



# Plasmon Archive Appliance Express

## User Manual

P/N 800-102913-00 B



# PREFACE

## Copyright

Copyright 2007 by Plasmon®. All rights reserved. This item and the information contained herein are the property of Plasmon. No part of this document may be reproduced, transmitted, transcribed, stored in a retrieval system, or translated into any language or computer language in any form or by any means, electronic, mechanical, magnetic, optical, chemical, manual, or otherwise, without the express written permission of Plasmon.

### United States Office

Plasmon  
4425 ArrowsWest Drive  
Colorado Springs, CO 80907-3489

### European Headquarters, UK

Plasmon Data Limited  
Whiting Way  
Melbourn, Herts. SG8 6EN

## Disclaimer

Plasmon makes no representation or warranties with respect to the contents of this document and specifically disclaims any implied warranties of merchantability or fitness for any particular purpose. Further, Plasmon reserves the right to revise this publication without obligation of Plasmon to notify any person or organization of such revision or changes.

## Trademark Notices

Plasmon is a U.S. registered trademark of Plasmon. All other product names are trademarks or registered trademarks of their respective owners.

## Revision History

Revision	Date	Description
A	4/07	Initial release.
B		Updated Safety Agency,

### NOTE

The most current information about this product is available on the Plasmon web site ([www.Plasmon.com](http://www.Plasmon.com)).

## Conventions Used

### WARNING



A **WARNING** is used to alert the reader to situations or conditions that could potentially result in personal injury, fire hazard, or equipment damage.

### CAUTION



A **CAUTION** is used to warn of undesirable procedures, or of situations in which equipment damage, or data loss could result.

### NOTE

A **NOTE** is used to emphasize an area of text or to provide additional information.

## WEEE Compliance

Plasmon products with the Waste Electrical and Electronic Equipment Directive (WEEE) label, shown below, can be shipped back to Plasmon for proper disposal of hazardous components. Please contact Plasmon Technical Support at the locations listed inside the back cover of this manual for the proper procedure.

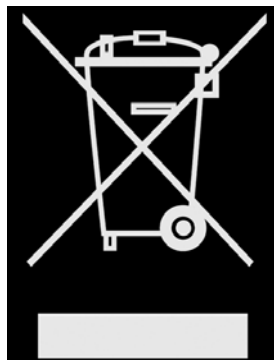

# Product Warranty

This Plasmon® product is warranted free from defects in materials, parts, and workmanship and to conform to the current product specification upon delivery. For the specific details of your warranty, refer to your sales contract or contact the company from which the product was purchased.

The Plasmon quality system is in compliance with and registered to ISO9001:2000. All products are assembled from new or remanufactured parts.

The warranty for the product shall not apply to failures of any unit when:

- The product is repaired by anyone other than Plasmon personnel or approved agent.
- The product is physically abused or is used in a manner that is inconsistent with the operating instructions or product specification defined by Plasmon.
- The product fails because of accident, misuse, abuse, neglect, mishandling, misapplication, alteration, faulty installation, modification, or service by anyone other than the factory service center or its approved agent.
- The product is repaired by anyone, including an approved agent, in a manner that is contrary to the maintenance or installation instructions supplied by Plasmon.
- The Plasmon serial number tag is removed.
- The product is damaged because of improper packaging on return.

## WARNING



Untrained personnel operating the product may create dangerous situations. This could lead to physical harm to the operator, data loss, and/or disabling of the system.

Please review and observe all safety statements concerning the operation of the product.

## CAUTION



Returning the product in unauthorized packaging may damage the unit and void the warranty.

If problems with the product occur, contact your maintenance organization; do not void the product warranty by allowing untrained or unauthorized personnel to attempt repairs.



# TABLE OF CONTENTS

<b>PREFACE</b> .....	<b>1</b>
Copyright .....	1
Disclaimer .....	1
Trademark Notices .....	1
Revision History .....	1
Conventions Used .....	2
WEEE Compliance .....	2
Product Warranty .....	3
<b>LIST OF FIGURES</b> .....	<b>7</b>
<b>CHAPTER 1</b>	
<b>PRODUCT OVERVIEW</b> .....	<b>9</b>
General Information .....	9
UDO Drive Type .....	10
UDO Media .....	11
UDO Media Labeling .....	11
Inserting UDO Media .....	11
Ejecting UDO Media .....	11
Write Protecting UDO Media .....	11
Media Care and Handling .....	12
<b>CHAPTER 2</b>	
<b>HARDWARE INSTALLATION</b> .....	<b>13</b>
Getting Started .....	13
Unpacking .....	13
Position .....	13
Environment .....	13
External Power Requirements .....	13
Rack Mounting .....	14
Rack Mount Guidelines .....	14
Rack Mount Installation .....	15
Installing the SATA Drives .....	17
Cable Connections .....	18
Power Connection .....	18
Network Connection .....	18
LED Indicators .....	19
Packing Instructions .....	20
<b>APPENDIX A</b>	
<b>SPECIFICATIONS</b> .....	<b>25</b>
Overall Specifications .....	25

<b>APPENDIX B</b>	
<b>SAFETY AGENCY STANDARDS.....</b>	<b>27</b>
FCC Notice .....	27
Industry Canada Notice per ICES-003.....	27
European Notice .....	27
Australia/New Zealand.....	28
Japan .....	28
Product Safety Standards .....	28
Laser Safety Notice .....	29
CDRH Regulations.....	30
Power Cord Set Selection .....	30
For the U.S. and Canada .....	30
For Germany and continental Europe.....	30
Power Supply.....	30
<b>INDEX.....</b>	<b>31</b>
<b>CONTACTING PLASMON .....</b>	<b>33</b>



# ***LIST OF FIGURES***

The Plasmon Archive Appliance Express .....	9
UDO Drive Types .....	10
UDO Media .....	11
Write Protecting UDO Media .....	11
Rack Mounting Kit for AAE .....	15
SATA Drive Release Lever and Release Lever Lock .....	17
Cable Connections .....	18
Archive Controller LED Indicators .....	19



# CHAPTER 1

## PRODUCT OVERVIEW

### General Information

The RoHS compliant Plasmon Archive Appliance Express™ is a Network Attached Storage (NAS) device providing long term storage for archived and fixed content data. It combines the performance benefits of network attached RAID with the reliability and robustness of Plasmon UDO® (Ultra Density Optical) optical storage. The appliance includes a two drive SATA RAID cache, a UDO drive for archiving to media, and an embedded server running enterprise class storage management software.

The Plasmon Archive Appliance Express is a low cost alternative to the larger automated Plasmon Archive Appliance products. The Archive Appliance Express, like other members of the Plasmon Archive Appliance family, can handle 200 million files. This appliance uses the same UDO media as the larger systems, enabling a later upgrade if required. It is very compact, and can be rack mounted.

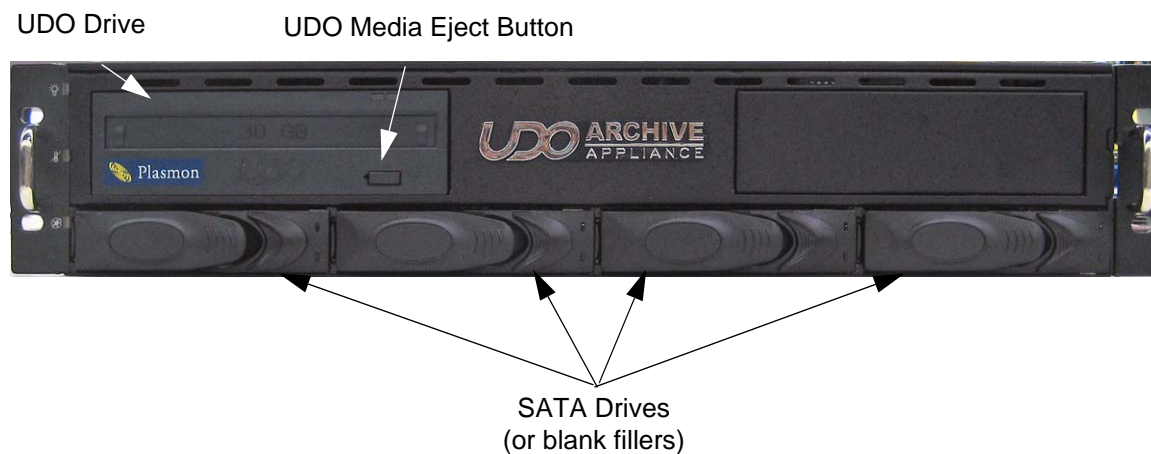

Figure 1. The Plasmon Archive Appliance Express

## UDO Drive Type

The Archive Appliance Express (AAE) can have either a UDO30 or a UDO60 drive installed. The drive type is indicated on the front of the drive as shown in the pictures below. UDO30 drives read and write only 30GB media. UDO60 drives read and write 60GB media, and can read 30GB media.



*Figure 2. UDO Drive Types*

The door on the UDO30 drive opens back into the drive case, while the door on the UDO60 drive opens out from the case. Media is inserted into the UDO30 by pushing it in against the door. Media is inserted into the UDO60 drive by pressing the eject button to first open the door.

Media is removed from both drive types by pressing the eject button. If the media cartridge is not removed within 30 seconds, the UDO60 drive retracts the media back into the drive without spinning up.

## UDO Media

The Plasmon AA Express uses UDO media with either 30GB or 60GB capacity, depending on the UDO drive type. These are available in both true Write Once and Rewritable media types.



Figure 3. UDO Media

### UDO Media Labeling

To identify each UDO media cartridge used in the AA Express a sequence number, and the start and stop dates for the cartridge must be entered on a label provided with the media. Plasmon UDO media for the AA Express also comes with barcode labels to facilitate a later upgrade to an automated appliance.

### Inserting UDO Media

To load media into the UDO drive, insert the cartridge fully into the slot on the front of the UDO drive. The media side facing up is the side the drive writes to.

### Ejecting UDO Media

When a side of the cartridge is full it automatically ejects. Pressing the eject button on the front of the UDO drive manually ejects the cartridge.

### Write Protecting UDO Media

To write protect one side of the media, slide the tab on that side in the direction of the protect arrow as shown in the figure below. There is a write protect tab on each side of the disk. When a side is protected, the Write Protect window is open.



Figure 4. Write Protecting UDO Media

## **Media Care and Handling**

To maintain maximum reliability, the operator should take the time to inspect each media cartridge before use, and whenever it is removed.

### **CAUTION**



Always condition the unopened media to the normal operating temperature of the room before using.

Improper handling or an inappropriate environment can damage the media. To ensure continued reliability:

- When media is loaded, or when handling media, ensure that the cartridge case is clean. Dirty media cartridges can cause failures in loading or loss of data. If a cartridge case is dirty, wipe with a lint free cloth.
- Do not carry media loosely (for example, in a box or basket). Media should be carefully and securely packed for transport.
- Do not load damaged media into a drive. Damaged media can interfere with read/write reliability.
- Never touch the disk. Opening the cartridge door and touching the disk may interfere with read/write reliability.
- Do not expose the media to moisture or direct sunlight.
- Do not expose the media to excessive heat (keep within 5 to 55 °C).

# CHAPTER 2

## HARDWARE INSTALLATION

### Getting Started

This chapter provides a guide to installing the Plasmon Archive Appliance Express (AAE) and the procedures necessary to get it on-line.

#### Unpacking

Save all packing material in case it is ever necessary to ship the appliance.

#### Position

Position the appliance to allow a minimum three inch clearance at the back for ventilation. Do not cover or block the air vents on the appliance.

To mount the appliance in a standard 19" rack, refer to the *Rack Mount Guidelines* section later in this chapter before proceeding.

#### Environment

To ensure long term reliability, operate the appliance only between 10° to 40°C (50° to 104°F) and 10% to 90% relative humidity. The media and drives require a clean environment. Excessive dust and dirt can lead to data loss, and increase service calls.

#### External Power Requirements

The appliance requires an external power source with 100 to 240 VAC (the power supply is auto-ranging) at 50 to 60 Hz. See Appendix A in this document for power figures.

# Rack Mounting

## Rack Mount Guidelines

This document provides information for mounting the Archive Appliance Express enclosure into an Electronics Industry Association (EIA 310-D) standard 19" (48.3 cm) rack. The standard 19" rack must have between 22" and 34" (56 to 142 cm) between front and back mounting columns to provide sufficient depth for the enclosure. The appliance takes up 2U of rack space. In this document, one rack unit (1U) equals 1.75" (4.445 cm).

If the unit is installed in a closed or multi-rack assembly, refer to the following guidelines:

- The operation temperature of the rack environment may be greater than the ambient temperature. Be sure to install the unit in an environment that is compatible with the maximum rated ambient temperature. See *Appendix A Specifications* in the User Manual.
- When mounting the equipment in the rack, make sure mechanical installation is level to avoid a hazardous condition. The rack must be specified to safely support the combined weight of all equipment.
- When connecting the equipment to the supply circuit, check equipment nameplate ratings to avoid overloading circuits that may cause damage to over-current protection devices and supply wiring.
- Maintain reliable grounding for rack-mounting equipment. Pay particular attention to supply connections.
- Allow sufficient air circulation or space between units when installed in a closed or multi-unit rack assembly to ensure the operating ambient temperature of the rack environment is not greater than that specified for the library in *Appendix A* in the User Manual.
- The unit is designed to use a three pronged grounding type plug. Equipment grounding ensures safe operation. Do not interfere with or remove the grounding means, and verify equipment is reliably grounded when mounted within a rack.

### WARNING



Use safe lifting procedures when installing the appliance in the rack. The appliance weighs about 33 lbs (15 kg).



## Rack Mount Installation

The Archive Appliance Express can be rack mounted using a sliding rail kit available from Plasmon. The rack mount kit works in racks with a depth of 22" to 34" (56 to 142 cm) from front to back rails.

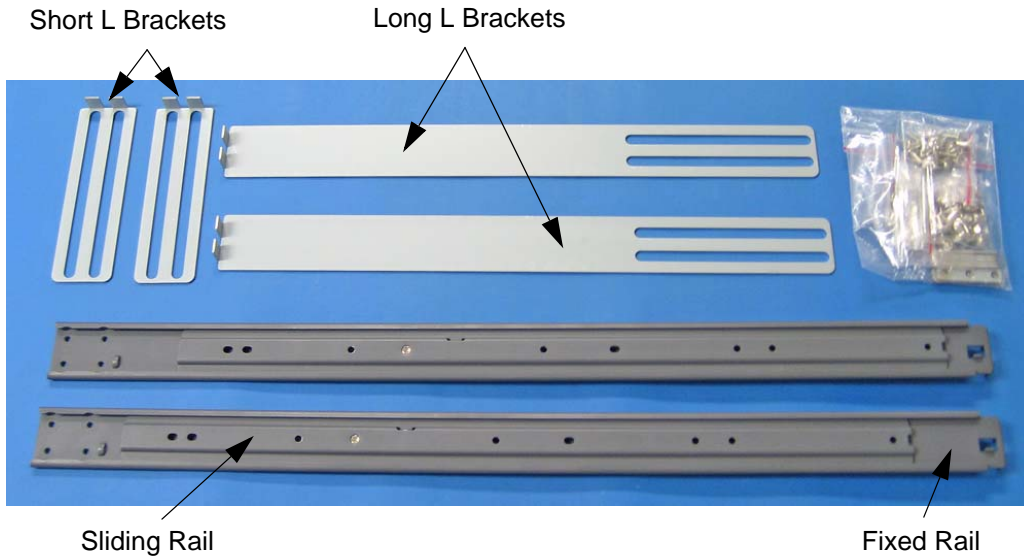
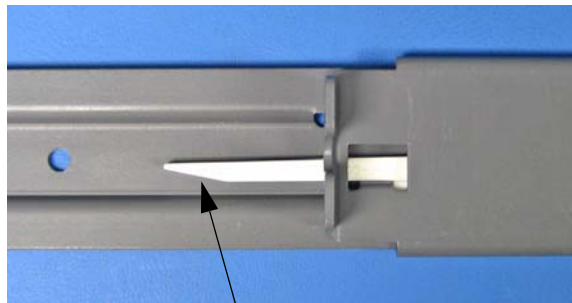

Figure 5. Rack Mounting Kit for AAE

To install the rack mounting rails, perform the following steps:

1. Separate the sliding rail from the fixed rail by fully extending the sliding rail and releasing the stop latch shown below. Repeat for the other rail.



Push up to release sliding rail.

2. Attach the sliding rails to the sides of the AAE by inserting the notched ends of the sliding rails into the raised tabs toward the front on each side of the AAE, and attaching the rails with two M4, 12mm x 20 screws on each as shown below.

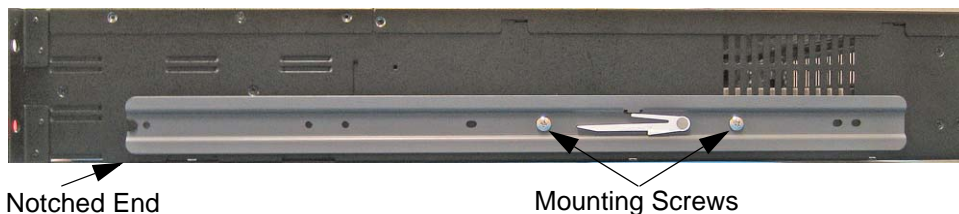

3. Attach two of the L brackets to the ends of the fixed rails that have four mounting holes using four of the short M4, 6mm x 16 screws, as shown below. Repeat for the other rail.

Choose either the long L brackets, or the short L brackets, depending on the depth of the rack. These brackets can be mounted with the L end facing either forward or to the back to provide maximum adaptability. Try different combinations to fit the rack.

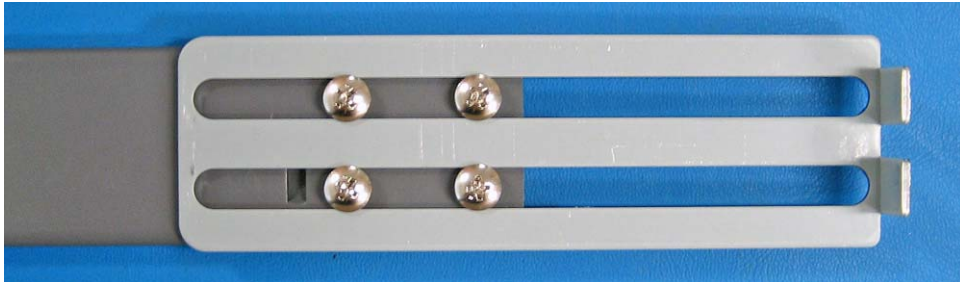

4. Attach the assembled fixed rails to the mounting rails in the rack using the threaded backing plates. Place a plate with the smaller holes on the inside of the mounting rail, and a plate with the larger holes on the outside of the mounting rail at the appropriate height using three M4, 12mm x 20 screws for each pair of brackets as shown below.

Threaded Backing Plate  
(with small holes)

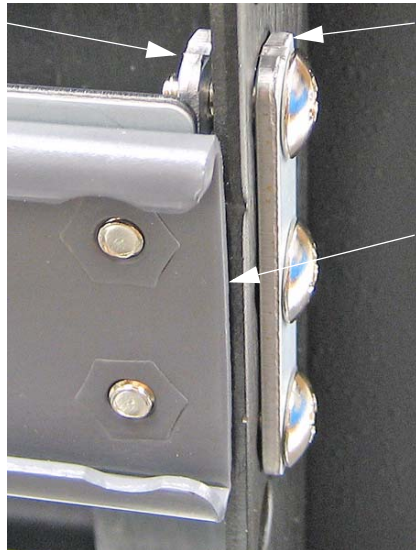

Threaded Backing Plate  
(with large holes)

L Bracket fits between rear  
backing plate and rack rail,  
straddling center screw

5. Slide the AAE enclosure fully into the rack by fitting the sliding rail into the fixed rail on each side. The stop latch on each side engages to prevent unintentional removal.

## Installing the SATA Drives

The appliance is shipped without the SATA drives installed. The SATA drives, in their own shuttles, are packaged separately, along with blank shuttles to fill any empty drive slots.

To mount the drives into the unpopulated slots of the appliance, prepare each SATA drive shuttle by pushing the release lever lock to the right to pop out the release lever. Then fully insert each SATA drive shuttle into the appliance and push the release lever all the way in to lock the drive shuttle in place.

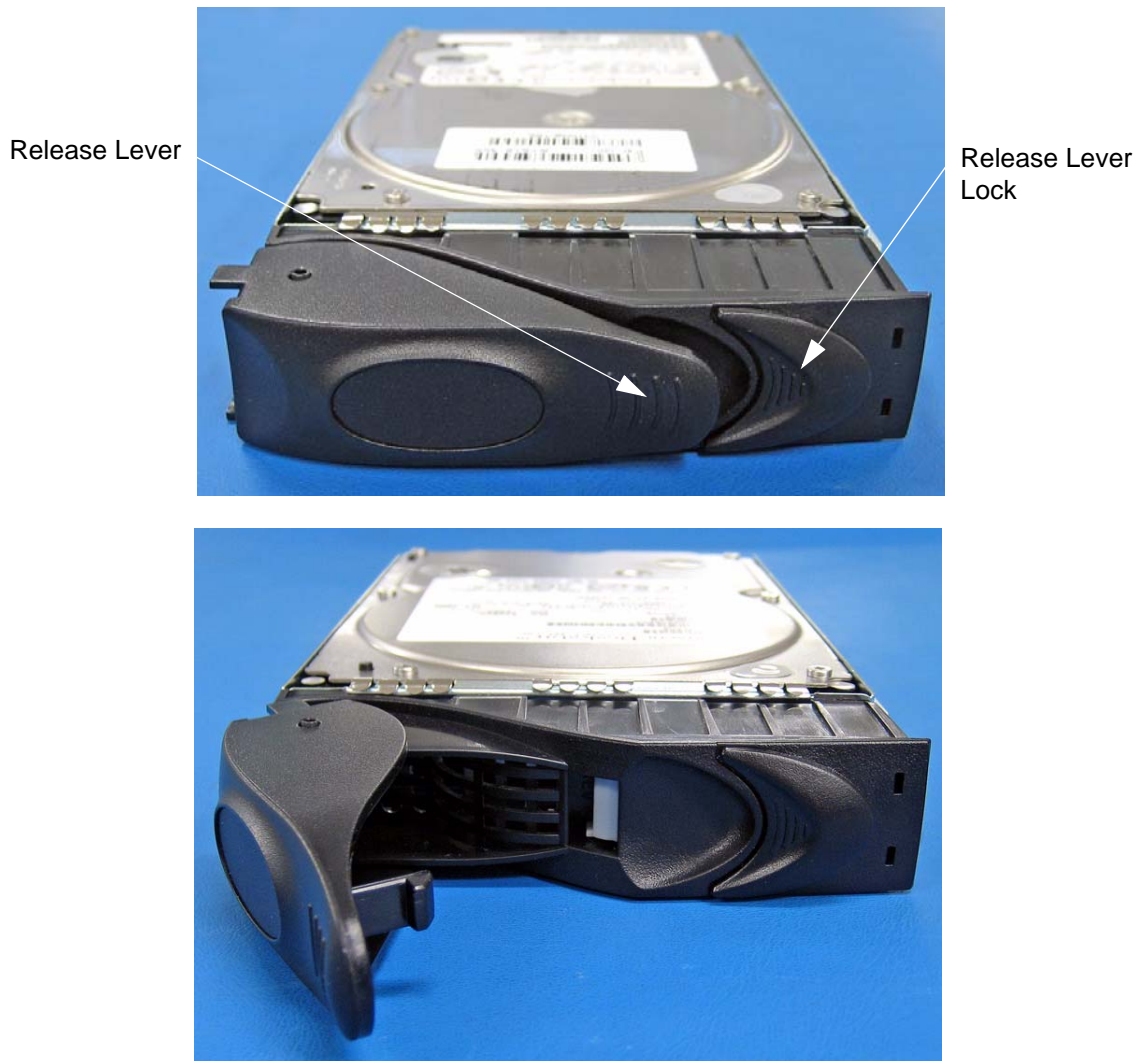

*Figure 6. SATA Drive Release Lever and Release Lever Lock*

Plasmon recommends mounting the SATA drives in the two right most positions in the bottom front of the appliance. Mount the blank shuttles in the two slots to the left.

## Cable Connections

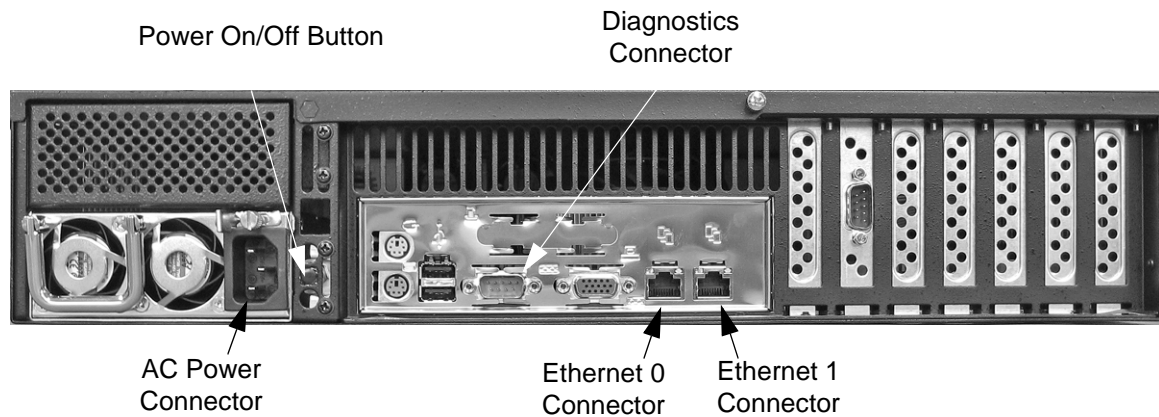

Figure 7. Cable Connections

### Power Connection

Route the power cable to the power connector located at the back of the appliance.

The power cable can be plugged into a standard 120 volt to 240 volt wall outlet. The appliance uses an auto-ranging power supply.

Do not use an extension cord. The unit must be located next to the AC outlet, and the outlet must be easily accessible. In the event an emergency power cutoff is required, pull the plug from the AC socket.

### Network Connection

Connect an ethernet network cable to the Ethernet 0 connector. The second Ethernet 1 connector can be used for load balancing or fail over protection. By default, Ethernet 1 is disabled.

## LED Indicators

There are three LED indicators on the left front of the appliance. Labels on the unit identify these indicators as shown below. A blue light indicates proper conditions, red indicates a fault.



Figure 8. Archive Controller LED Indicators

There are two LED indicators at the right front corner of each SATA drive shuttle. The top LED lights blue to indicate a drive is powered on. The bottom LED lights blue to indicate drive activity, or red to indicate a drive fault.



## Packing Instructions

This section is provided in case it is necessary to ship the appliance. These procedures must be followed.

### CAUTION



Plasmon products must be shipped in the original packaging. Shipping a unit in anything other than the manufacturers packaging voids the warranty.

Remove all media before shipping the appliance.

1. Lay the appliance double box out with the foam insert in place as shown below. Line up the slots in the foam blocks front to back.



2. Remove all SATA drives and blank shuttles from the appliance, and place it into the double box so the front tabs fit into the foam as shown below.



3. Place the covering foam piece, with the rack rail kit in the provided slot, on top of the appliance as shown below, and close the inner box.



4. In many cases the SATA drives do not leave the customer site. In this case pack the drive boxes empty (or provide other packing material) to fill the space. If the drives are being packed for moving or return, pack the SATA drives with shuttles, and the blank shuttles, into the drive boxes as shown below. Each drive and shuttle should be in an anti-static bag.



5. Place the top foam piece in place over the drives as shown below and close the drive box.





6. Place the two SATA drive boxes on top of the appliance box.

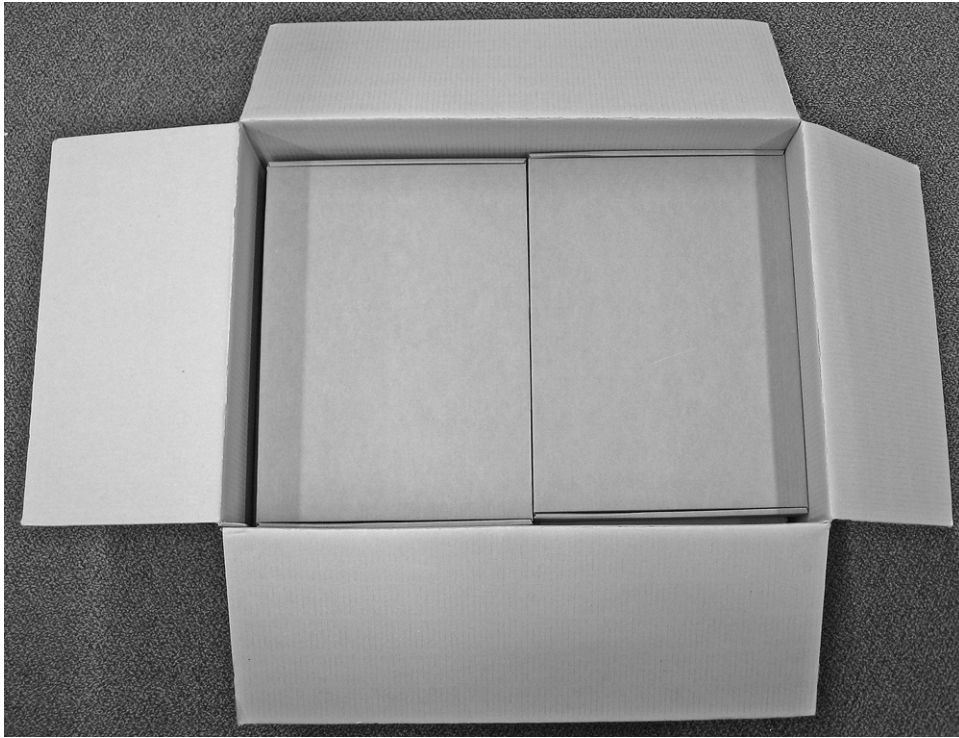

7. Two more boxes hold the blank shuttles and accessories. Place these on top of the drive boxes as shown below, and seal the double box for shipping.





# APPENDIX A

## SPECIFICATIONS

### Overall Specifications

The following table provides information about the Plasmon Archive Appliance Express. These specifications are subject to change without notice.

*Table 1. Archive Appliance Express Specifications*

Specification	Archive Appliance Express
Online RAID Capacity	170 GBytes, usable mirrored RAID cache
Online Optical Capacity	UDO30 15 GBytes, single UDO media side UDO60 30 GBytes, single UDO media side
Number of UDO Drives	One
Network	Gigabit Ethernet autosensing 10/100/1000 Base T, RJ45
Network File Protocols	Heterogeneous Microsoft and Unix networks using CIFS/NFS (v2 & v3) / FTP
IP Discovery	DHCP support and dynamically allocated IP address discovery utility (Find AA)
Security	Microsoft Active Directory Service (ADS) member server Kerberos authentication v5
Max Power Consumption Max Power Dissipation	207 Watts 590 BTU/hr
Power Requirements	Voltage 100 to 240 VAC (auto-ranging power supply) Frequency 50/60 Hz
Environmental	Operating Temperature +10 to +40°C (+50 to +104°F) Operating Humidity 10 to 90% RH non-condensing Non-Operating Temperature -30 to +60°C (-22 to +140°F)
Dimensions-Stand Alone	Width (in/cm) 17.3/44 Height (in/cm) 3.5/8.8 Depth (in/cm) 22/55.1 Weight (lbs/kg) 33/15 - including disk drives

Specification	Archive Appliance Express
Dimensions-Rack Mount	With Plasmon 20" Rack Mounting Rails, fits in racks with a depth of 22 to 34 inches (56- to 142cm). Uses 2U rack space.
Dimensions-Shipping Width (in/cm) Height (in/cm) Depth (in/cm) Weight (lbs/kg)	22.5/57 15/38 31/79 59/27 - including disk drives

# APPENDIX B

## SAFETY AGENCY STANDARDS

### FCC Notice

The equipment to which this manual pertains has been tested and found to comply with the limits for a Class A digital device, pursuant to part 15 of the FCC Rules. These limits are designed to provide reasonable protection against harmful interference when the equipment is operated in a commercial environment. This equipment generates, uses, and can radiate radio frequency energy and, if not installed and used in accordance with this manual, may cause harmful interference to radio communications. Operation of this equipment in a residential area is likely to cause harmful interference in which case the user is required to correct the interference at his own expense:

### Industry Canada Notice per ICES-003

**English:** This digital apparatus does not exceed the Class A limits for radio noise emissions from digital apparatus set out in the interference-causing equipment standard entitled "Digital Apparatus," ICES-003 of the Industry Canada.

**French:** Cet appareil numérique respecte les limites de bruits radioélectriques applicables aux appareils numériques de Classe A prescrites dans la norme sur le matériel brouilleur: "Appareils Numériques", NMB-003 édictée par l'Industrie Canada.

### European Notice

**CE** This product is in conformity with the following directive.

- EN 55022/CISPR 22, Class A
- EN 55024
- EN 61000-3-2
- EN 61000-3-3

This library system is in conformity with the EMC directive and low-voltage directive.

## Australia/New Zealand

This equipment has been tested and complies with AS/NZS 3548.

## Japan

この装置は、情報処理装置等電波障害自主規制協議会（VCCI）の基準に基づくクラスA情報技術装置です。この装置を家庭環境で使用すると電波妨害を引き起こすことがあります。この場合には使用者が適切な対策を講ずるよう要求されることがあります。

This is a Class A product based on the standard of the Voluntary Control for Interference by Information Technology Equipment (VCCI). If this equipment is used in a domestic environment, radio disturbance may occur, in which case, the user may be required to take corrective actions.

## Product Safety Standards

This product complies with the following domestic and international product safety standards:

- UL Standard 60950-1, 1st Edition: 2003 Safety of Information Technology Equipment
- CSA Standard C22.2 No. 60950-1-03, Safety of Information Technology Equipment
- IEC 60950-1, 1st Edition: 2001

## Laser Safety Notice

This is a Class 1 Laser Product. It complies with 21 CFR 1010.10, 1040.11, and IEC 60825-1:1993+A1:1997+A2:2001 as a Class 1 Laser product.

The maximum output power and wavelength of the laser in the Plasmon UDO30 and UDO60 drive is 65mW (403-413nm).

### WARNING



Use of controls or adjustments, or performance of procedures other than those specified herein, may result in hazardous radiation exposure.

## CDRH Regulations

The Center for Devices and Radiological Health (CDRH) of the U.S. Food and Drug Administration implemented regulations for laser products on August 2, 1976. These regulations apply to laser products manufactured from August 1, 1976. Compliance is mandatory for products marketed in the United States.

## Power Cord Set Selection

The voltage rating and the current rating of the power cord set shall be higher than the rated voltage and current of this unit. The voltage of the power cord set shall be higher than the power source.

### *For the U.S. and Canada*

Power cord must be UL listed and CSA labeled. Type SJT, SVT, ST, SJO or SO, 3-conductors, No. 18 AWG, rated 125v, 10A.

In the US the 120 VAC power cord shipped with Plasmon libraries meets these criteria:

- The power cord must have a molded NEMA 5-15P male attachment plug on one end.
- The power cord must have a molded IEC type CEE-22 female connector on the other end.
- The power cord must be UL Listed and CSA Certified.

Outside the US contact Plasmon for country specific requirements.

### *For Germany and continental Europe*

STROMANFNAHME: 100-240 VAC, 50/60 Hz, 10A.

Für eine 230V-Anwendung, ist eine harmonisierte <HAR> konfektionierte Leitungsschnur, Typ H05vvf3G1.00, die für 250V/10A oder die Gleichwertigkeit geeignet ist, zu benutzen.

## Power Supply

The AAE power supply is certified for China Compulsory Product Certification (CCC).



## C

cable	
network.....	18
power .....	18, 30
connection	
network.....	18
power .....	18
customer support.....	33

## D

drive	
LEDs .....	19
type .....	10

## H

hardware installation .....	13
-----------------------------	----

## L

LEDs	
controller.....	19
LEDs drive .....	19

## M

media	
care and handling .....	12
write protecting .....	11

## N

network connection.....	18
-------------------------	----

## P

packing instructions .....	20
power	
connection .....	18
cord.....	18, 30
requirements.....	13
product overview .....	9

## R

rack mounting .....	14
---------------------	----

## S

safety agency standards .....	27
specifications .....	25
support, technical .....	33

## T

technical support .....	33
-------------------------	----

## U

UDO	
drive type.....	10
media .....	11

## W

warranty .....	3
----------------	---



# CONTACTING PLASMON

Technical Support in the United States	
Plasmon Technical Support	1-877-585-6793
	1-719-593-4192 (fax)
e-mail	tech.support@plasmon.com
Internet	www.plasmon.com
Technical Support in Europe, Middle East, and Africa	
Plasmon Technical Support	+44 (0) 1763 262 963
	+44 (0) 1763 264 407 (fax)
e-mail	support@plasmon.co.uk
Internet	www.plasmon.com
Technical Support in Asia/Pacific, South America, and Canada	
International Calls	1-719-593-4437
	1-719-593-4192 (fax)

## Firmware Updates

Contact Plasmon or your reseller for the latest firmware updates.

## Before Placing a Service Call to Plasmon

Register your site on-line at <http://www.plasmontech.com/warranty/index.html>.

## Placing a Service Call

Contact your service provider directly. If Plasmon is your service provider, please have the following information available when calling:

- Serial number
- Description of failure
- System information
  - Software and version number



## Free Manuals Download Website

<http://myh66.com>

<http://usermanuals.us>

<http://www.somanuals.com>

<http://www.4manuals.cc>

<http://www.manual-lib.com>

<http://www.404manual.com>

<http://www.luxmanual.com>

<http://aubethermostatmanual.com>

Golf course search by state

<http://golfingnear.com>

Email search by domain

<http://emailbydomain.com>

Auto manuals search

<http://auto.somanuals.com>

TV manuals search

<http://tv.somanuals.com>