

XL340



[www.philips.com/support](http://www.philips.com/support)

---

EN Telephone

---



**Warning**

Use only rechargeable batteries.  
Charge each handset for 24 hours before use.

**PHILIPS**

---

## Welcome mode

### **Note**

Welcome mode is not available for some countries.

Before using your XL340, you need to configure it according to the country of use. When you switch on the phone for the first time, your phone displays a welcome message in different languages.

After a few seconds, your phone displays the countries available for selection. You can configure the country now.

- 1** View the countries available for selection.
- 2** Press the country number on the keypad to make a selection. For example, UK, PRESS 1.
  - *After making a selection, your phone's power turns off for a few seconds to update the settings.*

### **Warning**

If the handset is currently lost link, your phone will show a failed message. It will only update the display language. Your phone will display the welcome message again when you replace the handset's batteries.

When your phone finishes updating the settings, it will turn back on automatically.

Your phone is now ready to be used.

# Table of contents

<b>1</b>	<b>Important information</b>	<b>3</b>	3.5	Using GAP standard compliance	9
1.1	For your safety	3	3.6	Standby mode	9
1.2	Power requirements	3	3.7	Verify the signal	9
1.3	Telephone connection	3	<b>4</b>	<b>Using your phone</b>	<b>10</b>
1.4	Need help?	3	4.1	Call	10
1.5	Safety information	3	4.2	Answer a call	10
1.6	Conformity	3	4.3	Loudspeaker phone	10
1.7	Safety precautions	3	4.4	Adjust the audio volume	10
1.8	Environmental care	3	4.5	End a call	10
1.9	Recycling & disposal	3	4.6	Make a second call	11
<b>2</b>	<b>Your phone</b>	<b>5</b>	4.7	Answer a second call	11
2.1	What's in the box	5	4.8	Conference call	11
2.2	Overview of the phone	6	4.9	Use intercom	11
2.3	Overview of the base	7	4.10	Text or number entry	11
2.4	Display icons	7	<b>5</b>	<b>Use more of your phone</b>	<b>13</b>
<b>3</b>	<b>Getting started</b>	<b>8</b>	5.1	Phonebook memory	13
3.1	Connect the base	8	5.2	Personalizing your phone	13
3.2	Connect the charger	8	5.3	Advanced features	14
3.3	Insert the batteries in the handset	8	<b>6</b>	<b>Default settings</b>	<b>18</b>
3.4	Charge batteries	8			

## Table of contents

**7 Quick reference table for menus 19**

---

**8 Technical data 20**

---

**9 Frequently asked questions 21**

---

**10 Index 22**

---

---

# 1 Important information

---

## 1.1 For your safety

Before installing your XL340, carefully read the following information.

---

## 1.2 Power requirements

- The product requires an electrical supply of 220-240 volts, alternating monophased power, excluding IT installations defined in standards EN 60950. In case of power failure, the communication can be lost.

### Warning

The electrical network is classified as dangerous according to criteria in the standard EN 60950. The only way to power down this product is by unplugging the power supply from the electrical outlet. Ensure the electrical outlet is located close to the apparatus and is always easily accessible.

---

## 1.3 Telephone connection

- Always use the line cable provided with the product otherwise you may not have a dialing tone.
- If you have a broadband DSL Internet connection, make sure you have one DSL filter plugged directly on each line socket used in the house and check the modem and the phone are plugged in the correct filter slot (one specific for each).

---

## 1.4 Need help?

For more information on Troubleshooting and FAQ's:

- Online help: [www.philips.com/support](http://www.philips.com/support)
- Troubleshooting: see page 21

---

## 1.5 Safety information

### Warning

This equipment is not designed to make emergency calls when the power fails. An alternative has to be made available to allow emergency calls.

---

## 1.6 Conformity

Hereby, Philips declares that the XL340 is in compliance with the essential requirements and other relevant provisions of Directive 1999/5/EC. This product can only be connected to the analogue telephone networks of the countries mentioned on the packaging. The Declaration of conformity is available on [www.philips.com/support](http://www.philips.com/support)

---

## 1.7 Safety precautions

- Do not allow the handset to come into contact with water.
- Do not open the handset or the base station. You could be exposed to high voltages.
- Do not allow the charging contacts or the batteries to come into contact with conductive materials.
- Never use any battery type other than the one supplied : risk of explosion.

### Warning

Metallic objects may be retained if placed near or on the handset receiver.

---

## 1.8 Environmental care

Please remember to observe the local regulations regarding the disposal of your packaging materials, exhausted batteries and old phone and, where possible, promote their recycling.

---

## 1.9 Recycling & disposal

Disposal instructions for old products :

The purpose of the WEEE directive (Waste Electrical and Electronic Equipment; 2002/96/EC) is to ensure that products are recycled using best

available treatment, recovery and recycling techniques to ensure human health and high environmental protection.

Your product is designed and manufactured with high quality materials and components, which can be recycled and reused.

Do not dispose of your old product in your general household waste bin. Inform yourself about the local separate collection system for electrical and electronic products marked by this symbol.



Use one of the following disposal options:

- Dispose of the complete product (including its cables, plugs and accessories) in the designated WEEE collection facilities.
- If you purchase a replacement product, hand your complete old product back to the retailer. The shop should accept it as required by the WEEE directive.

#### **Disposal instructions for batteries:**

Batteries should not be disposed of with general household waste.



#### **Packaging information:**

Philips has marked the packaging with standard symbols designed to promote the recycling and appropriate disposal of your eventual waste.

A financial contribution has been paid to the associated national recovery & recycling system.



The labeled packaging material is recyclable.



## 2 Your phone

### 2.1 What's in the box

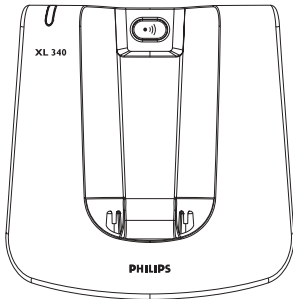

**Base unit**

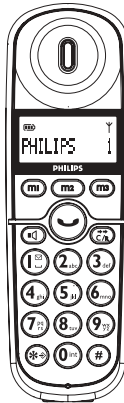

**Handset**

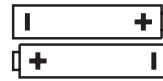

**2 rechargeable batteries**

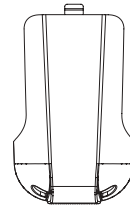

**Battery door**

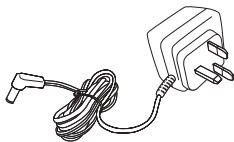

**Power adaptor for base**

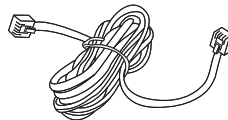

**Line cord\***



**User manual**



**Quick start guide**



**Guarantee**

Make sure you have all these items in the box. For missing item(s), contact your dealer. In multi-handset packs, you will find additional handsets, chargers, power supplies, and batteries.

**Note**

\*You may find in the box the line adaptor delivered separately from the line cord. In this case, please plug first this line adaptor onto the line cord before connecting it to the line socket.

**Note**

This telephone system meets FCC standards for Hearing Aid Compatibility.

## 2.2 Overview of the phone

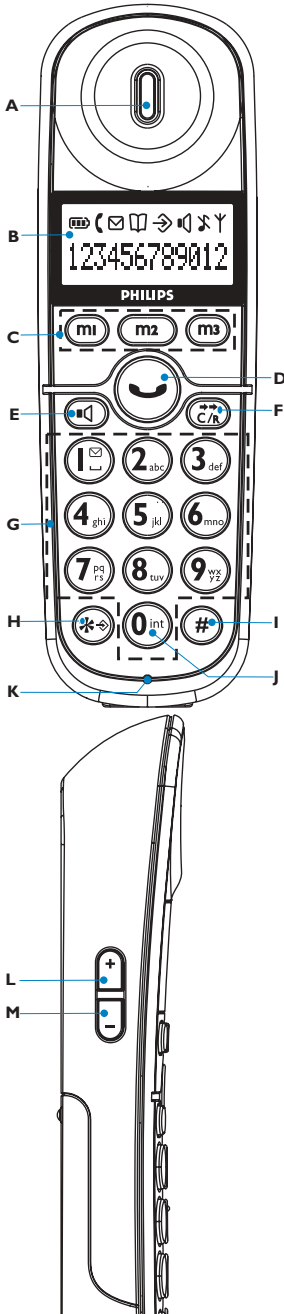

### **A Earpiece**

### **B Display**

### **C Direct memory keys**

Use to access direct memories.

### **D Talk key**

Use to take the line and answer a call.

In viewing memory, use to dial out the number.

Use to end a call.

### **E Speaker key**

Use to turn on or off the speaker.

Use to change the ringing melody.

### **F Redial, Cancel & Recall key**

Use to cancel an operation.

Use to redial the last dialed number.

Use to send out a flash.

### **G Digit keys**

Use to dial digits and enter characters.

Use to access extra memories.

### **H Insert star & Program key**

Use to insert \* (star).

Use to enter program mode.

### **I Insert # & Pause key**

Use to insert #.

Use to insert pause (P) when dialing.

### **J Intercom Key**

Use to make intercom call.

### **K Microphone**

### **L Volume up Key**

Use to increase ringer and audio volume.

### **M Volume down Key**

Use to decrease ringer and audio volume.

### **⚠ Warning**

Handsfree activation could suddenly increase the volume in the loudspeaker to a very high level.

Make sure the handset is not too close to your ear.



## 2.3 Overview of the base

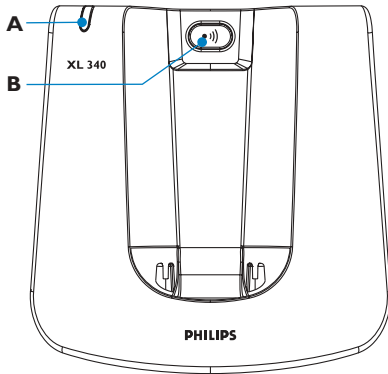

### A LED

Steadily on when line is in use.  
Blinking when receiving incoming call.  
Blinking when having new message in mailbox.









### B Page key

Use to locate handset(s).  
Use to register handset(s).

## 2.4 Display icons

When being used for the first time, it is sometimes necessary to wait until the batteries are sufficiently charged before the icons appear on the display.

The display gives information about the operation of your telephone. The following icons can be shown in the headline of the display.

-  Displays the current battery level. It scrolls during charging.
-  The phone is in use. It blinks during ringing.
-  There is a new voice mail in your network mailbox (subscription needed).
-  Phonebook memory is being reviewed or edited.
-  The phone is in program mode.
-  Loudspeaker is turned on.
-  The ringer is turned off.
-  The handset is linked to the base.

---

## 3 Getting started

---

### 3.1 Connect the base

Place the base station close enough to the telephone and the mains power sockets so that the cables will reach.

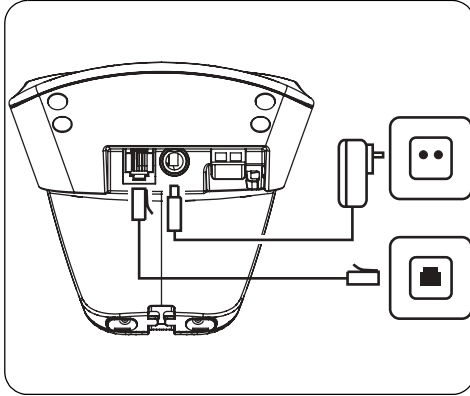

- 1 Connect the telephone line cord to the phone socket on the bottom of base unit and the wall phone sockets.
- 2 Connect output plug of power adaptor to the power socket on the bottom of base unit. Connect the power adapter to the wall mains supply.

#### **Warning**

The electrical network is classified as dangerous according to criteria in the standard EN 60950. The only way to power down this product is by unplugging the power supply from the electrical outlet. Ensure the electrical outlet is located close to the apparatus and is always easily accessible.

---

### 3.2 Connect the charger

If you have bought a multi-pack product, each extra handset comes with a charger and a charger adaptor.

- 1 Connect the output plug of the charger adaptor to the bottom of the charger.

- 2 Connect the charger adaptor to the wall mains supply.

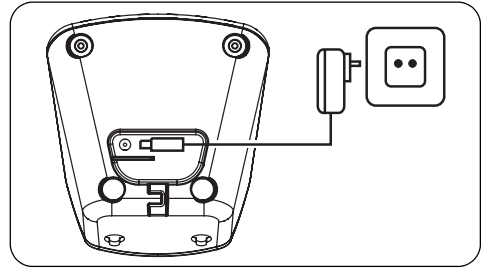

---

### 3.3 Insert the batteries in the handset

- 1 Place the two rechargeable batteries (included) into the battery compartment.

#### **Warning**

Verify the batteries polarity when inserting the batteries. Incorrect polarity may damage the product.

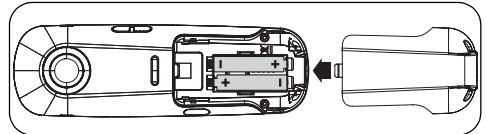

- 2 Slide the battery door firmly into place.

#### **Warning**

**RISK OF EXPLOSION IF BATTERY IS REPLACED BY AN INCORRECT TYPE. USE RECOMMENDED TYPE SUPPLIED WITH THIS PRODUCT. NEVER USE NON-RECHARGEABLE BATTERIES.**

---

### 3.4 Charge batteries

#### **Warning**

The base station must always be plugged into the mains when charging or when in use.

#### **Note**

If the batteries are completely exhausted, the product will not be able to power-on immediately. Handset may get warm during initial charge. This is normal.

Place handset on the base unit or the charger and let the batteries continuously charge for 24 hours before using.

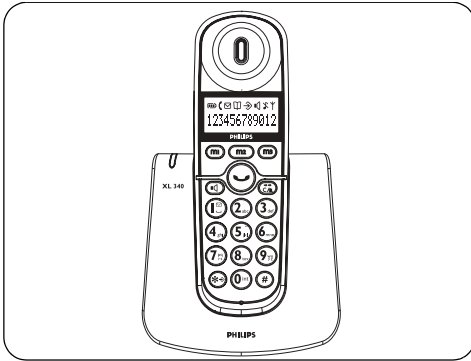

- The battery icon  appears on the screen when charging has started.

### Note

The warranty does not apply to the batteries and any other components which have a limited lifetime or are exposed to wear.

#### 3.4.1 Low battery warning

An empty battery icon  indicates the batteries need recharging.

Place the handset on the base unit or the charger to recharge the batteries.

### Note

Handset will go into sleep mode after reaching a very low battery voltage level.

### Note

A low battery alert (during off hook) will also inform you that the handset has to be recharged. If it happens during a call, the call may end shortly after the alert.

#### 3.4.2 Battery life and range

Optimal battery life is reached after 3 cycles of complete charging and discharging. Optimal range is reached when there is no other electrical appliances working within the range area.

Battery life in talking mode:	Up to 12 hours
Battery life in standby mode:	Up to 150 hours
Indoor range:	Up to 50 meters
Outdoor range:	Up to 300 meters

### 3.5 Using GAP standard compliance

The GAP standard guarantees that all DECT™ GAP handsets and base stations comply with a minimum operating standard irrespective of their makes. XL340 handset and base station are GAP compliant, which means they guarantee the minimum functions: register a handset, take the line, make a call and receive a call. The advanced features may not be available if you use them with other makes.

To register and use XL340 handset with a GAP compliant base station from different make, first follow the procedure described in the manufacturer's instructions, then follow the procedure described in this manual for subscribing a handset.

To register a handset from different make to XL340 base station, place the base station into registration mode, then follow the procedure described in the handset's manufacturer's instructions.

### 3.6 Standby mode

Your phone is in standby mode when it is idle. The standby screen displays the handset name, handset number, battery icon, and the signal icon.

### 3.7 Verify the signal

The signal icon  displays the link status between your handset and the base unit.

 is steadily on: Your handset and base unit are linked.

 is flashing: Your handset and base unit have lost link.

---

## 4 Using your phone

---

### 4.1 Call

#### Warning

This telephone is not designed for making emergency telephone calls when the power fails. Alternative arrangements should be made for access to emergency services.

---

#### 4.1.1 Make a call

- 1 Press  and wait for the dial tone.
  - 2 Dial the number you want to call.
    - *The number appears on display and is dialed.*
- 

#### 4.1.2 Call timer

The call timer shows the duration of your current call on display. It is shown in minutes and seconds (MM:SS) in the first hour. After that, it will be shown in hours and minutes (HH:MM).

---

#### 4.1.3 Preparatory dialing (Pre-Dial)

With pre-dial, you can see and edit the number you are calling before dialing it.

- 1 Enter the number you want to call.
  - *The number appears on display.*

- 2 Press .



#### Note

You can enter up to 24 digits. Press  to delete an incorrect digit.

---

#### 4.1.4 Redial the last number

With redialing, you can redial the last number dialed.

- 1 Press .
- 2 Press .

- *The last dialed number appears on display and is dialed.*
- 

### 4.1.5 Call from phonebook memory

Press  while viewing a memory.

- *The phonebook memory appears on display and is dialed.*

#### Note

If the number is longer than 12 digits, only the last 12 digits are shown on display.

For more details on the phonebook memory function, see “Phonebook memory”, page 13.

---

### 4.2 Answer a call

When you receive a call, the phone will ring and  will flash on the display.

Press  to answer the call.

#### Note

If the ringer is turned off, the phone will not ring for the incoming call.

---

#### 4.2.1 Answer a call in handsfree mode

The handsfree feature enables you to talk to the caller without holding onto the phone. It also allows others in the room to join in the conversation.

When you receive a call, the phone will ring and  will flash on the display.

Press  to answer the call.

---



### 4.3 Loudspeaker phone

During a call, press  to turn on and off the loudspeaker.

-  *appears on the handset display when loudspeaker is on.*
- 

### 4.4 Adjust the audio volume

During a call,

- 1 press  to increase the audio volume,
  - 2 press  to decrease the audio volume.
- 

### 4.5 End a call

Press  during a call to end it.

---

---

## 4.6 Make a second call

- 1 Press **☎** during a call.
    - **R** appears and you will hear a dial tone.
  - 2 Enter the number you want to call.
  - 3 After the second call is answered, you can press **☎** to toggle between these 2 calls.
- 

## 4.7 Answer a second call

During a call, if another call comes in, the handset will sound a short beep periodically to notify you. You can answer it without ending the current call.

- 1 Press **☎** when the second call comes in.
    - **R** appears on display, the current call will be put on hold, and you are talking with the second caller.
  - 2 Press **☎** subsequently to toggle between these 2 calls.
- 

## 4.8 Conference call

### 4.8.1 Join a conversation

During a call, another handset can join the conversation by pressing **☎**.

- A short beep (alert tone) will apply to the original handset to notify the conference call is initiated.
- 

### 4.8.2 Exit from Conference call

During a conference call, press **☎** to exit from the conference call.

- The other handset is still connected to the external caller.
- 

## 4.9 Use intercom

You can call someone in the house by using the intercom function.

- 1 Press and hold **☎**.
- 2 If there are only 2 handsets registered to the base station, the intercom will be made automatically. Otherwise, enter the handset

number you want to make the intercom call to.

- 3 Press **☎** to answer the intercom when the phone is ringing.
- 

## 4.10 Text or number entry

You can enter texts and numbers for the phonebook memories and other features.

- 1 Press corresponding key as many times as necessary to reach the desired character.
- 2 Press **☎** to delete a character. Press and hold **☎** to delete all entered characters.
- 3 Press **#** to switch between uppercase and lowercase.
  - The characters entered thereafter will be in the alternate case.

### Example to write "Peter"

- 1 Press **7** once: **P**
- 2 Press **#** once: **P**
- 3 Press **3** twice: **Pe**
- 4 Press **8** once: **Pet**
- 5 Press **3** twice: **Pete**
- 6 Press **7** three times: **Peter**



Upper case input table	
Keys	Assigned characters
1	[space] 1 , . ! ? : ; ' "
2	A B C 2 Á Á Á Ä Å Æ Ç
3	D E F 3 É Ê Ë Ì
4	G H I 4 Í Î Ï
5	J K L 5 [ ]
6	M N O 6 Ñ Ò Ó Ô Õ Ø Ò
7	P Q R S 7 Δ ⊙ λ ε Σ
8	T U V 8 Ù Ú Û Ü
9	W X Y Z 9 Ý ÿ
0	0 \$ € @ _ ( ) < > ~
*	* # + - / = & %

Lower case input table	
Keys	Assigned characters
1	[space] 1 , . ! ? : ; ' "
2	a b c 2 Á Â Ã Ä Å Æ Ç
3	d e f 3 È É Ê Ë Ì
4	g h i 4 Í Î Ï
5	j k l 5 [ ]
6	m n o 6 Ñ Ò Ó Ô Õ Ö Ø Ù
7	p q r s 7 Δ ⊙ Λ Ξ Σ
8	t u v 8 Û Ü Ý Þ
9	w x y z 9 Ÿ Ź
0	0 \$ € @ _ ( ) < > ~
*	* # + - / = & %

## 5 Use more of your phone

### 5.1 Phonebook memory

Your phone has 12 phonebook memories providing you with the convenience for making calls. Each memory can store a name up to 12 characters and a number up to 24 digits.



Memory type	Associated key
Direct access memories	  
Extra memories	Digit keys 1 ~ 9

#### 5.1.1 Save phonebook memory

In standby mode:

- 1 Enter the number.  
Press and hold  to insert a pause.
  - It is shown as **P**.
- 2 Press and hold digit keys (1 to 9)

**OR**

- 2 Direct Memory (    ).
  - The number is saved. You will hear a confirmation tone and see **NAME?**.
- 3 Enter the name.
- 4 Press and hold the same memory key to save the name.

#### Note

Existing phonebook memory can be replaced by entering a number and a name at the same memory location. The new entry will overwrite the existing one without warning information shown.

#### 5.1.2 View phonebook memory

You can view these memories when the handset is in standby mode.

Press Direct Memory   

**OR**

- press and hold digit keys (1 to 9).
  - The name and number will be shown.

### 5.1.3 Delete all memories



You can delete all memories by using the **RESET** function. See page 15 for more information.

### 5.2 Personalizing your phone

#### 5.2.1 Give your phone a name

You can give your phone a different name. If you have more than one handset, you can give each handset its own name. The handset name can be up to 10 characters long. It can be composed of A-Z, 0-9 and space.



In standby mode:

- 1 Press and hold  until you see **MENU?**.
- 2 Enter **40**.
- 3 Press and hold .
  - The current handset name is shown.
- 4 Edit the name.
- 5 Press and hold  to confirm.

#### 5.2.2 Select display language

Your phone supports many languages.

In standby mode:

- 1 Press and hold  until you see **MENU?**.
- 2 Enter the language index number (see below).
- 3 Press and hold  to confirm.



Language Name	Index Number
English	10
Dutch	11
French	12
German	13
Italian	14
Russian	15
Spanish	16
Turkish	17
Danish	18
Swedish	19
Norwegian	20
Greek	21

Language Name	Index Number
Polish	22
Portuguese	23
Finnish	24
Hebrew	25

### 5.2.3 Turn the backlight on/off

The LCD and the key  can be lit when the phone is being used.



In standby mode:

- 1 Press and hold  until you see **MENU?**.
- 2 Enter **44**.
- 3 Press and hold  to confirm.
  - *The new setting is shown.*

### 5.2.4 Auto Pick-up

Auto Pick-up gives you the convenience of answering a call by picking up the handset from the cradle or charger. You don't need to press .



In standby mode:

- 1 Press and hold  until you see **MENU?**.
- 2 Enter **42**.
- 3 Press and hold  to confirm.
  - *The new setting is shown.*

### 5.2.5 Auto Hang-up

Auto Hang-up gives you the convenience of ending a call by putting the handset onto the charging cradle. You don't need to press .



In standby mode:

- 1 Press and hold  until you see **MENU?**.
- 2 Enter **43**.
- 3 Press and hold  to confirm.
  - *The new setting is shown.*

### 5.2.6 Auto Dialing



Auto Dialing gives you the convenience of making a call from phonebook memories associated to key 1 or 2 by pressing and holding the key 1 or 2 during standby. You don't need to press .

In standby mode:

- 1 Press and hold  until you see **MENU?**.
- 2 Enter **45**.
- 3 Press and hold  to confirm.
  - *The new setting is shown.*





### 5.2.7 Select ringing melody

In standby mode:

- 1 Press and hold  until you see the current melody name.
- 2 Select the desired melody by pressing digit keys 0 to 9.
- 3 Press  to confirm.

### 5.2.8 Change the ringing volume

In standby mode:

- 1 Press and hold  until you see the current melody name.
- 2 Press  and  to increase or decrease the volume level.
- 3 Press  to confirm.



#### Note

If ringing volume level is set to **OFF**,  appears.

### 5.2.9 Turn the key tone on/off

Key tones are tones your handset makes each time you press a key on the handset.

In standby mode:

- 1 Press and hold  until you see **MENU?**.
- 2 Enter **41**.
- 3 Press and hold  to confirm.
  - *The new setting is shown.*

## 5.3 Advanced features

### 5.3.1 Register a handset

If you have inadvertently unregistered your handset, you can register it again. Additional handsets must be registered to the base before use.

In standby mode:

- 1 Press and hold  until you see **MENU?**.



- 2 Enter **51**. Press and hold **\*#** until you see **BASE?**.
- 3 Select the base using the digit keys (1, 2, 3 or 4). Press and hold **\*** to confirm.
- 4 If you see **PIN?**, enter the system PIN (default 0000). Press and hold **\*** until you see **SEARCHING....**
- 5 Press and hold **(\*)** on the base unit for 3 seconds.
  - The base will turn on the LED for 30 seconds.
  - If registration is successful, handset will show **REGISTERED**.

### **Note**

If registration was not successful, the handset will show **FAILED**. Repeat the above procedures and try again.

### 5.3.2 Select a base

If your handset is registered to more than 1 base, you can select which base the handset will use. You can choose a fixed base or you can allow the handset to automatically search for a nearby available base (AUTO base selection).

In standby mode:

- 1 Press and hold **\*#** until you see **MENU?**.
- 2 Enter the base index number (see below).
- 3 Press and hold **\*** to confirm.
  - If successful, handset will show the selected base. Otherwise, handset will show **FAILED**.

Base selection	Index Number
BASE 1	64
BASE 2	65
BASE 3	66
BASE 4	67
AUTO	68

### 5.3.3 Un-register a handset

A handset can un-register another handset registered to the same base station. It cannot un-register itself.

In standby mode:

- 1 Press and hold **\*#** until you see **MENU?**.

- 2 Enter **52**. Press and hold **\*#** until you see **HANDSET?**.
- 3 Enter the number of the handset you want to un-register. Press and hold **\*** to confirm.
- 4 If you see **PIN?**, enter the system PIN (default 0000).
- 5 Press and hold **\*** to confirm.
  - If un-registration is successful, your handset will show **DELETED**.

### 5.3.4 Change the system PIN

A PIN (Personal Identification Number) is required to register and un-register a handset. The factory preset PIN is 0000. You can change it to a unique one of your own. PIN can be up to 8 digits long.

In standby mode:

- 1 Press and hold **\*#** until you see **MENU?**.
- 2 Enter **50**. Press and hold **\*** until you see **PIN?**.
- 3 Enter the system PIN. Press and hold **\*** until you see **NEW PIN?**.
- 4 Enter the new PIN. Press and hold **\*** until you see **REPEAT PIN?**.
- 5 Enter the new PIN again for verification. Press and hold **\*** to confirm.
  - If PIN is changed successfully, handset will show **SAVED**.

### **Note**

The default product PIN code is preset to 0000. If you change this PIN code, keep the PIN details in a safe place where you have easy access to them. Do not lose the PIN code.

### 5.3.5 Reset your phone

You can reset your phone to factory settings. To find out what settings are being reset, see page 18.

In standby mode:

- 1 Press and hold **\*#** until you see **MENU?**.
- 2 Enter **01** if you want to delete all the memories.

### **OR**

- 2 Enter **02** if you want to keep the memories unchanged.

- 3 Press and hold **\*#** until you see **PROCESSING...**

### 5.3.6 Select flash duration

This option is helpful when using operator services. The default value of flash duration that is preset in your XL340 should be the best suited for your country network and therefore you should not need to change it.

In standby mode:

- 1 Press and hold **\*#** until you see **MENU?**.
- 2 Enter the flash duration index number (see below).
- 3 Press and hold **\*#** until you see the new setting is displayed.

Flash duration	Index Number
FLASH 1	71
FLASH 2	72
FLASH 3	73
FLASH 4	74
FLASH 5	75
FLASH 6	76
FLASH 7	77

### 5.3.7 Select pause duration

This option is helpful when using operator services. The default value of pause duration that is preset in your XL340 should be the best suited for your country network and therefore you should not need to change it.

In standby mode:

- 1 Press and hold **\*#** until you see **MENU?**.
- 2 Enter the pause duration index number (see below).
- 3 Press and hold **\*#** until you see the new setting is displayed.

Pause duration	Index Number
PAUSE 1	78
PAUSE 2	79

### 5.3.8 Select dial mode (country dependent)

The default value of dial mode that is preset in your XL340 should be the best suited for your country network and therefore you should not need to change it.

In standby mode:

- 1 Press and hold **\*#** until you see **MENU?**.
- 2 Enter **60**.
- 3 Press and hold **\*#** to confirm.
  - *The new setting is shown.*

### 5.3.9 Temporary tone dialing in pulse dial mode

If the dialing mode is set to pulse, you can press and hold **\*#** to set temporary tone dialing.

- **d** will be displayed on the screen. All the following digits will be dialed as tones until you hang up.

### 5.3.10 Set prefix insertion

The prefix insertion feature checks and formats your outgoing call number before it is dialed. If the first few digits of the number match with the digits you set as **DETECT**, they will be replaced by the digits you set as **PREFIX**.

For example, you set **DETECT** as **604** and **PREFIX** as **967**. When you are making a call to 6045551212, the actually dialed number will be 9675551212. The number shown is still 6045551212.

In standby mode:

- 1 Press and hold **\*#** until you see **MENU?**.
- 2 Enter **62**. Press and hold **\*#**.
- 3 Edit the **DETECT** digits

**OR**

- 3 enter a new one if you see **DETECT?** (such as 604 in the above example).
- 4 Press and hold **\*#** to confirm.
- 5 Edit the **PREFIX** digits

**OR**

- 5 enter a new one if you see **PREFIX?** (such as 967 in the above example).
- 6 Press and hold **\*#** to confirm.

### **Note**

If the dialed number starts with **#**, **\*** or **P**, the PREFIX will not be added.

### **Note**

Press and hold  to insert a pause in PREFIX.

---

#### **5.3.11 Message waiting indication**

If you have subscribed to the voice mail service from your local service provider,  will be on when you have a new message in your mailbox.

The LED on base station will blink.

After you've listened to all the new messages,  will turn off. The LED on base station will stop blinking.

### **Note**

You may also see **VOICEMAIL** shown on the display if you have new message in your mailbox, but it will disappear after you make an outgoing call.

---

#### **5.3.12 Paging handset**

You can use this feature to locate the handsets.

In standby mode, press  on the base.

- *All handsets registered to the base will produce the paging tone for 30 seconds and the screen displays **PAGING...***

### **Note**

You can stop the paging by pressing any key on each handset or pressing  on the base again.

---

## 6 Default settings

These are the factory pre-programmed settings of your phone.

<b>Functions</b>	<b>Settings after Reset</b>
Display Language	Country dependent
Handset Name	PHILIPS
Auto Pick-up	Off
Auto Hang-up	On
Backlight	On
Dial Mode*	Tone
Key Tone	On
Flash Duration*	Flash 1
Pause Duration	Pause 1
Prefix	[Empty]
Melody Selection	RING 1
Ring Volume	3 blocks
Receiver Volume	3 blocks
Speaker volume	3 blocks
Message Waiting Indication	Off
PIN Code	0000
Base selection	AUTO
Auto Dialing	Off
Last dialed number	[Empty]
Phonebook memories**	[Empty]

\* Country dependent features

\*\*These memories will remain unchanged for Reset 02

---

## 7 Quick reference table for phone menus

The table below lists the menus of your phone.

Reminder: Press and hold \* until you see **MENU?** to enter the menu index number.

Press **END** to exit from any menu instantly.

Index Number	Menu
01	Full Reset
02	Partial Reset
10 - 25	Language
40	Handset Name
41	Key Tone
42	Auto Pick-up
43	Auto Hang-up
44	Backlight
45	Auto Dialing
50	PIN Code
51	Registration
52	Un-registration
60	Dial Mode
62	Prefix Insertion
64 - 68	Base Selection
71 - 77	Flash Duration
78 - 79	Pause Duration

---

## 8 Technical data

### **General telephone features**

- Caller name & number identification
- 12 phonebook memories with direct access
- Conference call and voicemails
- Intercom
- Base selection

### **Battery**

- 2 x AAA NiMH 750mAh batteries

### **Weight and dimensions**

- Handset: 160 grams  
180 x 32 x 56 mm (H x D x W)
- Base: 150 grams  
94 x 128 x 117 mm (H x D x W)

### **Temperature range**

- Operation: 0°C to +46°C
- Storage: -25°C to +70°C

### **Relative humidity**

- Operation: Up to 95% at 40°C
- Storage: Up to 95% at 40°C

---

## 9 Frequently asked questions

---

In this chapter you will find the most frequently asked questions and answers about your phone.

---

### Set up

#### No dial tone

- Check the phone and power connections.
- The handset may be out of range. Move closer to the base station.
- The battery capacity may be low. Charge battery.

#### “Range/Signal” icon is flashing

- Move closer to the base station.
- If the handset displays **UNREGISTERED**, register the handset, see page 14.

#### The handset does not switch on

- Charge the battery: Put the handset on base/charger. The battery icon is animated while charging. After a few moments the phone will switch on.

#### The handset does not charge

- Check base/charger connections.
- The battery may be defective. Purchase new battery from your dealer.
- Check that the batteries are inserted correctly.
- Make sure the handset is placed properly on the base/charger. The battery icon is animating while charging.

#### Communication is lost during a call

- Charge the battery.
  - Move closer to the base station.
- 

### Sound

#### Handset does not ring

- Check that the handset melody volume is turned on. See page 14.

- Too many phones may be sharing the same phone line. Disconnect some of the phones.

#### No parking tone from the handset

- Check the power connections of the base/charger.
  - The handset may not be placed properly. Try again.
  - Charging contacts may be dirty. Clean contacts with a damp cloth.
- 

### Product behaviour

#### Bad audio quality (crackles, echo, etc.) during a call

- The handset may be nearly out of range. Move closer.
- The phone may be interfered by nearby electrical appliance. Move the base unit to a different location.
- The phone may be at a location with thick walls. Move the base unit to a different location.

#### Caller ID does not display

- Caller ID service may not be activated. Check with your service provider.
- The caller's information may be withheld or is unavailable.
- Let the phone ring at least once before answering it.

#### Second call service does not work

- Second call service may not be activated. The second call service may not be available from your telephone operator, check availability of the service with your telephone service provider.
- Check that the flash selection is correct. See page 16.

#### \* Tip

If the above solutions do not help, remove the power from both the base station and the handset. Wait for 15 minutes and try again.

---

## 10 Index

---

### **A**

Advanced features 14  
Answer a call 10  
Answer a second call 11  
Audio volume, adjust 10  
Auto Dialing 14  
Auto Hang-up 14  
Auto Pick-up 14

### **B**

Backlight on/off 14  
Base, overview 7  
Batteries 8, 20  
Battery door 8  
Battery life and range 9

### **C**

Call 10  
Call from phonebook memory 10  
Call timer 10  
Caller ID 21  
Character set table 11  
Charge batteries 8  
Charger 8  
Conference call 11  
Conformity 3  
Connect the base 8  
Connect the charger 8  
Connection 3

### **D**

Default settings 18  
Delete all phonebook memories 13  
Dial mode, change 16  
Dimensions 20  
Display 6  
Display icons 7  
Display language, select 13

### **E**

Earpiece 6  
End a call 10  
Environmental care 3

Example text entry 11  
Exit from Conference call 11

### **F**

Flash duration, select 16  
Frequently asked questions 21

### **G**

GAP standard 9  
Getting started 8

### **H**

Handsfree mode 10  
Help 3

### **I**

Insert the batteries 8  
Intercom 11

### **K**

Key tone on/off 14  
Keys, phone 6

### **L**

LED, base 7  
Line adaptor 5  
Line cord, connect 8  
Loudspeaker phone 10  
Low battery warning 9  
Lower case input table 12

### **M**

Make a call 10  
Message waiting indication 17  
Multi-handset packs 5

### **N**

Name, handset 13  
Number entry 11

### **P**

Page key 7  
Paging handset 17  
Pause duration, select 16  
Personalizing 13  
Phone, overview 6  
Phonebook memory 13



PIN 15

Power adapter, connect 8

Power requirements 3

Pre-Dial 10

Prefix set 16

## **W**

Warranty 9

Weight 20

Welcome mode 2

What's in the box 5

## **Q**

Quick reference table for phone menus 19

## **R**

Range 9

Recycling & disposal 3

Redial last number 10

Register a handset 14

Relative humidity 20

Reset phone 15

Ringer OFF 14

Ringing melody, select 14

Ringing volume, change 14

## **S**

Safety 3

Save phonebook memory 13

Second call 11

Select a base 15

Signal icon 9

Standby mode 9

System PIN, change 15

## **T**

Technical data 20

Temperature range 20

Temporary tone dialing 16

Text or number entry 11

Troubleshooting 21

## **U**

Un-register a handset 15

Upper case input table 11

## **V**

View phonebook memory 13

Voicemail 17





© 2007 Koninklijke Philips Electronics N.V.

All rights reserved.

Reproduction in whole or in part is prohibited without  
the written consent of the copyright owner.

Document order number: 3111 285 32831



Printed in PRC

## Free Manuals Download Website

<http://myh66.com>

<http://usermanuals.us>

<http://www.somanuals.com>

<http://www.4manuals.cc>

<http://www.manual-lib.com>

<http://www.404manual.com>

<http://www.luxmanual.com>

<http://aubethermostatmanual.com>

Golf course search by state

<http://golfingnear.com>

Email search by domain

<http://emailbydomain.com>

Auto manuals search

<http://auto.somanuals.com>

TV manuals search

<http://tv.somanuals.com>