

Kala plus 200



PHILIPS

Kala 200 (TD6131)

1. CONTENTS
2. INSTALLING TELEPHONE AND BASE STATION
 - Location of the base station
 - Inserting/Replacing batteries
 - Telephone connection
 - Charging/Recharging the telephone
 - Telephone range
 - Installing another KALA 200 handset
3. PRESENTATION OF TELEPHONE AND ACCESSORIES
4. THE DISPLAY
 - Programming icons
 - Icons for common functions
5. USING THE TELEPHONE
 - Calling directly/Hanging up
 - Taking a call
 - Placing a call on hold/Transferring a call
 - Earpiece volume adjustment
6. USING THE PHONEBOOKS
 - Storing your phone numbers
 - Consulting a phonebook
 - Calling from a phonebook
 - Changing a phonebook entry
 - Deleting an entry from the phonebook
 - Selecting the ringer type
7. THE LIST OF REDIAL NUMBERS AND INCOMING CALL LOG
 - List of numbers to redial
 - Incoming call log
8. HOW TO PROGRAM YOUR PHONE
 - Example: selecting and navigating
9. PROGRAMMING OPTIONS
 - Melody programming options
 - Registration of the handset with another base station
 - Settings programming option
 - Caller identification service
 - Other indirect programming options
10. TROUBLESHOOTING
11. YOUR PHILIPS WARRANTY
12. DECLARATION OF CONFORMITY
13. ENVIRONMENT AND SECURITY

Location of the base station

In order to reduce the risk of interference, place the base station at least 1m away from any other electrical appliance (telephone, television, computer, etc.)
The base station should be placed on a flat surface.
The base station should not be kept in a damp room, near a heat source or close to obstacles such as thick walls or metallic structures.

Inserting/Replacing batteries

Your handset is powered by two rechargeable AA/R6 batteries.
Only **AA 600 mAh rechargeable** batteries should be used as replacements.
Never use non rechargeable batteries.



1. Slide down the cover on the back of the telephone.
2. Insert batteries following the diagram.
3. Close the cover.

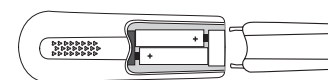
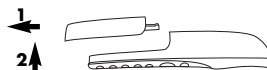

Telephone connection

On the bottom of the base station:

1. Connect the power supply (B) into the base station then plug the power adaptor into the easily accessible wall socket.
2. Connect the telephone cord (A) to the base station and then to the PTT wall socket.

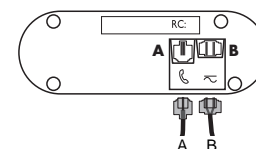

Charging/Recharging the telephone

While the batteries are being charged, flashes on the screen and shows . When the battery icon on the display shows , the batteries are fully charged.

You will hear a validation beep when you place the handset on the base station.
On first use or when new batteries have been inserted, charge the batteries for **at least 24 hours**.
You will hear a beep when you activate the telephone if the batteries need to be charged.

Telephone range

Your telephone has a range of : 50m indoors - 350m outdoors.

The symbol on the display indicates that the handset is connected on the base station.

Installing another KALA 200 handset

You can register up to 4 handsets with your base station (See Page 9 Programming options).
Additional handsets do not require additional telephone connections but do need a power supply adaptor. The reference of Additional Kala 200 handsets is TD 6830.



User guide

The handset may also be placed on the base station with the keypad face-up.

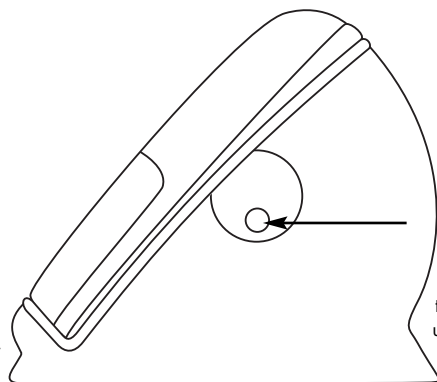

The key located on the base station side can be used to make all handsets ring at the same time.

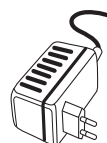

Mains adapter

Only use the power and telephone cables supplied with the telephone.

Telephone cable

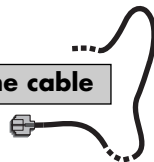

The batteries contain Cadmium and must be disposed of in compliance with the waste disposal regulations. Never use non-rechargeable batteries.

The manufacturer assumes no responsibility for non-respect of these regulations.

The crossed-out dustbin signifies that the battery should not be disposed of with general household waste.

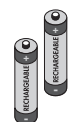

How to optimise batteries lifespan

If you plan not to use your phone for at least 15 days, we would suggest you to remove the batteries from the handset if you disconnect the mains power.

Batteries

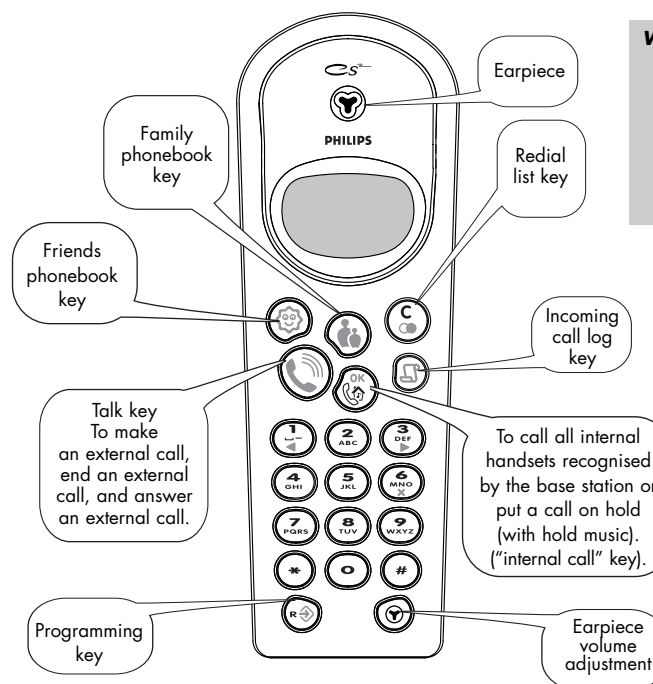

When using your telephone, 3 beep types will be heard:

- the error beep
- the validation beep
- the invitation beep

Beep indicators

Functions keys:

- moves to the left, or displays the previous entry.
 - moves to the right, or displays the following entry.
 - validates the entry.
 - press: removes a character during entry. press and hold: exit any mode (programming, phonebooks or lists).
- Modes:**
- list of last incoming calls.
 - list of last numbers dialed (redial key).
 - program the telephone.

THE DISPLAY

icon	status	description
	on	full
	1/4 full	less than 1/2 hour
	off	discharged
	on	new log entry
	off	no new log entry
	on	being accessed or incoming call (Caller identification service*)
	flashing	programming
	on	call in progress
	flashing	call arriving
	on	external call on hold or if a second or another handset: internal call in progress
	flashing	
	on	being accessed or incoming call (Caller identification service*)
	flashing	programming
	on	in range
	off	handset not registered to the base station
	flashing	out of range

Icons for common functions

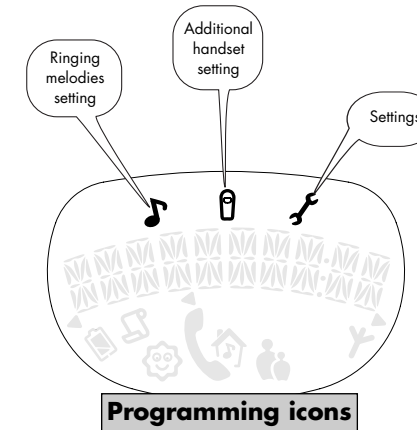

Programming icons

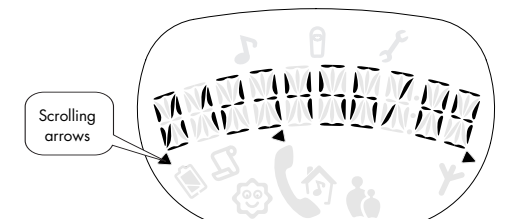

10 character screen

USING THE TELEPHONE

Talk key

Your phone rings. Press the "talk" key to be connected. Press the same key to hang up.

Call directly/Hang up

Enter your number, then press the "talk" key. Press the "talk" key to hang up.

Earpiece volume adjustment

During a call press this key to adjust the earpiece volume.

4 levels are available. They appear on the screen with the "+" symbol. The selected volume will be valid for the following calls.



Phonebook access (see description of the phonebook Page 6)

Press the "Friends" or "Family" phonebook key to access the chosen phonebook.

Note: only phonebooks containing entries can be accessed (otherwise, you have a beep error). Pressing a second time while scrolling will exit the phonebook.

*Caller identification service: This function is available if you have subscribed to your operator's Caller identification service. The network sends the caller's number to your telephone. If this number is stored in the Family or Friends phonebook, the corresponding icon will appear and the relevant melody will sound after the second ring (see Pages 6 and 7).



Placing a call on hold and transferring a call

Press the "internal call" key to place a call on hold, during which the person calling will hear music.

Press the "internal call" key to transfer a call (this option is only available if you have more than one handset). All the handsets on the base station will then be called. There is no need to wait for the receiver to pick up before hanging up (by pressing the "talk" key).

You have access to two phonebooks, each containing 10 names and numbers.

You can use these phonebooks to make calls and identify incoming calls if you have subscribed to the Caller identification (see Page 5).

When you receive an incoming call and the caller's number is stored in one of the phonebook, the corresponding  or  icon will be displayed and the associated melody will play after the second ring if you have subscribed to the Caller identification service.

Caller identification service:



The Caller identification function is available if you have subscribed to the Caller identification service.

If you have subscribed to the caller identification service from your operator, the screen will show the caller's number during the call.

The name will be displayed if it is stored in one of the phonebooks (see Page 7).

If you wish to know who is calling before you pick up, you can assign a specific melody to the caller; (see Page 9, *Programming options*).

Accessing and exiting the phonebook

Press  or  to access the phonebook. Press the same icon to exit the phonebook.

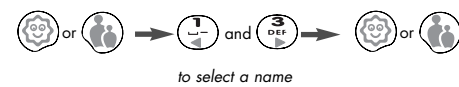

Accessing and selecting phonebook



Storing numbers in a phonebook

Each entry is made up of a name (maximum 10 characters) and a telephone number (maximum 25 characters).

To store an entry:

1. Enter the phone number, or have it displayed using one of the lists (see Page 7, *Incoming call log or list of redial numbers*).
2. Press the key of the desired phonebook  or .
3. After the beep, enter the name (see How to obtain the characters*) and press the  key to validate.

A validation beep sounds which indicates you go back to idle mode.

 If your country uses local prefixes, you will need to include these codes in your phonebook entries to ensure the Caller identification service works correctly.

Calling from a phonebook

Each phonebook can contain 10 names. Names are listed in alphabetical order.

Changing a phonebook entry

Only the phone number can be changed.



Deleting an entry from the phonebook



Selecting the ringer type

You have the possibility to change the pre-recorded melody of the Friends and Family phonebooks (see Page 8 *How to program your phone*). See also the programming example in the programming rules.

* How to obtain the characters:

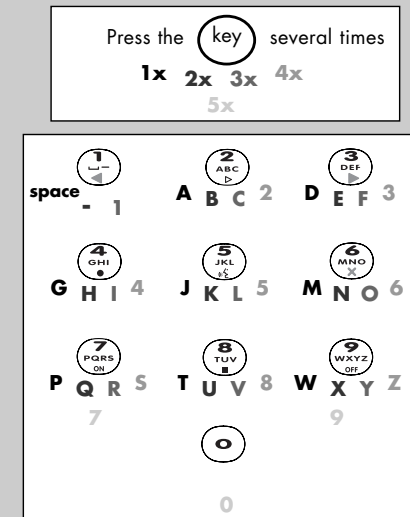

Example:

To enter the name "Patrick":

press  **once** for the letter "P"

press  **once** for the letter "A"

press  **once** for the letter "T"

press  **three times** for the letter "R"

press  **three times** for the letter "I"

press  **three times** for the letter "C"

press  **twice** for the letter "K"

If you make a mistake, simply press  to delete

List of numbers to redial**Pressing the following keys to access or exit the lists:**

C is used to access the redial list - a list of the last 5 numbers called, from the latest to the oldest. Each new entry deletes the oldest entry. You can use this function to automatically redial a caller's number.

Accessing the list of last numbers dialled (redial list)

Use the **C** key to access the list of last numbers dialled (you will hear a beep if there are no entries in the list).
Use the same key to exit the list.

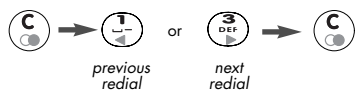
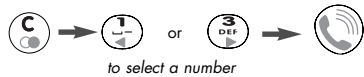
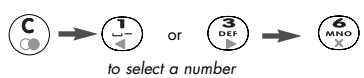
Consulting the list**Calling a displayed number****Deleting a number****Entering a number into the phonebook**

! If you lose your way press and hold **C** to exit any mode (programming, phonebooks or lists)

Incoming call log

The call log contains the last 10 external calls received, starting with the most recent. If you have subscribed to the Caller identification service (see Page 5), you will be able to store number or name in the log (according to the information provided by the network).

Accessing the log

Use the **C** key to access the log. Use the same key to exit the log.

Consulting the log

You will only be able to access the information shown on the screens below if you have subscribed to the Caller identification service.

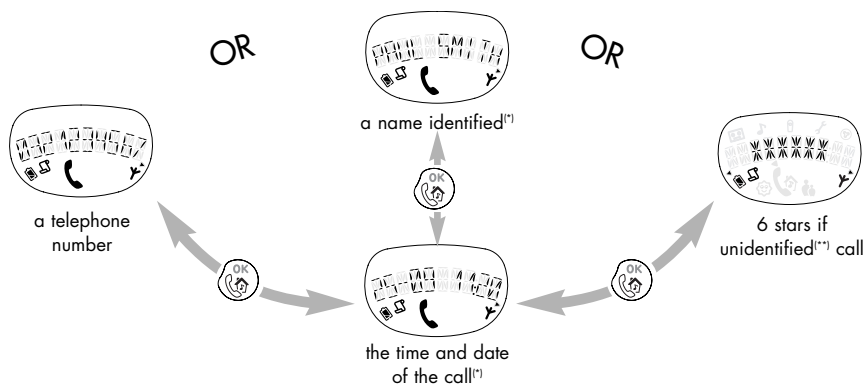

(*) This function depends on the network.

(**) Unlisted numbers, withheld caller id and calls from abroad.

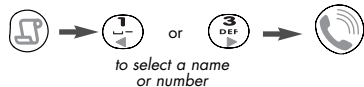
Calling a number from the log**Deleting a number from the log****Entering a number stored in a list into one of the phonebooks**

To access the programming icons, press the **R** key.

Programming icons:

- on: programming mode (consultation) or during a modification
- off: normal mode
- flashing: options can be selected

3 icons are displayed on the screen:

- Volume and melody settings
- To register the handset with another base
- Other programming option settings

To select one of the icons, use the key **1** and **3** and then validate your choice by pressing the **OK** key.

For instance: how to change the melody.

Press the **R** key, once then press **C**.

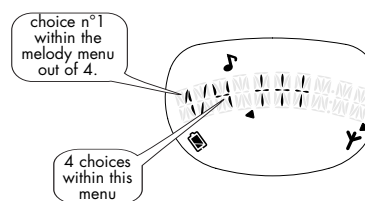
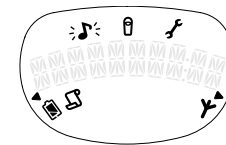

Use level 1/4 to select the melody volume. Scroll through the different volume settings using the **1** and **3** keys. The default setting is "+++ (3)".

Note: the screen will show the default or selected value. If registering an additional handset, you will need to enter the RC code (4-figure access code) shown on the bottom of the base station (see Page 9). Enter 4 figures when "0000" is displayed (and the scroll arrows have disappeared).

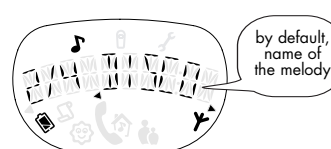

To select the "DISCO" melody, press **OK** to validate. If you wish to select the "RAIN" melody, press **3** to choose the melody and press **OK** to validate.

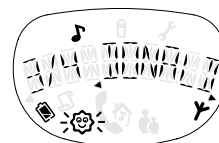

You can also select a melody specific to the Friends phonebook from the 7 melodies available. Press **OK** when you have selected the melody. The melody will sound after the second ring. This function is only available if you have subscribed to the operator's Caller identification service.



You can select a specific melody for the Family phonebook from the 7 available. Press **OK** then **R** once you have chosen the melody.



Press **R** to exit the programming options.

PROGRAMMING OPTIONS

To enter the programming options:

Press  to enter the programming options.

Enter the following functions by pressing  once or several times.



Melody programming options

Function number	Programmable functions	Select	Default value
1/4	Selects melody volume	+ (1) to ++++ (4)	+++ (3)
1x	Selects melody of handset (general)	7 melodies proposed	Disco
2x	Selects melody of handset (Friends phonebook)	7 melodies proposed	Birdy
3x	Selects melody of handset (Family phonebook)	7 melodies proposed	Starry

Note: the sound volume is the same for all melodies.



Registration of the handset with another base station

This option allows you to register the handset with another base station. You will need to switch the base station onto registration mode before entering the code. To place a Kala 200 base station in registration mode, simply disconnect and re-connect the mains supply. The RC code is shown on the bottom of the base station.

Function number	Programmable function	Select	Default value
1/1	Registers the handset	RC Code ⁽¹⁾	Bottom of the base





Settings programming options

Function number	Programmable functions	Select	Default value
1/5	Enters number of different CLI ⁽³⁾	List of CLI available	1
1x	Enters the dial mode ⁽²⁾	TONE, PULSE	Depends
2x	Enters network type ⁽⁴⁾	A (residential), B, C, D (PABX)	A
3x	Enters callback type ⁽⁵⁾ (long/short flash)	*** (short), ***** (long)	Depends
4x	Inserts automatic pause ⁽⁶⁾	NO, YES	NO

- RC code:** 4-figure access code found on the bottom the base station that allows you to register an additional handset (see the user manual for the additional handset).
- Dial mode:** this allows you to select either voice frequency dialling (faster dialling, access to operator services) or digital dialling. The availability of this function depends on the country.
- CLI or Caller identification service:** the Caller identification service (Name and Number) is available only if you have subscribed to the service with an operator (according to availability).
- Network type:** your telephone has a default configuration for public telephone lines (option A). You can choose between 3 other network types to adjust the sound qualities for a PABX/ISDN set-up.
- Flash type:** the operation of some services accessed using the  key (Call Waiting, Call Forward, etc.) will depend on the flash setting (short/long) depending on your installation type (ISDN, Public, PABX).
- Automatic pause:** this function allows you to insert a prefix before the telephone number.

Other indirect programming options

This option can be accessed using a combination of two keys, after pressing:

Sequence of keys	Programmable functions	Select	Default value
 + 	Unregisters the handset	RC code ⁽¹⁾	Bottom of the base



Press  to exit the programming options.

TROUBLESHOOTING

Problem	Error Beep	Cause or causes	Solution
• No dialling tone when pressing the talk key.	Yes	The base station is not properly connected to electricity or to the telephone sockets.	Check the connections and ensure you have used the telephone cable provided in the box.
	Yes	Batteries are low (the insert battery icon symbol is displayed).	Charge batteries (see Installing telephone and base station Page 2).
•  icon not displayed or blinking.	-	The handset is out of range.	Register the handset to the base station (see page 9). Move closer to the base station.
• When the handset is placed on the charging unit, no beep is heard.	-	The handset is not placed correctly on the base station charging unit.	Take the handset off the base station and put it back again. Clean them with a clean and dry cloth.
	-	Charging contacts are dirty.	
• Battery icon remains empty although the handset has charged for 24 hours.	-	Handset batteries are defective.	Please contact your PHILIPS dealer in order to purchase new rechargeable batteries (see Inserting/Replacing batteries Page 2).
• No symbol on the display.	-	Batteries are low.	Charge batteries (see Installing telephone and base station Page 2).
• A phonebook entry has not been memorised.	Yes	The phonebook you wish to use is full.	Delete some entries to free memory spaces.
• Bad audio quality (cracks, mute, echo, vibration, etc.).	-	Base station plugged too near from other electrical appliance.	Try to plug the base station in another place.
	-	or: Base station installed in a room with thick walls.	or: Please change the network type.
	-	or: You are using the handset too far from the base station.	or: Move closer to the base station.
• The CLI does not work.	-	Using operator different to default.	Please select another CLI.

Philips has designed this product to work on PSTN line and cannot guarantee the complete application on ISDN network.
The KALA 200 Plus is compliant with operator's analogue interface.
The KALA 200 Plus can only be connected to the British telephone network.
The geographical area in which the equipment may be used is shown on the label on the bottom of the base station.
Product may only be used in this zone.

YOUR PHILIPS WARRANTY

Dear customer,

Thank you for purchasing this Philips product which has been designed and manufactured to the highest quality standards. If, unfortunately, something should go wrong with this product Philips guarantees free of charge labour and replacement parts irrespective of the country where it is repaired during a period of 12 months from date of purchase (6 months for replacement/rechargeable batteries). This international Philips guarantee complements the existing national guarantee obligations to you of dealers and Philips in the country of purchase and does not affect your statutory rights a customer.

The Philips guarantee applies provided the product is handled properly for its intended use, in accordance with its operating instructions and upon presentation of the original invoice or cash receipt, indicating the date of purchase, dealer's name and model and production number of the product.

The Philips guarantee may not apply if:

- The documents have been altered in any way or made illegible;
- The model or production number on the product has been altered, deleted, removed or made illegible;
- Repairs or product modifications and alterations have been executed by unauthorised service organisations or person;
- Damage is caused by accidents including but not limited to lightning, water or fire, misuse or neglect.

Please note that the product is not defective under this guarantee in the case where modifications become necessary in order for the product to comply with local or national technical standards which apply in countries for which the product was not originally designed and/or manufactured. Therefore always check whether a product can be used in a specific country.

In case your Philips product is not working correctly or is defective, please return your phone to the place of purchase or the Philips National Service Centre. In the event you require service whilst in another country a dealer address can be given to you by the Philips Consumer Help Desk in that country.

In order to avoid unnecessary inconvenience, we advise you to read the operating instructions carefully before contacting your dealer.

- Methods of Transport within the UK:

Please be aware whichever method of transport is chosen it is the consumers' responsibility to package the faulty unit for return to a level which prohibits accidental damage. Philips is not responsible for damage/loss caused during carriage to the Service Centre.

Freepost: Please write the following address onto your package. This method of transport will take 2-3 working days to reach the Service Centre.

PHILIPS SERVICE CENTRE
FREEPOST (SCE10569)
RUGBY
Warwickshire
CV21 1BR

NB: Philips recommend all parcels to be returned to the Philips Service Centre be submitted over the counter at your Post Office and a proof of postage requested.

Please note the Royal Mail insurance limit for lost/damage using the Freepost service is £26. Up to £250 insurance and next day delivery can be obtained via Royal Mail Special Delivery, however, the consumer will be responsible for this cost.*

- Methods of Transport within IRELAND:

Please contact Philips Service Support, Dublin.

IMPORTANT (for UK only):

Please ensure the following are included when returning a genuinely faulty phone to the Philips Service Centre:

- Name.
- Return Delivery address.
- Daytime contact number.
- Proof of Purchase (copy)
- For Dect phones both handset and base have to be returned.
- Accessories: power supply line cords.
- A brief description of the assumed fault
- Despatch note (if your phone has previously been exchanged).

Failure to include all the necessary information will cause delays in servicing your phone.

Please allow 2-3 days from receipt at the service centre for your replacement/repaired product to be returned to you. If an out of warranty charge applies Philips shall contact you before the product is returned.

Philips shall pay for the return carriage on all in-warranty exchanges.

*Should you wish to return your products for service at your own cost (via a courier service or Royal Mail Special Delivery) please ensure the items are suitably packed for transport and sent to the following address:

Philips Service Centre
1 Great Central Way
Butlers Leap
Rugby
Warwickshire
CV21 3XH

For Philips Service Support in UK, (incl. Channel Islands) please call 0870 900 9070.

(Open during normal business hours, excluding National holidays and weekends).

Kala

200



PHILIPS

12

DECLARATION OF CONFORMITY

We, **PHILIPS Consumer Communications**
Route d'Angers 72081
Le Mans Cedex 9
France

Declare that the product Kala 200 (BS 6131 + HS 6131) is in compliance with ANNEX III of the R&TTE Directive 99/05/EC and then with the following essential requirements:

Article 3.1 a : (protection of the health & the safety of the user) EN 60950 (92) Ed.2 + amendments 1,2 (93) ; 3 (95) ; 4 (97) and 11 (97)

Article 3.1 b : (protection requirements with respect to electromagnetic compatibility) ETS 300 329 (97)

Article 3.2 : (effective use of the radio spectrum) TBR6 (97)

The presumption of conformity with the essential requirements regarding Council Directive 99/05/EC is ensured.

Date: 12/12/2000 Le Mans

Cordless Business Director

13

PHILIPS KALA: ENVIRONMENT AND SECURITY



PHILIPS KALA 200

Your telephone has all advantages of the latest technological advances which make it even simpler and easier to use.

Safety information

This equipment is not designed for making emergency telephone calls when the power fails. An alternative should be made available for access to emergency calls.

The CE marking certifies compliance with technical regulations in accordance with the Directive 1999/5/EC for the safety of the user, electromagnetic perturbations and for radio spectrum.

Power requirements

This product requires an electrical supply of 220-240 volts, alternating monophased current, excluding IT installations defined in standard EN 60-950.

WARNING !

The electrical network is classified as dangerous according to criteria in the standard EN60-950. The only way to power down this product is by unplugging the power cable from the electrical outlet. Ensure the electrical outlet is located to the apparatus and is always easily accessible.

To be able to make calls in the event of a power cut, it is recommended that this telephone be used as a complement to another telephone which does not require mains power.

Telephone connection

The voltage on the network is classified as TNV-3 (Telecommunication Network Voltages, as defined in the standard EN 60-950).

Safety precautions

Do not allow the handset to come into contact with water.

Do not open the handset or the base station. This could expose you to high voltages. Contact our after-sales service for all repairs.

Do not allow the charging contacts or the battery to come into contact with conductive materials such as keys, paper clips, rings, bracelets, etc.

Make sure you insert the batteries with their polarities in the correct position.

Environmental care

Your telephone has also benefited from the Philips EcoDesign program –Environmental Conscious Product Design – which considers the environmental impact of a product during its entire life cycle.

Please remember to observe the local regulations regarding the disposal of your packaging materials, exhausted batteries and old phone and where possible promote their recycling.

Philips has marked the battery and packaging with standard symbols designed to promote the recycling and appropriate disposal of your eventual waste.

Battery:

* The crossed-out dustbin signifies that the battery should not be disposed of with general household waste.



Packaging:

The mobius loop symbol signifies the labeled packaging material is recyclable.



The green point symbol signifies that a financial contribution has been made to the associated national packaging recovery and recycling system (e.g. EcoEmballage in France).



© 2000 - Philips Consumer Communications - Division of Philips France
UK - 4311 256 07402 - Printed in Europe - All rights reserved

Free Manuals Download Website

<http://myh66.com>

<http://usermanuals.us>

<http://www.somanuals.com>

<http://www.4manuals.cc>

<http://www.manual-lib.com>

<http://www.404manual.com>

<http://www.luxmanual.com>

<http://aubethermostatmanual.com>

Golf course search by state

<http://golfingnear.com>

Email search by domain

<http://emailbydomain.com>

Auto manuals search

<http://auto.somanuals.com>

TV manuals search

<http://tv.somanuals.com>