

Register your product and get support at

[www.philips.com/welcome](http://www.philips.com/welcome)

CD 150



---

## Telephone

---



### **Warning**

Use only rechargeable batteries.

Charge the handset for 24 hours before use.

**PHILIPS**



# Table of contents

<b>1</b>	<b>Safety information</b>	<b>3</b>	4.3	Install your phone	14
1.1	Equipment Approval Information	3	4.4	Menu structure	16
1.2	Interference Information	4	<b>5</b>	<b>Using your phone</b>	<b>18</b>
1.3	Hearing Aid Compatibility (HAC)	5	5.1	Make a call	18
1.4	FCC RF Radiation Exposure Statement	5	5.2	Answer a call	19
<b>2</b>	<b>Important</b>	<b>6</b>	5.3	End a call	19
2.1	Power requirements	6	<b>6</b>	<b>Use more of your phone</b>	<b>20</b>
2.2	Conformity	7	6.1	Switch the handset on/off	20
2.3	Electric, Magnetic and Electromagnetic Fields ("EMF")	7	6.2	Keypad lock/unlock	20
2.4	Recycle your batteries	7	6.3	Text or number entry	20
2.5	Service Centers	8	6.4	Call in progress	20
<b>3</b>	<b>Your phone</b>	<b>9</b>	6.5	Using your phonebook	21
3.1	What's in the box	9	6.6	Using the redial list	23
3.2	Overview of your phone	10	6.7	Using the call log	23
3.3	Display icons	12	6.8	Using the intercom	25
3.4	Overview of the base station	12	6.9	Handset locating	26
<b>4</b>	<b>Getting started</b>	<b>13</b>	<b>7</b>	<b>Personal settings</b>	<b>27</b>
4.1	Connect the base station	13	7.1	Change the handset name	27
4.2	Wall mounting the base	13	7.2	Handset Tones	27
			7.3	Change the display language	28
			7.4	Activate/deactivate auto hang-up	28

# Table of contents

<b>8</b>	<b>Clock and Alarm</b>	<b>29</b>
8.1	Set date and time	29
8.2	Set date/time format	29
8.3	Set alarm	29
8.4	Set alarm tone	30
<b>9</b>	<b>Advanced settings</b>	<b>31</b>
9.1	Change Master PIN	31
9.2	Registration	31
9.3	Unregister	31
9.4	Reset unit	32
9.5	Set area code	32
9.6	Set prefix	32
9.7	Change flash time	33
9.8	Change the dial mode	33
9.9	Set first ring	33
9.10	Default settings	34
<b>10</b>	<b>Technical data</b>	<b>35</b>
<b>11</b>	<b>Frequently asked questions</b>	<b>36</b>
<b>12</b>	<b>Index</b>	<b>38</b>

---

# 1 Safety information

---

## 1.1 Equipment Approval Information

Your telephone equipment is approved for connection to the Public Switched Telephone Network and is in compliance with parts 15 and 68, FCC Rules and Regulations and the Technical Requirements for Telephone Terminal Equipment published by ACTA.

---

### 1.1.1 Notification to the Local Telephone Company

On the bottom of this equipment is a label indicating, among other information, the US number and Ringer Equivalence Number (REN) for the equipment. You must, upon request, provide this information to your telephone company. The REN is useful in determining the number of devices you may connect to your telephone line and still have all of these devices ring when your telephone number is called. In most (but not all) areas, the sum of the RENs of all devices connected to one line should not exceed 5. To be certain of the number of devices you may connect to your line as determined by the REN, you should contact your local telephone company. A plug and jack used to connect this equipment to the premises wiring and telephone network must comply with the applicable FCC Part 68 rules and requirements adopted by the ACTA. A compliant telephone cord and modular

plug is provided with this product. It is designed to be connected to a compatible modular jack that is also compliant. See installation instructions for details.

#### Notes

- This equipment may not be used on coin service provided by the telephone company.
- Party lines are subject to state tariffs, and therefore, you may not be able to use your own telephone equipment if you are on a party line. Check with your local telephone company.
- Notice must be given to the telephone company upon permanent disconnection of your telephone from your line.
- If your home has specially wired alarm equipment connected to the telephone line, ensure the installation of this product does not disable your alarm equipment. If you have questions about what will disable alarm equipment, consult your telephone company or a qualified installer.

US Number is located on the cabinet bottom.

REN Number is located on the cabinet bottom.

---

### 1.1.2 Rights of the Telephone Company

Should your equipment cause trouble on your line which may harm the telephone network, the telephone company shall, where practicable, notify you that temporary discontinuance of service may be required. Where prior notice is not practicable and the circumstances

warrant such action, the telephone company may temporarily discontinue service immediately. In case of such temporary discontinuance, the telephone company must: (1) promptly notify you of such temporary discontinuance; (2) afford you the opportunity to correct the situation; and (3) inform you of your right to bring a complaint to the Commission pursuant to procedures set forth in Subpart E of Part 68, FCC Rules and Regulations.

The telephone company may make changes in its communications facilities, equipment, operations or procedures where such action is required in the operation of its business and not inconsistent with FCC Rules and Regulations. If these changes are expected to affect the use or performance of your telephone equipment, the telephone company must give you adequate notice, in writing, to allow you to maintain uninterrupted service.

---

## 1.2 Interference Information

This equipment generates and uses radio frequency energy which may interfere with residential radio and television reception if not properly installed and used in accordance with instructions contained in this manual. Reasonable protection against such interference is ensured, although there is no guarantee this will not occur in a given installation. If interference is suspected and verified by switching this equipment on and off, the user is encouraged to try to correct the

interference by one or more of the following measures: Reorient the radio/television receiver's antenna, relocate the equipment with respect to the receiver, plug the equipment and receiver into separate circuit outlets. The user may also wish to consult a qualified radio/television technician for additional suggestions. This equipment has been fully tested and complies with all limits for Class B computing devices pursuant to part 15 FCC Rules and Regulations. This device complies with RSS-210 of Industry Canada. Operation is subject to the following two conditions: (1) This device may not cause interference, and (2) This device must accept any interference, including interference that may cause undesired operation of the device.

This device complies with Part 15 of the FCC Rules. Operation is subject to the following two conditions:

(1) This device may not cause harmful interference; and (2) This device must accept any interference received, including interference that may cause undesired operation.

This equipment has been tested and found to comply with the limits for a Class B digital device, pursuant to Part 15 of the FCC Rules. These limits are designed to provide reasonable protection against harmful interference in a residential installation.

This equipment generates, uses, and can radiate radio frequency energy and, if not installed and used in accordance with the instructions, may cause harmful interference to radio communications.

However, there is no guarantee that interference will not occur in a particular installation.

Privacy of Communications may not be ensured when using this product.

If this equipment does cause harmful interference to radio or television reception, which can be determined by turning the equipment off and on, the user is encouraged to try to correct the interference by one or more of the following measures:

- Reorient or relocate the receiving antenna (that is, the antenna for radio or television that is “receiving” the interference).
- Reorient or relocate and increase the separation between the telecommunications equipment and receiving antenna.
- Connect the telecommunications equipment into an outlet on a circuit different from that to which the receiving antenna is connected.

If these measures do not eliminate the interference, please consult your dealer or an experienced radio/television technician for additional suggestions. Also, the Federal Communications Commission has prepared a helpful booklet, “How To Identify and Resolve Radio/TV Interference Problems.” This booklet is available from the U.S. Government Printing Office, Washington, D.C. 20402. Please specify stock number 004-000-00345-4 when ordering copies.

Notice: The changes or modifications not expressly approved by the party responsible for compliance could void the user's authority to operate the equipment.

---

### **1.3 Hearing Aid Compatibility (HAC)**

This telephone system meets FCC/ Industry Canada standards for Hearing Aid Compatibility.

---

### **1.4 FCC RF Radiation Exposure Statement**

This equipment complies with FCC RF radiation exposure limits set forth for an uncontrolled environment. This equipment should be installed and operated with a minimum distance of 20 centimeters between the radiator and your body. This transmitter must not be co-located or operated in conjunction with any other antenna or transmitter. For body worn operation, this phone has been tested and meets the FCC RF exposure guidelines when used with the belt clip supplied with this product. Use of other accessories may not ensure compliance with FCC RF exposure guidelines.

---

## 2 Important

Take time to read this user manual before you use your phone. It contains important information and notes regarding your phone.

**NOTICE:** This product meets the applicable Industry Canada technical specifications.

The equipment must be installed using an acceptable method of connection. The customer should be aware that compliance with the above conditions may not prevent degradation of service in some situations. Repairs to certified equipment should be made by an authorized Canadian maintenance facility designated by the supplier. Any repairs or alterations made by the user to this equipment, or equipment malfunctions, may give the telecommunications company cause to request the user to disconnect the equipment.

Users should ensure for their own protection that the electrical ground connections of the power utility, telephone lines and internal metallic water pipe systems, if present, are connected together. This precaution may be particularly important in rural areas.

**CAUTION:** Users should not attempt to make such connections themselves, but should contact the appropriate electric inspection authority, or electrician, as appropriate.

**NOTES:** This equipment may not be used on coin service provided by the telephone company.

---

### 2.1 Power requirements

- This product requires an electrical supply of 120 volts AC. In case of power failure, the communication can be lost.
- The Electrical network is classified as hazardous. The only way to power down the charger is to unplug the power supply from the electrical outlet. Ensure that the electrical outlet is always easily accessible.
- The voltage on the network is classified as TNV-3 (Telecommunication Network Voltages), as defined in the standard UL 60950.

#### **Warning**

To avoid damage or malfunction:

- Do not allow the charging contacts or the battery to come into contact with metal objects.
- Do not open it as you could be exposed to high voltages.
- Do not allow the charger to come into contact with liquids.
- Never use any other battery than the one delivered with the product or recommended by Philips: risk of explosion.
- Always use the cables provided with the product.
- Handsfree activation could suddenly increase the volume in the earpiece to a very high level: make sure the handset is not too close to your ear.
- This equipment is not designed to make emergency calls when the power fails. An alternative has to be made available to allow emergency calls.



- Do not expose the phone to excessive heat caused by heating equipment or direct sunlight.
- Do not drop your phone or allow objects to fall on your phone.
- Do not use any cleaning agents containing alcohol, ammonia, benzene, or abrasives as these may harm the set.
- Do not use the product in places where there are explosive hazards.
- Do not let small metal objects come into contact with the product. This can deteriorate audio quality and damage the product.
- Active mobile phones in the vicinity may cause interference.

About operating and storage temperatures:

- Operate in a place where temperature is always between 0 and 35° C (32 to 95° F).
- Store in a place where temperature is always between -20 and 45° C (-4 to 113° F).
- Battery life may be shortened in low temperature conditions.

---

## 2.2 Conformity

We, Philips declare that the product is in compliance with the essential requirements and other relevant provisions of Directive 1999/5/EC. This product can only be connected to the analogue telephone networks of the countries mentioned on the packaging. You can find the Declaration of Conformity on [www.p4c.philips.com](http://www.p4c.philips.com).

---

## 2.3 Electric, Magnetic and Electromagnetic Fields ("EMF")

1. Philips Royal Electronics manufactures and sells many consumer oriented products which usually, as with any electronic apparatus, have the ability to emit and receive electro magnetic signals.
2. One of Philips' leading Business Principles is to take all necessary health and safety precautions for our products, to comply with all applicable legal requirements and to stay well within the EMF standards applicable at the time of producing the products.
3. Philips is committed to develop, produce and market products that cause no adverse health effects.
4. Philips confirms that if its products are handled properly for their intended use, they are safe to use according to scientific evidence available today.
5. Philips plays an active role in the development of international EMF and safety standards, enabling Philips to anticipate further developments in standardisation for early integration in its products.

---

## 2.4 Recycle your batteries

Do not dispose your rechargeable batteries. Call the toll free number 1-800-822-8837 to get instructions on how to recycle your batteries.



The RBRC<sup>®</sup> Seal on the nickel metal hydride battery indicates that Philips Royal Electronics is voluntarily

participating in an industry program to collect and recycle these batteries at the end of their useful lives, when taken out of service within the United States and Canada.

The RBRC<sup>®</sup> program provides a convenient alternative to placing used nickel metal hydride batteries into the trash or municipal waste, which may be illegal in your area.

Philips's participation in RBRC<sup>®</sup> makes it easy for you to drop off the spent battery at local retailers participating in the RBRC<sup>®</sup> program or at authorized Philips product service centers.

Please call 1-800-8-BATTERY for information on Ni-MH battery recycling and disposal bans/restrictions in your area. Philips's involvement in this program is part of its commitment to protecting our environment and conserving natural resources.

RBRC<sup>®</sup> is a registered trademark of Rechargeable Battery Recycling Corporation.

---

## 2.5 Service Centers

US service center

Philips Accessories & Computer Peripherals North America  
1881 Route 46 WestLedgeWood, NJ 07852

Phone: (800) 233-8413

E-mail support:

<http://www.support.philips.com/support>

---

## 3 Your phone

Congratulations on your purchase and welcome to Philips!

To fully benefit from the support that Philips offers, register your product at [www.philips.com/welcome](http://www.philips.com/welcome).

---

### 3.1 What's in the box



**Handset**



**Base station with  
bracket**



**Battery door**



**Belt clip**



**2 AAA rechargeable  
NiMH batteries**



**Power supply**



**Line cord\***



**User manual**



**Guarantee**



**Quick start  
guide**

#### **Note**

\*You may find in the box the line adaptor delivered separately from the line cable. **In this case, you have to connect the line adaptor to the line cord first before plugging the line cord to the line socket.**

In multihandset packs, you will find one or more additional handsets, chargers with power supply units and additional rechargeable batteries.

## 3.2 Overview of your phone

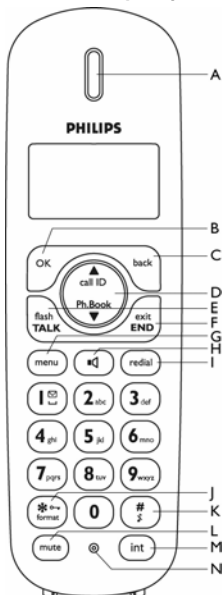

### A Earpiece

### B OK key

During a call: Access the Call menu  
In other modes: Select the function displayed on the handset screen directly above it.

### C Back/Clear key

In text or number editing mode: Short press to delete one digit/character. *Long press* to delete all digits/characters.  
In other modes: Select the function displayed on the handset screen directly above it.

### D Navigation keys

In idle mode: Scroll up to access the Call log and scroll down to access the Phonebook.  
During a call: Scroll up/down to increase or decrease earpiece and loudspeaker volume.  
In other modes: Scroll up/down a menu list or go to the previous or next record.

### E Talk key

In idle mode: Answer an incoming external or internal call.  
During a call: Activate the recall function.  
In phonebook/call log/redial list reviewing mode: Dial the selected number.

### F Hang-up/Exit key

In idle mode: *Long press* to switch on/off the handset.  
During a call: Hang up a call.  
In other modes: Short or *long press* to return to idle mode.

### G Menu key

In idle mode: Access the main menu.

### H Loudspeaker key

In idle mode: Turn on the loudspeaker and dial the number. Answer an incoming call using handsfree mode.  
During a call: Toggle the loudspeaker on/off.

In phonebook/call log/dial list reviewing mode: Dial the selected number using handsfree mode.

### I Redial key

In idle mode: Access the Redial list.  
In direct dialing mode: Dial the last dialed number.

### J Keypad lock/format key

In idle mode: Insert \*. *Long press* to lock/unlock keypad.

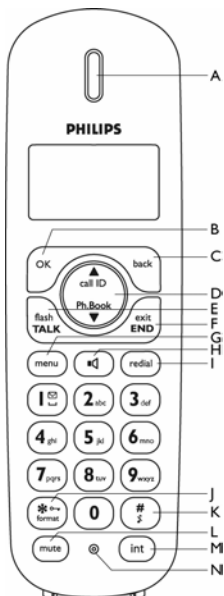

During a call: Switch from pulse dialing to tone dialing.

In call log reviewing mode: Press repeatedly to view the alternate dialing sequences.

**K Ringer off key** (#)

In idle mode: Insert #. *Long press* to turn the ringer on/off.

During a call: Insert #. *Long press* to insert a pause.

In text editing mode: Switch between upper and lower case. *Long press* to insert a pause.

**L Mute key** (mute)

During a call: Mute/unmute the handset microphone.

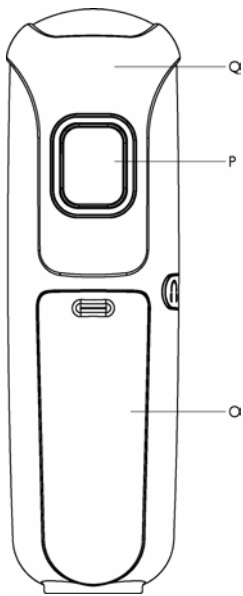

**M Call transfer/Intercom key** (int)

In idle mode: Initiate an internal call.

During a call: Hold the line and page another handset or toggle between an external and internal call. *Long press* to initiate a conference call.

**N Microphone**

**O Battery door**

**P Loudspeaker**

**Warning**

Handsfree activation can suddenly increase the volume in the earpiece to a very high level. Make sure the handset is not too close to your ear.

**Q Belt clip**

### 3.3 Display icons

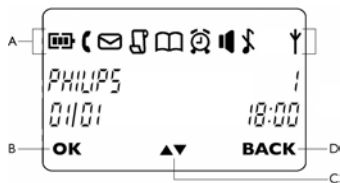

#### A Status bar



Indicates battery is fully charged.



Indicates battery is fully discharged.



Indicates that an external call is connected or held. Icon blinks when receiving an incoming call.



Indicates new voice messages received. Icon blinks when there are unread messages.



Displays when the call log is accessed. Icon blinks when there are new missed calls.



Displays when the phonebook is accessed.



Displays when the alarm clock is activated.



Displays when the loudspeaker is activated.



Displays when ringer off is activated.



Indicates that the handset is registered and within range of the base station. Icon blinks when the handset is out of range or is searching for a base.

#### B OK key

Displays when in menu mode to confirm your selection.

#### C ▲▼ key

Indicates that more options are available. Use the navigation keys to scroll up/down. Increase ▲ or Decrease ▼ earpiece or loudspeaker volume during a call.

#### D BACK key

Displays when in menu mode. Select **BACK** to return to the previous menu level. Select **BACK** to delete the last digit/character entered.

### 3.4 Overview of the base station

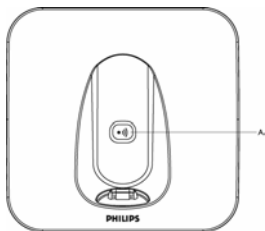

#### A Handset locator key

Page handset.

Long press to start registration procedure.

---

## 4 Getting started

---

### 4.1 Connect the base station

- 1 Place the base station in a central location near the telephone line socket and electricity socket.

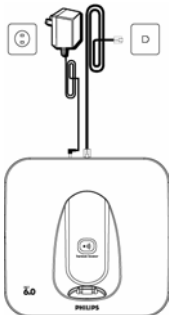

- 2 Connect the line cord and the power cable to their corresponding connectors at the back of the base station.

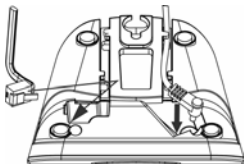

- 3 Connect the other end of the line cord and power cable to their respective sockets.

#### Note

The line adaptor may not be attached to the line cord. In this case, you have to connect

the line adaptor to the line cord first before plugging the line cord to the line socket.

#### Warning

Avoid placing the base station too close to large metal objects such as filing cabinets, radiators or electrical appliances. This can impair the range and sound quality. Buildings with thick internal and external walls may impair transmission of signals to and from the base.

#### Warning

The base station does not have an ON/OFF power switch. Power is applied when the power adaptor is plugged into the unit and connected to the electricity socket. The only way to power down the unit is to unplug the power adaptor from the electricity socket. Therefore, ensure that the electricity socket is easily accessible. The power adaptor and telephone line cord have to be connected correctly, as incorrect connection could damage the unit. Always use the telephone line cord supplied with the unit. Otherwise, you may not get a dial tone.

---

### 4.2 Wall mounting the base

The base is designed to support wall mounting. To wall mount the base, follow the instructions below.

#### Warning

Other wall mounting methods are not recommended and may damage the product.

- 1 Remove the bracket from the back of the base station by pressing down the two latches on the top of the bracket.



- 2 Turn the bracket around and re-insert the bracket to the back of the base station.

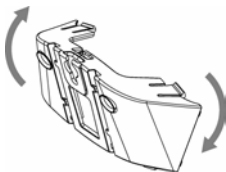

- 3 Slide the base down into place.



- 4 Use the pedestral wall mounting to plug your base station.



---

### 4.3 Install your phone

Before using the handset, the batteries have to be installed and fully charged.

---

#### 4.3.1 Install battery

##### **Warning**

Always use AAA rechargeable batteries supplied with your unit. There could be risk of battery leakage if you use alkaline batteries or other battery types.

- 1 Slide out the battery cover.



- 2 Place the batteries in the correct polarity as indicated and replace the cover.



---



#### 4.3.2 Charge battery

##### **Warning**

The handset must be charged for at least 24 hours before using it for the first time. When the battery level becomes low, the low battery sensor alerts you by sounding an audible tone and blinking the battery icon. If the battery level becomes exceedingly low, the phone automatically switches off shortly after the alert and any function in progress will not be saved.

- 1 Place the handset on the charging cradle of the base station. A beep is emitted if the handset is placed correctly.



- 2 The battery icon  on the display blinks during charge.
- 3 The battery icon  becomes steady when the handset is fully charged.

 **Note**

Optimal battery life is reached after 3 cycles of complete charging (over 15 hours) and discharging, allowing approximately 12 hours of talk-time and 150 hours of stand-by time.



The indoor and outdoor range of the phone is up to 50 metres and 300 metres respectively. When the handset moves beyond the operation range, the antenna icon  will blink.

 **Tip**

When reaching the range limit and the conversation becomes crackly, move closer to the base.

#### 4.4 Menu structure

The table below describes the menu tree of your phone.

Press  key to display the main menu. Use navigation keys  to navigate within the menus and press  key to enter each option.

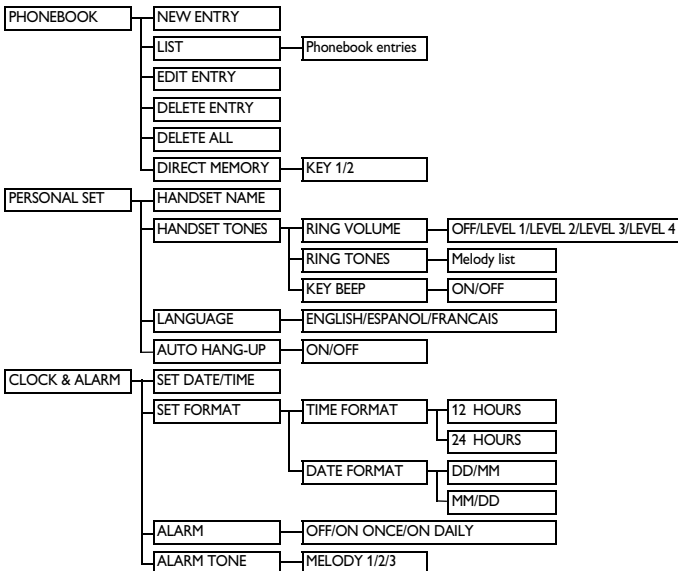

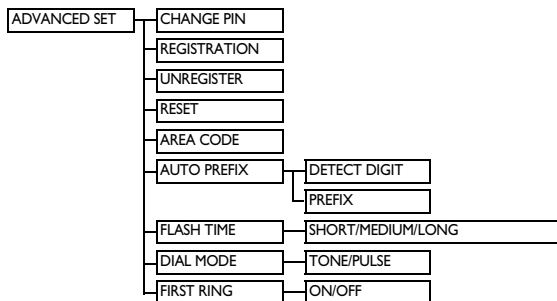

---

## 5 Using your phone

---

### 5.1 Make a call

---

#### 5.1.1 Predialling



- 1 Dial the number (maximum 24 digits).
- 2 Press  key.
  - The call is initiated.

#### \* Tip

You may insert a prefix number to the beginning of your predial number, see “Set Prefix” on chapter 9.6 for more information.



---

#### 5.1.2 Direct dialling

- 1 Press  or  key to take the line.
- 2 Dial the number.
  - The call is initiated.



---

#### 5.1.3 Call from redial list

- 1 Press  key in idle mode.
- 2 Scroll  to an entry in the redial list.
- 3 Press  key.
  - The call is initiated.



---

#### 5.1.4 Call from the phonebook

- 1 Press  in idle mode.
- 2 Scroll  to a phonebook entry.
- 3 Press  key.
  - The call is initiated.



#### \* Tip

Instead of scrolling  to browse the phonebook entries, you can press the numeric key corresponding to the first letter of the entry you wish to locate. For

example, pressing  will show the entries starting with A. Pressing  again will show the entries starting with B, etc...

---

#### 5.1.5 Call from the call log

- 1 Press  in idle mode.
- 2 Scroll  to an entry in the call log.
- 3 Press  key.
  - The call is initiated.





#### Note

You need to subscribe to Caller Line Identification service to be able to see the caller's number or name in the call log. (see “Access call list” on chapter 6.7.1)

---

#### 5.1.5.1 To choose the format for call log display

You must choose the correct format to dial the area code and number of the call log record chosen. The original incoming number from the call log will appear as a 7, 10 or 11-digit number. If it is a long distance call, the prefix digit 1 will automatically appear in front of the 10-digit local calls.



- 1 When viewing the call log, press  to change the format of the call log display as it should be dialed from your location. For example, if the call log entry appears as “234-567-8900”:
  - Press  once to display “1-234-567-8900”
  - Press  twice to display “567-8900”
  - Press  3 times to display “1-567-8900”
  - Press  4 times to display “1-234-567-8900” again.

**2** To dial the current displayed number, press  key.

- *The call is initiated.*

### **Note**

You need to subscribe to Caller Line Identification service to be able to see the caller's number or name in the call log (see "Access call list" on chapter 6.7.1). When saving the call list entry to phonebook, the original incoming number will be saved instead of the current displayed number.

If the first 3 digits of the incoming number corresponds to the local area code set in your phone, they will be filtered automatically when you press the  or  key to dial. To change the local area code, please refer to see "Set area code" on chapter 9.5.

---

## 5.2 Answer a call

### **Danger**

When the handset rings during an incoming call, please do not hold the handset too close to your ear as the volume of the ringing tone may damage your hearing. When the phone rings, press  key.

- *The call is established.*

### **Note**

Incoming call has priority over other events. Whenever there is an incoming call, other status in progress such as phone setting, menu navigation, etc will be aborted.

---

## 5.2.1 Handsfree answering

### **Danger**

Handsfree activation can suddenly increase the volume in the earpiece to a very high level. Make sure the handset is not too close to your ear.

When the phone rings, press  key.

- *The handset loudspeaker is activated.*

---

## 5.3 End a call

To end a conversation, press  key.

- *The call ends.*

### **Tip**

You can simply place the handset back to its base station to end the call (see "Activate/deactivate auto hang-up" on chapter 7.3). This feature is activated by default.

### **Note**

The call duration (HH-MM-SS) will be displayed on the handset screen. Press  **BACK** to return to idle mode.

## 6 Use more of your phone

### 6.1 Switch the handset on/off





Press and hold  key for more than 5 seconds to switch on/off the handset in idle mode.

### 6.2 Keypad lock/unlock







Press and hold  key for 1 second to lock/unlock the keypad in idle mode.





### 6.3 Text or number entry

When you select a field in which you can enter text, you can enter the letters that are printed on the keys by pressing the relevant key once or several times. For example, to enter the name "PAUL":

- 1 Press  once: P
- 2 Press  once: PA
- 3 Press  twice: PAU
- 4 Press  three times: PAUL

The table below gives you the character assignment during text or number entry:

Keys	Assigned characters
	space 1 _ < > *
	A B C 2
	D E F 3
	G H I 4
	J K L 5
	M N O 6
	P Q R S 7

	T U V 8 ?
	W X Y Z 9
	0 - / \ # +
	#
	*

### \* Tip

Press  **BACK** to delete the last digit or character entered.

### 6.4 Call in progress



Some options are available to you during a call. The available options are:

#### 6.4.1 Adjust earpiece volume

During a call, press  to select from **VOLUME 1** to **VOLUME 3**.

#### 6.4.2 Mute/unmute microphone



When the microphone is muted, your correspondent cannot hear you.

- 1 During a call, press  key to turn off the microphone.
- 2 Press  key again to turn on the microphone.

#### 6.4.3 Activate/deactivate loudspeaker mode

##### Danger

Handsfree activation can suddenly increase the volume in the earpiece to a very high level. Make sure the handset is not too close to your ear.

- 1 During a call, press  key to activate the loudspeaker mode.
- 2 Press  key again to return to normal mode.





#### 6.4.4 Adjust loudspeaker volume

During a call, press  to select from **VOLUME 1** to **VOLUME 5**.

#### 6.4.5 Call waiting

If you have subscribed to Call Waiting service, the earpiece will emit a beep tone to inform you that there is a second incoming call. The number or name of the second caller will also be displayed on your phone if you have subscribed to Caller Line Identification service (CLI). Please contact your network provider for more information on this service.

When you receive a second incoming call while on the phone, you can carry out the following operations:





 + 	Put the current call on hold and answer the second call.
 + 	End the current call and answer the second call.

The above operations may be different according to your network.

#### 6.5 Using your phonebook

Your phone can store up to 50 phonebook memories. Each phonebook entry can have a maximum of 24 digits for the phone number and 12 characters for name.

##### 6.5.1 Store a contact in the phonebook

- 1 Press  key in idle mode, scroll  to **PHONEBOOK** and press  **OK**. Press  **OK** again to enter **NEW ENTRY**.
- 2 **ENTER NAME** is displayed on the screen.
- 3 Enter the name of the contact (maximum 12 characters) and press  **OK**.

4 **ENTER NUMBER** is displayed on the screen.

- 5 Enter the number (maximum 24 digits) and press  **OK** to confirm.
  - A validation tone is emitted.

##### Note

Press  **BACK** to delete the last digit or character entered.

To return to idle mode, press  key.

##### \* Tip

You cannot store a new phonebook entry when the memory is full. In this case, you have to delete existing entries to make space for new entries.

##### 6.5.2 Access phonebook



- 1 Press  in idle mode to browse the phonebook entries.

Alternatively, you can press  key, scroll  to **PHONEBOOK** and press  **OK**, scroll  to **LIST** and press  **OK**.







- The phonebook entries will be listed in alphabetical order.

- 2 To view the details, press  **OK**.

##### \* Tip

Instead of scrolling  to browse the phonebook entries, you can press the numeric key corresponding to the first letter of the entry you wish to locate. For example, pressing  will show the entries starting with A. Pressing  again will show the entries starting with B, etc...

##### 6.5.3 Modify a phonebook entry

- 1 Press  key in idle mode, scroll  to **PHONEBOOK** and press  **OK**, scroll  to **EDIT ENTRY** and press  **OK**.
- 2 Scroll  to select an entry to edit.

- Press **OK** to display name. Edit the name and press **OK**.
- Edit the number and press **OK** to confirm.
  - A validation tone is emitted.

---

### 6.5.4 Delete a phonebook entry

- Press **menu** in idle mode, scroll to **PHONEBOOK** and press **OK**, scroll to **DELETE ENTRY** and press **OK**.
- Scroll to select an entry to delete and press **OK**.
- CONFIRM?** is displayed on the screen. Press **OK** again to confirm deletion.
  - A validation tone is emitted.

#### Note

Press **BACK** to discard change and the screen returns to phonebook list.

---

### 6.5.5 Delete the phonebook list

- Press **menu** key in idle mode, scroll to **PHONEBOOK** and press **OK**.
- Scroll to **DELETE ALL** and press **OK**.
- CONFIRM?** is displayed on the screen. Press **OK** again to confirm deletion.
  - A validation tone is emitted.

#### Note

Press **BACK** to discard change and the screen returns to phonebook list.

---

### 6.5.6 Direct access memory

There are 2 direct access memories (Keys **1** and **2**) included in the phonebook memory. A long press on the keys in idle mode will automatically dial the stored phone number.

---

### 6.5.6.1 Add/edit direct access memory

- Press **menu** key in idle mode, scroll to **PHONEBOOK** and press **OK**, scroll to **DIRECT MEMORY** and press **OK**.
- Scroll to **KEY 1** or **KEY 2** and press **OK**.
  - The stored number is displayed (if any).
- Press **menu** to enter direct memory menu.
- Scroll to select **EDIT** and press **OK**.
- ENTER NAME** is displayed on the screen.
- Enter the name of the contact (maximum 12 characters) and press **OK**.
- ENTER NUMBER** is displayed on the screen.
- Enter the number (maximum 24 digits) and press **OK** to confirm.
  - A validation tone is emitted.

---

### 6.5.6.2 Delete direct access memory

- Press **menu** key in idle mode, scroll to **PHONEBOOK** and press **OK**, scroll to **DIRECT MEMORY** and press **OK**.
- Scroll to **KEY 1** or **KEY 2** and press **OK**.
  - The stored number is displayed (if any).
- Press **menu** to enter direct memory menu.
- Scroll to **DELETE** and press **OK**.



- 5 CONFIRM?** is displayed on the screen. Press  **OK** to confirm deletion.
- A validation tone is emitted and the screen returns to previous menu.



---

## 6.6 Using the redial list

The redial list stores the last 5 numbers dialed. A maximum of 24 digits can be displayed for each entry.

---

### 6.6.1 Access redial list





- 1** Press  key to go to the redial list and scroll  to browse the redial list.
- The last number dialed will appear first in the redial list. If the redial number matches a phonebook entry, the name will be displayed instead.
- 2** To view the details, press  **OK** key.

#### Note

To return to idle mode, press  key.

---

### 6.6.2 Save a redial number into the phonebook







- 1** Press  key in idle mode to go to the redial list, scroll  to select an entry and press  **OK**. Press  again to enter **SAVE NUMBER**.
- 2** **ENTER NAME** is displayed on the screen.
- 3** Enter the name of the contact (maximum 12 characters) and press  **OK**.
- A validation tone is emitted. **SAVED!** is displayed for 2 seconds and the screen returns to redial list.

#### Note

Press  **BACK** to delete the last character entered.

---

### 6.6.3 Delete a redial number





- 1** Press  key in idle mode to go to the redial list, scroll  to select an entry and press  **menu**.
- 2** Scroll  to **DELETE** and press  **OK**.
- 3** **CONFIRM?** is displayed on the screen.
- Press  **OK** to confirm deletion.
- A validation tone is emitted and the screen returns to redial list.

#### Note

Press  **BACK** to discard change and the screen returns to redial list.

---

### 6.6.4 Delete the redial list

- 1** Press  key in idle mode to go to the redial list and press  **menu**, scroll to **DELETE ALL** and press  **OK**.
- 2** **CONFIRM?** is displayed on the screen. Press  **menu** to confirm deletion.
- A validation tone is emitted and the screen returns to redial list.

#### Note

Press  **BACK** to discard change and the screen returns to redial list.

---

## 6.7 Using the call log

The call log stores the last 10 external calls and any new voice mail received. If you have subscribed to Caller Line Identification (CLI), and provided the identity of the caller is not withheld, the name (or number) of the caller will be displayed.

#### Note

If the identity of the caller is withheld or the network does not provide the date and time information, then the information will not be displayed in the call log.

If you have not subscribed to Caller Line Identification service, there will not be any information displayed in the call log.

### 6.7.1 Access call list

- 1 Press in idle mode to browse the call list.
  - The calls (missed and received) are displayed in chronological order with the most recent call at the top of the list.
- 2 To view the details, press **OK**.
  - The call number is displayed. Press **OK** again to view more details.

### 6.7.2 Consulting the call list

The screen can either display :

- the caller's number\*
- the caller's name (if recorded in the phonebook)\*
- <UNKNOWN> if it is an unidentified call
- <WITHHELD> if it is a private call.
- <UNAVAILABLE> if it is a public or out of area call.

\* Subject to a subscription with your network operator.

#### **Note**

You can display the phone number, the time and the date of the call by pressing **OK**. The time and date displayed is dependent on the network.

### 6.7.3 Save call list entry into the phonebook

- 1 Press in idle mode, scroll to a call list entry and press .
- 2 Scroll to **SAVE NUMBER** and press **OK**.

3 **ENTER NAME** is displayed on the screen.

4 Enter the name of the contact (maximum 12 characters) and press **OK**.

- **SAVE !** is displayed for 2 seconds and the screen returns to call log.

#### **Note**

Press **BACK** to delete the last character entered.

### 6.7.4 Delete a call list entry

- 1 Press in idle mode, scroll to a call list entry and press .
- 2 Scroll to **DELETE** and press **OK** to confirm deletion.
- 3 **CONFIRM?** is displayed on the screen.  
Press **OK** to confirm deletion.
  - A validation tone is emitted and the screen returns to call log.

#### **Note**

Press **BACK** to discard change and the screen returns to call log.

### 6.7.5 Delete the call list

- 1 Press in idle mode, scroll to a call list entry and press .
- 2 Scroll to **DELETE ALL** and press **OK**.
- 3 **CONFIRM?** is displayed on the screen.  
Press **OK** again to confirm deletion.
  - A validation tone is emitted and the screen returns to call log.

#### **Note**

Press **BACK** to discard change and the screen returns to call log.

---

## 6.8 Using the intercom

### Warning

Intercom and call transfer is only possible with handsets registered to the same base station.



This feature is only available when there are at least 2 registered handsets. It allows you to make free internal calls, transfer external calls from one handset to another and use the conference option.

---

### 6.8.1 Intercom another handset



#### Note

If the handset does not belong to CD150/155 range, this function may not be available.

- 1 Press  key in idle mode.
  - *Intercom is established immediately if there are only 2 registered handsets.*
- 2 If there are more than 2 registered handsets, the handset numbers which are available for intercom will be displayed. Scroll  to select the specific handset number you wish to call and press  **OK** to start intercom.

---

### 6.8.2 Transfer an external call to another handset

- 1 During the call, press and hold  key to put the external call on hold (the caller can no longer hear you).
  - *Intercom is established immediately if there are only 2 registered handsets.*
- 2 If there are more than 2 registered handsets, the handset numbers which are available for intercom will be displayed. Scroll  to select the specific handset number you wish to call and press  **OK**.
  - *The called handset rings.*

- 3 Press  key on the called handset to answer the internal call, where both internal callers can talk.

- 4 Press  key on the first handset to transfer the external call to the called handset.
  - *The external call is transferred.*

#### Note

If there is no answer from the called handset, press  key to resume the external call.

---

### 6.8.3 Answer an external call during intercom

- 1 During intercom, a new call tone is emitted when there is an incoming external call.
- 2 Press  to answer the external call and end the intercom.
  - *Connection with the external call is established.*

#### Note

To put the internal call on hold and answer the incoming external call, press  key.

---







### 6.8.4 Switch between an internal and external call

During the call, long press  key to switch between an internal or external call.

---

### 6.8.5 Establish a three-party conference call

The conference call feature allows one external call to be shared with two handsets (in intercom). The three parties can share the conversation and no network subscription is required.

- 1 During the call, long press  key to put the external call on hold (the caller can no longer hear you).
- 2 If there are more than 2 registered handsets, the handset numbers which are available for intercom will be displayed. Scroll  to select the specific handset number you wish to call and press  **OK**.
- 3 Press  or  key on the called handset to answer the internal call, where both internal callers can talk.
  - *Intercom is established.*
- 4 Press and hold  key for 2 seconds on the first handset to start the three-party conference.
  - **CONFERENCE** will be displayed on the screen once the conference call is established.

 **Tip**

To establish intercom using handsfree mode, press  key again on the called handset to turn on speakerphone.

---

## 6.9 Handset locating

The paging feature enables you to locate a missing handset if the handset is in range and contains charged batteries.

- 1 Press  key on the base station.
  - *All the registered handsets start to ring.*
- 2 Once retrieved, press any key on the handset to end the handset locating.

 **Note**

If there are no key presses within 30 seconds, the handset and base station will automatically return to idle mode.

 **Tip**

Press  key on the base station again to stop handset locating.

---

## 7 Personal settings

---

### 7.1 Change the handset name

You can name the handset and display the handset name in idle mode. The default handset name of your handset is **PHILIPS**.

**1** Press  key in idle mode, scroll  to **PERSONAL SET** and press  **OK**, scroll  to **HANDSET NAME** and press  **OK**.

**2** The last stored name is displayed. Press  **BACK** key to delete the characters one by one.

**3** Enter the new name (maximum 10 characters) and press  **OK** to confirm.

- A validation tone is emitted and the screen returns to previous menu.

---





## 7.2 Handset Tones



### 7.2.1 Set the ring volume

#### Danger

When the handset rings during an incoming call, please do not hold the handset too close to your ear as the volume of the ringing tone may damage your hearing.

There are 5 ringer volume options (**OFF**, **LEVEL 1**, **LEVEL 2**, **LEVEL 3** and **LEVEL 4**). The default level is **LEVEL 2**.

**1** Press  key in idle mode, scroll  to **PERSONAL SET** and press  **OK**, press  **OK** to enter **HANDSET TONES** and press  **OK** again to enter **RING VOLUME**.

- 2** Scroll  to your desired volume level and press  **OK** to confirm.
- A validation tone is emitted and the screen returns to previous menu.







#### Note

When **RINGER OFF** is activated, the icon  will be displayed on the screen.

---

### 7.2.2 Set the tones melody

There are 10 ring melodies available on your handset.

**1** Press  key in idle mode, scroll  to **PERSONAL SET** and press  **OK**, press  **OK** to enter **HANDSET TONES**, scroll  to **RING TONES** and press  **OK**.







**2** Scroll  to your desired melody to play the melody.



- 3** Press  **OK** to set the ring melody.
- A validation tone is emitted and the screen returns to previous menu.

---

### 7.2.3 Activate/deactivate key tone

A single tone is emitted when a key is pressed. You can enable or disable the key tone. By default, the key tone is **ON**.

**1** Press  key in idle mode, scroll  to **PERSONAL SET** and press  **OK**, press  **OK** to enter **HANDSET TONES**, scroll  to **KEY BEEP** and press  **OK**.







**2** Scroll  to **ON** or **OFF** and press  **OK** to confirm.

- A validation tone is emitted and the screen returns to previous menu.

---

### 7.3 Change the display language

Your handset can support different display languages.

- 1 Press  key in idle mode, scroll  to **PERSONAL SET** and press  **OK**, scroll  to **LANGUAGE** and press  **OK**.
- 2 Scroll  to your desired language and press  **OK** to confirm.
  - A validation tone is emitted and the screen returns to previous menu.







#### \* Tip

Once the display language is set, the option menus on the handset will switch to display in the selected language immediately.

---

### 7.4 Activate/deactivate auto hang-up

This function enables you to end a call automatically by simply placing the handset on the base station. By default, the Auto Hang up feature is **ON**.

- 1 Press  key in idle mode, scroll  to **PERSONAL SET** and press  **OK**, scroll  to **AUTO HANG-UP** and press  **OK**.
- 2 Scroll  to **ON** or **OFF** and press  **OK** to confirm.
  - A validation tone is emitted and the screen returns to previous menu.







---

## 8 Clock and Alarm

This feature allows you to set the date, time and alarm settings for your phone. The default date and time is **2008/01/01** and **12:00 am** respectively.

---

### 8.1 Set date and time

- 1 Press  in idle mode, scroll  to **CLOCK & ALARM** and press  **OK**, press  **OK** to enter **SET DATE/TIME**.
- 2 The last stored date is displayed. Enter the current date (YYYY/MM/DD) and press  **OK**.
- 3 The last stored time is displayed. Enter the current time (HH:MM) and scroll  to select **am** or **pm**. Press  **OK** to confirm.
  - A validation tone is emitted.

#### Note

An error tone will be emitted if an invalid digit is entered in the date/time fields.  
Hour: 00 to 12; Minute: 00 to 59  
Date: 01 to 31; Month: 01 to 12

#### Warning

If your phone is connected to an ISDN line through an adaptor, the date & time may be updated after each call. The availability of date & time update is dependent on your network provider. Please check the date & time settings in your ISDN system or contact your network provider.









---

### 8.2 Set date/time format

You can set your preferred date/time format for your phone. The default format is **MM/DD** and **12 HOURS**.









---

#### 8.2.1 Set time format

- 1 Press  in idle mode, scroll  to **CLOCK & ALARM** and press  **OK**, scroll  to **SET FORMAT** and press  **OK**.
- 2 Press  **OK** to enter **TIME FORMAT**.
  - The current setting is displayed.
- 3 Scroll  to select time format display (**12 HOURS** or **24 HOURS**) and press  **OK** to confirm.
  - A validation tone is emitted and the screen returns to previous menu.

---

#### 8.2.2 Set date format



- 1 Press  in idle mode, scroll  to **CLOCK & ALARM** and press  **OK**, scroll  to **SET FORMAT** and press  **OK**.
- 2 Scroll  to enter **SET FORMAT** and press  **OK**.
  - The current setting is displayed.
- 3 Scroll  to select date format display (**DD/MM** or **MM/DD**) and press  **OK** to confirm.
  - A validation tone is emitted and the screen returns to previous menu.

---

### 8.3 Set alarm

- 1 Press  in idle mode, scroll  to **CLOCK & ALARM** and press  **OK**, scroll  to **ALARM** and press  **OK**.

**2** Scroll  to **OFF, ON ONCE** or **ON DAILY** and press  **OK**.

**3** If you select **ON ONCE** or **ON DAILY**, enter the time (HH:MM) for the alarm and scroll  to select **am** or **pm**. Press  **OK** to confirm.

- A validation tone is emitted and the screen returns to previous menu.



### **Note**

The alarm tone and alarm icon  will only sound/blink for 1 minute when the alarm time is reached. To mute the alarm tone, simply press any key on the handset.

---

## **8.4 Set alarm tone**

**1** Press  in idle mode, scroll  to **CLOCK & ALARM** and press  **OK**, scroll  to **ALARM TONE** and press  **OK**.

**2** Scroll  to **MELODY 1, MELODY 2** or **MELODY 3** and press  **OK** to confirm.

- A validation tone is emitted and the screen returns to previous menu.



---

## 9 Advanced settings







---

### 9.1 Change Master PIN

The default Master PIN number is 0000. The maximum length of the Master PIN is 8 digits. This PIN is also used to protect the settings of your handset. Your handset will prompt you whenever the PIN is required.

#### Note

The default pin code is preset to 0000. If you change this PIN code, keep the PIN details in a safe place where you have easy access to them. Do not lose the PIN code.

- 1 Press  key in idle mode, scroll  to **ADVANCED SET** and press  **OK**, scroll  to **CHANGE PIN** and press  **OK**.
- 2 Enter the Master PIN when prompted and press  **OK** to confirm.
  - *The PIN entered will be shown as asterisks (\*) on the screen.*
- 3 Enter the new PIN and press  **OK** to confirm.
  - *A validation tone is emitted and the screen returns to previous menu.*

#### Tip

If you forget your PIN, you will need to reset your phone to its default settings. See "Reset unit" on chapter 9.4 for more details.

---







### 9.2 Registration

The procedures described below are the procedures that you will find in your handset. The procedures may vary according to the handset you want to register. In this case, please refer to the manufacturer of the additional handset. Additional handsets must be registered to the base unit before you can use them. Up to 4 handsets can be registered to one base station.

- 1 Insert battery to power up the handset. The LCD displays "**PRESS OK KEY TO REGISTER**".
- 2 Press  **OK** on handset, the LCD displays "**HOLD LOCATOR KEY DURING 5s**".
- 3 Within 5 minutes, press the locator key on base station to start registration.
- 4 If registration succeeds, the handset returns to idle mode.
- 5 If registration fails, the LCD will display "**PRESS OK KEY TO REGISTER**". Repeat the process again.

---

### 9.3 Unregister

- 1 Press  key in idle mode, scroll  to **ADVANCED SET** and press  **OK**, scroll  to **UNREGISTER** and press  **OK**.
- 2 Scroll  to select the handset number to unregister and press  **OK**.
  - *A validation tone is emitted to indicate successful unregistration and the screen returns to idle mode.*

## Note

If no action is taken on the handset within 15 seconds, the unregistration procedure will be aborted and the handset returns to idle mode.

To unregister a handset that does not belong to the CD150/155 range, you can only use the CD150/155 handset to unregister it.

---

## 9.4 Reset unit







You can reset your phone to its default settings with this feature.

### Warning

Upon reset, all your personal settings, call log and redial list entries will be deleted and the phone will return to its default settings. However, your phonebook will remain unchanged after reset.

## Note

You may have to configure your phone once again.

- 1 Press  key in idle mode, scroll  to **ADVANCED SET** and press  **OK**, scroll  to **RESET** and press  **OK**.
- 2 **CONFIRM?** is displayed on the screen.
- 3 Press  **OK** again to confirm.
  - A validation tone is emitted.
  - The unit is reset to its default settings. (see “Default settings” on chapter 9.10)

---







## 9.5 Set area code

This feature is useful when you have subscribed to Caller Line Identification service. It allows you to set an area code in your CD150. Once the local area code

is set, the phone automatically filters the area code for all incoming calls, by removing the area code for local calls and retaining the area code for calls from other areas. If it is a local call, then only the phone number of the caller is displayed during an incoming call or when you call the number from the call log. If it is a long distance call, then both the area code and phone number will be displayed in a proper format to be dialed out directly from the call log, or saved into the phonebook.

## Note











You can enter a maximum of 3 digits for the area code. You need to subscribe to Caller Line Identification service to be able to see the caller's number or name in the call log. See “Using the call log” on chapter 6.7 for details.

- 1 Press  in idle mode, scroll  to **ADVANCED SET** and press  **OK**, scroll  to **AREA CODE** and press  **OK**.
- 2 Enter the local area code (maximum 3 digits) and press  **OK** to save.
  - A validation tone is emitted and the screen returns to previous menu.

---

## 9.6 Set prefix

This feature allows you to define a prefix number to be added to the beginning of a number during predialling (see “Predialling” on chapter 5.1.1). You may also use this feature to add a detect string to match and replace the first few digits of the number during predialling. You can enter up to a maximum of 5 digits for the detect string and auto prefix number respectively.

- 1 Press  key in idle mode, scroll  to **ADVANCED SET** and press  **OK**, scroll  to **AUTO PREFIX** and press  **OK**.
- 2 **DETECT DIGIT** is displayed on the screen. Press  **OK** to enter.
  - *The last stored detect string is displayed (if any).*
- 3 Enter a detect string number (maximum 5 digits) and press  **OK** to confirm.
  - *A validation tone is emitted and the screen returns to previous menu.*
- 4 Press  to scroll to **PREFIX**. Press  **OK** to enter.
  - *The last stored prefix number is displayed (if any).*
- 5 Enter the prefix number (maximum 10 digits) and press  **OK** to confirm.
  - *A validation tone is emitted and the screen returns to previous menu.*

### **Note**

If no detect string (blank) is entered, the prefix number will be automatically added to the predial number after  key is pressed.







For numbers starting with \*, # or P, the prefix number will not be added to the predial number after  key is pressed.

## 9.7 Change flash time

Flash time (or dial delay) is the time delay by which the line will be disconnected after you press  key. It can be set to short, medium or long.







The default value of flash time that is preset in your handset should be the best suited for your country network and therefore

you should not need to change it.

- 1 Press  key in idle mode, scroll  to **ADVANCED SET** and press  **OK**, scroll  to **FLASH TIME** and press  **OK**.
- 2 Scroll  to **SHORT, MEDIUM or LONG** and press  **OK** to confirm.
  - *A validation tone is emitted and the screen returns to previous menu.*







## 9.8 Change the dial mode

The default value for dial mode that is preset in your handset should be the best suited for your country network and therefore you should not need to change it. There are two dial modes: Tone or Pulse.

- 1 Press  key in idle mode, scroll  to **ADVANCED SET** and press  **OK**, scroll  to **DIAL MODE** and press  **OK**.
- 2 Scroll  to **TONE or PULSE** and press  **OK** to confirm.
  - *A validation tone is emitted and the screen returns to previous menu.*

## 9.9 Set first ring

When this function is set to Off, the first ring from a voice call will not sound. This is particularly useful in countries where calling line identity is sent after the first ring. Consequently, the phones in the house will not ring when a message arrives.

- 1 Press  in idle mode, scroll  to **ADVANCED SET** and press  **OK**, scroll to **FIRST RING** and press  **OK**.
- 2 Scroll  to **ON or OFF** and press  **OK** to confirm.
  - *A validation tone is emitted and the screen returns to previous menu.*

---

## 9.10 Default settings

Ringer Volume	LEVEL 2
Tone Melody	FLICK
Earpiece Volume	VOLUME 2
Key Tone	ON
Language	Country dependent
Auto Hang Up	ON
Handset Name	PHILIPS
Time/Date	2008/01/01; 12:00am
Time format	12 HOURS
Date format	MM/DD
Dialing Mode	Country dependent
Flash Time	Country dependent
First Ring	Country dependent
Master PIN	0000
Alarm	OFF
Alarm Tone	MELODY 1
Auto Prefix	EMPTY
Area Code	EMPTY

---

## 10 Technical data

---

### Display

- Progressive LCD backlight
- The backlight remains on for 15 seconds after each activation such as an incoming call, key presses, lifting the handset off the base station, etc.
- The colour of the LCD backlight is Amber.

### General telephone features

- Dual mode caller name & number identification
- 5 standard ringer melodies and 5 polyphonic ringer melodies

### Phonebook list, Redial list and Call log

- Phonebook list with 50 entries
- Redial list with 5 entries
- Call log with 10 entries

### Battery

- 2 x HR AAA NiMh 550 mAh batteries

### Power consumption

- Power consumption at idle mode: around 800mW

### Temperature range

- Operation: Between 0 and 35° C (32 to 95° F).
- Storage: Between -20 and 45° C (-4 to 113° F).

---

### Relative humidity

- Operation: Up to 95% at 40°C
- Storage: Up to 95% at 40°C

---

## 11 Frequently asked questions

[www.philips.com/support](http://www.philips.com/support)

---

In this chapter, you will find the most frequently asked questions and answers about your phone.

### Connection

#### The handset does not switch on!

- Charge the batteries: Put the handset on the base station to charge. After a few moments, the phone will switch on.

#### The handset does not charge!

- Check charger connections.

#### icon is not blinking during charge!

- Battery is full: There is no need to charge the battery.
- Bad battery contact: Adjust the handset slightly.
- Dirty contact: Clean the batteries contact with a cloth moistened with alcohol.

#### Communication is lost during a call!

- Charge the battery
- Move closer to the base station.

#### The phone is "Out of range"!

- Move closer to the base station.
- 

### Set-up

#### SEARCHING... is displayed on handset and icon is blinking!

- Move closer to the base station.
- Make sure that your base station is on.
- Reset your unit and restart handset registration.

### Sound

#### Handset does not ring!

Check that the **RING VOLUME** is not set to **RINGER OFF**, and make sure  icon is not displayed on the screen (see "Set the ring volume" on chapter 7.2.1).

#### Caller does not hear me!

Microphone may be muted: During a call, press .

#### There's no dialling tone!

- No power: Check the connections.
- Batteries are empty: Charge the batteries.
- Move closer to the base station.
- Wrong line cable used: Use the line cable provided.
- Line adaptor is required: Connect the line adaptor to the line cord.

#### Caller does not hear me clearly!

- Move closer to the base station.
- Move the base station at least one metre away from any electronic appliances.

#### Frequent noise interference on my radio or television!

- Move the base station as far away as possible from the electrical appliances.

### **I cannot change the settings of my voice mail**

- Operator voice mail is managed by your operator and not the phone itself. Please contact your operator should you want to change the settings.

---

### **Product behaviour**

#### **Keypad does not work!**

- Unlock your keypad: *Long press*  in idle mode.

#### **The handset warms up when making a long call!**

- This is a normal behavior. The handset consumes energy while calling.

#### **The handset cannot be registered to the base station!**

- Maximum number of handsets (4) has been reached. To register a new handset, unregister an existing handset.
- Remove and replace the handset batteries.
- Try again by disconnecting and connecting the base station power supply and follow the procedure to register a handset (see “Registration” on chapter 9.2).

#### **Caller number is not displayed!**

- Service is not activated: Check your subscription with your network operator.

#### **My handset keeps going into idle mode!**

- If there are no key presses for 15 seconds, the handset will automatically return to idle mode. It will also return to

idle mode automatically when you place the handset back on the base station.

#### **Phonebook entry cannot be stored and MEMORY FULL is displayed!**

- Delete an entry to free memory before saving your contact again.

#### **The Master PIN code is wrong!**

- The default master PIN is 0000.
- Reset the handset to revert to the default master PIN code if it has been changed before (see “Reset unit” on chapter 9.4).

---

## 12 Index

---

### **A**

Accessories 9  
Alarm 29  
Alarm tone 30  
Answer a call 19  
Answer an external call 25  
Auto hang-up 28

### **C**

Call in progress 20  
Call log 18, 23  
Charge battery 14  
Clock and alarm 29  
Conference call 25  
Connect base station 13

### **D**

Date and time 29  
Default settings 34  
Delete a call list entry 24  
Delete a redial number 23  
Delete call list 24  
Delete phonebook 22  
Delete redial list 23  
Dial mode 33  
Direct dialling 18  
Display icons 12

### **E**

End a call 19

### **H**

Handset locating 26  
Handset name 27  
Handset tones 27  
Handsfree answering 19

### **I**

Install battery 14  
Install phone 13  
Intercom 25

### **K**

Key tone 27  
Keypad lock/unlock 20

### **L**

Language 28  
LCD Backlight 35  
LED indicator 12  
Loudspeaker mode 20  
Loudspeaker volume 21

### **M**

Make a call 18  
Master PIN 31  
Menu structure 16  
Mute 20

### **O**

Overview of the base station 12  
Overview of your phone 10

### **P**

Phonebook 18, 21  
Predialling 18  
Prefix 32

### **R**

Recall time 33  
Recycle your batteries 7  
Redial list 18, 23  
Registration 31  
Reset unit 32  
Ring volume 27



**S**

- Save a redial number 23
- Set area code 32
- Store a contact 21
- Switch handset on/off 20

**T**

- Text or number entry 20
- Tones Melody 27
- Transfer an external call 25

**U**

- Unmute 20
- Unregister 31

**V**

- Volume 20





© 2008 Koninklijke Philips Electronics N.V.

All rights reserved

Reproduction in whole or in part is prohibited without the written consent of the copyright owner

Document number: 3111 285 42031



Printed in China

## Free Manuals Download Website

<http://myh66.com>

<http://usermanuals.us>

<http://www.somanuals.com>

<http://www.4manuals.cc>

<http://www.manual-lib.com>

<http://www.404manual.com>

<http://www.luxmanual.com>

<http://aubethermostatmanual.com>

Golf course search by state

<http://golfingnear.com>

Email search by domain

<http://emailbydomain.com>

Auto manuals search

<http://auto.somanuals.com>

TV manuals search

<http://tv.somanuals.com>