

Always there to help you

Register your product and get support at
www.philips.com/welcome

MT3120



User manual

PHILIPS

Contents

1	Important safety instructions	3		
2	Your handsfree phone	4		
	What is in the box	4		
	Overview of the phone	4		
	Main menu icons	4		
	Display icons	5		
3	Get started	6		
	Fix the lanyard to the phone	6		
	Wear the phone	6		
	Switch on the handsfree phone	6		
	Configure your phone (country dependent)	7		
	Set the country/language	7		
	Register your phone	7		
	Set the date and time	8		
	Charge the phone	8		
	Check the battery level	8		
	Standby mode	9		
	Check the signal strength	9		
4	Calls	10		
	Make a call	10		
	Make an external call	10		
	End a call	10		
	Answer a call	10		
	Silence the ringer for an incoming call	11		
	Adjust the speaker volume	11		
	Mute the microphone	11		
	Headphones mode	11		
5	Text and numbers	12		
	Enter text and numbers	12		
	Switch between the upper case and lower case	12		
6	Phonebook	13		
	View the phonebook	13		
	Add a record	13		
	Call from the phonebook	13		
	Edit a record	13		
	Delete a record	14		
	Delete all records	14		
7	Call log	15		
	Save a missed call number to the phonebook	15		
	Return a call	15		
	Delete a call record	16		
	Delete all call records	16		
8	Settings	17		
	Phone	17		
	Set the handset's ringtone volume	17		
	Set the handset's ringtone	17		
	Hang up confirmation	17		
	Silent mode	17		
	Set the key tone	18		
	Set the date and time	18		
	Auto lock	18		
	Set the display language	18		
	Set backlight of the LCD screen	18		
	Calibration	18		
	Alarm	19		
	Set the alarm	19		
	Turn off the alarm	19		
	Services	19		
	Call list type	19		
	ECO mode	19		
	Register your phone	20		
	Restore default settings	20		
9	Technical data	21		
10	Notice	22		
	Declaration of conformity	22		
	GAP standard	22		
	Compliance with EMF	22		
	Remove the integrated battery	23		
11	Frequently asked questions	24		

12 Appendix	25
Text and number input tables	25

1 Important safety instructions

Power requirements

The voltage on the network is classified as TNV-3 (Telecommunication Network Voltages), as defined in the standard EN 60950.

Warning

- The electrical network is classified as hazardous. The only way to power down the charger is to unplug the power supply from the electrical outlet. Ensure that the electrical outlet is always easily accessible.

To avoid damage or malfunction

Caution

- Use only the power supply listed in the user instructions.
- Risk of explosion if battery is replaced by an incorrect type.
- The battery is not designed to be replaced.
- Dispose of used batteries according to the instructions.
- Do not open the phone as you could be exposed to high voltages.
- Do not let small metal objects come into contact with the product. This can deteriorate audio quality and damage the product.
- Metallic objects may be retained if placed near or on the handset receiver.
- Do not use the product in places where there are explosive hazards.
- For pluggable equipment, the socket-outlet shall be installed near the equipment and shall be easily accessible.

- This is a handsfree product with high speaker volume. Make sure the product is not too close to your ear.
- This equipment is not designed to make emergency calls when the power fails. An alternative has to be made available to allow emergency calls.
- Do not allow the product to come into contact with liquids.
- Do not expose the phone to excessive heat caused by heating equipment or direct sunlight.
- Do not use any cleaning agents containing alcohol, ammonia, benzene, or abrasives as these may harm the set.
- Do not drop your phone or allow objects to fall on your phone.
- Do not let children play with the lanyard.
- Use the clip and lanyard together to avoid dropping the phone to the floor.
- Active mobile phones in the vicinity may cause interference.
- The full functionality of the phone can only be guaranteed when it is registered with a GAP compatible base station.

About operating and storage temperatures

- Operate in a place where temperature is always between 0°C to +40°C (up to 90% relative humidity).
- Store in a place where temperature is always between -20°C and +45°C (up to 95% relative humidity).
- Battery life may be shorter in low temperature conditions.

2 Your handsfree phone

Congratulations on your purchase! Your handsfree phone is designed to free your hands during phone calls and offer excellent voice quality through its built-in loudspeaker and microphone.

To fully benefit from the support that Philips offers, register your product at www.philips.com/welcome.



Guarantee



Quick start guide

What is in the box

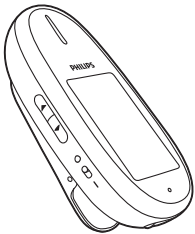

Phone with clip



Lanyard

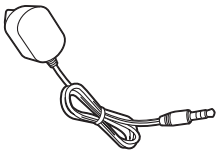

Adapter for battery charging



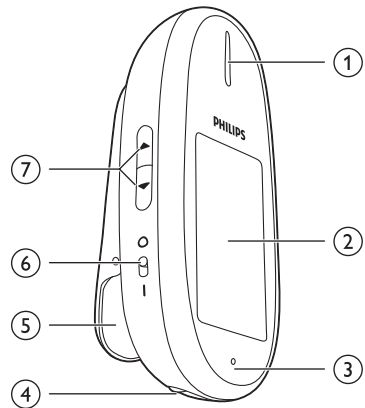

Overview of the phone



- ① Loud speaker
- ② Touch sensitive LCD screen
- ③ Microphone
- ④ Charging jack/Headphone jack (Headsets with mic are not supported.)
- ⑤ Clip
- ⑥ On and off switch
- ⑦ ▲ / ▼
 - Scroll through a list.
 - Increase or decrease the volume.









Main menu icons







The following is an overview of the menu options that are available on your handsfree phone. For detailed explanation of the menu options, see the corresponding sections in this user manual.

Icon	Descriptions
	[Call] - Make or pick up a call.
	[Settings] - Customize the settings for the phone, alarm and services.
	[Phonebook] - add, edit, view and delete phonebook entries etc.
	[Call log] - Displays the call history of all missed, dialed or received calls.

Display icons

In standby mode, the icons shown on the main screen tell you what features are available on your handset.

Icon	Descriptions
	Indicates the battery level (from full to low).
	When the handset is charging, the bars keep scrolling until the battery is fully charged or you unplug the adapter from the phone.
	The empty battery icon flashes and you hear an alert tone. The battery is low and needs recharging.
	Displays the link status between the handset and base station. The more bars are shown, the better the signal strength is.
	Indicates an incoming call in the call log.
	Indicates an outgoing call in the call log.
	Indicates an unread missed call in the call log.
	Indicates a read missed call in the call log.

	Indicates you are in a call.
	Displayed when you browse the phonebook.
	The alarm clock is activated.
	The ringer is off.
	The headphone is plugged into the phone.
	The silent mode is activated.

3 Get started

! Caution

- Make sure that you have read the safety instructions in the "Important safety instruction" section before you connect and install your handset.
- A lanyard is provided together with the phone. You are recommended to use the lanyard and the clip together to prevent the phone from dropping.
- The phone works with any base station compliant to the GAP standard. For information on the GAP standard, see the chapter 'Notice'.
- This product is a DECT phone accessory that requires a GAP compliant DECT base station for access to the landline.

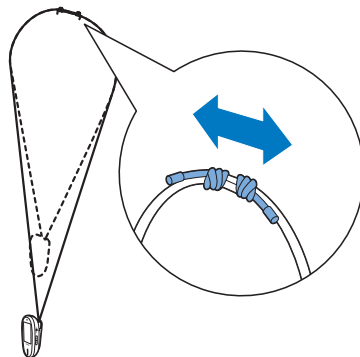

Fix the lanyard to the phone

Attach the lanyard as shown below:

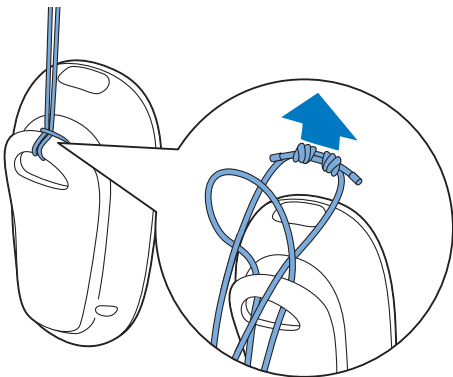

You can lengthen or shorten the lanyard by adjusting the distance between two knots.

Wear the phone

Clip the phone to your collar or wear it around your neck.

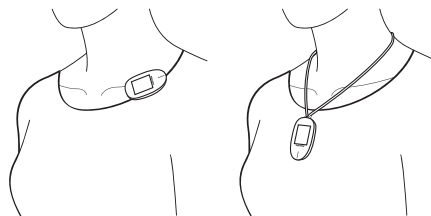

Switch on the handsfree phone

Switch on the handsfree phone as shown below:

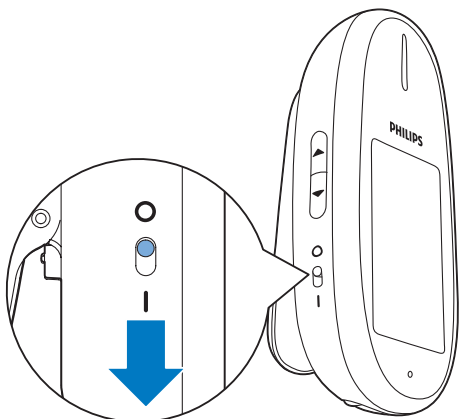

Note

- During normal use, it is not necessary to switch off the phone at any time. Switch the phone off only during extended period of non-use. In this case, time and date settings will be lost.

Configure your phone (country dependent)

When using your phone for the first time it will prompt you for initial setup information.

Set the country/language

Select your country/language, then tap ✓ to confirm.

↳ The country/language setting is saved.

Note

- The country/language setting option is country dependent. If no welcome message is displayed, it means the country/language setting is preset for your country. Then you can set the date and time.
- You can re-set the language later (see 'Set the display language' on page 18).

Register your phone

Your phone automatically asks you to register the phone with your original cordless phone's base station when you turn it on for the first time. If you skipped this step, refer to steps 1-3 below, otherwise continue after step 3.

- 1 Tap to access the main menu screen.
- 2 Select > [Services] > [Register], then tap ✓ to confirm.
- 3 Press the paging button on your original cordless phone's base station for approximately 10 seconds to set the base station of your phone to registration mode.

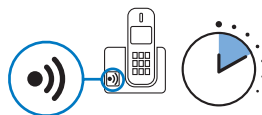

Note

- Check in the user manual of your base station on how to enter the registration mode. For most base stations, this can be achieved by pressing the paging button for 5-10 seconds until you hear a confirmation signal.
- The phone tries to connect to the base station with a series of standard passcodes automatically.
- A successful registration is indicated by a sound signal in less than 30 seconds.
- If your base station uses the passcodes/PIN different from the most common settings (e.g. 3456), you have to enter this PIN/passcode manually by following steps 4 to 6.
- If you use a pin code with more than 4 digits, it cannot be entered through the handsfree phone. In this case, change your base stations pin code to a 4-digit pin code (e.g.0000) and then resume the registration process.

- 4 If your base station's passcode/PIN is not auto-recognized, enter the base station's passcode/PIN.
- 5 Select to make corrections.
- 6 Tap ✓ to confirm the passcodes/PIN.
 - ↳ When you see a confirmation message, registration is complete.

Note

- You can find the passcodes/PIN in the manual of your original cordless phone with base (unless you changed the standard PIN code).
- This phone is only able to connect to a base station with the correct passcodes/PIN.
- If the passcodes/PIN is incorrect or no base is found within a certain period, your handset displays a notification message. Repeat the above procedure if registration fails.

Set the date and time

Tip

- To set the date and time later, tap ↶ to skip this setting.

Your phone automatically asks you to set date & time when you turn it on the first time. If you need to change the date and time, refer to the steps below.

Set the date

- 1 Tap ⬆ to access the main menu screen.
- 2 Select ☰ > [Phone] > [Date & time] > [Set date], then tap ✓ to confirm.
- 3 Tap ▲ / ▼ once or several times to enter the date, then tap ✓ to confirm.

Set the time

- 1 Tap ⬆ to access the main menu screen.
- 2 Select ☰ > [Phone] > [Date & time] > [Set time], then tap ✓ to confirm.
- 3 Tap ▲ / ▼ once or several times to enter the date, then tap ✓ to confirm.

Set the date format

- 1 Tap ⬆ to access the main menu screen.
- 2 Select ☰ > [Phone] > [Date & time] > [Date format], then tap ✓ to confirm.
- 3 Tap to select a date format, then tap ✓ to confirm.

Set the time format

- 1 Tap ⬆ to access the main menu screen.
- 2 Select ☰ > [Phone] > [Date & time] > [Time format], then tap ✓ to confirm.

- 3 Tap to select a time format, then tap ✓ to confirm.

Charge the phone

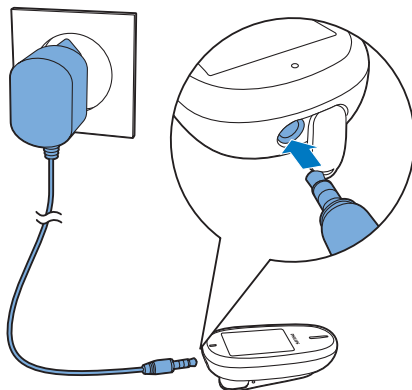

Plug the charging adapter into the headset/charging jack at the bottom of the phone.

↳ The handset starts charging.



Note

- Make sure that you switch on the phone for charging, it only charges when switched on.
- Before first use, charge the battery until the display indicator shows a full charge.
- The phone might get warm while the batteries are charging. This is normal.
- If your phone's battery has depleted completely after long periods of non-use, it may take up to 20 minutes for the phone to recharge until it powers up.

Your phone is now ready to use.

Check the battery level

The battery icon displays the current battery level.



	Indicates the battery level (from full to low).
	When the handset is charging, the bars keep scrolling until the battery is fully charged or you unplug the adapter from the phone.
	The empty battery icon flashes. The battery is low and needs recharging.

If you are on the phone, you hear warning tones when the battery is almost empty. You can plug in the charger to continue the call. The phone turns off after approximately 15 minutes when the battery is completely empty.

Standby mode

Your phone is in standby mode when it is idle. In standby mode, the phone's charge lasts about a week. If the auto lock has been set, you see a key icon on the idle screen. You need to press the icon to activate the phone. The auto lock feature is automatically disabled during an incoming call.

Check the signal strength

	Indicates the link status between the handset and base station. The more bars are shown, the better the connection is.
	
	

- Make sure the handset is registered to the base station before you make or receive calls.
- If you hear warning tones when you are on the phone, the handset is almost out of battery or the handset is out of range. Charge the battery or move the handset nearer to the base station.

4 Calls

Note

- When the power fails, the phone cannot access emergency services.
- This is a handsfree phone. Make sure you keep an optimal distance (15cm-1m) between your mouth, ears and your phone. Do not hold your phone close to your ears.



Make a call

You can make a call in these ways:

- Make an external call
- Call from the phonebook list
- Call from the call log

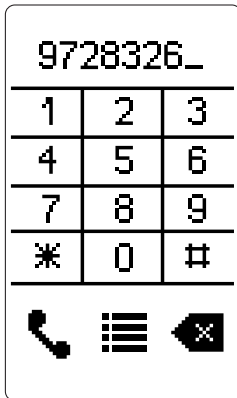
Make an external call



- 1 Tap  from the idle screen or main menu screen.
↳ The keypad appears.
- 2 Dial the phone number; then tap .
↳ The number is dialed out.
↳ The duration of your current call is displayed.

Note

- The call timer displays the talk time of your current call.

Note

- If you hear warning tones, the phone is almost out of battery or out of range. Charge the battery or move the phone close to the base station.

End a call

Tap .

Note

- The phone will ask for confirmation to hang up to avoid accidental call termination. This confirmation can be deactivated in the phone settings menu.

Answer a call

When the phone rings, tap  to answer the call.

Warning

- Always keep the phone away from your ear to avoid ear damage.

Note

- The caller ID service is available if you have registered to the caller ID service with your service provider.
- Whether or not the caller ID service is finally available varies with different base stations.

Tip



- When there is a missed call, the phone displays a notification message.

Silence the ringer for an incoming call

When the phone rings, tap .



You can turn the ringer off permanently or for specific time periods.

Adjust the speaker volume

Press  /  on the left side of the phone to adjust the volume during a call.

- ↳ The speaker volume is adjusted and the phone is back to the call screen.

Mute the microphone

- 1 Tap  during a call.
 - ↳ The handset displays **[Mute on]**.
 - ↳ The caller cannot hear you, but you can still hear his voice.
- 2 Tap  again to unmute the microphone.
 - ↳ You can now communicate with the caller.



Headphones mode

You can plug in any standard headphones (e.g. Philips SHE7000) into the phone to listen in greater privacy. The headphone jack is the same jack as the charging jack. Headsets with mic are not supported.

5 Text and numbers

You can enter text and numbers for phonebook records and other menu items.

Enter text and numbers

- 1 Tap on the keypad to enter the character and numbers.
- 2 Select  to delete the character.
- 3 Press  to add a space.

Switch between the upper case and lower case

By default, the first letter of each word in a sentence is upper case and the rest is lower case. Tap **Aa** to switch between the upper case and lower case letters during editing.

6 Phonebook

This phone has a phonebook that stores up to 20 records. You can access the phonebook from the handset. Each record can have a name up to 14 characters long and a number up to 24 digits long.

View the phonebook

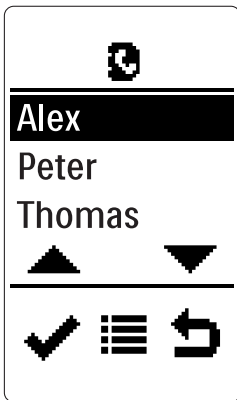

- 1 Tap to access the main menu screen.
- 2 Tap to access the phonebook list.
- 3 Tap on a phonebook entry.
↳ The phonebook entry is highlighted.
- 4 Select > [View], then tap to display the information.

Tip

- Tap or to scroll up or down.

Add a record

Note

- If your phonebook memory is full, the phone displays a notification message. Delete some records to add new ones.

- 1 Tap to access the main menu screen.
- 2 Tap to access the phonebook list.
- 3 Select to access the option menu.
- 4 Select [Add new], then tap to confirm.
- 5 Enter the name, then tap to confirm.
- 6 Enter the number; then tap to save.
↳ Your new record is saved.

Tip

- Press and hold # to insert a pause if you need to store the access number or country code.

Call from the phonebook





- 1 Tap to access the main menu screen.
- 2 Tap to access the phonebook list.
- 3 Tap on a phonebook entry to highlight it.
- 4 Tap on the phonebook entry again to make the call.

Tip



- Tap or to scroll up or down.

Edit a record



- 1 Tap to access the main menu screen.
- 2 Tap to access the phonebook list.
- 3 Tap on a phonebook entry.

- ↳ The phonebook entry is highlighted.
- 4 Select  > **[Edit]**, then tap  to confirm.
 - 5 Edit the name, then tap  to confirm.
 - 6 Edit the number; then tap  to save.
↳ The record is saved.

Tip

- Tap  or  to scroll up or down.
- The new phonebook entry overwrites the old one.





Tip

- Tap  or  to scroll up or down.

Note

- Changes to the phonebook on your handsfree phone does not impact the phonebook on other DECT phones you are using.





Delete a record

- 1 Tap  to access the main menu screen.
- 2 Tap  to access the phonebook list.
- 3 Tap on a phonebook entry.
↳ The phonebook entry is highlighted.
- 4 Select  > **[Delete]**, then tap  to confirm.
↳ The record is deleted.

Tip

- Tap  or  to scroll up or down.

Delete all records

- 1 Tap  to access the main menu screen.
- 2 Tap  to access the phonebook list.
- 3 Select  > **[Delete all]**, then tap  to confirm.
↳ The handset displays a confirmation request.
- 4 Tap  to confirm.
↳ All records are deleted.

7 Call log

The call log stores the call history of all missed, received or dialed calls. The call history includes up to 30 entries with the name and number of the caller; call time and date. This feature is available if you have registered for the caller ID service with your service provider. If the caller allows the display of his identity, you can view his name or number. The call records are displayed in chronological order with the most recent received call at the top of the list.

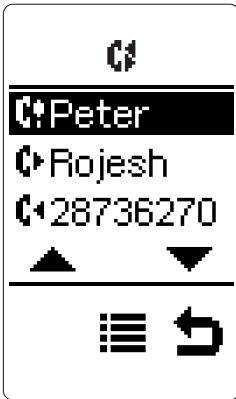

Note

- Make sure the number in the call list is valid before you can call back directly from the call list.

The following icons shown on the screen inform you if you have incoming, outgoing and missed calls.

- Indicates an incoming call in the call log.
- Indicates an outgoing call in the call log.
- Indicates the unread missed call in the call log.
- Indicates the read missed call in the call log.

Note

- If you pick up a call on your original phone but not the handsfree phone, it will appear as a missed call on the handsfree phone.

Save a missed call number to the phonebook

- 1 Tap from the idle screen or main menu.
↳ The call log is displayed.
- 2 Select a record, then tap to access the option menu.
- 3 Select **[Save number]**, then tap to confirm.
- 4 Enter and edit the name, then tap to confirm.
- 5 Enter and edit the number; then tap to save.
↳ The record is saved.

Tip

- Tap or to scroll up or down.





Return a call

- 1 Tap from the idle screen or main menu.
↳ The call log is displayed.
- 2 Tap on a call log record to highlight it.
- 3 Tap on the call log record again to make the call.

Tip

- Tap or to scroll up or down.

Delete a call record





- 1 Tap  from the idle screen or main menu.
↳ The call log is displayed.
- 2 Select a record, then then tap  to access the option menu.
- 3 Select [**Delete**], then tap  to confirm
↳ The handset displays a confirmation requests.
- 4 Tap  to confirm.
↳ The record is deleted.



Tip

- Tap  or  to scroll up or down.

Delete all call records





- 1 Tap  from the idle screen or main menu.
↳ The call log is displayed.
- 2 Tap  to access the option menu.
- 3 Select [**Delete all**], then tap  to confirm
↳ The handset displays a confirmation requests.
- 4 Tap  to confirm.
↳ All record are deleted.

8 Settings

Phone





Set the handset's ringtone volume

You can select among 5 ringtone volume levels, or **[Off]**.

- 1 Tap  to access the main menu screen.
- 2 Select  > **[Phone]** > **[Sounds]** > **[Ring volume]**, then tap  to confirm.
- 3 Select a volume level, then tap  to confirm.
↳ The setting is saved.





Set the handset's ringtone

You can select from 5 ringtones.

- 1 Tap  to access the main menu screen.
- 2 Select  > **[Phone]** > **[Sounds]** > **[Ring tones]**, then tap  to confirm.
- 3 Select a ringtone, then tap  to confirm.
↳ The setting is saved.

Hang up confirmation

You can choose whether the phone asks for confirmation after  has been selected.



- 1 Tap  to access the main menu screen.
- 2 Select  > **[Phone]** > **[Hang up confirmation]**, then tap  to confirm.
- 3 Select **[On]/[Off]**, then tap  to confirm.
↳ The setting is saved.

Silent mode

You can set your phone to silent mode and enable it for a specific duration when you do not want to be disturbed. When the silent mode is turned on, your handsfree phone does not ring.





Note

- When you activate the alarm, your phone still alerts you even when silent mode is activated.

- 1 Tap  to access the main menu screen.
- 2 Select  > **[Phone]** > **[Sounds]** > **[Silent mode]** > **[On/off]** > **[On]** or **[Off]**, then tap  to confirm.
↳ The setting is saved.





Note

- If you select **[On]**, your handsfree phone does not ring for incoming calls during a specified period. If you select **[Off]**, your handsfree phone rings for any incoming call at any time.

- 3 Select **[Start & end]**, then tap  to confirm.
- 4 Set the start and end times, then tap  to confirm.
↳ The setting is saved.
↳  is displayed when silent mode is active and the current time is outside of the silent period.  is displayed when silent mode is active and the current time falls into the silent period.

Exclude the contacts from silent mode

You can select the length of ring delay and set the contacts to be excluded from the phonebook. With this feature, callers that you exclude or those that do not hang up before the ring delay time will be able to reach you even if silent mode is active. Ring delay is the time during which rings will be muted before they become audible on the phone.

- 1 Tap  to access the main menu screen.
- 2 Select  > **[Phone]** > **[Sounds]** > **[Silent mode]**, then tap  to confirm.
- 3 Select **[Exception]**, then tap  to confirm.
- 4 Select **[On/off]** > **[On]** to activate the setting, then tap  to confirm.
- 5 Then you have two options:



- Select **[Delay]**, then select a ring delay option, then tap ✓ to confirm.
- Select **[Select number]**, then select the contact which you want to exclude from this setting. Tap ✓ to confirm. The selected contact is highlighted with a "*", then tap ↩ to leave the menu.

Note

- If **[Exception]** is set to **[On]** and **[Delay]** option is selected, the handset rings only after the time of ring delay selected is reached.
- If the incoming call is from a contact highlighted with a "*", your handsfree phone rings immediately. If the contact is not highlighted with a "*", your handsfree phone rings based on the ring delay option.
- If you exclude the contacts from silent mode or enable ring delay, Make sure **[Exception]** is set as **[On]**, for those exceptions to be active.

Set the key tone

Key tone is the sound made when you press a key on the handset.



- 1 Tap  to access the main menu screen.
- 2 Select  > **[Phone]** > **[Sounds]** > **[Key tone]**, then tap ✓ to confirm.
- 3 Select **[On]/[Off]**, then tap ✓ to confirm.
↳ The setting is saved.

Set the date and time

You can set the date and time for your phone.

Auto lock



You can set to automatically lock the screen on your phone.

- 1 Tap  to access the main menu screen.
- 2 Select  > **[Phone]** > **[Auto lock]**, then tap ✓ to confirm.
- 3 You can choose between **[Off]**, and auto lock timeouts of 20, 40 and 60 seconds.
- 4 Tap ✓ to confirm.
↳ The setting is saved.

Set the display language



Note

- This feature only applies to models with multiple-language support.
- Languages available for selection vary with different countries.

- 1 Tap  to access the main menu screen.
- 2 Select  > **[Phone]** > **[Language]**, then tap ✓ to confirm.
- 3 Select a language, then tap ✓ to confirm.
↳ The setting is saved.



Set backlight of the LCD screen

The handsfree phone display features a backlight to allow good readability in dark environments. You can set the time out for the backlight to turn off when not using the product.

- 1 Tap  to access the main menu screen.
- 2 Select  > **[Phone]** > **[Backlight]**, then tap ✓ to confirm.
- 3 Turn the backlight off or set automatic backlight time out of 20, 40 or 60 seconds. Longer timeouts can reduce battery life.
- 4 Tap ✓ to confirm.

Calibration













In rare cases the touch screen stops recognizing input accurately. In such case, the screen needs to be re-calibrated.

- 1 Tap  to access the main menu screen.
- 2 Select  > **[Phone]** > **[Calibration]**, then tap ✓ to confirm.
- 3 Tap on the cross to confirm.
↳ The setting is saved.

Alarm

Your phone has a built-in alarm clock.

Set the alarm

- 1 Tap  to access the main menu screen.
- 2 Select  > [Alarm], then tap  to confirm.
- 3 Select [On/off] > [On], then tap  to confirm.
- 4 Select [Alarm time], then tap  to confirm.
- 5 Tap  /  once or several times to enter an alarm time, then tap  to confirm.
- 6 Select [Repetition], then tap  to confirm.
- 7 Select an alarm occurrence, then tap  to confirm.
- 8 Select [Alarm tone], then tap .
- 9 Select a tone from options, then tap  to confirm.
↳ The alarm is set and  is displayed on the screen.

Tip

- Tap  /  to switch between [AM]/[PM].

Note





- The alarm clock rings at the preset time every day until it is set to [Off].

Turn off the alarm

When the alarm rings

Press any key to turn off the alarm.

Before the alarm rings

- 1 Tap  to access the main menu screen.
- 2 Select  > [Alarm] > tap  to confirm.
- 3 Select [On/off] > [Off], then tap  to confirm.





↳ The setting is saved.

Services

Call list type



You can set if you can see all calls or missed calls from the call log.

Set the call list type

- 1 Tap  to access the main menu screen.
- 2 Select  > [Services] > [Call list type], then tap  to confirm.
- 3 Select an option, then tap  to confirm.

ECO mode

The handsfree phone supports Eco mode to minimize transmission power and radiation.

- 1 Tap  to access the main menu screen.
- 2 Select  > [Services] > [Eco mode], then tap  to confirm.

You can choose between two modes:

- [Off]: No reduction of transmission power.
- [On]:
 - In Eco mode, transmission will be reduced to minimize radiation. For selected Philips models (CD48x, CD49x, CD68x, CD69x and SE888), both the handset and DECT base will reduce transmission power drastically when the handset is close to the base. The transmission power increases automatically only when the handset is further away from the base. Make sure that Eco mode is also enabled for these models when selecting Eco mode on your handsfree phone. In this mode, the range will be reduced by approximately 50%.
 - If you register your handsfree phone with another phone base not listed above, the handsfree phone will reduce transmission power automatically when it is close to the base. The DECT base

will maintain standard transmission power. In this case, the range is not affected.



Tip





- Apart from Eco mode for the reduction of the transmission power and radiation, this handsfree phone uses a power adapter which consumes very little power in standby mode.

Register your phone

Register your phone manually to the base station before use (see 'Register your phone' on page 7).

Restore default settings

You can reset your phone settings to the original factory settings.

- 1 Tap  to access the main menu screen.
- 2 Select  > **[Services]** > **[Reset]**, then tap  to confirm.
 - ↳ The handset displays a confirmation request.
- 3 Tap  to confirm.
 - ↳ All settings are reset.

9 Technical data

Display

- Touch panel with white LCD backlight

General telephone features

- Display of caller number and caller name (if the name is stored in phone book)
- Talk time: 10 hours
- Standby time: 160 hours

Battery

- Integrated battery: Li-Polymer

Adapter

Charger

- Philips: SSW-1920EU-2, Input: 100-240V 50/60Hz 0.2A, Output: 6V@500mA
- Philips: SSW-1920UK-2, Input: 100-240V50/60Hz 0.2A, Output: 6V@500mA

Power consumption

- Eco power supply with minimal power consumption: 0.01W

Weight and dimensions

- 62 grams
- 90 x 43.5 x 29.5 mm (H x W x D)

Eco mode

Yes

Range

Indoor: 50m; Outdoor: 300m

Phonebook list and Call log

- Phonebook list with 20 entries
- Call log with 30 entries

10 Notice

Declaration of conformity

Hereby Philips Consumer Lifestyle, declares that the MT3120 is in compliance with the essential requirements and other relevant provisions of Directive 1999/5/EC. You can find the Declaration of Conformity on www.p4c.philips.com.

This product has been designed, tested and manufactured according to the European R&TTE directive 1999/5/EC.

GAP standard

The GAP standard guarantees that all DECT™ GAP handsets and base stations comply with a minimum operating standard irrespective of their make. The handset is GAP compliant, which means it guarantees these minimum functions: register it to a base station, make a call and receive a call. More advanced features may not be available if you use them with other makes. To register and use this handset with a GAP compliant base station of different make, first follow the procedure described in the manufacturer's instructions, then follow the procedure described in this manual for registering a handset.

Compliance with EMF

Koninklijke Philips Electronics N.V. manufactures and sells many products targeted at consumers, which, like any electronic apparatus, in general have the ability to emit and receive electromagnetic signals.

One of Philips' leading Business Principles is to take all necessary health and safety measures for our products, to comply with all applicable legal requirements and to stay well within

the EMF standards applicable at the time of producing the products.

Philips is committed to develop, produce and market products that cause no adverse health effects. Philips confirms that if its products are handled properly for their intended use, they are safe to use according to scientific evidence available today.

Philips plays an active role in the development of international EMF and safety standards, enabling Philips to anticipate further developments in standardization for early integration in its products.



Your product is designed and manufactured with high quality materials and components, which can be recycled and reused.



When this crossed-out wheeled bin symbol is attached to a product it means that the product is covered by the European Directive 2002/96/EC. Please inform yourself about the local separate collection system for electrical and electronic products.

Please act according to your local rules and do not dispose of your old products with your normal household waste.

Correct disposal of your old product helps to prevent potential negative consequences for the environment and human health.



Your product contains a built-in rechargeable battery covered by the European Directive 2006/66/EC, which cannot be disposed of with normal household waste.

Please inform yourself about the local rules on separate collection of batteries because correct disposal helps to prevent negative

consequences for the environmental and human health.

Remove the integrated battery

If there is no collection/recycling system for electronic products in your country, you can protect the environment by removing and recycling the battery before disposing the phone.

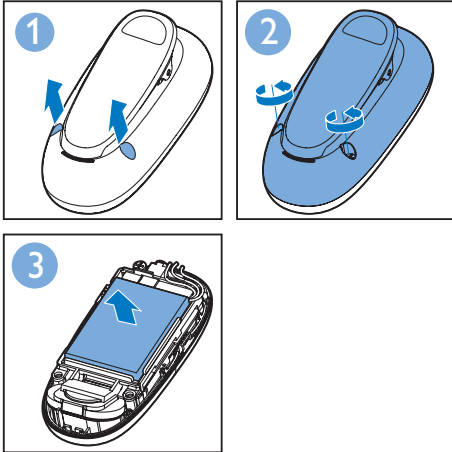

When this logo is attached to a product, it means a financial contribution has been paid to the associated national recovery and recycling system.

Environmental information

All unnecessary packaging has been omitted. We have tried to make the packaging easy to separate into three materials: cardboard (box), and polyethylene (bags, protective foam sheet.) Your system consists of materials which can be recycled and reused if disassembled by a specialized company. Please observe the local regulations regarding the disposal of packaging materials, exhausted batteries and old equipment.

11 Frequently asked questions

How to connect the handsfree phone to my other phones?

Go to  >  > [Services] > [Register].



Tip

- For information, see chapter 'Get started', section 'Register your phone'.

No signal bars are displayed on screen.

- The handset is out of range. Move it closer to the base station.
- Make sure you have registered your phone to the base station.



Tip

- For information, see chapter 'Get started', section 'Register your phone'.

My phone is not connected to the base station/I cannot get a dial tone.

Your phone is not registered, i.e. linked to the base station. Register the handset with the base station.

If I fail to register the phone to the base station, what do I do?

Your base memory is full. Unregister the unused handsets and try again.

No dialing tone

- Check your phone connections.
- The handset is out of range. Move it closer to the base station.

The handset is connected to the power supply but does not charge.

- Make sure there is power supply and the charging adapter is plugged properly to the phone.
- Make sure you switch on the phone.

No display

- Make sure the batteries are charged.

- Make sure there is power and the phone is connected to the charger.

Bad audio (crackles, echo, etc.)

- The handset is nearly out of range. Move it closer to the base station.
- The phone receives interference from the nearby electrical appliances. Move the base station away from them.
- The phone is at a location with thick walls. Move the base away from them.

The handset does not ring.

Make sure the handset ringtone is turned on.

The caller ID is not displayed.

- The service is not activated. Check with your service provider.
- The caller's information is withheld or unavailable.
- Not all DECT base stations support caller ID service compatible with this phone.

I have a 6 digit pin code but I can only enter 4 digits on my handsfree phone.

If you use a pin code with more than 4 digits, it cannot be entered through the handsfree phone. In this case, change your base stations pin code to a 4-digit pin code (e.g.0000) and then resume the registration process.

Internal calls do not work on my handsfree phone.

Placing internal calls from your handsfree phone is not supported.



Note

- If the above solutions do not help, Switch off the phone, then switch it on and try again.

12 Appendix

Text and number input tables

Key	Upper case characters (for English/ French/ German/ Italian/Turkish/ Portuguese/Spanish/Dutch/Danish/ Finnish/Norwegian/ Swedish/Romanian/ Polish/Czech/Hungarian/Slovakian/ Slovenian/Croatian/Lithuanian/Estonian/ Latvian/Bulgarian)
0	Space . 0 , / ; " ' ! ; ? ; * + - % \ ^ ~
1	1 @ _ # = < > () & € £ \$ ¥ [] { } ¤ § ...
2	A B C 2 Å Ä Æ Á Ā Ą Ą Ą Ą Ą Ą Ç Ć
3	D E F 3 È É Ê Ë Ë Ë Ë Ë Δ Φ
4	G H I 4 Ğ Ĩ Ĵ Ĳ Ĳ Ĳ Ĳ Ĳ Ĳ
5	J K L 5 Λ
6	M N O 6 Ñ Ó Ô Õ Ö
7	P Q R S 7 Š ſ Π Θ Σ
8	T U V 8 Û Ü Ū Ū Ū Ū Ū Ū Ū Ū
9	W X Y Z 9 Ø Æ Ξ Ψ Ž

Key	Lower case characters (for English/ French/ German/ Italian/Turkish/ Portuguese/Spanish/Dutch/Danish/ Finnish/Norwegian/Swedish)
0	Space . 0 , / ; " ' ! ; ? ; * + - % \ ^ ~
1	1 @ _ # = < > () & € £ \$ ¥ [] { } ¤ § ...
2	a b c 2 à â ã ä å ä å ä å ä ç ĉ
3	d e f 3 è é ê ë è è ē Δ Φ
4	g h i 4 ğ ĩ ĵ Ĳ Ĳ Ĳ Ĳ Ĳ Ĳ
5	j k l 5 Λ
6	m n o 6 ñ ó ô õ ö ò
7	p q r s 7 š š ſ Π Θ Σ
8	t u v 8 ù ú ü ū ū ū ū ū ū ū ū
9	w x y z 9 ø æ Ξ Ψ ž

Key	Upper case characters (for Greek)
0	Space . 0 , / ; " ' ! ; ? ; * + - % \ ^ ~
1	1 @ _ # = < > () & € £ \$ ¥ [] { } ¤ § ...

2	A B Γ 2 A B C Æ Å Ä Ç
3	Δ Ε Ζ 3 D E F Ε
4	H Θ Ι 4 G H I
5	K Λ Μ 5 J K L
6	N Ξ Ο 6 M N O Ñ Ö
7	Π Ρ Σ 7 P Q R S
8	T Υ Φ 8 T U V Ü
9	X Ψ Ω 9 W X Y Z Ø

Key	Lower case characters (for Greek)
0	Space . 0 , / ; " ' ! ; ? ; * + - % \ ^ ~
1	1 @ _ # = < > () & € £ \$ ¥ [] { } ¤ § ...
2	α β γ 2 a b c à æ ä å
3	δ ε ζ 3 d e f è é
4	η θ ι 4 g h i ï
5	κ λ μ 5 j k l λ
6	ν ξ ο 6 m n o ñ ö ò
7	π ρ σ ς 7 p q r s β
8	τ υ φ 8 t u v ü ü
9	χ ψ ω 9 w x y z ø

Key	Upper case characters (for Serbian)
0	Space . 0 , / ; " ' ! ; ? ; * + - % \ ^ ~
1	1 @ _ # = < > () & € £ \$ ¥ [] { } ¤ § ...
2	A B C Ђ Ć Č 2 A B В Г
3	D E F Ј Đ 3 Δ Ε Ж 3 Δ Φ
4	G H I Љ 4 И Й К Л Г
5	J K L Њ 5 M H O П Л
6	M N O Ћ 6 P C T Y
7	P Q R S □ Š 7 Ф Х Ц Ч П Θ Σ Β
8	T U V 8 Ш Щ Ъ Ы
9	W X Y Z Ž 9 Ъ Э Ю Я Ω Ξ Ψ

Key	Lower case characters (for Serbian)
0	Space . 0 , / ; " ' ! ; ? ; * + - % \ ^ ~
1	1 @ _ # = < > () & € £ \$ ¥ [] { } ¤ § ...
2	a b c Ђ Ć Č 2 A B В Г
3	d e f Ј Đ 3 Δ Ε Ж 3
4	g h i Љ 4 И Й К Л
5	j k l Њ 5 M H O П

6	m n o ґ 6 P C T Y
7	p q r s □ Š 7 Ф X Ц Ч П Θ Σ Β
8	t u v L j 8 Ш Щ Ъ Ы
9	w x y z Ž 9 Ь Э Ю Я Ω Ξ Ψ

Key Upper case characters (for Russian and Ukrainian)

0	Space . 0 , / ; " ' ! ; ? ; * + - % \ ^ ~
1	1 @ _ # = < > () & € £ \$ ¥ [] { } ¢ § ...
2	А Б В Г 2 Г А В С Æ Ä Å Ç
3	Д Е Ё Ж 3 З € Д Е F É Δ Φ
4	И Й К Л 4 І Ğ Н І Г
5	М Н О П 5 J K L Λ
6	Р С Т У 6 М N O Ñ Ö
7	Ф X Ц Ч 7 P Q R S П Θ Σ Β
8	Ш Щ Ъ Ы 8 T U V Ü
9	Ь Э Ю Я 9 W X Y Z Ø Ω Ξ Ψ

Key Lower case characters (for Russian and Ukrainian)

0	Space . 0 , / ; " ' ! ; ? ; * + - % \ ^ ~
1	1 @ _ # = < > () & € £ \$ ¥ [] { } ¢ § ...
2	а б в г 2 г а б с à æ ä å
3	д е ё ж 3 з € д е f è é Δ Φ
4	и й к л 4 і ğ н і і Г
5	м н о п 5 j k l Λ
6	р с т у 6 м n o ñ ö ò
7	ф х ц ч 7 p q r s П Θ Σ Β
8	ш щ ъ ы 8 t u v ù ü
9	ь э ю я 9 w x y z ø Ω Ξ Ψ



CE 0979

Specifications are subject to change without notice
© 2012 Koninklijke Philips Electronics N.V.
All rights reserved.



Free Manuals Download Website

<http://myh66.com>

<http://usermanuals.us>

<http://www.somanuals.com>

<http://www.4manuals.cc>

<http://www.manual-lib.com>

<http://www.404manual.com>

<http://www.luxmanual.com>

<http://aubethermostatmanual.com>

Golf course search by state

<http://golfingnear.com>

Email search by domain

<http://emailbydomain.com>

Auto manuals search

<http://auto.somanuals.com>

TV manuals search

<http://tv.somanuals.com>