

DECT 623
DECT 621



User manual





**Charge the handset(s) 24 hours
before use.**



PHILIPS

Quick start guide / understanding the menu system

Press the **Left soft key (LSK)**  to enter the main menu in idle mode. Use the **Navigation keys**  to go up or down in the menu list or to navigate within the lists. Press the **LSK**  to select the menu or an option and confirm a setting.

Press the **Right soft key (RSK)**  to access the **Phonebook** in idle mode and press the **LSK**  to **VIEW** the details.



A short press of one of the soft keys confirms the text function described above these keys.

Press the **Up navigation key**  to access the **Redial list** in idle mode and press the **Down navigation key**  to access the **Call log**.

Answer / end a call



Make a call

Predial number &  or  and dial number



Read Call log

Press , scroll  to select **Call log** or **SMS** and browse 

Redial a number

Press  and browse  and 



Call from phonebook

Press **RSK**  and browse  and 

Add a name to the phonebook

Predial number and press the **LSK**  to select **SAVE**, enter the name and press 

Adjust the earpiece volume during a call

Scroll up  to increase the volume, scroll down  to decrease the volume





Adjust the handset loudspeaker volume

During a handsfree call, Up  to increase, Down  to decrease









Mute and unmute the microphone

During a call press **LSK**  **MUTE**, press **LSK** again  to select **UNMUTE**

Set the date and time

Press the **LSK**  to enter the menu list, scroll  to **Clock & Alarm** and press  **SELECT**, press  to select **Date & time**. Enter the current time (HH:MM), then the current day (DD/MM) and press  **SELECT**.

Set the handset ring tone

Press the **LSK**  to enter the menu list, scroll  to **Personalize** and press  **SELECT**, scroll  to **Handset Tones** and press  **SELECT**. Scroll  to **HS Ringtone** and press  **SELECT**. Browse  through the list to hear the ring tones and select  your chosen ring tone.

Activate/deactivate the answer machine (only DECT 627)

Press  on the base station to switch the answer machine ON/OFF

DECT 623/DECT 627 Handset

Colour Display

Headline : shows icons and current menu operation.
Soft key line : shows contextual menus.

Left Soft key

- In idle mode, short press to access the main menu.
- Short press to select contextual menu.

Pick-up & Recall key

- Press to take the line and answer a call.
- To insert **R** for operator services when on line.

Keypad lock & insert *

- Short press to insert *
- Long press to lock/unlock the keypad in idle mode.

Loudspeaker*

- Short press to take the line and to activate the handset loudspeaker during a call.

Earpiece

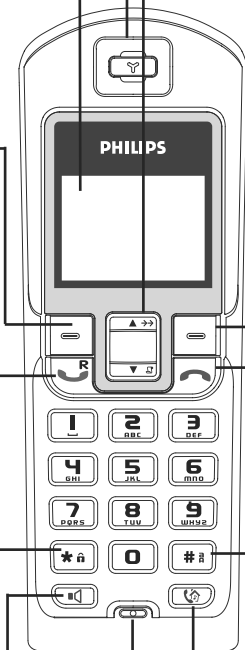

Microphone

Navigation keys

- Scroll to move through the menus & options
- Scroll up to access the **Redial list** from idle mode
- Scroll down to access the **Call log/SMS** messages from idle mode

Right Soft key

- Short press to access the **Phonebook** from idle mode.
- Short press to select contextual menu.

Hang-up key

- A short press to hang-up the line or to exit (return to idle mode).
- A long press to power off the handset.

Case mode & insert

- Short press to insert #.
- Press to change case mode when editing.
- Long press to insert a pause (P) when dialling.

Intercom / Call transfer

- Short press to initiate an internal call.
- Short press during internal call to transfer the call or switch between internal call and external call.
- Short press to answer an internal call.

***Warning :** Handsfree activation could suddenly increase the volume in the earpiece to a very high level. Make sure the handset is not too close to your ear.

Icons on the handset display

The display gives information about the operation of your telephone. A total of 8 icons can be shown in the headline of the display :



When being used for the first time, it is sometimes necessary to wait until the battery is sufficiently charged before the icons appear on the display.



The handset is registered and in range of the base. **When blinking**, this symbol indicates that the handset is not registered to the base or out of range.



The ringtone is deactivated.



The alarm clock is activated.



An external call is in progress. **When blinking**, this symbol indicates that there is an incoming external call in progress or that the line is already busy.



An internal call is in progress. **When blinking**, this symbol indicates that there is an incoming internal call.



The keypad is locked.



The handset loudspeaker is activated.







New message(s) (SMS, call log entry or voice mail).

When charging, the battery bars scroll from empty to full status.



When the handset discharges, the battery shows the status :

Full , 2/3 , 1/3  and empty .

Icons on the base display

only DECT 627

The display of the base DECT 627 gives information about the answer machine and the settings.

Time (HH : MM)



Date (DD / MM)

Number of messages



The remote access code is activated.



New unread message(s) on answer machine.



Old message(s) on answer machine, already read.



The answer machine is ON.



Indicates the type of outgoing message.



Indicates the number of rings before the answer machine will start playing the outgoing message.



Call screening ON/OFF

DECT 623 base station

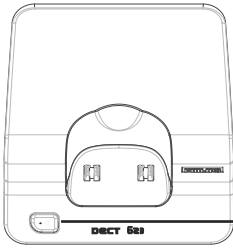

Paging key

The paging key enables you to locate a missing handset if the handset is in range and has charged batteries. Press the key until the handset starts to ring. Once retrieved, press  key on the handset to end paging.

DECT 627 base station



Volume keys

To adjust the base volume level

Backlight will be ON when there are new answer machine messages or answer machine memory is full.
Icons see page 3



Paging key

Press to locate all handsets.



ON/OFF key

Press to switch the answer machine ON or OFF



Skip back / Replay key

If pressed within 1 second of message playback : Skip to previous message.
If pressed after 1 second of message playback : Replay current message.



Play / Stop key

Short press to play message.
Short press to stop playback while listening to a message.
Long press to enter answer machine setting mode.

Loudspeaker

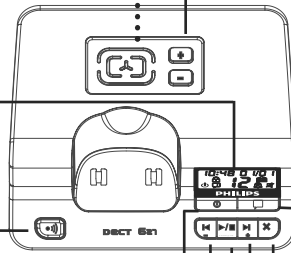

Record Memo &

Outgoing messages

Short press to record a memo.
Long press to record outgoing message 1 or 2 (see page 49).



Skip forward / Next

message

Short press to go to the next message while listening.





Delete key

Short press to delete the current message during playback.
Long press in idle mode to delete all messages (after all messages have been read).

Quick start guide	1
DECT 623 / DECT 627 handset	2
Icons on the handset display	3
Icons on the base DECT 627	3
DECT 623 / DECT 627 base station	4
Table of contents	5-6
Menu structure	7-9
Contextual soft key labels	9
Conformity, environment and safety	10
Declaration of conformity	
Using GAP standard compliance	11
Installing the DECT 623/627	
Unpacking your DECT 623/627	12
Installing the base station	13
Installing and replacing the batteries in the handset	13
Battery life and range	13
Configuration mode	14
Handset power Off/On and keypad lock/unlock	14
Introduction	
Idle mode	15
Understanding the menu system	15
Basic principles	16
In-call features	17
Editing systems	18
SMS	
Write and send new SMS	19
View SMS	20
Inbox	21
Outbox	22
Draft folder	24
SMS settings	25
Clock & Alarm	26
To set the date and time	26
To set the alarm clock	26-27
Phonebook	
Group ring tone	28
New entry	28
View	29

Call log	
View	32
Store a number in the phonebook	32
Delete all	33
Redial list	
View	34
Store a number in the phonebook	34
Delete all	35
Intercom	
Internal call	36
Call transfer	36
Conference call	37
Personalize	
Wallpaper	38
Contrast	38
Handset tones	38
Handset name	40
Auto answer	40
Language	40
Advance settings	
Dial mode	41
Flash time	41
Voice language (only DECT 627)	42
Security	42
Registration	43
Unregistration	43
Reset	43
Network service (Operator services)	44
Answer machine DECT 627	
Keys	45
Display	46
Saved messages	46
Delete answer machine messages	47
Answer machine settings	47
Outgoing messages	49
Record and listen to a memo	50
Remote control	51
Default settings	51
FAQ	52-53
Troubleshooting	54-55
Index	56

Menu structure

From idle mode, to enter the menu, press the **Left soft key (LSK)**  **MENU**. Use the **Navigation keys**  to go up or down in the menu list.

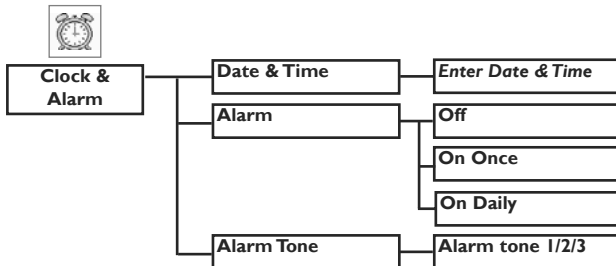
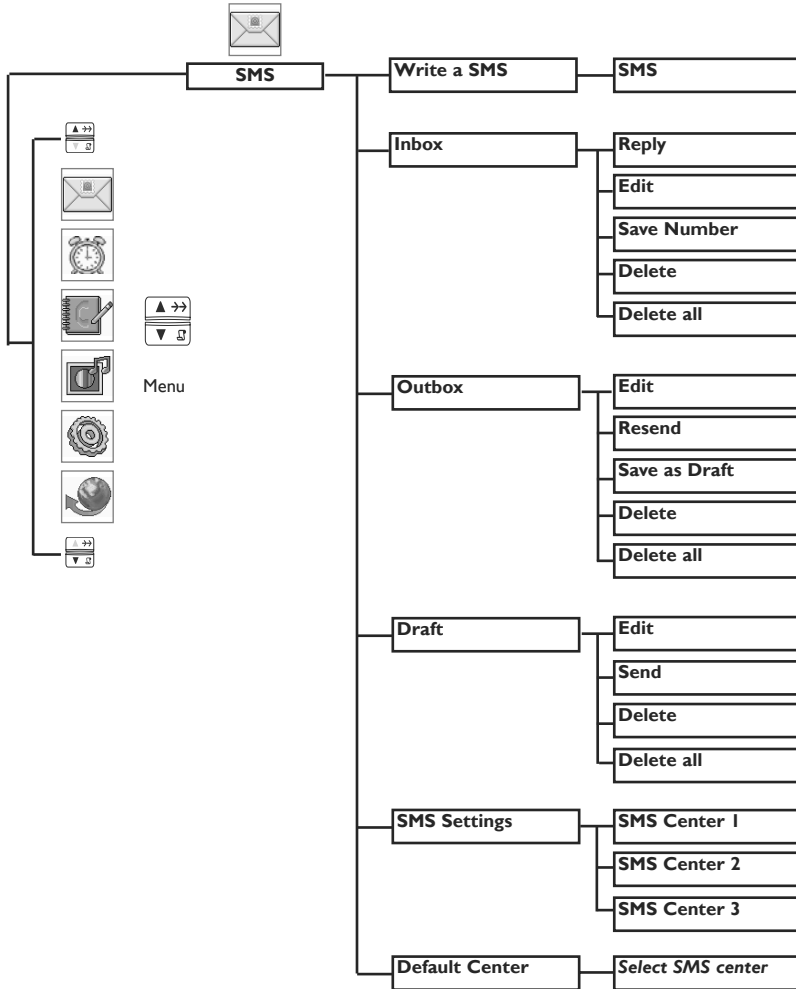

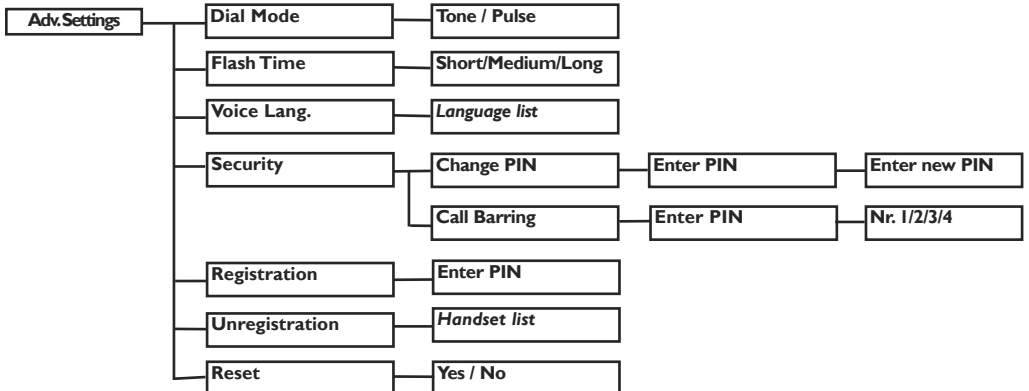
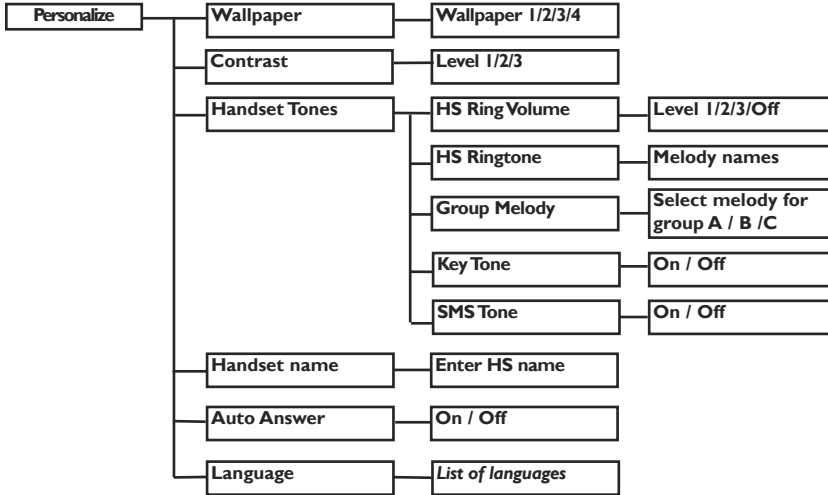
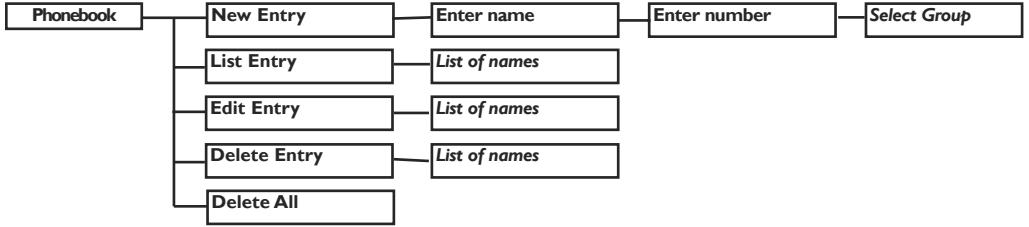

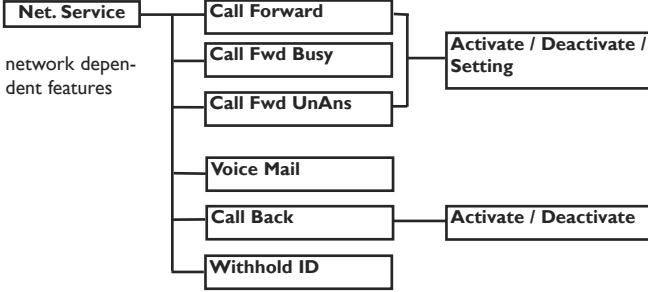

Contextual soft key labels

Depending on context the following soft key labels may appear above the Left and Right soft keys :

Soft key label Function

MENU	Initiate a menu function.
SELECT	Choose the current selection.
OK	Confirm the current settings / entry or function.
BACK	Go back to the previous screen.
PHBK	Access Phonebook list.
MUTE	Mute the handset microphone.
UNMUTE	Unmute the handset microphone.
SILENT	Stop the incoming ring tone.
CLEAR	Clear the current character and shift the cursor to the left.
SAVE	Save in phonebook.
STOP	Switch off the alarm.
VIEW	View the details of an entry.
ALL	To call all handsets via intercom.
CONF	Start a conference call.

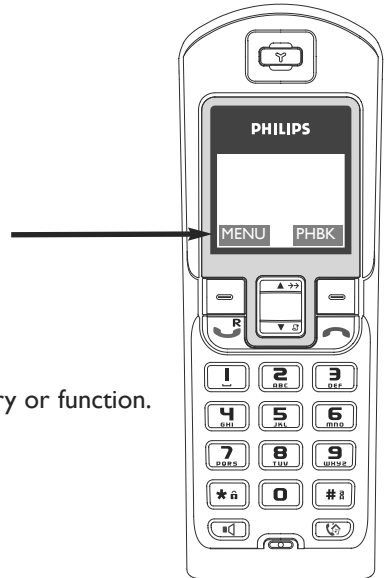

Conformity, environment and safety

Safety information

This equipment is not designed to make emergency calls when the power fails. An alternative has to be made available to allow emergency calls.

Conformity

Hereby, Philips declares that the DECT 623xx and DECT 627xx are in compliance with the essential requirements and other relevant provisions of Directive 1999/5/EC. This product can only be connected to the analogue telephone networks of the countries mentioned on the packaging.

Power requirements

This product requires an electrical supply of 220-240 volts, alternating monophased power, excluding IT installations defined in standard EN 60-950. In case of power failure, the communication can be lost.

Warning !

The electrical network is classified as hazardous according to criteria in the standard EN 60-950. The only way to power down this product is to unplug the power supply unit from the electrical outlet. Ensure the electrical outlet is located close to the apparatus and is always easily accessible.

Telephone connection

The voltage on the network is classified as TNV-3 (Telecommunication Network Voltages), as defined in the standard EN 60-950.

Safety precautions

Do not allow the handset to come into contact with water. Do not open the handset or the base station. You could be exposed to high voltages. Do not allow the charging contacts or the battery to come into contact with conductive materials. Never use any battery type other than the one supplied : risk of explosion.

Handsfree activation could suddenly increase the volume in the earpiece to a very high level. Make sure the handset is not too close to your ear.

Environmental care

Please remember to observe the local regulations regarding the disposal of your packaging materials, exhausted batteries and old phone and, where possible, promote their recycling.

Recycling & disposal

Disposal instructions for old products.

The purpose of the WEEE directive (Waste Electrical and Electronic Equipment; 2002/96/EC) is to ensure that products are recycled using best available treatment, recovery and recycling techniques to ensure human health and high environmental protection.

Your product is designed and manufactured with high quality materials and components, which can be recycled and reused.

Do not dispose of your old product in your general household waste bin.

Inform yourself about the local separate collection system for electrical and electronic products marked by this symbol :



Use one of the following disposal options :

1. Dispose of the complete product (including its cables, plugs and accessories) in the designated WEEE collection facilities.
2. If you purchase a replacement product, hand your complete old product back to the retailer. He should accept it as required by the WEEE directive.

Declaration of conformity

We,
PHILIPS Consumer Electronics
Route d'Angers
72081 Le Mans Cedex 9
France

Declare that the products DECT62xx are in compliance with ANNEX IV of the R&TTE-Directive 1999/5/EC and then with the following essential requirements :

Article 3.1 a: (protection of the health & the safety of the user)

Safety: EN 60950-1 (10/2001)

SAR: EN 50371 (2002)

Article 3.1 b: (protection requirements with respect to electromagnetic compatibility)

EMC : ETSI EN 301 489-6 V1.2.1 (08/2002) & ETSI EN 301 489-1 V1.4.1 (08/2002)

Article 3.2: (effective use of the radio spectrum)

Radio : EN 301 406 V1.5.1 (2003)

The presumption of conformity with the essential requirements regarding Council Directive 1999/5/EC is ensured.

Date : 20/05/2005

Le Mans



CE0168

Product Quality Manager
Home Communication

Using GAP standard compliance

The GAP standard guarantees that all DECT™ GAP handsets and base stations comply with a minimum operating standard irrespective of their make. Your DECT 623/627 handset and base station are GAP compliant, which means the minimum guaranteed functions are : register a handset, take the line, receive a call and dial. The advanced features may not be available if you use another handset than a DECT 623/627 with your base station (except with DECT 723/727 handsets).

To register and use your DECT 623/627 handset with a GAP standard base station of a different make, first follow the procedure described in the manufacturer's instructions, then follow the procedure described on page 43.

To register a handset of another make to the DECT 623/627 base station, place the base station into registration mode (page 43), then follow the procedure in the manufacturer's instructions.

Philips has marked the battery and packaging with standard symbols designed to promote the recycling and appropriate disposal of your eventual waste.



A financial contribution has been paid to the associated national recovery & recycling system.



The labelled packaging material is recyclable.

DECT™ is a Trade Mark of ETSI registered for the benefit of the implementers of the DECT technology.

Installing the DECT 623/627

Unpacking your DECT 623

The DECT 623 package contains:

One DECT 623 base station



One DECT 623 handset



NiMh AAA
550 mAh
rechargeable
batteries



A user guide
and an SMS
leaflet



A guarantee



A power supply
unit

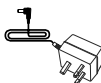

A line cord*

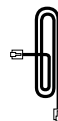

Unpacking your DECT 627

The DECT 627 package contains:

One DECT 627 base station

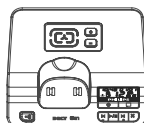

One DECT 627 handset



NiMh AAA
550 mAh
rechargeable
batteries



A user guide
and an SMS
leaflet



A guarantee



A power supply
unit

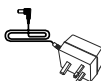

A line cord*

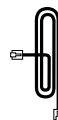

***Warning :** You may find in the box the line adaptor delivered separately from the line cable. In this case, please **connect the line adaptor to the line cable before connecting it to the line socket.**

In DECT 623 and DECT 627 multi handset packs, you will also find one or more additional handsets, chargers with power supply units and additional rechargeable batteries.

Installing the base station

Place your product close enough to the telephone and mains power sockets so that the cables will reach. To properly install the base station, plug the line cord and the power cable into the base station. Plug the cord and the cable into the wall. If you have a broadband DSL Internet connection, please make sure you have one DSL filter plugged directly on each line socket used in the house and check the modem and the phone are plugged in the correct filter slot (one specific for each).

Warning! The electrical network is classified as hazardous according to criteria in the standard EN 60-950. The only way to power down this product is to unplug the power supply from the electrical outlet. Ensure the electrical outlet is located close to the apparatus and is always easily accessible. Please take care that the power supply and telephone line are connected to the correct sockets as incorrect placement could damage your equipment.

Warning! Always use the line cable provided with the product otherwise you may not have a dialling tone.

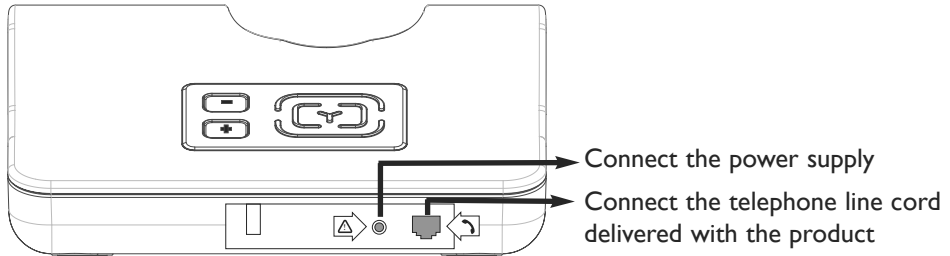

Installing and replacing the batteries in the handset

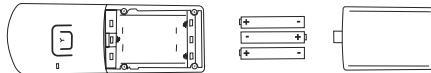

To insert the batteries, open the battery cover, place the batteries as indicated and then replace the battery cover. When the handset is placed on the base station, the 3 battery bars scroll (if charge is needed). Allow 12 - 15 hours for the batteries to fully charge. On first use it may be necessary to wait for a few minutes before seeing symbols on the display.

Never use any battery type other than the one supplied : risk of explosion.

Warning: the base station must always be plugged into the mains when charging or when in use. Always use rechargeable batteries.

The warranty does not apply to the batteries and any other components which have a limited lifetime or are exposed to wear.



Batteries should not be disposed of with general household waste.

Battery life and range

Optimal battery life is reached after 3 cycles of complete charging & discharging. When reaching the range limit and the conversation becomes crackly, move closer to the base. To reach optimal range, place the base station away from electrical appliances.

Battery life in talk time	Battery life in standby mode	Indoor range	Outdoor range
up to 14 hours	up to 140 hours	up to 50 metres	up to 300 metres

Configuration mode

Country dependent feature

Before using your DECT 623/627, you need to configure it according to the country of use. Install the batteries. After a few minutes of charging, the configuration screen appears.

Browse  through the different countries.

Press  **SELECT** to choose the country that suits you.

Browse  through the list of operators.

Press  **SELECT** to choose your operator.

Your phone is ready to be used.

If you need to re-configure your DECT 623/627, see page 40.

Note: If  **BACK** is pressed, the handset will show the country selection screen again.

Handset power OFF and ON

To power the handset OFF or ON long press the  key.



Keypad lock/unlock

Long press the  key to lock/unlock the keypad in idle mode.

Introduction

Idle mode

In idle mode, the DECT 623/627 display shows various information:

- The date & time, the name of the handset and the instructions to access the menu.
- New calls, new SMS  or network voicemail message, if any.
- and the alarm clock , if activated.

You can define a wallpaper image for the idle mode (see page 38). By default one of the preinstalled pictures is used as wallpaper.







Understanding the menu system





To access the main menus from the idle mode, press the Left Soft Key  **MENU**.





Scroll up  or down  to reach the desired menu and press the Left Soft Key  to **SELECT**. To return to the idle mode press the Right Soft Key to select  **BACK**.

The sub menus are listed one under the other, so when reaching the bottom of the list, the first item is then shown again. Up to five sub menus are displayed on the screen. When there are more than 5 sub menus in the list, an arrow ▼ is displayed between the soft key labels.









To reach one particular sub-menu, use the navigation keys  and press the Left Soft Key  to **SELECT**.

Note : in idle mode the Phonebook names list is also directly accessible via the Right Soft Key  **PHBK**, the Call log via the

Down navigation key  and the Redial list via the Up navigation key .

Basic principles

To make, to answer and to end a call

Predialling	Direct dialling	Answer a call*	End a call
 Dial the number	 Press the key	When ringing	
 Make the call	 Dial the number	 Take the line	



*You can also press the  key to answer an incoming external call in handsfree mode. If you have activated the Auto Answer Mode (see page 40) simply lift up the handset from the base or charger to answer a call.

Warning! Upon incoming calls, the handset ringer volume can increase in the earpiece. Make sure the handset is not too close to your ear when ringing.





Call duration counter

After you have taken the line (dial a number or answer a call), the call duration counter appears on the handset display.





To call from the phonebook

-  Press the **RSK** to directly access **PHBK**.
-  Choose a name in the list.
-  Make the call.

To store a name from predial

-  Dial the number.
-  Press **SAVE** to enter the options.
-  Enter the name and press  **OK**.

Redial from call log

-  Press the Down key to directly access the **Call log**.
-  Press **SELECT**.
-  Choose an entry.
-  Make the call.

In-call features

During an external call, some other options are available.

To mute the handset microphone



- Press to select **MUTE** (the caller can no longer hear you).
- Press again to resume the conversation (**UNMUTE**).

Intercom (available only if you have at least two handsets)

During an external call, you can use the intercom key to call another handset and, for example, transfer the call to this handset.



- Press to put the external call on hold, the caller can no longer hear you.
- Enter the number of the handset you want to transfer the call to.
- Press to end the call on the first handset when the second handset has taken the line.

Other options are available such as **Switch** and **Conference call** (see page 36-37).

To access the phonebook, the call log or the redial list

Press the **RSK**  to enter the **Phonebook** or press the Down navigation key  to enter the **Call log** or press Up navigation key  to enter the **Redial list**.

To switch the handset loudspeaker ON/OFF

Press  to activate or deactivate the handset loudspeaker.

Warning : Handsfree activation could suddenly increase the volume in the earpiece to a very high level. Make sure the handset is not too close to your ear.



To increase/decrease the volume of the earpiece and loudspeaker during a call



Scroll up to increase or down to decrease the volume when on line.

The last setting is stored for the next calls.

Caller Line Identification and Call waiting



If you subscribe to the Call waiting service, a beep in the earpiece informs you of a second incoming call. The name or number of the second caller may be displayed if you also subscribe to Caller Line Identification Service. To answer that second call, use  +  (according to your network, the code may be different). Please contact your network provider for more details.

Editing system

Case mode

By default, the first letter of a sentence is in upper case. Use  to change the case mode:

- all letters in upper case (ABC)
- all letters in lower case (abc) or
- the first letter in upper case and the rest of the word in lower case (Abc).

Punctuation and mathematical signs are available by pressing  or  while other special characters are also available via  (see table below).

Scroll  to move the cursor left or right. Press  **CLEAR** to delete a character.

The standard multi-tap system

This system allows you to enter the text character by character, pressing the corresponding key as many times as necessary to reach the desired character.

In multi-tap mode, letters available on the alpha-numeric key pressed by the user are shown under the header.

The current case mode is indicated between the soft key labels (a or A).

To write "Peter" with multi-tap

Press  once : P

Press  twice : Pe

Press  once : Pet

Press  twice : Pete

Press  three times : Peter

Keypad Keys	Multi-tap Sequence
1	[space] @ _ # = < > () & € £ \$ ¥ [] { } ¢ §
2	a b c 2 à ä ç â æ
3	d e f 3 è é Δ φ
4	g h i 4 ì Γ
5	j k l 5 Λ
6	m n o 6 ñ ò ö
7	p q r s 7 ß Π θ Σ
8	t u v 8 ù ü
9	w x y z 9 φ Ω Ξ Ψ
0	. 0 , / ; : " ' ! ; ? ; * + - % \ ^ ~

Warning : An unknown character (not available in the characters table) in received SMS messages is replaced by a space. The symbols €, [and] count as 2 characters.



SMS

Write a SMS
Inbox
Outbox
Draft
SMS settings
Default Center

Important informations are also available on the SMS leaflet in the box

SMS stands for Short Message Service. To benefit from this service you must subscribe to the Caller Line Identification Service (CLI) together with the SMS service from your network provider. SMS messages can be exchanged with a phone (mobile or compatible fixed lines), a fax or an

Email address provided the receiver has also subscribed to the CLI & SMS services.

Your DECT 623/627 factory settings correspond to the main national operator. If you wish to send or receive SMS through another service provider you must set the corresponding numbers (see page 25 and the SMS leaflet).

Write and send new SMS

To write and send an SMS to a phone



Press to reach the menu list and press **SELECT**.



Select **Write a SMS** option and press **SELECT**.



Enter the text and press **OK** (see page 18).

Note : To delete a wrong character, press **CLEAR**. You can delete and change any character by simply moving the cursor to the left or to the right to reach the character and pressing **CLEAR** once.

If you enter more than 640 characters for an SMS you will hear an error beep.



Enter the phone number and press **OK** or press **LSK** **PHBK** and scroll to retrieve the number from the **Phonebook list** (to send SMS from phonebook, see page 30).



Select **Send**, otherwise



if you want to store your SMS, scroll to **Save as Draft** and press **SELECT**. The SMS stored can be later retrieved from **Draft** folder.

The sent SMS can be up to a maximum of 640 characters long. The DECT 623/627 can store 20 SMS messages of 160 characters each in the draft folder and in the Outbox.

View SMS

The display shows that there is (are) new message(s) : **3 New SMS** and in the headline the icon  is ON. If the SMS tone is activated (see page 40) you will hear an alarm tone each time you receive a new message.

There are two ways to view the received SMS messages : you can use the **Call log** key or the **Inbox** menu. The SMS messages are displayed from the newest to the oldest. Unread messages in the Inbox list are shown by an exclamation mark .

Note: If you have subscribed to the Caller Identification Service (CLI), the display shows the name or the number of the sender.

To read an SMS by using the Call log



Press to access the Call log.

Scroll to **SMS** and press  **SELECT**.

Browse the list of SMS and select the message you want to read.

Press to select **VIEW** and to see the content of the message.

To return to the inbox list, press  **BACK**.

To read an SMS by using the Inbox menu





Press to reach the menu list and press  **SELECT**.

Scroll to **Inbox** and press  **SELECT**.

Browse the list of SMS and select the message you want to read.

Press to select **VIEW** and to see the content of the message.

To return to the Inbox list, press  **BACK**.

While reading SMS, press  to scroll to the next page and press  to return to the previous page. At the end of the message, the sender number and the date/time of receipt are shown.

When viewing the list of received SMS, some options are only available for SMS received from a phone.

These options are **Reply**, **Edit**, **Save Number**, **Delete** and **Delete all**.

Inbox

All received SMS messages are stored in the Inbox (up to 20 messages).

To reply to an SMS (for received SMS)



Press to reach the menu list and press **SELECT**.



Scroll to **Inbox** and press **SELECT**.



Browse the list of SMS and press **VIEW** to select the one you want to reply to.



Press **MENU**, confirm **Reply** by pressing **SELECT**.



Enter the text (see page 18) and press **OK**.



Press **OK** to confirm the number.



Select **Send**.

To edit and send again an SMS (for received SMS)



Press to reach the menu list and press **SELECT**.



Scroll to **Inbox** and press **SELECT**.



Browse the list of SMS and press **VIEW** to select the one you want to edit and send again.



Press **MENU**, scroll to **Edit** and press **SELECT**.



You can modify the text if necessary (see page 18) and press **OK**.



Enter the number and press **OK** or retrieve it from the phonebook (see page 30).



Select **Send**.

To save a sender number in the phonebook



Press to reach the menu list and press **SELECT**.



Scroll to **Inbox** and press **SELECT**.



Browse the list of SMS and press **VIEW** to select the one you want to copy the number.



Press **MENU**, scroll to **Save Number** and press **SELECT**.



Enter the name and press **OK**.



The number is inserted automatically. Press **OK** to confirm.











Browse the list of melodies and select the wanted group ring tone for this record.











Press **SELECT** to confirm.

To delete an SMS from the Inbox

-  Press to reach the menu list and press  **SELECT**.
 -  Scroll to **Inbox** and press  **SELECT**.
 -  Browse the list of SMS and press  **VIEW** to select the one to be deleted.
 -  Press **MENU**, scroll to **Delete** and press  **SELECT**.
- The selected message will then be deleted immediately.

To delete all SMS from the Inbox

This option enables you to delete all SMS in the Inbox list.

-  Press to reach the menu list and press  **SELECT**.
 -  Scroll to **Inbox** and press  **SELECT**.
 -  Browse the list of SMS and press  **VIEW**.
 -  Press **MENU**, scroll to **Delete All** and press  **SELECT**.
- Once selected, a confirmation is required : **“Delete All?”**.
-  Press **SELECT** to confirm or **BACK** if you do not want to delete all your SMS list.











Outbox

All your successfully sent messages are stored in the Outbox (up to 20 messages).

To review sent messages

-  Press to reach the menu list and press  **SELECT**.
 -  Scroll to **Outbox** and press  **SELECT**.
- The list of sent messages is displayed.
-  Browse the list of SMS and press  **VIEW** to read the selected message.

To edit and send again an SMS (for sent SMS)

-  Press to reach the menu list and press  **SELECT**.
 -  Scroll to **Outbox** and press  **SELECT**.
 -  Browse the list of SMS and press  **VIEW** to select the one you want to edit and send again.
 -  Press **MENU**, press  to select **Edit**.
- You can modify the text if necessary (see page 18) and press  **OK**.
-  Enter the number, press  **OK** and select **Send** or retrieve the number from the phonebook (see page 30).

To resend an Outbox message



Press to reach the menu list and press **SELECT**.



Scroll to **Outbox** and press **SELECT**.



Browse the list of SMS and press **VIEW** to select the one you want to resend.



Press **MENU**, scroll to **Resend** and press **SELECT** to start transmission.

To save a sent SMS as Draft



Press to reach the menu list and press **SELECT**.



Scroll to **Outbox** and press **SELECT**.



Browse the list of SMS and press **VIEW** to select the one you want to save as draft.



Press **MENU**, scroll to **Save as Draft** and press **SELECT** to copy the message in the draft folder.

To delete an SMS from the Outbox



Press to reach the menu list and press **SELECT**.



Scroll to **Outbox** and press **SELECT**.



Browse the list of SMS and press **VIEW** to select the one to be deleted.



Press **MENU**, scroll to **Delete** and press **SELECT**.

The selected message will then be deleted immediately.

To delete all SMS from the Outbox

This option enables you to delete all SMS in the Outbox list.



Press to reach the menu list and press **SELECT**.



Scroll to **Outbox** and press **SELECT**.



Press **MENU**, scroll to **Delete All** and press **SELECT**.

Once selected, a confirmation is required : **“Delete All!”**.



Press **SELECT** to confirm or **BACK** if you do not want to delete all your SMS list.

Draft folder

You can store up to 20 messages in the Draft folder.

To edit and send an SMS stored in the draft folder



Press to reach the menu list and press **SELECT**.



Scroll to **Draft** and press **SELECT**.



Browse the list of SMS and press **VIEW** to select the one you want to edit and send.



Press **MENU**, scroll to **Edit** and press **SELECT**.



You can modify the text if necessary (see page 18) and press **OK**.



Enter the number, press **OK** and select **Send** or retrieve the number from the phonebook (see page 30).

To delete an SMS from the Draft folder



Press to reach the menu list and press **SELECT**.



Scroll to **Draft** and press **SELECT**.



Browse the list of SMS and press **VIEW** to select the one to be deleted.



Press **MENU**, scroll to **Delete** and press **SELECT**.

The selected message will then be deleted immediately.

To delete all SMS from the Draft folder

This option enables you to delete all SMS in the Draft folder list.



Press to reach the menu list and press **SELECT**.



Scroll to **Draft** and press **SELECT**.



Browse the list of SMS and press **VIEW**.



Press **MENU**, scroll to **Delete All** and press **SELECT**.

Once selected, a confirmation is required : **“Delete All?”**.

















Press **SELECT** to confirm or **BACK** if you do not want to delete all your SMS list.

SMS settings







To set the SMS centre number(s)

The SMS are sent via a centre. To receive an SMS from another operator, you must specify the corresponding numbers.

-  Press to reach the menu list and press  **SELECT**.
-  Scroll to **SMS Settings** and press  **SELECT**.
-  Choose an SMS centre and press  **SELECT**.
-  Press to select **Outgoing Nr.** and press  **SELECT**.
-  Enter the number (up to 24 digits) and press  **OK**.
-  Scroll to **Incoming Nr.** and press  **SELECT**.
-  Enter the number (up to 24 digits) and press  **OK**.

To set the default SMS center

The SMS center number 1 is the default center. If you wish to send your SMS through another SMS center, you must have specified the corresponding numbers (see above **To set the SMS centre number(s)**) and selected the corresponding SMS center.

-  Press to reach the menu list and press  **SELECT**.
-  Scroll to **Default Center** and press  **SELECT**.
-  Choose an SMS center and press  **SELECT**.



Clock & Alarm

Date & Time









Alarm

Alarm Tone

Date & Time

To set the date and time (of the handset and base station)

After setting, the date and time are shown in idle mode.









-  Press to reach the menu list.
-  Scroll to **Clock & Alarm** and press  **SELECT**.
-  Press to select **Date & Time**.
-  Enter the current time (HH:MM).
-  Enter the current date (DD/MM).
-  Press  **SELECT** to confirm.



Warning : If your phone is connected to an ISDN line through an adaptor, the date & time may be updated after each call. Please check the date & time settings in your ISDN system. Please contact your network provider (see FAQ page 52).

Alarm

To set the alarm clock ON/OFF

By default the alarm is off.

-  Press to reach the menu list.
-  Scroll to **Clock & Alarm** and press  **SELECT**.
-  Scroll to **Alarm** and press  **SELECT**.
-  Browse through the options **Off**, **On Once**, **On Daily** and select  the appropriate setting.
- If you select **On Once** or **On Daily** :
-  Enter the time and press  **SELECT**.

When the alarm is set to **On Once** or **On Daily**, an alarm icon  is shown in idle mode in the display headline. The alarm tone rings for 1 minute at the most. Press  **STOP** or any key to switch off the alarm and return in idle mode.

To set the alarm tone

Three alarm tones are available.



Press to reach the menu list.



Scroll to **Clock & Alarm** and press  **SELECT**.



Scroll to **Alarm Tone** and press  **SELECT**.

The current alarm tone is heard.



Browse through the list of alarm tones to hear them and press  to **SELECT** the appropriate one.



Phonebook

New Entry
List Entry
Edit Entry
Delete Entry
Delete All

50 names and numbers can be stored in the phonebook of the handset.
The phonebook contains all the information related to the callers.

Group ring tone

All available ring tone melodies can be selected as group ring tones. When ringing, the ring tone helps you identify the caller's group and the screen shows the caller's name. A subscription to the Caller Line identification is necessary.

New Entry

The names are stored in alphabetical order.

To enter a new entry in the phonebook



Press to reach the menu list.



Scroll to **Phonebook** and press **SELECT**.



Press to select **New Entry**.



Enter the name (see page 18 "Editing system") and press **OK**.



Enter the number and press **OK**.



Browse through the list to hear the ring tones and select your chosen group ring tone for this entry : **No Group** or **Group A, B, C**.

To store a number from predial in the phonebook



Dial the number.



Press **SAVE** to enter the options.



Enter the name and press **OK**.



The number is automatically inserted in the number field, press **OK**.



Browse through the list to hear the ring tones and select your chosen group ring tone for this entry : **No Group** or **Group A, B, C**.

To store a number from redial list in the phonebook



Press to reach the redial list.



Browse through the redial list to select the wanted number.



Press to access the menu.



Scroll to **Copy to Phbk** and press **SELECT**.



Enter the name (see page 18, "Editing system") and press **OK**.

The number is automatically inserted in the number field, press **OK**.



Browse through the list to hear the ring tones and select your chosen group ring tone for this entry.

To store a number from call log in the phonebook



Press to reach the call log list.



Press to select **Call log**.



Browse through the call log list to select the wanted number and press **OK**.



Press to select **Copy to Phbk**.



Enter the name (see page 18 "Editing system") and press **OK**.

The number is automatically inserted in the number field, press **OK**.



Browse through the list to hear the ring tones and select your chosen group ring tone for this entry.

View

There are two possibilities of accessing the phonebook list :

- from the Phonebook menu by selecting the sub-menu **List Entry**

- from the idle mode or, when the line is connected by pressing the **RSK** **PHBK**.

The names are listed in alphabetical order. The letter (A, B or C) on the right of the name indicates that a group ring tone has been assigned to this person.

Navigation in the phonebook

To navigate in the phonebook you can :

- either press the Up or Down navigation keys to reach the previous or next entry and

press **VIEW** to see the details.

- or enter the first letter of the wanted name (e.g., 3 for "D" or 33 for "E"). The first entry starting with this letter is selected in the list. Press **VIEW** to see the details.

To call



Press **RSK** to reach the list of names directly.

Browse through the list of names and select a name.

Make the call.

Note : A phonebook number can also be retrieved when the line is connected. In that case, viewing the details is not possible. Select the entry and press  to dial the number immediately.





To send an SMS from the phonebook



Press to reach the menu list and press  **SELECT**.

Select **Write a SMS** option and press  **SELECT**.

Enter the text and press  **OK** (see page 18).

Note : To delete a wrong character press  **CLEAR**. You can delete and change any character by simply moving the cursor to the left  or to the right  to reach the character and pressing on  **CLEAR** once.

If you enter more than 640 characters for an SMS you will hear an error beep.

Press **LSK**  **PHBK** and scroll  to retrieve the number from the **Phonebook list**.

Press **SELECT**, to check the number and press  **OK**.

Select **Send** to send the SMS immediately otherwise,

if you want to store your SMS, scroll to **Save as Draft** and press  **SELECT**.
The stored SMS can be later retrieved from the **Draft** folder.

To edit an entry



Press to reach the menu list.



Scroll to **Phonebook** and press **SELECT**.



Scroll to **Edit Entry** and press **SELECT**.



Browse through the list of names and press **SELECT**.



Press **CLEAR** to delete character by character.



Enter the new name (see page 18, "Editing system") and press **OK**.



Press **CLEAR** to delete digit by digit.



Enter the new number and press **OK**.



Browse through the list to hear the ring tones and select your chosen group ring tone for this entry.

Note : If, for example, only the number is to be changed, press **OK** until the number is shown on the display and modify it.

To delete an entry



Press to reach the menu list.



Scroll to **Phonebook** and press **SELECT**.



Scroll to **Delete Entry** and press **SELECT**.



Browse through the list of names.



Press **SELECT** to delete the selected entry.

To delete whole phonebook list



Press to reach the menu list.



Scroll to **Phonebook** and press **SELECT**.



Scroll to **Delete All** and press **SELECT**.

Once selected, a confirmation is required : "**Delete All ?**".



Press **SELECT** to confirm deletion of the complete phonebook list.

Call log

The call log can store up to 20 entries and shows the list of outgoing calls.

If you have subscribed to the Caller Line Identification (CLI), you also will have the incoming calls in the list. In this case, the name (or number) of the callers will be displayed. The date & time of the call are also shown. If you have no subscription, the display shows “Unknown caller” as well as the date & time of the call.

The calls (made, missed and received) are displayed in chronological order with the most recent ones at the top of the list. When the call log is empty, the screen displays “List empty”.

To view the call log

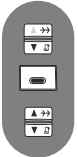

Press to view the call log details directly.

Press **SELECT** to select **Call log**.

Browse through the call log entries and read the information.

Note : The word “New” on the right of the entry number indicates the caller’s information has not been read.

To call / redial

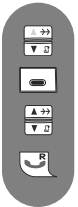

Press to view the call log detail directly.

Press **SELECT** to select **Call log**.

Scroll to select a call log entry.

Press to call.

Note : To be able to call back a caller in the case of an incoming call, you need to subscribe to the Caller Line Identification service.

To store a number from call log in the phonebook

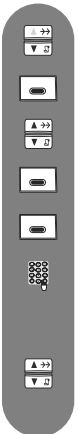

Press to view the call log details directly.

Press **SELECT** to select **Call log**.

Browse through the list of details to view the wanted entry.

Press **MENU** to access the menu.

Select **Copy to Phbk**.

Enter the name (see page 18, “Editing system”) and press  **OK**.

The number is automatically inserted in the number field, press  **OK**.

Browse through the list to hear the ring tones and select  your chosen group ring tone for this entry.

To delete a name or a number



Press to directly reach the call log.



Press **SELECT** to select **Call log**.



Browse to view the wanted entry.



Press **MENU** to access the menu.



Scroll to **Delete** and press  **OK**.

A confirmation tone is heard and the screen will show the call log again.

To delete all call log entries



Press to directly reach the call log.



Press **SELECT** to select **Call log**.



Press **MENU** to access the menu.



Scroll to **Delete All** and press  **OK**.



Press  **OK** to confirm deletion of the complete call log list.

A confirmation tone is heard and then the phone returns to the idle mode.

Redial list

The last 20 dialed numbers are stored in the redial list.

The dialed numbers (or names, if the numbers match the phonebook entries) are displayed in chronological order with the most recent at the top of the list. When the redial list is empty the screen displays “List empty”.

To view the redial list



Press to directly reach the redial list in idle mode.



Browse through the list.

To view the details of a selected redial number :



Press  **MENU**.



Choose  **VIEW**.



Press the Up or Down navigation key to view the details of the previous or next record.

To call / redial



Press to directly reach the redial list in idle mode.



Browse through the redial list to select the wanted number.



Press to call.

To store a number from redial in the phonebook



Press to directly reach the redial list.



Browse through the redial list to select the wanted number.



Press to select **MENU**.



Scroll to **Copy to PhBk** and press  **SELECT**.



Enter the name (see page 18, “Editing system”) and press  **OK**.

The number is automatically inserted in the number field, press  **OK**.



Browse through the list to hear the ring tones and select  your chosen group ring tone for this entry.

To delete a name or a number from redial list



Press to directly reach the redial list.



Browse through the redial list to select a record.



Press to select **MENU**.



Scroll to **Delete** and press  **SELECT**.
Then the screen will show the redial list again.

To delete whole redial list



Press to directly reach the redial list.



Press to select **MENU**.



Scroll to **Delete All ?** and press  **SELECT**.



Press  **OK** to confirm deletion of the complete redial list.
“List Empty” will be shown and then the phone returns to the idle mode.

Using the Intercom (if there are at least 2 handsets, see page 17)

This feature allows you to make free internal calls, transfer external calls from one handset to another and use the conference option.

Internal call



Press in the idle mode.



Enter the number of the handset you want to call or press  **ALL**.



Hang up or put the phone in the cradle to terminate the internal call.

Note : *If the handset does not belong to the Philips DECT 623/627 range, this function may not be available.*

Incoming external call during an intercom call



Press to accept the external call and put the internal call on hold.

OR



Hang up the current internal call and then



press to accept the incoming external call.

Call transfer to a specific handset when on line



Press to put the external call on hold, the caller can no longer hear you.



Enter the number of the handset you want to transfer the call to.

The called handset rings.

Note : *If there is no answer from the called handset, you can resume the call on the first handset.*

If the called handset takes the line, both internal callers can talk.



Press to end the call on the first handset and to transfer the external call to the other handset.

Note : *To answer the call on the second handset, you can press .*

Switch between internal and external call



Press to put the external call on hold, the caller can no longer hear you.



Enter the number of the handset you want to transfer the call to.

The called handset rings.

Note: *If there is no answer from the called handset, you can resume the call on the first handset.*

If the called handset takes the line, both internal callers can talk.



Press to toggle between the external and internal call.

Conference call via the in-call options

Conference call allows one external call to be shared with two handsets (in intercom). The 3 people can share the conversation. No operator subscription is needed.



Press to put the external call on hold, the caller can no longer hear you.

Enter the number of the handset you want to call.

The called handset rings.

Note : *If there is no answer from the called handset, you can resume the call on the first handset.*

If the called handset takes the line, both internal callers can talk.



Press  **CONF** to start a 3-party conference.

The 3 people can share the conversation.



Personalize

Wallpaper
 Contrast
 Handset Tones
 Handset name
 Auto Answer
 Language



Wallpaper

This feature allows you to specify the wallpaper that is displayed in idle mode. There are 4 wallpapers pre-installed in your phone.

To specify a wallpaper



Press to reach the menu list.



Scroll to **Personalize** and press **SELECT**.



Press to select **Wallpaper**. *The currently selected wall paper is shown.*



Scroll to view the wallpaper pictures and press to **SELECT** your chosen wallpaper.

Contrast

Three display contrast levels are available.

To set the display contrast



Press to reach the menu list.



Scroll to **Personalize** and press **SELECT**.



Scroll to **Contrast** and press **SELECT**.

The currently selected contrast level is highlighted.



Browse through the contrast levels to see the difference and press to **SELECT** the appropriate one.

Handset Tones

To set the handset ring volume or silence mode

Three ring volume levels and Ring Off (silence) are available.



Press to reach the menu list.



Scroll to **Personalize** and press **SELECT**.



Scroll to **Handset Tones** and press **SELECT**.



Press to select **HS Ring Volume**. *The current level is heard.*



Browse through the levels to hear them and press to **SELECT** the appropriate one.

Note :When **Ring Off** is selected, this icon is shown in the idle mode.

To set the handset ring tone

To select the ring melody from the choices available.



Press to reach the menu list.

Scroll to **Personalize** and press  **SELECT**.

Scroll to **Handset Tones** and press  **SELECT**.

Scroll to **HS Ringtone** and press  **SELECT**.

The current melody is heard.

Browse through the list of melodies to hear them and press  to **SELECT** the appropriate one.

To set the group ring tones

This menu enables you to select and set the melodies to be played in case of an external incoming call with CLI enabled and when the number is known in the phonebook and set as a group. There are 3 groups of caller (see page 28, **Phonebook, Group ring tones**). You can associate 1 ring tone to each group (A, B, C).





Press to reach the menu list.

Scroll to **Personalize** and press  **SELECT**.

Scroll to **Handset Tones** and press  **SELECT**.

Scroll to **Group Melody** and press  **SELECT**.

Scroll through the 3 different groups and select  one.

Browse through the list of melodies to hear them and press  to **SELECT** the appropriate one.

To activate / deactivate the key tone

By default the key tone is ON. You can deactivate it.



Press to reach the menu list.

Scroll to **Personalize** and press  **SELECT**.

Scroll to **Handset Tones** and press  **SELECT**.

Scroll to **Key Tone** and press  **SELECT**.

Select **On** or **Off** and press  **SELECT** to confirm.

To activate / deactivate the SMS tone

Allows you to determine whether there is an alert beep each time you receive a new message. By default the SMS tone is ON. You can deactivate it.



Press to reach the menu list.

Scroll to **Personalize** and press **SELECT**.

Scroll to **Handset Tones** and press **SELECT**.

Scroll to **SMS Tone** and press **SELECT**.

Select **On** or **Off** and press **SELECT** to confirm.

Handset name

To rename a handset

You can rename your handset and display the name in idle mode. By default the handset name is "PHILIPS".



Press to reach the menu list.

Scroll to **Personalize** and press **SELECT**.

Scroll to **Handset Name** and press **SELECT**.

Enter the new handset name (see page 18).

Press **OK** to confirm the new name.

Auto Answer

To activate / deactivate the auto answer mode

Allows you to set **Auto Answer ON** or **OFF**. If **ON**, you can answer a call by simply lifting the handset from the charging cradle. The default setting is **Auto Answer Off**.



Press to reach the menu list.

Scroll to **Personalize** and press **SELECT**.

Scroll to **Auto Answer** and press **SELECT**.

Select **On** or **Off** and press **SELECT**.

Language

To change the language

Your phone supports different languages for the menus.



Press to reach the menu list.

Scroll to **Personalize** and press **SELECT**.

Scroll to **Language** and press **SELECT**.

Browse through the list of languages and press **SELECT**.



Adv. Settings

Dial Mode
Flash Time
Voice Lang.
Security
Registration
Unregistration
Reset

Dial Mode

To change the dial mode

By default your phone is pre-configured with the country dependent settings and you do not have to change them.



Press to reach the menu list.

Scroll to **Adv. Settings** and press **SELECT**.

Press to select **Dial Mode**.

Browse to select **Tone** or **Pulse** and press **SELECT**.

Note : This setting allows you to select pulse dialling (also called “Loop disconnect” which is used in countries without DTMF tone dialling capability or when using old PABX).

Flash Time

To change the flash time

This setting is useful when using operator services.



Press to reach the menu list.

Scroll to **Adv. Settings** and press **SELECT**.

Scroll to **Flash Time** and press **SELECT**.

Browse to select **Short** or **Medium** or **Long** and press **SELECT**.

Note : The use of some operator services accessed with + , + and + (call waiting, call forward ...) will depend on the flash setting according to your installation type (ISDN, Public, PABX).

Voice Language

only available for DECT 627

To set the voice language

You can change the language of the answer machine for the predefined outgoing messages (see page 47).



Press to reach the menu list.



Scroll to **Adv. Settings** and press **SELECT**.



Scroll to **Voice Lang.** and press **SELECT**.



Choose the appropriate language in the list and press **SELECT**.

Security

To change the PIN code

The default code is the registration code “0000”. We advise you to personalize it.



Press to reach the menu list.



Scroll to **Adv. Settings** and press **SELECT**.



Scroll to **Security** and press **SELECT**.



Press to select **Change PIN**.



Enter your PIN code and press **OK**.

Note : If you have already changed the PIN code, you will be prompted to enter this new PIN code before changing it again.

To set or change Call Barring

This menu allows you to limit the use of your phone to specific calls by letting you bar parts (prefix) of outgoing phone numbers. You can set 4 different barring numbers.



Press to reach the menu list.



Scroll to **Adv. Settings** and press **SELECT**.



Scroll to **Security** and press **SELECT**.



Scroll to **Call Barring** and press **SELECT**.



Enter your PIN code and press **OK**.



Browse to select the barring **Number 1, 2, 3 or 4** to be changed and press **SELECT**.



Enter the barring number (e.g. 00 to bar international calls) and press **OK**. Repeat the last 2 steps to enter or change further call barring numbers.

Registration

Up to 5 handsets can be registered to the base station.

Warning : If you wish to register non Philips handsets to the DECT 623 or DECT 627 base station, make sure that this handset is GAP compliant otherwise it will not operate properly (see page 11).

To register a handset

If you have inadvertently unregistered your handset, you can register it again. Additional handsets must be registered to the base before use.

To register a handset, first press the paging key  on the base for approx. 5 seconds when the base is in idle mode. Then carry out the following steps on the handset within one minute :



Press  to reach the menu list.

Scroll to **Adv. Settings** and press  **SELECT**.

Scroll to **Registration** and press  **SELECT**.

Enter the 4-digit PIN code (by default "0000") and press  **OK**.

If the registration was successful, a long confirmation tone is heard and the handset number (1 to 5) will be assigned by the base automatically.

To unregister a handset



Press  to reach the menu list.

Scroll to **Adv. Settings** and press  **SELECT**.

Scroll to **Unregistration** and press  **SELECT**.

Choose the handset to unregister from the list and press  **SELECT**.

Note : If you have your handset serviced, please make sure it is unregistered from the base station before taking it back to the repair centre.

To reset to default settings

You can reset your phone to the default settings (see page 51) at any time. **Note that after a reset all your personal settings and saved data (phonebook entries, SMS messages, call log and redial list) will be deleted.**



Press  to reach the menu list.

Scroll to **Adv. Settings** and press  **SELECT**.

Scroll to **Reset** and press  **SELECT**.

Select **Yes** to reset your phone and press  **SELECT**.

Note : After a reset you need to reconfigure your phone, refer to page 40.



Net Service

Call Forward
 Call Fwd Busy
 Call Fwrd UnAns
 Voice Mail
 Call Back
 Withhold ID

This feature allows you to activate or deactivate operator services that are subscription dependent. Contact your network operator for more information on the services. You can usually subscribe to Call forward, operator voice mailbox etc ...

Example of service : Call forward

Calls can be redirected to another phone number.



Press to reach the menu list.

Scroll to **Net. Service** and press **SELECT**.

Browse through the list of services and press **SELECT**.

Scroll to **Setting** and press **SELECT**.

Enter or retrieve from the phonebook the number to which the calls are to be forwarded and press **OK**.

The number is automatically chained to the call forward prefix and the phone dials the number.

Hang up.

To activate / deactivate Services



Press to reach the menu list.

Scroll to **Net. Service** and press **SELECT**.

Browse through the list of services and press **SELECT**.

Select **Activate** or **Deactivate** and press **SELECT**.

The dialling number string for that selected service will be dialled out.

Press to return to the idle mode.

Answer machine DECT 627

The DECT 627 includes an answer machine that records unanswered calls when it is activated.

The answer machine can store up to 99 messages within the maximum recording time of 14 minutes.



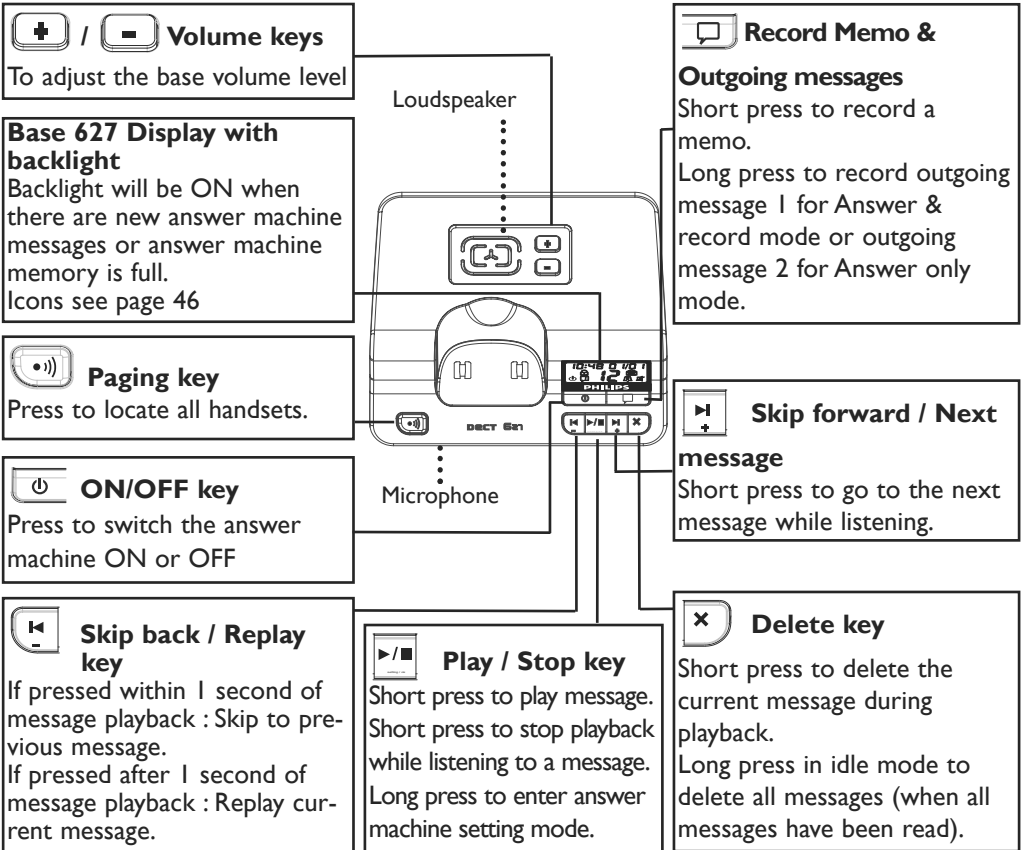





DECT 627 answer machine keys



DECT 627 answer machine display

The display of the DECT 627 answer machine gives information about the answer machine and the settings. The date and time setting of the base is done simultaneously when setting date & time on the handset (see page 26).



-  The Remote access code is activated.
-  New unread message(s) on answer machine.
-  Old message(s) on answer machine, already read.
-  The answer machine is ON.
-  Indicates the type of outgoing message.
-  Indicates the number of rings before the answer machine will start playing the outgoing message.
-  Call screening ON
-  Call screening OFF

To switch the DECT 627 Telephone Answer Machine ON/OFF

 Press ON/OFF key on the base to switch the answer machine ON or OFF.

When it is switched ON, the selected outgoing message is automatically played. The answer machine display backlight will also be lighted if there is (are) one or more new unread message(s).

When the answering machine is ON, it will answer the call after a certain number of rings depending on the setting (see page 48). After answering the call, the answering machine will play your welcome message and record the message left by the caller, if any.

Saved messages

To listen to new message(s)

The LCD backlight is ON and the base display shows that there is one or more new message(s) : 3 .

 Press to start playback.

Messages are always played in chronological order, the oldest new message first.

The message counter and the date and time of recording will be shown on the display.

During message playback, the following functions are available :

 Press to skip forward to the next message.

 Press to skip back to the previous message or replay current message.

 Press to stop playback and press again to continue playback.

Note : *If there is no more memory keep, two bars on the display will kept flashing and the base LCD backlight will be ON continuously. Delete old messages (see page 47) to free space for the new one.*

Volume adjustment

During message playback and call screening you can adjust the loudspeaker volume by using the keys on the rear of the base:



Press to increase the loudspeaker volume.

Press to decrease the loudspeaker volume.

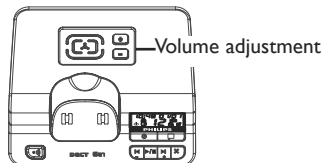

Delete answer machine messages

To delete an answer machine message



Press to delete while listening to a message.

A short beep confirms deletion of the message.

To delete all answer machine messages

Deletion of all messages is only possible in the idle mode and when there are no new unread messages :



Press and hold to delete all old messages.

A long beep confirms deletion of all old messages. Then the answer machine display shows "00" without the envelope icon.

Note : Deleted messages can not be recovered. If there is no more memory left, two bars on the display will keep flashing and the base LCD backlight will be ON continuously.

Answer machine settings

In the answer machine setting sequence the following items can be modified one after the other in the fixed order (all settings must be done in a row) :

1. Outgoing message selection (1/2)
2. Ring delay (1 - 7)
3. Call screening (ON/OFF)
4. Remote access code

Sequence 1 : To select the answer mode and the outgoing message type

The answering machine announces the outgoing message when it answers the call. There are 2 default outgoing messages :

Outgoing message 1 Answer & Record (when messages can be left).

Outgoing message 2 Answer only (when no messages can be left)



The voice language of the predefined outgoing messages can be changed (see page 42).

You can also record your own outgoing message 1 and outgoing message 2 (see page 49).



Press to switch the answer machine ON.

To enter the answer machine setting mode :

Press for approx. 4 seconds, until the outgoing message icon  flashes and all other icons except power  are cleared.



Press **+** or



- to switch between outgoing message 1 or 2.

The current outgoing message number will be shown inside the icon



Press to confirm the selected outgoing message and then proceed to the next setting.

Note : if you do not wish to change the outgoing message type, press (key on the base station).

Sequence 2 :To set the number of rings before answering

You can set the answer machine to start playing the outgoing message after a given number of rings (1 - 7 rings or Economy mode \$). The economy mode (activated by default) is useful when using the remote access. The answer machine will start playing the outgoing message after 3 rings if there are new messages. If there is no new message, the outgoing message will be played after 5 rings. Hang up after the 4th ring if you want to check if you have any messages at no cost.

After having confirmed the outgoing message type (see above), you may select ring delay. The ring delay icon will flash and all other icons except power will be cleared.



Press **+** or



- to select the wanted ring delay : **1, 2, 3, 4, 5, 6, 7** or **\$** (economy mode).

The currently selected number of ring delays will be shown inside the icon



Press to confirm the selected number of ring delays and then proceed to the next setting.

Note : if you do not wish to change the number of rings before answering, press (key on the base station).

Sequence 3 :To activate / deactivate call screening on the base

You can activate or deactivate the call screening on the base loudspeaker; i.e. choose whether you want to hear the message being left by your callers or not. By default the function is activated.

After having confirmed the number of ring delays (see above), you may select call screening ON or OFF.

The loudspeaker icon will flash and all other icons except power will be cleared.



Press **+** or



- to select call screening ON or OFF.

If call screening OFF has been selected the loudspeaker icon will be crossed through .



Press to confirm the selected call screening setting and then proceed to the next setting.

Note : if you do not wish to change the call screening setting, press (key on the base station).

Sequence 4 :To change the remote control access code

The remote control access code is needed to remotely control your answer machine and to prevent unauthorized access of the answer machine from external callers.

Warning ! If the setting of the remote access code is 00 (as by default), the remote control access is disabled.

After having confirmed the call screening setting (see page 48), you may change the remote control access code.

The first digit of the access code and the lock icon  will flash.



Press **+** to increase or



- to decrease the first digit of the remote control code.



Press to confirm.

The first digit will stop flashing and the second digit will flash.



Press **+** to increase or



- to decrease the second digit of the remote control code.



Press to confirm.

Then all the settings will be finished and the display will return to the idle mode.

Note : if you do not wish to change the remote control access code, press  (key on the base station).

Personal outgoing messages

You can record 2 different personal outgoing messages : a specific personal welcome message 1 for Answer & record mode and a specific personal welcome message 2 for Only answer mode. The personal outgoing messages will replace the default ones. If you delete your personalized welcome message, the default welcome message will automatically be restored.

The maximum recording time for a welcome message is 60 seconds. You do not need to delete your previously recorded welcome message to record a new one. Once you record a new welcome message, the old one will be overwritten.

To record your personal outgoing message

To record welcome message 1 for Answer & record mode, first check if welcome message 1 is selected as the answer machine setting (see page 47).

OR

To record welcome message 2 for Only answer mode, first check if welcome message 2 is selected as the answer machine setting (see page 47).



Long press (for approx 4 seconds) until a long beep is heard to indicate that you can start recording.

Speak into the microphone of the base station after the beep.



Press to stop recording.

A long beep confirms successful recording and the recorded message will playback automatically for review.

Note : If you are not satisfied with the recorded outgoing message, repeat the above steps and the old welcome message will be overwritten. Play it and delete it to restore the default outgoing message, or record a new welcome message overwriting the previous one. If you want to have the default outgoing message back, see “To delete personal outgoing message”, page 50.

To play back personal or default outgoing message

To play back outgoing message 1, first check if outgoing message 1 is selected as the answer machine setting (see page 47).

OR

To playback outgoing message 2, first check if outgoing message 2 is selected as the answer machine setting (see page 47).

Turn the answer machine off.

Turn the answer machine on again.

When it is switched ON, the selected outgoing message is automatically played.

Note: *The voice language of the predefined outgoing messages can be changed (see page 42).*

To delete personal outgoing message

To delete outgoing message 1, first check if outgoing message 1 is selected as the answer machine setting (see page 47).

OR

To delete outgoing message 2, first check if outgoing message 2 is selected as the answer machine setting (see page 47).

Turn the answer machine off.

Turn the answer machine on again.

When it is switched ON, the selected outgoing message is automatically played.

Press to delete the personal outgoing message during playback and to restore the default outgoing message.

Note : *The default outgoing messages cannot be deleted.*

Record and listen to a memo

This feature allows you to leave local messages for your family on the answer machine. The maximum recording time for a memo is 180 seconds.

To record a memo

Press until a long beep is heard to indicate that you can start recording.

Speak into the microphone of the base station after the beep.

Press to stop recording.

A long beep confirms the memo was successfully recorded. The LCD backlight turns ON and the base display shows that there is one new message : 1 .

To listen to a memo

The LCD backlight is ON and the base display shows that there is one new message : 1 .

Press to start playback.

The message counter and the date and time of recording will be shown on the display.

To remotely control your answer machine

Warning : The remote control access is only possible if the remote access code is NOT the default (00 = Remote access OFF), see page 49.

You can access your answering machine when you are away by using any tone dialling phone.

To remotely control your answer machine

To remotely access your answer machine :

- dial home from another phone.
- If your answer machine is ON, press the star (*) key on the external phone during or after the outgoing message ; if your answer machine is OFF, you will hear a beep after 10 rings, then press the star (*) key.
- Dial your remote control code (not 00) and press # to confirm.
- if you have new messages, they will be automatically played after the beep.

The following table indicates the features available when remotely accessing the answer machine.

Answer machine ON/OFF	dial 0
Play previous message	dial 1
Play message / Stop	dial 2
Play next message	dial 3
Delete	dial 4

Default settings

Handset Ringer volume :	Level 2	Phonebook memory :	Empty
Handset Ringtone :	Melody 1	SMS Inbox, Outbox, Draft :	Empty
Group A melody :	Melody 1	Call log :	Empty
Group B melody :	Melody 2	Redial list :	Empty
Group C melody :	Melody 3		
Handset earpiece volume :	Level 3		
Handset speaker volume :	Level 3		
Handset key tone :	ON		
SMS tone :	ON		
Battery low tone :	ON		
Menu language (Handset) :	Country dependent		
Auto answer :	OFF		
Wallpaper :	Wallpaper 1		
Handset name :	PHILIPS		
Time/Date (Handset) :	00:00 01-01-2005		
Dialling mode :	Country dependent		
Flash time :	Country dependent		
PIN code Handset :	0000		
Only DECT 627 :			
Remote access code:	00, Remote access OFF		
Voice language outgoing message :	Country dependent		

1/ I have no dialling tone after having installed my phone. How do I solve this problem?

Check that you have connected your phone using the supplied telephone line cable and not the one from any previous phone (they are often wired differently).

Check that you have fully charged the handset according to the instructions given for the phone.

Check that the aerial icon (radio link with the base station) is displayed. If the handset is not registered you may need to register it (see page 43).

2/ Can the handset be left on the base all the time?

Yes there is no "memory effect". The handset can be left on the base station for all current models using NiMh batteries.

3/ Will my phone lose all recorded data (phonebook entries, recorded messages) in the case of a general power cut?

No it will not. The data recorded in your phone is not deleted in the case of a general power failure or when you unplug your base station or when you replace the batteries.

4/ I have set up the date & time on my phone and the information given after a call is not correct. Why?

If you have an ISDN phone installation, these parameters (date & time) may be transferred directly through the ISDN to the phone. If you did not set up the ISDN correctly, this could explain why the information transmitted is not correct. Set up the date & time directly on the ISDN phone installation or, if this is not possible, call the network operator/dealer who provided and installed the ISDN.

5/ I cannot use the answering machine of my Philips phone together with my Fax. Both are plugged into the same line. Why is this? (DECT 627 only)

To avoid this, it is recommended to set up the number of rings before the answering machine switches on.

Example: if the network mail box or a fax is set to answer the calls after 4 rings, please set up your answering machine on 3 rings. To set up the number of rings, please see page 48.

6/ What is CLI and how do I make it work?

CLI stands for Caller Line Identification and it is a special service that you may subscribe to from your network operator. Once you have subscribed to the service, a CLI enabled phone will display the callers number (unless withheld) when the phone rings so that you may decide whether or not to take the call.

7/ The CLI service does not work on my Philips phone, on my digital phone installation (ISDN, ADSL). How do I solve this problem?

Our products are designed to work on an analogue network. If you plugged your PHILIPS phone into a digital installation, the CLI may not be displayed upon incoming calls. Digital phone installations (ISDN) are not always compatible with analogue phones as far as operator services are concerned.

You may find the information regarding compatibility in the user guide of your ISDN. If not, please contact the ISDN manufacturer to check if the device is designed to display CLI on analogue phones. ISDN over 2 or 3 years old may not be compatible with analogue phones for the CLI Service.

Note that the filters used with some ADSL lines can filter out part of the CLI signal and prevent the phone from displaying CLI correctly. It is possible to purchase better ADSL filters that do not cause this problem.

8/ What is CNIP (Caller Name Identification)?

As with the CLI service, this new feature is dependent on the Network and it has to be activated by your network operator (by subscription). It will allow you to have the name of the caller displayed upon an incoming call.

This service may not be available from all operators yet. We advise you to check with your operator.

N.B. If the name of the caller is registered in your phonebook upon an incoming call it will be the name you have registered which will be displayed and not the one provided by the operator. The data in your phonebook will have priority over the operator's data in this particular case.

The CNIP uses the same technology as for the CLI. Therefore the limits of this service are identical (please refer to the questions related to CLI if the service is not working properly). Remember that it only works with alphanumeric display.

9/ How many telephones can I have?

All items of telephone equipment have Ringtone Equivalence Number (REN), which is used to calculate the number of items which may be connected to any one telephone line.

Your DECT 623/627 has a REN of 1. A total REN of 4 is allowed, if the total REN of 4 is exceeded, the telephones may not ring.

With different telephone types there is no guarantee of ringing, even when the REN is less than 4.

10/ My answering machine does not record the messages left by my callers. How do I solve this problem?

Check the operator voice mail box is not activated. If it is activated, set the answering machine so that it starts recording first (set up the number of rings before the answering machine switches on).

11/ Which are the conditions required to be able to send an SMS ?

You must first have a subscription to Caller Display (CLI) service from your network operator as well as an SMS service subscription from the appropriate provider.

12/ Is it possible to write, read send or receive an SMS when the other handset is in use (DECT 623 and DECT 627 multi-handset packs only)?

No it is not possible.

13/ What happens if I send an SMS to a fixed line with no SMS phone ?

The person could receive a voice message (SMS provider dependent).

14/ Is it possible to send an SMS to a fixed line in another country ?

This feature depends on your provider. Please contact your provider for more details.



15/ How can I get the SMS centre number ?

At least one SMS centre number is pre-programmed in your DECT 623/DECT 627. However, should you need to store another number, other numbers can be set via the menu **SMS/SMS Settings/SMS Center**. Please check the incoming and outgoing centre numbers with the SMS provider or from the enclosed addendum to your phone user manual.

16/ When using my SMS-enabled Philips phone with another SMS-enabled phone on the same line, can it cause any problems ?

Yes, this will prevent the phones from receiving SMS messages. You need to deactivate the SMS feature on one of the phones.

Telephone troubleshooting

PROBLEMS	CAUSES	SOLUTIONS
The icon  does not scroll when the handset is placed on the base	<ul style="list-style-type: none"> - Bad battery contact - Dirty contact - Battery is full 	<ul style="list-style-type: none"> - Move the handset slightly - Clean the contact with a cloth moistened with alcohol - No need to charge
No dialling tone	<ul style="list-style-type: none"> - No power - Batteries are empty - You are too far from the base station - Wrong line cable - Line adaptor (when needed) not connected to the line cord 	<ul style="list-style-type: none"> - Check the connections. Reset the phone : unplug and plug back in the mains - Charge the batteries at least 24 hours - Move closer to the base station - Always use the line cable provided - Connect the line adaptor (when needed) to the line cord
No ring tone	<ul style="list-style-type: none"> - The ring tone is deactivated 	<ul style="list-style-type: none"> - Increase the volume (page 38)
The icon  does not appear	<ul style="list-style-type: none"> - No mains power - The handset is too far from the base station 	<ul style="list-style-type: none"> - Check connections - Move closer to the base station
The icon  is blinking	<ul style="list-style-type: none"> - Handset not registered to the base station 	<ul style="list-style-type: none"> - Register the handset to the base (page 43)
- Crackling on the line	<ul style="list-style-type: none"> - You are too far from the base station - The base station is too close to electrical appliances, reinforced concrete walls or metal doorframes 	<ul style="list-style-type: none"> - Move closer to the base station - Move the base station to find a better place (the higher the better)
The handset displays 'not available' - when attempting to add another handset to the base station - when using a handset	<ul style="list-style-type: none"> - The procedure to add a handset has failed, try again - Maximum number of handsets (5) has been reached - Base station is already busy with another handset 	<ul style="list-style-type: none"> - Disconnect and connect the base station power supply. - Remove and place back the handset battery - Follow the procedure to register a handset (page 43) - Unregister a handset - Wait until it is available
Noise interference on your radio or television	The DECT 623/627 base station or mains power pack are too close to electrical appliances	Move the power pack or base station as far away as possible
Caller Line Identification (CLI) service does not work	- The service is not activated	- Check your subscription with your network operator
A phonebook entry cannot be stored	The phonebook is full	Delete an entry to free memory

PROBLEMS	CAUSES	SOLUTIONS
No new SMS are received	<ul style="list-style-type: none"> - SMS storage space is full - Wrong SMS settings 	<ul style="list-style-type: none"> - Delete old SMS/MMS - Check SMS settings p. 25
No SMS can be sent or received	<ul style="list-style-type: none"> - The outgoing or incoming SMSC number is not set or is wrong - You have no subscription - Another SMS-enabled phone is also on your line - There is a problem of compatibility between operators - The identity is withheld 	<ul style="list-style-type: none"> - Refer to the SMS leaflet to get the correct SMSC's numbers - Contact your provider for more information - Deactivate the SMS mode on one of the device. - Contact your provider for more information - Show identity
No caller Id/ poor audio quality/Poor connection quality with broadband DSL internet	<ul style="list-style-type: none"> - DSL filter(s)/splitter missing or insufficient number of filters - Modem &/or phone plugged in the wrong DSL filter slot - Defective DSL filter(s) 	<ul style="list-style-type: none"> - Make sure you have one DSL filter plugged directly on each line socket used in the house - Check the modem and the phone are plugged in the correct filter slot (one specific for each) - The filter(s) can be defective. Replace it/them and make another test

Answer machine troubleshooting

PROBLEMS	CAUSES	SOLUTIONS
The answer machine does not record messages	<ul style="list-style-type: none"> - The memory is full - The answer only mode is activated 	<ul style="list-style-type: none"> - Delete messages - Select the Answer & record mode
The remote control access does not work	The remote control access is not activated (code 00 disable is set)	Change the remote control access code (page 49)
It is not possible to record an outgoing message	The memory is full	Delete messages
The DECT 627 hangs up during remote access	<ul style="list-style-type: none"> - Failed attempt to send a code - Duration is too long 	<ul style="list-style-type: none"> - Enter the correct code - Manage the remote control quicker
The answer machine stops automatically	<ul style="list-style-type: none"> - The memory is full - Message exceeds 180 sec 	<ul style="list-style-type: none"> - Play & delete messages - Messages must not exceed 180 sec

Index

<p>A Add new entry (phonebook) 28 Alarm clock 26 Alarm tone 27 Answer a call 1, 16 Answer machine (only DECT 627) 45 Answer machine settings 47 Auto answer 40</p> <p>B Base keys 4 Base installation 13 Batteries & battery life 13</p> <p>C Call barring 42 Call duration 16 Call forward 44 Call log 32 Call transfer 36 Call screening 48 Case mode 18 Change name (Phonebook) 31 Change number (Phonebook) 31 Clear character 19 Choose country/operator 14 Code PIN 42 Code remote access (answer machine) 49 Conference call 37 Conformity 10, 11 Contrast 38 Copy to phonebook (number from SMS) 21</p> <p>D Date and time 26 Declaration of conformity 11 Default settings 43, 51 Default SMS center 25 Define ring tone 39 Delete all (Answer machine) 47 Delete all (Call log) 33 Delete call log entry 33 Delete an entry (Phonebook) 31 Delete an SMS 22, 23, 24 Dial mode 41 Display contrast 38 Draft folder 24</p> <p>E Earpiece tone, volume 17 Edition mode 18 Edit SMS 21 Enable registration (DECT peripheral) 11, 43</p> <p>F FAQ 52, 53 Flash time 41</p> <p>G GAP 11 Group ring tones 28, 39</p> <p>H Handset keys 2 Handset ring tones 38</p> <p>I Icons 3 Idle mode 15 Inbox 21 Installing base station 13 Intercom 17, 36, 37</p> <p>K Keys handset 2 Keys answer machine (only DECT 627) 45 Key tone 39 Keypad lock/unlock 2, 14</p> <p>L Language, menus 14, 40 Line settings 41 Listening to messages (Answer machine) 46 Local message (Memo) 50</p>	<p>Loudspeaker base 4, 45 Loudspeaker handset 2, 17</p> <p>M Make calls 1, 16, 17, 30, 32, 34 Memo 50 Menu overview 7-9 Microphone handset 2 Mute 17</p> <p>N Navigation in menus 15 Network services 44 New entry, phonebook 28 Number of rings for answer machine 48</p> <p>O ON/OFF handset 14 ON/OFF answer machine 45, 46 Outbox 22 Outgoing messages 47, 49</p> <p>P PABX/PSTN 41 Paging key 4 Phonebook 28 Predial 16 Pulse (Dial mode) 41</p> <p>R Range 13 Read SMS 20 Recall type 41 Record a memo 50 Recording personal outgoing message 49 Redial 1, 16, 32, 34 Register handset 43 Remote access to answer machine 51 Remote control code (Answer machine) 49 Rename handset 40 Reply to an SMS 21 Resend message 23 Reset 43 Ring tone type (alarm) 27 Ring tone volume 38 Rings before answering (Answer machine) 48</p> <p>S Save as draft 19, 23 Screening calls 48 Security 42 Send new SMS 19 Send SMS (from Phonebook) 30 Service settings 44 Silence mode 38 SMS center and SMS settings 25 SMS tone 40 Soft key functions 9, 15 Store number in phonebook 29 Switch calls 36</p> <p>T Toll saver (Answer machine) 48 Tone (Dial mode) 41 Troubleshooting 54, 55</p> <p>U Unpacking your DECT 623/627 12 Unregister handset 43</p> <p>V View call log 32 View phonebook 29 View SMS 20 Voice language selection (only DECT 627) 42 Volume adjustment (Answer machine) 47 Volume (earpiece) 17 Volume (ring tone) 38</p> <p>W Wallpaper 15, 38</p>
---	--

© 2005

Philips Consumer Electronics

Home communication

All rights reserved

Printed in PRC

www.philips.com



GB

IRL

3 111 285 2470 1

Free Manuals Download Website

<http://myh66.com>

<http://usermanuals.us>

<http://www.somanuals.com>

<http://www.4manuals.cc>

<http://www.manual-lib.com>

<http://www.404manual.com>

<http://www.luxmanual.com>

<http://aubethermostatmanual.com>

Golf course search by state

<http://golfingnear.com>

Email search by domain

<http://emailbydomain.com>

Auto manuals search

<http://auto.somanuals.com>

TV manuals search

<http://tv.somanuals.com>