

Register your product and get support at
www.philips.com/welcome

CD560
CD565



EN User manual

PHILIPS

Philips Consumer Lifestyle
Glaslaan2
5616LW Eindhoven
The Netherlands

DECLARATION OF CONFORMITY

We,

Philips Consumer Lifestyle
Glaslaan2
5616LW Eindhoven
The Netherlands

Declare that product models CD 560 & CD 565 (telecommunications terminal equipments) manufactured in China are in compliance with ANNEX IV of the R&TTE-Directive 1999/5/EC and then with the following essential requirements:

Article 3.1 a: (protection of the health & the safety of the user)

Safety:	EN 60950-1(2006)
SAR:	EN50360/EN50361:2001

Article 3.1 b: (protection requirements with respect to electromagnetic compatibility)

EMC:	ETSI EN 301 489-1 V1.6.1 (2005) & ETSI EN 301 489-6 V1.2.1 (2002)
------	---

Article 3.2: (effective use of the radio spectrum)

Radio:	EN 301 406 V1.5.1 (2003)
--------	--------------------------

The presumption of conformity with the essential requirements regarding Council Directive 1999/5/EC is ensured.

Product is labelled with the European approval marking CE and the number of the Notified Body as follows:

CE0168

Date : 27/04/2009, Eindhoven

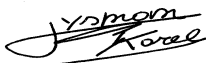

Karel RYSMAN
Approbation manager
Audio Video & Communication

Contents

1 Important	5
Safety instructions	5
2 Your CD560/CD565	8
What is in the box	8
Overview of the phone	9
Overview of the base station	10
Display icons	11
3 Get started	12
Connect the base station	12
Connect the charger	13
Wallmount the base station	13
Install the handset	14
Check the battery level	14
Set the country	14
Set the date and time	14
Set the date and time format	15
What is standby mode?	15
Check the signal strength	15
Switch your handset On/Off	15
4 Calls	16
Make a call	16
End a call	17
Answer a call	17
Adjust the earpiece volume	17
Mute the microphone	17
Turn the speaker on or off	17
Make a second call	17
Answer a second call	17
Toggle between two calls	18
Make a conference call	18
5 Intercom and conference calls	19
Make a call to another handset	19
Transfer a call	19
Make a conference call	19
6 Text and numbers	21
Enter text and numbers	21
Switch between uppercase and lowercase	21
7 Phonebook	22
View the phonebook	22
Search a record	22
Access the phonebook during a call	22
Call from the phonebook	22
Add a record	22
Set the melody	23
Edit a record	23
Delete a record	23
Delete all records	23
8 Call log	24
View the call records	24
Return a call	24
Save a call record to the phonebook	24
Delete a call record	24
Delete all call records	24
9 Redial list	25
View the redial records	25
Redial a call	25
Save a redial record to the phonebook	25
Delete a redial record	25
Delete all redial records	25
10 Self-defined settings	26
Personalize the phone display	26
Personalize the sounds	26
11 Call features	28
Auto hang up	28
Auto conference	28
Dial mode	28
Select the recall duration	28
Auto prefix	29
First ring	29
ECO mode	29

12 Extra features	30
Alarm clock	30
Auto clock	30
Keypad lock	31
Locate the handset	31

13 Advanced settings	32
Register the handsets	32
Unregister the handsets	32
Restore default settings	32

14 Telephone answering machine	33
Turn on the answering machine	33
Turn off the answering machine	33
Set the answering machine language	34
Set the answer mode	34
Outgoing messages (OGM)	34
Incoming messages (ICM)	35

15 Default settings	38
Answering machine default settings	38

16 Technical data	39
--------------------------	----

17 Frequently asked questions	40
--------------------------------------	----

1 Important

Safety instructions

Power requirements

- This product requires an electrical supply of 100-240 volts AC. In case of power failure, the communication can be lost.
- The voltage on the network is classified as TNV-3 (Telecommunication Network Voltages), as defined in the standard EN 60950.



Warning

- The Electrical network is classified as hazardous. The only way to power down the charger is to unplug the power supply from the electrical outlet. Ensure that the electrical outlet is always easily accessible.

To avoid damage or malfunction



Caution

- Use only the supplied batteries and adaptor
- Do not allow the charging contacts or the battery to come into contact with metal objects.
- Do not open the handset, base station or charger as you could be exposed to high voltages.
- Do not allow the charger to come into contact with liquids.
- Risk of explosion if battery is replaced by an incorrect type.
- Dispose of used batteries according to the instructions.
- Always use the cables provided with the product.
- For pluggable equipment, the socket-outlet shall be installed near the equipment and shall be easily accessible.
- Handsfree activation could suddenly increase the volume in the earpiece to a very high level: make sure the handset is not too close to your ear.
- This equipment is not designed to make emergency calls when the power fails. An alternative has to be made available to allow emergency calls.

- Do not expose the phone to excessive heat caused by heating equipment or direct sunlight.
- Do not drop your phone or allow objects to fall on your phone.
- Do not use any cleaning agents containing alcohol, ammonia, benzene, or abrasives as these may harm the set.
- Do not use the product in places where there are explosive hazards.
- Do not let small metal objects come into contact with the product. This can deteriorate audio quality and damage the product.
- Active mobile phones in the vicinity may cause interference.
- Metallic objects may be retained if placed near or on the handset receiver.

About operating and storage temperatures

- Operate in a place where temperature is always between 0°C to +35°C (32°F to 95°F).
- Store in a place where temperature is always between -20°C and +45°C (-4°F to 113°F).
- Battery life may be shortened in low temperature conditions.

Declaration of conformity

Hereby Philips Consumer Lifestyle, P&A, declares that the CD560/CD565 is in compliance with the essential requirements and other relevant provisions of Directive 1999/5/EC. You can find the Declaration of Conformity on www.p4c.philips.com.

This product has been designed, tested and manufactured according the European R&TTE directive 1999/5/EC. Following this directive, this product can be brought into service in the following countries:

CE 0168		R&TTE Directive 1999/5/EC	
AT ✓	BE ✓	BG ✓	CY ✓
CZ ✓	DK ✓	EE ✓	FI ✓
FR ✓	DE ✓	GR ✓	HU ✓
IS ✓	IE ✓	IT ✓	LV ✓
LI ✓	LT ✓	LU ✓	MT ✓
NL ✓	NO ✓	PL ✓	PT ✓
RO ✓	SK ✓	SI ✓	ES ✓
SE ✓	CH ✓	UK ✓	

Use GAP standard compliance

The GAP standard guarantees that all DECT™ GAP handsets and base stations comply with a minimum operating standard irrespective of their make. The handset and base station are GAP compliant, which means they guarantee the minimum functions: register a handset, take the line, make a call and receive a call. The advanced features may not be available if you use them with other makes. To register and use this handset with a GAP compliant base station of different make, first follow the procedure described in the manufacturer's instructions, then follow the procedure described in this manual for registering a handset. To register a handset from different make to the base station, put the base station in registration mode, then follow the procedure described in the handset manufacturer's instructions.

Compliance with EMF

Koninklijke Philips Electronics N.V. manufactures and sells many products targeted at consumers, which, like any electronic apparatus, in general have the ability to emit and receive electromagnetic signals.

One of Philips' leading Business Principles is to take all necessary health and safety measures for our products, to comply with all applicable legal requirements and to stay well within the EMF standards applicable at the time of producing the products.

Philips is committed to develop, produce and market products that cause no adverse health effects. Philips confirms that if its products are handled properly for their intended use, they are safe to use according to scientific evidence available today.

Philips plays an active role in the development of international EMF and safety standards, enabling Philips to anticipate further developments in standardisation for early integration in its products.

Disposal of your old product and batteries



Your product is designed and manufactured with high quality materials and components, which can be recycled and reused.



When this crossed-out wheeled bin symbol is attached to a product it means that the product is covered by the European Directive 2002/96/EC.

Please inform yourself about the local separate collection system for electrical and electronic products.

Please act according to your local rules and do not dispose of your old products with your normal household waste. Correct disposal of your old product helps to prevent potential negative consequences for the environment and human health.



Your product contains batteries covered by the European Directive 2006/66/EC, which cannot be disposed with normal household waste. Please inform yourself about the local rules on separate collection of batteries because correct disposal helps to prevent negative consequences for the environmental and human health.



When this logo is attached to a product, it means a financial contribution has been paid to the associated national recovery and recycling system.

Environmental information

All unnecessary packaging has been omitted. We have tried to make the packaging easy to separate into three materials: cardboard (box), polystyrene foam (buffer) and polyethylene (bags, protective foam sheet.)

Your system consists of materials which can be recycled and reused if disassembled by a specialized company. Please observe the local regulations regarding the disposal of packaging materials, exhausted batteries and old equipment.

Your product contains batteries covered by the European Directive 2006/66/EC, which cannot be disposed of with normal household waste.

Please inform yourself about the local rules on separate collection of batteries. The correct disposal of batteries helps prevent potentially negative consequences on the environment and human health.

2 Your CD560/ CD565

Congratulations on your purchase and welcome to Philips!

To fully benefit from the support that Philips offers, register your product at www.philips.com/welcome.

What is in the box

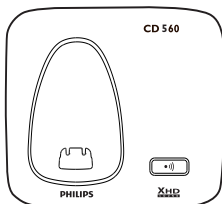

Base station with bracket (CD560)

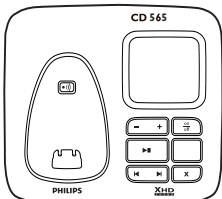

Base station with bracket (CD565)

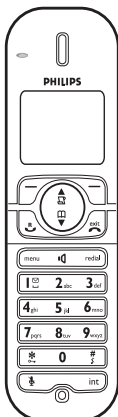

Handset

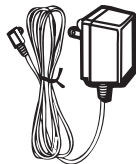

Power supply

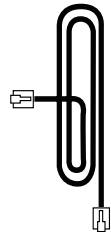

Line cord



Guarantee

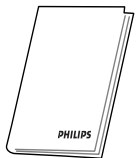

User Manual



Quick start guide

Note

- In some countries, you have to connect the line adaptor to the line cord, then plug the line cord to the line socket.

Note

- In multi-handset packs, there are additional handsets and chargers with power supply units.

Overview of the phone

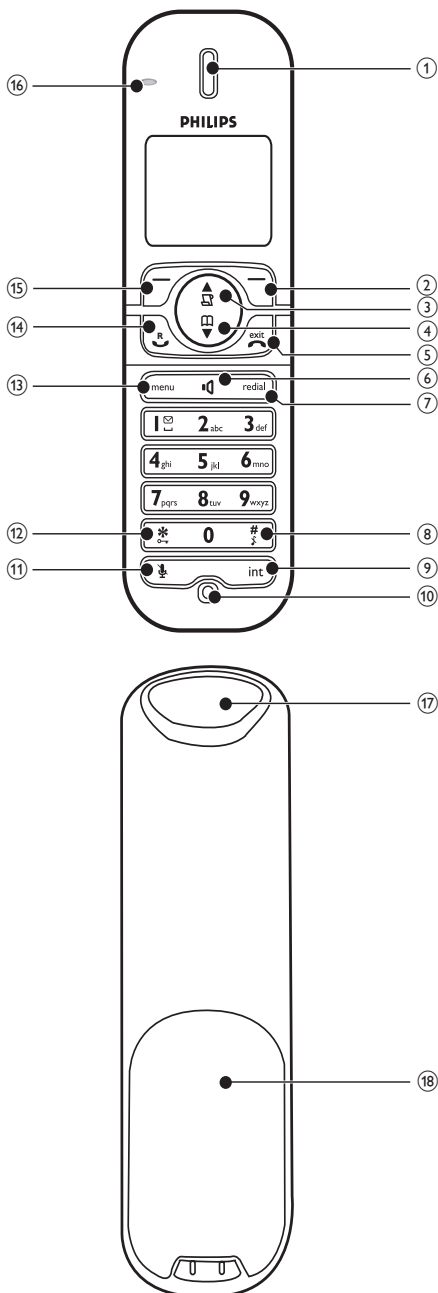

Key	Name	Descriptions
1	Earpiece	
2	Right soft key	<ul style="list-style-type: none"> Select the function displayed on the handset screen directly above the key.
3	Call Log/Up key	<ul style="list-style-type: none"> Scroll up on the menu Increase the earpiece/speaker volume Enter the call log
4	Phonebook/Down key	<ul style="list-style-type: none"> Scroll down on the menu Decrease the earpiece/speaker volume Enter the phonebook
5	End /On/Off key	<ul style="list-style-type: none"> End the call Exit the menu/operation Turn the handset on/off
6	Speaker key	<ul style="list-style-type: none"> Turn the speaker on/off
7	Redial key	<ul style="list-style-type: none"> Enter redial list and dial the recent number
8	Ringer Off/ Pause key	<ul style="list-style-type: none"> Press to enter a pause Turn the ringer on/off Switch between the lower and upper case during text editing
9	Intercom/ Conference key	<ul style="list-style-type: none"> Make the intercom call Make the conference call
10	Microphone	
11	Mute key	<ul style="list-style-type: none"> Mute/unmute the microphone

Key	Name	Descriptions
12	Star/Keylock key	<ul style="list-style-type: none"> Lock/unlock keypad key
13	Menu key	<ul style="list-style-type: none"> Access the main menu
14	Talk/Recall key	<ul style="list-style-type: none"> Make and receive calls Send the flash signal
15	Left soft key	<ul style="list-style-type: none"> Select the function displayed on the handset screen directly above the key.
16	LED indicator	
17	Loudspeaker	
18	Battery door	

Overview of the base station

CD560

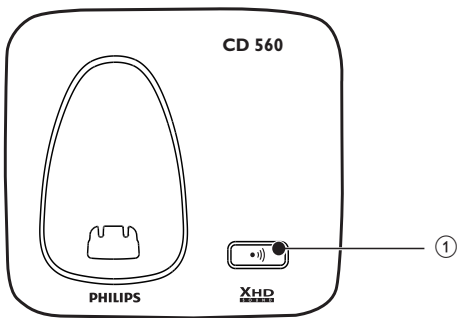

Key	Name	Descriptions
1	Paging key	<ul style="list-style-type: none"> Find handsets Enter registration mode



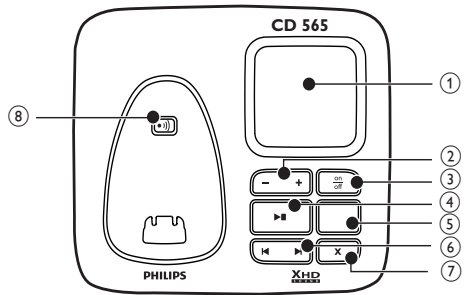









CD565



Key	Name	Descriptions
1	Loudspeaker	
2	Volume up/down key	<ul style="list-style-type: none"> Increase/decrease the speaker volume
3	On/Off key	<ul style="list-style-type: none"> Turn the answering machine on/off
4	Play/Stop key	<ul style="list-style-type: none"> Play messages Stop message playback
5	Message counter	<ul style="list-style-type: none"> Display the number of messages Display the answering machine operation
6	Forward/backward key	<ul style="list-style-type: none"> Skip forward/backward during playback
7	Delete key	<ul style="list-style-type: none"> Delete messages
8	Paging key	<ul style="list-style-type: none"> Find handset(s) Enter registration mode

Display icons

In standby mode, the icons shown on the main screen tell you what features are available on your handset.

Icon	Descriptions
	The battery is fully charged, the talk time can go up to 14 hours.
	The battery is empty.
	It indicates if your phone is linked to a base.
	The call is in progress.
	The alarm is activated.
	The speaker is on.
	The ringer is off.
	Call log
	Answering machine.
	There is unheard voice message.
	Scroll up for more options.
	Scroll down for more options.
ECO	The ECO mode is activated.

3 Get started

! Caution

- Ensure you have read the safety instructions in the "Important" section before you connect and install your handset.

Connect the base station

! Warning

- Risk of product damage! Ensure that the power supply voltage corresponds to the voltage printed on the back or the underside of the phone.
- Use only the supplied power socket to charge the battery.

☰ Note

- The type plate is located on the bottom of the base station.

- 1 Connect the output plug of the power socket to the bottom of the base station.

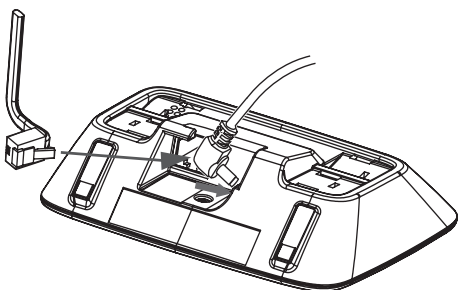

- 2 Connect the power socket to a standard wall outlet.
- 3 Connect the telephone line cord to the phone socket at the bottom of the base station and the wall phone socket.

CD560

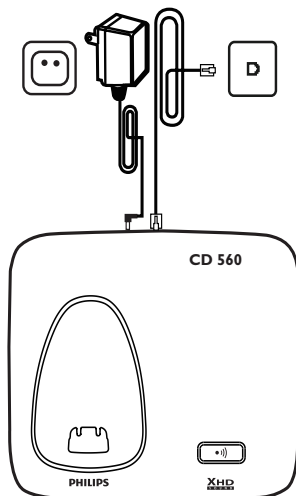

CD565

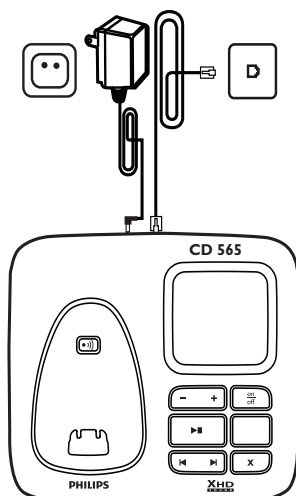

Connect the charger

Note

- The instructions for charger connection below is only available for multi-pack models.

- 1 Connect the output plug of the power socket to the bottom of the charger.

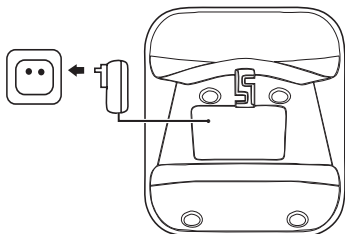

- 2 Connect the power socket to a standard wall outlet.

Wallmount the base station

Warning

- You must follow the instructions below to wallmount the base station.

- 1 Press the two latches on the top of the bracket.
 - ↳ The bracket from the back of the base station is removed.

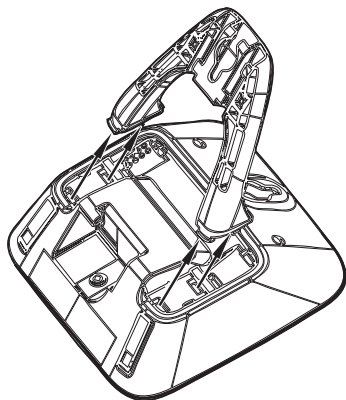

- 2 Turn the bracket around.

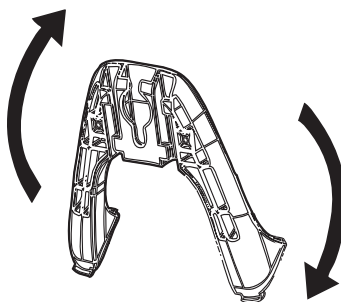

- 3 Re-insert the bracket into the back of the base station.

- 4 Insert screws (not included) into the wall.

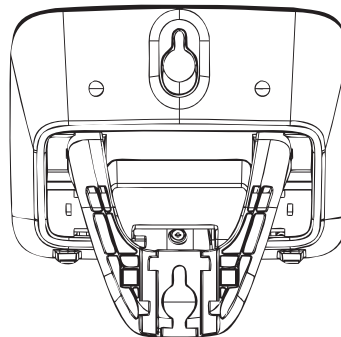

- 5 Align the mounting holes on the back of the base station with the screws on the wall.

- 6 Slide the base station down into place.

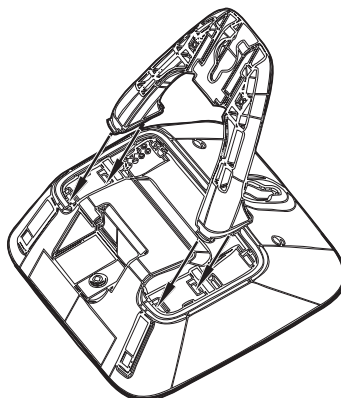

Install the handset

! Caution

- Risk of explosion! Keep batteries away from heat, sunshine or fire. Never discard batteries in fire.
- Use only the supplied batteries.
- Risk of decreased battery life! Never mix different brands or types of batteries.

☰ Note

- Charge the batteries for 24 hours before first use.

! Warning

- Check the battery polarity when inserting in the battery compartment. Incorrect polarity may damage the product.

- 1 The batteries are pre-installed in the handset. Pull the battery tape off from the battery door before charging.

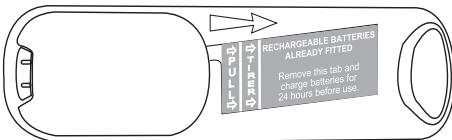

- 2 Place the handset on the base station to power up.

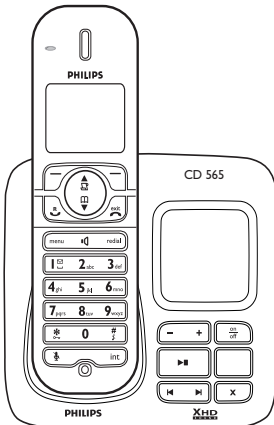

☰ Note

- If the handset becomes warm when the batteries are being charged, it is normal.

Check the battery level

The battery icon displays the current battery level.



The battery is full, the talk time can go up to 14 hours.



The battery is empty. Charge it.

The handsets turn off if the battery is empty. If you are on the phone, you hear warning tones when the battery is almost empty. The call gets disconnected after the warning.

Set the country

To make the phone work, select your country.

- 1 When you see the welcome message, select your country, press **[SELECT]** to confirm.
 - ↳ The country setting is saved.
- 2 Set the date and time.
 - ↳ The phone is now ready to use.
 - ↳ To set the date and time later, press **[BACK]** to skip this setting.

Set the date and time

- 1 Press menu.
- 2 Select **[CLOCK & ALARM]** > **[SET DATE/TIME]**, then press **[SELECT]** to confirm.
- 3 Press the numeric buttons to enter the date, then press **[OK]** to confirm.
 - ↳ On the handset, the time set menu is displayed.

- 4 Press the numeric buttons to enter the time.
 - If the time is in 12-hour format, press * to select [AM] or [PM].
- 5 Press [OK] to confirm.

Set the date and time format

- 1 Press **menu**.
- 2 Select [CLOCK & ALARM] > [SET FORMAT], then press [SELECT] to confirm.
- 3 Select [DATE FORMAT] or [TIME FORMAT].
- 4 Select the setting. Select [DD/MM][MM/DD] as the date display and [12 HOURS] or [24 HOURS] as the time display. Then press [SELECT] to confirm.
 - ↳ The setting is saved.

What is standby mode?

Your phone is in standby mode when it is idle. The standby screen displays the handset name, handset number, date and time, signal icon, and battery icon.

Check the signal strength

- The signal icon displays the link status between the handset and base station. A steady icon means your handset and the base station are linked. A flashing icon means your handset and the base station are not linked.
- Ensure the handset is linked to the base station before you make or receive calls and carry out the phone functions and features.
- If you hear warning tones when you are on the phone, the handset is almost out of battery or the handset is out of range. Charge the battery or move the handset nearer to the base station.

Switch your handset On/Off

- Press and hold  to switch off the handset. The handset's screen turns off.

Note

- When the handset is switched off, no call can be received.
- Press and hold  to switch on the handset. It takes a few seconds for the handset to power up.

4 Calls

Note

- When the power fails, the phone cannot access emergency services.

Tip

- Check the signal strength before you make a call or when you are in a call. For more information, see "Check the signal strength" in the Get started section.

Make a call

You can make a call in these ways:

- Quick call
- Dial before you call
- Redial the most recent number
- Call from the redial list.
- Call from the phonebook list
- Call from the call log

Quick call

- 1 Press .
- 2 Dial the phone number.
 - ↳ The number is dialed out.
 - ↳ The duration of your current call is displayed.

Dial before you call

- 1 Dial the phone number
 - To erase a digit, press **[CLEAR]**.
 - To enter a pause, press and hold **#**.
- 2 Press  to dial out the call.

Redial the most recent number

- 1 Press .
- 2 Press **redial**.
- 3 Press **[SELECT]**.
 - ↳ The most recent number is then dialed out.

Call from the redial list

You can make a call from the redial list.

Tip

- For more information, see "Redial a call" in the Redial list section.

Call from the phonebook

You can make a call from the phonebook list.

Tip

- For more information, see "Call from the phonebook" in the Phonebook section.

Call from the call log

You can return a call from the outgoing, received or missed call log.

Tip

- For more information, see "Return a call" in the Call log section.

Note

- The call timer displays the talk time of your current call.

Note



- If you hear warning tones, the handset is almost out of battery or the handset is out of range. Charge the battery or move the handset nearer to the base station.

End a call

You can end a call in these ways:

- Press  or
- Place the handset to the base station or charging cradle if the auto hang up is activated.

Answer a call

When the phone rings, Press  or  to answer the call.



Warning

- When the handset rings or when the handsfree is activated, keep the handset away from your ear to avoid ear damage.



Note

- The caller ID service is available if you have registered to the caller ID service with your service provider.





Tip



- When there is a missed call, the handset displays a notification message.

Turn off the ringer for all incoming calls

There are two ways to turn off the ringer:



- 1 Press and hold  in standby mode.
 - ↳  displays on the screen.
- 2 When the phone rings, press **[SILENT]**.

Adjust the earpiece volume

Press  or  to adjust the volume during a call.

- ↳ The earpiece volume is adjusted and the phone is back to the call screen.

Mute the microphone

- 1 Press  during a call.
 - ↳ The handset displays **[MUTE ON]**.
 - ↳ The caller cannot hear you, but you can still hear his voice.
- 2 Press  again to unmute the microphone.
 - ↳ You can now communicate with the caller.

Turn the speaker on or off

Press .

Make a second call



Note

- This service is network dependent.

- 1 Press  during a call, then press **[OK]**.
 - ↳ The first call is put on hold.
- 2 Dial the second number.
 - ↳ The number displayed on the screen is dialed out.



Answer a second call



Note

- This is a country dependent setting.

When there is a periodical beep to notify you of an incoming call, you can answer the call in these ways:

- 1 Press  and **2_{abc}** to answer the call.
 - ↳ The first call is put on hold, and you are now connected to the second call.
- 2 Press  and **I** to end the current call and answer the first call.

Toggle between two calls

You can toggle your calls in these ways:

- 1 Press **⏸** and **2**_{abc}; or
- 2 Press **[OK]** and select **[SWITCH CALLS]**, then press **[OK]** again to confirm.
 - ↳ The current call is put on hold, and you are now connected to the other call.

Make a conference call



Note

- This service is network dependent. Check with the service provider for additional charges.

When you are connected to two calls, press **[OK]**, select **[CONFERENCE]** and then press **[SELECT]** again to confirm.

- ↳ The two calls are combined and a conference call is established.

5 Intercom and conference calls

An intercom call is a call to another handset that shares the same base station. A conference call involves a conversation among you, another handset user and the outside callers.

Make a call to another handset

Note

- If the base station only has 2 registered handsets, press **int** to make a call to another handset.

- 1 Press **int**. The handsets available for intercom are displayed.
- 2 Select or enter a handset number, then press **[SELECT]** to confirm.
 - ↳ The selected handset rings.
- 3 Press **R** on the selected handset.
 - ↳ The intercom is established.
- 4 Press **exit** to cancel or end the intercom call.

Note

- If the selected handset is occupied in a call, you hear a busy tone.

While you are on the phone

You can go from one handset to another during a call:

- 1 Press **int**.
 - ↳ The current caller is put on hold.
- 2 Select or enter a handset number, then press **[SELECT]** to confirm.
 - ↳ Wait for the other side to answer your call.

Toggle between calls

Press **int** to switch between the outside call and the intercom call.

Transfer a call

- 1 Press **int** during a call.
- 2 Select or enter the handset number, then press **[SELECT]** to confirm.
- 3 Press **exit** when the other side answers your call.
 - ↳ The call is now transferred to the selected handset.

Make a conference call

A 3-way conference call is a call between you, another handset user and the outside callers. It requires two handsets to share the same base station.

During an external call

- 1 Press **int** to initiate an internal call.
 - ↳ The handsets available for intercom are displayed.
 - ↳ The external caller is put on hold.
- 2 Select or enter a handset number, then press **[SELECT]** to confirm.
 - ↳ The selected handset rings.
- 3 Press **R** on the selected handset.
 - ↳ The intercom is established.
- 4 Press and hold **int** on your handset.
 - ↳ You are now on a 3-way conference call with the external call and the selected handset.
- 5 Press **exit** to end the conference call.

 Note

- Press **R** to join an ongoing conference with another handset if **[ADVANCED SET] > [CONFERENCE]** is set to **[ON]**.

During the conference call

- 1** Press **int** to put the external call on hold and go back to the internal call.
↳ The external call is put on hold.
- 2** Press **int** to toggle between the external and internal call.
- 3** Press and hold **int** to establish the conference call again.

 Note

- If a handset hangs up during the conference call, the other handset remains connected to the external call.

6 Text and numbers

You can enter text and numbers for handset name, phonebook records, and other menu items.

Enter text and numbers

- 1 Press once or several times on the alphanumeric key to enter the selected character.
- 2 Press **[CLEAR]** to delete the character. Press **▲/▼** to move the cursor left and right.

Key	Characters (Upper case)
0	. 0 , / : ; " ' ! ; ? ; * + - % \ ^ ~
1	[Sp] 1 @ _ # = < > () & € £ \$ ¥ [] { } ¨ § ...
2	A B C 2 Ä Å Æ Á Ā Ă Ą Ć Ĉ Ç Ċ Ď ě Ě Ę Ę Ę Ę Ę Ę Δ Φ
3	D E F 3 Ď ě Ě Ę Ę Ę Ę Ę Ę Δ Φ
4	G H I 4 Ğ ğ İ ï Î ĩ Γ
5	J K L 5 Λ λ Ł ł
6	M N O 6 Ñ ñ Ó ó Ô ô Ö ö
7	P Q R S 7 Ŕ ŕ Š š Ś ś β π Θ Σ
8	T U V 8 Ţ ţ Û ú Ü ü Ů ů Ú ú μ
9	W X Y Z 9 Ÿ Ž ž Ž ž Ž ž Ø Ω ≡ Ψ

Key	Characters (Lower case)
0	. 0 , / : ; " ' ! ; ? ; * + - % \ ^ ~
1	[Sp] 1 @ _ # = < > () & € £ \$ ¥ [] { } ¨ § ...
2	a b c 2 ä å æ á ā ă ą ą ç ę ĉ ċ ě ě ě ě ě ě Δ Φ
3	d e f 3 đ ě ě ě ě ě ě ě ě Δ Φ
4	g h i 4 ğ ğ ĩ ï î ĩ Γ
5	j k l 5 λ λ ł ł
6	m n o 6 ñ ñ ó ó ô ô ö ö
7	p q r s 7 ŕ ŕ š š ś ś β π Θ Σ
8	t u v 8 ŧ ŧ ù ú ü ü ů ů ú ú μ
9	w x y z 9 ý ž ž ž ž ž ž ø Ω ≡ Ψ

Example to write "Paul"

Press 7 once: P

Press 2 once: a

Press 8 two times: u

Press 5 three times: l

Switch between uppercase and lowercase

By default, the first letter of each word in a sentence is uppercase and the rest is lowercase.

Press and hold **#** to switch between the uppercase and lowercase letters.

7 Phonebook

This phone has a phonebook that stores up to 200 records. You can access the phonebook from the handset. Each record can have a name up to 14 characters long and a number up to 24 digits long.

View the phonebook



Note

- You can view the phonebook on one handset only each time.

- 1 Press .
- 2 Select a contact and view the available information.

Search a record

You can search the phonebook records in these ways:

- Scroll the contacts list.
- Enter the first character of the contact.

Scroll the contact list

Access the phonebook menu, then press and to scroll through the phonebook entries.

Enter the first character of a contact

- 1 Access the phonebook menu.
- 2 Select **[LIST]**.
- 3 Press the alphanumeric key that corresponds to the character.
 - ↳ The first record that starts with this character is displayed.

Access the phonebook during a call

- 1 Press **[OPTION]**, select **[PHONEBOOK]** then press **[SELECT]** to confirm.
- 2 Select the contact, then press **[SELECT]** to confirm.
 - ↳ The number can be viewed.
- 3 Press **[SELECT]** again to dial out the number.

Call from the phonebook

- 1 Press to access the phonebook.
- 2 Select a contact in the phonebook list.
- 3 Press to make the call.

Add a record



Note

- If your phonebook memory is full, the handset displays a notification message. Delete some records to add new ones.

- 1 Press **menu**.
- 2 Select **[PHONEBOOK]** > **[NEW ENTRY]**, then press **[SELECT]** to confirm.
- 3 Enter the name then press **[OK]** to confirm.
- 4 Enter the number, then press **[SAVE]** to confirm.



Tip

- For more information on how to edit the name and number, see the section on Text and numbers.

**Note**

- The phonebook only saves new number.

**Tip**

- Press and hold **#** to insert a pause.

↳ Your new record is saved.

Set the melody

You can personalize the melody played when someone in the phonebook calls you.

**Note**

- Ensure you have subscribed the caller line identification service before you have this feature.

- 1 Press **menu**.
- 2 Select **[PHONEBOOK] > [SELECT MELODY]**, then press **[SELECT]** to confirm.
- 3 Select a contact, then press **[VIEW]**.
- 4 Press **[SELECT]** to set or change the melody for the contact.
- 5 Select a melody for the contact, then press **[SELECT]** to confirm.
↳ The melody is set.

Edit a record

- 1 Press **menu**.
- 2 Select **[PHONEBOOK] > [EDIT ENTRY]**, then press **[SELECT]** to confirm.
- 3 Select the contact, then press **[SELECT]** to confirm.
- 4 Edit the name, then press **[OK]** to confirm.

- 5 Edit the number, then press **[SAVE]** to confirm.
↳ The record is saved.

Delete a record

- 1 Press **menu**.
- 2 Select **[PHONEBOOK] > [DELETE]**, then press **[SELECT]** to confirm.
- 3 Select a contact, then press **[OK]** to confirm.
↳ The record is deleted.

Delete all records

- 1 Press **menu**.
- 2 Select **[PHONEBOOK] > [DELETE ALL]**, press **[SELECT]** to confirm.
↳ The handset displays a confirmation request.
- 3 Press **[OK]** to confirm.
↳ All records are deleted.

8 Call log

The call log stores the call history of all outgoing, missed or received calls. The incoming call history includes the name and number of the caller, call time and date. This feature is available if you have registered to the caller ID service with your service provider.

Your phone can store up to 50 call records. The call log icon on the handset flashes to remind you of any unanswered calls. If the caller allows the display of his identity, you can view his name or number. The call records are displayed in chronological order with the most recent received call at the top of the list.



 Note

- Ensure the number in the call list is valid before you can call back directly from the call list.

View the call records

- 1 Press .
- 2 Select [CALL LIST], then press [SELECT] to confirm.
↳ The incoming call log is displayed.
- 3 Select a record, then press [OPTION] for more available information.

Return a call

- 1 Press .
- 2 Select [CALL LIST], then press [OPTION].
- 3 Select a record on the list.
- 4 Press  to make the call.

Save a call record to the phonebook

- 1 Press .
- 2 Select [CALL LIST].
- 3 Select a record, then press [OPTION] to confirm.
- 4 Select [SAVE NUMBER], then press [SELECT] to confirm.
- 5 Enter and edit the name, then press [OK] to confirm.
- 6 Enter and edit the number, then press [SAVE] to confirm.
↳ The record is saved.

Delete a call record

- 1 Press .
- 2 Select [CALL LIST].
- 3 Select a record, then press [OPTION] to confirm.
- 4 Select [DELETE], then press [SELECT] to confirm.
↳ The record is deleted.

Delete all call records

- 1 Press .
- 2 Select [CALL LIST].
- 3 Press [OPTION] to enter the options menu.
- 4 Select [DELETE ALL], then press [SELECT] to confirm.
↳ The handset displays a confirmation requests.
- 5 Press [OK] to confirm.
↳ All records are deleted.

9 Redial list

The redial list stores the call history of dialed calls. It includes the names and/or numbers you have called. This phone can store up to 10 redial records.

View the redial records

- 1 Press **redial** to enter the list of dialed calls.
- 2 Select a record, press **[SELECT]**.

Redial a call

- 1 Press **redial**.
- 2 Select the record you want to call. Press .
↳ The number is dialed out.

Save a redial record to the phonebook

- 1 Press **redial** to enter the list of dialed calls.
- 2 Select a record, then Press **[SELECT]** then **[OPTION]**.
- 3 Select **[SAVE NUMBER]**, then press **[SELECT]** to confirm.
- 4 Enter and edit the name, then press **[OK]** to confirm.
- 5 Enter and edit the number, then press **[SAVE]** to confirm.
↳ The record is saved.

Delete a redial record

- 1 Press **redial** to enter the list of dialed calls.
- 2 Select a record, then Press **[SELECT]** then **[OPTION]**.
- 3 Select **[DELETE]**, then press **[SELECT]**.
↳ The record is deleted.

Delete all redial records

- 1 Press **redial** to enter the list of dialed calls.
- 2 Press **[SELECT]** then **[OPTION]** to enter the options menu.
- 3 Select **[DELETE ALL]**, then press **[SELECT]** to confirm.
- 4 The handset displays a confirmation request.
- 5 Press **[OK]** to confirm.
↳ All records are deleted.

10 Self-defined settings

Customize the settings to make it your own phone.

Personalize the phone display

Name the handset

The name of the handset can be up to 14 characters. It is displayed on the handset screen in standby mode.

- 1 Press **menu**.
- 2 Select **[PERSONAL SET] > [HANDSET NAME]**, then press **[SELECT]** to confirm.
- 3 Enter or edit the name. To erase a character, press **[CLEAR]**.
- 4 Press **[OK]** to confirm.
↳ The setting is saved.

Set the display language

 **Note**

- This feature only applies to models with multiple-language support.
- Languages available for selection vary with different countries.

- 1 Press **menu**.
- 2 Select **[PERSONAL SET] > [LANGUAGE]**, then press **[SELECT]** to confirm.
- 3 Select a language, then press **[SELECT]** to confirm.
↳ The setting is saved.

Personalize the sounds

Set the handset's ringtone

You can select from 15 ringtones.

- 1 Press **menu**.
- 2 Select **[PERSONAL SET] > [HANDSET TONES] > [RING TONES]**, then press **[SELECT]** to confirm.
- 3 Select a ringtone, then press **[SELECT]** to confirm.
↳ The setting is saved.

Set the handset's ringtone volume

You can select among 6 ringtone volume levels or **[OFF]**.

- 1 Press **menu**.
- 2 Select **[PERSONAL SET] > [HANDSET TONES] > [RING VOLUME]**, then press **[SELECT]** to confirm.
- 3 Select a volume level, then press **[SELECT]** to confirm.
↳ The setting is saved.

 **Tip**

- To turn off the ringtone, press and hold **#** in standby mode. Then **↵** displays on the screen.

Set the key tone

Key tone is the sound made when you press a key on the handset.

- 1 Press **menu**.
- 2 Select **[PERSONAL SET] > [HANDSET TONES] > [KEY BEEP]**, then press **[SELECT]** to confirm.
- 3 Select **[ON]/[OFF]**, then press **[SELECT]** to confirm.
↳ The setting is saved.

Enhance the audio quality

XHD (Extreme High Definition) sound mode is an exclusive feature which transmits high fidelity signals to the handset. It makes the phone conversations sound like real-life conversations.

When you are in standby mode,

- 1 Press **menu**.
- 2 Select **[ADVANCED SET] > [XHD SOUND]**, then press **[SELECT]** to confirm.
- 3 Select the new setting, then press **[SELECT]** to confirm.
↳ The setting is saved.

When you are in a call,

- 1 Press **[OPTION]** to enter the options menu.
- 2 Change the XHD setting.
- 3 Press **[SELECT]** to confirm.
↳ The setting is saved.

11 Call features

The phone supports a number of call-related features that help you handle and manage the calls.

Auto hang up

To end a call, simply place the headset on the base station or charge cradle.

Activate/Deactivate auto hang up

- 1 Press **menu**.
- 2 Select **[PERSONAL SET] > [RECALL TIME]**, then press **[SELECT]** to confirm.
- 3 Select **[ON]/[OFF]**, then press **[SELECT]** to confirm.
↳ The setting is saved.

Note

- When the auto hang up is off, the speaker is on automatically.

Auto conference

To join an external call with another handset, press .

Activate/Deactivate auto conference

- 1 Press **menu**.
- 2 Select **[ADVANCED SET] > [CONFERENCE]**, then press **[SELECT]** to confirm.
- 3 Select **[ON]/[OFF]**, then press **[SELECT]** to confirm.
↳ The setting is saved.

Dial mode

Note

- This feature only applies to models that support both tone and pulse dial.

Dial mode is the telephone signal used in your country. The phone supports tone (DTMF) and pulse (rotary) dial. Consult the service provider for detailed information.

Set the dial mode

- 1 Press **menu**.
- 2 Select **[ADVANCED SET] > [DIAL MODE]**, then press **[SELECT]** to confirm.
- 3 Select a dial mode, then press **[SELECT]** to confirm.
↳ The setting is saved.

Note

- If your phone is in pulse dial mode, press ***d*** during a call for temporary tone mode. 'd' displays. Digits entered for this call are then sent out as tone signals.

Select the recall duration

Ensure that the recall time is set correctly before you can answer a second call. In normal case, the phone is already preset for the recall duration. You can select among 3 options: **[SHORT]**, **[MEDIUM]** and **[LONG]**. The number of available options varies with different countries. For details, consult your service provider.

Set the recall duration

- 1 Press **menu**.
- 2 Select **[ADVANCED SET] > [RECALL TIME]**, then press **[SELECT]** to confirm.
- 3 Select an option, then press **[SELECT]** to confirm.
↳ The setting is saved.

Auto prefix

This feature checks and formats your outgoing call number before it is dialed out. The prefix number can replace the detect number you set in the menu. For example, you set 604 as the detect number and 1250 as the prefix. When you have dialed out a number such as 6043338888, your phone changes the number to 12503338888 when it dials out.

Note

- The maximum length of a detect number is 5 digits. The maximum length of an auto prefix number is 10 digits.

Set auto prefix

- 1 Press **menu**.
- 2 Select **[ADVANCED SET] > [AUTO PREFIX]**, then press **[SELECT]** to confirm.
- 3 Enter the detect number, then press **[OK]** to confirm.
- 4 Enter the prefix number, then press **[OK]** to confirm.
 - ↳ The setting is saved.

Note

- To enter a pause, press and hold **#**.

Note

- If the prefix number is set and the detect number is left empty, the prefix number is added to all outgoing calls.

Note

- The feature is unavailable if the dialed number starts with ***** and **#**.

First ring

If you have subscribed for caller ID service with your service provider, your phone can suppress the first ring before the caller ID displays on the screen. After the phone is reset, it can detect automatically if the caller ID service is subscribed and start to suppress the first ring. You can change this setting to suit your preference. This feature only applies to models with first ring support.

Turn the first ring on/off

- 1 Press **menu**.
- 2 Select **[ADVANCED SET] > [FIRST RING]**, then press **[SELECT]** to confirm.
- 3 Select **[ON]/[OFF]**, press **[OK]** to confirm.
 - ↳ The setting is saved.

Note

- To reset the first ring status, go to the reset menu.

ECO mode

The **ECO** mode reduces the transmission power of the handset and base station.

- 1 Press **menu**.
- 2 Select **[ADVANCED SET] > [ECO]**, then press **[SELECT]** to confirm.
- 3 Select the new setting, then press **[OK]** to confirm.
 - ↳ The setting is saved.
 - ↳ **ECO** is displayed instead of **Y** in standby mode

Note

- When the **ECO** mode is activated, the connection range between the handset and the base station can be reduced.

12 Extra features

Your phone offers you extra features which keep you organized and informed while on the move.

Alarm clock

Your phone has a built-in alarm clock. Check the information below to set your alarm clock.

Set the alarm

- 1 Press **menu**.
- 2 Select **[CLOCK & ALARM] > [ALARM]**, then press **[SELECT]** to confirm.
- 3 Select **[ON ONCE]** or **[ON DAILY]**, then press **[SELECT]** to confirm.
- 4 Enter an alarm time.
- 5 Press **[OK]** to confirm.
↳ The alarm is set and  is displayed on the screen.



Tip

- Press / to switch between **[AM]/[PM]**

Turn off the alarm

When the alarm rings

- 1 Press any key can turn off the alarm.

Before the alarm rings

- 1 Press **menu**.
- 2 Select **[CLOCK & ALARM] > [ALARM]**, then press **[SELECT]** to confirm.
- 3 Select **[OFF]**, then press **[SELECT]** to confirm.
↳ The setting is saved.

Set the alarm melody

- 1 Press **menu**.
- 2 Select **[CLOCK & ALARM] > [ALARM TONE]**, then press **[SELECT]** to confirm.
- 3 Select a new melody, then press **[SELECT]** to confirm.
↳ The setting is saved.

Note

- The alarm volume is set to the same level as the ringer volume. If the ringer is off, the alarm volume is set to level 1.

Auto clock

Note

- This service is network dependent.

Note

- Ensure you have the caller ID service before you have this feature.

It synchronizes the date and time on your phone with the public switched telephone network (PSTN) automatically. For the date to be synchronized, ensure the current year is set.

- 1 Press **menu**.
- 2 Select **[CLOCK & ALARM] > [AUTO CLOCK]**, then press **[SELECT]** to confirm.
- 3 Select **[ON]/[OFF]**. Press **[SELECT]**.
↳ The setting is saved. .

Keypad lock

You can lock the keypad to prevent accidental button presses.

Lock the keypad

- 1 Press and hold  in standby mode.
↳ The keypad is locked.





Note

- When the keypad is locked, no call can be made. You can still answer the incoming calls. The keypad is unlocked during the call but is locked automatically after you finish the call.

Unlock the keypad

- 1 Press and hold .
↳ The keypad is unlocked.

Locate the handset

- 1 Press  on the base station.
↳ All handsets connected to this base station ring.
- 2 Press  on the base station again to stop ringing.
↳ All handsets stop ringing; or
- 3 Press any key on one handset to stop ringing.

13 Advanced settings

Register the handsets

You can register additional handsets to the base station. The base station can register up to 5 handsets.

Auto registration

- 1 Place the handset on the base station.
 - ↳ The handset detects the base station and start to register automatically.
 - ↳ Registration is completed in less than 2 minutes. The base station automatically assigns a handset number to the handset.

Manual registration

If auto registration fails, register your handset manually to the base station.

- 1 Press **menu** on the handset.
- 2 Select **[ADVANCED SET] > [REGISTER]**, then press **[SELECT]** to confirm.
- 3 Press and hold **(•••)** on the base station for 5 seconds until you hear a confirmation beep.
- 4 Enter the system PIN. Press **[CLEAR]** to make corrections.
- 5 Press **[OK]** to confirm the PIN.
 - ↳ Registration is completed in less than 2 minutes. The base automatically assigns a handset number to the handset.

Note

- If the PIN is incorrect or no base is found within a certain period, your handset displays a notification message. Repeat the above procedure if registration fails.

Note

- The preset PIN is 0000. No change can be made on it.

Unregister the handsets

- 1 If two handsets share the same base stations, you can unregister a handset with another handset.
- 2 Press **menu**.
- 3 Select **[ADVANCED SET] > [UNREGISTER]**, then press **[SELECT]** to confirm.
- 4 Enter the system PIN. (The preset PIN is 0000). Press **[CLEAR]** to remove the number.
- 5 Select the handset number to be unregistered.
- 6 Press **[OK]** to confirm.
 - ↳ The handset is unregistered.

Tip

- The handset number displays beside the handset name in standby mode.

Restore default settings

You can reset your phone settings to the original factory settings.

- 1 Press **menu**.
- 2 Select **[ADVANCED SET] > [RESET]**, then press **[SELECT]** to confirm.
 - ↳ The handset displays a confirmation request.
- 3 Press **[OK]** to confirm.
 - ↳ All settings are reset.
 - ↳ The welcome screen displays.

Tip

- For more information about the default settings, see the section on Default settings.

14 Telephone answering machine

Note

- Available only for CD565.

Your phone includes a telephone answering machine that records unanswered calls when it is on. By default, the answering machine is set to the **[ANSWER & REC.]** mode. You can also access the answering machine remotely and change the settings through the answering machine menu on the handset.

The LED message counter (two digits 7-segment display) on the base station shows the number of the messages when the answering machine is on.

.	The answering machine is on.
No display	The answering machine is off.
--	Memory full
AA	The answering machine can be accessed remotely (both on the handset or on a touch tone phone).
[]	Recording
x.	Volume level adjustment Number of messages

Turn on the answering machine

You can turn on the answering machine through the base station or the handset.

Through the handset

- 1 Press **menu**.
- 2 Select **[ANSWER MACHINE] > [ANSWER ON/OFF]**, then press **[SELECT]** to confirm.
- 3 Select **[ON]**, then press **[SELECT]** to confirm.
↳ The setting is saved.

Through the base

- 1 Press **on/off** to turn on the answering machine in standby mode.

Note

- When the answering machine is switched on, it answers incoming calls after a certain number of rings based on the ring delay setting.

Turn off the answering machine

You can turn off the answering machine through the base unit or the handset.

Through the handset

- 1 Press **menu**.
- 2 Select **[ANSWER MACHINE] > [ANSWER ON/OFF]**, then press **[SELECT]** to confirm.
- 3 Select **[OFF]**, then press **[SELECT]** to confirm.
↳ The setting is saved.

Through the base

- 1 Press **on/off** to turn off the answering machine in standby mode.

Set the answering machine language

Note

- This feature only applies to models with multiple-language support.

The answering machine language is the language for the outgoing messages.

- 1 Press **menu**.
- 2 Select **[ANSWER MACHINE] > [SETTINGS] > [VOICE LANGUAGE]**, then press **[SELECT]** to confirm.
- 3 Select a language, then press **[SELECT]** to confirm.
↳ The setting is saved.

Set the answer mode

You can set the answering machine and select if the callers can leave messages. Select **[ANSWER & REC.]** if you allow the callers to leave messages. Select **[ANSWER ONLY]** if you forbid the callers to leave messages.

- 1 Press **menu**.
- 2 Select **[ANSWER MACHINE] > [ANSWER MODE]**, then press **[SELECT]** to confirm.
- 3 Select an answer mode, then press **[SELECT]** to confirm.
↳ The setting is saved.

Note

- If the memory is full, the answering machine switches to **[ANSWER ONLY]** mode automatically.

Outgoing messages (OGM)

The outgoing message is the message your caller hears when the answering machine picks up the call. The answering machine has 2 pre-recorded outgoing messages: the **[ANSWER & REC.]** mode and **[ANSWER ONLY]** mode.

Record an outgoing message

The maximum length of the outgoing message you can record is 3 minutes. The newly recorded outgoing message automatically replaces the old one.

- 1 Press **menu**.
- 2 Select **[ANSWER MACHINE] > [RECORD OGM]**, then press **[SELECT]** to confirm.
- 3 Select **[ANSWER & REC.]** or **[ANSWER ONLY]**, then press **[SELECT]** to confirm.
- 4 Select **[RECORD OGM]**, then press **[SELECT]** to confirm.
- 5 Recording starts after the beep.
- 6 Press **[OK]** to stop recording or the recording stops after 3 minutes.
↳ The recorded outgoing message plays back automatically for your review.

Note

- To restore the pre-recorded outgoing message, delete your current outgoing message.

Listen to the current outgoing message

- 1 Press **menu**.
- 2 Select **[ANSWER MACHINE] > [RECORD OGM]**, then press **[SELECT]** to confirm.

- 3 Select **[ANSWER & REC.]** or **[ANSWER ONLY]**. Press **[SELECT]** to confirm.
- 4 Select **[PLAY]**, then press **[SELECT]** to confirm.
 - ↳ The handset plays the current outgoing message.

Delete an outgoing message

- 1 Press **menu**.
- 2 Select **[ANSWER MACHINE]** > **[RECORD OGM]**, then press **[SELECT]** to confirm.
- 3 Select **[ANSWER & REC.]** or **[ANSWER ONLY]**, then press **[SELECT]** to confirm.
- 4 Select **[DELETE]**, then press **[SELECT]** to confirm.
- 5 The pre-recorded outgoing message is restored.

Note

- No pre-recorded outgoing message can be deleted.

Incoming messages (ICM)

Each message can be up to 3 minutes long. When you receive new messages, the new message indicator flashes on the answering machine and the handset displays a notification message.

Note

- If you pick up the phone when the caller leaves a message, the recording stops and you can talk to the caller directly.

Note

- If the memory is full, the answering machine switches to **[ANSWER ONLY]** automatically. Delete old messages to receive new ones.

Listen to the incoming messages

Incoming messages are played back in the sequence they are recorded.



From the base

- Start/Stop playback: Press **▶■**.
- Adjust the volume: Press **+ / -**.
- Skip backward:
 - During message playback, press **◀** to play the message from the beginning.
 - During the first second of the current message, press **◀** to play the previous message.
- Skip forward: Press **▶** to skip to the next message.
- Delete the current message: Press **✕**.

Note

- No deleted messages can be recovered.

From the handset

- 1 Press **menu**.
 - 2 Select **[ANSWER MACHINE]** > **[PLAY]**, then press **[SELECT]** to confirm.
 - ↳ New messages start playing. Old messages start playing if there is no new message.
- Press **[BACK]** to stop the playback.
 - Press  to enter the options menu.
 - Press  /  to increase/decrease the volume.

Delete an incoming message

From the base

- 1 Press **✕** during message playback.
 - ↳ The current message is deleted.

From the handset

- 1 Press  during message playback to enter the options menu.
- 2 Select **[DELETE]**, then press **[SELECT]** to confirm.
↳ The current message is deleted.

Delete all old incoming messages

From the base

- 1 Press and hold **X** in standby mode.
↳ All old messages are permanently deleted.

From the handset

- 1 Press **menu** on the handset.
- 2 Select **[ANSWER MACHINE] > [DELETE ALL]**, then press **[SELECT]** to confirm.
↳ The handset displays a confirmation request.
- 3 Press **[OK]** to confirm.
↳ All old messages are permanently deleted.

Note

- You can delete the read messages only. No deleted messages can be recovered.

Call screening

You can hear the caller while he is leaving a message. Then you can decide whether or not to talk to the caller directly.

From the base

Press **+/-** to adjust the speaker volume during call screening. The lowest volume level turns off the call screening.

Set the ring delay

You can set the number of times the phone rings before the answering machine picks up the call.

- 1 Press **menu**.
- 2 Select **[ANSWER MACHINE] > [SETTINGS] > [RING DELAY]**, then press **[SELECT]** to confirm.
- 3 Select a new setting, then press **[SELECT]** to confirm.
↳ The setting is saved.

Note

- Ensure that the answering machine is switched on before this feature can be applied.

Tip

- When you access the answering machine remotely, you are recommended to set the ring delay to **[ECONOMY]** mode. This is a cost effective way to manage your messages. When there are new messages, the answering machine picks up the call after 3 rings; When there is no messages, it picks up the call after 5 rings.

Remote access

You can operate your answering machine when you are away from home. Simply make a call to your phone with a touch tone phone and enter your 4-digit PIN code.

Note

- The remote access PIN code is the same as your system PIN. The preset PIN is 0000.

Activate/deactivate the remote access

You can allow or block remote access to the answering machine.

- 1 Press **menu**.

- 2 Select **[ANSWER MACHINE] > [SETTINGS] > [REMOTE ACCESS]** , then press **[SELECT]** to confirm.
- 3 Select a new setting, then press **[SELECT]** to confirm.
↳ The setting is saved.

Access the answering machine remotely

- 1 Make a call to your home number with a touch tone phone.
- 2 Press **#** when the outgoing message starts playing.
- 3 Enter your PIN code.
↳ You now have access to your answering machine, and the new messages start playing.

Note

- You have 2 chances to enter the correct PIN code before your phone hangs up.

- 4 Press a key to carry out a function. See the Remote access commands table below for a list of available functions.

Note

- When no message plays, the phone hangs up automatically if no key is pressed for 8 seconds.

Remote access commands

Key	Function
1	Repeat current or play previous message.
2	Play messages.
3	Skip to next message.
6	Delete current message.
7	Switch answering machine on (not available during playback).
8	Stop message playback
9	Switch answering machine off (not available during playback).

Set the sound quality of the message

You can adjust the sound quality of the messages received from the answering machine.

- 1 Press **menu**.
- 2 Select **[ANSWER MACHINE] > [SETTINGS] > [MSG QUALITY]**, then press **[SELECT]** to confirm.
- 3 Select the new setting, then press **[SELECT]** to confirm.
↳ The setting is saved.

15 Default settings

Language	Country dependent
Handset name	PHILIPS
Date	01/01/09
Date format	DD/MM
Time	00:00
Time format	24-hour
Auto clock	On
Alarm	Off
Phonebook list	Unchanged
Auto hang up	On
Recall time	Country dependent
Area code	[Empty]
Carrier code	[Empty]
Network type	PSTN (DECT phone for connection to the public switched telephone network)
First ring	Country dependent
Conference	Off
Handset ring melody	Melody 1
Alarm tone	Melody 1
Receiver volume	Volume 3
Handset speaker volume	Level 3
Handset ring volume	Level 3
Handset key beep	On
XHD sound	On
Incoming call log	[Empty]
Redial list	[Empty]
Dial mode*	Tone
Auto prefix	[Empty]

Answering machine default settings

Answering Machine	
Ans machine status	On
Ans machine mode	Answer & Rec
Base call screening	On
Outgoing message memory	Pre-recorded OGM
Incoming message memory	[Empty]
Remote access	Off
PIN code	0000
Voice language	Country-dependent
Ring delay	5 rings
Base speaker volume	Level 3
Message quality	High



Note

- *Country dependent features

16 Technical data

- Operation: Up to 95% at 40°C
- Storage: Up to 95% at 40°C

Display

- Progressive LCD backlight

General telephone features

- Dual mode caller name & number identification
- 10 polyphonic ringer melodies and 5 standard ringer melodies
- Conference call and voicemails
- Intercom

Phonebook list, Redial list and Call log

- Phonebook list with 200 entries
- Redial list with 10 entries
- Call log with 50 entries

Battery

- 2 x AAA Ni-MH 1.2V Rechargeable 650mAh batteries

Adaptor

- Base: Input 100-240V 50/60Hz 0.1A, Output: 6V 500mA
- Charger: Input 100-240V 50/60Hz 0.2A, Output: 6V 150mA

Power consumption

- Power consumption at standby mode: around 600 mW (CD560); 650 mW (CD565)

Weight and dimensions (CD560)

- Handset: 103 grams
- 164.5 x 27 x 46.5 mm (H x D x W)
- Base: 107 grams
- 79.5 x 107 x 108 mm (H x D x W)

Weight and dimensions (CD565)

- Handset: 103 grams
- 164.5 x 27 x 46.5 mm (H x D x W)
- Base: 139 grams
- 79.5 x 107 x 122 mm (H x D x W)

Temperature range

- Operation: 0°C to +35°C (32°F to 95°F)
- Storage: -25°C to +45°C (-4°F to 113°F)

Relative humidity

17 Frequently asked questions

The signal icon flashes.

- The handset is out of range. Move it closer to the base station.

If the handset displays [UNREGISTERED], register the handset.



Tip

- For more information, see "Register the handsets" on the Advanced settings section.

If I fail to register the additional handsets to the base station, what do I do?

Your base memory is full. Unregister the unused handsets and try again.

No dialing tone

- Check your phone connections.
- The handset is out of range. Move it closer to the base station.

No parking tone

- The handset is not placed properly on the cradle.
- The charging contacts are dirty. Disconnect the power supply first and clean the contacts with a damp cloth.

I cannot change the settings of my voice mail, what do I do?

The voice mail service is managed by your service provider but not the phone itself. Contact your service provider to change the settings.

The handset on the charger does not charge.

- Ensure the batteries are inserted correctly.
- Ensure the handset is placed properly on the charger. The battery icon animates when charging.
- Batteries are defective. Purchase new ones from your dealer.

No display

- Ensure the batteries are charged.
- Ensure there are power and phone connections.

Bad audio (crackles, echo, etc.)

- The handset is nearly out of range. Move it closer to the base station.
- The phone receives interference from the nearby electrical appliances. Move the base station away from them.
- The phone is at a location with thick walls. Move the base away from them.

The handset does not ring.

Ensure the handset ringtone is turned on.

The caller ID does not display.

- The service is not activated. Check with your service provider.
- The caller's information is withheld or unavailable.

The handset loses connection with the base or the sound is distorted during a call.

Check if the **ECO** mode is activated. Turn it off to increase the handset range and enjoy the optimal call conditions.



Note

- If the above solutions do not help, disconnect the power supply from both the handset and base station. Try again after 1 minute.

ANNEX 1

	ANNEX 1
English	Hereby, Philips Consumer Lifestyle, BU P&A, declares that this [type of equipment] is in compliance with the essential requirements and other relevant provisions of Directive 1999/5/EC.
Finnish	Philips Consumer Lifestyle, BU P&A vakuuttaa täten että [type of equipment] tyyppinen laite on direktiivin 1999/5/EY oleellisten vaatimusten ja sitä koskevien direktiivin muiden ehtojen mukainen.
Dutch	Hierbij verklaart, Philips Consumer Lifestyle, BU P&A dat het toestel [type of equipment] in overeenstemming is met de essentiële eisen en de andere relevante bepalingen van richtlijn 1999/5/EG.
French	Par la présente, Philips Consumer Lifestyle, BU P&A, déclare que l'appareil [type of equipment] est conforme aux exigences essentielles et aux autres dispositions pertinentes de la directive 1999/5/CE
Swedish	Härmed intygar, Philips Consumer Lifestyle, BU P&A, att denna (type of equipment] står i överensstämmelse med de väsentliga egenskapskrav och övriga relevanta bestämmelser som framgår av direktiv 1999/5/EG.
Danish	Undertegnede Philips Consumer Lifestyle, BU P&A erklærer herved, at følgende udstyr [type of equipment] overholder de væsentlige krav og øvrige relevante krav i direktiv 1999/5/EF
German	Hiermit erklärt Philips Consumer Lifestyle, BU P&A die Übereinstimmung des Gerätes [Type of equipment] mit den grundlegenden Anforderungen und den anderen relevanten Festlegungen der Richtlinie 1999/5/EG.
Greek	ΜΕ ΤΗΝ ΠΑΡΟΥΣΑ Philips Consumer Lifestyle, BU P&A ΔΗΛΩΝΕΙ ΟΤΙ [type of equipment] ΣΥΜΜΟΡΦΩΝΕΤΑΙ ΠΡΟΣ ΤΙΣ ΟΥΣΙΩΔΕΙΣ ΑΠΑΙΤΗΣΕΙΣ ΚΑΙ ΤΙΣ ΛΟΙΠΕΣ ΣΧΕΤΙΚΕΣ ΔΙΑΤΑΞΕΙΣ ΤΗΣ ΟΔΗΓΙΑΣ 1999/5/ΕΚ
Italian	Con la presente Philips Consumer Lifestyle, BU P&A dichiara che questo (type of equipment) è conforme ai requisiti essenziali ed alle altre disposizioni pertinenti stabilite dalla direttiva 1999/5/CE.
Spanish	Por medio de la presente, Philips Consumer Lifestyle, BU P&A, declara que el (type of equipment) cumple con los requisitos esenciales y cualesquiera otras disposiciones aplicables o exigibles de la Directiva 1999/5/CE
Portuguese	Philips Consumer Lifestyle, BU P&A declara que este [type of equipment] está conforme com os requisitos essenciais e outras disposições da Directiva 1999/5/CE.
	Property of Philips Consumer Lifestyle



CE 0168



© 2009 Koninklijke Philips Electronics N.V.

All rights reserved.

Printed in China

CD560-565_EN_UM_V1.3

Free Manuals Download Website

<http://myh66.com>

<http://usermanuals.us>

<http://www.somanuals.com>

<http://www.4manuals.cc>

<http://www.manual-lib.com>

<http://www.404manual.com>

<http://www.luxmanual.com>

<http://aubethermostatmanual.com>

Golf course search by state

<http://golfingnear.com>

Email search by domain

<http://emailbydomain.com>

Auto manuals search

<http://auto.somanuals.com>

TV manuals search

<http://tv.somanuals.com>