

# **USER'S MANUAL**

## **EB-471LF**

**ULV Celeron® M  
3.5" Embedded Card  
With VGA/ SOUND/ LAN**

**EB-471LF M1**

***EB-471LF Celeron® M***  
***3.5" Embedded Card***  
***With VGA /Sound/LAN***

***OPERATION MANUAL***

**COPYRIGHT NOTICE**

This operation manual is meant to assist both Embedded Computer manufacturers and end users in installing and setting up the system. The information contained in this document is subject to change without any notice.

This manual is copyrighted in April, 2006. You may not reproduce or transmit in any form or by any means, electronic, or mechanical, including photocopying and recording.

**ACKNOWLEDGEMENTS**

All trademarks and registered trademarks mentioned herein are the property of their respective owners.

**CE NOTICE**

This is a class A product. In a domestic environment this product may cause radio interference in which case the user may be required to take adequate measures.

## **FCC NOTICE**

This equipment has been tested and found to comply with the limits for a Class A digital device, pursuant to part 15 of the FCC Rules. These limits are designed to provide reasonable protection against harmful interference when the equipment is operated in a commercial environment. This equipment generates, uses, and can radiate radio frequency energy and, if not installed and used in accordance with the instruction manual, may cause harmful interference to radio communications. Operation of this equipment in a residential area is likely to cause harmful interference in which case the user will be required to correct the interference at his own expense.

You are cautioned that any change or modifications to the equipment not expressly approve by the party responsible for compliance could void your authority to operate such equipment.

## TABLE OF CONTENTS

### CHAPTER 1 INTRODUCTION

1-1	About This Manual .....	1-2
1-2	System Specification .....	1-3
1-3	Safety Precautions .....	1-5

### CHAPTER 2 HARDWARE CONFIGURATION

2-1	Jumper & Connector Quick Reference Table .....	2-2
2-2	Component Locations .....	2-3
2-3	How to Set the Jumpers .....	2-4
2-4	COM Port Connector .....	2-6
2-5	RS232/422/485(COM2) Selection .....	2-7
2-6	Keyboard/ Mouse Connector .....	2-8
2-7	Reset Connector .....	2-8
2-8	Hard Disk Drive LED Connector .....	2-8
2-9	External Speaker Connector .....	2-9
2-10	Power LED Connector .....	2-9
2-11	IrDA Connector .....	2-9
2-12	System Fan Connector .....	2-10
2-13	VGA CRT Connector .....	2-10
2-14	Hard Disk Drive Connector .....	2-11
2-15	Universal Serial Bus Connector .....	2-12
2-16	LAN Connector .....	2-12
2-17	Clear CMOS Data Selection .....	2-13
2-18	Power Requirement Selection .....	2-14
2-19	AT Power Connector .....	2-15
2-20	Inverter Connector .....	2-15
2-21	Reset/NMI Watchdog Selection .....	2-16
2-22	LVDS Connector .....	2-17
2-23	Panel Voltage Selection .....	2-18
2-24	Sound Connector .....	2-19
2-25	TV-Out Connector .....	2-19
2-26	LAN LED .....	2-20

**CHAPTER 3 SOFTWARE UTILITIES**

3-1	Introduction .....	3-2
3-2	VGA Driver Utility .....	3-2
3-3	Flash BIOS Update .....	3-4
3-4	LAN Driver Utility .....	3-6
3-5	Sound Driver Utility .....	3-7
3-6	Intel Chipset Software Installation Utility .....	3-8
3-7	USB2.0 Software Installation Utility .....	3-9
3-8	Watchdog Timer Configuration .....	3-10

**CHAPTER 4 AWARD BIOS SETUP**

4-1	Introduction .....	4-2
4-2	Entering Setup .....	4-3
4-3	The Standard CMOS Features .....	4-4
4-4	The Advanced BIOS Features .....	4-8
4-5	Advanced Chipset Features .....	4-10
4-6	Integrated Peripherals .....	4-13
4-7	Power Management Setup .....	4-17
4-8	PNP/PCI Configuration .....	4-18
4-9	PC Health Status .....	4-20
4-10	Frequency Control .....	4-21
4-11	Load Fail-Safe Defaults .....	4-22
4-12	Load Optimized Defaults .....	4-22
4-13	Password Setting .....	4-23
4-14	Save & Exit Setup .....	4-24
4-15	Exit Without Saving .....	4-25

**APPENDIX A EXPANSION BUS**

PC104+ Bus Pin Assignment .....	A-2
---------------------------------	-----

**APPENDIX B TECHNICAL SUMMARY**

Block Diagram .....	B-2
Interrupt Map .....	B-3
RTC & CMOS RAM Map .....	B-4
Timer & DMA Channels Map .....	B-5
I/O & Memory Map .....	B-6

# *INTRODUCTION*

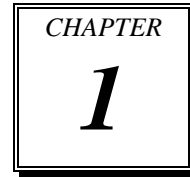

This chapter gives you the information for EB-471LF. It also outlines the System specification.

Section includes:

- About This Manual
- System Specifications
- Safety precautions

**Experienced users can skip to chapter 2 on page 2-1 for Quick Start.**

## **1-1. ABOUT THIS MANUAL**

Thank you for purchasing our EB-471LF Celeron® M3.5” Embedded Card enhanced with VGA /Sound/ LAN, which is fully PC / AT compatible. EB-471LF provides faster processing speed, greater expandability and can handle more task than before. This manual is designed to assist you how to install and set up the system. It contains four chapters. The user can apply this manual for configuration according to the following chapters :

### ***Chapter 1 Introduction***

This chapter introduces you to the background of this manual, and the specification for this system. Final part of this chapter will indicate you how to avoid damaging this Embedded Card.

### ***Chapter 2 Hardware Configuration***

This chapter outlines the component location and their functions. In the end of this chapter, you will learn how to set jumper and how to configure this card to meet your own needs.

### ***Chapter 3 Software Utilities***

This chapter contains helpful information for proper installations of the VGA utility, LAN utility, sound utility, and BIOS update. It also describes the Watchdog timer configuration.

### ***Chapter 4 Award BIOS Setup***

This chapter indicates you how to set up the BIOS configurations.

### ***Appendix A Expansion Bus***

This Appendix introduces you the expansion bus for PC104+ Connector.

### ***Appendix B Technical Summary***

This section gives you the information about the Technical maps.

## **1-2. SYSTEM SPECIFICATION**

- **CPU :**

- Intel® Celeron® M processor
- Ultra Low Voltage without L2 cache onboard
- Available at 600MHz
- System bus frequency at 400MHz
- Auto detect voltage regulator

- **SYSTEM CHIPSET :**

- Intel® 852GM chipset

- **MEMORY :**

- Supports up to 1 GB DDR SDRAM.
- One 200-pin DDR SO-DIMM sockets on board

- **CACHE :**

- Built-in CPU

- **REAL-TIME CLOCK / CALENDAR :**

- 256-byte battery backed CMOS RAM.
- Hardware implementation to indicate century rollover

- **BIOS :**

- Phoenix-AwardBIOS™ for plug & play function
- Memory size with 4 MB, with VGA BIOS

- **KEYBOARD/MOUSE CONNECTOR :**

- PS/2 keyboard with mini DIN connector or one external Y cable.

- **UNIVERSAL SERIAL BUS :**

- Universal Serial Bus Connector on board
- Supports up to two USB 2.0 ports.

- **BUS SUPPORT :**

- PC/104+ Connector.



● **DISPLAY :**

Built in Intel 852GM, support CRT, LCD.

● **IDE INTERFACE :**

One IDE ports support up to two IDE devices.  
Supports UDMA 33/66/100.

● **LAN INTERFACE :**

Intel® 82562ET 10/100 Base-T

● **SOUND:**

AC '97 Codec. Reatel ALC202A.  
Fully Compliant AC '97 Analog I/O Component

● **SERIAL PORT :**

Two high speed 16550 Compatible UARTs with Send / Receive 16 Byte FIFOs. COM1 for RS232; COM2 for RS232/422/485.

● **HARDWARE MONITORING FUNCTION :**

Monitor Voltage, CPU Temperature and Cooling Fan.

● **IRDA PORT :**

One 5-pin Infrared connector  
Supports IrDA v1.0 SIR protocol.

● **LED INDICATOR :**

HDD LED, Power LED.

● **DMA CONTROLLER :**

82C37 x 2

● **DMA CHANNELS :**

7

● **INTERRUPT CONTROLLERS :**

82C59 x 2

● **INTERRUPT LEVELS :**

15

● **OPERATING TEMPERATURE :**

0 to 60°C (32°F to 140°F)

● **INPUT POWER REQUIREMENT :**

AT power: +5V, +12V

Only +5V: +5V only provide power for SBC, It does not have enough power to support expansion card.

● **BOARD DIMENSION :**

102mm x 145mm (4.02" x 5.71")

● **BOARD NET WEIGHT :**

290 grams (0.64 lb)

### **1-3. SAFETY PRECAUTIONS**

Follow the messages below to avoid your systems from damage:

1. Avoid your system from static electricity on all occasions.
2. Prevent electric shock. Don't touch any components of this card when the card is power-on. Always disconnect power when the system is not in use.
3. Disconnect power when you change any hardware devices. For instance, when you connect a jumper or install any cards, a surge of power may damage the electronic components or the whole system.

# ***HARDWARE CONFIGURATION***

CHAPTER

**2**

## **\*\* *QUICK START* \*\***

Helpful information describes the jumper & connector settings, and component locations.

Section includes:

- Jumper & Connector Quick Reference Table
- Component Locations
- Configuration and Jumper settings
- Connector's Pin Assignments

## 2-1. JUMPER & CONNECTOR QUICK REFERENCE TABLE

COM Port Connector .....	COM1, COM2
RS232/422/485 (COM2) Selection .....	JP1
Keyboard/Mouse Connector .....	DIN1
Reset Connector .....	JPANEL1(7,8)
Hard Disk Drive LED Connector .....	JPANEL1(2,4)
External Speaker Connector .....	JPANEL1(5,6)
Power LED Connector .....	JPANEL1 (1,3)
IrDA Connector .....	JIRDA1
System Fan Connector .....	JSFAN1
VGA Connector .....	VGA1
Hard Disk Drive Connector .....	IDE1
Universal Serial Bus Connector .....	USB1
LAN Connector .....	LAN1
Clear CMOS Data Selection .....	JP3
Power Requirement Selection .....	JP2
AT Power Connector .....	PW1
Inverter Connector .....	J2
Reset/NMI/Watchdog Selection .....	JP4
LVDS Connector .....	LVDS1
Panel Voltage Selection .....	JP5
Sound Connector .....	J1
TV-Out Connector .....	JTV1
LAN LED .....	LED1

## 2-2. COMPONENT LOCATIONS

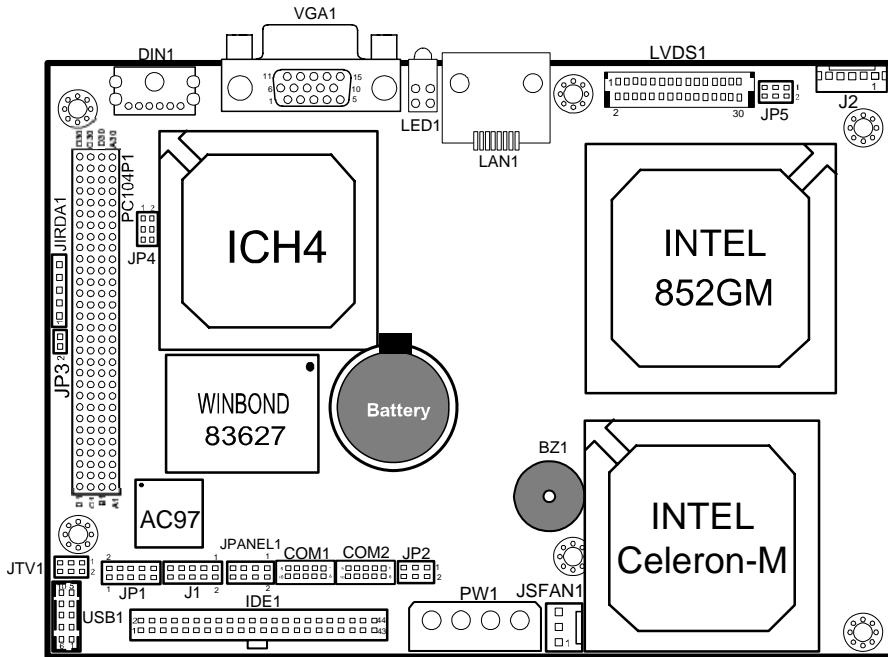

**EB-471LF Connector, Jumper and Component locations**

## 2-3. HOW TO SET THE JUMPERS

You can configure your board by setting jumpers. Jumper is consists of two or three metal pins with a plastic base mounted on the card, and by using a small plastic "cap", Also known as the jumper cap (with a metal contact inside), you are able to connect the pins. So you can set-up your hardware configuration by "open" or "close" pins.

The jumper can be combined into sets that called jumper blocks. When the jumpers are all in the block, you have to put them together to set up the hardware configuration. The figure below shows how this looks like.

### JUMPERS AND CAPS

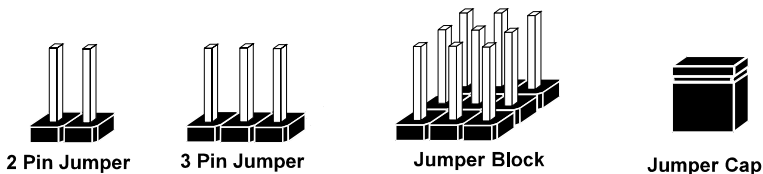

If a jumper has three pins (for examples, labelled PIN1, PIN2, and PIN3), You can connect PIN1 & PIN2 to create one setting and shorting. You can either connect PIN2 & PIN3 to create another setting. The same jumper diagrams are applied all through this manual. The figure below shows what the manual diagrams look and what they represent.

### JUMPER DIAGRAMS



Jumper Cap  
looks like this



2 pin Jumper  
looks like this

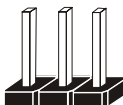

3 pin Jumper  
looks like this

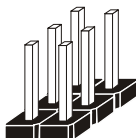

Jumper Block  
looks like this

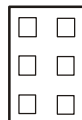

### JUMPER SETTINGS



2 pin Jumper close(enabled)  
Looks like this



1



3 pin Jumper  
2-3 pin close(enabled)  
Looks like this



1



Jumper Block  
1-2 pin close(enabled)  
Looks like this



1 2

## 2-4. COM PORT CONNECTOR

**COM1** : COM1 Connector

COM1 is fixed as RS-232.

The pin assignment is as follows :

PIN	ASSIGNMENT
1	DCD1
2	RX1
3	TX1
4	DTR1
5	GND
6	DSR1
7	RTS1
8	CTS1
9	RI1
10	NC

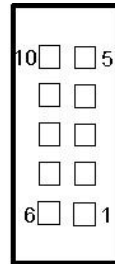

**COM1**

**COM2** : COM2 Connector

The COM2 is selectable as RS-232/422/485.

The pin assignment is as follows :

PIN	ASSIGNMENT		
	RS-232	RS-422	RS-485
1	DCD2	TX-	TX-
2	RX2	TX+	TX+
3	TX2	RX+	RX+
4	DTR2	RX-	RX-
5	GND	GND	GND
6	DSR2	RTS-	NC
7	RTS2	RTS+	NC
8	CTS2	CTS+	NC
9	RI2	CTS-	NC
10	NC	NC	NC

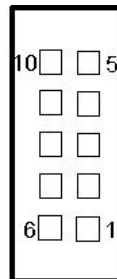

**COM2**



## 2-5. RS232/422/485 (COM2) SELECTION

### JP1 : RS-232/422/485 (COM2) Selection

This connector is used to set the COM2 function.

The jumper settings are as follows :

COM 2 Function	Jumper Settings (pin closed)	Jumper Illustrations
RS-232	Open	<p>JP1</p>
RS-422	1-2, 3-4, 9-10	<p>JP1</p>
RS-485	1-2, 5-6, 7-8	<p>JP1</p>

\*\*\* Manufactory default --- RS-232.

## 2-6. KEYBOARD/MOUSE CONNECTOR

**DIN1** : Keyboard/Mouse Connector  
The pin assignments are as follows :

PIN	ASSIGNMENT
1	KB_DATA
2	MS_DATA
3	GND
5	K/B_VCC
6	KB_CLK
8	MS_CLK



## 2-7. RESET CONNECTOR

**JPANEL1 (7,8)** : Reset Connector.  
The pin assignment is as follows :

PIN	ASSIGNMENT
7	GND
8	RST_SW

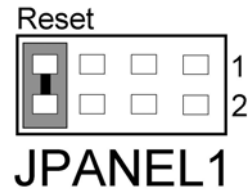

## 2-8. HARD DISK DRIVE LED CONNECTOR

**JPANEL (2, 4)** : Hard Disk Drive LED Connector  
The pin assignment is as follows :

PIN	ASSIGNMENT
2	VCC3_3_R
4	HD_LED

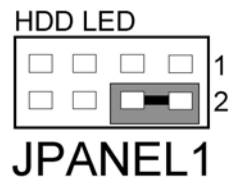

## 2-9. EXTERNAL SPEAKER CONNECTOR

**JPANEL1 (5, 6) :** External Speaker Connector  
The pin assignment is as follows :

PIN	ASSIGNMENT
5	SPK1
6	SPK_VCC

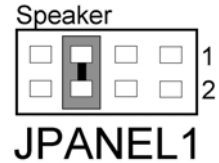

## 2-10. POWER LED CONNECTOR

**JPANEL1 (1, 3) :** Power LED Connector  
The pin assignment is as follows:

PIN	ASSIGNMENT
1	VCC_R
3	GND

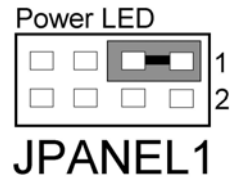

## 2-11. IRDA CONNECTOR

**JIRDA1:** IrDA (Infrared) Connector  
The pin assignments are as follows:

PIN	ASSIGNMENT
1	+5V
2	NC
3	IRRX
4	GND
5	IRTX

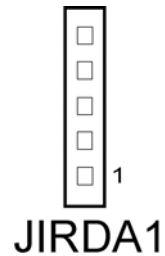

## 2-12. SYSTEM FAN CONNECTOR

**JSFAN1** : System Fan connector  
The pin assignment is as follows:

PIN	ASSIGNMENT
1	GND
2	+12V
3	FAN0



**JSFAN1**

## 2-13. VGA CONNECTOR

**VGA1** : VGA CRT Connector  
The pin assignments are as follows:

PIN	ASSIGNMENT
1	RED
2	GREEN
3	BLUE
4	NC
5	GND
6	GND
7	GND
8	GND
9	VGA_P5V
10	GND
11	NC
12	VGA_5VDDCDA
13	VGA_HSYNC_5V
14	VGA_VSYNC_5V
15	VGA_5VDDCLK
16	NC

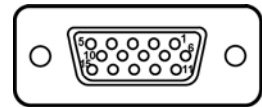

**VGA1**

## 2-14. HARD DISK DRIVE CONNECTOR

### IDE1: Hard Disk Drive Connector

The pin assignments are as follows:



IDE1

PIN	ASSIGNMENT	PIN	ASSIGNMENT
1	IDERSTJ	2	GND
3	PDD7	4	PDD8
5	PDD6	6	PDD9
7	PDD5	8	PDD10
9	PDD4	10	PDD11
11	PDD3	12	PDD12
13	PDD2	14	PDD13
15	PDD1	16	PDD14
17	PDD0	18	PDD15
19	GND	20	NC
21	PDREQ	22	GND
23	PDIOWJ	24	GND
25	PDIORJ	26	GND
27	PIORDY	28	PULL LOW
29	PDDACKJ	30	GND
31	IRQ14	32	NC
33	PDA1	34	P66 DET
35	PDA0	36	PDA2
37	PDCSJ1	38	PDCSJ3
39	IDEACTPJ	40	GND
41	+5V	42	+5V
43	GND	44	NC

## 2-15. UNIVERSAL SERIAL BUS CONNECTOR

**USB1:** Universal Serial Bus Connector  
The pin assignments are as follows:

PIN	ASSIGNMENT
1	VCCUSB0
2	USBP0N
3	USBP0P
4	GND
5	GND
6	VCCUSB0
7	USBP1N
8	USBP1P
9	GND
10	GND

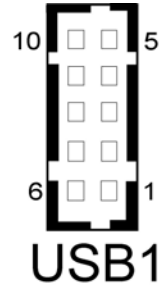

## 2-16. LAN CONNECTOR

**LAN1:** LAN Connector  
The pin assignments are as follows:

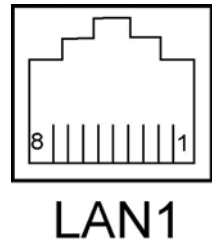

PIN	ASSIGNMENT
1	TX+
2	TX-
3	RX+
4	ISOLATED_GND
5	ISOLATED_GND
6	RX-
7	ISOLATED_GND
8	ISOLATED_GND



## 2-17. CLEAR CMOS DATA SELECTION

### JP3 : Clear CMOS Data Selection

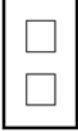
The selections are as follows :

FUNCTION	JUMPER SETTING (pin closed)	JUMPER ILLUSTRATION
Normal	Open	 1 <b>JP3</b>
Clear CMOS	Close	 1 <b>JP3</b>

\*\*\* Manufacturing Default is set as Normal.

Note: To clear CMOS data, user must power-off the computer and set the jumper to "Clear CMOS" as illustrated above. After five to six seconds, set the jumper back to "Normal" and power-on the computer.

## 2-18. POWER REQUIREMENT SELECTION

**JP2** : Power Requirement Selection

The selections are as follows:

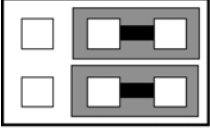
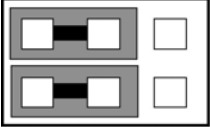
Power Selection	JUMPER SETTINGS (pin closed)	JUMPER ILLUSTRATION
+5V & +12V	1-3, 2-4	 <p>JP2</p>
+5V Only	3-5, 4-6	 <p>JP2</p>

\*\* Manufacturing default: +5V Only \*\*



## 2-19. AT POWER CONNECTOR

**PW1** : AT Power Connector

The pin assignments are as follows:

PIN	ASSIGNMENT
1	VCC12EX
2	GND
3	GND
4	VCC



**PW1**

## 2-20. INVERTER CONNECTOR

**J2** : Inverter Connector

The pin assignment is as follows:

PIN	ASSIGNMENT
1	+12
2	GND
3	+5V
4	GND
5	LVDS_BKLTEN

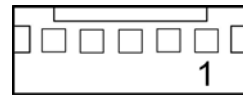

**J2**

## 2-21. RESET/NMI WATCHDOG SELECTION

### JP4 : Reset/NMI Watchdog Selection

The selections are as follows:

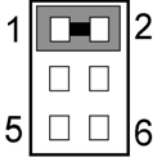
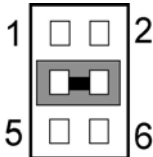
FUNCTION	JUMPER SETTING (pin closed)	JUMPER ILLUSTRATION
RESET	1-2	 <b>JP4</b>
NMI	3-4	 <b>JP4</b>

\*\* Manufacturing default: Reset.

ⓘ User may select to use the Reset or NMI watchdog. NMI, also known as Non-Maskable Interrupt, is used for serious conditions that demand the processor's immediate attention, it cannot be ignored by the system unless it is shut off specifically.

## 2-22. LVDS CONNECTOR

LVDS1 : LVDS Connector.

The pin assignments are as follows:



LVDS1

PIN	ASSIGNMENT	PIN	ASSIGNMENT
1	LVDS_VCC	2	GND
3	ZCM	4	ZCP
5	GND	6	Z2M
7	Z2P	8	GND
9	Z1M	10	Z1P
11	Z3P	12	Z3M
13	Z0P	14	Z0M
15	GND	16	YCP
17	YCM	18	GND
19	Y2P	20	Y2M
21	GND	22	Y1P
23	Y1M	24	GND
25	Y0P	26	Y0M
27	Y3P	28	Y3M
29	LVDS_VCC	30	LVDS_VCC

## 2-23. PANEL VOLTAGE SELECTION

**JP5** : Panel Voltage Selection.

The selections are as follows:

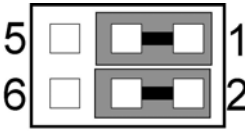
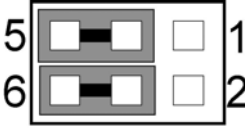
SELECTION	JUMPER SETTING	JUMPER ILLUSTRATION
LVDS_VCC3	1-3, 2-4	 <b>JP5</b>
LVDS_VCC5	3-5, 4-6	 <b>JP5</b>

## 2-24. SOUND CONNECTOR

**J1** : Sound Connector.

The pin assignments are as follows:

PIN	ASSIGNMENT
1	MIC-IN
2	NC
3	GND
4	GND
5	LINE-L
6	LINE-R
7	GND
8	GND
9	SPK-L
10	SPK-R

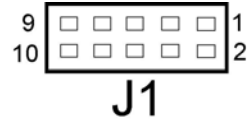

## 2-25. TV-OUT CONNECTOR

**JTV1** : TV-Out Connector.

The pin assignments are as follows:

PIN	ASSIGNMENT
1	TVYFCC2
2	TVCVB
3	GND
4	GND
5	TVCFCC2
6	NC

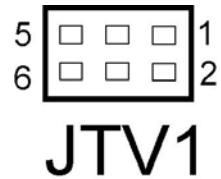

## 2-26. LAN LED

### LED1 : LAN LED

The pin assignments are as follows:

PIN	ASSIGNMENT
1+	ACTLEDJ
1-	LILEDJ
2+	RJ45VCCA
2-	SPLEDJ

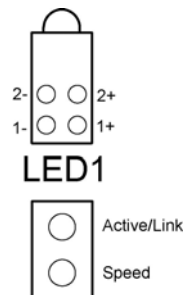

# ***SOFTWARE UTILITIES***

CHAPTER

**3**

This chapter comprises the detailed information of VGA driver, LAN driver, and Flash BIOS update. It also describes how to install the watchdog timer configuration.

Section includes:

- VGA Driver Utility
- Flash BIOS Update
- LAN Driver Utility
- Sound Driver Utility
- Intel® Chipset Software Installation Utility
- USB2.0 Chipset Software Installation Utility
- Watchdog Timer Configuration

### 3-1. INTRODUCTION

Enclosed with our EB-471LF package is our driver utility, which may come in a form of a CD ROM disc or floppy diskettes. For CD ROM disc user, you will only need some of the files contained in the CD ROM disc, please kindly refer to the following chart:

<b>Filename (Assume that CD ROM drive is D:)</b>	<b>Purpose</b>
D:\VGA	Intel 852GM For VGA driver installation
D:\AWDFLASH	For BIOS update utility
D:\LAN	For LAN Driver installation
D:\SOUND	Realtek ALC202A AC97 For Sound driver installation
D:\UTILITY	Intel® Chipset Software Installation Utility For Win 98SE, ME, 2000, XP
D:\USB 2.0	USB 2.0 Software Installation Utility For Win 98SE, 2000, ME, XP

⚠ User should remember to install the Utility right after the OS fully installed.

### 3-2. VGA DRIVER UTILITY

The VGA interface embedded with our EB-471LF can support a wide range of display. You can display CRT, LVDS simultaneously with the same mode.



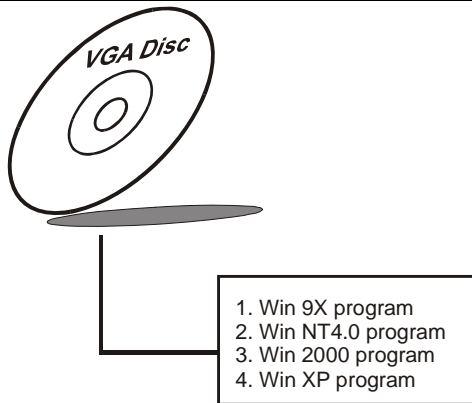

### 3-2-1. Installation of VGA Driver:

To install the VGA Driver, simply follow the following steps:

1. Place insert the Utility Disk into Floppy Disk Drive A/B or CD ROM drive.
2. Under Windows 9X/NT4.0/2000/XP system, go to the directory where VGA driver is located.
3. Click **Setup.exe** file for VGA driver installation.
4. Follow the instructions on the screen to complete the installation.
5. Once installation is completed, shut down the system and restart in order for the changes to take effect.

⚠ Under the Windows 98 system, after reboot computer, there will have two error messages appear, "Can't find ikch8xx.cat and isb8xx.cat", just skip the messages, they will not cause any effects.

### 3-3. FLASH BIOS UPDATE

#### 3-3-1. System BIOS Update:

Users of EB-471LF can use the program “Awdflash.exe” contained in the Utility Disk for system BIOS and VGA BIOS update.

#### 3-3-2. To update VGA BIOS for LCD Flat Panel Display:

As EB-471LF user, you have to update the VGA BIOS for your specific LCD flat panel you are going to use. For doing this, you need two files. One is the “Awdflash.exe” file and the other is the VGA BIOS for ATI Rage Mobility M6 file for LCD panel display. Both file must be provided by the vendor or manufacturer. When you get these two files ready, follow the following steps for updating your VGA BIOS:

1. Install “Awdflash.exe” from Utility Disk to Drive C.
2. Insert the VGA BIOS file you have obtained from the vendor.  
Type the path to Awdflash.exe and execute the VGA BIOS update with file H15bxxxx.bin
3. C:\UTIL\AWDFLASH>AWDFLASH H15bxxxx.bin
4. The screen will display as the table found on the next page:

FLASH MEMORY WRITER v7.XX (C) Award Software 2001 All Rights Reserved
Flash Type – SST 49LF004A /3.3V File Name to Program: H20bxxxx.bin Checksum: XXXXX
Error Message: Do You Want To Save BIOS (Y/N)

If you want to save up the original BIOS, enter "Y" and press < Enter >. If you choose "N", the following table will appear on screen.

FLASH MEMORY WRITER v7.XX (C) Award Software 2001 All Rights Reserved
Flash Type – SST 49LF004A /3.3V File Name to Program: H20bxxxx.bin Checksum: XXXXX
Error Message : Are You Sure To Program (Y/N)

Select "Y", and the BIOS will be renewed. When you are refreshing the BIOS, do not turn off or reset the system, or you will damage the BIOS. After you have completed all the programming, the screen displays the table below:

FLASH MEMORY WRITER v7.XX (C) Award Software 2001 All Rights Reserved
Flash Type – SST 49LF004A /3.3V File Name to Program: H20bxxxx.bin Checksum: XXXXX  Reset System or Power off to accomplish update process!
F1: Reset F10: Exit

Please reset or power off the system, and then the Flash BIOS is fully implemented.

## 3-4. LAN DRIVER UTILITY

### 3-4-1. Introduction

EB-471LF is enhanced with LAN function that can support various network adapters. Installation programs for LAN drivers are listed as follows:

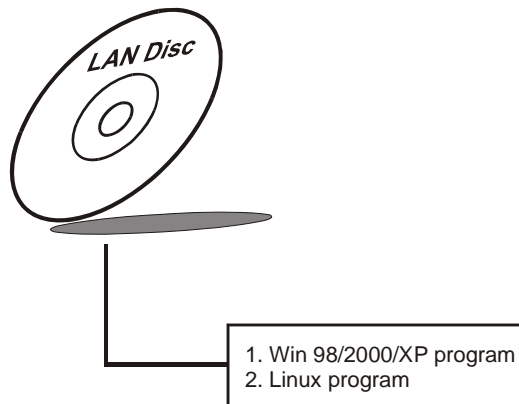

**For more details on Installation procedure, please refer to [Readme.txt](#) file found on LAN DRIVER UTILITY.**

## 3-5. SOUND DRIVER UTILITY

### 3-5-1. Introduction

The Realtek ALC202A sound function enhanced in this system is fully compatible with Windows 98, Windows 98SE, Windows NT 4.0, Windows 2000, Windows ME and Windows XP. Below, you will find the content of the Sound driver :

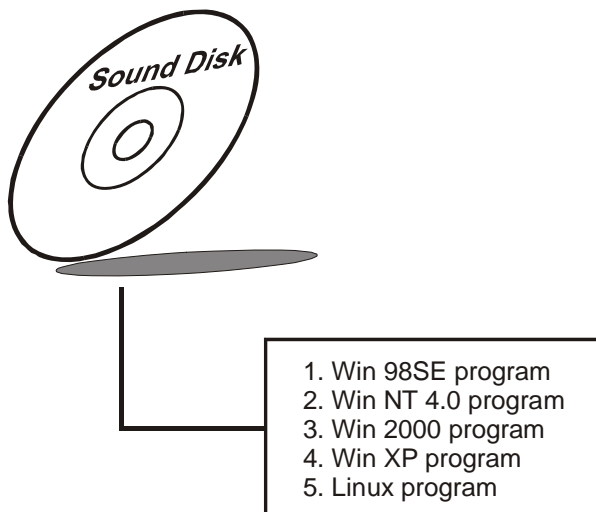

### 3-5-2. Installation Procedure for Windows 9x/NT/2000/XP

1. From the task bar, click on Start, and then Run.
2. In the Run dialog box, type D:\Sound\path\setup, where "D:\Sound\pathname" refers to the full path to the source files.
3. Click on the OK button or press the ENTER key.
4. Click on the "Next" and OK prompts as they appear.
5. Reboot the system to complete the driver installation.

## **3-6. INTEL® CHIPSET SOFTWARE INSTALLATION UTILITY**

### **3-6-1. Introduction**

The Intel® Chipset Software Installation Utility installs to the target system the Windows\* INF files that outline to the operating system how the chipset components will be configured. This is needed for the proper functioning of the following features:

- Core PCI and ISAPNP Services
- AGP Support
- IDE/ATA33/ATA66/ATA100 Storage Support
- USB Support
- Identification of Intel® Chipset Components in Device Manager

### **3-6-2. Installation of Utility for Windows 98SE/ME/2000/XP**

The Utility Pack is to be installed only for Windows 98SE, Windows ME, Windows 2000 and XP program.

It should be installed right after the OS installation, kindly follow the following steps:

1. Place insert the Utility Disk into Floppy Disk Drive A/B or CD ROM drive.
2. Under Windows 98SE/ME/2000/XP system, go to the directory where Utility Disc is located.
3. Click **Setup.exe** file for utility installation.
4. Follow the instructions on the screen to complete the installation.
5. Once installation is completed, shut down the system and restart in order for the changes to take effect.

## **3-7. USB2.0 SOFTWARE INSTALLATION UTILITY**

### **3-7-1. Installation of Utility for Windows 98SE/ 2000/XP**

Intel USB 2.0 Enhanced Host Controller driver can only be used on Windows 98SE, Windows 2000 and Windows XP on Intel Desktop boards. It should be installed right after the OS installation, kindly follow the following steps:

1. Place insert the Utility Disk into Floppy Disk Drive A/B or CD ROM drive.
2. Under Windows 98SE, 2000, and XP system, go to the directory where Utility Disc is located.
3. Start the "System" wizard in control panel. (Click Start/Settings/Control Panel).
4. Select "Hardware" and click "Device Manager" button.
5. Double Click "USB Root Hub".
6. Select "Driver".
7. Click "Install" to install the driver.
8. Follow the instructions on the screen to complete the installation.
9. Click "Finish" after the driver installation is complete.

### 3-8. WATCHDOG TIMER CONFIGURATION

The I/O port address of the watchdog timer is 2E(hex) and 2F(hex). 2E (hex) is the address port. 2F(hex) is the data port. User must first assign the address of register by writing address value into address port 2E(hex), then write/read data to/from the assigned register through data port 2F (hex).

#### Configuration Sequence

To program W83627HF configuration registers, the following configuration sequence must be followed:

- (1) Enter the extended function mode
- (2) Configure the configuration registers
- (3) Exit the extended function mode

#### (1) Enter the extended function mode

To place the chip into the extended function mode, two successive writes of 0x87 must be applied to Extended Function Enable Registers (EFERs, i.e. 2Eh).

#### (2) Configure the configuration registers

The chip selects the logical device and activates the desired logical devices through Extended Function Index Register (EFIR) and Extended Function Data Register (EFDR). EFIR is located at the same address as EFER, and EFDR is located at address (EFIR+1).

First, write the Logical Device Number (i.e.,0x07) to the EFIR and then write the number of the desired logical device to the EFDR. Secondly, write the address of the desired configuration register within the logical device to the EFIR and then write (or read) the desired configuration register through EFDR.

#### (3) Exit the extended function mode

To exit the extended function mode, one write of 0xAA to EFER is required. Once the chip exits the extended function mode.

#### Example Program

1. Enable watchdog timer and set 30 sec. as timeout interval

```
-----  
Mov dx, 2eh ; Enter to extended function mode  
Mov al, 87h  
Out dx, al  
Out dx, al  
-----
```



```
Mov al, 07h ; Select Logical Device 8 of watchdog timer
Out dx,al
Inc dx
Mov al, 08h
Out dx,al
;-----
Dec dx ; Set second as counting unit
Mov al, 0f5h
Out dx,al
Inc dx
In al,dx
And al,not 08h
Out dx,al
;-----
Dec dx ; Set timeout interval as 30seconds and start counting
Mov al, 0f6h
Out dx,al
Inc dx
Mov al, 30
Out dx,al
;-----
Dec dx ; Exit the extended function mode
Mov al, 0aah
Out dx,al
```

# ***AWARD BIOS SETUP***

CHAPTER

**4**

This chapter shows how to set up the Award BIOS.

Section includes:

- Introduction
- Entering Setup
- The Standard CMOS Features
- The Advanced BIOS Features
- The Advanced Chipset Features
- Integrated Peripherals
- Power Management Setup
- PNP/PCI Configuration
- PC Health Status
- Frequency Control
- Load Fail-Safe Defaults
- Load Optimized Defaults
- Set Supervisor Password
- Set User Password
- Save and Exit Setup
- Exit Without Saving

## **4-1. INTRODUCTION**

This chapter will show you the function of the BIOS in managing the features of your system. The EB-471LF Celeron® M Embedded CPU Card is equipped with the BIOS for system chipset from Award Software Inc. This page briefly explains the function of the BIOS in managing the special features of your system. The following pages describe how to use the BIOS for system chipset Setup menu.

Your application programs (such as word processing, spreadsheets, and games) rely on an operating system such as DOS or OS/2 to manage such things as keyboard, monitor, disk drives, and memory.

The operating system relies on the BIOS (Basic Input and Output system), a program stored on a ROM (Read-only Memory) chip, to initialize and configure your computer's hardware. As the interface between the hardware and the operating system, the BIOS enables you to make basic changes to your system's hardware without having to write a new operating system.

The following diagram illustrates the interlocking relationships between the system hardware, BIOS, operating system, and application program:

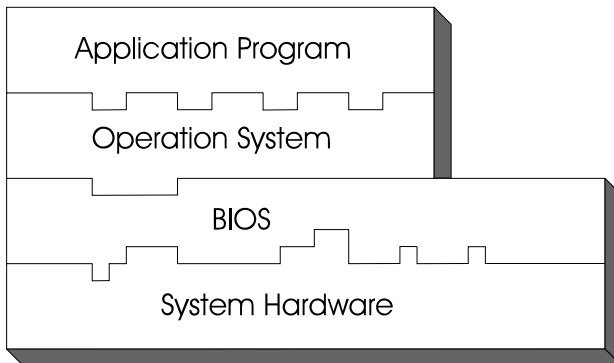

## 4-2. ENTERING SETUP

When the system is powered on, the BIOS will enter the Power-On Self Test (POST) routines and the following message will appear on the lower screen:

**PRESS <DEL> TO ENTER SETUP, ESC TO SKIP MEMORY TEST**

As long as this message is present on the screen you may press the <Del> key (the one that shares the decimal point at the bottom of the number keypad) to access the Setup program. In a moment, the main menu of the Award SETUP program will appear on the screen:

Phoenix - AwardBIOS CMOS Setup Utility	
<ul style="list-style-type: none"> <li>▶ Standard CMOS Features</li> <li>▶ Advanced BIOS Features</li> <li>▶ Advanced Chipset Features</li> <li>▶ Integrated Peripherals</li> <li>▶ Power Management Setup</li> <li>▶ PnP/PCI Configurations</li> <li>▶ PC Health Status</li> </ul>	<ul style="list-style-type: none"> <li>▶ Frequency Control</li> <li>Load Fail-Safe Defaults</li> <li>Load Optimized Defaults</li> <li>Set Supervisor Password</li> <li>Set User Password</li> <li>Save &amp; Exit Setup</li> <li>Exit Without Saving</li> </ul>
Esc : Quit F10 : Save & Exit Setup	↑↓→← : Select Item
Time, Date, Hard Disk Type ....	

### Setup program initial screen

You may use the cursor the up/down keys to highlight the individual menu items. As you highlight each item, a brief description of the highlighted selection will appear at the bottom of the screen.

### 4-3. THE STANDARD CMOS FEATURES

Highlight the "STANDARD CMOS FEATURES" and press the <ENTER> key and the screen will display the following table:

Phoenix - AwardBIOS CMOS Setup Utility  
Standard CMOS Features

Date (mm:dd:yy)	Sun, Jan 5 2005	Item Help
Time (hh:mm:ss)	21 : 6 : 40	Menu Level ▶
▶ IDE Primary Master	[None]	Change the internal clock.
▶ IDE Primary Slave	[None]	
▶ IDE Secondary Master	[None]	
▶ IDE Secondary Slave	[None]	
Drive A	[None]	
Drive B	[None]	
Video	[EGA/VGA]	
Halt On	[All, But Keyboard]	
Base Memory	640K	
Extended Memory	489472K	
Total Memory	490496K	
↑↓→←: Move Enter: Select +/-/PU/PD:Value F10:Save ESC:Exit F1:General Help F5: Previous Values F6: Fail-Safe Defaults F7:Optimized Defaults		

CMOS Setup screen

In the above Setup Menu, use the arrow keys to highlight the item and then use the <PgUp> or <PgDn> keys to select the value you want in each item.

**Date:**

< Month >, < Date > and <Year >. Ranges for each value are in the CMOS Setup Screen, and the week-day will skip automatically.

**Time:**

< Hour >, < Minute >, and < Second >. Use 24 hour clock format, i.e., for PM numbers, add 12 to the hour. For example: 4: 30 P.M. You should enter the time as 16:30:00.

**IDE Primary Master / Slave:**

**IDE Secondary Master / Slave:**

The BIOS can automatically detect the specifications and optimal operating mode of almost all IDE hard drives. When you select type AUTO for a hard drive, the BIOS detect its specifications during POST, every time system boots.

If you do not want to select drive type AUTO, other methods of selecting drive type are available:

1. Match the specifications of your installed IDE hard drive(s) with the preprogrammed values for hard drive types 1 through 45.
2. Select USER and enter values into each drive parameter field.
3. Use the IDE HDD AUTO DETECTION function in Setup.

Here is a brief explanation of drive specifications:

Type: The BIOS contains a table of pre-defined drive types. Each defined drive type has a specified number of cylinders, number of heads, write precompensation factor, landing zone, and number of sectors. Drives whose specifications do not accommodate any predefine type are classified as type USER.

- Size: Disk drive capacity (approximate). Note that this size is usually greater than the size of a formatted disk given by a disk-checking program.
- Cyls: number of cylinders.
- Head: number of heads.
- Precomp: write precompensation cylinders.
- Landz: landing zone.
- Sector: number of sectors.
- Mode: Auto, Normal, Large or LBA.

Auto: The BIOS automatically determines the optimal mode.

- Normal: Maximum number of cylinders, heads, sectors supported are 1024, 16 and 63.
- Large: For drives that do not support LBA and have more than 1024 cylinders.

- LBA (Logical Block Addressing): During drive accesses, the IDE controller transforms the data address described by sector, head and cylinder number into a physical block address, significantly improving data transfer rates. For drives greater than 1024 cylinders.

**DRIVE A AND DRIVE B:**

Select the type of floppy disk drive installed in your system. The available options are 360KB 5.25in, 1.2KB 5.25in, 720KB 3.5in, 1.44MB 3.5in, 2.88MB 3.5in and None.

**VIDEO:**

This category selects the type of video adapter used for the primary system monitor. Although secondary monitors are supported, you do not have to select the type in Setup. Available Options are as follows:

EGA/VGA	Enhanced Graphics Adapter/Video Graphics Array. For EGA, VGA, SEGA, SVGA or PGA monitor adapters.
CGA 40	Color Graphics Adapter, power up in 40 column mode.
CGA 80	Color Graphics Adapter, power up in 80 column mode.
MONO	Monochrome adapter, includes high resolution monochrome adapters.

**HALT ON:**

This category allows user to choose whether the computer will stop if an error is detected during power up. Available options are “All errors”, “No errors”, “All, But keyboard”, “All, But Diskette”, and “All But Disk/Key”.

**BASE MEMORY:**

Displays the amount of conventional memory detected during boot up.

**EXTENDED MEMORY:**

Displays the amount of extended memory detected during boot up.

**TOTAL MEMORY:**

Displays the total memory available in the system.

**HARD DISK ATTRIBUTES:**

Type	Cylinders	Heads	V-P comp	LZone	Sect	Capacity
1	306	4	128	305	17	10
2	615	4	300	615	17	20
3	615	6	300	615	17	30
4	940	8	512	940	17	62
5	940	6	512	940	17	46
6	615	4	65535	615	17	20
7	642	8	256	511	17	30
8	733	5	65535	733	17	30
9	900	15	65535	901	17	112
10	820	3	65535	820	17	20
11	855	5	65535	855	17	35
12	855	7	65535	855	17	49
13	306	8	128	319	17	20
14	733	7	65535	733	17	42
15	000	0	0000	000	00	00
16	612	4	0000	663	17	20
17	977	5	300	977	17	40
18	977	7	65535	977	17	56
19	1024	7	512	1023	17	59
20	733	5	300	732	17	30
21	733	7	300	732	17	42
22	733	5	300	733	17	30
23	306	4	0000	336	17	10
24	977	5	65535	976	17	40
25	1024	9	65535	1023	17	76
26	1224	7	65535	1223	17	71
27	1224	11	65535	1223	17	111
28	1224	15	65535	1223	17	152
29	1024	8	65535	1023	17	68
30	1024	11	65535	1023	17	93
31	918	11	65535	1023	17	83
32	925	9	65535	926	17	69
33	1024	10	65535	1023	17	85
34	1024	12	65535	1023	17	102
35	1024	13	65535	1023	17	110
36	1024	14	65535	1023	17	119
37	1024	2	65535	1023	17	17
38	1024	16	65535	1023	17	136
39	918	15	65535	1023	17	114
40	820	6	65535	820	17	40
41	1024	5	65535	1023	17	42
42	1024	5	65535	1023	26	65
43	809	6	65535	852	17	40
44	809	6	65535	852	26	61
45	776	8	65335	775	33	100
47			AUTO			

**Award Hard Disk Type Table**



### 4-4. THE ADVANCED BIOS FEATURES

Choose the “ADVANCED BIOS FEATURES” in the main menu, the screen shown as below.

Phoenix - AwardBIOS CMOS Setup Utility  
Advanced BIOS Features

CPU L1 & L2 Cache	[Enabled]	Item Help
Quick Power On Self Test	[Enabled]	
First Boot Device	[USB-FDD]	Menu Level ►
Second Boot Device	[HDD-0]	Allows you to choose the VIRUS warning feature for IDE Hard Disk boot sector protection. If this function is enabled and someone attempt to write data into this area, BIOS will show a warning message on screen and alarm beep
Boot Up NumLock Status	[On]	
Typematic Rate Setting	[Disabled]	
x Typematic Rate (Chars/Sec)	6	
x Typematic Delay (Msec)	250	
Security Option	[Setup]	
OS Select For DRAM > 64MB	[Non-OS2]	
↑↓→←: Move    Enter: Select    +/-/PU/PD:Value    F10:Save    ESC:Exit    F1:General Help F5: Previous Values    F6: Fail-Safe Defaults    F7:Optimized Defaults		

**BIOS Features Setup Screen**

The “BIOS FEATURES SETUP” allow you to configure your system for basic operation. The user can select the system’s default speed, boot-up sequence, keyboard operation, shadowing and security.

A brief introduction of each setting is given below.

**CPU L1 & L2 CACHE :**

This item allows you to enable L1 & L2 cache.

**QUICK POWER ON SELF-TEST:**

This item allows you to speed up Power On Self Test (POST) after power-up the computer. When enabled, the BIOS will shorten or skip some check items during POST.

**FIRST/SECOND/ BOOT DEVICE:**

The BIOS attempt to load the operating system from the devices in the sequence selected in these items.

**BOOT UP NUMLOCK STATUS:**

Select power on state for NumLock.

**TYPOMATIC RATE SETTING:**

Enable this item if you wish to be able to configure the characteristics of your keyboard. Typematic refers to the way in which characters are entered repeatedly if a key is held down. For example, if you press and hold down the "A" key, the letter "a" will repeatedly appear on your screen on your screen until you release the key. When enabled, the typematic rate and typematic delay can be selected.

**TYPOMATIC RATE (CHARS/SEC):**

This item sets the number of times a second to repeat a key stroke when you hold the key down.

**TYPOMATIC DELAY (MSEC):**

The item sets the delay time after the key is held down before it begins to repeat the keystroke.

**SECURITY OPTION:**

This category allows you to limit access to the system and Setup, or just to Setup.

System	The system will not boot and access to Setup will be denied if the correct password is not entered at the prompt.
Setup	The system will boot, but access to Setup will be denied if the correct password is not entered at the prompt.

🔔 To disable security, select PASSWORD SETTING at Main Menu and then you will be asked to enter password. Do not type anything and just press <Enter>, it will disable security. Once the security is disabled, the system will boot and you can enter Setup freely.

**OS SELECT FOR DRAM >64MB :**

Select the operating system that is running with greater than 64MB or RAM on the system. You may choose OS2 or Non-OS2.

### 4-5. ADVANCED CHIPSET FEATURES

Choose the "ADVANCED CHIPSET FEATURES" from the main menu, the screen shown as below.

Phoenix - AwardBIOS CMOS Setup Utility  
Advanced Chipset Features

DRAM Timing Selectable	[By SPD]	Item Help
X CAS Latency Time	2	
X Active to Precharge Delay	6	
X DRAM RAS# to CAS# Delay	3	Menu Level ▶
X DRAM RAS# Precharge	2	
DRAM Data Integrity Mode	Non-ECC	
System BIOS Cacheable	[Enabled]	
Video BIOS Cacheable	[Disabled]	
Memory Hole At 15M-16M	[Disabled]	
Delayed Transaction	[Enabled]	
AGP Aperture Size (MB)	[64]	
** On-Chip VGA Setting **		
On-Chip VGA	[Enabled]	
On-Chip Frame Buffer Size	[32MB]	
Boot Display	[TV]	
Panel Type	[1024 x 768 24bits]	
PCI SERR# NMI	[Disabled]	
↑↓→←: Move    Enter: Select    +/-/PU/PD: Value    F10: Save    ESC: Exit    F1: General Help F5: Previous Values    F6: Fail-Safe Defaults    F7: Optimized Defaults		

#### Chipset Features Setup Screen

This parameter allows you to configure the system based on the specific features of the installed chipset. The chipset manages bus speed and access to system memory resources, such as DRAM and the external cache.

It also coordinates communications between conventional ISA bus and the PCI bus. It must be stated that these items should never need to be altered. The default settings have been chosen because they provide the best operating conditions for the system. The only time you might consider making any changes would be if you discovered that data was being lost while using your system.

**DRAM TIMING BY SELECTABLE:**

This allows you to select the DRAM timing.

**CAS LATENCY TIME:**

When synchronous DRAM is installed, the number of clock cycles of CAS latency depends on the DRAM timing.

**ACTIVE TO PRECHARGE DELAY:**

This item controls the number of DRAM clocks for TRAS.

**DRAM RAS# TO CAS# DELAY:**

This field let's you insert a timing delay between the CAS and RAS strobe signals, used when DRAM is written to, read from, or refreshed. Fast gives faster performance; and Slow gives more stable performance. This field applies only when synchronous DRAM is installed in the system.

**DRAM RAS# PRECHARGE:**

If an insufficient number of cycles is allowed for the RAS to accumulate its charge before DRAM refresh, the refresh may be incomplete and the DRAM may fail to retain data. Fast gives faster performance; and Slow gives more stable performance. This field applies only when synchronous DRAM is installed in the system.

**DRAM DATA INTEGRITY MODE:**

Select Parity or ECC (error-correcting code), according to the type of installed DRAM.

**SYSTEM BIOS CACHEABLE:**

Selecting Enabled allows caching of the system BIOS ROM at F0000h-FFFFFh, resulting in better system performance. However, if any program writes to this memory area, a system error may result.

**VIDEO BIOS CACHEABLE:**

Select Enabled allows caching of the video BIOS, resulting in better system performance. However, if any program writes to this memory area, a system error may result.

**MEMORY HOLE AT 15M-16M:**

You can reserve this area of system memory for ISA adapter ROM. When this area is reserved, it cannot be cached. The user information of peripherals that need to use this area of system memory usually discusses their memory requirements.

**DELAYED TRANSACTION:**

The chipset has an embedded 32-bit posted write buffer to support delay transactions cycles. Select Enabled to support compliance with PCI specification version 2.1.

**AGP APERTURE SIZE:**

This field determines the effective size of the Graphic Aperture used for a particular GMCH configuration. It can be updated by the GMCH-specific BIOS configuration sequence before the PCI standard bus enumeration sequence takes place. If it is not updated then a default value will select an aperture of maximum size.

**ON-CHIP VGA :**

By default, the On-Chip VGA or chipset-integrated VGA is “Enabled”.

**ON-CHIP FRAME BUFFER SIZE: (depend on chipset)**

The On-Chip Frame Buffer Size can be set as 1MB or 8MB. This memory is shared with the system memory.

**BOOT DISPLAY: (depend on chipset)**

Boot Display determines the display output device where the system boots. The options are CRT and LVDS.

**PANEL TYPE: (depend on chipset)**

This field allows user to decide the LVDS panel resolution. The available choices are: 640x480 18bits, 800x600 18bits, 1024x768 18bits, 1280x1024 36bits, 1400x1050 36bits, 1600x1200 36bits, and 1024x768 24bits.

## 4-6. INTEGRATED PERIPHERALS

Choose "INTEGRATED PERIPHERALS" from the main setup menu, a display will be shown on screen as below:

Phoenix - AwardBIOS CMOS Setup Utility  
Integrated Peripherals

▶ OnChip IDE Device	[Press Enter]	Item Help
▶ Onboard Device	[Press Enter]	
▶ SuperIO Device	[Press Enter]	Menu Level ▶
Watch Dog Timer Select	[Disabled]	
↑↓→←: Move    Enter: Select    +/-/PU/PD:Value    F10:Save    ESC:Exit    F1:General Help F5: Previous Values    F6: Fail-Safe Defaults    F7:Optimized Defaults		

### Integrated Peripherals Setup Screen

By moving the cursor to the desired selection and by pressing the <F1> key, the all options for the desired selection will be displayed for choice.

- 🔔 If bios setup menu item supports USB device boot, it will cause Win9x detects the same storages twice when the system is rebooted, and USB HDD will fail. Note: this cause just happen under Win9x, the phenomenon is a limitation.

**ONCHIP IDE DEVICE:**

The options for these items are found in its sub menu. By pressing the <ENTER> key, you are prompt to enter the sub menu of the detailed options as shown below:

Phoenix – Award CMOS Setup Utility  
OnChip IDE Device

OnChip Primary PCI IDE	[Enabled]	Item Help
IDE Primary Master PIO	[Auto]	
IDE Primary Slave PIO	[Auto]	Menu Level ►
IDE Primary Master UDMA	[Auto]	
IDE Primary Slave UDMA	[Auto]	
OnChip Secondary PCI IDE	[Enabled]	
IDE Secondary Master PIO	[Auto]	
IDE Secondary Slave PIO	[Auto]	
IDE Secondary Master UDMA	[Auto]	
IDE Secondary Slave UDMA	[Auto]	
IDE HDD Block Mode	[Enabled]	
↑↓→←:Move Enter:Select +/-/PU/PD:Value F10:Save ESC:Exit F1:General Help F5: Previous Values F6:Fail-Safe Defaults F7:Optimized Defaults		

Descriptions on each item above are as follows:

**1. OnChip Primary PCI IDE**

The integrated peripheral controller contains an IDE interface with support for two IDE channels. Select Enabled to activate each channel separately.

**2. Primary Master/Slave PIO  
Secondary Master/Slave PIO**

The four IDE PIO fields allow you to set a PIO mode (0-4) for each of the four IDE devices that the onboard IDE interface supports. Modes 0 through 4 provide successively increased performance. In Auto mode, the system automatically determines the best mode for each device.

**3. Primary Master/Slave UDMA  
Secondary Master/Slave UDMA**

Ultra DMA/33 implementation is possible only if your IDE hard drive supports it and the operating environment includes a DMA driver (Windows 95 OSR2 or a third-party IDE bus master driver). If you

hard drive and your system software both support Ultra DMA/33, select Auto to enable BIOS support.

- 4. **OnChip Secondary PCI IDE**  
Enable the secondary IDE channel.
- 5. **IDE HDD Block Mode**

Block mode is also called block transfer, multiple commands, or multiple sector read/write. If your IDE hard drive supports block mode (most new drives do), select Enabled for automatic detection of the optimal number of block read/writes per sector the drive can support.

**ONBOARD DEVICE:**

The options for these items are found in its sub menu. By pressing the <ENTER> key, you are prompt to enter the sub menu of the detailed options as shown below:

Phoenix – Award CMOS Setup Utility  
Onboard Device

USB Controller	[Enabled]	Item Help
USB 2.0 Support	[Enabled]	
USB Keyboard Support	[Disabled]	Menu Level ►
USB Mouse Support	[Disabled]	
Onboard LAN	[Enabled]	
Init Display First	[Onboard]	
↑↓→←:Move Enter: Select +/-/PU/PD:Value F10:Save ESC:Exit F1:General Help F5: Previous Values F6:Fail-Safe Defaults F7:Optimized Defaults		

Descriptions on each item above are as follows:

- 1. **USB Controller**  
This should be enabled if your system has a USB installed on the system board and you want to use it. Even when so equipped, if you add a higher performance controller, you will need to disable this feature.
- 2. **USB Keyboard Support**  
Select Enabled if your system contains a Universal Serial Bus (USB) controller and you have a USB keyboard.
- 3. **USB Mouse Support**  
Select Enabled if your system contains a Universal Serial Bus (USB) controller and you have a USB Mouse.
- 4. **Init Display First**



This item allows you to decide to active whether PCI Slot or on-chip VGA first.

**SUPER IO DEVICE:**

The options for these items are found in its sub menu. By pressing the <ENTER> key, you are prompt to enter the sub menu of the detailed options as shown below:

Phoenix – Award CMOS Setup Utility  
SuperIO Device

Onboard FDC Controller	[Enabled]	Item Help
Onboard Serial Port 1	[3F8/IRQ4]	
Onboard Serial Port 2	[2F8/IRQ3]	Menu Level ►
UART Mode Select	[Normal]	
X RxD, TxD Active	Hi, Lo	
X IR Transmission Delay	Enabled	
X UR2 Duplex Mode	Half	
X Use IR Pins	IR-Rx2Tx2	
↑↓→←:Move Enter: Select +/-/PU/PD:Value F10:Save ESC:Exit F1:General Help F5: Previous Values F6:Fail-Safe Defaults F7:Optimized Defaults		

Descriptions on each item above are as follows:

1. **Onboard FDC Controller**  
Select Enabled if the system has a floppy disk controller (FDC) installed on the system board and you wish to use it. If you install and-in FDC or the system has no floppy drive, select Disabled.
2. **Onboard Serial Port 1/2**  
Select an address and corresponding interrupt for the first and second serial ports.
3. **UART Mode Select**  
This item allows you to select UART mode.
4. **RxD, TxD Active**  
This item allows you to determine the active of RxD, TxD.
5. **IR Transmission Delay**  
This item allows you to enable/disable IR transmission delay.
6. **UR2 Duplex Mode**  
This item allows you to select the IR half/full duplex function.
7. **Use IR Pins**  
This item allows you to select IR transmission routes, one is RxD2m, TxD2 (COM Port) and the other is IR-Rx2Tx2

## 4-7. POWER MANAGEMENT SETUP

Choose "POWER MANAGEMENT SETUP" option on the main menu, a display will be shown on screen as below :

Phoenix - AwardBIOS CMOS Setup Utility  
Power Management Setup

Power Management	[User Define]	Item Help
MODEM Use IRQ	[3]	
** Reload Global Timer Events **		Menu Level ►
Primary IDE 0	[Disabled]	
Primary IDE 1	[Disabled]	
Secondary IDE 0	[Disabled]	
Secondary IDE 1	[Disabled]	
FDD, COM, LPT Port	[Disabled]	
↑↓→←: Move Enter: Select +/-/PU/PD:Value F10:Save ESC:Exit F1:General Help F5: Previous Values F6: Fail-Safe Defaults F7:Optimized Defaults		

### Power Management Setup Screen

The "Power Management Setup" allows the user to configure the system to the most effectively save energy while operating in a manner consistent with your own style of computer use.

#### POWER MANAGEMENT:

This item allows you to select the Power Management mode.

#### MODEM USE IRQ:

This item enable you to name the interrupt request (IRQ) line assigned to the modem (if any) on your system. Activity of the selected IRQ always awakens the system.

#### PM EVENTS:

PM events are I/O events whose occurrence can prevent the system from entering a power saving mode or can awaken the system from such a mode. In effect, the system remains alert for anything, which occurs to a device which is configured as *Enabled*, even when the system is in a power down mode. (1) **Primary IDE 0** (2) **Primary IDE 1** (3) **Secondary IDE 0** (4) **Secondary IDE 1** (5) **FDD, COM, LPT Port**

## 4-8. PNP/PCI CONFIGURATION

Choose "PNP/PCI CONFIGURATION" from the main menu, a display will be shown on screen as below:

Phoenix - AwardBIOS CMOS Setup Utility  
PnP/PCI Configurations

Reset Configuration Data	[Disabled]	Item Help
Resources Controlled By x IRQ Resources	[Auto (ESCD)] Press Enter	Menu Level ►
PCI/VGA Palette Snoop	[Disabled]	Select Yes if you are using a Plug and Play capable operating system Select No if you need the BIOS to configure non-boot devices
↑↓→←: Move    Enter: Select    +/-/PU/PD: Value    F10: Save    ESC: Exit    F1: General Help F5: Previous Values    F6: Fail-Safe Defaults    F7: Optimized Defaults		

### PNP/PCI Configuration Setup Screen

The PNP/PCI Configuration Setup describes how to configure PCI bus system. PCI, also known as Personal Computer Interconnect, is a system, which allows I/O devices to operate at speeds nearing the speed of the CPU itself uses when communicating with its own special components.

This section covers technical items, which is strongly recommended for experienced users only.

#### RESET CONFIGURATION DATA:

Normally, you leave this field Disabled. Select Enabled to reset Extended System Configuration Data (ESCD) when you exit Setup if you have installed a new add-on and the system configuration has caused such a serious conflict that the operating system cannot boot.

**RESOURCE CONTROLLED BY:**

The Award Plug and Play Bios can automatically configure all of the booth and Plug and Play-compatible devices. However, this capability means absolutely nothing unless you are using a Plug and Play operating system such as Windows 95. By choosing “manual”, you are allowed to configure the *IRQ Resources and DMA Resources*.

**IRQ RESOURCES:**

The options for these items are found in its sub menu. By pressing the <ENTER> key, you are prompt to enter the sub menu of the detailed options as shown below:

Phoenix – Award CMOS Setup Utility  
IRQ Resources

IRQ-3 assigned to	[PCI Device]	Item Help
IRQ-4 assigned to	[PCI Device]	
IRQ-5 assigned to	[PCI Device]	Menu Level ► Legacy ISA for devices compliant with the original PC AT bus specification, PCI/ISA PnP for devices compliant with the Plug and Play standard whether designed for PCI or ISA bus architecture
IRQ-7 assigned to	[PCI Device]	
IRQ-9 assigned to	[PCI Device]	
IRQ-10 assigned to	[PCI Device]	
IRQ-11 assigned to	[PCI Device]	
IRQ-12 assigned to	[PCI Device]	
IRQ-14 assigned to	[PCI Device]	
IRQ-15 assigned to	[PCI Device]	
↑↓→←:Move Enter: Select +/-/PU/PD:Value F10:Save ESC:Exit F1:General Help F5: Previous Values F6:Fail-Safe Defaults F7:Optimized Defaults		

Descriptions on each item above are as follows:

**1. IRQ-n Assigned to:**

You may assign each system interrupt a type, depending on the type of device using the interrupt.

### 4-9. PC HEALTH STATUS

Choose "PC HEALTH STATUS" from the main menu, a display will be shown on screen as below:

Phoenix - AwardBIOS CMOS Setup Utility  
PC Health Status

Current Warning Temperature	[Disabled]	Item Help
Current CPU Temperature	55°C/131°F	Menu Level ▶
Current SYSTEM Fan Speed	0 RPM	
Vcore	1.00V	
Vccp	1.05V	
3.3 V	3.36V	
+ 5 V	5.08V	
+12V	12.22V	
VBAT (V)	3.13V	
5VSB (V)	5.01V	
↑↓→←: Move Enter: Select +/-/PU/PD:Value F10:Save ESC:Exit F1:General Help F5: Previous Values F6: Fail-Safe Defaults F7:Optimized Defaults		

#### PC Health Status Setup Screen

The PC Health Status Setup allows you to select whether to choose between monitoring or to ignore the hardware monitoring function of your system.

#### CURRENT WARNING TEMPERATURE:

Select the combination of lower and upper limits for the CPU temperature. If the CPU temperature extends beyond either limit, any warning mechanism programmed into your system will be activated.

#### CURRENT CPU TEMPERATURE:

This item shows you the current CPU temperature.

#### CURRENT SYSTEM FAN SPEED:

This item shows you the current System FAN speed.

#### VCORE:

This item shows you the current system voltage.

#### 3.3V / +5V / +12V / VBAT/5VSB:

Show you the voltage of 3.3V/+5V/+12V/VBAT/5VSB.

## 4-10. FREQUENCY CONTROL

Choose "FREQUENCY CONTROL" from the main menu, a display will be shown on screen as below:

Phoenix - AwardBIOS CMOS Setup Utility  
Frequency Control

Auto Detect PCI Clk	[Enabled]	Item Help
Spread Spectrum	[Enabled]	
		Menu Level ►
↑↓→←: Move    Enter: Select    +/-/PU/PD:Value    F10:Save    ESC:Exit    F1:General Help F5: Previous Values    F6: Fail-Safe Defaults    F7:Optimized Defaults		

### Frequency Control Setup Screen

This setup menu allows you to specify your settings for frequency control.

#### **AUTO DETECT PCI CLK:**

This item allows you to enable or disable auto detect PCI Clock.

#### **SPREAD SPECTRUM:**

When the system clock generator pulses, the extreme values of the pulse generate excess EMI. Enabling pulse spectrum spread modulation changes the extreme values from spikes to flat curves, thus reducing EMI. This benefit may in some cases be outweighed by problems with timing-critical devices such as a clock-sensitive SCSI device.

## **4-11. LOAD FAIL-SAFE DEFAULTS**

By pressing the <ENTER> key on this item, you get a confirmation dialog box with a message similar to the following:

Load Fail-Safe Defaults ( Y/N ) ? N

To use the BIOS default values, change the prompt to "Y" and press the <Enter > key. CMOS is loaded automatically when you power up the system.

## **4-12. LOAD OPTIMIZED DEFAULTS**

When you press <Enter> on this category, you get a confirmation dialog box with a message similar to the following:

Load Optimized Defaults ( Y/N ) ? N

Pressing "Y" loads the default values that are factory setting for optimal performance system operations.

## 4-13. SET SUPERVISOR PASSWORD/SET USER PASSWORD

User is allowed to set either supervisor or user password, or both of them. The difference is that the supervisor password can enter and change the options of the setup menus while the user password can enter only but do not have the authority to change the options of the setup menus.

### TO SET A PASSWORD

When you select this function, the following message will appear at the center of the screen to assist you in creating a password.

Enter Password:

Type the password up to eight characters in length, and press < Enter >. The password typed now will clear any previously entered password from CMOS memory. You will be asked to confirm the password. Type the password again and press the < Enter > key. You may also press < Esc > to abort the selection and not enter a password.

 User should bear in mind that when a password is set, you will be asked to enter the password everything you enter CMOS setup Menu.

### TO DISABLE THE PASSWORD

To disable the password, select this function (do not enter any key when you are prompt to enter a password), and press the <Enter> key and a message will appear at the center of the screen:

PASSWORD DISABLED!!!  
Press any key to continue...

Press the < Enter > key again and the password will be disabled. Once the password is disabled, you can enter Setup freely.



### 4-14. SAVE & EXIT SETUP

After you have completed adjusting all the settings as required, you must remember to save these setting into the CMOS RAM. To save the settings, select “SAVE & EXIT SETUP” and press <Enter>, a display will be shown as follows:

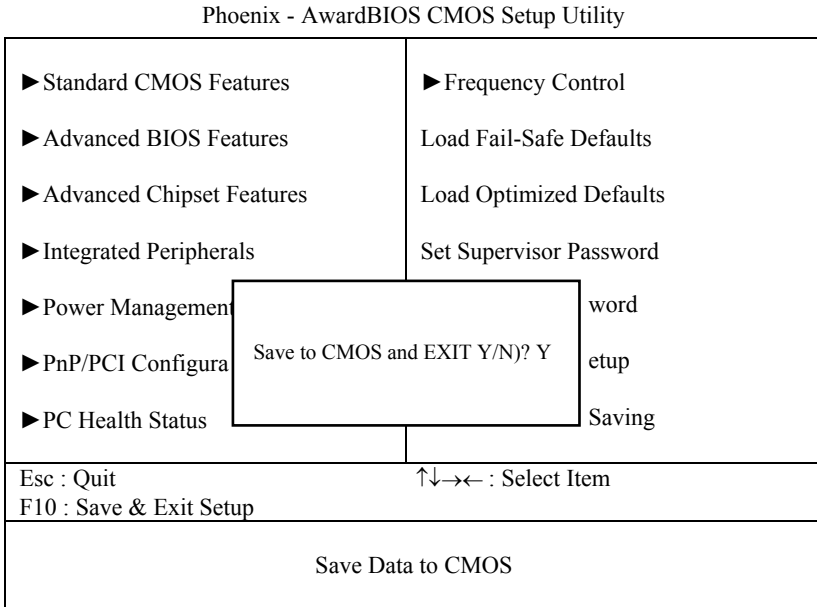

When you confirm that you wish to save the settings, your system will be automatically restarted and the changes you have made will be implemented. You may always call up the setup program at any time to adjust any of the individual items by pressing the <Del> key during boot up.

## 4-15. EXIT WITHOUT SAVING

If you wish to cancel any changes you have made, you may select the "EXIT WITHOUT SAVING" and the original setting stored in the CMOS will be retained. The screen will be shown as below:

Phoenix - AwardBIOS CMOS Setup Utility	
<ul style="list-style-type: none"> <li>▶ Standard CMOS Features</li> <li>▶ Advanced BIOS Features</li> <li>▶ Advanced Chipset Features</li> <li>▶ Integrated Peripherals</li> <li>▶ Power Management</li> <li>▶ PnP/PCI Configura</li> <li>▶ PC Health Status</li> </ul>	<ul style="list-style-type: none"> <li>▶ Frequency Control</li> <li>Load Fail-Safe Defaults</li> <li>Load Optimized Defaults</li> <li>Set Supervisor Password</li> </ul>
<div style="border: 1px solid black; padding: 5px; display: inline-block;">Quit Without Saving (Y/N)? N</div>	
<div style="display: flex; justify-content: space-between;"> <span>word</span> <span>etup</span> <span>Saving</span> </div>	
<div style="display: flex; justify-content: space-between;"> <span>Esc : Quit</span> <span>↑↓→← : Select Item</span> </div>	
<div style="display: flex; justify-content: space-between;"> <span>F10 : Save &amp; Exit Setup</span> </div>	
Abandon all Datas	

# ***EXPANSION BUS***

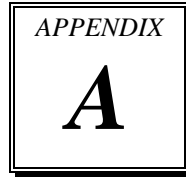

This appendix indicates the pin assignments.

Section includes:

- PC/104 Plus BUS Connector Pin Assignment

## PC/104 PLUS BUS CONNECTOR PIN ASSIGNMENT

PC/104 Plus Bus connector is divided into four rows. Each row consists of 30 pins.

The pin assignments are as followed:

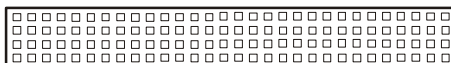

A		B		C		D	
PIN	ASSIGNMENT	PIN	ASSIGNMENT	PIN	ASSIGNMENT	PIN	ASSIGNMENT
A1	GND	B1	Reserved	C1	+5V	D1	AD00
A2	V/I/O	B2	AD02	C2	AD01	D2	+5V
A3	AD05	B3	GND	C3	AD04	D3	AD03
A4	C/BE0#	B4	AD07	C4	GND	D4	AD06
A5	GND	B5	AD09	C5	AD08	D5	GND
A6	AD11	B6	V/I/O	C6	AD10	D6	M66EN
A7	AD14	B7	AD13	C7	GND	D7	AD12
A8	+3.3V	B8	C/BE1#	C8	AD15	D8	+3.3V
A9	SERR#	B9	GND	C9	SB0#	D9	PAR
A10	GND	B10	PERR#	C10	+3.3V	D10	SDONE
A11	STOP#	B11	+3.3V	C11	LOCK#	D11	GND
A12	+3.3V	B12	TRDY#	C12	GND	D12	DEVSEL
A13	FRAME#	B13	GND	C13	IRDY#	D13	+3.3V
A14	GND	B14	AD16	C14	+3.3V	D14	C/BE2#
A15	AD18	B15	+3.3V	C15	AD17	D15	GND
A16	AD21	B16	AD20	C16	GND	D16	AD19
A17	+3.3V	B17	AD23	C17	AD22	D17	+3.3V
A18	IDSEL0	B18	GND	C18	IDSEL1	D18	IDSEL2
A19	AD24	B19	C/BE3#	C19	V/I/O	D19	IDSEL3
A20	GND	B20	AD26	C20	AD25	D20	GND
A21	AD29	B21	+5V	C21	AD28	D21	AD27
A22	+5V	B22	AD30	C22	GND	D22	AD31
A23	REQ0#	B23	GND	C23	REQ1#	D23	V/I/O
A24	GND	B24	REQ2#	C24	+5V	D24	GNT0#
A25	GNT1#	B25	V/I/O	C25	GNT2#	D25	GND
A26	+5V	B26	CLK0	C26	GND	D26	CLK1
A27	CLK2	B27	+5V	C27	CLK3	D27	GND
A28	GND	B28	INTD#	C28	+5V	D28	RST#
A29	+12V	B29	INTA#	C29	INTB#	D29	INTC#
A30	-12V	B30	Reserved	C30	Reserved	D30	GND

# ***TECHNICAL SUMMARY***

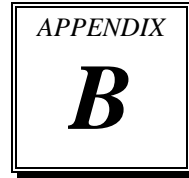

This section introduce you the maps concisely.

Section includes:

- Block Diagram
- Interrupt Map
- RTC & CMOS RAM Map
- Timer & DMA Channels Map
- I / O & Memory Map

## BLOCK DIAGRAM

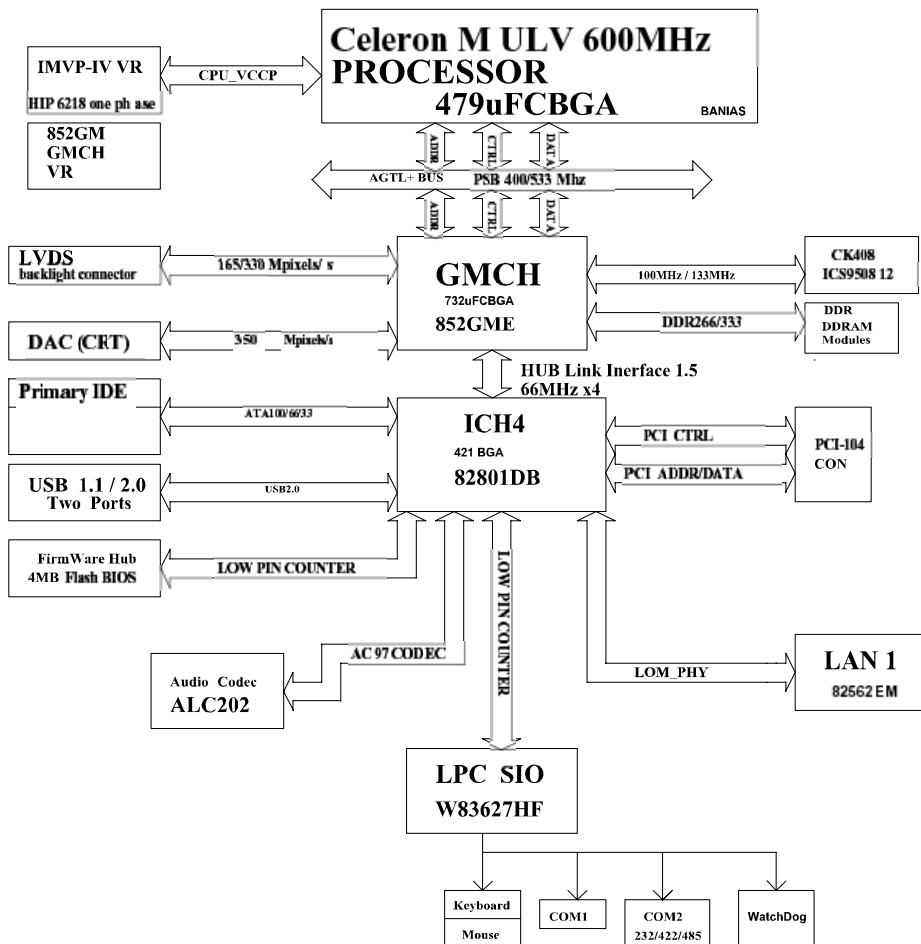

**INTERRUPT MAP**

<b>IRQ</b>	<b>ASSIGNMENT</b>
0	System TIMER
1	Keyboard
2	Cascade
3	Serial port 2
4	Serial port 1
5	Available
6	Floppy
7	Parallel port 1
8	RTC clock
9	Available
10	Available
11	Available
12	PS/2 Mouse
13	Math coprocessor
14	IDE1
15	IDE2

## **RTC & CMOS RAM MAP**

<b>CODE</b>	<b>ASSIGNMENT</b>
00	Seconds
01	Second alarm
02	Minutes
03	Minutes alarm
04	Hours
05	Hours alarm
06	Day of week
07	Day of month
08	Month
09	Year
0A	Status register A
0B	Status register B
0C	Status register C
0D	Status register D
0E	Diagnostic status byte
0F	Shutdown byte
10	Floppy Disk drive type byte
11	Reserve
12	Hard Disk type byte
13	Reserve
14	Equipment byte
15	Base memory low byte
16	Base memory high byte
17	Extension memory low byte
18	Extension memory high byte
30	Reserved for extension memory low byte
31	Reserved for extension memory high byte
32	Date Century byte
33	Information Flag
34-3F	Reserve
40-7f	Reserved for Chipset Setting Data



## TIMER & DMA CHANNELS MAP

### Timer Channel Map :

Timer Channel	Assignment
0	System timer interrupt
1	DRAM Refresh request
2	Speaker tone generator

### DMA Channel Map :

DMA Channel	Assignment
0	Available
1	Available
2	Floppy
3	Available
4	Cascade
5	Available
6	Available
7	Available

## **I/O & MEMORY MAP**

### **Memory Map :**

<b>MEMORY MAP</b>	<b>ASSIGNMENT</b>
0000000-009FFFF	System memory used by DOS and application
00A0000-00BFFFF	Display buffer memory for VGA/ EGA / CGA / MONOCHROME adapter
00C0000-00DFFFF	Reserved for I/O device BIOS ROM or RAM buffer.
00E0000-00EFFFF	Reserved for PCI device ROM
00F0000-00FFFFFF	System BIOS ROM
0100000-FFFFFFF	System extension memory

### **I/O Map :**

<b>I/O MAP</b>	<b>ASSIGNMENT</b>
000-01F	DMA controller (Master)
020-021	Interrupt controller (Master)
022-023	Chipset controller registers I/O ports.
040-05F	Timer control registers.
060-06F	Keyboard interface controller (8042)
070-07F	RTC ports & CMOS I/O ports
080-09F	DMA register
0A0-0BF	Interrupt controller (Slave)
0C0-0DF	DMA controller (Slave)
0F0-0FF	Math coprocessor
1F0-1F8	Hard Disk controller
278-27F	Parallel port-2
2B0-2DF	Graphics adapter controller
2F8-2FF	Serial port-2
360-36F	Net work ports
378-37F	Parallel port-1
3B0-3BF	Monochrome & Printer adapter
3C0-3CF	EGA adapter
3D0-3DF	CGA adapter
3F0-3F7	Floppy disk controller
3F8-3FF	Serial port-1

## Free Manuals Download Website

<http://myh66.com>

<http://usermanuals.us>

<http://www.somanuals.com>

<http://www.4manuals.cc>

<http://www.manual-lib.com>

<http://www.404manual.com>

<http://www.luxmanual.com>

<http://aubethermostatmanual.com>

Golf course search by state

<http://golfingnear.com>

Email search by domain

<http://emailbydomain.com>

Auto manuals search

<http://auto.somanuals.com>

TV manuals search

<http://tv.somanuals.com>