

# Panasonic®

## Operating Instructions/Bedienungsanleitung Manuel d'emploi/Istruzioni per l'uso Instrucciones de funcionamiento

Camera-Recorder/Kamerarecorder  
Caméscope/Videocamera  
Videocámara-grabadora

Model No. AG- **DVX100B** E

Mini **DV** PAL

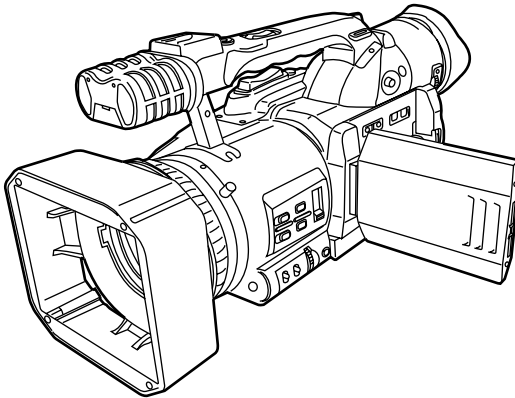

Before operating this product, please read the instructions carefully and save this manual for future use.

Lesen Sie die Anweisungen vor der Verwendung dieses Produkts sorgfältig durch, und bewahren Sie das vorliegende Handbuch zur künftigen Referenz auf.

Avant d'utiliser ce produit, veiller à lire attentivement ce manuel et le conserver pour un usage ultérieur.

Prima di utilizzare questo prodotto, leggere queste istruzioni e conservare questo manuale per consultarlo quando necessario.

Antes de utilizar este producto, lea estas instrucciones de funcionamiento con atención y guárdelas para poder consultarlas en el futuro.

# Caution for AC Mains Lead

**FOR YOUR SAFETY PLEASE READ THE FOLLOWING TEXT CAREFULLY.**

This product is equipped with 2 types of AC mains cable. One is for continental Europe, etc. and the other one is only for U.K.

Appropriate mains cable must be used in each local area, since the other type of mains cable is not suitable.

**FOR CONTINENTAL EUROPE, ETC.**  
Not to be used in the U.K.

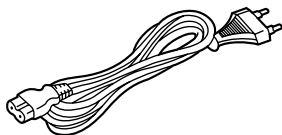

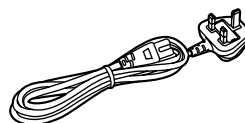

**FOR U.K. ONLY**



**FOR U.K. ONLY**

This appliance is supplied with a moulded three pin mains plug for your safety and convenience.

A 5 amp fuse is fitted in this plug. Should the fuse need to be replaced please ensure that the replacement fuse has a rating of 5 amps and that it is approved by ASTA or BSI to BS1362.

Check for the ASTA mark  or the BSI mark  on the body of the fuse.

If the plug contains a removable fuse cover you must ensure that it is refitted when the fuse is replaced.

If you lose the fuse cover the plug must not be used until a replacement cover is obtained.

A replacement fuse cover can be purchased from your local Panasonic Dealer.

**How to replace the fuse**

**1. Open the fuse compartment with a screwdriver.**

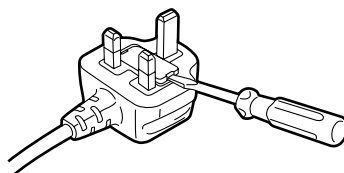

**2. Replace the fuse**

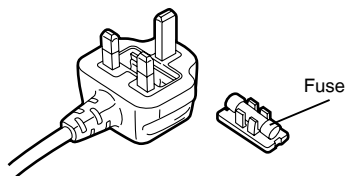

 indicates safety information.

## ■ DO NOT REMOVE PANEL COVERS BY UNSCREWING THEM.

To reduce the risk of electric shock, do not remove cover. No user serviceable parts inside. Refer servicing to qualified service personnel.

### WARNING:

- TO REDUCE THE RISK OF FIRE OR SHOCK HAZARD, DO NOT EXPOSE THIS EQUIPMENT TO RAIN OR MOISTURE.
- TO REDUCE THE RISK OF FIRE OR SHOCK HAZARD, KEEP THIS EQUIPMENT AWAY FROM ALL LIQUIDS. USE AND STORE ONLY IN LOCATIONS WHICH ARE NOT EXPOSED TO THE RISK OF DRIPPING OR SPLASHING LIQUIDS, AND DO NOT PLACE ANY LIQUID CONTAINERS ON TOP OF THE EQUIPMENT.

### CAUTION:

**TO REDUCE THE RISK OF FIRE OR SHOCK HAZARD AND ANNOYING INTERFERENCE, USE THE RECOMMENDED ACCESSORIES ONLY.**

### CAUTION:

In order to maintain adequate ventilation, do not install or place this unit in a bookcase, built-in cabinet or any other confined space. To prevent risk of electric shock or fire hazard due to overheating, ensure that curtains and any other materials do not obstruct the ventilation.

### Operating precaution

Operation near any appliance which generates strong magnetic fields may give rise to noise in the video and audio signals. If this should be the case, deal with the situation by, for instance, moving the source of the magnetic fields away from the unit before operation.

### CAUTION:

Danger of explosion or fire if battery is mis-treated.

- Replace only with same or specified type.
- Do not disassemble or dispose of in fire.
- Do not store in temperatures over 60°C.
- Use specified charger for rechargeable batteries.
- Do not recharge the battery if it is not a rechargeable type.

#### For Remote Controller

- Replace battery with part No. CR2025 only.
- Do not recharge the battery.

#### Camera-Recorder

The rating plate is on the underside of the Camera-Recorder

#### AC Adapter

The rating plate is on the underside of the AC Adapter.

Disconnect the AC mains plug from the AC mains socket when not in use.

### CAUTION:

**THE AC RECEPTACLE (MAINS SOCKET OUTLET) SHALL BE INSTALLED NEAR THE EQUIPMENT AND SHALL BE EASILY ACCESSIBLE.**

**TO COMPLETELY DISCONNECT THIS EQUIPMENT FROM THE AC MAINS, DISCONNECT THE POWER CORD PLUG FROM THE AC RECEPTACLE.**

## Attention/Attentie

- Batteries are used for the main power source, memory back-up in the product and remote controller. At the end of their useful life, you should not throw them away. Instead, hand them in as small chemical waste.
- Voor de primaire voeding en het reservegeheugen van het apparaat, alsmede voor de afstandsbediening, wordt gebruik gemaakt van een batterij. Wanneer de batterij uitgeput is, mag u deze niet gewoon weggooien, maar dient u ze als klein chemisch afval weg te doen.

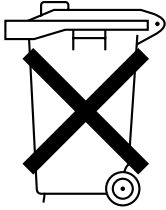

## To remove the battery/ Verwijderen van de batterij

### Main Power Battery

### Batterij Voor Primaire Voeding

While pressing the battery release, lift the battery out

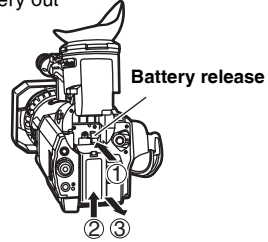

# Contents

<b>Before use</b>	
<b>Read this first!</b> .....	<b>6</b>
<b>Accessories</b> .....	<b>6</b>
<b>Operating precautions</b> .....	<b>7</b>
<b>Checking the system operations</b> .....	<b>9</b>
Items to prepare.....	9
Connect the AC power supply cord.....	9
Insert the Mini DV cassette tape.....	9
Turn on the camera.....	10
Start shooting.....	10
Check what you have shot (rec check).....	11
Eject the tape.....	11
Turn off the unit.....	12
Disconnect the power cord.....	12
<b>Adjusting the hand strap</b> .....	<b>13</b>
<b>Attaching the shoulder strap</b> .....	<b>13</b>
<b>Attaching the lens hood</b> .....	<b>14</b>
<b>Attaching the lens-cap strap</b> .....	<b>14</b>
<b>Cassette tapes</b> .....	<b>14</b>
<b>Description of parts</b>	
<b>Description of parts</b> .....	<b>15</b>
Camera-recorder.....	15
Remote control.....	18
<b>Preparation</b>	
<b>The remote control</b> .....	<b>19</b>
Insert the battery.....	19
Remote control setup.....	19
<b>The battery</b> .....	<b>20</b>
Charging.....	20
Attaching the battery.....	21
Detaching the battery.....	21
<b>Viewfinder</b> .....	<b>22</b>
Using the viewfinder.....	22
Using the LCD.....	23
Emphasizing outlines.....	23
Adjusting the screen display.....	24
<b>Time data</b> .....	<b>25</b>
Setting the calendar.....	25
Recharging the built-in battery.....	26
Setting user information.....	26
Setting the time code.....	27
Specifying the time code (TC PRESET).....	28

<b>Shooting</b>	
<b>Regular shooting</b> .....	<b>30</b>
Preparation and inspections.....	30
Shooting in auto mode.....	30
<b>Shooting techniques for different targets</b> ....	<b>31</b>
Check what you have shot (rec check).....	31
Finding specific scenes (image search).....	31
Zoom.....	31
Low-angle shooting.....	32
Self-portrait shooting.....	32
Zebra pattern.....	32
Marker.....	32
ONE-SHOT recording.....	33
Changing the image size.....	33
Optical Image Stabilizer.....	34
Using the USER buttons.....	34
Backlight compensation.....	34
Index recording.....	34
Color bars.....	34
Adding effects to images.....	34
Backup recording.....	35
Switching to manual mode.....	35
Adjusting the volume while shooting.....	35
<b>Shooting in progressive mode</b> .....	<b>36</b>
<b>Focus</b> .....	<b>37</b>
<b>Adjusting the shutter speed</b> .....	<b>38</b>
Slow shutter mode.....	39
Synchro scan.....	39
<b>Adjusting the white balance</b> .....	<b>40</b>
White balance adjustments.....	40
Using presets.....	41
Black balance adjustments.....	41
Auto Tracking White (ATW).....	41
<b>Adjusting Iris, Gain, and Light Intensity</b> ...	<b>42</b>
Iris adjustments.....	42
Adjusting the gain.....	42
Light intensity adjustments.....	42
<b>Switching Audio Input</b> .....	<b>43</b>
Using the built-in microphone.....	43
Using another microphone and audio equipment.....	43
Adjusting the recording level.....	43
<b>Using scene files</b> .....	<b>44</b>
Changing scene file settings.....	44
<b>Transferring scene files</b> .....	<b>46</b>

## Contents (continued)

### Playback

<b>Playback</b> .....	<b>47</b>
Adjusting the volume .....	48
Viewing images on a television .....	48
Checking the date and time .....	48
<b>Variable-speed playback</b> .....	<b>49</b>
Slow playback .....	49
Frame-by-frame playback .....	49
Fast-forward and rewind .....	49
Index search .....	49
Variable speed search .....	50
End search .....	50
<b>Using the Counter</b> .....	<b>51</b>
Counter display .....	51
Memory stop mode .....	51
1394TC preset mode .....	51

### Editing

<b>Connecting external units</b> .....	<b>52</b>
Headphones .....	52
External microphone .....	52
Digital video equipment .....	53
Television .....	54
Video deck .....	54
<b>Audio dubbing</b> .....	<b>55</b>
<b>Dubbing</b> .....	<b>57</b>
Analog input .....	57
Analog output .....	58
Digital input/output .....	59

### Displays

<b>Screen displays</b> .....	<b>60</b>
Displays in CAMERA and VCR modes .....	60
In VCR mode only .....	63
Warnings .....	63
Setting the DISPLAY items .....	64

### Menus

<b>Using the setup menus</b> .....	<b>65</b>
Using the setup menus .....	65
Initializing the menu settings .....	66
<b>Setup menu structure</b> .....	<b>67</b>
Camera mode menu .....	67
VCR mode menu .....	67
<b>Setup menu list</b> .....	<b>68</b>
SCENE FILE screen .....	68
CAMERA SETUP screen .....	70
SW MODE screen .....	70
AUTO SW screen .....	71
PLAYBACK FUNCTIONS screen .....	72
RECORDING SETUP screen .....	73
AV IN/OUT SETUP screen .....	74
DISPLAY SETUP screen .....	75
OTHER FUNCTIONS screen .....	76

### Reference

<b>Before calling for service</b> .....	<b>78</b>
<b>Condensation</b> .....	<b>81</b>
<b>Tally lamp</b> .....	<b>81</b>
<b>System resetting</b> .....	<b>81</b>
<b>Video Heads</b> .....	<b>82</b>
<b>Cleaning</b> .....	<b>82</b>
<b>Storage Precautions</b> .....	<b>83</b>
<b>Specifications</b> .....	<b>84</b>

- LEICA is a trademark of Leica Microsystems IRGmbH.
- DICOMAR is a trademark of Leica Camera AG.

All other explanations, company names, and product names are the registered trademarks of the respective companies.

### IMPORTANT

"Unauthorized recording of copyrighted television programs, video tapes and other materials may infringe the right of copyright owners and be contrary to copyright laws."

# Read this first!

## Always take some trial shots before actual shooting.

- When shooting important events (such as weddings), always take some trial shots and check that the sound and images have been recorded properly before actual shooting.

## Panasonic makes no guarantees for your recordings.

- Please understand that Panasonic makes no guarantees for your recordings in cases where images and/or sound were not recorded as you intended due to problems with the camera-recorder or cassette.

## Respect copyrights

- Copyright laws forbid the use of video and audio material you have recorded for any purpose other than your own personal enjoyment. Remember that restrictions apply to the shooting of certain material even if it is intended for private use.

## Note concerning illustrations in these instructions

- Illustrations (camera-recorder, menu screens, etc.) in these operating instructions differ slightly from the actual camera-recorder.









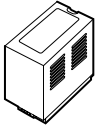
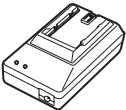
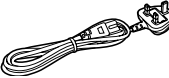

## References

- References are shown as (Page 10).

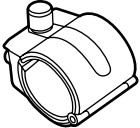
## Tapes you can use

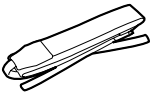
- You can use tapes with this mark-  .

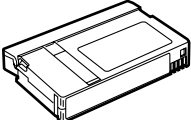
# Accessories

<b>Battery *</b> 	<b>AC Adapter *</b> 	<b>AC power supply cord</b> (For the U.K.)  (For areas other than the U.K.) 	
<b>DC cord</b> 	<b>Wireless remote control and button battery (CR2025)</b> 	<b>Eye cup</b> 	<b>Microphone holder</b> 
<b>2x 6-mm screws</b> <b>2x 12-mm screws</b> 	<b>Microphone holder adapter</b> 	<b>Shoulder belt</b> 	<b>Lens cap strap</b> 
<b>Mini DV cassette tape (AY-DVM63MQ)</b> 	<b>Ferrite cores</b> Ferrite cores for DV (IEEE1394) cable 		Attach one core to each end of the DV (IEEE1394) cable. 

\* For part numbers for the battery and AC adapter, see "OPTIONAL UNITS" (Page 85).

# Operating precautions

---

## **Do not allow any water to get into the camera-recorder when using it in the rain or snow or at the beach.**

- Failure to heed this caution will cause the camera-recorder or cassette to malfunction (and may result in irreparable damage).

## **Keep the camera-recorder away from equipment (such as TV sets and video game machines) that generate magnetic fields.**

- Using the camera-recorder on top of or near a TV set may cause distortion in the images and/or sound due to the electromagnetic waves that the set emits.
- The powerful magnetic fields generated by speakers or large motors may damage your tape recordings or distort the images.
- The electromagnetic waves emitted from a microcomputer will adversely affect the camera-recorder, causing the images and/or sound to be distorted.
- If the camera-recorder is so adversely affected by products that generate magnetic fields that it no longer operates properly, turn it off and remove the battery or unplug the AC adapter from the power outlet. Then install the battery again or reconnect the AC adapter. After this, turn the camera-recorder back on.

## **Do not use the camera-recorder near radio transmitters or high-voltage equipment.**

- Using the camera-recorder near a radio transmitter or high-voltage equipment may adversely affect the recorded images and/or sound.

## **Do not allow any sand or dust to get into the camera-recorder when using it at the beach and other similar places.**

- Sand and dust can damage the camera-recorder and cassette. (Be especially careful when inserting or removing the cassettes.)

## **AC adapter and battery**

- If the battery is extremely hot or cold, the CHARGE lamp will blink several times before charging starts.
- If the CHARGE lamp continues to blink even when the battery temperature is normal, there may be something wrong with the battery or AC adapter. Contact your dealer.
- The battery takes longer to charge when it is warm.
- The AC adapter can interfere with radio reception so keep radios at least 1 meter away from it.
- The AC adapter may make some noise when you are using it, but this is normal.

## **Take precautions not to drop the camera when moving it.**

- Strong impacts may damage the camera and cause it to stop working.
- Handle the camera with care, using the hand strap or shoulder strap to carry it.

## **Do not spray the camera with insect sprays or other volatile substances.**

- These can warp the camera or cause the finish to come off.
- Do not leave the camera-recorder in contact with rubber or PVC products for extended periods of time.

## **After use, remove the cassette and battery and disconnect the AC power supply cord.**

- The tape can become slack or damaged if you leave it in the camera.
- The battery can over discharge if you leave it in the camera and it may become impossible to recharge it.



### Battery characteristics

This camera-recorder uses a rechargeable lithium-ion battery that uses its internal chemical reaction to generate electrical energy. This reaction is easily influenced by the ambient temperature and humidity, and the battery's effective operating time is reduced as the temperature rises or falls. In very low temperatures, the battery may last only 5 minutes.

Protective circuitry functions if you use the battery where it is very hot and you will have to wait before you can use it again.

### Remove the battery after use

Completely remove the battery. (The battery continues to be used even if you have turned the camera off.) The battery can over discharge if you leave it in the camera and it may become impossible to recharge it.

### Disposing of spent batteries

The battery will become unchargeable. Rather than throwing the battery into the garbage, take it to a store that can assist in recycling it.

### Protect the battery terminals.

Keep the battery's terminal area free of dust and other foreign matter.

If you accidentally drop the battery, check that the battery and its terminals have not been damaged. You can damage the camera and AC adapter if you try to use or recharge a damaged battery.

### Liquid crystal displays

- Images or letters can get burned onto the screen of the LCD or viewfinder if they are displayed for a long time, but you can fix this by leaving the camera off for several hours.
- The liquid crystal parts are highly precise with 99.99% of the pixels effective. This leaves less than 0.01% of pixels that may not light or may remain on all the time. These phenomena are normal and will have no effect on the images you shoot.
- Condensation may form if you use the camera where temperatures fluctuate. Wipe dry with a soft, dry cloth.
- The LCD may appear dim after immediately turning on a cold camera, but will brighten as the camera warms up.

### Do not point the lens or viewfinder at the sun.

Doing so may damage the parts inside.

### Protective caps for the connectors

Keep the protective caps fitted over any connectors that are not being used.

### Mounting the camera-recorder on a tripod

The tripod mounting hole is 5.5 mm deep. Do not force the tripod screw beyond this depth. You can damage the camera-recorder if you use any screw other than 1/4-20UNC.

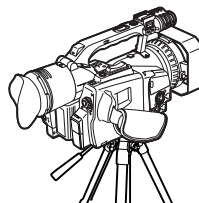
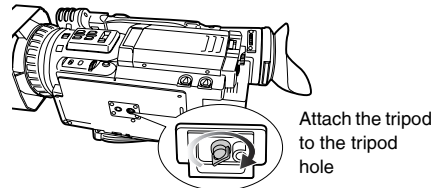

# Checking the system operations

After purchase, do these system checks to ensure that the unit is working properly before you attempt to shoot anything.

## Items to prepare

### AC adapter

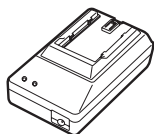

### AC power supply cord

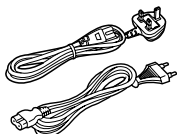

### DC cord



### Mini DV cassette tape

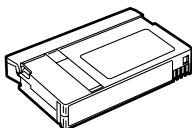

## Connect the AC power supply cord

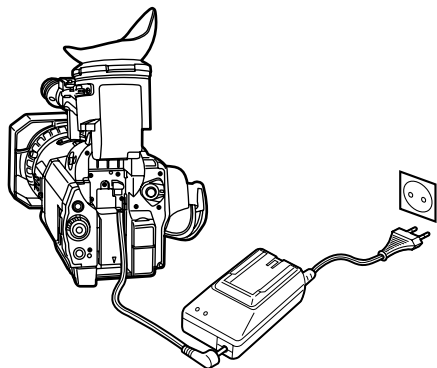

- 1 Lift up the viewfinder.
- 2 Press on the DC cord's battery connector and move it down until it clicks into place.
- 3 Connect the DC cord to the AC adapter.
- 4 Plug the AC cord into the power outlet.
- 5 Return the viewfinder to its original position.

**Connect the cords properly as shown in the figure above.**

- You cannot charge the battery when supplying power to the camera-recorder from the AC adapter.

## Insert the Mini DV cassette tape

- 1 Slide the EJECT switch in the direction shown by the arrow to open the cassette holder. The cassette holder opens automatically when the cassette cover is fully open.
  - The cassette holder will not open if the camera is not supplied with power (AC adapter or battery).

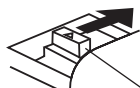

EJECT switch

- 2 Insert the cassette as shown in the diagram.

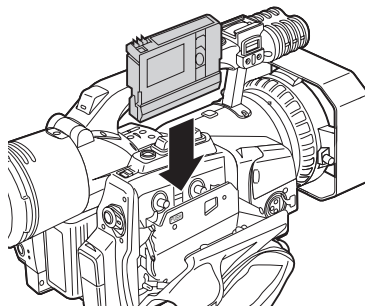

- 3** Press PUSH to close the cassette holder. The holder automatically goes into position when you close it correctly.

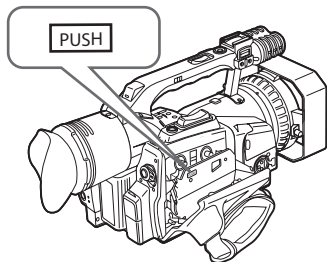

- Do not try to insert or eject the tape by just holding the cassette cover.
- Insert and remove cassette tapes after putting the camera-recorder down on a stable, flat surface or hold it with both hands to keep it stable.
- Do not force the cassette holder while it is moving. Trying to do so could damage the camera.
- Close the cassette cover only after the cassette holder is completely in position. Trying to close the cover while the cassette holder is moving could damage the camera.

## Start shooting

### Viewfinder

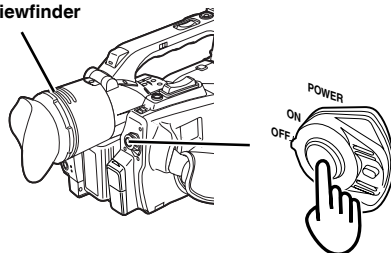

- 1** Look at your subject through the viewfinder.
- 2** Press the START/STOP button on the POWER switch to start shooting. Press START/STOP again to return the camera to the shooting standby mode.

## Turn on the camera

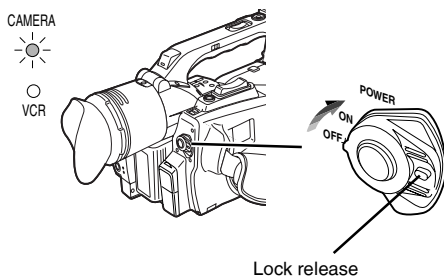

While pressing the lock release, move the POWER switch to ON.

The CAMERA lamp lights red (camera mode) and the camera is now in the shooting standby mode.

## Checking the system operations (continued)

### Check what you have shot (rec check)

- 1 Press the OPEN button in the direction shown by arrow (1) to open the LCD. It can open out to 120 degrees. Do not try to open it further as this will damage the camera.

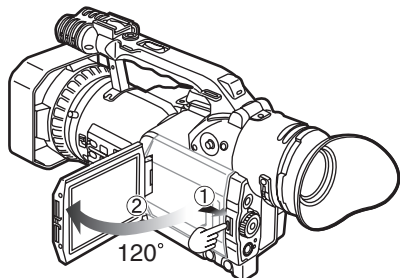

- 2 While in the shooting standby mode, press the REC CHECK button. A few seconds of the last thing you shot play, and then the camera returns to the shooting standby mode.

#### REC CHECK button

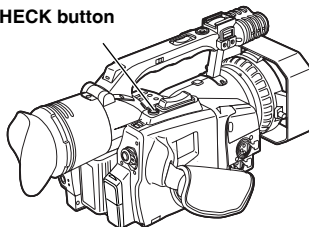

#### Power saving mode

The camera-recorder performs as follows when you pause or leave it in standby mode for about 5 minutes, and do not perform any specified operations.

ON: The camera recorder turns off automatically

OFF: The cylinder head pauses and goes into standby mode without cutting the power.

See the setup menus, OTHER FUNCTIONS screen, POWER SAVE (Page 77) for details.

### Eject the tape

- 1 Slide the EJECT switch in the direction shown by the arrow to open the cassette cover. When the cassette cover is fully open, the cassette holder automatically opens out.
  - The cassette holder will not open if the camera is not supplied with power (AC adapter or battery).

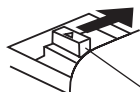

EJECT switch

- 2 Remove the cassette. Press PUSH to close the cassette holder.

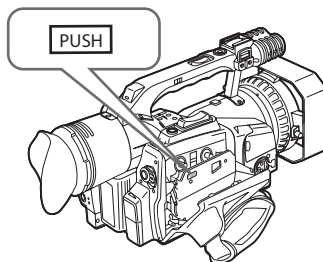

- 3 Close the cassette cover only after the cassette holder is completely in position. Do not close the cassette cover while the cassette holder is moving as this can damage the mechanism.

- Make sure the camera-recorder is supplied with power before operating the EJECT switch.
- Close the cassette holder again if you are not going to insert another tape.
- Do not open the cassette cover while you are recording. Recording continues, and the open cover allows outside light and dust to adversely affect the tape.

## Turn off the unit

CAMERA



VCR

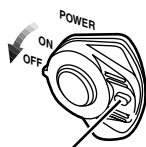

**Lock release**

While pressing the lock release, move the POWER switch to OFF.

The red CAMERA lamp goes out.

## Disconnect the power cord

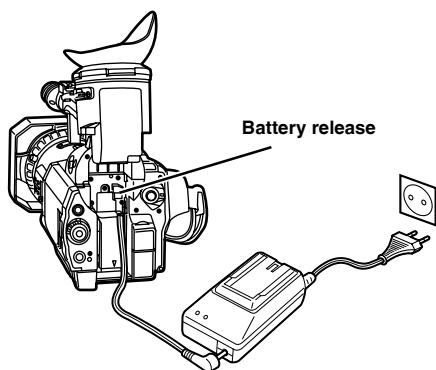

- 1** Unplug the AC cord from the power outlet.
- 2** Lift up the viewfinder.
- 3** While pressing the battery release, pull the DC cord's battery connector towards you.
- 4** Return the viewfinder to its original position.

- Turn POWER to OFF and check that the POWER lamp (CAM/VCR) has gone off before disconnecting the power cord.

## Adjusting the hand strap

Adjust the hand strap to suit your hand.

- 1 Open the cover and adjust the length.
- 2 Close the cover.
  - Make sure the cover is fully closed.

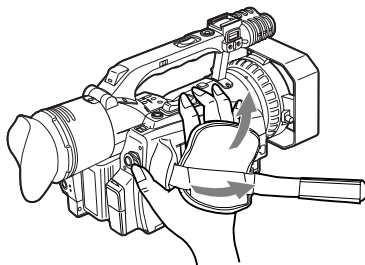

## Attaching the shoulder strap

Attach the shoulder strap and use it as a precaution against dropping the camera.

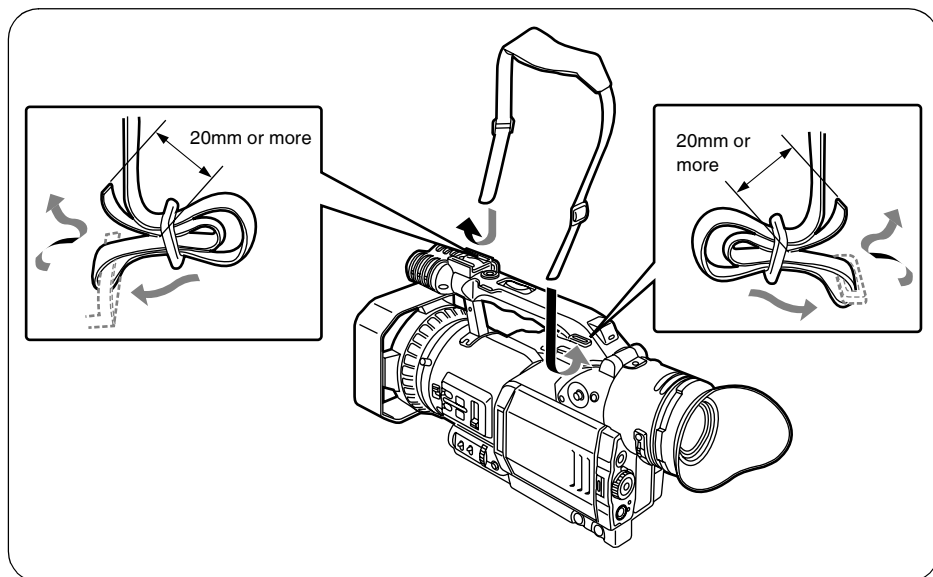

# Attaching the lens hood

## Detaching the lens hood

- Loosen the screw and turn the lens hood counterclockwise to detach it.

## Attaching the lens hood

- Position the lens hood so the mark is at the top and fit it onto the lens.
- Turn the lens hood clockwise and fix in position with the screw.

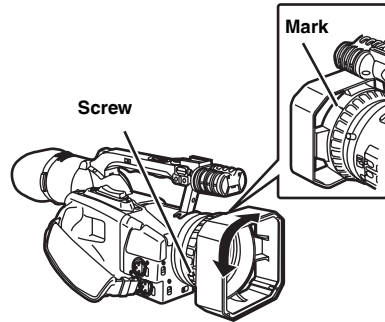

Before use

# Attaching the lens-cap strap

Thread the strap through the lens cap. Thread one end through the hand strap.

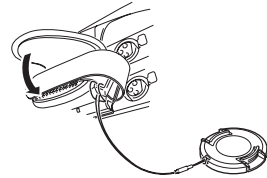

# Cassette tapes

- Use the following mini DV cassette tapes with this camera-recorder.

AY-DVM63PQ Professional series tape

(60 minutes in SP mode)

AY-DVM63MQ Master series tape

(60 minutes in SP mode)

- Picture quality does not worsen if you shoot in LP mode, but you may notice some block noise and there may be other limitations.

Block noise and feature limitations occur in the following situations.

- When you play a tape on other digital video equipment that you have shot in LP mode on this camera.
- When you play a tape in this camera that you have shot in LP mode on other digital video equipment.
- When you have shot in LP mode and try to play it on other digital video equipment that doesn't have an LP mode.
- During slow motion or still-picture playback
- When using the camera's search functions

- Audio dubbing cannot be performed in the LP mode as the tracks on the tape are narrower than the heads.

## Preventing accidental erasure

To prevent erasing the recordings on a tape by accident, set the tab on the cassette to SAVE.

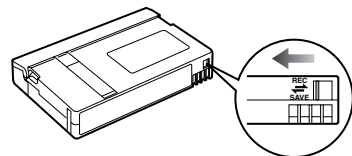

# Description of parts

## Camera-recorder

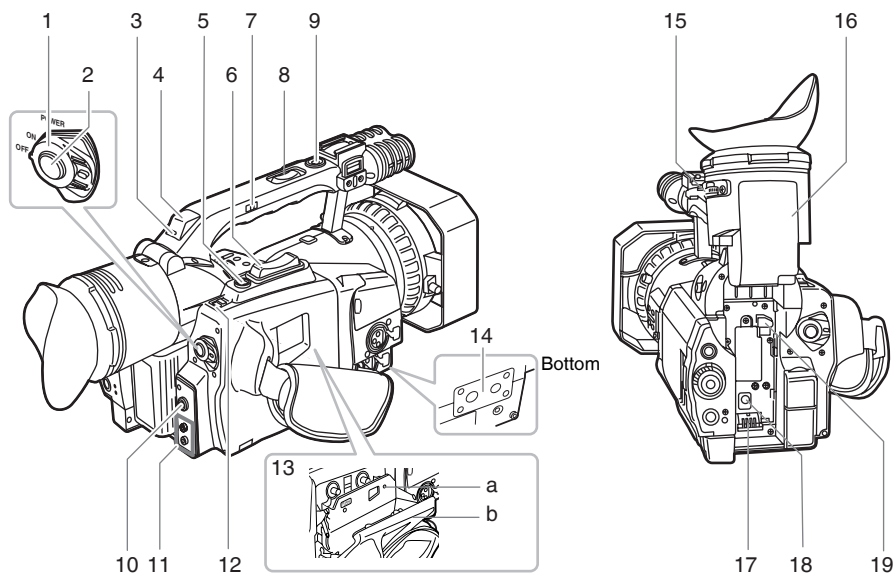

- 1 **POWER switch** (Page 10)
- 2 **START/STOP button** (Page 10)
- 3 **Rear tally lamp** (Page 81)
- 4 **Rear remote control sensor**
- 5 **REC CHECK button** (Page 11)
- 6 **Zoom button** (Page 31)
- 7 **HANDLE ZOOM switch** (Page 31)
- 8 **Handle zoom button** (Page 31)
- 9 **Handle START/STOP button** (Page 32)
- 10 **PHONES jack (3.5-mm stereo)** (Page 52)
- 11 **Remote control jacks**  
FOCUS/IRIS (3.5 mm mini jack)  
Connect a remote control to remotely control focus and iris.  
ZOOM S/S (2.5 mm Super mini jack)  
Connect a remote control to remotely control zoom and start/stop.
- 12 **EJECT switch** (Page 9)
- 13 **Cassette section** (Page 9)
  - a) Cassette holder
  - b) Cassette cover
- 14 **Tripod hole** (Page 8)
- 15 **Viewfinder diopter dial** (Page 22)
- 16 **Viewfinder** (Page 22)
- 17 **Power terminals** (Page 9)
- 18 **DC INPUT terminal (7.9 V)**
- 19 **Battery release** (Pages 12 and 21)

### Information:

Do not connect any equipment except the remote controller to the remote control jack. If any equipment except the remote controller is connected, the pictures will be affected e.g. appear dark or out of focus.



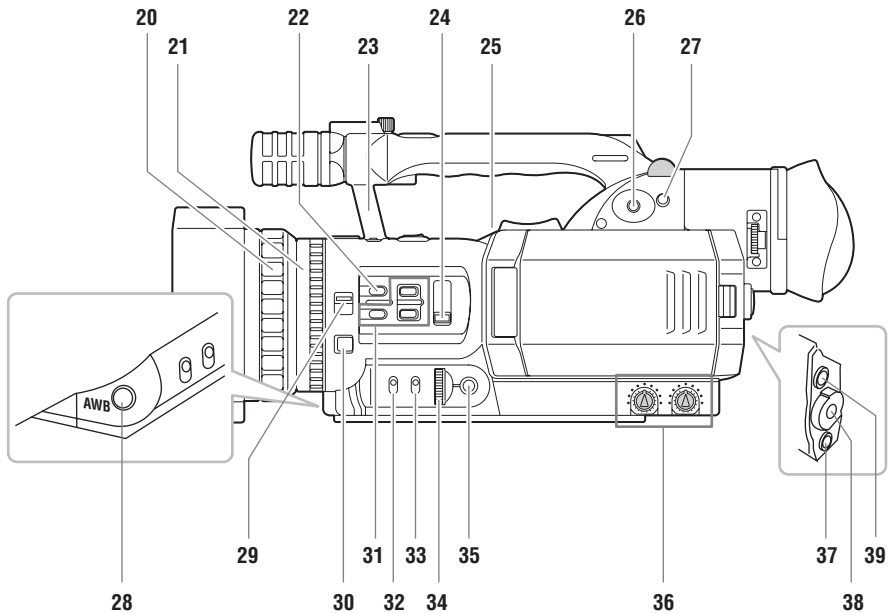

- |   |  |
|---|--|
| 20 <b>Focus ring</b> (Page 37)  | 31 <b>USER buttons 1 to 3</b> (Page 34)                  |
| 21 <b>Zoom ring</b> (Page 31)<br>If you don't need the zoom ring pin, fit it into the provided hole (23) so that you don't lose it. | 32 <b>GAIN switch</b> (Page 42)                          |
| 22 <b>AUTO button</b> (Pages 30 and 35)   | 33 <b>WHITE BAL switch</b> (Page 40)                     |
| 23 <b>Hole for the zoom ring pin</b>  | 34 <b>IRIS dial</b> (Page 42)                            |
| 24 <b>ND FILTER switch</b> (Page 42)  | 35 <b>IRIS button</b> (Page 42)                          |
| 25 <b>Speaker</b> (Page 48)   | 36 <b>AUDIO control</b> (Page 43)                        |
| 26 <b>OPERATION lever</b> (Pages 31, 47, and 65)  | 37 <b>CAMERA/VCR button and lamp</b> (Page 47)           |
| 27 <b>MENU button</b> (Page 65)   | 38 <b>Scene file dial</b> (Page 44)                      |
| 28 <b>AWB button</b> (Pages 40 and 41)  | 39 <b>EVF DTL/END SEARCH button</b><br>(Pages 23 and 50) |
| 29 <b>FOCUS switch</b> (Page 37)  |  |
| 30 <b>PUSH AUTO button</b> (Page 37)  |  |

## Description of parts (continued)

### Camera-recorder (continued)

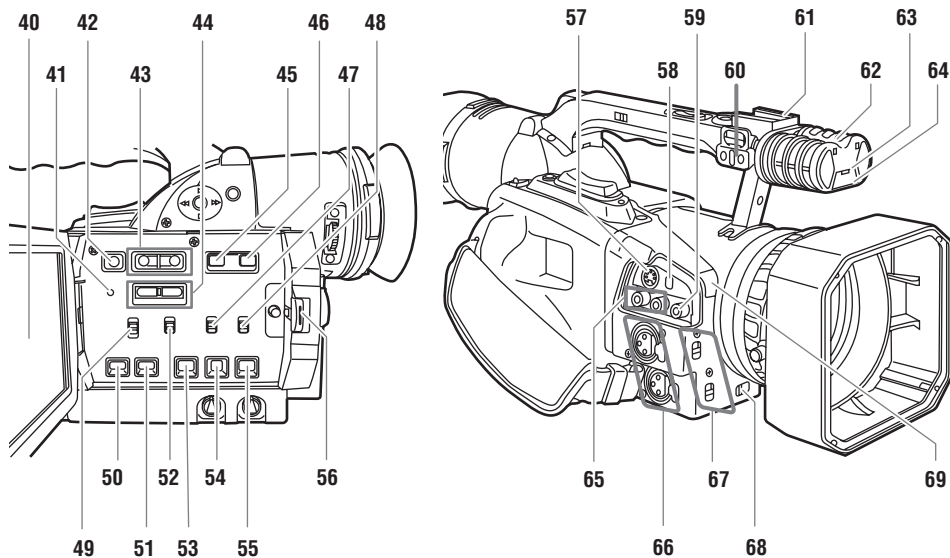

- 40 **LCD monitor** (Pages 8 and 23)
- 41 **RESET button** (Page 23)
- 42 **DISPLAY/AUDIO DUB button**  
(Pages 55 and 64)
- 43 **VCR REC buttons** (Pages 57 and 59)
- 44 **AUDIO MON/VAR buttons**  
(Pages 48, 49, and 50)
- 45 **SHUTTER button** (Page 38)
- 46 **SPEED SEL button** (Page 38)
- 47 **INPUT1 switch (MIC POWER +48 V)** (Page 43)
- 48 **INPUT2 switch (MIC POWER +48 V)** (Page 43)
- 49 **CH1 SELECT switch** (Page 43)
- 50 **COUNTER button** (Page 51)
- 51 **COUNTER RESET/TC SET button**  
(Pages 24 and 51)
- 52 **CH2 SELECT switch** (Page 43)
- 53 **MODE CHK button** (Page 64)
- 54 **ZEBRA button** (Page 32)
- 55 **OIS button** (Page 34)
- 56 **OPEN button** (Page 23)
- 57 **S-VIDEO IN/OUT terminal** (Page 54)
- 58 **DV terminal** (Page 35)
- 59 **VIDEO IN/OUT terminal (pin jack)** (Page 54)
- 60 **Microphone shoe** (Page 52)
- 61 **Light shoe**
- 62 **Built-in stereo microphone** (Page 43)
- 63 **Front tally lamp** (Page 81)
- 64 **Front remote control sensor**
- 65 **AUDIO IN/OUT CH1/CH2 terminal (pin jack)**  
(Page 54)
- 66 **INPUT 1/2 terminal (XLR, 3 pin)**  
(Pages 43 and 52)
- 67 **INPUT 1/2 switch** (Page 43)
- 68 **ZOOM switch** (Page 31)
- 69 **White balance sensor** (Page 40)

## Remote control

The following buttons are for functions that cannot be executed on the camera-recorder.

- PHOTO SHOT
- MULTI/P-IN-P
- STORE
- PB.ZOOM
- TITLE
- SELECT
- OFF/ON

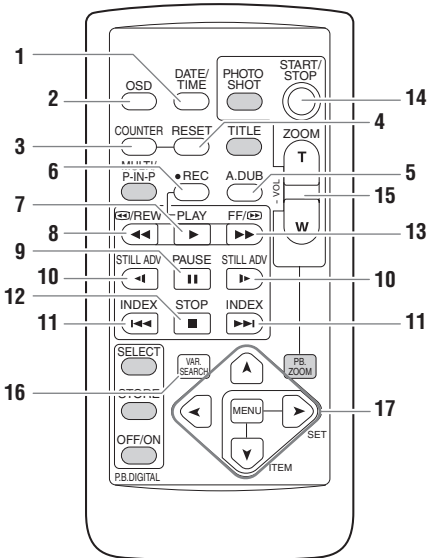

- 1 **DATE/TIME button** (Page 48)
- 2 **OSD button** (Page 48)
- 3 **COUNTER button**  
Same function as the COUNTER button on the main unit.
- 4 **COUNTER RESET button**  
Same function as the COUNTER RESET button on the main unit.
- 5 **A.DUB button**  
Same function as the AUDIO DUB button on the main unit.
- 6 **REC button** (Pages 57 and 59)

### (Used during VCR mode)

- 7 **PLAY button** (▶) (Page 47)
- 8 **REW button** (◀◀) (Page 47)
- 9 **PAUSE button** (||) (Page 47)
- 10 **STILL ADV button** (◀|, |▶) (Page 49)
- 11 **INDEX buttons** (◀◀, ▶▶) (Page 49)
- 12 **STOP button** (■) (Page 47)
- 13 **FF button** (▶▶) (Page 49)

### Buttons for shooting and volume control

- 14 **START/STOP button**  
Same function as the START/STOP button on the main unit.
- 15 **ZOOM/VOL buttons** (Pages 31 and 48)
- 16 **VAR. SEARCH button** (Page 50)
- 17 **MENU button**  
Functions the same as the MENU button on the camera.  
[◀], [▶], [▲], [▼] buttons  
Function the same as the ◀◀, ▶▶, ▲, ▼ buttons on the camera.

# The remote control

## Insert the battery

- 1 Push the catch in the direction shown by arrow (1) to remove the holder.

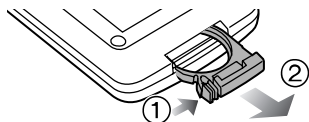

- 2 Insert the battery with the "+" marked side facing up.

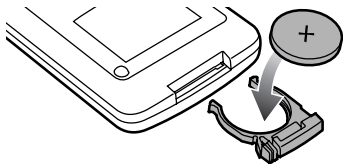

- 3 Return the holder to its original position.

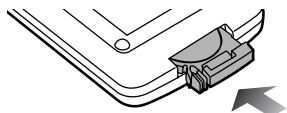

- When the battery (CR2025) has run out, replace it with a new one. (The battery lasts about one year, depending on the frequency of use.)  
If the remote control unit fails to work even when it is operated near the camera-recorder's remote control sensor, the battery has run out.
- **Keep the battery out of the reach of children.**

## Remote control setup

When using two camera-recorders simultaneously, set this camera-recorder and the remote control to either [VCR1] or [VCR2] so the remote control does not operate the wrong camera-recorder by mistake.

### Setting

#### • Wireless remote control

Press the STOP (■) and STILL ADV (▶) buttons at the same time to set the remote control unit for use with VCR1.

Alternatively, press the STOP (■) and STILL ADV (◀) buttons at the same time to set the remote control unit for use with VCR2.

When the battery in the remote control unit is replaced, the remote control unit is set for use with VCR1.

#### • Camera

In the setup menus, OTHER FUNCTIONS screen, REMOTE, set to VCR1 or VCR2. (Page 76)

If different settings are used for the camera-recorder and remote control unit, "REMOTE" lights in red on the viewfinder and LCD monitor.

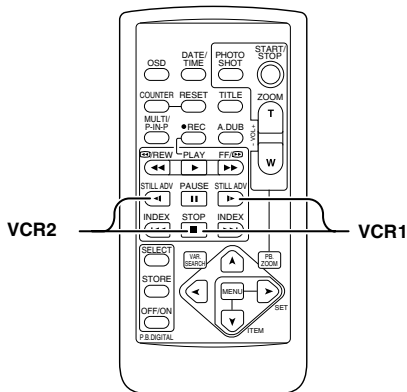

# The battery

## Charging

Before using the battery, fully charge it with the AC adapter.

Keep a spare battery with you.

**1** Align the battery with the “ $\Rightarrow$ ” marking on the AC adapter, place it flat, and slide it in the direction shown below.

- You cannot charge the battery if the DC cord is connected to the DC OUT connector, so disconnect it first.

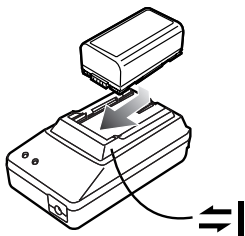

**2** Plug the AC cord into the power outlet.

- The POWER lamp and CHARGE lamp on the AC adapter light, and charging begins.
- If the CHARGE lamp does not light when attached, detach the battery and then attach it again.

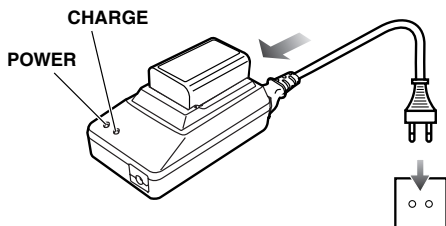

**3** When the battery is charged, the CHARGE lamp on the AC adapter goes out.

**4** Slide the battery and remove it.

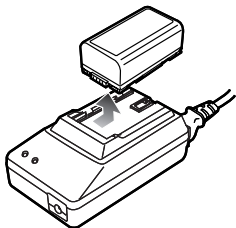

## Recording time of included battery

Recharging time	Continuous recording time
Approx. 330 min.	Approx. 360 (or 300) min.

- Times given above are approximate. Figures in parentheses show the recording times when you use the LCD monitor.
- The times apply when the ambient operating temperature is 68°F (20°C) and humidity is 60%. Charging may take longer at other temperatures and humidity levels.

• **Keep metal objects (such as necklaces and hairpins) away from the battery. Short-circuiting may occur across the terminals, causing the battery to heat up, and you may seriously burn yourself if you touch the battery in this state.**

- The battery becomes hot while it is being used or charged.  
The camera-recorder itself also becomes hot during use.

- The recordable time reduces if you repeatedly start and stop recording.

- Discharge the battery before storing it.  
When storing it for an extended time, charge it at least once a year, use up its charge in the camera-recorder, and then store it again.

- If the battery is extremely hot or cold, the CHARGE lamp will blink several times before charging starts.

- If the CHARGE lamp continues to blink even when the battery temperature is normal, there may be something wrong with the battery or AC adapter. Contact your dealer.

- The battery takes longer to charge when it is warm.

- The AC adapter can interfere with radio reception so keep radios at least 1 meter away from it.

- The AC adapter may make some noise when you are using it, but this is normal.

- You cannot charge the battery when supplying power to the camera-recorder from the AC adapter.

## The battery (continued)

### Attaching the battery

- 1 Lift up the viewfinder.

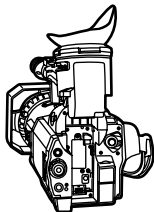

- 2 Press on the battery and move it down until it clicks into place.

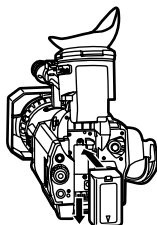

- 3 Return the viewfinder to its original position.

### Detaching the battery

- Turn POWER to OFF and check that the POWER lamp (CAM/VCR) has gone off before detaching the battery.
- Support the battery with your hand so that it does not fall.

While pressing the battery release, lift the battery out.

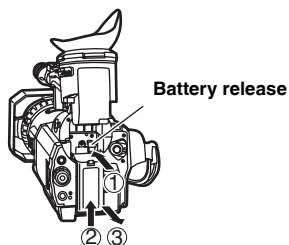

# Viewfinder

This camera has two viewfinders; one is a miniature LCD in the viewfinder and the other is a retractable 3.5-inch LCD.

Use the viewfinder that best suits the application and shooting conditions.

- The brightness and hue may differ between the images appearing on the viewfinder and LCD monitor and those displayed on a TV monitor. To see how the final images will appear, check them on a TV monitor.

## Using the viewfinder

- 1 Set the POWER switch to ON and check that images appear in the viewfinder.
  - Keep the LCD monitor closed.



- 2 Adjust the viewfinder's angle so that the screen is positioned where it is easiest to see.
  - You can move the view finder out to about 90° perpendicular to the camera.
- 3 Adjust the diopter adjustment lever so that you can see the characters on the viewfinder screen clearly.

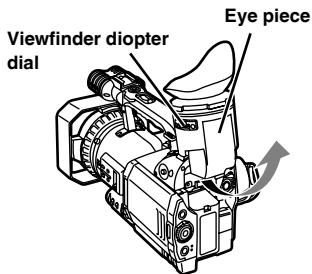

**Do not point the viewfinder at the sun.**  
Doing so may damage the parts inside.

### Fitting the eye cup

Attach the eye cup by aligning the projections on the eye cup holder and eye cup and fitting them together.

- Turning the eye cup after attaching it may cause the eye cup holder to come off. If the eyecup holder does come off, see "Cleaning the Viewfinder" (Page 82) for details on how to refit it.

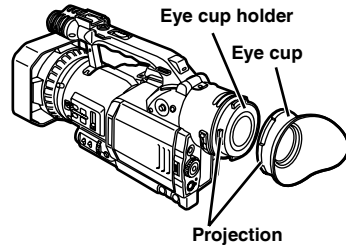

## Viewfinder (continued)

### Using the LCD

- 1 Set the POWER switch to ON.
- 2 Press the OPEN button in the direction shown by arrow (1) to open the LCD. It can open out to 120 degrees. Do not try to open it further as this will damage the camera.

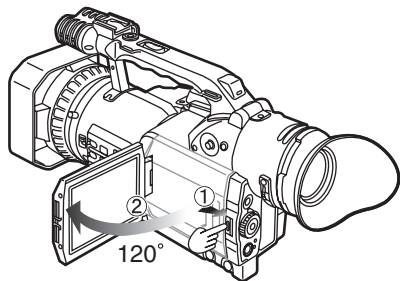

- 3 Position the LCD monitor where it is easiest to see.
  - The monitor can be rotated 180° toward the lens and 90° toward you.
  - Do not apply unnecessary force to the open LCD. This can damage the camera.

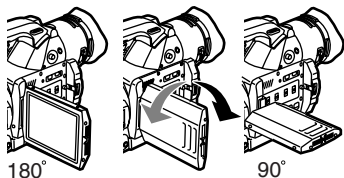

- Ensure the LCD is fully closed.
- Both the LCD and viewfinder come on when you have rotated the LCD to face in the same direction as the lens for self-portrait shooting.

### Emphasizing outlines

Emphasizing the outlines of the images you see in the viewfinder or on the LCD makes it easier to focus.

Emphasizing the outlines does not effect the images you shoot.

- 1 In CAMERA mode, press EVF DTL/END SEARCH.
  - “EVF DTL ON” appears on the screen for about 2 seconds.

EVF DTL/  
END SEARCH button

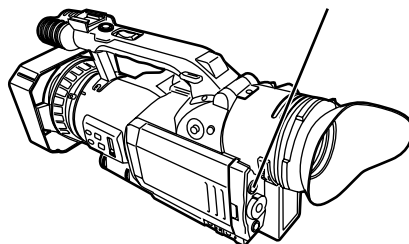

Press EVF DTL/END SEARCH again to return to the original display. “EVF DTL OFF” appears on the screen for about 2 seconds.

EVF DTL/END SEARCH works differently when in VCR mode. (Page 50)



## Adjusting the screen display

- To adjust the viewfinder's screen:  
In the setup menus, DISPLAY SETUP screen  
EVF SET, select YES.  
To adjust the LCD's screen:  
In the setup menus, DISPLAY SETUP screen  
LCD SET, select YES.
  - For menu operation (Page 65)
  - You can also use the menu buttons on the remote control. (Page 18)

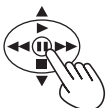
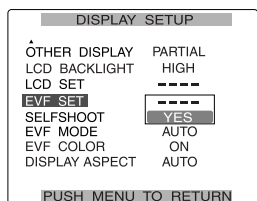

The following explanations show how to change the viewfinder's display. You can change the LCD's displays in the same way.

- Select EVF COLOUR LEVEL and move the OPERATION lever ◀ or ▶ to adjust the color level of the screen.

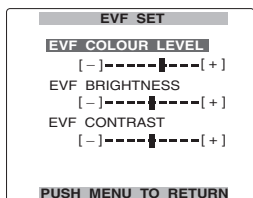

- Select EVF BRIGHTNESS and move the OPERATION lever ◀ or ▶ to adjust the brightness of the screen.

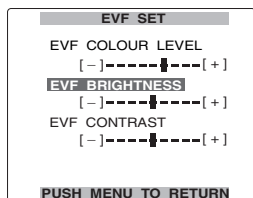

- Select EVF CONTRAST and move the OPERATION lever ◀ or ▶ to adjust the contrast of the screen.

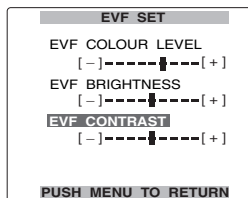

- Press MENU three times to exit the menus.



- You can return the settings for EVF SET and LCD SET to the factory settings by selecting the item and pressing COUNTER RESET (if it is possible to change the item at that time).

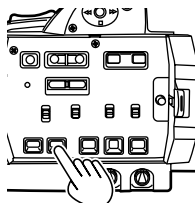

Camera

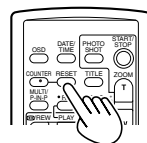

or Remote control

- The viewfinder remains on when you open the LCD if you have set the EVF MODE in the DISPLAY SETUP screen to ON.
- The viewfinder display can be in color or black and white. (See the setup menus, DISPLAY SETUP screen, EVF COLOUR.) The resolution is the same for both of them.

# Time data

## Setting the calendar

This shows you how to adjust the calendar to 5:20 PM on December 25, 2005.

- 1 Set the POWER switch to ON.



- 2 In the setup menus, OTHER FUNCTIONS screen, CLOCK SET, select YES.

- For menu operation (Page 65)
- You can also use the menu buttons on the remote control. (Page 18)

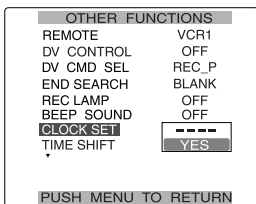

- 3 Move the OPERATION lever ◀ or ▶ to set the year to 2005.

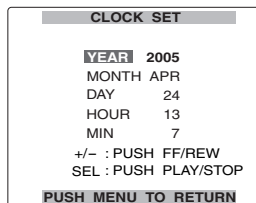

Choose a year between 2000 and 2089.

- 4 Move the OPERATION lever ▼ to move to MONTH.

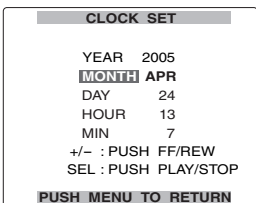

- 5 Move the OPERATION lever ◀ or ▶ to set the MONTH to DEC.

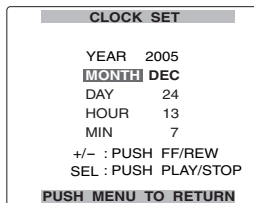

- 6 Set DAY, HOUR, and MIN using the method shown in steps 4 and 5.

- This is a 24-hour clock.

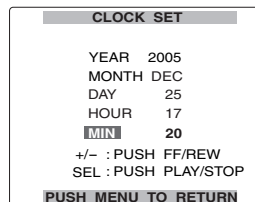

- 7 Press MENU three times to exit the menus.



The clock can vary in accuracy so check that the time is correct before shooting.

## Recharging the built-in battery

The camera's internal battery saves the date and time. "  " appears on the screen of the viewfinder or LCD when the internal battery is running low on charge.

Do the following to recharge it.

Reset the date and time when fully recharged.

- 1 Connect the AC adapter.  
(Page 9)
- 2 Leave the POWER switch at OFF.
- 3 Leave the camera-recorder like this for about 4 hours.
  - The internal battery charges during this time.

## Setting user information

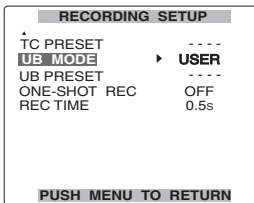

Setting user information allows you to store 8-digit information (such as the date and time) in the hexadecimal format on the tape's sub code track. User information is automatically saved in the memory and retained after you turn off the power.

- 1 Set the POWER switch to ON.
- 2 In the setup menus, RECORDING SETUP screen UB MODE, select USER.
  - For menu operation (Page 65)
  - You can also use the menu buttons on the remote control. (Page 18)

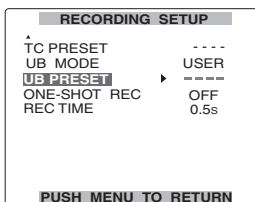

- 3 Move the OPERATION lever ▼ to select UB PRESET.



- 4 Press the OPERATION lever  (or move it ) , move it ▼ to select YES and press  again.

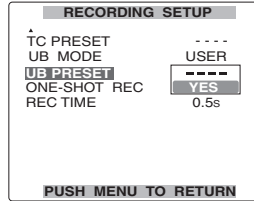

- 5 The following screen appears, so use the OPERATION lever to set the user information.

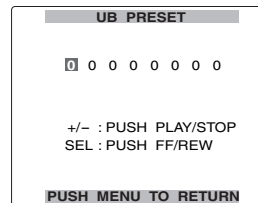

Move the OPERATION lever ▲ or ▼ to select the characters for the user information.

- You can use numbers from 0 to 9 and letters from A to F.

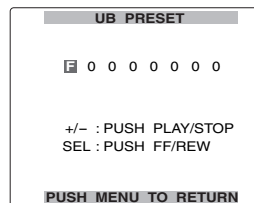

Move the OPERATION lever ◀◀ or ▶▶ to move to the next digit.

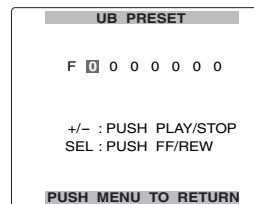

## Time data (continued)

You can reset user information to nothing by pressing COUNTER RESET.

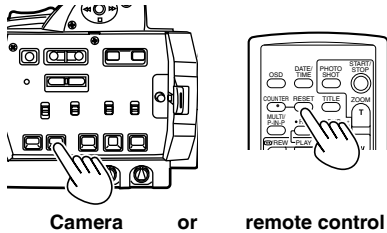

## Setting the time code

In the setup menus, RECORDING SETUP screen, set the following time code related items. (Page 73)

- TCG
  - FIRST REC TC
  - TC PRESET
  - 1394 TC REGEN (appears when in VCR mode)
- In VCR mode and 1394 TC REGEN is ON, you cannot change the items shown above.

- 6 Press the MENU button when you have finished setting the user information.



- 7 The following screen appears, so move the OPERATION lever ▲ to select YES..

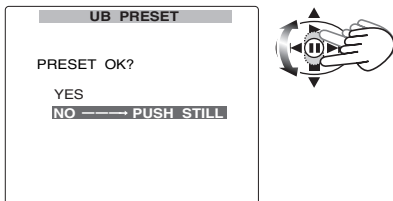

- 8 Press the OPERATION lever [II].

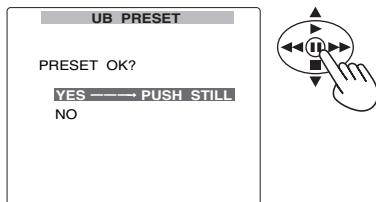

- 9 Press MENU twice to exit the menus.



## Specifying the time code (TC PRESET)

Set TC PRESET so you can record a value of your choice as the initial setting for the time code to be used at the start of recording.

- 1 Set the POWER switch to ON.



- 2 In the setup menus, RECORDING SETUP screen FIRST REC TC, select PRESET.
- For menu operation (Page 65)
  - You can also use the menu buttons on the remote control. (Page 18)

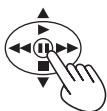
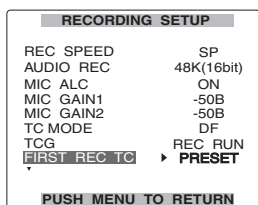

- 5 The following screen appears, so use the OPERATION lever to set the time code.

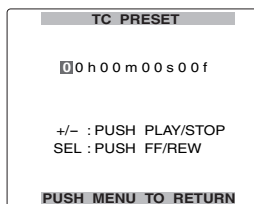

Move the OPERATION lever ▲ or ▼ to change the time code.

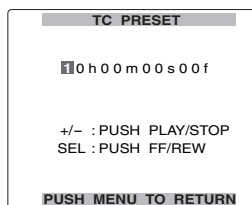

- 3 Move the OPERATION lever ▼ to select TC PRESET.

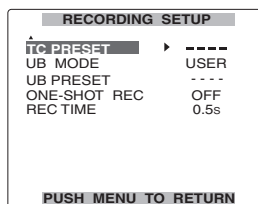

Move the OPERATION lever ◀◀ or ▶▶ to move to the next digit.

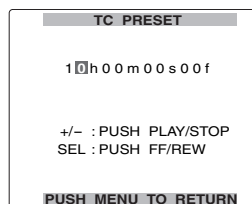

- 4 Press the OPERATION lever (|||)(or move it ▶▶), move it ▼ to move to YES and press (|||) again.

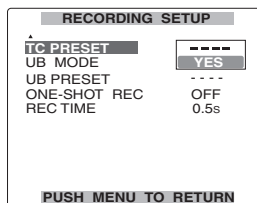

You can reset the time code to zero by pressing COUNTER RESET.

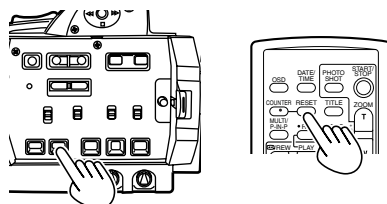

## Time data (continued)

---

- 6 Press the MENU button when you have finished setting the time code.



- 7 The following screen appears, so move the OPERATION lever ▲ to select YES.

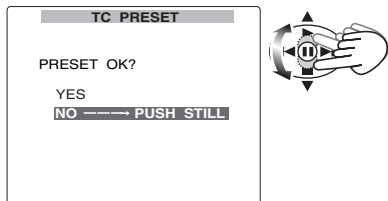

- 8 Press the OPERATION lever [II].

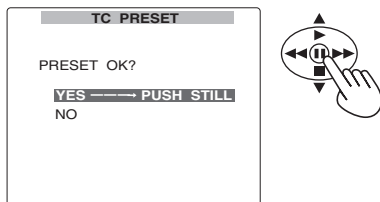

- 9 Press MENU twice to exit the menus.



# Regular shooting

## Preparation and inspections

Ensure that the unit is working properly before you attempt to shoot anything.

Check the equipment you need for the shooting conditions.

### ■ Battery (Page 20)

Use a fully charged battery.

Keep a spare battery with you.

### ■ Cassette tape (Pages 9 and 14)

Check that the cassette tape can be used for recording.

- Set the erasure prevention tab to SAVE.
- Make sure the tape doesn't have images you want to keep recorded on it.
- Make sure the cassette holder is completely closed.

### ■ Viewfinder (Page 22)

See if the diopter adjustment is suitable.

### ■ Zoom, focus, and iris

- Check that motor-driven zooming is possible. (Page 31)
- Check that the focusing can be performed both automatically and manually. (Page 37)
- Check that the lens iris operations can be performed automatically and manually. (Page 42)

### ■ Time data (Page 25)

- Check that the date and time have been set correctly.
- Check that the time code and user information have been set correctly.

### ■ Audio input (Page 43)

Check that CH1/CH2 SELECT switch is in the correct position.

### ■ Other equipment (Page 52)

- Check that any equipment you have connected to the camera is working correctly.
- Check that connections are complete and correct.

## Shooting in auto mode

- 1 Set the POWER switch to ON.
- 2 Press AUTO to switch to auto mode.
  -  appears on the viewfinder and LCD screens.

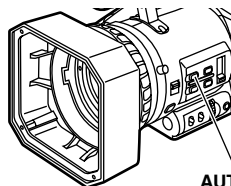

AUTO button

The camera makes the following adjustments for you when in auto mode.

- Focus
- Gain
- Iris
- White balance

- In the setup menus, AUTO SW screen, you can choose which items you want to have automatically adjusted in auto mode. (Page 71)

Viewfinder

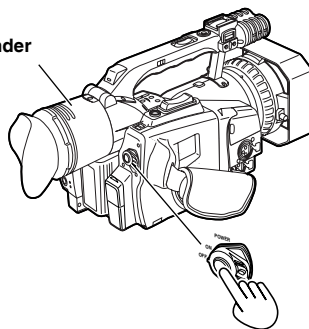

- 3 Look at your subject through the viewfinder.
- 4 Press the START/STOP button on the POWER switch to start shooting. Press START/STOP again to return the camera to the shooting standby mode.

# Shooting techniques for different targets

## Check what you have shot (rec check)

Press REC CHECK in the shooting standby mode and two seconds of the last thing you shot play, and then the camera returns to the shooting standby mode.

- REC CHECK does not work if you have shot for less than a second.
- Note that this REC CHECK portion will also be recorded to any equipment you have set up to make backup recordings.

REC CHECK button

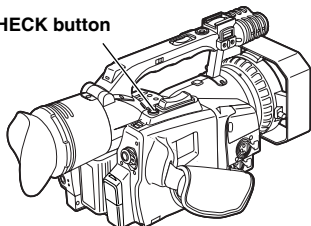

## Finding specific scenes (image search)

While in the shooting standby mode, you can search through any images you have shot. This is useful when you want to find a point from which to continue shooting so two scenes come one after the other.

- 1 Press the OPERATION lever **▶▶** or **◀◀**. The tape plays forward or backward while you are holding the lever in position.

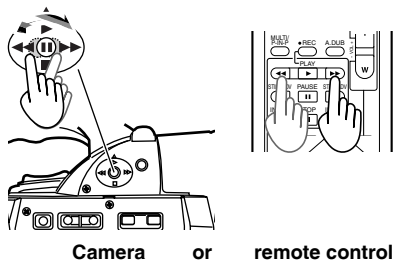

- 2 Release the lever when you find the point you are looking for. The camera returns to shooting standby mode.

## Zoom

This camera has a 10 x zoom. Zoom with the zoom button or the zoom ring.

Zoom button (handle)

HANDLE ZOOM switch

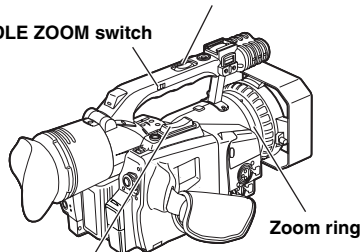

Zoom button

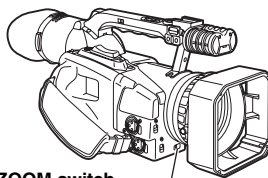

ZOOM switch  
SERVO ZOOM 1 MANU

### Zoom button

Set the ZOOM switch to SERVO so that you can use the motor-driven zoom.

T: Zoom in

W: Zoom out

Gently press the zoom button on the viewfinder to zoom slowly, firmly press to zoom faster.

You can change the zoom speed on the handle zoom button by selecting one of three speeds with the HANDLE ZOOM switch.

Set HANDLE ZOOM switch speeds by going to the setup menu, SW MODE screen HANDLE ZOOM. (Page 70)

### Zoom ring

Set the ZOOM switch to MANU so that you can use the zoom ring.

- You cannot use the zoom ring if the ZOOM switch is set to SERVO. Trying to use it could damage the camera.

### On the remote control

Press ZOOM/VOL to zoom with the motor drive. Zoom speed is fixed at medium.



## Low-angle shooting

Use the START/STOP button on the handle to make it easier to shoot from low angles.

### START/STOP button

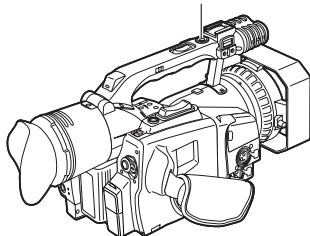

## Self-portrait shooting

Images in the LCD when it is turned 180 degrees for self-portrait shooting may appear unusual. You can make them appear better by reversing left and right. Go to the setup menus, DISPLAY SETUP screen, SELF SHOOT, and select MIRROR. Shooting in mirror mode has no effect on what you actually shoot and record. Items shown on the viewfinder and LCD screens are limited to the following.

- : Shooting
  - || : Shooting standby mode
  - ▬▬▬ : battery indicator
  - ⊠ : warning
- ⊠ If this appears, turn the LCD back to its normal position and see what the warning is.

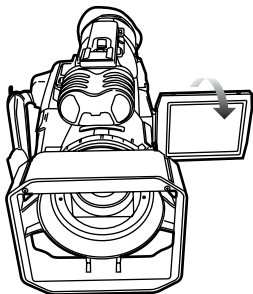

## Zebra pattern

Press the ZEBRA button in the camera mode to show the zebra pattern or marker on the screen so you can check the brightness of the subject. Parts that may be whited out through over exposure are shown as a zebra pattern.

- Very bright
- Reflecting parts

You can remove most overexposed parts by adjusting the iris and shutter speed in the manual mode to remove the areas with zebra patterns. The display changes as follows each time you press the ZEBRA button.

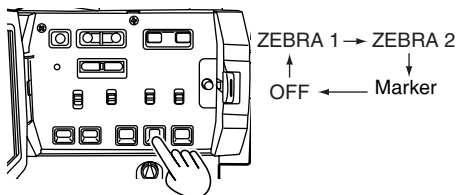

In the setup menus, DISPLAY SETUP screen, ZEBRA DETECT 1 and ZEBRA DETECT 2, set the brightness for the zebra patterns. (Page 75) The zebra pattern you have set appears as a percentage on the display for about 2 seconds.

## Marker

If you press the ZEBRA button again while the zebra pattern is being displayed, a marker appears in the center of the display (if you have set the setup menu, DISPLAY SETUP, MARKER to ON). The image level at the center of the screen is shown as a percentage between 0 and 99 while the marker is displayed. "99%" appears if the percentage is over 99.

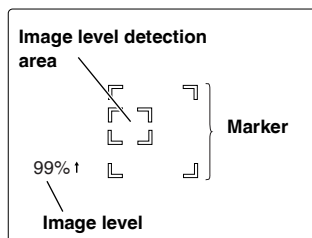

- The normal display reappears if you press the ZEBRA button again.

## Shooting techniques for different targets (continued)

### ONE-SHOT recording

- 1** In the setup menus, RECORDING SETUP screen, ONE-SHOT REC, select ON.
    - For menu operation (Page 65)  
OFF: ONE-SHOT is off.  
ON: The camera records for the number of seconds you have set in REC TIME, then returns to shooting standby mode.
    - While in progressive mode 25P you cannot change ONE-SHOT settings.
  - 2** Set the recording time in REC TIME. (Page 74)
  - 3** Press the START/STOP button to start ONE-SHOT recording.
    - After you have set ONE-SHOT to ON, “|—” blinks to the left of the VCR mode indicator. “|—” lights when you start recording.
  - 4** If you move the OPERATION lever in the ■ direction, “|—” blinks again and ONE-SHOT recording stops and the camera goes to shooting standby mode.
    - During ONE-SHOT recording, no other operations are possible.
    - During ONE-SHOT recording, the remaining tape time is not shown.
- The ONE-SHOT recording setting switches to OFF when you turn the camera off.
- To end ONE-SHOT recording, do one of the following.
- 1) Switch the camera off.
  - 2) Change the ONE-SHOT REC setting back to OFF.

### Changing the image size

You can change the aspect ratio of the images you record with this camera.

Select the aspect ratio in the setup menus, CAMERA SETUP screen, ASPECT CONV.

- For menu operation (Page 65)

#### NORMAL:

Recorded in the regular 4:3 aspect ratio.

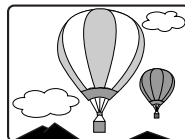

#### LETTER BOX:

Recorded in the 16:9 aspect ratio.

Black bands are recorded at the top and bottom of the image.

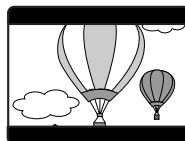

#### SQUEEZE:

The recorded images are squeezed horizontally so that they are shown as 16:9 images on a compatible wide-screen television.

If you have selected SQUEEZE, “SQU” appears on the screen.

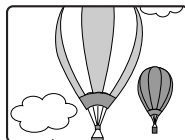

- The viewfinder and LCD screens will be distorted for a moment when you switch to SQUEEZE, but this is normal.
- Images may be poorer when you playback if you shot them in the SQUEEZE mode.
- LETTER BOX is displayed on the EVF/LCD when AUTO or 16:9 is selected in the setup menus, DISPLAY ASPECT.

#### To change the aspect ratio display of the viewfinder and LCD

Select the aspect ratio in the setup menus, DISPLAY SETUP screen, DISPLAY ASPECT (Page 75).

## Optical Image Stabilizer

Use the Optical Image Stabilizer (OIS) to reduce the effects of camera shake when shooting by hand.

Press the OIS button to turn the function on and off.

 appears on the screen when this function is on.

Turn the function off when using a tripod for more natural images.

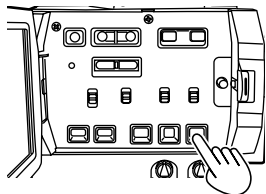

- This function will not be as effective when the vibration is severe or when tracking a moving subject.

## Using the USER buttons

You can allocate one of eleven features to each of the three USER buttons.

Use these buttons to change shooting settings quickly or add effects to the images you are shooting.

The following features are allocated to the buttons at the time of shipping.

USER1: COLOURBAR

USER2: BACKLIGHT

USER3: INDEX

For details, see the setup menus, SW MODE screen, USER1 to 3 (Page 71).

## Backlight compensation

Press the USER button you have allocated to the BACKLIGHT feature when shooting subjects lit from the back.

BACK appears on the screen.

Backlight compensation adjusts the iris so the subject doesn't come out dark.

Press the same USER button to turn the feature off.

(When using manual iris, backlight compensation is maintained even if you turn off the backlight compensation function.)

## Index recording

Press the USER button you have allocated to the INDEX feature during shooting and an index signal is recorded to the tape.

If you press the button while in shooting standby mode, you also activate index standby mode. When you start shooting or recording, an index signal is recorded to the tape.

Adding indexes means that you can make index searches during play. (Page 49)

## Color bars

Press the USER button you have allocated to the COLOURBAR feature to output a color bar screen to a television or monitor so you can adjust them. Press the same USER button to turn the feature off.

## Adding effects to images

Press the USER button you have allocated to the BLACKFADE or WHITEFADE feature to add fading effects to your images.

### BLACKFADE:

Press and hold to fade out to black. Audio also fades out.

### WHITEFADE:

Press and hold to fade out to white. Audio also fades out.

## Shooting techniques for different targets (continued)

### Backup recording



If you have connected equipment to the DV terminal (Page 53). You can make automatic backup recordings of whatever you are shooting.

- In the setup menus, OTHER FUNCTIONS screen, DV CONTROL and DV CMD SEL, select how to control the equipment you have connected. (Page 76)

#### Note the following when backup recording.

- Menu settings are retained even if you turn the power off. So if you use the camera-recorder with the settings for backup recording still in effect, images on tapes in any unit that connected may be overwritten. After backup recording, check the menu item settings before you operate the camera-recorder.
- If you use another AG-DVX100B as the external unit for backup recording, select "OFF" for DV CONTROL on the external unit and set it to VCR mode.
- Backup recording may not work properly if you connect two or more external units.
- Use a DV (IEEE1394) cable of 4.5 m or less for connection.
- Set the external unit up to receive DV signals before backup recording.
- You can have a tape in the external unit start recording automatically when the tape in this unit is almost finished. Set DV CONTROL (Page 76) to "CHAIN".
- Note that images are recorded even when you perform a rec check.

### Switching to manual mode

Press the AUTO button to switch between AUTO (  lights) and manual mode (  goes out). You can change the following settings in the manual mode.

- Focus (Page 37)
- Gain (Page 42)
- Iris (Page 42)
- White balance (Page 40)

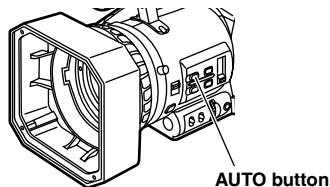

### Adjusting the volume while shooting

If you are monitoring the sound through headphones while shooting, you can adjust the volume with the AUDIO MON/VAR button.

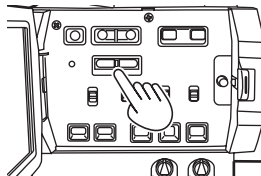

- To adjust the recording level (Page 43).

# Shooting in progressive mode

You can change the progressive mode in the setup menu, SCENE FILE screen, PROGRESSIVE (Page 69).

## 25P mode:

Shoot 25 frames a second in the progressive mode.

For output and recording, the 25-frame-per-second signal is converted to 50-field-per-second interlace.

This mode gives you high quality images .

25 P	A	B	C	D	E	F	G	H	I	J									
↓																			
50 i	Ao	Ae	Bo	Be	Co	Ce	Do	De	Eo	Ee	Fe	Go	Ge	Ho	He	Io	Ie	Jo	Je

## Note the following when shooting in progressive mode.

- You cannot have a gain of 18dB.
- The synchronization signal will be disrupted for a moment when you switch to progressive mode.
- Set the shutter speed to 1/50 (OFF) for best results.

# Focus

---

This camera allows you to choose between automatic and manual focusing.

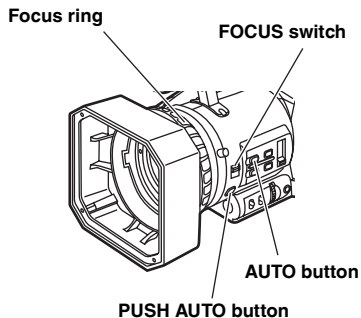

**1** If the camera is in auto mode, press the AUTO button to switch to manual focusing ( **A** goes out).

**2** Use the FOCUS switch to choose how to control focusing.

**A (AUTO):**

Auto focus mode

**M (MANUAL):**

Manual focus mode

Turn the focus ring by hand.

$\infty$  :

The camera first focuses on infinity, then it switches to manual focus.

The FOCUS switch automatically moves back to M (MANUAL) after you move it to  $\infty$  .

**Temporarily switching to auto focus**

Even if you have switched FOCUS to M (MANUAL) the camera will focus automatically while you press down PUSH AUTO.

- Auto focus may not work properly if there is flickering. Select a shutter speed suited to the ambient light. (Page 38)
- When you use auto focus in the progressive or slow shutter modes, the focus assist mode becomes active which gives a more accurate focus than manual focusing.  
The extra focus control will make focusing take longer than normal.

# Adjusting the shutter speed

## Shutter speeds you can select

Progressive mode	Normal shutter speeds (OFF)	Shutter speeds you can select with SPEED SEL button	
		SYNCHRO SCAN	Shutter speed selected
OFF (50i)	1/50	1/50.2 - 1/248.0	1/60, 1/120, 1/250, 1/500, 1/1000, 1/2000
25P	1/50	1/25.1 - 1/248.0	1/25, 1/60, 1/120, 1/250, 1/500, 1/1000

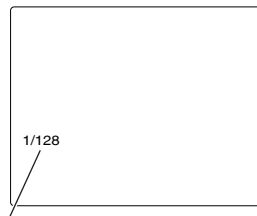
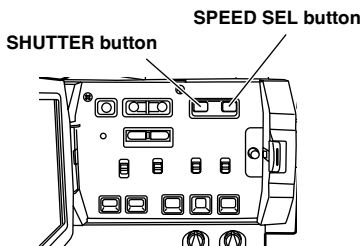

The current shutter speed appears on the viewfinder and LCD screens unless you have selected OFF in OTHER DISPLAY in the DISPLAY SETUP screen of the setup menus. It is not displayed if you have set the shutter speed to normal (OFF).

**1** Each time you press the SHUTTER button, the shutter speed switches between normal (OFF) and the speed you selected with the SPEED SEL button.

**2** After you have pressed the SHUTTER button, press SPEED SEL to select the shutter speed. The shutter speed changes as follows each time you press SPEED SEL.

### When progressive mode is OFF (50i)

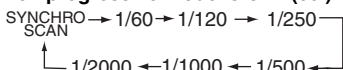

### When progressive mode is on (25P)

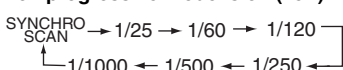

- Remember that the faster the shutter speed, the lower the sensitivity.
- If iris is set to auto, then it will open wider with higher shutter speeds and thereby reduce focal depth.
- If you have set slow shutter mode (Page 39), you cannot change shutter speeds ("INVALID" appears on the screen). First press the USER button you have allocated to SLOWSHUT to cancel the slow shutter mode, then change the shutter speed as shown above.

With artificial lighting and especially fluorescent lights and mercury-vapor lamps, the luminance changes in synchronization with the power line frequency. When this frequency is 50 Hz, mutual interference will occur between the camera-recorder's vertical sync frequency (approx. 60 Hz) and the lighting frequency (50 Hz). This means that the white balance may change periodically. Before shooting in areas with artificial lighting or adjusting the white balance, set the shutter speed as follows.

Progressive mode	Shutter speed	
	50 Hz	60 Hz
OFF (50i)	OFF (1/50)	1/60
25P	OFF (1/50)	1/60

## Adjusting the shutter speed (continued)

### Slow shutter mode

- 1 In the setup menus, SW MODE screen, allocate one of the USER buttons to SLOWSHUT. (Page 71)
- 2 Press the USER button you have allocated to SLOWSHUT to enter the slow shutter mode. Each time you press SPEED SEL, the shutter speed changes as shown below.

#### When progressive mode is off (50i)

1/3 → 1/6 → 1/12 → 1/25



#### When progressive mode is on (25P)

1/3 → 1/6 → 1/12



- “PROCESSING...” appears on the display for a few moments after you enter the slow shutter mode while the camera makes the necessary settings.
- Press the USER button you have allocated to SLOWSHUT again to exit the slow shutter mode and return to the previous mode.
- The slow shutter mode is also canceled if you turn the camera off then on again.
- You cannot control the gain while in slow shutter mode. The gain will be fixed at 0 dB.
- While shooting you cannot change the slow shutter mode settings or exit the mode.
- If you are using a shutter speed selected with the SPEED SEL button (Page 38) you cannot switch to slow shutter mode (“INVALID” appears on the screen).

First press the SHUTTER button to return to normal (OFF), then switch to slow shutter mode.

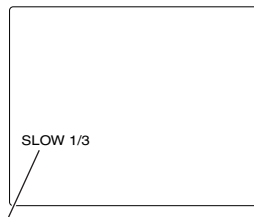

The current slow shutter speed appears on the viewfinder and LCD screens unless you have selected OFF in OTHER DISPLAY in the DISPLAY SETUP screen of the setup menus.

### Synchro scan

Set the shutter speed of the synchro scan (used when shooting a television or computer monitor) in the setup menus, CAMERA SETUP screen, SYNCRO SCAN. (Page 70)

- Adjust the shutter speed to match the frequency of the television or computer monitor to minimize the horizontal noise that appears when shooting such subjects.

You can change the progressive mode in the setup menu with PROGRESSIVE in the SCENE FILE screen (Page 69).



# Adjusting the white balance

When you are shooting in manual mode, readjust the white balance whenever lighting conditions change.

You can save adjustments and reselect them by setting the WHITE BAL switch to A or B.

You can also use the preset values.

Use the settings to suit the shooting conditions.

## White balance sensor

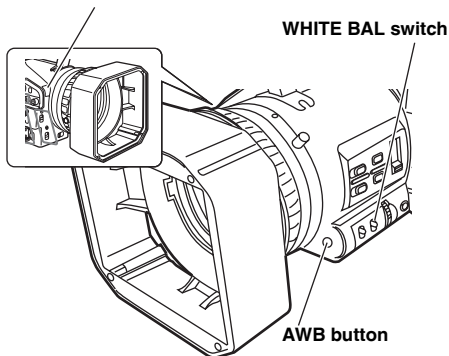

The white balance sensor detects the light source during shooting so the camera-recorder can adjust the white balance. Do not block the sensor.

## White balance adjustments

- 1** If the camera is in auto mode, press the AUTO button to switch to manual focusing ( **A** goes out).
- 2** Set the shutter speed.
- 3** Place a white pattern in a location with the same lighting conditions and light source as the subject, then zoom in and fill the whole screen with white.  
Something white (a white cloth or wall) near the subject can be used instead.
  - Do not include bright spotlights in your shot.
- 4** Set the WHITE BAL switch to A or B (whichever one you want to save the adjustment in).

- 5** Press the AWB button.
  - Adjustment takes a few seconds.  
(The following messages appear on the screen.)

### Message during adjustment

**AWB Ach ACTIVE**

### Message after adjustment

**AWB Ach OK**

An error message appears on the screen when white balance adjustment is not possible.

- White balance cannot be adjusted automatically if the Auto Tracking White (ATW) function is working.

### Message when adjustment cannot be done

**AWB Ach NG**

Error messages	Adjustments
<b>LOW LIGHT</b>	Increase light or increase the gain.
<b>LEVEL OVER</b>	Reduce light or decrease the gain.

Make the necessary adjustments if one of the above error messages appears, then try adjusting the white balance again.

If the messages repeatedly appear even after trying a number of times, consult your dealer.

## Adjusting the white balance (continued)

### Using presets

Use this feature when you have no time to make white balance adjustments.

- 1** If the camera is in auto mode, press the AUTO button to switch to manual focusing ( **[A]** goes out).
- 2** Set the WHITE BAL switch to PRST.  
The current white balance value appears.
  - White balance values 3200 K and 5600 K are preset in the PRST position.  
Guide to the preset values  
3200 K: halogen light  
5600 K: outdoors
- 3** Press the AWB button.  
White balance switches between 3200 K and 5600 K.

### Black balance adjustments

It is not normally necessary to adjust the black balance. Adjust it when:

- You use the camera for the first time
- You use the camera after not using it for a long time
- The ambient temperature changes greatly
- You switch to the normal (OFF) shutter speed or to slow shutter mode
- You switch between the progressive and normal (50i) modes

Press the AWB button to automatically adjust the white balance.

Press and hold the AWB button to adjust the black balance.

- As the white balance is adjusted first when you press the AWB button, make the necessary preparations for this.
- You cannot adjust the black balance while you are shooting.

#### Message during adjustment

**ABB ACTIVE**

#### Message after adjustment

**ABB END**

### Auto Tracking White (ATW)

You can allocate the ATW feature to one of the positions on the WHITE BAL switch (A, B, or PRST). Allocate it by going to the setup menus, SW MODE screen, ATW. (Page 70)

The ATW feature is set to work in the auto mode at the time of shipping.  
(Page 30)

If you use the ATW feature whenever you are shooting, the camera automatically adjusts the white balance as you shoot.

- The ATW feature automatically determines the current shooting environment and adjusts the white balance accordingly. Depending on the environment, there may be some error in the adjustment.

Use the procedure described on the proceeding page whenever you need more precise white balance.

- Do not block the white balance sensor when using the ATW feature. ATW will not work if you do.

# Adjusting Iris, Gain, and Light Intensity

Adjust the aperture, gain and ND FILTER to suit the scene or lighting you are shooting.

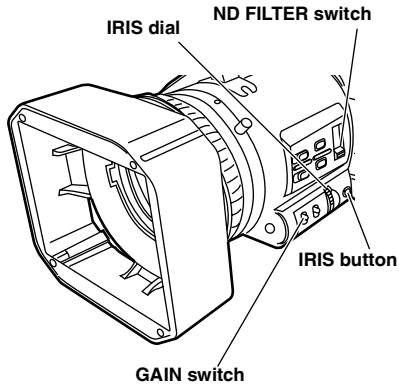

## Adjusting the gain

When the display is dark, increase the gain to brighten the display.

- 1 If the camera is in auto mode, press the AUTO button to switch over to the manual mode (**[A]** goes out).
- 2 Switch the gain with the GAIN switch.
  - L:**  
Set here under normal conditions. (0 dB)
  - M:**  
Increase the gain of the image amplifier. (The default value is 6 dB.)
  - H:**  
Increase the gain of the image amplifier. (The default value is 12 dB.)

## Iris adjustments

- 1 If the camera is in auto mode, press the AUTO button to switch to manual focusing (**[A]** goes out).
- 2 Press the IRIS button to switch how to adjust the aperture of lens.
  - AUTO IRIS:**  
Adjust the iris automatically.
  - MANUAL IRIS:**  
Adjust the iris manually.
- 3 Turn the IRIS dial to adjust the aperture of lens when in the manual iris mode.
  - Even if Auto IRIS is used, you can correct the aperture with this dial.

Set the direction of the IRIS DIAL and aperture control in the setup menus, SW MODE screen, IRIS DIAL (Page 70).

This unit's iris F number when it is open is F1.6 at full WIDE and F2.8 at full TELEPHOTO. The iris display in the viewfinder or on the LCD when the iris is open is OPEN at full WIDE and F2.8 or OPEN at full telephoto.

## Light intensity adjustments

Change the gain values of M and H in the setup menus, SW MODE screen, MID GAIN and HIGH GAIN (Page 70).

Use the ND FILTER Switch to change the ND Filter used (filter to change light intensity).

- OFF:**  
ND filter is not used.
- 1/8:**  
Cuts light intensity by up to about 1/8.
- 1/64:**  
Cuts light intensity by up to about 1/64.

# Switching Audio Input

You can record audio through two channels when shooting (see the table below). You can switch the source for each channel between the built-in microphone, another microphone, or audio equipment connected to the camera.

Built-in microphone L	CH1
Built-in microphone R	CH2
INPUT 1 (XLR)	CH1
INPUT 2 (XLR)	CH2

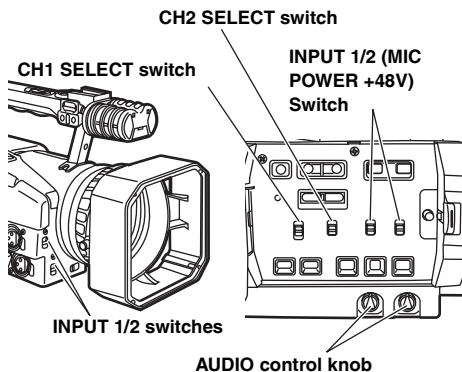

## Using the built-in microphone

- 1 Switch the CH1 SELECT switch to INT (L).
  - Audio from the built-in microphone Lch is recorded to audio channel 1.
- 2 Switch the CH2 SELECT switch to INT (R).
  - Audio from the built-in microphone Rch is recorded to audio channel 2.

## Using another microphone and audio equipment

- 1 Connect an external microphone or audio equipment to the INPUT 1/2 (XLR 3-pin) terminal. (Page 58)
- 2 Use the INPUT 1/2 switch to switch the audio input.

**LINE: (audio equipment is connected)**  
Input level is 0 dBu.

**MIC: (another microphone is connected)**  
Input level is -50 dBu.

You can change the input level to -60 dBu in the setup menus, RECORDING SETUP screen MIC GAIN 1 and MIC GAIN 2 (Page 73). Be aware that sensitivity will be higher if you choose -60 dBu so you will record more noise.

- 3 When using the phantom microphone, set the INPUT 1/2 (MIC POWER +48V) switch to ON.

**ON: (When using the phantom microphone)**  
48V power supply to INPUT 1/2 terminal.

**OFF: (When a phantom microphone is not connected)**  
No power supply for INPUT 1/2 terminal.

  - The battery will discharge faster if you use a phantom microphone.
  - Set to OFF if you connect equipment not compatible with +48V. You can damage such equipment if you leave the setting at ON.

- 4 Use the CH1 SELECT switch to select the input signal to be recorded to audio channel 1.

**INT (L):** Audio from the built-in microphone Lch is recorded to audio channel 1.

**INPUT 1:** Audio from a device connected to INPUT 1 terminal is recorded to channel 1.

**INPUT 2:** Audio from a device connected to INPUT 2 terminal is recorded to channel 1.

- 5 Use the CH2 SELECT switch to select the input signal to be recorded to audio channel 2.

**INT (R):**  
Audio from the built-in microphone Rch is recorded to audio channel 2.

**INPUT 2:**  
Audio from a device connected to INPUT 2 terminal is recorded to channel 2.

- When inputting the microphone signal to channels 1 and 2, connect the microphone to INPUT 2 and switch both CH1 SELECT and CH2 SELECT to INPUT 2.

## Adjusting the recording level

Use the AUDIO control knob to adjust the recording level of the built-in microphone or of audio signals input through the INPUT 1/2 (XLR 3-pin) terminal. To adjust the volume of monitored sound. (Page 35). Leave it in the center position under normal conditions.

Adjust the record level of audio signal using this knob, regardless of the settings of MIC ALC items in the RECORDING SETUP screen of setting menu. (Page 73)

- The audio signals input into AUDIO IN/OUT CH1/CH2 (pin jack) terminals can not be adjusted.

# Using scene files

The settings according to the variety of shooting circumstances are stored in each position of scene file dial.

When shooting, you can retrieve the necessary file instantly using scene file dial.

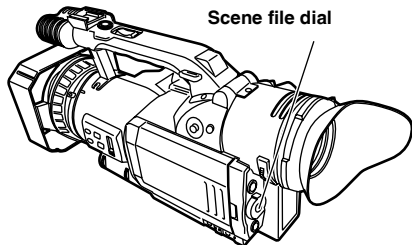

- Progressive mode will not be changed even if you change the scene file while recording. If you want to change the progressive mode, please set the camera-recorder to recording standby state.

When the camera-recorder is shipped from the factory, the following files are stored.

## F1: SCENE

File suitable for normal shooting.

## F2: SCENE FLOU.

File suitable for shooting under fluorescent lights, ie. indoors.

## F3: SCENE SPARK

File suitable for making subjects sharper, such as at weddings.

## F4: SCENE B-STR

File for broadening the contrast of dark parts, such as when shooting sunsets.

## F5: SCENE 25P

File suitable for shooting in progressive 25P mode.

(The V DETAIL FREQ item on the SCENE FILE setting menu screen is set to THICK.)

## F6: SCENE CINE

File suitable for shooting in progressive 25P mode.

(The V DETAIL FREQ item on the SCENE FILE setting menu screen is set to THIN.)

## Changing scene file settings

The setting value of the scene file can be changed. Also you can save the changed scene file to each position of the scene file dial.

**Example: Change the name of the scene file.**

- 1 Set the POWER switch to ON.
- 2 Turn the scene file dial, then select the scene file to be changed.
- 3 In the setup menus, select the SCENE FILE screen.
  - For menu operation (Page 65)
  - You can also use the menu buttons on the remote control. (Page 18)
- 4 Move the OPERATION lever ▼ to select NAME EDIT.

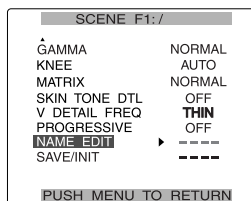

- 5 Press the OPERATION lever (II) (or move it ►►) then move it ▼ to select YES.

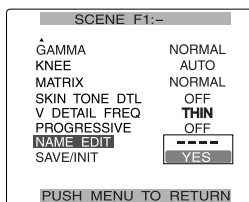

## Using the scene files (continued)

- 6** The screen below is displayed, so set the file name of six letters using OPERATION lever. Set the same as user information (Page 26).
- Characters that can be set  
Space A to Z, 0 to 9, ; ; < = > ? @ [ \ ] ^ \_ / .

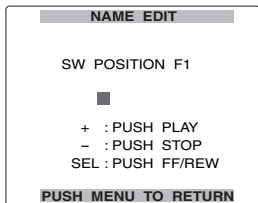

- 7** After you finish setting the filename, press the MENU button.

- 8** Move the OPERATION lever ▼ to select SAVE/INIT.

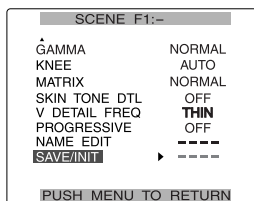

- 9** Press the OPERATION lever (II) (or move it ►►) then move it ▼ to select YES.

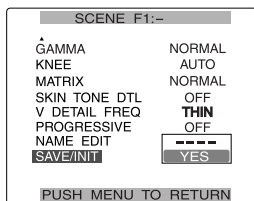

- 10** The following screen appears, so press the OPERATION lever (II).

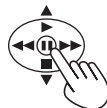
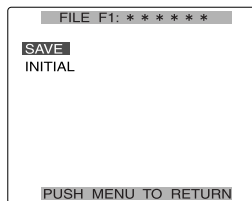

- 11** The following screen appears, so move the OPERATION lever ▲ to select YES, then press the OPERATION lever (II).

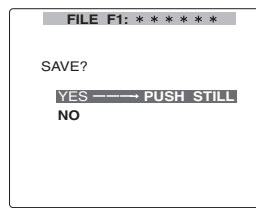

- 12** Ten beeps sound in succession, the message below appears, and the changes to the scene file are complete.



- 13** Press MENU three times to exit the menus.

- The original scene file settings will be restored when the menu mode is released, the operation is switched to the VCR mode or when the power is turned off if SAVE has not been selected.
- To return the scene file settings to the factory settings, select INITIAL in step 10, then do steps 11 to 13.

# Transferring scene files

You can transfer the following scene file data to another DVX 100B connected with a DV (IEEE1394) cable.

**SCENE:** A file selected with the scene dial (F1-F6)

**SCENE ALL:** All scene files

**USER:** All user files

• You can only transfer between DVX100B models.

- 1 Connect camera 1 to camera 2 with a DV (IEEE1394) cable.
  - For connection (Page 53)
  - When choosing SCENE (step 7), set the scene dial on camera 1 to the item you want to send, and set the scene dial on camera 2 to the item you want to send it to. (For example you can send F1 to F2.)

- 2 Put camera 1 in CAMERA mode and turn off the DV CONTROL function under the OTHER FUNCTIONS screen in the setup menus.
  - For menu operation (Page 65)
  - You can also use the menu buttons on the remote control. (Page 18)

- 3 Put camera 2 in VCR mode, stop or eject the cassette tape, and then input a 1394 video signal.

- 4 Put camera 2 in the file receiving mode. In the setup menus, OTHER FUNCTIONS screen, set FILE RECEIVE to YES.

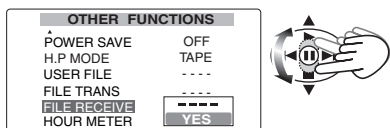

- 5 The following screen appears, so move the OPERATION lever ▲ to select YES and press the OPERATION lever (II). RECEIVE MODE blinks on the screen.

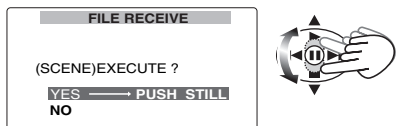

- 6 Put camera 1 in the file transfer mode. In the setup menus, OTHER FUNCTIONS screen, set FILE TRANS to YES.

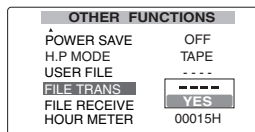

- 7 The following screen appears, so move the OPERATION lever ▼, select the data for transfer, and press the OPERATION lever (II).

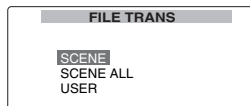

- 8 The following screen appears, so move the OPERATION lever ▲ to select YES and press the OPERATION lever (II). File transfer starts.

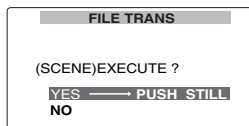

FILE TRANS appears on the screen of camera 1 when the transfer is complete. FILE RECEIVE OK → PLEASE POWER OFF appears on the screen of camera 2. Be sure to turn off camera 2.

- When turning off camera 2, be sure to use the power switch. Under no circumstances cut the power by disconnecting the battery or AC adapter.

When a file is transferring, do not disconnect the DV (IEEE1394) cable or turn off the power of camera 2. It will not transfer correctly.







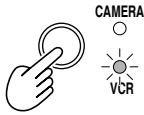

- FILE TRANS NG appears on the screen of camera 1 if a problem occurs during the transfer. Check the connections and settings on both cameras.
- Do not change the scene dial when RECEIVE MODE is displayed on camera 2. The transfer will stop if you switch the PROGRESSIVE settings from 50i to 25P (FILE RECEIVE NG appears on camera 2).

# Playback

- 1 Set the POWER switch to ON.
- 2 Press the CAMERA/VCR button to switch to VCR mode.
- 3 Use the OPERATION lever and the supplied remote control to perform the common playback operations (see below).

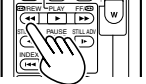
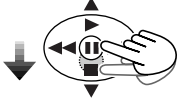

## Basic operations

Operation by the OPERATION lever	Remote control
 <p>While the tape is in the stop mode, turn the lever in the direction ► to play back. During playback, turn the lever in the direction ► to use the variable speed search mode (Page 50), then playback with the speed of 1x will start. (The audio will not be played back.) Variable speed search will not start if you are using the remote control.</p>	
 <p>While the tape is in the stop mode, turn the lever in the direction ►► to fast forward the tape. During play, move the lever ►► to play the tape at 10x speed.</p>	
 <p>While the tape is in the stop mode, turn the lever in the direction ◀◀ to rewind the tape. During play, move the lever ◀◀ to rewind the tape at 10x speed.</p>	
 <p>Turn the lever in the direction ■ to stop the tape.</p>	
 <p>While the tape is playing back, press this lever to set the camera-recorder to the playback pause mode.</p>	

### Tape protection mode

If you pause the camera-recorder for 5 minutes during play or shooting, it automatically stops to protect the tape. The mode activates faster if it is cold.



## Adjusting the volume

AUDIO MON/VAR button

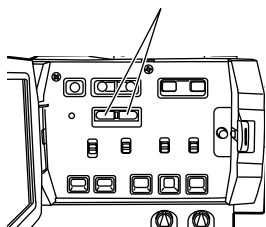

**1** With the AUDIO MON/VAR button, adjust the volume of the sound that is output from the internal speaker and PHONES jack.

On the remote control, press the ZOOM/VOL button.

- This button works differently during variable speed search and pause.  
(Pages 47 and 50)

## Checking the date and time

Press the DATE/TIME button on the remote control to show the date and time of shooting on the screen. The display changes as follows each time you press the button.

Time  
↓  
Date  
↓  
Time and Date  
↓  
Original screen

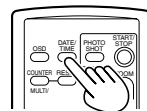

## Viewing images on a television

Connect the camera to a television with an AV cable or S-video cord (not included) to view the images on the television.

**1** Connect the camera-recorder to the TV set (Page 54).

**2** Start playback.

- To show the information that appears on the viewfinder and LCD, press the OSD button on the remote control.

Press the OSD button again to clear the display.



# Variable-speed playback

## Slow playback

- 1 During play, press one of the STILL ADV (◀◀ or ▶▶) buttons on the remote control unit.

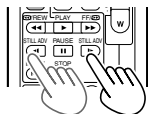

- Press the PLAY button (▶) to return to normal playback.

## Frame-by-frame playback

- 1 During play, press the OPERATION lever (||) to pause play.

- 2 Press the AUDIO MON/VAR button to play frame-by-frame.

On the remote control unit, press the STILL ADV (◀◀ or ▶▶) button.

- Press and hold the button to perform frame-by-frame play continuously.

### AUDIO MON/VAR button

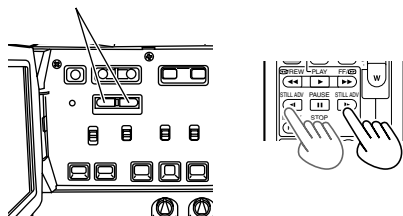

Camera or remote control

- Move the OPERATION ▶ to return to normal playback.

## Fast-forward and rewind

During playback, move the OPERATION lever ▶▶ to play 10 times normal speed.

During playback, move the OPERATION lever ◀◀ to rewind at 10 times normal speed.

Fast-forward/fast-rewind continue as long as you hold the lever in place.

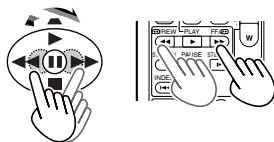

Camera or remote control

- Move the OPERATION lever ▶ to return to normal playback.

## Index search

This function searches for the index signals (Page 34) recorded on the tape.

Index searches can be performed using the supplied wireless remote control unit.

- 1 During play, press the INDEX buttons ▶▶| or ◀◀.

- The tape is cued at the next scene after showing [S1] on the screen.
- Each time you press the INDEX button thereafter, [S2] and then [S3] are displayed, and the tape is cued up to the second and subsequent scenes. When the tape is cued up, playback starts from that section. (Up to nine scenes before or ahead on the tape can be specified for cue-up.)

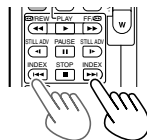

- Press the STOP button (■) to stop the search.
- The function may not work properly if the interval between one index and the next is less than one minute.

## Variable speed search

This function enables you to change the playback speed and search for specific scenes.

- 1 During playback, move the OPERATION lever . On the remote control, press the VAR. SEARCH button.

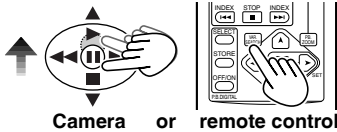

[1x] appears on the screen and the tape is played back at the normal speed. No sound is heard at this time.

- 2 Press the AUDIO MON/VAR button to change the playback speed. On the remote control, press the [▼] or [▲] SET button.
  - Each time you press the button, the speed changes as follows; 1/5 (1/3 in LP mode) speed, 1x speed, 2x speed, 5x speed, 10x speed, 20x speed.
  - Press the “+” button to increase the speed and the “-” button to decrease the speed.

### AUDIO MON/VAR button

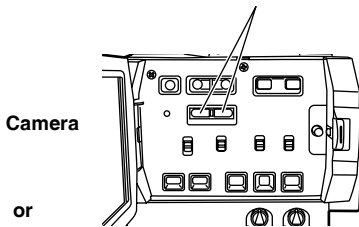

### remote control

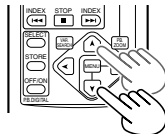

- Move the OPERATION  to return to normal playback.

## End search

You can find unrecorded parts or the end of the last scene shot.

- 1 In the setup menus, OTHER FUNCTIONS screen, END SEARCH, set the search method. (Page 76)
  - BLANK:** Find unrecorded parts.
  - REC END:** Find the end of the last scene shot.

- 2 Press the EVF DTL/END SEARCH button in the VCR mode.
  - The unrecorded parts are found, and a still picture that is about a second ahead is displayed.

When in the camera mode, press and hold the EVF DTL/END SEARCH button for at least a second.

  - A blank portion of the tape is found, and a still picture that is about a second ahead is displayed while the camera is in recording standby mode.

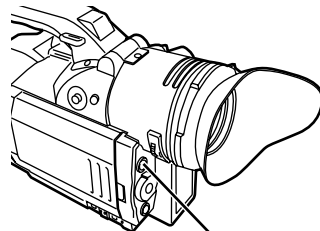

- If you change the tapes, the camera will not be able to find the end of the last scene shot even if you have set REC END.
- If the tape is blank, searching stops at the end of the tape.
- This function may not work properly if there are blank parts near the beginning of the tape or part way through the tape.
- Before recording, check the still picture first.

EVF DTL/END SEARCH works differently when simply pressed in camera mode. (Page 23)

# Using the Counter

## Counter display

You can display a counter that indicates how much time has elapsed during shooting or playback.

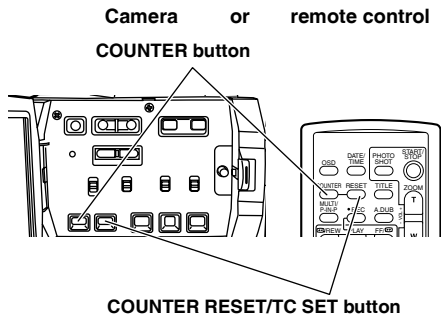

- 1 Press the COUNTER button.  
Each time you press the button, the display changes as follows.

**0 : 00. 00:**

Counter value

**M 0 : 00. 00:**

Counter value in memory stop mode

**TC XX : XX : XX : XX:**

Time code value

**UB XX XX XX XX:**

User information

**FR XXX -:**

Frame rate (50i/25P) and frame sequence in progressive mode shooting.

**No display:**

Data is not displayed.

### Resetting the counter

Press the COUNTER RESET button while the counter is displayed.

## Memory stop mode

After shooting or playback, the tape can first be returned to near the pre-programmed position, and then stopped automatically.

- 1 Press the COUNTER button to display the counter in memory stop mode.
- 2 At the desired position on the tape, press the COUNTER RESET button to reset the counter.
- 3 Proceed with playback or shooting.
- 4 Press the CAMERA/VCR button to set the VCR mode.

- 5 When rewind or fast-forward the tape, it stops automatically near where you reset the counter.

During dubbing, reset the counter value at the OUT point to stop dubbing with memory stop mode. (Page 56)

## 1394TC preset mode

You can synchronize the time codes of your cameras when using more than one for a shoot. The camera used for synchronization is the MASTER and the camera being synchronized is the SLAVE.

- 1 Connect a second camera with a DV (IEEE1394) cable and turn both cameras off.
  - For connection (Page 53)
- 2 Put the MASTER camera in CAMERA mode and output a video signal from the DV (IEEE1394) terminal.

Do the remaining steps on the SLAVE camera.

- 3 Set the SLAVE camera to VCR mode and in the setup menus, RECORDING SETUP screen, set FIRST REC TC to PRESET mode so the counter shows the TC.  
Stop or eject the cassette tape.
  - You cannot do this if you have selected REGEN.
- 4 In the setup menus, RECORDING SETUP screen, set DV IN PRESET to ON. (Page 74)
  - DVTC appears on the screen.
- 5 Stop or eject the cassette tape.
- 6 Press the COUNTER RESET/TC SET button. The TCG value is preset with the TC value from the input 1394 signal.
- 7 Reset the SLAVE camera to CAMERA mode.

# Connecting external units

## Headphones

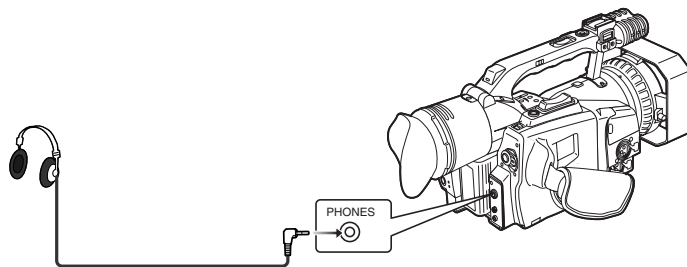

## External microphone

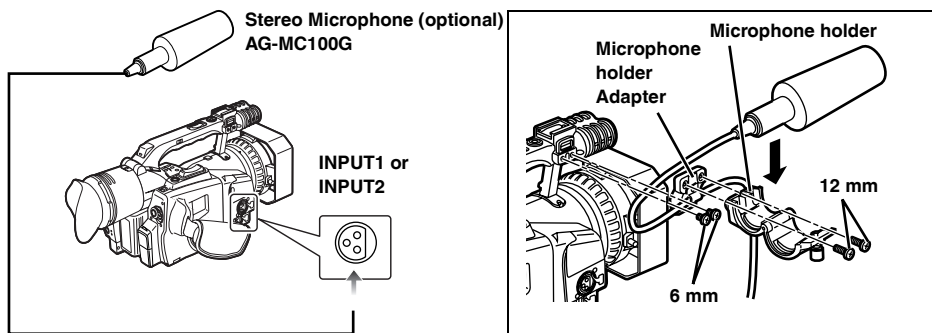

- When attaching an external microphone to the microphone shoe, use the supplied microphone holder and microphone holder adapter.

## Connecting external units (continued)

### Digital video equipment

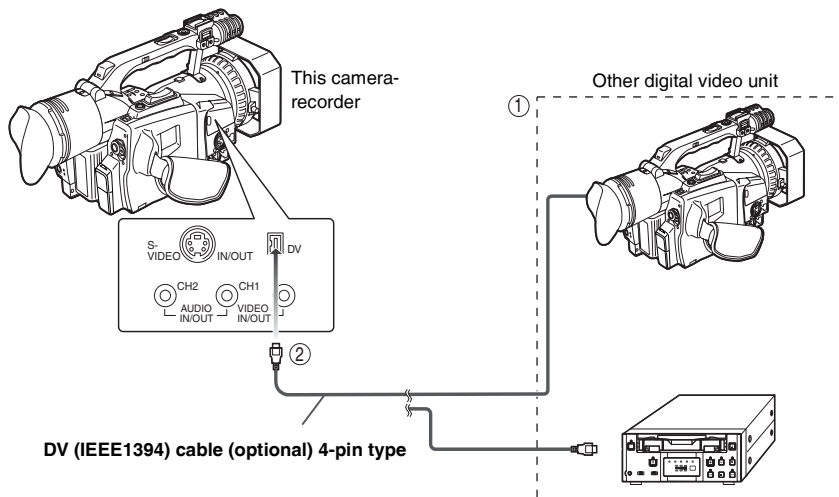

#### ■ You can connect a digital video unit equipped with a DV connector and digitally transfer video and audio signals as well as time code.

- Before proceeding to connect or disconnect DV (IEEE1394) cable, be absolutely sure to turn off the power of the units.
- Before proceeding to connect the unit which uses a 6-pin type DV connector, carefully check the shape of the DV (IEEE1394) cable and the connectors on the DV cable. Connecting a connector upside down may damage the parts inside the unit and cause malfunctioning. Furthermore, connect the DV (IEEE1394) cable to the unit which uses a 6-pin type DV connector first. ((1)→(2))
- When recording signals from an external unit, first check that video signals are supplied.
- While signals from an external unit are being recorded, do not stop output on the external unit side or disconnect any of cables. This may lead to a failure to recognize the signals when you do recording again.
- Do not apply force when connecting DV (IEEE1394) cable to DV connector as this may damage the connector.

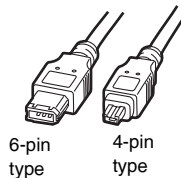

## Television

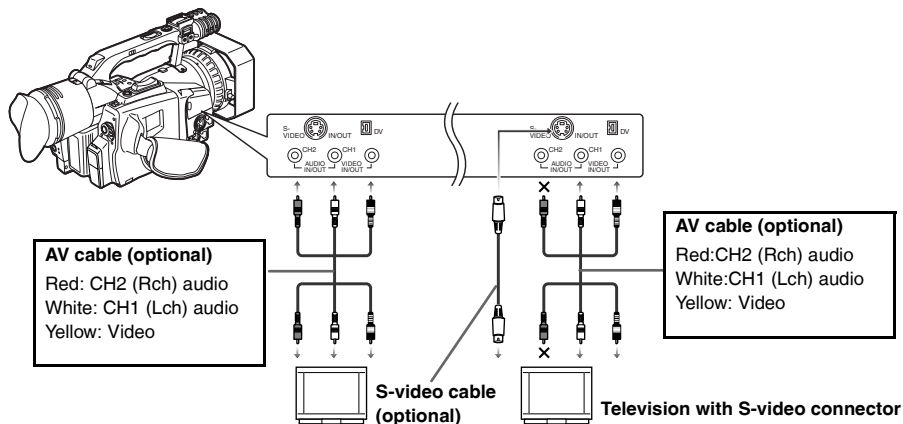

## Video deck

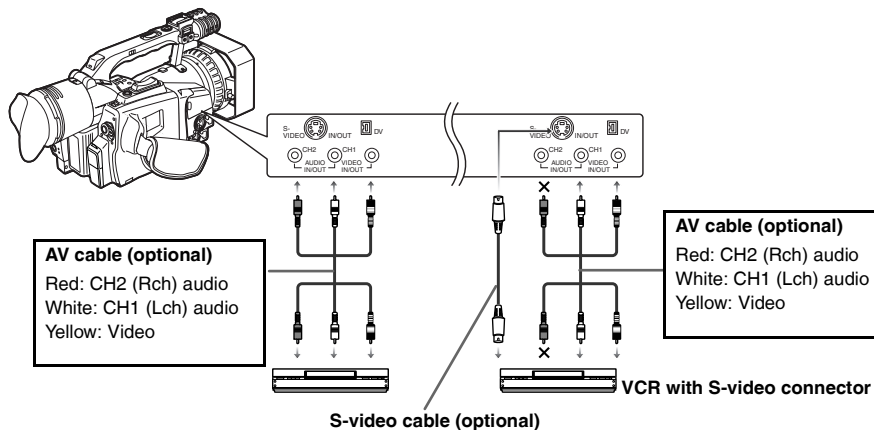

■ When connecting the external unit in order to input video and audio signals from the external unit, the unit shall be connected to the output connectors on the external unit.

■ When connecting an external unit in order to output video and audio signal to the external unit, connect it to the input connectors on the external unit.

- When video signals are input to both the S-VIDEO IN/OUT connector and VIDEO IN/OUT jack, signals of the S-VIDEO IN/OUT connector take precedence.
- Except when performing audio dubbing on existing recordings, audio signals cannot be recorded unless video signals are input to the S-VIDEO IN/OUT connector and/or VIDEO IN/OUT jack.
- A widescreen detection signal is not output from the unit's S-VIDEO IN/OUT connector. Also, even if a widescreen detection signal is input to the unit's S-VIDEO IN/OUT connector, it will not be detected.

# Audio dubbing

Background music or narration can be added to the images you have recorded on the tape.

- 1 Set the POWER switch to ON.
- 2 In the setup menus, select an audio recording system in RECORDING SETUP screen, AUDIO REC.
  - For menu operation (Page 65)
  - You can also use the menu buttons on the remote control. (Page 18)

## 32K(12bit):

The sound is recorded using the 12-bit/32kHz (4-channel) system.

Use this mode when you want keep the sound that recorded while you were shooting even after audio dubbing has been performed.

## 48K(16bit):

The sound is recorded using the 16-bit/48kHz (high-quality stereo) system.

When audio dubbing is performed, the sound that was recorded while you are shooting will be erased.

- 3 Start shooting.
- 4 Press the CAMERA/VCR button and switch to the VCR mode.

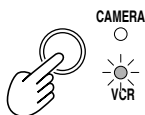

- 5 In the setup menus, select an audio recording system in the AV IN/OUT SETUP screen, A. DUB INPUT.
  - For menu operation (Page 65)
  - You can also use the menu buttons on the remote control. (Page 18)

## MIC:

The sound of the built-in microphone or the external unit connected to INPUT 1/2 connector is recorded. (Select by CH1 SELECT switch and CH2 SELECT switch.)

## A\_IN:

The sound of audio component connected to AUDIO IN/OUT connector (pin jack) is recorded.

- 6 Find the scene you want to add and set the unit to the still mode.
- 7 Press the DISPLAY/AUDIO DUB button to establish the status ready for audio dubbing. Press the A. DUB button on the remote control unit.
  - "A.DUB" appears.
- 8 Press the OPERATION lever [ ] and start input of sound to be dubbed.
- 9 Press the OPERATION lever [ ] to pause. To continue dubbing, repeat steps 7 and 8.
  - When finished, move the OPERATION lever [ ].

DISPLAY/AUDIO DUB button

OPERATION lever

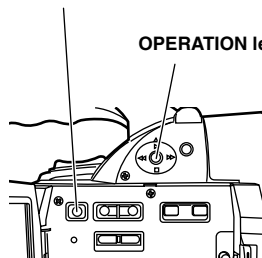

**In the LP mode, you cannot dub after recording as the track on the tape is thinner than the head.**



### Input channels and the tracks recorded

Input	Shooting mode	Audio dubbing mode
Built-in microphone L channel	CH1	CH3
Built-in microphone R channel	CH2	CH4
INPUT 1 (XLR)	CH1	CH3
INPUT 2 (XLR)	CH2 (CH1)	CH4 (CH3)
AUDIO IN/OUT CH1 (Pin jack)	-	CH3
AUDIO IN/OUT CH2 (Pin jack)	-	CH4

The sound track to be recorded when shooting can be changed by CH1 SELECT switch and CH2 SELECT switch.

The sound track to be recorded when dubbing can be changed at A. DUB INPUT ITEM on the AV IN/OUT SETUP screen. (Page 74)

### Adjusting the audio input level

Use the AUDIO control to adjust the recording level of audio signals input from the built-in microphone or INPUT 1/2 terminal.

You cannot adjust the audio signals input into the AUDIO IN/OUT CH1/CH2 terminals.

### Listening to sound that has been dubbed

Switch between the sound that has been dubbed and the sound heard during shooting in the setup menus, PLAYBACK FUNCTIONS screen, 32K (12bit) AUDIO. (Page 72)

#### ST1:

The sound recorded during shooting is played back.

#### ST2:

The sound that has been dubbed is played back.

#### MIX:

Both the sound recorded during shooting and that you have dubbed are played back.

### Performing audio dubbing as you listen

You can monitor the sound by setting "ST2".

If you use headphones when performing audio dubbing on a recording using microphone input, you can listen to the sound being dubbed.

When you perform audio dubbing using line input (from the audio component connected to the AUDIO IN/OUT jack), you can listen to the sound being dubbed through the speakers.

### Using the memory stop mode to edit dubbed sound

- (1) First reset the counter memory display in the memory stop mode at the position where the audio dubbing is to end. (Page 56)
- (2) Rewind the tape to the position where the audio dubbing is to start, and start the dubbing.
- (3) The tape then stops automatically at the position where the counter memory display was reset.

# Dubbing

## Analog input

Use the dubbing function to copy the contents of S-VHS (or VHS) cassettes onto DV cassettes or record the television.

- 1 Connect this unit to a video deck or a television. (Page 54)
- 2 Press the CAMERA/VCR button and switch to the VCR mode.



- 3 Turn on the power of the external unit, and play back the tape.
- 4 To start recording video signals from the connected devices, press two VCR REC buttons at a time. On the remote control, while pressing the REC button, press the PLAY button.

### VCR REC buttons

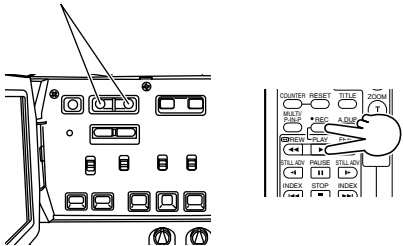

Camera or remote control

- If you press these two buttons during pause, the unit will go to shooting standby mode. Each time the [ ] button of the OPERATION lever is pressed, the unit switches between shooting and the shooting standby mode.
- 5 Move the OPERATION lever [ ] to stop recording.
  - 6 Stop playback on the external unit.

You cannot adjust the audio level.

## Analog/digital (AD) conversion

You can use this unit to convert analog to digital signals. In the setup menus, AV IN/OUT SETUP screen, set DV OUT to "ON". (Page 74)

This enables you to output digital images, which were input as analog signals from an external unit, through this unit's DV connector to another digital video unit.

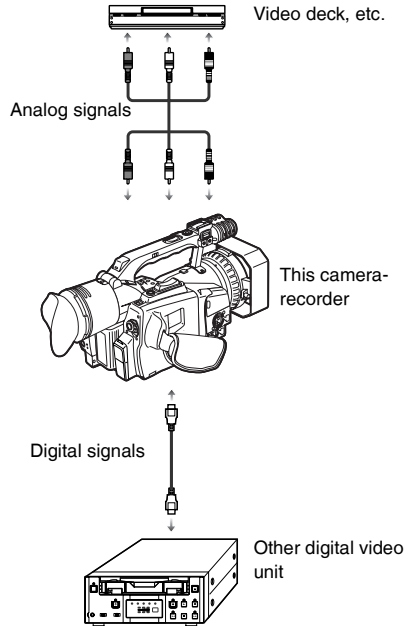

- Normally, set DV OUT to "OFF". Images may be disrupted if you set it to "ON".
- You can also use an S-video cable.
- Connecting external units (Page 52)

## Analog output

You can record images you have shot on this unit to an S-VHS (VHS) tape in a video deck.

- 1** Connect this unit to a video deck.  
(Page 54)
- 2** Press the CAMERA/VCR button and switch to the VCR mode.



- 3** Move the OPERATION lever [▶] to start play on this unit.
- 4** Start recording on the video deck.
- 5** Stop recording on the video deck.
- 6** Move the OPERATION lever [■] to stop play.



# Screen displays

## Displays in CAMERA and VCR modes

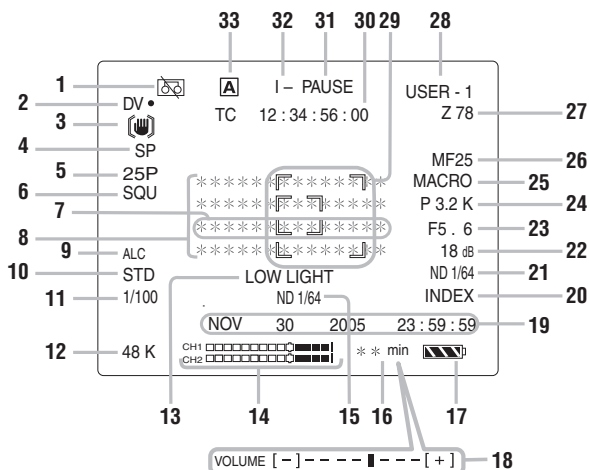

### 1 Warnings

**REMOTE:** Blinks when the wrong equipment setting is selected on the remote control unit.

- : Lights when condensation has formed inside the camera-recorder.
- : Blinks when cylinder heads are dirty.
- : Blinks when a tape has not been inserted or the write-protect switch is engaged.
- END:** Blinks when the tape has reach the end.
- : Lights if a problem has occurred while taking a self-portrait in the mirror mode.
- : Lights when the internal battery for the calendar has run out.

### 2 Backup unit displays

The status of the backup unit connected to the DV connector is displayed here.

Nothing is displayed if in the setup menus, OTHER FUNCTIONS screen, DV CONTROL, you have selected "OFF".

**DV●:** Recording

**DV■:** Recording standby

: The backup unit cannot be controlled.

**DV:** The backup unit is not connected.

**DV- |:** The backup unit is connected but is in a mode other than recording or recording standby.

### 3 Optical Image Stabilizer ( ) display

Appears when the Optical Image Stabilizer is ON.

### 4 Recording time mode (SP/LP)

SP: Standard mode  
LP: Extended mode

### 5 Progressive mode

Frame rate information during shooting in the progressive mode is displayed here.

### 6 Squeeze information

Appears when in the setup menus, CAMERA SETUP screen, ASPECT CONV, you have selected "SQUEEZE" (Page 70) or when playing back images recorded in the squeeze mode.

### 7 Setting selection

The selected setting is displayed here when a switch is selected or a button is pressed to select a setting.

### 8 Information display

Following information is displayed depending on the situation.

- Performance of the auto white balance or the auto black balance
- Warning (Page 63)
- The functions allocated to the USER buttons are displayed while you hold down the MODE CHK button.

## Screen displays (continued)

### 9 Mic level auto control

Appears when in the setup menus, RECORDING SETUP screen, MIC ALC, you have selected "ON".

### 10 Auto iris control displays

STD : Standard auto-iris control  
 SPOT : Auto iris control for spotlight  
 BACK : Auto iris control for backlight compensation

### 11 Shutter speed

The shutter speed is normally displayed here. "SLOW" appears when using the slow shutter speed.

When the ZEBRA button is pressed to display the markers (Page 32), the brightness level around the center of the screen is indicated as 0% to 99%. "99%↑" appears if the percentage is over 99.

### 12 Audio sampling frequency

### 13 AWB error

#### LOWLIGHT

Appears when the brightness level adjusted by the auto white balance is too low.

### 14 Audio level meter



### 15 Recommended ND filter

The recommended ND filter under the current shooting conditions is displayed here.

### 16 Remaining tape

This is not displayed while being calculated. It is also not displayed during intermittent recording or slow playback.

### 17 Remaining battery charge

As the remaining battery charge drops, the display changes as follows: ➔ ➔ ➔

➔ ➔

When the battery has completely discharged,

( ) blinks.

(When the AC adapter is being used, a display other than may appear: this is not a sign of malfunctioning.)

### 18 Monitor volume level meter

Press the AUDIO MON/VAR button to display the level meter showing the volume level of the sound that is output from the internal speaker and PHONES jack.

### 19 Calendar

Month:  
 JAN (January), FEB (February), MAR (March), APR (April), MAY (May), JUN (June), JUL (July), AUG (August), SEP (September), OCT (October), NOV (November), DEC (December)

Day of the month  
 Year: 2002 - 2089  
 Hours  
 Minutes  
 Seconds

mmm dd yyyy hh:mm:ss

### 20 INDEX record display

When the USER button allocated the Index function in advance is pressed during the recording, it will light when recording the index signal.

When you press the USER button before recording, it will light. (In the condition of waiting the index signal record)

### 21 ND filter display

ND filter selected is displayed.

When [ND--] is displayed, the ND filter may be out of alignment. (OFF, the position except 1/8, 1/64) Check the position of the ND filter switch.

### 22 Gain display

Displays the gain value of the image amplifier configured. When AUTO is selected, ACG is displayed.

### 23 IRIS display

Displays F value.

### 24 AWB information display

Displays the information of white balance.

ATW: When ATW is selected.  
 P3.2K/5.6K: When preset is selected.  
 Ach/Bch: When Ach/Bch is selected.  
 LOCK: When ATW LOCK is selected.

### 25 Macro control display

### 26 Focus control display

Displays the focus control information with 99-00. 95 (Focal distance: infinity)

:  
 50 (Focal distance: approx. 1 m)

:  
 36 and below (Macro)

:  
 00 (Focal distance: approx. 2 cm)

- Depending on the zoom position, the macro range may not be enabled.

Also, depending on the zoom position, the lower limit value of macro range may be different.

**AF:** Auto focus display

**MF:** Manual focus display

**27 Zoom position display**

The zoom position is displayed with Z00 (maximum wide-angle) - Z99 (maximum zoom).

**28 Scene file name display****29 Displays marker**

During shooting, pressing the ZEBRA button once or twice will display the marker.

**30 Counter display**

The following data is selected in turn each time the COUNTER button is pressed.

**COUNTER:**

Counter value

**M COUNTER:**

Counter value in memory stop mode

**TC:**

Time code value

When the time code value could not be read correctly from the tape, [TC\*] is displayed.

When it acts in drop frame mode, the colon between seconds and frames become “.”.

**UB:**

User information

When user information could not be read correctly from the tape, [UB\*] is displayed.

**FR:**

Frame rate information for recording

FR 50I : Standard (50i interlace) mode  
(50 fields/sec.)

FR 25P : 25P progressive mode (25  
frames/sec.)

**31 Operational state display**

REC	: Recording
●	: Recording (during self-portrait shooting)
PAUSE	: Recording pause
●II	: Recording standby (during self-portrait recording)
□□	: Play pause
STNDBY	: Standby (the cylinder-head is stopped)
A. DUB □□	: Standby for dubbing record
A. DUB ▷	: Dubbing record
▷	: Play
▷▷ (◁◁)	: Fast-forward/Fast-forward play (Rewind/Rewind play)
□▷ (◁□)	: Slow play (Reverse slow play)
CHK	: Rec check
▷▷ (◁◁)	: Cue (reverse cue)
□▷ (◁□)	: Frame-by-frame (Reverse Frame-by-frame)
BLANK	: Blank search
REC END	: End of recording search
<b>x ▷ /x ▷▷ (x ◁ /x ◁◁):</b>	<b>Variable-speed search (Reverse variable-speed search)</b>

**32 ONE-SHOT recording display**

Appears when “ON” has been selected for ONE-SHOT REC in the RECORDING SETUP screen of the setup menus.

**33 AUTO button action display**

When the AUTO button is pressed, this display appears if the function configured in the AUTO SW screen of the Setup menu is active.

## In VCR mode only

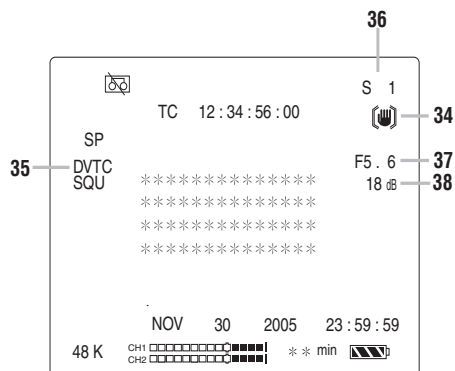

- 34 Optical Image Stabilizer (OIS) (Hand icon) display**  
When the CAMERA DATA item of the DISPLAY SETUP screen of the Setup menu is set to ON, and you are using the Optical Image Stabilizer, (Hand icon) is displayed even if playing back the tape as camera data.
- 35 DVTC display**  
Appears when you have set DV IN PRESET to ON in the setup menus, RECORDING SETUP screen.  
It does not appear when you have set REGEN for FIRST REC TC.
- 36 Search number display**  
Displays the index numbers performed the index search. (S1 to S9)
- 37 IRIS display**  
When the CAMERA DATA item of the DISPLAY SETUP screen of the Setup menu is set to ON, the F value of recording is displayed even if playing back the tape as camera data.
- 38 Gain display**  
When the CAMERA DATA item of the DISPLAY SETUP screen of the Setup menu is set to ON, the F value of recording is displayed even if playing back the tape as camera data.

## Warnings

If a problem occurs with this unit or tapes, the following messages are displayed in the middle of the screen.

### UNPLAYABLE TAPE (OTHER FORMAT)

Can not playback because of the different tape format.

### COPY INHIBITED

Can not record correctly because of the input signal copy-guarded.

### UNABLE TO A. DUB (LP RECORDED)

Can not perform dubbing because the tape was recorded with LP mode.

### INCOMPATIBLE TAPE

Can not use because the tape is not the standard for this unit (e.g. a tape for saving data).

### EXTERNAL

#### DV DISCONNECT

When the DV CONTROL item of the OTHER FUNCTIONS screen of the Setup menu is set to EXT and recording without connecting external units with DV terminal, this display appears.

#### AUTO OFF

When trouble occurs with tape running systems, AUTO OFF is displayed.

When AUTO OFF is displayed, the power supply of this device is automatically set to OFF.

#### CYLINDER LOCK

#### LOADING LOCK

#### UNLOADING LOCK

#### T REEL LOCK (Take up reel lock)

#### S REEL LOCK (Supply reel lock)

### WARNING

When trouble occurs with camera systems, WARNING is displayed.

#### FOCUS LOCK (Abnormal focus operation)

#### PSD NG (Abnormal vibration detected)

#### GYRO NG (Abnormal Optical Image Stabilizer control)

### FILE TRANS NG

Is displayed in the following cases:

- When the DV (IEEE 1394) cable is not connected while performing FILE TRANS.
- When the connected external device is unable to receive data while performing FILE TRANS.

### FILE RECEIVE NG

Is displayed in the following cases:

- When the DV (IEEE 1394) cable is not connected while performing FILE RECEIVE.
- When the connected external device is not set to FILE RECEIVE mode.



## Setting the DISPLAY items

Display the following items on the viewfinder and LCD monitor screen by pressing the MODE CHK button or by configuring OTHER DISPLAY of the DISPLAY SETUP screen of the setup menus (Page 75).

Displays	MODE CHK button	OTHER DISPLAY settings		
		ALL	PARTIAL	OFF
3 Optical Image Stabilizer display	✓	✓	✓	x
4 Displaying record time mode (SP/LP)	✓	✓	x (camera) ✓ (VCR)	x
5 Progressive display	✓	✓	x	x
6 Squeeze record display	✓	✓	✓	x
8 Displaying the function allocated to the USER button	✓	x	x	x
9 Microphone level auto-control display	✓	✓	x	x
10 Auto-IRIS control display	✓	✓	✓	x
11 Shutter speed display	✓	✓	✓	x
12 Audio-sampling frequency display	✓	✓	x (camera) ✓ (VCR)	x
14 Audio level meter display	✓	—	—	—
15 Recommended ND filter display	✓	✓	✓	x
16 Remaining tape display	✓	—	—	—
17 Remaining battery display	✓	—	—	—
19 Date and time display	✓	—	—	—
21 ND filter display	✓	✓	x	x
22 Gain display	✓	✓	x	x
23 IRIS display	✓	✓	✓	x
24 AWB information display	✓	✓	✓	x
26 Focus control display	✓	—	—	—
27 Zoom position display	✓	—	—	—
28 Scene file name display	✓	✓	x	x
30 Counter display	✓	—	—	—
33 AUTO button operation display	✓	✓	✓	x

- ✓: Displayed  
 x: Not displayed  
 —: Displayed depending on other settings

Press and hold the DISPLAY/AUDIO DUB button for about 3 seconds in the camera mode to clear all of the above from the screen.

Press and hold it again to restore the displays.

# Using the setup menus

Use the setup menus to change the settings to suit the scenes you are shooting or what you are recording. You can also use the menu buttons on the remote control. (Page 18)

## Using the setup menus

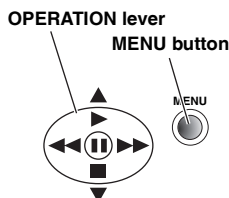

- 1 When not shooting or recording, press the MENU button. The camera enters the menu mode and the following is displayed on the screen.

### Camera mode

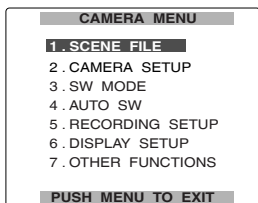

### VCR mode

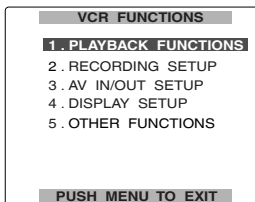

- 2 Move the OPERATION lever ▲ or ▼ to highlight the item you want to change.

- 3 Press the OPERATION lever (||) (or move it ►►) to display the items to display the items.

### Example:

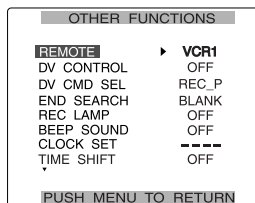

- 4 Move the OPERATION lever ▲ or ▼ to highlight the item you want to change.

### Example:

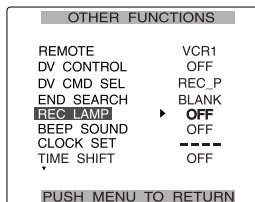

- 5 Press the OPERATION lever (II) (or move it ►►), then move it ▲ or ▼ to select the setting you want to change.

To change a setting, move [►], then move the OPERATION lever ▲ or ▼.

Example:

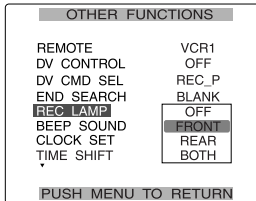

- 6 To change other settings, repeat steps 4 and 5.

When you have finished, press the MENU button to return to the function screen.

- 7 To change other settings, repeat steps 2 to 5. When the menu mode is finished, press the MENU button again and return to the normal screen.

## Initializing the menu settings

The setup menus are divided into user files and scene files. You can initialize these separately.

### To initialize the user file (all items except the scene files)

In the OTHER FUNCTIONS screen, USER FILE, select INITIAL. The settings for the current user file are returned to the factory settings. (Page 77)

### To initialize the scene files

From the 6 scene files, select the one you want to initialize with the scene dial. Then in the SCENE FILE screen, SAVE/INIT, select INITIAL. The settings for the selected scene file are returned to the factory settings. (Page 69)

There is no effect on the other scene files.

# Setup menu structure

## Camera mode menu

### CAMERA MENU

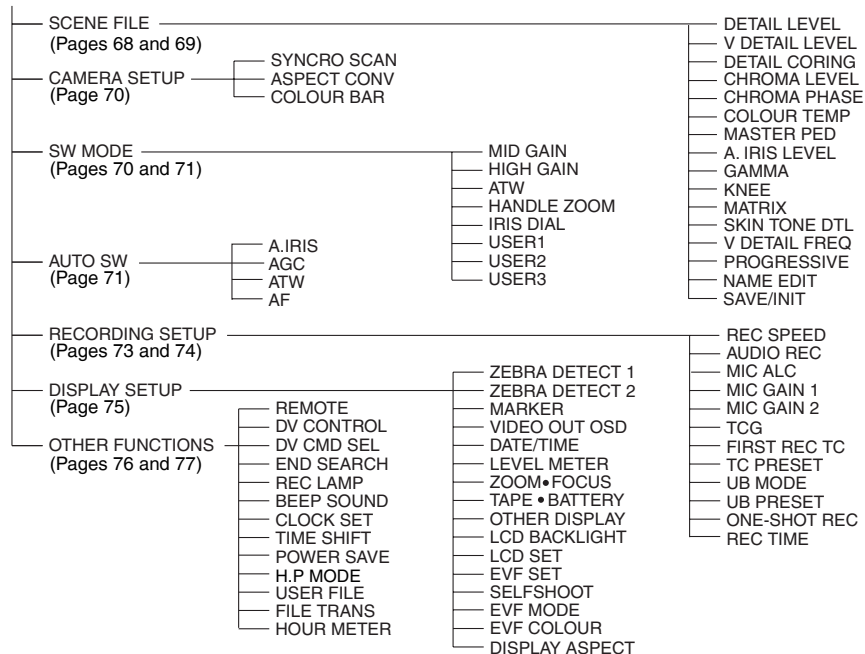

## VCR mode menu

### VCR FUNCTIONS

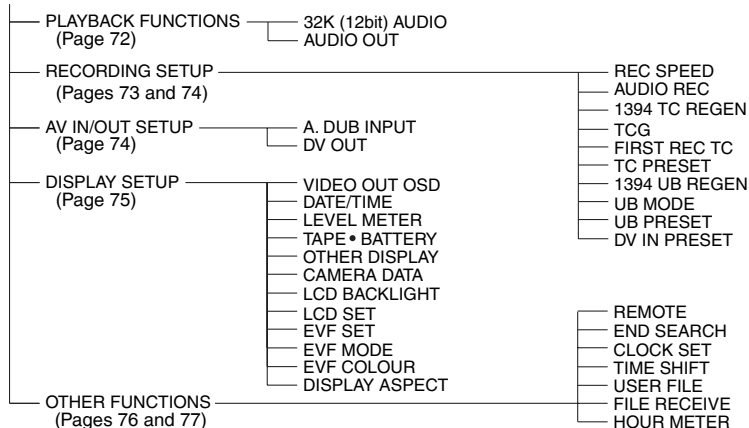

# Setup menu list

## SCENE FILE screen

Item/ (Display mode)	Description of settings
<b>DETAIL LEVEL</b> (camera)	Adjusts the amount of detail. -7 ... 0 ... +7
<b>V DETAIL LEVEL</b> (camera)	Adjusts the level of outline correction in vertical screen. -7 ... 0 ... +7
<b>DETAIL CORING</b> (camera)	Adjusts the level of removing noises of the detail signal. -7 ... 0 ... +7 Set to - for a clearer image. Noise increases slightly. Set to + to decrease noise.
<b>CHROMA LEVEL</b> (camera)	Adjusts chroma level. -7 ... 0 ... +7
<b>CHROMA PHASE</b> (camera)	Finely adjusts chroma phase. -7 ... 0 ... +7
<b>COLOUR TEMP</b> (camera)	Finely adjusts color temperature (after adjusting white balance). -7 ... 0 ... +7
<b>MASTER PED</b> (camera)	Adjusts the black master pedestal as the basis for images. -15 ... 0 ... +15
<b>A. IRIS LEVEL</b> (camera)	Sets AUTO IRIS level. -4 ... 0 ... +4

Item/ Display mode)	Description of settings
<b>GAMMA</b> (camera)	<p>Selects gamma curve.</p> <p><b>LOW:</b></p> <p>Using the gamma curve, which the slope of low-brightness is modest, makes it staid image. The contrast become sharp.</p> <p><b>NORMAL:</b></p> <p>Makes standard images.</p> <p><b>HIGH:</b></p> <p>Using the gamma curve, which the slope of low-brightness is modest, spreads out the tone of dark parts and makes it bright image. The contrast become soft.</p> <p><b>B.PRESS:</b></p> <p>Makes the contrast sharper than LOW.</p> <p><b>CINELIKE:</b></p> <p>Uses the gamma curve to complete the cine-line image. Images have less noise than CINELIKE_D.</p> <p><b>CINELIKE_D:</b></p> <p>Dynamic range is higher than CINELIKE.</p> <p><b>CINELIKE_V:</b></p> <p>Uses the gamma curve to complete the cine-like image of the emphasis on contrast.</p> <ul style="list-style-type: none"> <li>• When CINELIKE Gamma is selected, we recommend that the lens aperture is set to the lower level (about 1/2) than normal image level for making full use the characteristics.</li> </ul>
<b>KNEE</b> (camera)	<p>To avoid an over exposure, use this to set the compression level (knee point) of the high-intensity video signals which the CCD received.</p> <p><b>AUTO:</b></p> <p>Sets the level automatically according to the received signals.</p> <p><b>LOW:</b></p> <p>Low setting (compression begins from approximately 80%)</p> <p><b>MID:</b></p> <p>Medium setting (compression begins from approximately 90%)</p> <p><b>HIGH:</b></p> <p>High Setting (compression begins from approximately 100%)</p>

\_\_\_\_\_ are the factory settings.

## Setup menu list (continued)

### SCENE FILE screen (continued)

Item/ (Display mode)	Description of settings
<b>MATRIX</b> (camera)	Chooses a MATRIX table, and sets the color for shooting. <b>NORM:</b> Makes colors suitable for a shooting in the open air or in using a halogen lamp as the source of light. <b>ENRICHED:</b> Makes colors brighter than the NORM1 mode. <b>FLOU:</b> Makes colors suitable for shooting indoors under fluorescent lights. <b>CINE-LIKE:</b> Makes colors suitable for movie-like shooting.
<b>SKIN TONE</b> <b>DTL</b> (camera)	Sets the skin tone details to ON or OFF. When ON is selected, skin tone details are reduced, which softens the skin tones. <b>ON OFF</b>
<b>V DETAIL</b> <b>FREQ</b> (camera)	Sets the vertical detail when shooting in progressive mode. <b>THIN:</b> Select this to thin the detail of images. <b>MID:</b> Select this to slightly thicken the detail of images. <b>THICK:</b> Select this to thicken the detail of images. • When images were shot in the progressive mode in which the vertical detail is set as "THIN" or "MID" and are played on a monitoring television (50i interlace), you will feel flickers caused on horizontal lines and almost horizontal oblique lines. When you play images under the progressive mode, set the detail as "THIN" or "MID". This gives you higher resolution images than setting the detail as "THICK".

Item/ (Display mode)	Description of settings
<b>PROGRESSIVE</b> (camera)	Sets the shooting in progressive mode. <b>OFF:</b> Select this to disable progressive mode. <b>25P:</b> Select this to shoot in 25P mode (25 frames/second).
<b>NAME EDIT</b> (camera)	Edits the name of the selected scene file you have selected with the scene file dial.
<b>SAVE/INIT</b> (camera)	<b>SAVE:</b> The changed settings in the scene file are saved. • The original scene file settings will be restored when the menu mode is released, the operation is switched to the VCR mode or when the power is turned off if you do not select SAVE. <b>INITIAL:</b> The selected scene file settings in the SCENE FILE dial are returned to the factory settings.

\_\_\_\_\_ are the factory settings.

## CAMERA SETUP screen

Item/ (Display mode)	Description of settings
<b>SYNCRO SCAN</b> (camera)	Adjusts the synchro scan shutter speed used for shooting images on a TV screen, etc. If you move and hold the OPERATION to ▲ or ▼, changing speeds up and a beep sounds. • PROGRESSIVE MODE OFF: <u>1/50.2</u> ... 1/248.0 • PROGRESSIVE MODE 25P: 1/25.1 ... <u>1/50.0</u> ... 1/248.0
<b>ASPECT CONV</b> (camera)	Selects the aspect ratio of the images which are to be recorded. (Page 33) <b>NORMAL</b> <b>LETTER BOX</b> <b>SQUEEZE</b>
<b>COLOUR BAR</b> (camera)	Sets the color bar to ON or OFF. <b>ON OFF</b> • Even if the color bar is set to ON, it reverts to OFF when the unit is switched to VCR mode or when the power is turned off.

## SW MODE screen

Item/ (Display mode)	Description of settings
<b>MID GAIN</b> (camera)	Sets the gain value which is to be allocated to the M position of GAIN switch. <b>0dB 3dB 6dB 9dB 12dB</b>
<b>HIGH GAIN</b> (camera)	Sets the gain value which is to be allocated to the H position of GAIN switch. <b>0dB 3dB 6dB 9dB 12dB</b>
<b>ATW</b> (camera)	Sets the operation of the ATW (Auto Tracking White) function which is to be allocated to the WHITE BAL switch. <b>OFF:</b> Disables the ATW function. However, if the ATW function is set to the AUTO button or USER button, the operation of that button becomes effective. <b>Ach:</b> Activates the ATW function when the WHITE BAL switch is set to A. <b>Bch:</b> Activates the ATW function when the WHITE BAL switch is set to B. <b>PRE:</b> Activates the ATW function when the WHITE BAL switch is set to PRST.
<b>HANDLE ZOOM</b> (camera)	Sets the zoom speeds allocated to the setting positions of the HANDLE ZOOM switch. <b>L/OFF/H:</b> Sets LOW (speed) /OFF/HIGH (speed) to each position of 1/2/3 (zoom is disabled when set to OFF). <b>L/M/H:</b> Sets LOW/MID (medium speed)/HIGH to each position of 1/2/3.
<b>IRIS DIAL</b> (camera)	Sets the rotation and the aperture control of the IRIS dial (when in MANUAL IRIS mode). <b>DOWN OPEN:</b> The iris opens when the IRIS dial is turned downward. <b>UP OPEN:</b> The iris opens when the IRIS dial is turned upward.

\_\_\_\_\_ are the factory settings.

## Setup menu list (continued)

### SW MODE screen (continued)

Item/ (Display mode)	Description of settings
<b>USER1</b> (camera)	<p>Enables a function to be allocated to the USER1 button.</p> <p><b>COLOURBAR:</b> Color bar display (Page 34)</p> <p><b>SPOTLIGHT:</b> Sets the auto iris control for the spotlight to ON or OFF.</p> <p><b>BACKLIGHT:</b> Auto iris control for the backlight compensation (Page 34)</p> <p><b>BLACKFADE:</b> Blackfade (Page 34)</p> <p><b>WHITEFADE:</b> Whitefade (Page 34)</p> <p><b>MODECHECK:</b> Press the button to check the status of the current camera setting displayed on the viewfinder and LCD monitor.</p> <p><b>ATW:</b> Sets the ATW function to ON or OFF.</p> <p><b>ATWLOCK:</b> Press the button to fix the value of white balance. Press again and the ATW function is activated.</p> <p><b>GAIN: 18 dB:</b> Press the button to set the gain value to 18 dB. This function is disabled in progressive mode and slow shutter mode.</p> <ul style="list-style-type: none"> <li>When the gain value is set to 18 dB or set from 18 dB to another value, the image can be disordered for a moment.</li> </ul> <p><b>INDEX:</b> INDEX recording (Page 34)</p> <p><b>SLOWSHUT:</b> Slow shutter mode (Page 39)</p>
<b>USER2</b> (camera)	<p>Enables a function to be allocated to the USER2 button.</p> <p>For further details, refer to USER1 above.</p> <p><b>BACKLIGHT</b></p>
<b>USER3</b> (camera)	<p>Enables a function to be allocated to the USER3 button.</p> <p>For further details, refer to USER1 above.</p> <p><b>INDEX</b></p>

### AUTO SW screen

Item/ (Display mode)	Description of settings
<b>A.IRIS</b> (camera)	<p><b>ON:</b> Performs auto iris control when in auto mode. The IRIS button is disabled.</p> <p><b>OFF:</b> Disables the auto iris control when in auto mode. This performs the iris control selected with the IRIS button.</p>
<b>AGC</b> (camera)	<p>Sets the Auto Gain Control function for when the A. IRIS option is set to ON.</p> <p><b>6dB:</b> Enables the Auto Gain Control function (max 6 dB) when the Auto Mode is selected.</p> <p><b>12dB:</b> Enables the Auto Gain Control function (max 12 dB) when the Auto Mode is selected.</p> <p><b>OFF:</b> Disables the Auto Gain Control function when the Auto Mode is selected.</p>
<b>ATW</b> (camera)	<p><b>ON:</b> Enables the ATW (Auto Tracing White Balance) function when the Auto Mode is selected. You can't enable or disable the ATW function with the WHITE BAL switch or the USER button when this is selected. If ATWLOCK is assigned to the USER button, however, you can set the White Balance value with the USER button.</p> <p><b>OFF:</b> Disables the ATW function when the Auto Mode is selected. The ATW function that has been selected with the WHITE BAL switch applies.</p>
<b>AF</b> (camera)	<p><b>ON:</b> Performs auto focus when the auto mode is established. Neither FOCUS switch nor the PUSH AUTO button works.</p> <p><b>OFF:</b> Performs no auto focus when the auto mode is established. The focusing is performed by the FOCUS switch or PUSH AUTO button.</p>

\_\_\_\_\_ are the factory settings.



## PLAYBACK FUNCTIONS screen

Item/ (Display mode)	Description of settings
<b>32K (12bit) AUDIO (VCR)</b>	<p>Sets the sound to be output as CH1 and CH2 signals when playing back a tape that was recorded in the 32K (12bit) audio mode.</p> <p><b>ST1:</b> Selects the sound that was recorded during shooting. CH1 signals = CH1 track CH2 signals = CH2 track</p> <p><b>ST2:</b> Selects the sound that was dubbed on the recording. CH1 signals = CH3 track CH2 signals = CH4 track</p> <p><b>MIX:</b> Mixes the sound that was recorded during shooting and the sound that was dubbed on the recording. CH1 signals = CH1 track + CH3 track CH2 signals = CH2 track + CH4 track</p> <p><b>Note</b> When the sound is recorded in the 48K (16bit) audio mode, CH3 and CH4 do not exist so the following is always the case. CH1 signals = CH1 track CH2 signals = CH2 track</p>

Item/ (Display mode)	Description of settings
<b>AUDIO OUT (VCR)</b>	<p>Sets the audio signals to be output from the AUDIO IN/OUT pin jack when the tape is played back.</p> <p><b>CH1•CH2:</b> CH1 output = CH1 signals CH2 output = CH2 signals</p> <p><b>CH1:</b> CH1 output = CH1 signals CH2 output = CH1 signals</p> <p><b>CH2:</b> CH1 output = CH2 signals CH2 output = CH2 signals</p>

\_\_\_\_\_ are the factory settings.

### 32K (12bit) AUDIO item/AUDIO OUT item settings and audio track signals output from the AUDIO IN/OUT jack

Audio recording mode	32K (12bit) AUDIO item setting	AUDIO OUT item setting	AUDIO IN/OUT jack CH1 output	AUDIO IN/OUT jack CH2 output
32K (12bit)	ST1	CH1•CH2	CH1	CH2
		CH1 CH2	CH1 CH2	CH1 CH2
	ST2	CH1•CH2 CH1 CH2	CH3 CH3 CH4	CH4 CH3 CH4
	MIX	—	CH1+CH3	CH2+CH4
48K (16bit)	—	CH1•CH2 CH1 CH2	CH1 CH1 CH2	CH2 CH1 CH2

## Setup menu list (continued)

### RECORDING SETUP screen

Item/ (Display mode)	Description of settings
<b>REC SPEED</b> (camera) (VCR)	Set the recording-time mode. <b>SP:</b> SP (standard) mode <b>LP:</b> LP (long) mode
<b>AUDIO REC</b> (camera) (VCR)	Set the audio recording mode for conversion to PCM audio. <b>32K (12bit):</b> 12bit/21kHz <b>48K (16bit):</b> 16bit/48kHz
<b>MIC ALC</b> (camera)	Sets microphone level auto control to ON or OFF. <b>ON OFF</b> Set this ON to reduce distortion at high input levels. • You should also adjust the input level with the AUDIO control whatever you set here.
<b>MIC GAIN 1</b> (camera)	Sets the input level of the external microphone connected to the INPUT 1 terminal. <b>-50dB -60dB</b>
<b>MIC GAIN 2</b> (camera)	Sets the input level of the external microphone connected to the INPUT 2 terminal. <b>-50dB -60dB</b>
<b>1394 TC REGEN</b> (VCR)	Selects the time code used when signals from equipment connected with the DV terminal is recorded. <b>ON:</b> Records with the time code signal input through the DV terminal. <b>OFF:</b> Records with the time code set at TCG/FIRST REC TC. • This setting has priority over any setting you have made in TCG/FIRST REC TC. • If there is no input to the DV terminal, the setting follows the ones set at TCG/FIRST REC TC.

Item/ (Display mode)	Description of settings
<b>TCG</b> (camera) (VCR)	Use this to set the mode in which to advance the time code. <b>FREE RUN:</b> The time code advances regardless of the operation mode. <b>REC RUN:</b> The time code advances only when recording.
<b>FIRST REC TC</b> (camera) (VCR)	Select the time code to be recorded when you start recording. <b>REGEN:</b> Select to record the time code so that it continues from the time code already on the tape. <b>PRESET:</b> The time code does not continue from the time code on the tape. The value you set at TC PRESET is used as the initial value when recording the time code. The time code does continue on from the one on the tape, however, if you continue recording from something on the tape.
<b>TC PRESET</b> (camera) (VCR)	Sets the initial time code. This is effective when you have select PRESET in FIRST REC TC. • Set the frame value to 0 or a multiple of 5 when you are shooting in progressive mode, 25P. Using any other value will cause the time code to differ.
<b>1394 UB REGEN</b> (VCR)	Selects the user information used when signals from equipment connected with the DV terminal is recorded. <b>ON:</b> Records with the user information signal input through the DV terminal. <b>OFF:</b> Records the user information set with UB MODE. • If you select ON here, this has priority over the settings in UB MODE. • If the signal has no user information, the none is recorded. • If there is no signal being input through the DV terminal, then the UB MODE settings are used.

\_\_\_\_\_ are the factory settings.

## RECORDING SETUP screen (continued)

Item/ (Display mode)	Description of settings	Item/ (Display mode)	Description of settings
<b>UB MODE</b> (camera) (VCR)	Set the information you want for user information. <b>USER:</b> Records user information. <b>TIME:</b> Records the current time. <b>DATE:</b> Records the current date. <b>TCG:</b> Records the data from the time code generator. <b>FRM. RATE:</b> Records the frame conversion frame rate.  <div style="text-align: center;">           * * 0 F * * * *                                           a     b     c         </div> <b>a: Checking information for user information</b> <b>b: Frame rates</b> <ul style="list-style-type: none"> <li>• Frame rate (50/25)</li> <li>• I/P ID</li> <li>• Conversion data</li> <li>• Frame rate coefficient</li> </ul> <b>c: Recording management data</b> <ul style="list-style-type: none"> <li>• Frame updates</li> <li>• REC START/STOP data</li> </ul>	<b>UB PRESET</b> (camera) (VCR)	Set user information. Make sure you have set USER in UB MODE.
		<b>ONE-SHOT REC</b> (camera)	Set ONE-SHOT recording mode. (Page 33) <b>ON</b> <b>OFF</b>
		<b>REC TIME</b> (camera)	Sets the length of time for ONE-SHOT recording. (Page 33) <b>0.5s:</b> 0.5 seconds <b>1s:</b> 1.0 second <b>1.5s:</b> 1.5 seconds <b>2s:</b> 2.0 seconds
		<b>DV IN PRESET</b> (VCR)	Synchronizes the camera's TCG with the TC from DV input when you press the TC SET button. <b>ON:</b> The mode is on. <b>OFF:</b> Cancels the mode.

## AV IN/OUT SETUP screen

Item/ (Display mode)	Description of settings
<b>A. DUB INPUT</b> (VCR)	Selects the sound to be recorded for audio dubbing. (Page 55) <b>MIC</b> <b>A_IN</b>
<b>DV OUT</b> (VCR)	Select ON to convert analog input signals into digital signals and output them from the DV connector. (Page 57) <b>OFF ON</b>

\_\_\_\_\_ are the factory settings.

## Setup menu list (continued)

### DISPLAY SETUP screen

Item/ (Display mode)	Description of settings
ZEBRA DETECT 1 (camera)	Sets the brightness level of the left-leaning zebra patterns on the screen. <b>80%, 85%, 90%, 95%, 100%, 105%</b>
ZEBRA DETECT 2 (camera)	Sets the brightness level of the right-leaning zebra patterns on the screen. <b>80%, 85%, 90%, 95%, 100%, 105%, OFF</b> <b>Note</b> The zebra patterns do not appear if you select OFF.
MARKER (camera)	Select ON to display the marker. <b>ON OFF</b> • To display the marker, press the ZEBRA button. (Page 32)
VIDEO OUT OSD (camera) (VCR)	Select ON to output information displayed in the viewfinder and LCD monitor together with the signals from the VIDEO IN/OUT jack. <b>ON OFF</b>
DATE/TIME (camera) (VCR)	Sets whether to display the date and time on the screen and whether to output from the VIDEO IN/OUT jack. <b>OFF:</b> The date and time are not displayed. <b>TIME:</b> The time is displayed. <b>DATE:</b> The date is displayed. <b>TIME&amp;DATE:</b> The time and date are displayed. • If you select any setting other than OFF, the date and/or time are included in the image output signals regardless of the VIDEO OUT OSD setting.
LEVEL METER (camera) (VCR)	Select ON to display the audio level meter. <b>ON OFF</b>
ZOOM · FOCUS (camera)	Select ON to display the zoom and focus values. <b>ON OFF</b>
TAPE · BATTERY (camera) (VCR)	Select ON to display the remaining tape and battery charge. <b>ON OFF</b>
OTHER DISPLAY (camera) (VCR)	Select how much information to display. (Page 64) <b>OFF, PARTIAL, ALL</b>

Item/ (Display mode)	Description of settings
CAMERA DATA (VCR)	Select ON to show the camera settings (such as image stabilizer, F-number, and gain value) during tape playback. <b>OFF ON</b>
LCD BACK-LIGHT (camera) (VCR)	Adjusts the backlight of the LCD monitor. Select HI for a brighter backlight than usual. <b>HI NORMAL</b>
LCD SET (camera) (VCR)	Adjusts the display level of the images on the LCD monitor. (Page 24) <b>LCD COLOUR LEVEL</b> <b>LCD BRIGHTNESS</b> <b>LCD CONTRAST</b>
EVF SET (camera) (VCR)	Adjusts the display level of the images on the viewfinder. (Page 24) <b>EVF COLOUR LEVEL</b> <b>EVF BRIGHTNESS</b> <b>EVF CONTRAST</b>
SELFSHOOT (camera)	Select the LCD mirror mode for self-portrait shooting. Select MIRROR to reverse left and right during self-portrait shooting. <b>NORMAL MIRROR</b>
EVF MODE (camera) (VCR)	Select when to show images on the viewfinder. <b>ON:</b> Images always appear on the viewfinder. <b>AUTO:</b> Images do not appear on the viewfinder when the LCD is open.
EVF COLOUR (camera) (VCR)	Select color or black and white for the images on the viewfinder. <b>ON:</b> Color <b>OFF:</b> Black and white
DISPLAY ASPECT (camera) (VCR)	Select the aspect ratio of the LCD monitor and viewfinder. <b>AUTO:</b> Changes automatically to suit the recording or play mode. <b>4:3:</b> Fixed at 4:3 <b>16:9:</b> Fixed at 16:9 There is a 10% overscan on the LCD when the setting is 16:9 (but not on the viewfinder). You will see the whole image on both the LCD and viewfinder when the setting is 4:3.

\_\_\_\_\_ are the factory settings.

## OTHER FUNCTIONS screen

Item/ (Display mode)	Description of settings	Item/ (Display mode)	Description of settings
<b>REMOTE</b> (camera) (VCR)	Sets the operations of the supplied remote control unit. (For settings on the remote control (Page 19)) <b>VCR1:</b> Accepts commands from a remote control set to VCR1. <b>VCR2:</b> Accepts commands from a remote control set to VCR2. <b>OFF:</b> Operations are not accepted from any remote control.	<b>REC LAMP</b> (camera)	Sets lighting of the tally lamp. <b>OFF:</b> Tally lamp does not light. <b>FRONT:</b> Front tally lamp (microphone side) lights. <b>REAR:</b> Rear tally lamp (viewfinder side) lights. <b>BOTH:</b> Both tally lamps light.
<b>DV CONTROL</b> (camera)	Sets the control method for backup recording with a backup unit connected to the DV connector. <b>OFF:</b> The backup unit is not controlled. <b>EXT:</b> The backup unit can be controlled by the START/STOP button. The images shot by the video camera are stored in the backup unit. Note that the video camera does not record them. <b>BOTH:</b> The images shot by the video camera are recorded by both the video camera and backup unit. <b>CHAIN:</b> When the video camera's tape approaches its end during shooting, the backup unit set in the recording stand-by mode automatically starts to record the images.	<b>BEEP SOUND</b> (camera)	Selects ON/OFF for the beeps. <b>ON OFF</b>  Select ON to be warned by a beep in the following situations. • When a beep sounds, the audio signals from the OUT jack are muted and the beep is output instead. One beep • when you set the power switch to ON • when you start shooting Two beeps • when you pause shooting Three beeps • when you have set the cassette tape write-protect • when condensation has formed inside the camera-recorder • when a problem has occurred in the camera-recorder Ten beeps • when it is not possible to record to the tape
<b>DV CMD SEL</b> (camera)	Sets how the START/STOP button works for the backup unit. <b>REC P:</b> The button works as a REC/REC PAUSE button. <b>STOP:</b> The button works as a REC/REC STOP button. <b>Note</b> If the backup unit does not have a rec pause function, select STOP.	<b>CLOCK SET</b> (camera) (VCR)	Sets the camera-recorder's calendar.
<b>END SEARCH</b> (camera) (VCR)	Sets the operation to be performed when a blank search is conducted. (Page 50) <b>BLANK</b> <b>REC END</b>	<b>TIME SHIFT</b> (camera) (VCR)	The time set using this item is added to the clock time of the internal calendar (time difference compensation) and displayed on the screen. The added time is also recorded on the tape. <b>+23h ... +1h, OFF, -1h ... -23h</b> (In 1-hour increments)

\_\_\_\_\_ are the factory settings.

## Setup menu list (continued)

### OTHER FUNCTIONS screen (continued)

Item/ (Display mode)	Description of settings
<b>POWER SAVE</b> (camera)	<p>Select the power saving mode. When you don't perform any specified operations for five minutes*</p> <p><b>ON:</b> the camera recorder turns off automatically</p> <p><b>OFF:</b> the cylinder head pauses and goes into standby mode without cutting the power</p> <p>* The camera recorder does not go into power save mode if you use the following controls.</p> <ul style="list-style-type: none"> <li>• AUTO Button</li> <li>• FOCUS switch</li> <li>• PUSH AUTO button</li> <li>• GAIN switch</li> <li>• WHITE BAL switch</li> <li>• IRIS button and dial</li> <li>• CH1/CH2 SELECT switch</li> <li>• INPUT1/2 switch</li> <li>• AUDIO control</li> <li>• OIS button</li> <li>• SHUTTER button</li> <li>• SPEED SEL button</li> <li>• Zoom button and ring</li> <li>• HANDLE ZOOM switch</li> <li>• Opening or closing the LCD</li> </ul> <p><b>Note</b> When connecting a DV (IEEE 1394) cable to an external device in transfer mode, the power will not turn off even if you have not performed any of these functions.</p>
<b>H.P MODE</b> (camera)	<p>Select headphone output.</p> <p><b>TAPE:</b> Sound recorded on the tape is output.</p> <p><b>LIVE:</b> Current input is output. The beep sound is not output even if you have selected ON for BEEP SOUND. Use this when you are shooting in the 25P mode or any other time that sound delay becomes noticeable.</p>

Item/ (Display mode)	Description of settings
<b>USER FILE</b> (camera) (VCR)	<p><b>LOAD:</b> The previous scene file settings are loaded.</p> <p><b>SAVE:</b> The changed user file settings are saved.</p> <p><b>INITIAL:</b> The user file settings are returned to the factory settings.</p> <ul style="list-style-type: none"> <li>• After LOAD or INITIAL, switch camera-recorder OFF and then back ON to ensure that the settings take effect.</li> </ul>
<b>FILE TRANS</b> (camera)	<p>Make settings for scene file transfer. (Page 46)</p> <p><b>SCENE:</b> Transfer the scene file currently selected with the SCENE dial.</p> <p><b>SCENE ALL:</b> Transfer all scene files.</p> <p><b>USER:</b> Transfer all user scene files.</p> <p><b>Note</b> When in FILE TRANS mode, only the menu operation buttons will function.</p>
<b>FILE RECEIVE</b> (VCR)	<p>Makes the camera ready to receive scene files from another camera. (Page 46)</p> <p><b>Note</b> <b>RECEIVE MODE</b> appears on the screen after you set this mode. When in FILE RECEIVE mode, only the menu operation buttons will function.</p>
<b>HOURL METER</b> (camera) (VCR)	<p>Displays the total running time (a 5-digit figure in 1-hour increments) of the cylinder head.</p>

\_\_\_\_\_ are the factory settings.

# Before calling for service

## Power supply

<b>There's no power.</b>	<ul style="list-style-type: none"> <li>• Make sure the battery and AC adapter are connected properly. Check the connections again.</li> </ul>	P 9
<b>Power shuts off for no apparent reason.</b>	<ul style="list-style-type: none"> <li>• To prevent the battery from running down needlessly and to safeguard the tape from wear, the camera-recorder automatically turns off when the camera-recorder has been left in the shooting pause mode for more than 5 minutes. Check the settings in the OTHER FUNCTIONS screen, POWER SAVE.</li> </ul>	P 11, P 77
<b>Power goes off as soon as it is turned on.</b>	<ul style="list-style-type: none"> <li>• The battery may have run out. If the remaining battery charge display is blinking or  appears, the battery has run out. Either recharge the battery or replace the discharged battery with a fully charged one.</li> <li>• Condensation may have formed. When, for instance, the camera-recorder is taken from a cold place to a heated room, condensation may form inside. If this happens, the camera automatically turns off and the only operation that you will be able to perform is to remove the cassette. Wait until the condensation has dried out.</li> </ul>	P 20  P 81

## Battery

<b>The battery runs down quickly.</b>	<ul style="list-style-type: none"> <li>• Make sure the battery is fully charged. Keep charging until the AC adapter's CHARGE lamp goes out.</li> <li>• Are you using the battery in a cold place? The battery is affected by the ambient temperature. Its operating time is reduced in low-temperatures.</li> <li>• The battery may have reached the end of its service life. The battery will become unchargeable. The battery has a certain service life which varies depending on how the battery is used. If the battery operates only for a short period even when it is charged adequately, it has reached the end of its service life.</li> </ul>	P 20  —  —
<b>The battery cannot be charged.</b>	<ul style="list-style-type: none"> <li>• The battery cannot be charged if the DC cord is connected. Disconnect it.</li> </ul>	—

## Normal video recording

<b>Cannot record even though the cassette tape is inserted properly.</b>	<ul style="list-style-type: none"> <li>• Make sure the tab on the cassette tape for preventing accidental erasure is not set to SAVE. You cannot record when the tab is in this position.</li> <li>• The cassette tape may have reached the end. If so, replace it with another tape.</li> <li>• Make sure the POWER switch is ON.</li> <li>• Make sure the VCR lamp is off. You cannot shoot in VCR mode.</li> <li>• Make sure the cassette holder is closed. You cannot operate the camera if the cassette holder is open.</li> <li>• Condensation may have formed. If this happens, the only operation that you will be able to perform is to remove the cassette. Wait until the condensation has dried out.</li> <li>• If the AUTO OFF/T REEL LOCK warning appears, the tape may have snapped. Check the tape.</li> </ul>	P 14  —  —  —  P 81  —
--	--	--

## Before calling for service (continued)

### Other types of video recording

<b>Cannot focus automatically.</b>	<ul style="list-style-type: none"><li>• Make sure the camera is in manual mode. You can focus automatically when the auto focus mode is selected.</li></ul>	P 35
	<ul style="list-style-type: none"><li>• You may be shooting a scene where it is difficult to bring the subject into focus in the auto focus mode. If this is the case, focus in the manual focus mode. It may be hard to bring the subject into focus when<ul style="list-style-type: none"><li>* both close and distant objects are to be shot</li><li>* shooting through a dirty window</li><li>* shooting in a dark place</li><li>* there are sparkling or shiny objects around the subject</li><li>* the subject is moving fast</li><li>* shooting a scene with minimal contrast</li></ul></li></ul>	—

### Editing

<b>Cannot perform audio dubbing.</b>	<ul style="list-style-type: none"><li>• Make sure the tab on the cassette tape for preventing accidental erasure is not set to SAVE. You cannot edit when the tab is in this position.</li></ul>	P 14
	<ul style="list-style-type: none"><li>• You may be trying to edit a part that was shot in LP mode. You cannot dub after recording in LP mode as the track on the tape is thinner than the head.</li></ul>	—

### Displays

<b>Something is wrong with the time code display.</b>	<ul style="list-style-type: none"><li>• The time code display may not register a regular count if a tape is played in the reverse slow mode. This is normal.</li></ul>	—
<b>The remaining tape display differs from the actual amount of tape remaining.</b>	<ul style="list-style-type: none"><li>• The remaining tape is not displayed accurately if you shoot continuously for periods of less than 30 seconds.</li></ul>	—
	<ul style="list-style-type: none"><li>• The display may show 2 to 3 minutes less than the actual time remaining on the tape.</li></ul>	—

### Playback (images)

<b>Cannot play back a tape even when I press the play button.</b>	<ul style="list-style-type: none"><li>• Make sure the VCR lamp is on (press the CAMERA/VCR button). No kind of playback operation can be performed unless this lamp is on.</li></ul>	P 47
<b>Mosaic-like noise appears when I cue or review a tape.</b>	<ul style="list-style-type: none"><li>• This noise is inherent to digital video technology. This is normal.</li></ul>	—
<b>Images do not appear on the television even though I have connected the camera-recorder properly.</b>	<ul style="list-style-type: none"><li>• Make sure the input selector on your television is set to video input. Read the television's instructions carefully and select the correct video input connector for the camera-recorder.</li></ul>	—
<b>The playback images are not displayed clearly.</b>	<ul style="list-style-type: none"><li>• The camera-recorder's heads may be dirty. Images will not be displayed clearly if the heads are dirty.</li></ul>	—



## Playback (sound)

<b>Cannot hear any sound from the camera-recorder's speaker.</b>	<ul style="list-style-type: none"> <li>You may have turned down the camera-recorder's volume control too far. In the VCR mode, adjust the volume level using the AUDIO MON/VAR button+.</li> </ul>	P 48
<b>I can hear two sets of sound.</b>	<ul style="list-style-type: none"> <li>You may have selected "MIX" as the 32K (12bit) AUDIO setting in the PLAYBACK FUNCTION screen.</li> <li>If you perform audio dubbing on a tape that was recorded with 32K (12bit) selected as the AUDIO REC setting in the RECORDING SETUP screen, you will hear the sound heard during recording and that of the audio dubbing. You can also listen to each sound separately.</li> </ul>	P 72 P 73
<b>When I performed audio dubbing, the original sound was erased.</b>	<ul style="list-style-type: none"> <li>If you perform audio dubbing on a tape that was recorded with 32K (12bit) selected as the AUDIO REC setting in the RECORDING SETUP screen, you will hear the sound heard during recording and that of the audio dubbing. To leave the original sound intact, make sure that 32K (12bit) is selected when you shoot.</li> </ul>	P 73

## Other

<b>Cannot remove the cassette tape.</b>	<ul style="list-style-type: none"> <li>Make sure the camera is supplied with power. Make sure the AC adapter or battery is inserted correctly. As long as the power is supplied, you can remove the cassette without turning ON the POWER switch.</li> </ul>	P 9
<b>Cannot perform any operation other than removing the cassette.</b>	<ul style="list-style-type: none"> <li>Condensation may have formed. If this happens, the only operation that you will be able to perform is to remove the cassette. Wait until the condensation has dried out.</li> <li>When the cassette holder is closed immediately after sliding EJECT switch to open the cassette holder, sometimes operations other than eject cannot be performed. In this case, slide EJECT switch again to open the cassette holder, check that the cassette mechanism has completed ejecting operation, and then close the cassette holder.</li> </ul>	P 81 —
<b>The remote control does not work.</b>	<ul style="list-style-type: none"> <li>The button battery in the remote control may have run out. If the remote control fails to work even if it is operated close to the remote control sensor of the camera-recorder, it means that the button battery has run out. Replace it with new one.</li> <li>Make sure the remote control setting is the same for the remote control unit and the camera-recorder. If the REMOTE setting is different on the remote control and the camera-recorder, the remote control will not work.</li> </ul>	P 19 P 19, P 76
<b>There is a rattling sound when the camera-recorder is tilted back and forth.</b>	<ul style="list-style-type: none"> <li>There are some parts of the camera that make a rattling sound in the VCR mode or when the POWER switch is OFF. This is normal.</li> </ul>	—

# Condensation

## How to find out if there is condensation inside and what to do about it

If the condensation mark  blinks, condensation has formed inside the camera-recorder. If this happens, the power automatically turns off in few seconds.

Take the following action.

- (1) Remove the cassette  
No other functions will be possible. It may not even be possible to remove the cassette tape depending on the amount of condensation. If this is the case, wait two to three hours before removing the cassette.
- (2) Wait two to three hours with the cassette holder open.  
The time you need to wait depends on the amount of condensation and the ambient temperature.

- (3) Turn on the power two to three hours later and check whether or not the condensation display has gone off.

To make doubly sure, wait another hour or so after the condensation display has gone off before using the camera-recorder again.

### Also remember that even when the condensation display has not appeared, condensation may be forming.

- Condensation builds up gradually so the condensation display may not appear for 10 to 15 minutes after it has started to form inside.
- In very cold areas, the condensation may freeze. If this happens, it will take another two to three hours for it to thaw out.

# Tally lamp

The tally lamp can be made to light up during shooting by selecting "ON" as the REC LAMP setting in the OTHER FUNCTIONS screen (Page 76). When the camera-recorder is in any of the following states, the tally lamp blinks.

- When an operation initiated by the remote control unit has been received (8 blinks/sec.)
- When the camera-recorder's mode is being switched to shooting (8 blinks/sec.)
- When the end of the tape is reached (4 blinks/sec.)
- When trouble occurs regarding tape running systems (4 blinks/sec.)

- When there is not much tape left, or the remaining charge of the battery is low (1 blink/sec.)

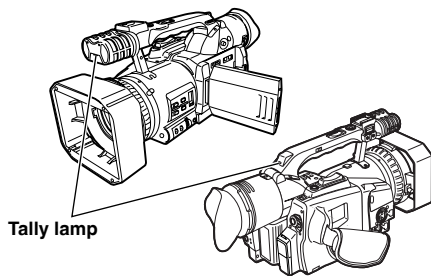

# System resetting

Reset the system microcomputer if you can no longer operate the camera-recorder even though its power is on or a similar kind of a problem has occurred.

Use a pointed object to press the RESET button on the camera-recorder.

The menu setting entered and memory contents will not be cleared even when the system is reset.

Do not press the RESET button when the camera-recorder is operating normally.

RESET button

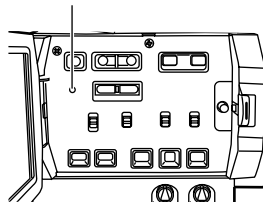

# Video Heads

Dirty video heads cause partial mosaic-pattern noise or make the whole display bluish on playback. When the video heads get extremely dirty, the recording quality decreases, and, in the worst case, it won't record at all.

## Causes of dirty video heads

- Dusty atmosphere
- High temperature and humidity
- Scratches on tapes
- Overuse

## Using A Cleaning Tape

- (1) Insert the cleaning tape in the camera recorder and turn on the power switch
- (2) Press the CAMERA/VCR button and make sure the VCR lamp is on.
- (3) Move the OPERATION lever ►. Move it ■ within ten seconds.  
(Do not rewind the tape at this point.)
- (4) Eject the cleaning tape and insert another tape. Record on it and play it back. Make sure the picture is fine.
- (5) If the picture is not clear, repeat the steps 1-4.  
(Do not use the cleaning tape more than four times in a row.)

- Do not rewind the cleaning tape until it gets to the end of the tape. When the tape gets to the end, rewind it to the beginning to use it again.
- If the video head gets dirty soon after you clean it, the cleaning tape might be damaged. Stop using the cleaning tape right away.
- Overusing the cleaning tape might damage the video head. If the video head is damaged, the picture quality will not improve even when you clean the video head.
- When you can't clean a dirty video head with the cleaning tape, it needs cleaning and repair at the dealer. Please contact them.

## Regular Maintenance

For the superior picture quality, we recommend replacing consumable parts such as a video head approximately every 2,000 hours of use. (However, this estimated time varies greatly depending on the environment in which it is used, such as temperature, humidity, and dust.)

# Cleaning

## When cleaning, do not use benzene or thinner.

- Using benzene or paint thinners may deform the camera-recorder and/or cause the surface finish to peel off.
- Before proceeding with maintenance, remove the battery or disconnect the AC cord from the power outlet.
- Use a soft, clean cloth to wipe the camera-recorder. To remove stubborn dirt, wipe the camera-recorder with a cloth moistened with kitchen detergent that has been diluted with water and then use a dry cloth to take up the remaining moisture.

## Cleaning the Viewfinder

If there is dust inside the view finder, remove the eye cap holder and get rid of the dust.

- The interior of the eye cap holder is specially finished, so do not ever wipe it. If there is dust on it, blow it off with an air blower.

- You can remove the eye cap holder by turning it counterclockwise. When you do this, tilt the view finder slightly upward.
- When you put the eye cap holder back on, hold it so that the eye cap holder mark points upward, then turn it clockwise to put it back on.

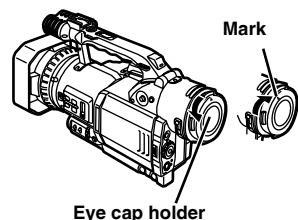

# Storage Precautions

---

Before storing the video camera, remove both the cassette and battery.

Store all of these items in a place with low humidity and relatively constant temperature.

[Recommended temperature range: 15°C to 25°C]

[Recommended relative humidity: 40% to 60%]

## Video camera

- Wrap the video camera in a soft cloth to keep the dust off.

## Battery

- The battery life is shortened in places with extreme temperatures.
- Storing the battery in a location with oily vapors or high dust concentrations may corrode the terminals or cause other damage, leading to malfunction.
- **Keep metal objects (such as necklaces and hair pins) away from the terminals. Short-circuiting may occur across the terminals, causing the battery to heat up, and you may seriously burn yourself if you touch the battery in this state.**
- Discharge the battery before storing it. When storing it for an extended time, charge it at least once a year, use up its charge in the camera-recorder, and then store it again.

## Cassette Tapes

- Always rewind your tapes to the beginning before storing them. They will become slack if left stopped part way through for six months or more (the time frame depends on the storage conditions). Make sure that all of your tapes are rewound to the beginning before storage.
- Always put your tapes back into their original cases before storing them. Dust, direct sunlight (ultraviolet rays) or humidity may damage the tapes. Dust contains particles of hard minerals. These particles could burrow into the cassettes, causing damage to the video camera's heads or other parts. Make sure that all of your tapes are stored in the cases.
- Fast forward and rewind tapes once every six months. If tapes are left wound up for more than a year, the expansion and contraction caused by changes in temperature and humidity may distort the tapes or make them stick to each other.
- Do not place substances or equipment with strong magnetic fields near cassettes.
- Tapes are surfaced with microscopically small magnetic particles where the signals are recorded. Magnetic necklaces, toys and other products may have an unexpectedly strong magnetic field and this may cause data loss or generate noise on the screen and in the sound.

# Specifications

## [GENERAL]

Supply voltage: DC7.2 V/7.9 V
Power consumption
6.8 W (when the viewfinder is used)
7.2 W (when the LCD monitor is used)
9.8 W (max.)

 indicates safety information.

### Ambient operating temperature

0 °C to 40 °C

### Ambient operating humidity

10% to 85% (no condensation)

### Weight

1.7 kg (excluding battery and accessories)

### Dimensions (WxHxD)

139 mm x 160 mm x 364 mm

### Recording format

DV (Digital video SD format)

### Tape format

Mini DV system

### Video signals recorded

625i (PAL)

In progressive mode, convert to 625i and record

### Shooting mode

50i (625i)

Progressive mode (25P)

### Audio signals recorded

PCM digital recording

16bit: 48kHz/2ch

12bit: 32kHz/4ch

### Recording tracks

Digital video/audio:

    Helical tracks

Time code:

    Helical tracks (sub code area)

### Tape speeds

SP mode: 18.831 mm/sec.

LP mode: 12.568 mm/sec.

### Recording time (when AY-DVM63 is used)

SP mode: 60 minutes

LP mode: 90 minutes

### Tapes used

6.35 mm wide metal tapes

### FF/REW time

Approx. 140 sec. (when AY-DVM63 is used)

### Pickup devices

CCD image sensor (x3)

(1/3-inch, interline transfer, progressive-capable)

### Number of pixels

Total number of pixels: 470,000, Number of effective pixels: 440,000 (pixel offset system)

### Lens

LEICA DICOMAR Optical image stabilizer lens, Motorized/Manual selectable 10x zoom, F1.6 (f=4.5 to 45 mm)

(35 mm equivalent: 32.5 to 325 mm)

### Color separation optical system

Prism system

### ND filter

1/8, 1/64

### Gain settings

0/+3/+6/+9/+12/+18 dB (50i mode)

0/+3/+6/+9/+12 dB (progressive 25P mode)

(however, set to 0dB when the slow shutter mode is used)

### Shutter speed settings

Regular shutter speed

50i mode:

1/50 (OFF), 1/60, 1/120,

1/250, 1/500, 1/1000, 1/2000 sec.

25P mode:

1/25, 1/50 (OFF), 1/60, 1/120, 1/250, 1/500, 1/1000 sec.

Synchronous scan settings

50i mode: 1/50.2 to 1/248.0 sec.

25P mode: 1/25.1 to 1/248.0 sec.

Slow shutter settings

50i mode: 1/3, 1/6, 1/12, 1/25

25P mode: 1/3, 1/6, 1/12

### Minimum subject luminance

3 lx (F1.6, gain 18 dB, video output 50 IRE)

### Lens hood

Large-sized lens hood with wide angle of view

### Filter diameter

72 mm

### LCD monitor

3.5-inch LCD color monitor, 210,000 pixels

### Viewfinder

0.44-inch LCD color viewfinder, 235,000 pixels

### Internal microphone

Stereo microphone

### Internal speaker

28 mm diameter

## Specifications (continued)

### [VIDEO]

#### Sampling frequency

Y: 13.5 MHz, Pb/Pb: 6.75 MHz

#### Quantizing

8 bit

#### Video compression system

DCT + variable-length code

#### Error correction

Reed-Solomon product code

### [AUDIO]

#### Sampling frequency

48 kHz/32 kHz

#### Quantizing

16 bit/12 bit

#### Frequency response

20 Hz to 20 kHz

#### Wow & flutter

Below measurable limits

### [CONNECTORS]

#### VIDEO IN/OUT (automatic input/output switching)

Pin jack, Analog composite input/output,  
1.0 V [p-p], 75  $\Omega$

#### S-VIDEO IN/OUT (automatic input/output switching)

S-connector, Y/C separate signal  
Y: 1.0 V [p-p], C: 0.3 V [p-p],  
75  $\Omega$

#### AUDIO IN/OUT (automatic input/output switching)

Pin jack x2 (CH1, CH2)  
Input: 316 mV, high impedance  
Output: 316 mV, 600  $\Omega$

#### DV

4 pins, digital input/output, compliant with IEEE  
1394 standard

#### INPUT 1, INPUT 2

XLR (3 pins) x2 (CH1, CH2),  
LINE/MIC selectable, high impedance  
LINE: 0 dBu  
MIC:  
-50 dBu/-60 dBu (selectable in menu)

#### DC INPUT

7.9 V

#### PHONES

3.5-mm stereo mini jack, 100  $\Omega$

#### CAM REMOTE

Mini jack (3.5 mm diameter)  
(FOCUS IRIS)  
Super-mini jack (2.5 mm diameter)  
(ZOOM S/S)

### [AC ADAPTER]

Power Source: 100-240 V AC, 50/60 Hz
Power Output: 8.4V 1.2A (Charging) 7.9V 1.4A (Supplying)
Power consumption 20 W

 indicates safety information.

#### Weight

160 g

#### Dimensions (W x H x D)

70 mm x 44.5 mm x 116 mm

### [OPTIONAL UNITS]

#### Wide conversion lens

AG-LW7208G

#### 16: 9 conversion lens

AG-LA7200G

#### XLR microphone

AG-MC100G

#### Hard carrying case

AG-HT100G

#### Soft carrying case

AG-SC100G

#### Battery

CGR-D16 (1600 mAh)

CGP-D28 (2800 mAh)

CGA-D54 (5400 mAh: equivalent to accessory  
battery)

#### AC adapter kit

AG-B15 (equivalent to accessory AC cord, DC  
cord, AC adapter)

#### Cleaning tape

AY-DVMCL

Weight and dimensions when shown are  
approximately.  
Specifications are subject to change without notice.

### Information on Disposal for Users of Waste Electrical & Electronic Equipment (private households)



This symbol on the products and/or accompanying documents means that used electrical and electronic products should not be mixed with general household waste.

For proper treatment, recovery and recycling, please take these products to designated collection points, where they will be accepted on a free of charge basis. Alternatively, in some countries you may be able to return your products to your local retailer upon the purchase of an equivalent new product.

Disposing of this product correctly will help to save valuable resources and prevent any potential negative effects on human health and the environment which could otherwise arise from inappropriate waste handling. Please contact your local authority for further details of your nearest designated collection point.

Penalties may be applicable for incorrect disposal of this waste, in accordance with national legislation.

### For business users in the European Union

If you wish to discard electrical and electronic equipment, please contact your dealer or supplier for further information.

### Information on Disposal in other Countries outside the European Union

This symbol is only valid in the European Union.

If you wish to discard this product, please contact your local authorities or dealer and ask for the correct method of disposal.

---

## **Matsushita Electric Industrial Co., Ltd.**

Web Site: <http://www.panasonic.co.jp/global/>

© 2005 Matsushita Electric Industrial Co., Ltd. All Rights Reserved.

Download from [Www.Somanuals.com](http://www.Somanuals.com). All Manuals Search And Download.





## Free Manuals Download Website

<http://myh66.com>

<http://usermanuals.us>

<http://www.somanuals.com>

<http://www.4manuals.cc>

<http://www.manual-lib.com>

<http://www.404manual.com>

<http://www.luxmanual.com>

<http://aubethermostatmanual.com>

Golf course search by state

<http://golfingnear.com>

Email search by domain

<http://emailbydomain.com>

Auto manuals search

<http://auto.somanuals.com>

TV manuals search

<http://tv.somanuals.com>