

Packard Bell EasyNote TK11BZ/TK13BZ

# SERVICEGUIDE



## Revision History

Refer to the following table for the updates made to this Packard Bell EasyNote TK11BZ/TK13BZ service guide.

Date	Chapter	Updates

Service guide files and updates are available on the ACER/CSD Website. For more information, go to <http://csd.acer.com.tw>. The information in this guide is subject to change without notice.

## Copyright

Copyright © 2010 by Packard Bell Incorporated. All rights reserved. No part of this publication may be reproduced, transmitted, transcribed, stored in a retrieval system, or translated into any language or computer language, in any form or by any means, electronic, mechanical, magnetic, optical, chemical, manual or otherwise, without the prior written permission of Packard Bell Incorporated.

## Disclaimer

The information in this guide is subject to change without notice.

There are no representations or warranties, either expressed or implied, with respect to the contents hereof and specifically disclaims any warranties of merchantability or fitness for any particular purpose. The software described in this manual is sold or licensed "as is". Should the programs prove defective following their purchase, the buyer (not the manufacturer, distributor, or its dealer) assumes the entire cost of all necessary servicing, repair, and any incidental or consequential damages resulting from any defect in the software.

## Conventions

The following conventions are used in this manual:

### **WARNING:**

Indicates a potential for personal injury.

### **CAUTION:**

Indicates a potential loss of data or damage to equipment.

### **+ IMPORTANT:**

Indicates information that is important to know for the proper completion of a procedure, choice of an option, or completing a task.

The following typographical conventions are used in this document:

- Book titles, directory names, file names, path names, and program/process names are shown in *italics*.

Example:

the *DRS5 User's Guide*  
*/usr/local/bin/fd*  
the */TPH15spool\_M* program

- Computer output (text that represents information displayed on a computer screen, such as menus, prompts, responses to input, and error messages) are shown in constant width.

Example:

```
[01] The server has been stopped
```

- User input (text that represents information entered by a computer user, such as command names, option letters, and words) are shown in constant width bold.

Variables contained within user input are shown in angle brackets (< >).

Example:

At the prompt, type run **<file name> -m**

- Keyboard keys are shown in ***bold italics***.

Example:

After you enter the data, press ***Enter***.

## General information

---

This service guide provides all technical information relating to the basic configuration for Packard Bell's global product offering. To better fit local market requirements and enhance product competitiveness, your regional office may have decided to extend the functionality of a machine (such as add-on cards, modems, or extra memory capabilities). These localized features are not covered in this generic service guide. In such cases, contact your regional offices or the responsible personnel/channel to provide further technical details.

When ordering FRU parts:

Check the most up-to-date information available on your regional Web or channel. If, for whatever reason, a part number change is made, it may not be noted in this printed service guide.

Acer-authorized Service Providers:

Your Acer office may have a different part number code than those given in the FRU list in this service guide. You must use the list provided by your regional Acer office to order FRU parts for repair and service of customer machines.



# CHAPTER 1

## Hardware Specifications

---

<b>Features</b> .....	<b>1-5</b>
Operating System .....	1-5
Platform .....	1-5
System Memory .....	1-5
Display .....	1-5
Audio Subsystem .....	1-5
Graphics .....	1-6
Storage Subsystem .....	1-6
Privacy Control .....	1-6
Optical Media Drive .....	1-6
Communication .....	1-6
Dimension and Weight .....	1-7
Power Adapter and Battery .....	1-7
Special Keys and Controls .....	1-7
I/O Ports .....	1-7
Optional Items .....	1-8
Warranty .....	1-8
Software .....	1-8
Environment .....	1-9
<b>Notebook Tour</b> .....	<b>1-10</b>
Top View .....	1-10
Closed Front View .....	1-12
Rear View .....	1-13
Left View .....	1-14
Right View .....	1-15
Base View .....	1-16
Touchpad Basics .....	1-17
Using the Keyboard .....	1-18
Windows Keys .....	1-19
Hotkeys .....	1-20
System Block Diagram .....	1-22
<b>Specification Tables</b> .....	<b>1-23</b>
Computer specifications .....	1-23
Processor .....	1-24
Processor Specifications .....	1-25
CPU Fan True Value Table (TJ100-CPU/UMA) .....	1-25
CPU Fan True Value Table (TJ100-CPU/SG) .....	1-25
System Memory .....	1-26
Memory Combinations .....	1-26
Video Interface .....	1-26
BIOS .....	1-27
LAN Interface .....	1-28
Keyboard .....	1-28

Hard Disk Drive (AVL components) . . . . .	1-29
Hard Disk Drive (AVL components) (Continued) . . . . .	1-30
Super-Multi Drive . . . . .	1-31
LED 15.6" . . . . .	1-32
LCD Inverter (not available with this model) . . . . .	1-32
Display Supported Resolution (LCD Supported Resolution) . . . . .	1-33
Display Supported Resolution (GPU Supported Resolution) . . . . .	1-33
Mini Card . . . . .	1-35
3G Card (not available in this model). . . . .	1-35
Audio Codec and Amplifier . . . . .	1-35
Audio Interface . . . . .	1-35
Battery . . . . .	1-37
VRAM . . . . .	1-37
USB Port . . . . .	1-37
AC Adapter . . . . .	1-38
System Power Management . . . . .	1-38
Card Reader . . . . .	1-38
System LED Indicator . . . . .	1-39
System DMA Specification . . . . .	1-39

## CHAPTER 2

### System Utilities

---

<b>BIOS Setup Utility</b> . . . . .	<b>2-3</b>
Navigating the BIOS Utility . . . . .	2-3
<b>BIOS</b> . . . . .	<b>2-4</b>
Information . . . . .	2-4
Main . . . . .	2-6
Security . . . . .	2-8
Boot . . . . .	2-12
Exit . . . . .	2-13
<b>BIOS Flash Utilities</b> . . . . .	<b>2-14</b>
DOS Flash Utility . . . . .	2-15
WinFlash Utility . . . . .	2-17
<b>Remove HDD/BIOS Password Utilities</b> . . . . .	<b>2-18</b>
Removing BIOS Passwords . . . . .	2-20
Cleaning BIOS Passwords . . . . .	2-22
<b>Miscellaneous Tools</b> . . . . .	<b>2-23</b>
Using Boot Sequence Selector . . . . .	2-23
Using DMITools . . . . .	2-24
Using the LAN MAC EEPROM Utility . . . . .	2-25
Crisis Disk Recovery . . . . .	2-26

## CHAPTER 3

### Machine Maintenance Procedures

---

Introduction . . . . .	3-5
General Information . . . . .	3-5
Recommended Equipment . . . . .	3-5
Maintenance Flowchart. . . . .	3-6
Getting Started . . . . .	3-7
Battery Pack Removal. . . . .	3-8
Battery Pack Installation . . . . .	3-8
Dummy Card Removal . . . . .	3-9
Dummy Card Installation . . . . .	3-9
Keyboard Removal . . . . .	3-10
Keyboard Installation. . . . .	3-11
ODD (Optical Disk Drive) Module Removal . . . . .	3-12
ODD Module Installation. . . . .	3-13
Base Door Removal . . . . .	3-14
Base Door Installation . . . . .	3-14
DIMM (Dual In-line Memory Module) Module Removal . . . . .	3-15
DIMM Module Installation. . . . .	3-16
WLAN (Wireless Local Area Network) Board Removal . . . . .	3-17
WLAN Board Installation . . . . .	3-17
RTC Battery Removal . . . . .	3-18
RTC Battery Installation . . . . .	3-18
HDD (Hard Disk Drive) Module Removal . . . . .	3-19
HDD Module Installation . . . . .	3-20
Upper Cover Removal . . . . .	3-21
Upper Cover Installation . . . . .	3-23
Speaker Removal . . . . .	3-24
Speaker Installation . . . . .	3-25
Power Board Removal . . . . .	3-26
Power Board Installation . . . . .	3-26
Touchpad Removal. . . . .	3-27
Touchpad Installation . . . . .	3-27
USB Board Removal . . . . .	3-28
USB Board Installation . . . . .	3-29
ODD Board Removal . . . . .	3-30
ODD Board Installation . . . . .	3-30
Bluetooth Board Removal . . . . .	3-31
Bluetooth Board Installation . . . . .	3-31
Mainboard Removal. . . . .	3-32
Mainboard Installation . . . . .	3-34
Fan Removal . . . . .	3-35

Fan Installation . . . . .	3-35
Heatsink Removal . . . . .	3-36
Heatsink Installation . . . . .	3-37
LCD (Liquid Crystal Display) Module Removal . . . . .	3-39
LCD Module Installation . . . . .	3-40
DC-IN Cable Removal . . . . .	3-41
DC Cable Installation . . . . .	3-42
LCD Bezel Removal . . . . .	3-43
LCD Bezel Installation . . . . .	3-45
Camera Module Removal . . . . .	3-46
Camera Module Installation . . . . .	3-47
LCD Panel Removal . . . . .	3-48
LCD Panel Installation . . . . .	3-49
LCD Bracket Removal . . . . .	3-50
LCD Bracket Installation . . . . .	3-50
LVDS Cable Removal . . . . .	3-51
LVDS Cable Installation . . . . .	3-52
Microphone Set Removal . . . . .	3-53
Microphone Set Installation . . . . .	3-53
WLAN Antenna Removal . . . . .	3-54
WLAN Antenna Installation . . . . .	3-54

## CHAPTER 4

### Troubleshooting

---

<b>Introduction . . . . .</b>	<b>4-3</b>
<b>General Information . . . . .</b>	<b>4-3</b>
Power On Issues . . . . .	4-4
No Display Issues. . . . .	4-5
LCD Failure . . . . .	4-7
Keyboard Failure . . . . .	4-8
Touchpad Failure . . . . .	4-9
Internal Speaker Failure. . . . .	4-10
Microphone Failure . . . . .	4-12
USB Failure . . . . .	4-13
Wireless Failure. . . . .	4-14
Bluetooth Failure . . . . .	4-15
Card Reader Failure . . . . .	4-16
Thermal Module Failure. . . . .	4-17
Cosmetic Failure . . . . .	4-18
Other Functions Failure . . . . .	4-19
<b>Intermittent Problems . . . . .</b>	<b>4-20</b>
<b>Undetermined Problems . . . . .</b>	<b>4-20</b>
<b>Post Codes . . . . .</b>	<b>4-21</b>



## **CHAPTER 5**

### **Jumper and Connector Locations**

Mainboard Jumper and Connector Locations .....	5-3
USB Board Jumper and Connector Locations.....	5-5
Power Board Jumper and Connector Locations.....	5-6
Clearing Password Check and BIOS Recovery .....	5-7
Clearing Password Check.....	5-7
Clear CMOS Jumper .....	5-8
BIOS Recovery by Crisis Disk.....	5-8

## **CHAPTER 6**

### **FRU (Field Replaceable Unit) List**

Exploded Diagrams .....	6-4
FRU List.....	6-6
Screw List .....	6-21

## **CHAPTER 7**

### **Model Definition and Configuration**

Packard Bell EasyNote TK11BZ/TK13BZ .....	7-3
---	-----

## **CHAPTER 8**

### **Test Compatible Components**

Microsoft® Windows® 7 Environment Test .....	8-4
--	-----

## **CHAPTER 9**

### **Online Support Information**

Introduction .....	9-3
--------------------	-----



# CHAPTER 1

## Hardware Specifications

---

<b>Features</b> .....	<b>1-5</b>
Operating System .....	1-5
Platform .....	1-5
System Memory .....	1-5
Display .....	1-5
Audio Subsystem .....	1-5
Graphics .....	1-6
Storage Subsystem .....	1-6
Privacy Control .....	1-6
Optical Media Drive .....	1-6
Communication .....	1-6
Dimension and Weight .....	1-7
Power Adapter and Battery .....	1-7
Special Keys and Controls .....	1-7
I/O Ports .....	1-7
Optional Items .....	1-8
Warranty .....	1-8
Software .....	1-8
Environment .....	1-9
<b>Notebook Tour</b> .....	<b>1-10</b>
Top View .....	1-10
Closed Front View .....	1-12
Rear View .....	1-13
Left View .....	1-14
Right View .....	1-15
Base View .....	1-16
Touchpad Basics .....	1-17
Using the Keyboard .....	1-18
Windows Keys .....	1-19
Hotkeys .....	1-20
System Block Diagram .....	1-22
<b>Specification Tables</b> .....	<b>1-23</b>
Computer specifications .....	1-23
Processor .....	1-24
Processor Specifications .....	1-25
CPU Fan True Value Table (TJ100-CPU/UMA) .....	1-25
CPU Fan True Value Table (TJ100-CPU/SG) .....	1-25
System Memory .....	1-26
Memory Combinations .....	1-26
Video Interface .....	1-26
BIOS .....	1-27
LAN Interface .....	1-28
Keyboard .....	1-28
Hard Disk Drive (AVL components) .....	1-29
Hard Disk Drive (AVL components) (Continued) .....	1-30
Super-Multi Drive .....	1-31
LED 15.6" .....	1-32

LCD Inverter (not available with this model) . . . . .	1-32
Display Supported Resolution (LCD Supported Resolution) . . . . .	1-33
Display Supported Resolution (GPU Supported Resolution) . . . . .	1-33
Mini Card . . . . .	1-35
3G Card (not available in this model). . . . .	1-35
Audio Codec and Amplifier . . . . .	1-35
Audio Interface . . . . .	1-35
Battery . . . . .	1-37
VRAM. . . . .	1-37
USB Port . . . . .	1-37
AC Adapter. . . . .	1-38
System Power Management . . . . .	1-38
Card Reader. . . . .	1-38
System LED Indicator . . . . .	1-39
System DMA Specification. . . . .	1-39



# Hardware Specifications and Configurations

---

## Features

---

The following is a summary of the computer's many features:

### Operating System

- Genuine Windows® 7 Home Premium 64-bit
- Genuine Windows® 7 Home Basic 64-bit
- Genuine Windows® 7 Starter

### Platform

- AMD E-Series processor E-350 (512 KB / 1 MB L2 cache, 1.60 GHz, DDR3 1066 MHz, 18 W)
- AMD A50M Fusion™ Controller Hub

### System Memory

- Dual-channel DDR3 SDRAM support:
  - Up to 4 GB of DDR3 system memory, upgradable to 8 GB using two soDIMM modules (for 64-bit OS)
  - Up to 2 GB of DDR3 system memory (for Windows® 7 Starter only)

### Display

- 15.6" HD 1366 x 768 resolution, high-brightness (200-nit) Diamond View Technology LED-backlit TFT LCD
- Mercury-free, environment-friendly
- 16:9 aspect ratio

### Audio Subsystem

- High-definition audio support
- Built-in mono speaker
- MS-Sound compatible
- Built-in microphone

## Graphics

- ATI Radeon™ HD 6310 Graphics with 256 MB of dedicated system memory, supporting Unified Video Decoder 3 (UVD3), OpenCL® 1.1, Open GL 3.1, OpenEXR High Dynamic-Range (HDR) technology, Shader Model 5.0, Microsoft® DirectX® 11
- Dual independent display support
- 16.7 million colors
- External resolution / refresh rates:
  - VGA port up to 2560 x 1600: 60 Hz
  - HDMI® port up to 1920 x 1080: 60 Hz
- MPEG-2/DVD decoding
- VC-1 and H.264 (AVC) decoding
- MPEG-4 Part 2 DivX® and Xvid decoding
- HDMI® (High-Definition Multimedia Interface) with HDCP (High-bandwidth Digital Content Protection) support

## Storage Subsystem

### **Hard disk drive:**

- 250/320/500/640/750 GB or larger

### **2-in-1 card reader, supporting:**

- Secure Digital™ (SD) Card, MultiMediaCard™ (MMC)

## Privacy Control

- BIOS user, supervisor, HDD passwords
- Kensington lock slot

## Optical Media Drive

### **8X DVD-Super Multi double-layer drive:**

- Read: 24X CD-ROM, 24X CD-R, 24X CD-RW, 8X DVD-ROM, 8X DVD-R, 8X DVD+R, 6X DVD-ROM DL, 6X DVD-R DL, 6X DVD+R DL, 6X DVD-RW, 6X DVD+RW, 5X DVD-RAM
- Write: 24X CD-R, 16X CD-RW, 8X DVD-R, 8X DVD+R, 4X DVD-R DL, 4X DVD+R DL, 6X DVD-RW, 8X DVD+RW, 5X DVD-RAM

## Communication

### **Video conferencing solution, featuring:**

- Webcam with 1280 x 1024 resolution
- Microphone

### **WLAN:**

- 802.11b/g/n Wi-Fi CERTIFIED™
- 802.11b/g Wi-Fi CERTIFIED™



**WPAN:**

- Bluetooth® 3.0+HS

**LAN:**

- Gigabit Ethernet, Wake-on-LAN ready

## Dimension and Weight

- 381 (W) x 253 (D) x 31/34.14 (H) mm (15 x 9.96 x 1.22/1.34 inches)
- 2.6 kg (5.72 lbs.) with 6-cell battery pack

## Power Adapter and Battery

ACPI 3.0 CPU power management standard: supports Standby and Hibernation power-saving modes

**Power adapter**

- 3-pin 65 W AC adapter:
  - 95 (W) x 50 (D) x 25.4 (H) mm (3.74 x 1.96 x 1 inches)
  - 216 g (0.47 lbs.) with 180 cm DC cable

**Battery**

- 48 Wh 4400 mAh 6-cell Li-ion standard battery pack
- Battery life: 4.5 hours
- ENERGY STAR®

## Special Keys and Controls

**Keyboard**

- 103-/104-/107-key Packard Bell FineTip keyboard with independent standard numeric keypad, international language support

**Touchpad**

- Multi-gesture touchpad, supporting two-finger scroll, pinch, rotate, flip

**Media keys**

- Media control keys (printed on keyboard): play/pause, stop, previous, next, volume up, volume down

## I/O Ports

- 2-in-1 card reader
- Three USB 2.0 ports
- HDMI™ port with HDCP support
- External display (VGA) port
- Headphone/speaker/line-out jack
- Microphone-in jack
- Ethernet (RJ-45) port
- DC-in jack for AC adapter

## Optional Items

- 1/2/4 GB DDR3 1066 MHz soDIMM module
- 4400 mAh 6-cell Li-ion battery pack
- 3-pin 65 W AC adapter

## Warranty

- One-year International Travelers Warranty (ITW)

## Software

### Productivity

- Packard Bell MyBackup Solution
- Packard Bell Power Management
- Packard Bell Recovery Management
- Packard Bell Social Networks
- Adobe® Flash® Player 10.1
- Adobe® Reader® 9.1
- Bing Bar™
- Microsoft® Office 2010 preloaded (purchase a product key to activate)
- Microsoft® Office Starter 2010

### Security

- Norton Internet Security™ 2010

### Multimedia

- Adobe® Photoshop® Elements 8
- Cyberlink® PowerDVD™
- Nero® 9 Essentials

### Gaming

- WildTangent® Packard Bell Edition (except China, Japan, Hong Kong, Korea)

### Communication and ISP

- Microsoft® Silverlight™
- Skype™
- Windows Live™ Essentials

### Web links and utilities

- Packard Bell Accessory Store (Canada, France, Germany, Italy, Mexico, Spain, UK, US only)
- Packard Bell Identity Card
- Packard Bell InfoCenter
- Packard Bell Registration
- Packard Bell Updater
- eBay® shortcut 2009 (Belgium, France, Germany, Italy, Netherlands, Spain, Sweden, UK only)

# Environment

- Temperature:
  - Operating: 5°C to 35°C
  - Non-operating: -20°C to 65°C
- Humidity (non-condensing):
  - Operating: 20% to 80%
- Non-operating: 20% to 80%

# Notebook Tour

## Top View

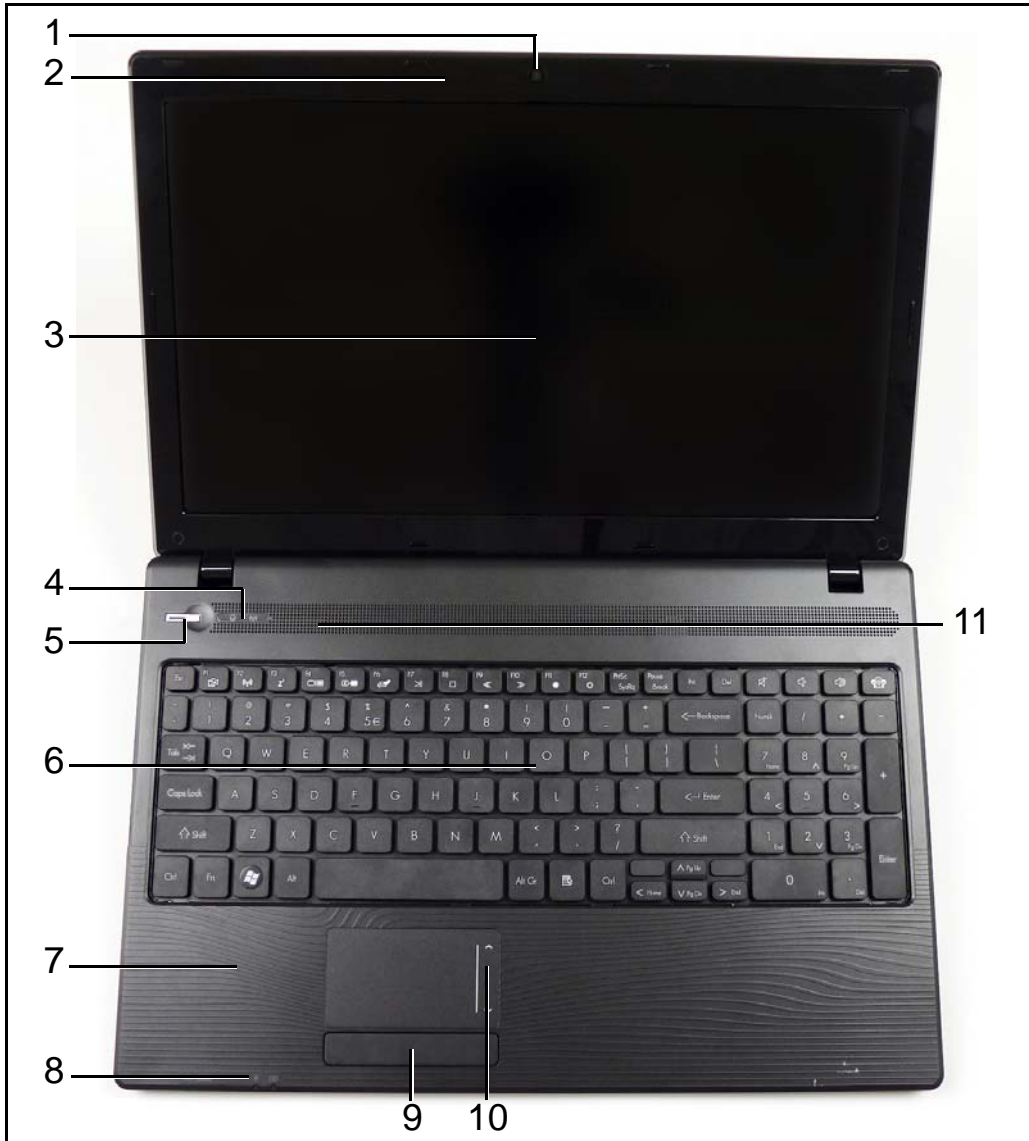







Figure 1-1. Top View

Table 1-1. Top View

#	Icon	Item	Description
1		Webcam	Web camera for video communication (for selected models).
2		Microphone	Internal microphone for recording sound.

**Table 1-1. Top View (Continued)**

#	Icon	Item	Description
3		Display screen	Also called Liquid-Crystal Display (LCD), displays computer output.
4		HDD	Indicates when the hard disk drive is active.
		Communication indicator	Indicates the computer's wireless connectivity device status.
5		Power button	Turns the computer on and off.
6		Keyboard	For entering data into your computer.
7		Palmrest	Comfortable support area for your hands when you use the computer.
8		Power	Indicates the computer's power status.
		Battery	Indicates the computer's battery status. <b>1. Charging:</b> The light shows amber when the battery is charging. <b>2. Fully charged:</b> The light shows blue when in AC mode.
9		Click buttons (left and right)	The left and right buttons function like the left and right mouse buttons.
10		TouchPad	Touch-sensitive pointing device which functions like a computer mouse.
11		Speakers	Left and right speakers deliver stereo audio output.

## Closed Front View

---



Figure 1-2. Closed Front View

Table 1-2. Closed Front View

#	Icon	Item	Description
1		2-in-1 card reader	Accepts Secure Digital (SD), MultiMediaCard (MMC). <b>Note:</b> Push to remove/install the card. Only one card can operate at any given time.

## Rear View

---

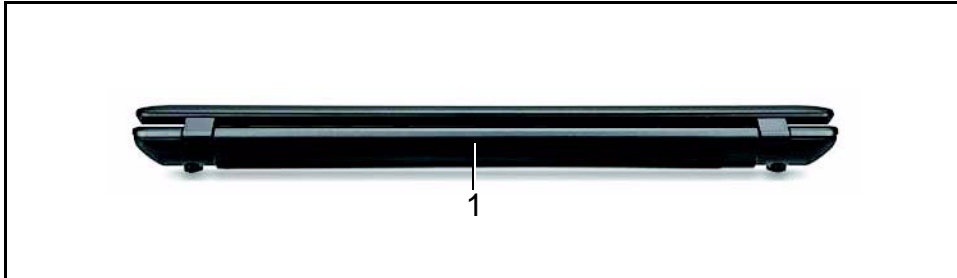

---

**Figure 1-3. Rear View**

**Table 1-3. Rear View**

#	Icon	Item	Description
1		Battery bay	Houses the computer's battery pack.

## Left View

---

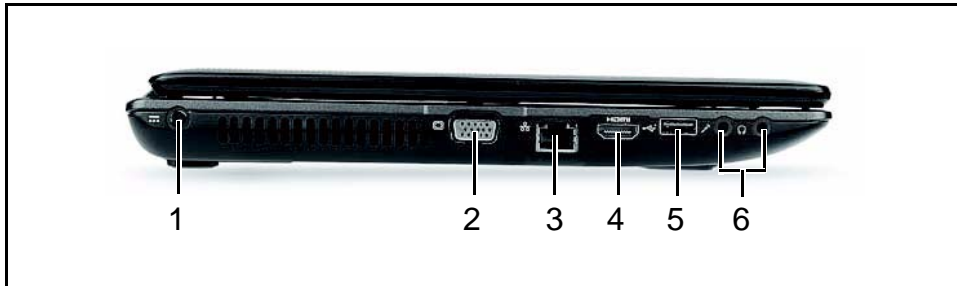









Figure 1-4. Left View

Table 1-4. Left View

#	Icon	Item	Description
1		DC-in jack	Connects to an AC adapter
2		External display (VGA) port	Connects to a display device (e.g. external monitor, LCD projector).
3		Ethernet (RJ-45) port	Connects to an Ethernet 10/100/1000-based network.
4		HDMI	Connect to HDMI devices
5		USB 2.0 ports	Connect to USB 2.0 devices (e.g. USB mouse, USB camera).
6		Microphone-in jack	Accepts input from external microphones.
		Headphones/speaker /line-out jack	Connects to audio line-out devices (e.g. speakers, headphones).



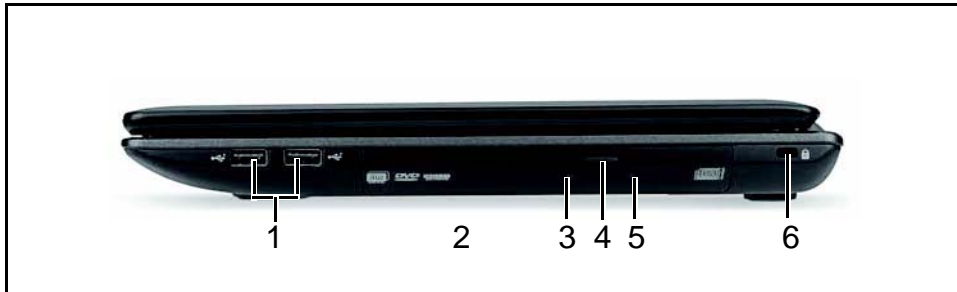

## Right View



**Figure 1-5. Right View**

**Table 1-5. Right View**

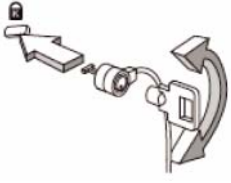
#	Icon	Item	Description
1		USB 2.0 ports	Connect to USB 2.0 devices (e.g. USB mouse, USB camera).
2		Optical drive	Internal optical drive; accepts CDs or DVDs.
3		Optical disk access indicator	Lights up when the optical drive is active.
4		Optical drive eject button	Ejects the optical disk from the drive.
5		Emergency eject hole	Ejects the optical drive tray when the computer is turned off. <b>Note:</b> Insert a paper clip into the emergency eject hole to eject the optical drive tray when the computer is off.
6		Kensington lock slot 	Connects to a Kensington compatible computer security lock. <b>Note:</b> Wrap the computer security lock cable around an immovable object such as a table or handle of a locked drawer. Insert the lock into the notch and turn the key to secure the lock. Some keyless models are also available.

## Base View



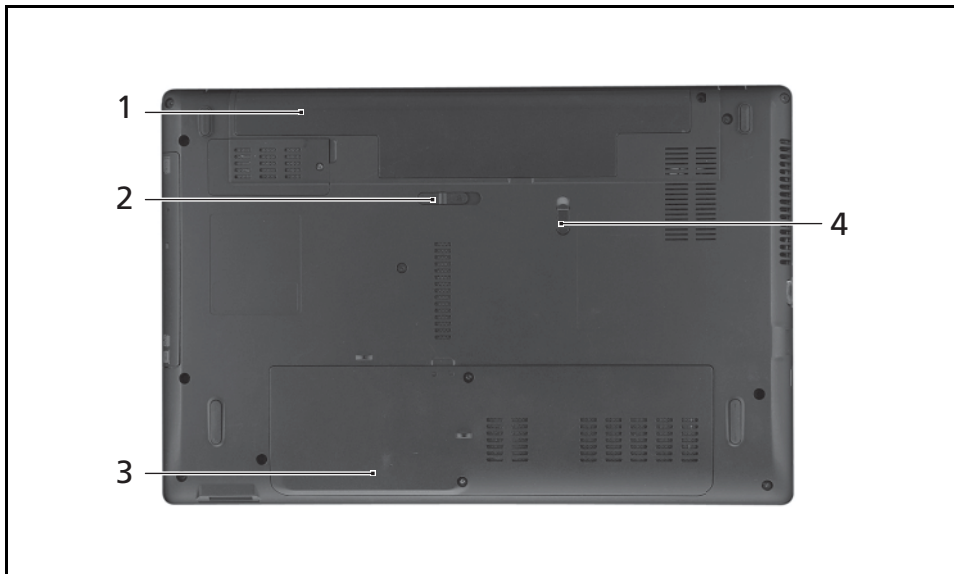

---



---

**Figure 1-6. Base View**

**Table 1-6. Base View**

#	Icon	Item	Description
1		Battery bay	Houses the computer's battery pack.
2		Battery release latch	Releases the battery for removal.
3		Hard disk bay	Houses the computer's hard disk (secured with screws).
		Memory compartment	Houses the computer's main memory.
4		Battery lock	Locks the battery in position.

# Touchpad Basics

---

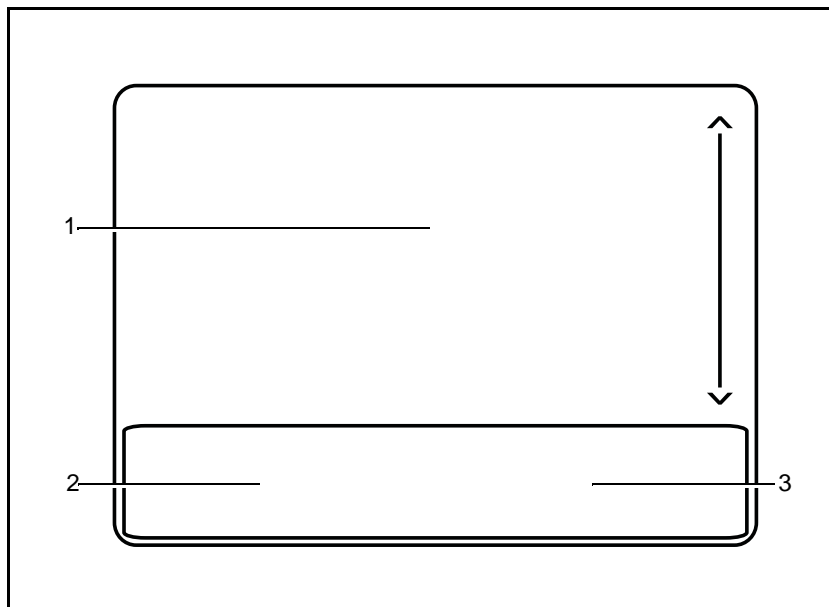

**Figure 1-7. Touchpad**

- Move your finger across the Touchpad (1) to move the cursor.
- Press the left (2) and right (3) buttons located beneath the Touchpad to perform selection and execution functions. These two buttons are the equivalent of the left and right buttons on a mouse. Tapping on the Touchpad is the same as clicking the left button.

**Table 1-7. Touchpad**

Function	Main TouchPad (1)	Left Button (2)	Right Button (3)
Execute	Tap twice (at the same speed as double-clicking a mouse button).	Quickly click twice.	
Select	Tap once.	Click once.	
Drag	Tap twice (at the same speed as double-clicking a mouse button); rest your finger on the TouchPad on the second tap and drag the cursor.	Click and hold, then use finger on the Touchpad to drag the cursor.	
Access context menu			Click once.
<p><b>⇒ NOTE:</b> When using the Touchpad, keep it - and fingers - dry and clean. The Touchpad is sensitive to finger movement; hence, the lighter the touch, the better the response. Tapping too hard will not increase the Touchpad's responsiveness.</p>			

# Using the Keyboard

The computer has a close-to-full-sized keyboard and an embedded numeric keypad, separate cursor, lock, function and special keys.



**Figure 1-8. Keyboard Lock Keys**

## Lock Keys

The keyboard has three lock keys which can be toggled on and off.

**Table 1-8. Keyboard Lock Keys**

Lock key	Description
Caps Lock	When Caps Lock is on, all alphabetic characters typed are in uppercase.
Num Lock	When Num Lock is on, the embedded keypad is in numeric mode. The keys function as a calculator (complete with the arithmetic operators +, -, *, and /). Use this mode when doing a lot of numeric data entry. A better solution would be to connect an external keypad.
Scroll Lock <Fn> + <F12>	When Scroll Lock is on, the screen moves one line up or down when the up or down arrow keys are pressed respectively. Scroll Lock does not work with some applications.

## Embedded Numeric Keypad



The embedded numeric keypad functions like a desktop numeric keypad. It is indicated by small characters located on the upper right corner of the key caps. To simplify the keyboard legend, cursor-control key symbols are not printed on the keys.

**Table 1-9. Embedded Numeric Keypad**















Desired access	Num Lock on	Num Lock off
Number keys on embedded keypad	Type numbers in a normal manner.	
Cursor-control keys on embedded keypad	Hold <Shift> while using cursor-control keys.	Hold <Fn> while using cursor-control keys.
Main keyboard keys	Hold <Fn> while typing letters on embedded keypad.	Type the letters in a normal manner.

# Windows Keys

The keyboard has two keys that perform Windows-specific functions.

-  Windows Logo key
-  Application key

**Table 1-10. Windows Keys**

Key	Description
Windows Logo key	<p>Pressed alone, this key has the same effect as clicking on the Windows Start button; it launches the Start menu. It can also be used with other keys to provide a variety of functions.</p> <p><b>Functions supported by Windows XP, Windows Vista, and Windows 7:</b></p> <p>&lt;&gt;: Open or close the Start menu</p> <p>&lt;&gt; + &lt;R&gt;: Open the Run dialog box</p> <p>&lt;&gt; + &lt;M&gt;: Minimizes all windows</p> <p>&lt;SHIFT&gt; + &lt;&gt; + M: Undo minimize all windows</p> <p>&lt;&gt; + &lt;F1&gt;: Show the help window</p> <p>&lt;&gt; + &lt;E&gt;: Open Windows Explorer</p> <p>&lt;&gt; + &lt;F&gt;: Search for a file or folder</p> <p>&lt;&gt; + &lt;D&gt;: Show the desktop</p> <p>&lt;CTRL&gt; + &lt;&gt; + &lt;F&gt;: Search for computers (if you are on a network)</p> <p>&lt;&gt; + &lt;L&gt;: Lock your computer (if you are connected to a network domain), or switch users (if you're not connected to a network domain)</p> <p>&lt;CTRL&gt; + &lt;&gt; + &lt;TAB&gt;: Moves focus from Start menu, to the Quick Launch toolbar, to the system tray (use RIGHT ARROW or LEFT ARROW to move focus to items on the Quick Launch toolbar and the system tray)</p> <p>&lt;&gt; + &lt;TAB&gt;: Cycle through programs on the taskbar</p> <p>&lt;&gt; + &lt;BREAK&gt;: Display the System Properties dialog box</p> <p><b>Functions supported by Windows XP:</b></p> <p>&lt;&gt; + &lt;BREAK&gt;: Show the System Properties dialog box</p> <p>&lt;&gt; + &lt;U&gt;: Open Ease of Access Center</p>
Application key	This key has the same effect as clicking the right mouse button; it opens the application's context menu.

# Hotkeys

The computer employs hotkeys or key combinations to access most of the computer's controls like screen brightness and volume output.

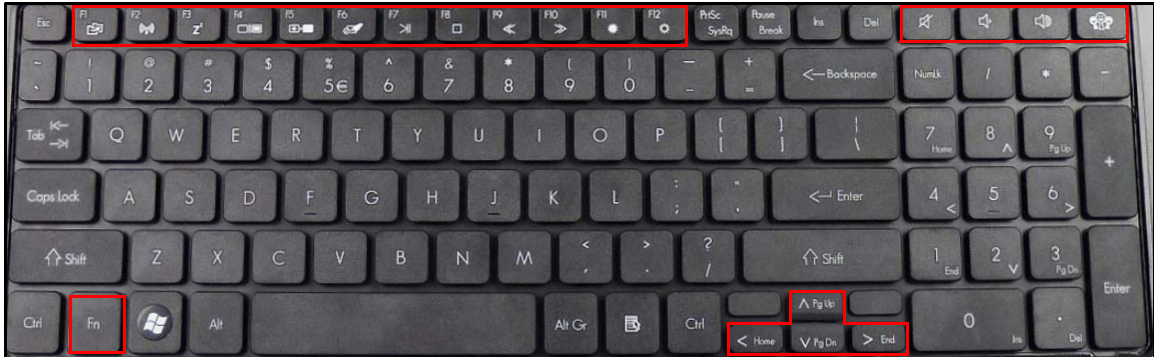







**Figure 1-9. Keyboard Hotkeys**

To activate hotkeys, press and hold the <Fn> key before pressing the other key in the hotkey combination.

**Table 1-11. Keyboard Hotkeys**

Hot key	Icon	Function	Description
<Fn> + <F1>		Backup Management	Launches the backup application.
<Fn> + <F2>		Communication Device On/Off	Toggles WiFi, 3G and Bluetooth on and off using a pop-up window.
<Fn> + <F3>		Sleep	Puts the computer in Sleep mode.
<Fn> + <F4>		Display toggle	Switches display output between the display screen, external monitor (if connected) and both.
<Fn> + <F5>		Display off	Turns off the LCD back light.
<Fn> + <F6>		Touchpad toggle	Turns the touchpad on and off.
<Fn> + <F7>		Play/Pause	Toggles Play and Pause in multimedia applications.
<Fn> + <F8>		Stop	Stops media in multimedia applications.
<Fn> + <F9>		Reverse	Performs a reverse scan in multimedia applications.

**Table 1-11. Keyboard Hotkeys (Continued)**

Hot key	Icon	Function	Description
<Fn> + <F10>		Forward	Performs a forward scan in multimedia applications.
<Fn> + <F11>		Brightness Down	Decreases the screen brightness.
<Fn> + <F12>		Brightness Up	Increases the screen brightness.
		Social Networking Key	Launches a social networking website (user configurable).
		Volume Up	Increases the sound volume.
		Volume Down	Decreases the sound volume.
		Speaker toggle	Turns the speakers on and off.

# System Block Diagram

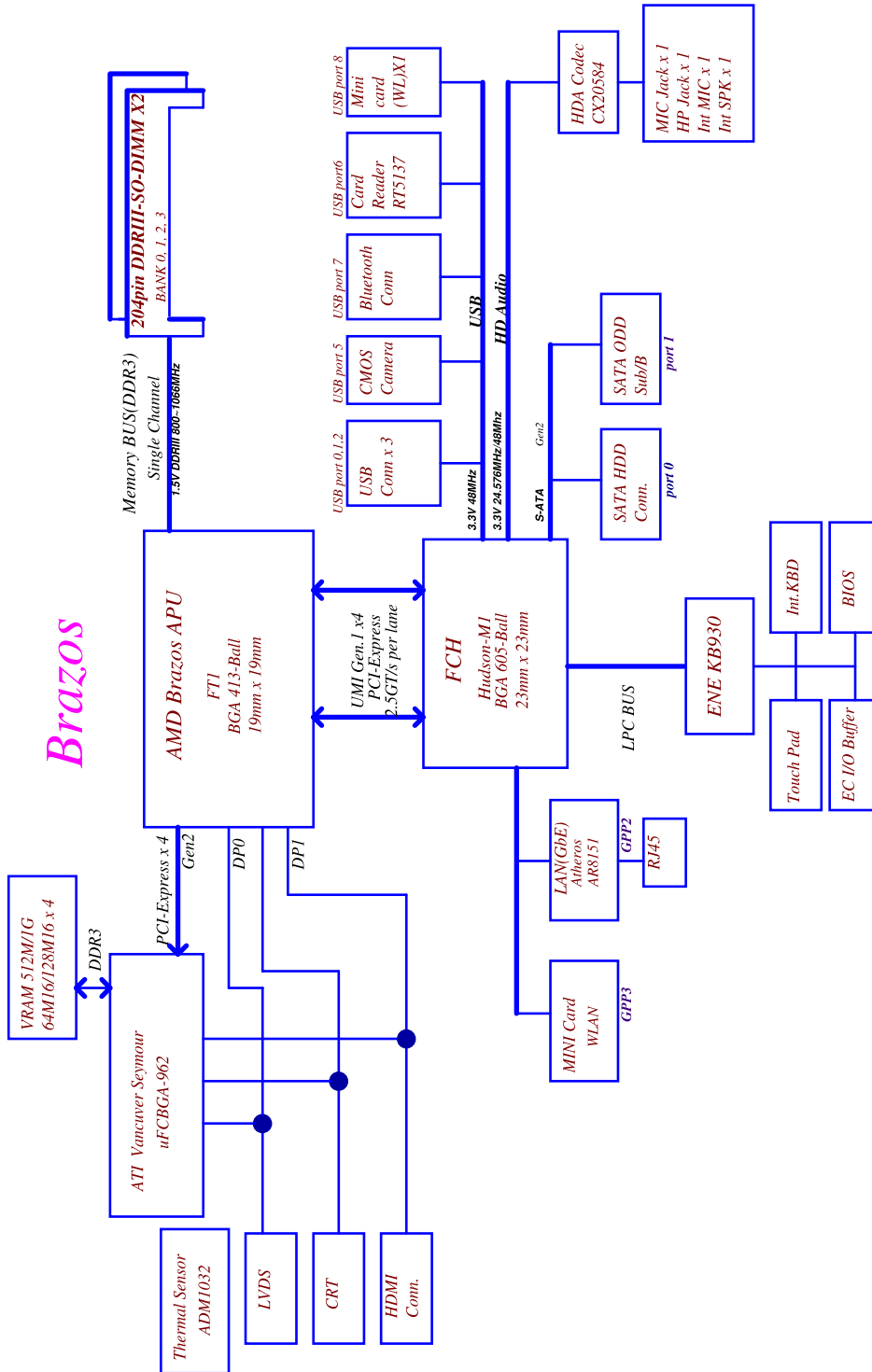

Figure 1-10. System Block Diagram



# Specification Tables

## Computer specifications

Item	Metric	Imperial
Dimensions		
Length	26.0 cm	10.23 in
Width	35.7 cm	14.05 in
Height (front to rear)	3.0 to 3.6 cm	1.16 to 1.43 in
Weight (equipped with optical drive, flash drive, and battery)	2.54 kg	5.6 lbs
Weight (equipped with optical drive, flash drive, and without battery)	2.32 kg	4.78lbs
Input power		
Operating voltage	19.0 V dc @ 3.42 A - 65 W	
Operating current	3.42 A	
Temperature		
Operating (not writing to optical disc)	0°C to 35°C	32°F to 95°F
Operating (writing to optical disc)	5°C to 35°C	41°F to 95°F
Nonoperating	-20°C to 60°C	-4°F to 140°F
Relative humidity		
Operating	10% to 90%	
Nonoperating	5% to 95%	
Maximum altitude (unpressurized)		
Operating	-15 m to 3,048 m	-50 ft to 10,000 ft
Nonoperating	-15 m to 12,192 m	-50 ft to 40,000 ft
Shock		
Operating	125 g, 2 ms, half-sine	
Nonoperating	200 g, 2 ms, half-sine	
Random vibration		
Operating	0.75 g zero-to-peak, 10 Hz to 500 Hz, 0.25 oct/min sweep rate	
Nonoperating	1.50 g zero-to-peak, 10 Hz to 500 Hz, 0.25 oct/min sweep rate	
<b>⇒ NOTE:</b> Applicable product safety standards specify thermal limits for plastic surfaces. The computer operates well within this range of temperatures.		

## System Board Major Chips

Item	Specification
Core logic	AMD Hudson M1 uFCBGA-605-ball
VGA	ATI Mobility Radeon™ HD 6310M APU ATI Mobility Radeon™ HD 6470M GPU
LAN	Atheros AR8151 for Giga LAN Controller
USB 2.0	AMD Hudson M1
USB 3.0	N/A
Super I/O controller	AMD Hudson M1
Bluetooth	Atheros BU12/ Broadcom BCM2070
Wireless	Atheros HB95/ HB97, Broadcom 43225
PCMCIA	N/A
Audio codec	Conexant CX20584
Card reader	Realtek RTS-5137
eSata	N/A

## Processor

Item	Specification
CPU type	AMD E350(1.6G dual core), E240(1.5G single core)
CPU package	FT1 BGA 413-ball
Core Logic	Two execution cores <ul style="list-style-type: none"><li>• A 32-KB instruction and 32-KB data first-level cache (L1) for each core</li><li>• A 256-KB shared instruction/data second-level cache (L2) for each core</li><li>• Up to 4-MB shared instruction/data third-level cache (L3), shared among all cores</li></ul>
Chipset	AMD Hudson M1

## Processor Specifications

Item	CPU Speed (GHz)	Cores/Threads	Bus Speed	Mfg Tech (nm)	Cache Size	Package	Voltage
E-350	1.6 GHz	2 Cores	APU	40 nm	1 MB	FT1	0.8-1.25V
E-350	1.6 GHz	1 Cores	APU	40 nm	512 KB	FT1	0.8-1.25V

### CPU Fan True Value Table (TJ100-CPU/UMA)

CPU Temperature (°C)	Fan Speed (RPM)	SPL Spec (dBA)
50	0	0
56	2200	28
63	2400	31
70	2600	34
75	2900	37
95	3200	40
98	3200	40

P-state throttling 50%: On= 95°C; OFF=87°C  
 Prochot throttling 50%: On= 98°C; OFF=87°C  
 OS shut down at 100°C; H/W shut down at 92°C

### CPU Fan True Value Table (TJ100-CPU/SG)

CPU Temperature (°C)	Fan Speed (RPM)	SPL Spec (dBA)
50	0	0
56	2200	28
63	2400	31
70	2600	34
75	2900	37
95	3200	40
98	3200	40

P-state throttling 50%: On= 95°C; OFF=87°C  
 Prochot throttling 50%: On= 98°C; OFF=87°C  
 OS shut down at 100°C; H/W shut down at 92°C

## System Memory

Item	Specification
Memory controller	Built in at APU
Memory size	512MB,1GB,2GB,4GB DDR3 RAM
DIMM socket number	2
Supports memory size per socket	4 GB
Supports maximum memory size	8 GB
Supports DIMM type	Support DDR III 800/1066Mhz SDRAM memory interface design
Supports DIMM Speed	800/1066Mhz SDRAM
Support DIMM voltage	1.5V
Supports DIMM package	204pin DDRIII-SO-DIMM

## Memory Combinations

Slot 1 (MB)	Slot 2 (MB)	Total Memory (MB)
512	512	1024
0	1024	1024
1024	0	1024
1024	1024	2048
0	2048	2048
2048	0	2048
2048	2048	4096
0	4096	4096
4096	0	4096
4096	4096	8192

## Video Interface

Item	Specification
Chipset	AMD Radeon™ HD 6310 Graphics
Package	BGA 413-Ball (19mmX19mm)
Interface	LVDS
Compatibility	Fully compliant with the electrical specifications of ANSI/TIA/EIA-644
Sampling rate	60MHz

## BIOS

Item	Specification
BIOS vendor	Insyde
BIOS Version	1.00
BIOS ROM type	MX25L1606EM2I-12G, EN25F16-100HIP, W25Q16BVSSIG
BIOS ROM size	2MB
Features	<ul style="list-style-type: none"><li>● Insyde code base</li><li>● Flash ROM 2 MB</li><li>● Support Acer UI</li><li>● Support multi-boot</li><li>● Suspend to RAM (S3)/Disk (S4)</li><li>● Various hot-keys for system control</li><li>● Support SMBIOS 2.5,PCI2.1.</li><li>● DMI utility for BIOS serial number configurable/asset tag</li><li>● Support PXE</li><li>● Support WinFlash</li><li>● Wake on LAN from S3</li><li>● Wake on LAN from S5 in AC mode</li><li>● System information</li><li>● HDD password</li><li>● Refer to Acer BIOS specification.</li></ul>

## LAN Interface

Item	Specification
LAN Chipset	AR8151
LAN connector type	RJ45
LAN connector location	JRJ45 at the left side
Features	Supports 10/100/1000

## Keyboard

Item	Specification
Type	Acer 2010 AC7T flat keyboard
Total number of keypads	103-US/104-UK & 107-JP keys
Windows logo key	Yes
Internal & external keyboard work simultaneously	Plug USB keyboard to the USB port directly: Yes
Features	<ul style="list-style-type: none"><li>• Phantom key auto detect</li><li>• Overlay numeric keypad</li><li>• Support independent pgdn/pgup/pgup/home/end keys</li><li>• Support reverse T cursor keys</li><li>• Factory configurable different languages by OEM customer</li></ul>

## Hard Disk Drive (AVL components)

Item	Specification		
Vendor & Model Name	HTS545016B9A300 MK1665GSX ST9160314AS WD1600BPVT-22ZEST0	HTS545025B9A300 MK2565GSX ST9250315AS WD2500BPVT-22ZEST0	HTS545032B9A300 MK3265GSX ST9320310AS WD3200BPVT-22ZEST0
Capacity (GB)	160	250	320
Bytes per sector	512, 512, 512, 4096	512, 512, 512, 4096	512, 512, 512, 4096
Data heads	2, 1, 2, 1	2, 2, 2, 1	3, 2, 2, 2
Drive Format			
Disks	1	1	2, 1, 1, 1
Spindle speed (RPM)	5400		
Performance Specifications			
Buffer size	8MB		
Interface	SATA		
Fast data transfer rate (Gbits / sec, max)	3.0	3.0	3.0
Media data transfer rate (Mbytes/sec max)	106, 105.6, 159.2, 146.9, 108	106, 105.6, 129, 146.9, 108	106, 105.6, 159.1, 146.9, 108
DC Power Requirements			
Voltage tolerance	5V ±5%		

### Hard Disk Drive (AVL components) (Continued)

Item	Specification		
Vendor & Model Name	HTS545050B9A300 MK5065GSX ST9500325AS WD3200BPVT-22ZEST0	MK6465GSX WD6400BPVT-22HXZT1	MK7559GSXP WD7500BPVT-22HXZT1
Capacity (GB)	500	640	750
Bytes per sector	512, 512, 512, 4096	512, 4096	4096
Data heads	4, 4, 4, 3	4	4
Drive Format			
Disks	2	2	2
Spindle speed (RPM)	5400		
Performance Specifications			
Buffer size	8MB		
Interface	SATA		
Fast data transfer rate (Gbits / sec, max)	3.0	3.0	3.0
Media data transfer rate (Mbytes/sec max)	106, 105.6, 159.2, 146.9, 97	159.2, 97	170.4, 97
DC Power Requirements			
Voltage tolerance	5V ±5%		



## Super-Multi Drive

Item	Specification	
Vendor & Model name	HLDS Super-Multi Drive DL 8X GT32N LF / SONY Super-Multi Drive DL 8X AD-7585H LF / Panasonic Super-Multi Drive DL 8X UJ890 / PLDS Super-Multi Drive DL 8X DS-8A5SH / HLDS Super-Multi Drive DL 8X GT34N LF / PIONEER Super-Multi Drive DL 8X DVR-TD10RS LF / Panasonic Super-Multi Drive DL 8X UJ8A0 / TSST Super-Multi Drive DL 8X TS-L633F	
Performance Specification	With CD Diskette	With DVD Diskette
Transfer rate (KB/sec)	Sustained: Max 3.6 (24x)	Sustained: Max 10.08Mbytes/sec
Buffer Memory	2MB	
Interface	SATA	
Applicable disc format	<p>CD: CD-DA, CD-ROM, CD-ROM XA, Photo CD (multi-session), Video CD, Cd-Extra (CD+), CD-text DVD: DVD-VIDEO, DVD-ROM, DVD-R (3.9GB, 4.7GB) DVD-R DL, DVD-RW, DVD-RAM, DVD+R, DVD+R DL, DVD+RW CD: CD-DA (Red Book) - Standard Audio CD &amp; CD-TEXT CD-ROM (Yellow Book Mode1 &amp; 2) - Standard Data CD-ROM XA (Mode2 Form1 &amp; 2) - Photo CD, Multi-Session CD-I (Green Book, Mode2 Form1 &amp; 2, Ready, Bridge) CD-Extra/ CD-Plus (Blue Book) - Audio &amp; Text/Video Video-CD (White Book) - MPEG1 Video CD-R (Orange Book Part) CD-RW &amp; HSRW (Orange Book Part Volume1 &amp; Volume 2 Super Audio CD (SACD) Hybrid type US &amp; US+ RW</p> <p>DVD: DVD-ROM (Book 1.02), DVD-Dual DVD-Video (Book 1.1) DVD-R (Book 1.0, 3.9G) DVD-R (Book 2.0, 4.7G) - General &amp; Authoring DVD+R (Version 1.0) DVD+RW DVD-RW (Non CPRM &amp; CPRM) DVD-R Dual</p>	
Loading mechanism	Load: Manual Release: (a) Electrical Release (Release Button) (b) Release by ATAPI command (c) Emergency Release	
<b>Power Requirements</b>		
Input Voltage	5 V +/- 5% (Operating)	

**LED 15.6”**

Item	Specification
Vendor & Model name	AUO/B156XW02 V6 (HW:0A) AUO/B156XW02 V2 (HW:4A) Samsung/LTN156AT02-A11 LG/LP156WH2-TLEA CMO/N156B6-L0B CPT/ CLAA156WB11A
Screen Diagonal (mm)	394.91 mm
Active Area (mm)	344.23 mm x 193.54 mm
Display resolution (pixels)	1366 x 3(RGB) x 768
Pixel Pitch (mm)	0.252mm x 0.252 mm
Typical White Luminance (cd/m <sup>2</sup> ) also called Brightness	200 cd/m <sup>2</sup>
Contrast Ratio	400 min / 500 type
Response Time (Optical Rise Time/Fall Time) msec	8 ms / 16 ms
Typical Power Consumption (watt)	5.15 W
Weight (without inverter)	460 max
Physical Size (mm)	360 mm x 210mm x 5.5 max
Electrical Interface	1 channel LVDS
Viewing Angle (degree) Horizontal (Right) CR = 10 (Left) Vertical (Upper) CR = 10 (Lower)	40 (Right) / 40 (Left) / 10 (Upper) / 30 (Lower) min.

**LCD Inverter (not available with this model)**

Item	Specification
Vendor & Model name	
Brightness conditions	
Input voltage (v)	
Input current (mA)	
Output voltage (V, RMS)	
Output current (mA, RMS)	
Output voltage frequency (KHz)	

### Display Supported Resolution (LCD Supported Resolution)

Resolution	16 bits	32 bits	ATI
800x600p/60Hz 4:3	Yes	Yes	Yes
1024x768p/60Hz 4:3	Yes	Yes	Yes
1280x720/60Hz 16:9	Yes	Yes	Yes
1280x768/60Hz 16:10	Yes	Yes	Yes
1360x768/60Hz 16:9	Yes	Yes	Yes
1366x768/60Hz 16:9	Yes	Yes	Yes
2048x1536:85Hz (AS5253G Only)	Yes	Yes	Yes
2560x1620: 60Hz (AS5253 Only)	Yes	Yes	Yes

### Graphics Controller

Item	Specification	
	UMA	PX
VGA Chip	AMD APU integrated VGA	AMD Seymour
Supports	<ul style="list-style-type: none"><li>• Supports for DX11, UVD3.0, OpenGL 1.1</li><li>• GPU core derived from the Manhattan family</li><li>• Internal LVDS support via DP0</li></ul>	<ul style="list-style-type: none"><li>• Supports for DX11, UVD3.0, OpenGL 1.1</li><li>• Support for OpenGL® 3.1</li><li>• Multiple display support</li><li>• Four independent display controllers that support true 30-bpp</li><li>• Support for display resolutions up to 4096 × 2304 @ 30 Hz per display output</li><li>• Supports 2.5 GT/s and 5.0 GT/s link-data rates.</li></ul>

### Display Supported Resolution (GPU Supported Resolution)

Resolution	16 bits	32 bits	ATI
800x600p/60Hz 4:3	Yes	Yes	Yes
1024x768p/60Hz 4:3	Yes	Yes	Yes
1280x720/60Hz 16:9	Yes	Yes	Yes
1280x768/60Hz 16:10	Yes	Yes	Yes
1360x768/60Hz 16:9	Yes	Yes	Yes
1366x768/60Hz 16:9	Yes	Yes	Yes
2048x1536:85Hz (AS5253G Only)	Yes	Yes	Yes
2560x1620: 60Hz (AS5253 Only)	Yes	Yes	Yes

## Bluetooth Interface

Item	Specifications
Chipset	Atheros BU12/ Broadcom BCM2070/ Broadcom
Data throughput	TX 1.2Mbits/sec RX 1.2Mbits/sec
Protocol	3.0+HS
Interface	USB 2.0
Connector type	SM06B-XSRK-ETB
Supported protocol	USB 1.1

## Bluetooth Module

Item	Specifications
Controller	Atheros BU12/ Broadcom BCM2070/ Broadcom
Feature	<ul style="list-style-type: none"><li>• Mini USB module with built-in antenna</li><li>• Bluetooth 3.0</li></ul>

## Camera

Item	Specification		
Vendor & Model	Chicony CNF9157	Lite-on 09P2SF119	Suyin HF1315-S32B-OV01
Type	1.3M		

### Mini Card

Item	Specification
Number supported	1
Features	1 mini card slot (for WLAN or WLAN/WiMax)

### 3G Card (not available in this model)

Item	Specification
Features	

### Audio Codec and Amplifier

Item	Specification
Audio Controller	Conexant CX20584
Features	<ul style="list-style-type: none"><li>• Two stereo DAC support 16/20/24-bit PCM for two independent playback (multiple streaming)</li><li>• Two stereo ADC supports 16/20/24-bit PCM format for two independent recording</li><li>• All DACs support independent 44.1k/48k/96k/192kHz sample rate</li><li>• All ADCs support independent 44.1k/48k/96k/192kHz sample rate</li><li>• Two independent SPDIF outputs support 16/20/24-bit format and 44.1k/48k/88.2k/96k/192kHz rate</li><li>• Supports line level mono output</li><li>• Supports analog PCBEEP input, and features an integrated digital BEEP generator</li><li>• Support two stereo digital microphone input for microphone array AEC/BF application</li><li>• Supports legacy analog mixer architecture</li><li>• Supports two GPIO (General Purpose Input/Output) pins (pin sharing with digital microphone interface)</li><li>• Supports EAPD (External Amplifier Power Down) control for external amplifier</li><li>• Supports anti-pop mode when analog power AVDD is on and digital power is off</li><li>• Supports 1.5V~3.3V scalable I/O for HD Audio link</li><li>• 48-pin QFN 'Green' package</li></ul>

### Audio Interface

Item	Specification
Audio Controller	Conexant CX20584
Audio onboard or optional	On board
Mono or Stereo	Mono

Item	Specification
Resolution	Support 16/24bit PCM
Compatibility	HD audio Interface
Sampling rate	Sample rate up to 192Khz resolution VSR (Variable Sampling Rate)
Internal microphone	Yes
Internal speaker/quantity	Yes/(2W speakers x1)

#### **Wireless Module 802.11b/g/n**

Item	Specification
Chipset	Atheros HB95/ HB97, BCM943225
Data throughput	11~54 Mbps, up to 270 Mbps for Draft-N
Protocol	802.11 b+g, Draft-N
Interface	PCI bus (mini PCI socket for wireless module)

## Battery

Item	Specification	
Vendor & Model name	SANYO AS2010D31 SIMPLO AS10D71/75 SONY AS2010D41 SAMSUNG AS2010D61 PANASONIC AS10D51	PANASONIC AS10D56
Battery Type	Li-ion	
Pack capacity	2200 mAh	2900 mAh
Number of battery cell	6	4
Package configuration	3S2P	4S1P

## VRAM

Item	Specification
Chipset	Seymour
Memory size	512MB
Interface	PCIE GENII

## USB Port

Item	Specification
USB compliance level	USB2.0
EHCI	2
Number of USB port(s)	3
Location	one left side, two right side
Output Current	2.0A for the one USB port in left side 2.0A for the two USB port in right side

## HDMI Port

Item	Specification
Compliance level	HDMI1.3a
Data throughput	Up to 16.7 million colors
Number of HDMI port(s)	1
Location	JHDMI1 at the left side

## AC Adapter

Item	Specification
Input rating	65w
Maximum input AC current	65w:3.42A at 100V
Inrush current	12t at 264V
Efficiency	Refer to EPA 5.0

## System Power Management

Item	Specification
Mech. Off (G3)	All devices in the system are turned off completely.
Soft Off (G2/S5)	OS initiated shutdown. All devices in the system are turned off completely.
Working (G0/S0)	Individual devices such as the CPU and hard disc may be power managed in this state.
Suspend to RAM (S3)	CPU set power down VGA Suspend PCMCIA Suspend Audio Power Down Hard Disk Power Down CD-ROM Power Down Super I/O Low Power mode
Save to Disk (S4)	Also called Hibernation Mode. System saves all system states and data onto the disc prior to power off the whole system.

## Card Reader

Item	Specification
Chipset	Realtek RTS5137-GR
Package	QFN 48P
Maximum supported size	SD: 16G MMC: 16G miniSD: 16G
Features	2 in 1 card reader, supporting: <ul style="list-style-type: none"><li>Secure Digital™ (SD) Card, MultiMediaCard™ (MMC)</li><li>Storage cards with adapter: miniSD™</li></ul>



## System LED Indicator

Item	Specification
Lock	N/A
System state	<ul style="list-style-type: none"> <li>• Blue color solid on: System on</li> <li>• Blue color and amber color off: System off</li> <li>• Amber color blinking: S3 state</li> </ul>
HDD access state	Reflects the activities of the HDD or Card reader access
Wireless state	Amber color if a wireless device is active
Power button backlight	<ul style="list-style-type: none"> <li>• Blue color solid on: System on</li> <li>• Blue color off: System off</li> </ul>
Battery state	Charging <ul style="list-style-type: none"> <li>• Amber solid on - Battery charging with AC</li> <li>• Blue color solid on - Battery full</li> <li>• Amber blinking - Battery abnormal stop charge or batter in low power state</li> </ul> Discharging <ul style="list-style-type: none"> <li>• Amber and blinking - Battery in critical low state</li> <li>• Amber color off - Discharging state</li> </ul>

## System DMA Specification

Legacy Mode	Power Management
DMA0	Not applicable
DMA1	Not applicable
DMA2	Not applicable
DMA3	Not applicable
DMA4	Direct memory access controller
DMA5	Available for ExpressCard
DMA6	Not Assigned
DMA7	Not Assigned
*ExpressCard controller can use DMA 1, 2, or 5.	

## System Interrupt Specification

Hardware IRQ	System Function
IRQ0	High precision event timer
IRQ1	Standard PS/2 Keyboard
IRQ2	Cascaded
IRQ8	High precision event timer
IRQ11	Ethernet controller
IRQ12	PS/2 compatible mouse
IRQ13	Numeric data processor
IRQ14	Primary IDE channel
IRQ15	Secondary IDE channel
IRQ16	High definition audio controller PCI-E standard root port PCI standard PCI-to-PCI bridge
IRQ17	Standard Enhanced PCI to USB host controller
IRQ18	Standard OpenHCD USB host controller
IRQ19	High definition audio controller Standard AHCI 1.0 serial ATA controller Wireless network adapter
IRQ81 - IRQ190	Microsoft ACPI-compliant system

## System IO Address Map

I/O address (hex)	System function (shipping configuration)
000 - 00F	DMA controller no. 1
010 - 01F	Unused
020 - 021	Interrupt controller no. 1
022 - 03F	Unused
040 - 043	Counter/timer registers
060	Keyboard controller
061	Speaker controller
062 - 063	Unused
064	Keyboard controller
065 - 06F	Unused
070 - 071	CMOS/RTC
072 - 073	Alternate RTC address port / data port
074 - 080	Unused
081 - 08F	DMA page registers
090 - 091	Unused
092	FAST INIT register
093 - 09F	Unused
0A0 - 0A1	Interrupt controller no. 2
0A2 - 0BF	Unused
0C0 - 0DF	DMA controller no. 2
0E0 - 0EF	Unused
0F0 - 0FF	Numeric data processor
100 - 3AF	Unused
3B0 - 3BB	VGA
3BC - 3BF	Unused
3C0 - 3DF	VGA
3E0 - 40A	Unused
40B	DMA1 Extend
40C - 4CF	Unused
4D0	Interrupt edge control
4D1 - 4D5	Unused

## System I/O Address Specifications

I/O address (hex)	System function (shipping configuration)
4D6	DMA2 extend register
4D7 - 4FF	Unused
C00 - C01	PCI interrupt register
C14	PCI error register
C50 - C51	Client management register
C52	GPM port
C6F	ISA MISC register
CD0 - CD1	Power management 2 register
CD4 - CD5	BIOS RAM register
CD6 - CD7	Power management register

# CHAPTER 2

## System Utilities

---

<b>BIOS Setup Utility</b> .....	<b>2-3</b>
Navigating the BIOS Utility .....	2-3
<b>BIOS</b> .....	<b>2-4</b>
Information .....	2-4
Main .....	2-6
Security .....	2-8
Boot .....	2-12
Exit .....	2-13
<b>BIOS Flash Utilities</b> .....	<b>2-14</b>
DOS Flash Utility .....	2-15
WinFlash Utility .....	2-17
<b>Remove HDD/BIOS Password Utilities</b> .....	<b>2-18</b>
Removing BIOS Passwords .....	2-20
Cleaning BIOS Passwords .....	2-22
<b>Miscellaneous Tools</b> .....	<b>2-23</b>
Using Boot Sequence Selector .....	2-23
Using DMITools .....	2-24
Using the LAN MAC EEPROM Utility .....	2-25
Crisis Disk Recovery .....	2-26

# System Utilities

---

## BIOS Setup Utility

---

This utility is a hardware configuration program built into a computer's BIOS (Basic Input/Output System).

The utility is pre-configured and optimized so most users do not need to run it. If configuration problems occur, the setup utility may need to be run. Refer to [Chapter 4, Troubleshooting](#) when a problem arises.

To activate the utility, press **F2** during POST (power-on self-test) when prompted at the bottom of screen.

The default parameter of `F12 Boot Menu` is set to `Disabled`. To change the boot device without entering *BIOS Setup Utility*, set the parameter to `Enabled`.

To change the boot device without entering the BIOS SETUP, press **F12** during POST to enter the multi-boot menu.

## Navigating the BIOS Utility

---

Six menu options are:

- Information
- Main
- Security
- Boot
- Exit

To navigate through the following:

- Menu - use the left and right arrow keys
- Item - use the up and down arrow keys
- Change parameter value - press **F5** or **F6**.
- Exit - Press **Esc**
- Load default settings - press **F9**. Press **F10** to save changes and exit BIOS Setup Utility

### ⇒ NOTE:

Parameter values can be changed if enclosed in square brackets [ ]. Navigation keys appear at the bottom of the screen. Read parameter help carefully when making changes to parameter values. Parameter help is found in the Item Specific Help area of the screen.

### ⇒ NOTE:

System information is subject to specific models.

# BIOS

The following is a description of the tabs found on the InsydeH20 *BIOS Setup Utility* screen:

⇒ **NOTE:**

The screens provided are for reference only. Actual values may differ by model.

## Information

The Information tab shows a summary of computer hardware information.

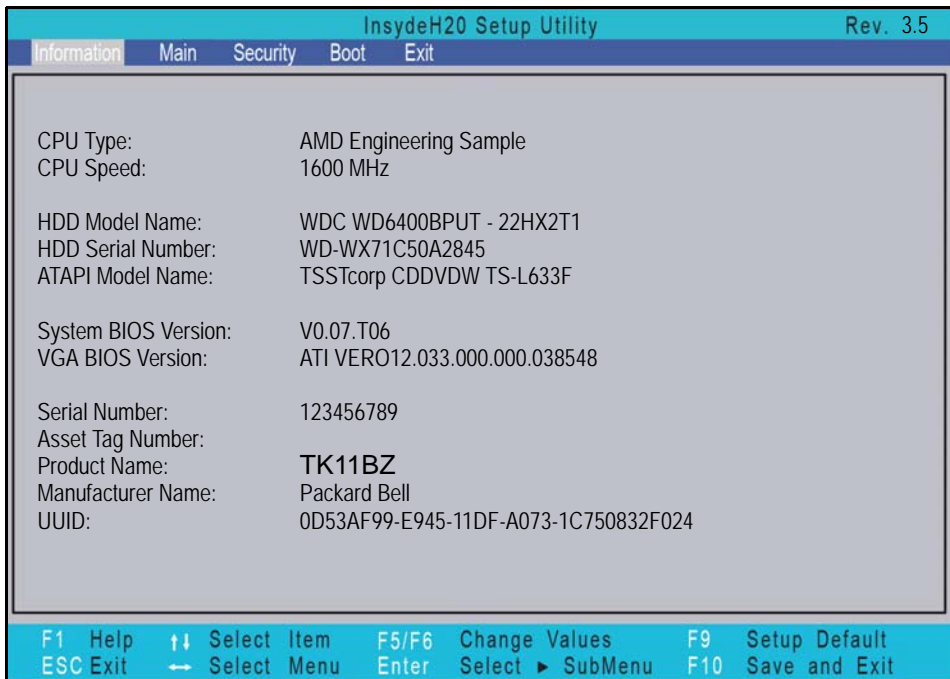

**Figure 2-1. BIOS Information**

Table 2-1 describes the parameters shown in Figure 2-1

**Table 2-1. BIOS Information**

Parameter	Description
CPU Type	CPU (central processing unit) type and speed of system
CPU Speed	Speed of the CPU
HDD Model Name	Model name of HDD0 (hard disk drive) installed on primary IDE master
HDD Serial Number	Serial number of HDD0 installed on primary IDE master
ATAPI Model Name	Model name of Optical device installed in system
System BIOS Version	System BIOS version

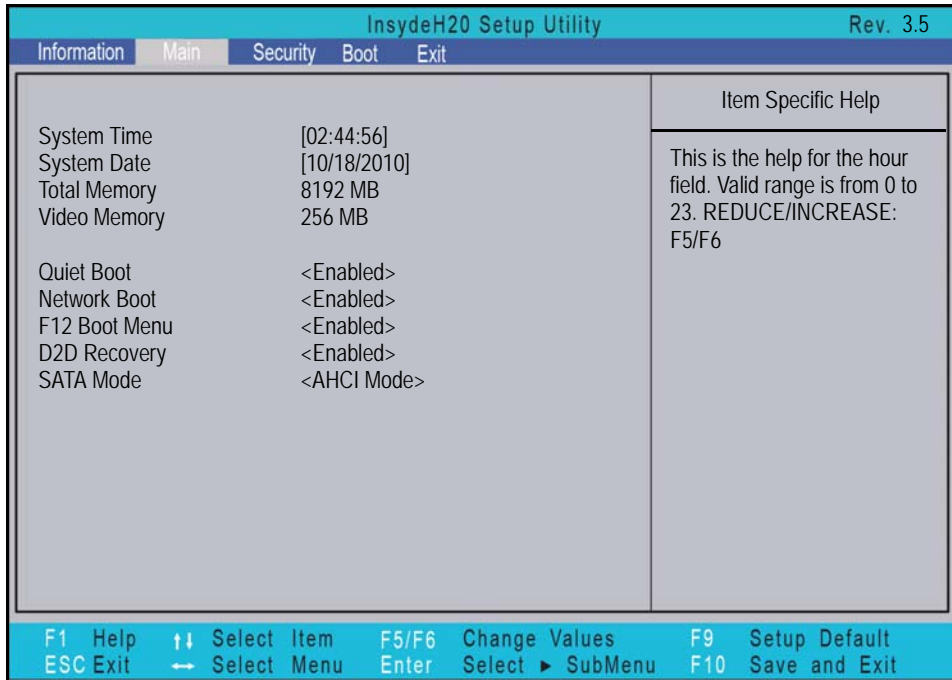

**Table 2-1. BIOS Information (Continued)**

<b>Parameter</b>	<b>Description</b>
VGA BIOS Version	VGA (video graphics array) firmware version of system
Serial Number	Serial number of unit
Asset Tag Number	Asset tag number of system
Product Name	Product name of the system
Manufacturer Name	Manufacturer of system
UUID	Universally Unique Identifier

# Main

The Main tab allows the user to set system time and date, enable or disable boot option and enable or disable recovery.



**Figure 2-2. BIOS Main**

Table 2-2 describes the parameters shown in Figure 2-2

**Table 2-2. BIOS Main**

Parameter	Description	Format/Option
System Time	BIOS system time in 24-hour format	Format: HH:MM:SS (hour:minute:second)
System Date	BIOS system date	Format MM/DD/YYYY (month/day/year)
Total Memory	Total memory available	N/A
Video Memory	Available memory for video	N/A
Quiet Boot	Shows OEM (original equipment manufacturer) screen during system boot instead of traditional POST screen	Option: Enabled or Disabled
Network Boot	Option to boot system from LAN (local area network)	Option: Enabled or Disabled
F12 Boot Menu	Option to use boot menu during POST	Option: Enabled or Disabled

**Table 2-2. BIOS Main (Continued)**

<b>Parameter</b>	<b>Description</b>	<b>Format/Option</b>
D2D Recovery	Option to use D2D Recovery function	Option: Enabled or Disabled
SATA Mode	Option to set SATA controller mode	Option: AHCI or IDE

# Security

The Security tab shows parameters that safeguard and protect the computer from unauthorized use.

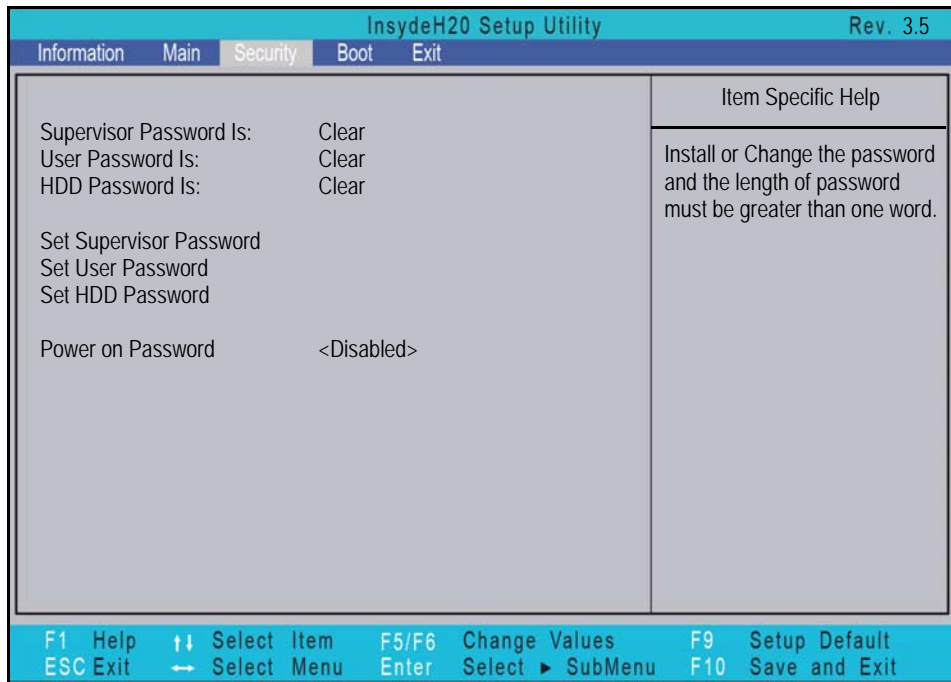

**Figure 2-3. BIOS Security**

Table 2-3 describes the parameters shown in Figure 2-3.

**Table 2-3. BIOS Security**

Parameter	Description	Option
Supervisor Password Is	Supervisor password setting	Clear or Set
User Password Is	User password setting	Clear or Set
HDD Password Is	HDD password setting	Clear or Set
Set Supervisor Password	Option to set supervisor password	N/A
Set User Password	Option to set user password	N/A
Set HDD Password	Option to set HDD password	N/A

**Table 2-3. BIOS Security (Continued)**

Parameter	Description	Option
Password on Boot	<p><b>▲ CAUTION:</b> If Power-on-Password authentication is enabled, the BIOS password can only be cleared by initiating the Crisis Disk Recovery procedure. Refer to <a href="#">Crisis Disk Recovery</a>.</p> <p>Shows if password is required during system boot</p>	Disabled or Enabled

⇒ **NOTE:**

When prompted to enter password, three attempts are allowed before system halts. Resetting BIOS password may require computer be returned to dealer.

## Setting a Password

Perform the following to set user or supervisor passwords:

1. Use the ↑ and ↓ keys to highlight the `Set Supervisor Password` parameter and press **Enter**. The `Set Supervisor Password` dialog box appears.

⇒ **NOTE:**

To change an existing password, refer to [Changing a Password](#).



**Figure 2-4. Set Supervisor Password**

2. Type a new password in the `Enter New Password` field. Passwords are not case sensitive and the length must not exceed 12 alphanumeric characters (A-Z, a-z, 0-9). Retype the password in the `Confirm New Password` field.

+ **IMPORTANT:**

Use care when typing a password. Characters do not appear on the screen.

3. Press **Enter**. After setting the password, the computer sets the `User Password` parameter to `Set`.

⇒ **NOTE:**

`Password on Boot` must be set to `Enabled` to activate password feature.

4. Press **F10** to save changes and exit *BIOS Setup Utility*.

## Removing a Password

Perform the following:

1. Use the **↑** and **↓** keys to highlight `Set Supervisor Password` and press **Enter**. The `Set Supervisor Password` dialog box appears:



**Figure 2-5. Set Supervisor Password**

2. Type current password in `Enter Current Password` field and press **Enter**.
3. Press **Enter** twice without typing anything in `Enter New Password` and `Confirm New Password` fields. Computer will set `Supervisor Password` parameter to `Clear`.
4. Press **F10** to save changes and exit the *BIOS Setup Utility*.

## Changing a Password

1. Use the **↑** and **↓** keys to highlight `Set Supervisor Password` and press **Enter**. The `Set Supervisor Password` dialog box appears.



**Figure 2-6. Set Supervisor Password**

2. Type current password in `Enter Current Password` field and press **Enter**.
3. Type new password in `Enter New Password` field. Retype new password in `Confirm New Password` field.
4. Press **Enter**. Computer sets `Supervisor Password` parameter to `Set`.

**⇒ NOTE:**

`Password on Boot` must be set to `Enabled` to activate the password feature.

5. Press **F10** to save changes and exit *BIOS Setup Utility*.

If the verification is OK, the screen will show as follows.



---

**Figure 2-7. Setup Notice**

The password setting is complete after the user presses **Enter**.

If the password entered does not match the current password, the screen shows the Setup Warning dialog. (Figure 2-8)



---

**Figure 2-8. Setup Warning: Invalid Password**

If new password and confirm new password strings do not match, the Setup Warning dialog appears (Figure 2-9).



---

**Figure 2-9. Setup Warning: Passwords Do Not Match**

# Boot

---

The Boot tab allows changes to the order of boot devices used to load the operating system. Bootable devices include the:

- USB diskette drives
- Onboard hard disk drive
- DVD drive in the module bay

Use ↑ and ↓ keys to select a device and press **F5** or **F6** to change the value.

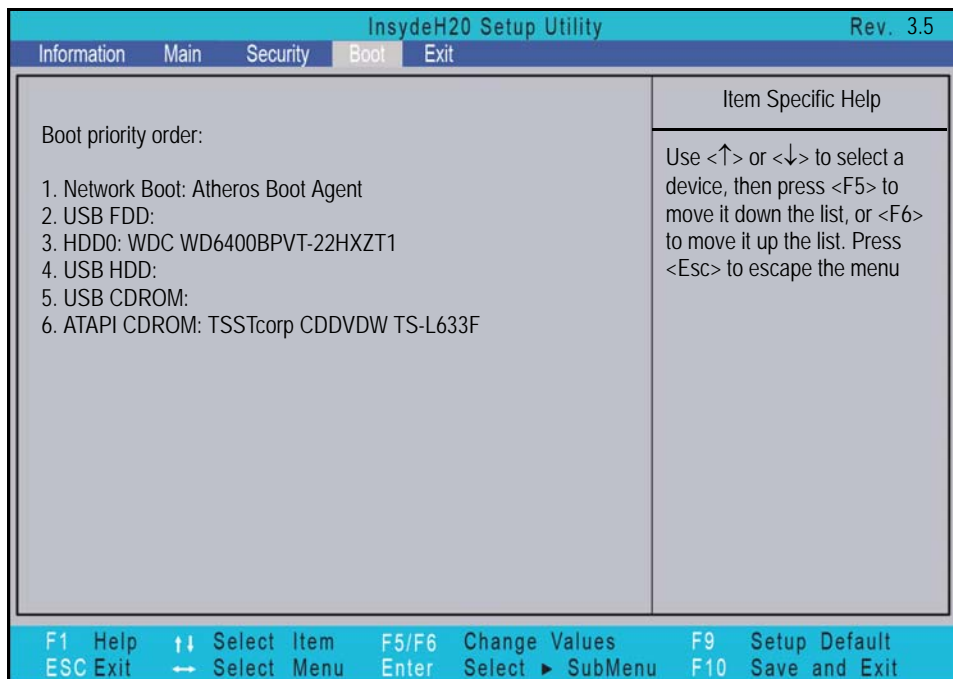

---

**Figure 2-10. BIOS Boot**



# Exit

---

The Exit tab allows users to save or discard changes and quit the *BIOS Setup Utility*.

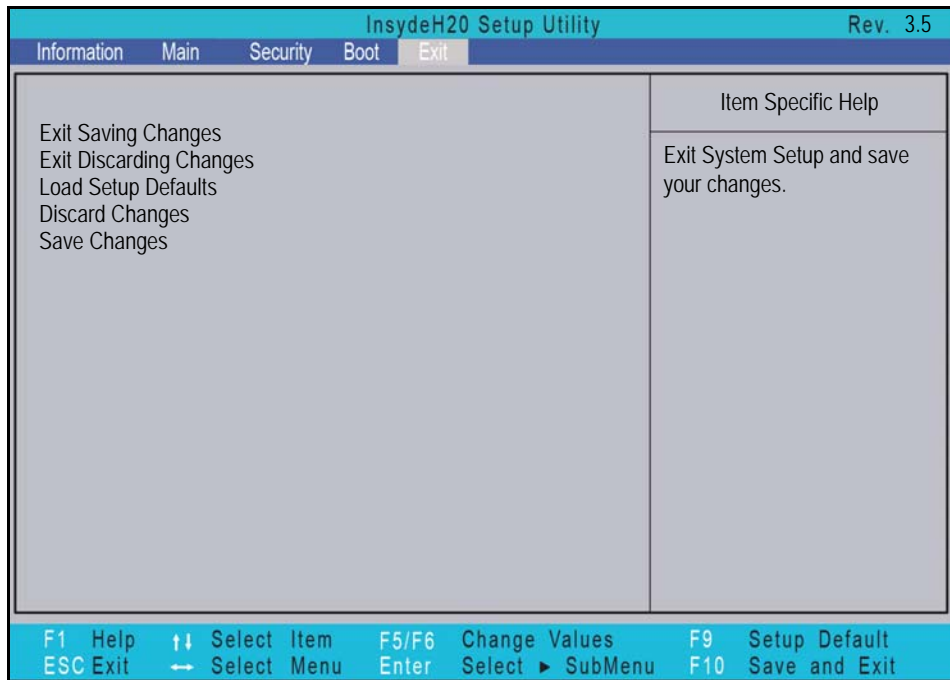

**Figure 2-11. BIOS Exit**

Table 2-4 describes the parameters in Figure 2-11.

**Table 2-4. Exit Parameters**

Parameter	Description
Exit Saving Changes	Exit BIOS utility and save setup item changes to system.
Exit Discarding Changes	Exit BIOS utility without saving setup item changes to system.
Load Setup Default	Load default values for all setup items.
Discard Changes	Load previous values of all setup items.
Save Changes	Save setup item changes to system.

# BIOS Flash Utilities

---

BIOS Flash memory updates are required for the following conditions:

- New versions of system programs
- New features or options
- Restore a BIOS when it becomes corrupted.

Use the Flash utility to update the system BIOS Flash ROM.

⇒ **NOTE:**

If a Crisis Recovery Disc is not available, create one before Flash utility is used.

⇒ **NOTE:**

Do not install memory related drivers (XMS, EMS, DPMI) when Flash is used.

⇒ **NOTE:**

Use AC adaptor power supply when running Flash utility. If battery pack does not contain power to finish loading BIOS Flash, do not boot system.

Perform the following to run Flash.

1. Prepare a bootable USB HDD.
2. Copy Flash utilities to bootable USB HDD.
3. Boot system from bootable USB HDD.

⇒ **NOTE:**

Flash utility has auto execution function.

# DOS Flash Utility

---

Perform the following to use the *DOS Flash Utility*:

1. Press **F2** during boot to enter Setup Menu.
2. Select **Boot** Menu to modify boot priority order.

Example: If using USB HDD to Update BIOS, move USB HDD to position 1.

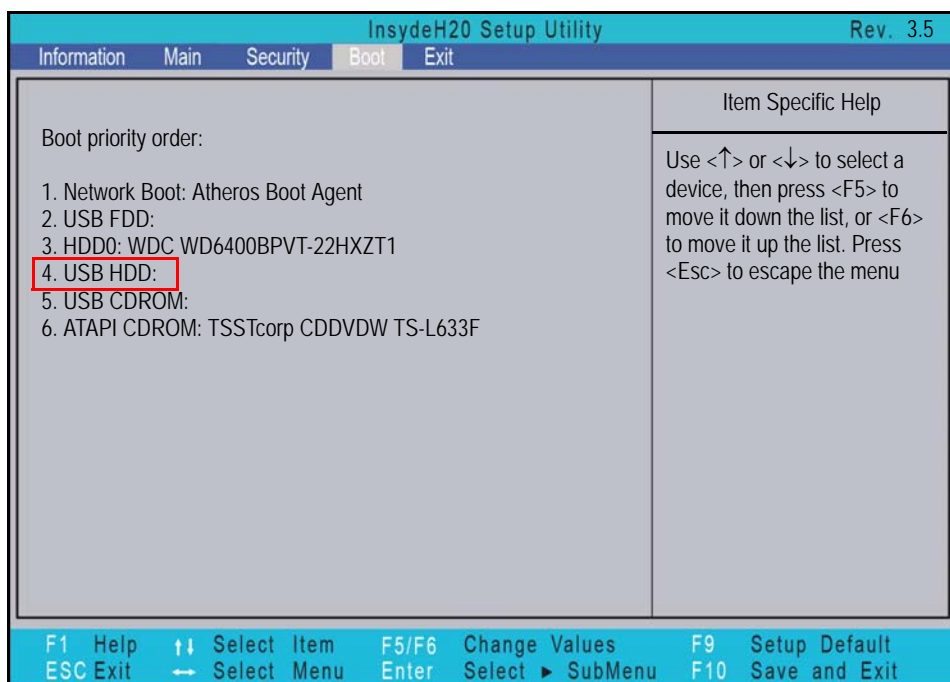

---

**Figure 2-12. BIOS Boot**

3. Insert the USB HDD and reboot computer.

- Execute `XEWX100.BAT` to update BIOS. Flash process begins as shown in Figure 2-13.

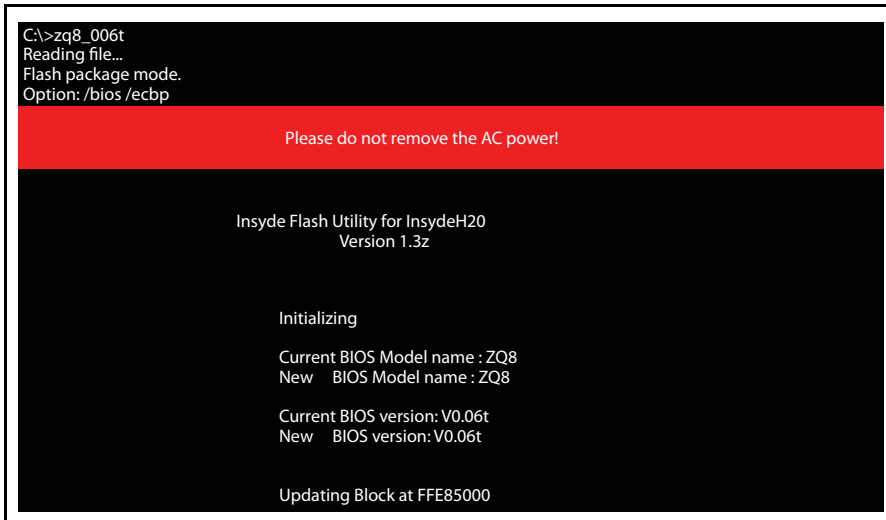

```
C:\>zq8_006t
Reading file...
Flash package mode.
Option: /bios /ecbp

Please do not remove the AC power!

Insyde Flash Utility for InsydeH20
Version 1.3z

Initializing

Current BIOS Model name : ZQ8
New   BIOS Model name : ZQ8

Current BIOS version: V0.06t
New   BIOS version: V0.06t

Updating Block at FFE85000
```

**Figure 2-13. DOS Flash Process**

- Flash is complete when the message, `Flash Programming Complete` is shown. System will restart automatically when finished.

⇒ **NOTE:**

If AC power is not connected, the following message is shown (Figure 2-14). Plug in the AC power to continue.



```
C:\>zq8_006t
Reading file...
Flash package mode.
Option: /bios /ecbp

Warning: No AC power connect
```

**Figure 2-14. AC Power Warning**

# WinFlash Utility

---

Perform the following to use the WinFlash Utility:

1. Double-click WinFlash executable.
2. Click **OK** to begin update. A progress screen is shown. (Figure 2-15)

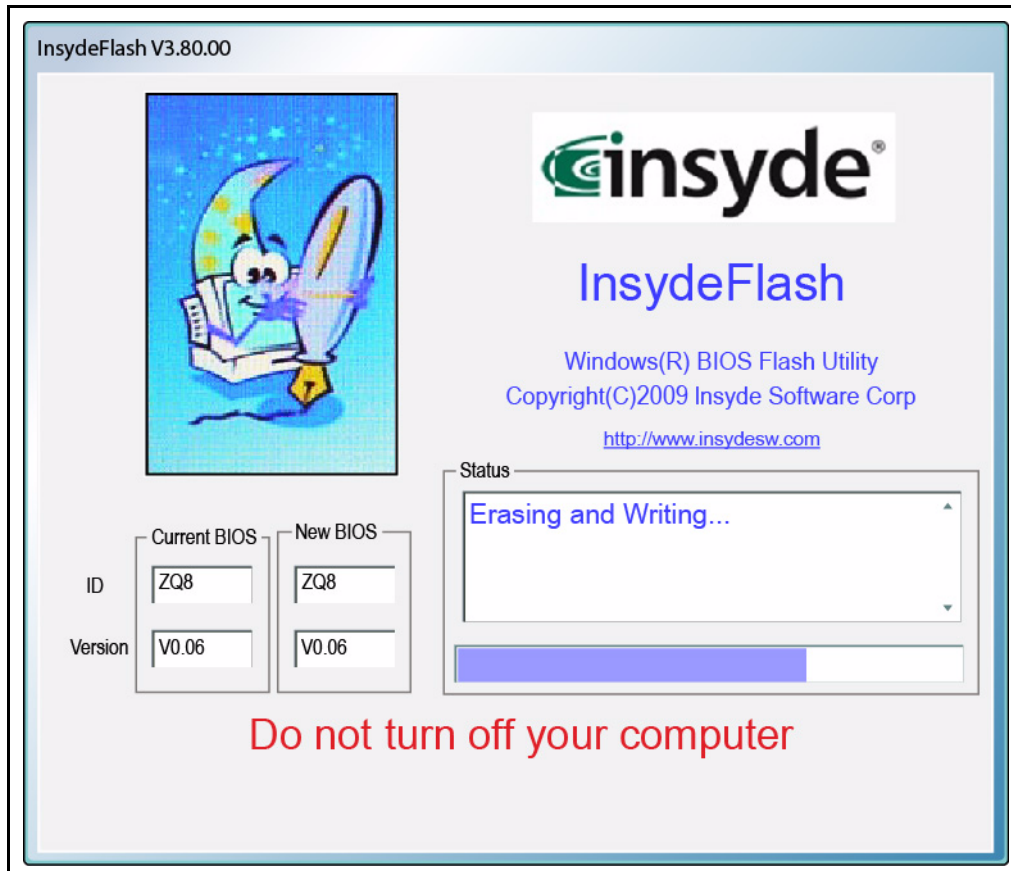

Figure 2-15. InsydeFlash

# Remove HDD/BIOS Password Utilities

**⚠ CAUTION:**

If Power-on Password authentication is enabled, the BIOS password can only be cleared by initiating the Crisis Disk Recovery procedure. See [Crisis Disk Recovery](#).

This section provides details about removing HDD/BIOS passwords.

Remove HDD Password as follows:

**⇒ NOTE:**

If the HDD password is incorrectly entered three times, an error is generated. (Figure 2-16)



**Figure 2-16. Password Error Status**

To reset the HDD password, perform the following:

1. From Password Error Status dialog shown in Figure 2-16, press **Enter** to continue.
2. The Enter Unlock Password dialog (Figure 2-18) is shown.

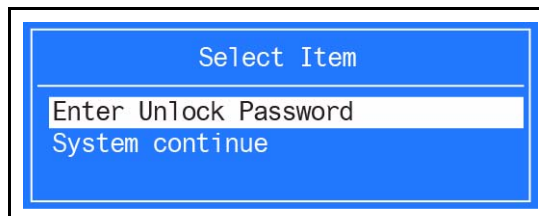

**Figure 2-17. Unlock Password Key**

**⇒ NOTE:**

An key code is generated for use with unlocking utility (Ex: 76943488). Make note of this code.

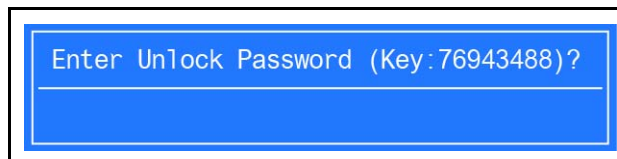

**Figure 2-18. Unlock Password Key**

3. On separate, compatible device, boot to DOS.

4. Execute *UnlockHD.exe* (Figure 2-19) to create a password unlock code. Use the format `<UnlockHD [key code]>` with the code noted in the Figure 2-18.

Example: **UnlockHD** 76943488

The command generates a password which can be used for unlocking the HDD.

Password: 46548274

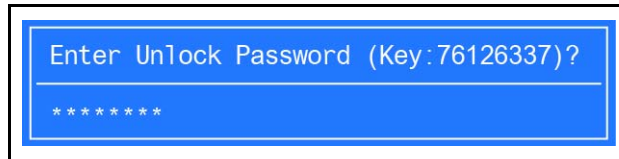

---

**Figure 2-19. Unlock Password**

5. On original device, enter password (Figure 2-19) in Enter Unlock Password dialog (Figure 2-18).

## Removing BIOS Passwords

---

(Hardware method) To clear User or Supervisor passwords, open the DIMM door and use a metal instrument to short the R582 point.

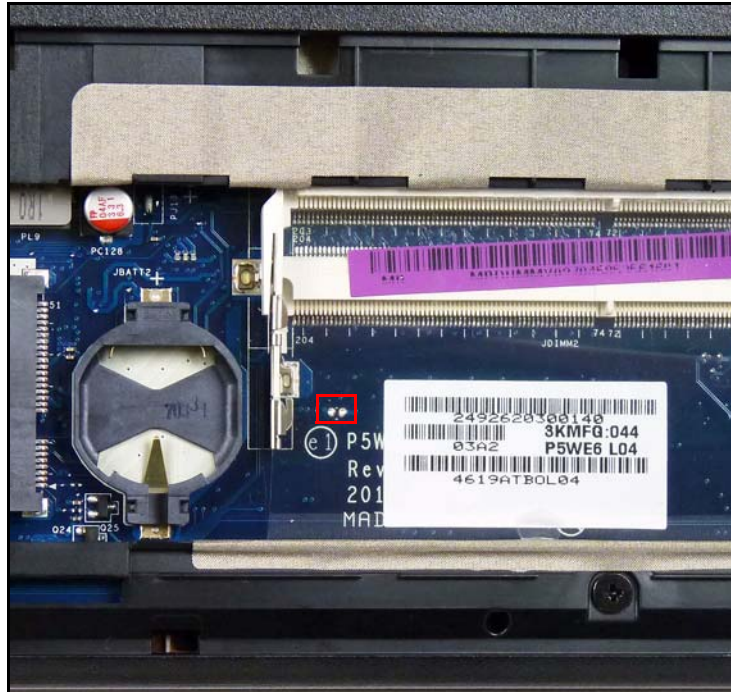

---

**Figure 2-20. CMOS Jumper**

(Software method) If wrong supervisor password is entered three times, the message System will halt! is displayed on screen.

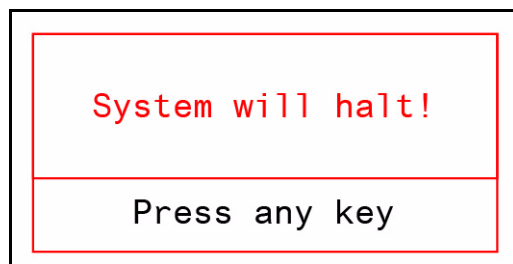

---

**Figure 2-21. Supervisor Password Error**



If user is unable to obtain correct password then it must be removed. There are two methods to do this.

### Method 1:

If BIOS menu item `Power on Password` is set to `Enabled`, then `Crisis Recovery disc` must be used.

### Method 2:

If BIOS menu item `Power on Password` is set to `Disabled`.

1. Boot to DOS and execute `ClearSuPw.exe`. (Figure 2-22)

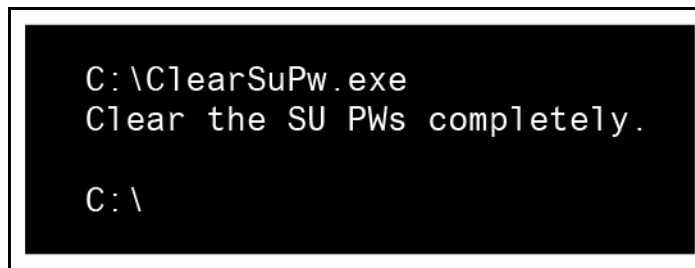
A screenshot of a DOS command prompt window. The text displayed is: C:\ClearSuPw.exe, Clear the SU Pws completely., and C:\. The text is white on a black background.

```
C:\ClearSuPw.exe
Clear the SU Pws completely.

C:\
```

---

**Figure 2-22. Clear Supervisor Password Utility**

2. When message `Clear the SU Pws completely` is displayed, supervisor password has been removed.

## Cleaning BIOS Passwords

---

### ⚠ CAUTION:

If Power-on Password authentication is enabled, the BIOS password can only be cleared by initiating the Crisis Disk Recovery procedure. See [Crisis Disk Recovery](#).

To clean the User or Supervisor passwords, perform the following steps:

1. At the DOS prompt, enter **c1npwd.exe**.
2. Press **1** or **2** to clean the desired password shown on the screen.

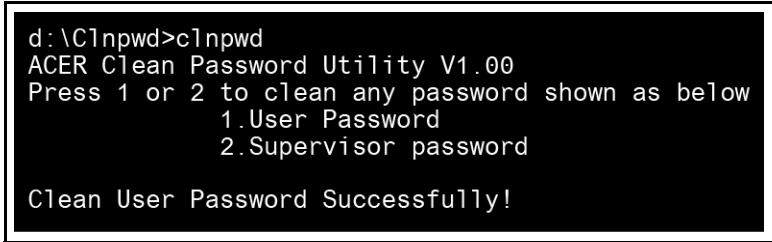

```
d:\C1npwd>c1npwd
ACER Clean Password Utility V1.00
Press 1 or 2 to clean any password shown as below
    1.User Password
    2.Supervisor password

Clean User Password Successfully!
```

---

**Figure 2-23. Clean BIOS Password**

3. The on screen message shows function success or failure.

# Miscellaneous Tools

---

## Using Boot Sequence Selector

---

The Boot Sequence Selector allows the boot order to be changed without accessing the BIOS. To use Boot Sequence Selector, perform the following steps:

1. Enter into DOS.
2. Execute *BS.exe* to show the usage screen. (Figure 2-24)

```
d: \BOOTSEQ>bs

*** Boot Sequence Selector Version 0.03 ***
Create by Rockwell Chuang 10/01/2005.

Usage:
      BS [ 1 | 2 | 3 | 4 ]

BS 1 : [ Floppy ] => [ HardDisk ] => [ CD-ROM ] => [ LAN ]
BS 2 : [ HardDisk ] => [ CD-ROM ] => [ LAN ] => [ Floppy ]
BS 3 : [ CD-ROM ] => [ HardDisk ] => [ LAN ] => [ Floppy ]
BS 4 : [ LAN ] => [ Floppy ] => [ HardDisk ] => [ CD-ROM ]

d: \BOOTSEQ>
```

---

**Figure 2-24. Boot Sequence Selector**

3. Select the desired boot sequence by entering the corresponding sequence. For example, enter **<BS 2>** to change the boot sequence to HDD | CD ROM | LAN | Floppy.

# Using DMITools

---

The DMI (Desktop Management Interface) Tool copies BIOS information to EEPROM (Electrically Erasable Programmable Read-Only Memory). Used in the DMI pool for hardware management.

When the BIOS shows **verifying DMI pool data**, it is checking that the table correlates with the hardware before sending information to the operating system (Windows, etc.).

To update the DMI Pool, perform the following:

1. Boot to DOS.
2. Execute **dmitools.exe**. The following messages report to screen to confirm completion:
  - `dmitools /r ==>` Read dmi string from BIOS
  - `dmitools /wm xxxx ==>` Write manufacturer name to EEPROM (max. 16 characters)
  - `dmitools /wp xxxx ==>` Write product name to EEPROM (max. 16 characters)
  - `dmitools /ws xxxx ==>` Write serial number to EEPROM (max. 22 characters)
  - `dmitools /wu xxxx ==>` Write uuid to EEPROM
  - `dmitools /wa xxxx ==>` Write asset tag to EEPROM (max. 32 characters)

The following examples show the commands and the corresponding output information.

## Read DMI Information from Memory

**Input:**

```
dmitools /r
```

**Output:**

```
Manufacturer (Type1, Offset04h): Packard Bell
Product Name (Type1, Offset05h): xxxxx
Serial Number (Type1, Offset07h): 01234567890123456789
UUID String (Type1, Offset08h): xxxxxxxx-xxxx-xxxx-xxxx-xxxxxxxxxxxx
Asset Tag (Type3, Offset04h): Acet Asstag
```

## Write Product Name to EEPROM

**Input:**

```
dmitools /wp Acer
```

## Write Serial Number to EEPROM

**Input:**

```
dmitools /ws 01234567890123456789
```

## Write UUID to EEPROM (Create UUID from Intel WFM20.pdf)

**Input:**

```
dmitools /wu
```

## Write Asset Tag to EEPROM

**Input:**

```
dmitools /wa Acet Asstag
```

### ⇒ NOTE:

When using any of the write options, restart the system to set the new DMI data.

## Using the LAN MAC EEPROM Utility

---

Perform the following steps to write MAC (Media Access Control) information to EEPROM:

Use the *MAC.BAT* utility to write the *MAC.CFG* file to the EEPROM under DOS mode.

1. Use a text editor (Ex: Notepad) to open the *MAC.CFG* file. See the *MAC.CFG* contents in Figure 2-25

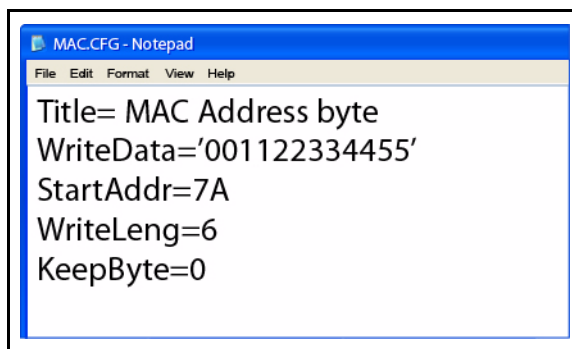
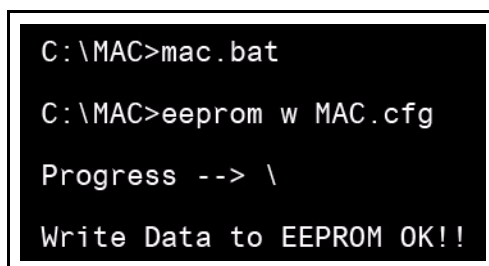

**Figure 2-25. LAN MAC EEPROM**

**Table 2-5. LAN MAC EEPROM**

Parameter	Description
WriteData = '001122334455'	MAC value
StartAddr=7A	MAC address
WriteLeng=6	MAC value length
KeepByte=0	Value not important

2. Enter into DOS.
3. Run the *MAC.BAT* file to write MAC values to EEPROM.



**Figure 2-26. LAN MAC EEPROM**

4. Reboot the system when the process has completed.

# Crisis Disk Recovery

---

1. Plug in the USB flash disk.
2. Select the **Fast Format** option and click **Start**. Then click **Next**.



Figure 2-27. USB Flash Crisis Disk

---

3. Click **Format** and then **Exit** to complete the operation.

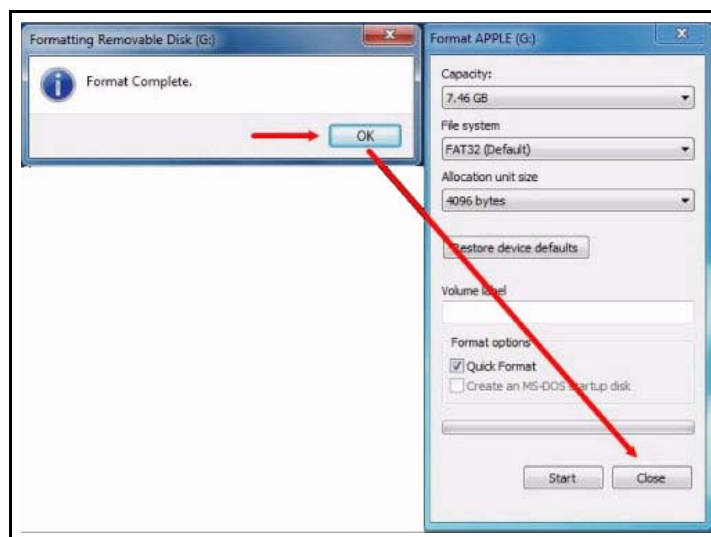
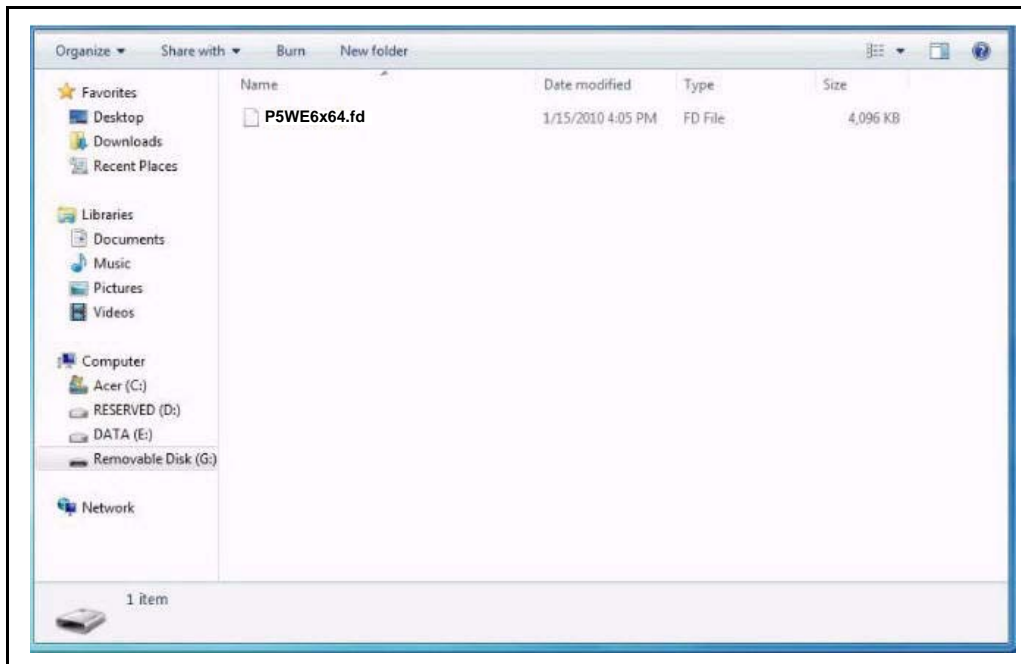

Figure 2-28. USB Flash Crisis Disk

---

4. Copy the *P5WE6x64.FD* file to the USB flash disk root directory.



**Figure 2-29. USB Flash Crisis Disk**

⇒ **NOTE:**

Do not place any other \*.fd files to the USB flash disk root directory.

5. Plug in the USB Flash Disk without AC plug.
6. Press **Fn + Esc** keys and hold them down, then plug in AC power. The power button flashes orange.
7. Press **Power** button and the system will enter crisis mode to flash the BIOS.





# CHAPTER 3

## Machine Maintenance Procedures

---

<b>Introduction</b> . . . . .	<b>3-5</b>
<b>General Information</b> . . . . .	<b>3-5</b>
<b>Recommended Equipment</b> . . . . .	<b>3-5</b>
<b>Maintenance Flowchart</b> . . . . .	<b>3-6</b>
<b>Getting Started</b> . . . . .	<b>3-7</b>
Battery Pack Removal . . . . .	3-8
Battery Pack Installation . . . . .	3-8
Dummy Card Removal . . . . .	3-9
Dummy Card Installation . . . . .	3-9
Keyboard Removal . . . . .	3-10
Keyboard Installation . . . . .	3-11
ODD (Optical Disk Drive) Module Removal . . . . .	3-12
ODD Module Installation . . . . .	3-13
Base Door Removal . . . . .	3-14
Base Door Installation . . . . .	3-14
DIMM (Dual In-line Memory Module) Module Removal . . . . .	3-15
DIMM Module Installation . . . . .	3-16
WLAN (Wireless Local Area Network) Board Removal . . . . .	3-17
WLAN Board Installation . . . . .	3-17
RTC Battery Removal . . . . .	3-18
RTC Battery Installation . . . . .	3-18
HDD (Hard Disk Drive) Module Removal . . . . .	3-19
HDD Module Installation . . . . .	3-20
Upper Cover Removal . . . . .	3-21
Upper Cover Installation . . . . .	3-23
Speaker Removal . . . . .	3-24
Speaker Installation . . . . .	3-25
Power Board Removal . . . . .	3-26
Power Board Installation . . . . .	3-26
Touchpad Removal . . . . .	3-27
Touchpad Installation . . . . .	3-27
USB Board Removal . . . . .	3-28
USB Board Installation . . . . .	3-29
ODD Board Removal . . . . .	3-30
ODD Board Installation . . . . .	3-30
Bluetooth Board Removal . . . . .	3-31
Bluetooth Board Installation . . . . .	3-31
Mainboard Removal . . . . .	3-32
Mainboard Installation . . . . .	3-34
Fan Removal . . . . .	3-35
Fan Installation . . . . .	3-35
Heatsink Removal . . . . .	3-36
Heatsink Installation . . . . .	3-37
LCD (Liquid Crystal Display) Module Removal . . . . .	3-39

LCD Module Installation . . . . .	3-40
DC-IN Cable Removal . . . . .	3-41
DC Cable Installation . . . . .	3-42
LCD Bezel Removal . . . . .	3-43
LCD Bezel Installation . . . . .	3-45
Camera Module Removal . . . . .	3-46
Camera Module Installation . . . . .	3-47
LCD Panel Removal . . . . .	3-48
LCD Panel Installation . . . . .	3-49
LCD Bracket Removal . . . . .	3-50
LCD Bracket Installation . . . . .	3-50
LVDS Cable Removal . . . . .	3-51
LVDS Cable Installation . . . . .	3-52
Microphone Set Removal . . . . .	3-53
Microphone Set Installation . . . . .	3-53
WLAN Antenna Removal . . . . .	3-54
WLAN Antenna Installation . . . . .	3-54



# Machine Maintenance Procedures

---

## Introduction

---

This chapter contains general information about the computer, a list of tools needed to do the required maintenance and step by step procedures on how to remove and install components from the computer.

## General Information

---

The product previews seen in the following procedures may not represent the final product color or configuration. Cable paths and positioning may also differ from the actual model. During the removal and installation of components, make sure all available cable channels and clips are used and that the cables are installed in the same position.

All prerequisites must be completed prior to starting maintenance.

## Recommended Equipment

---

The following equipment are recommended to do the following maintenance procedures:

- Wrist grounding strap and conductive mat
- Flat screwdriver
- Philips screwdriver
- Plastic tweezers
- Flat plastic pry

**Table 3-1. Screw List**

Size	Quantity	Acer Part No.
M2.5*8.0	14	86.R4F02.002
M2.0*3.0	11	86.R4F02.004
M2.0D*3.0L 3.5D	4	86.R4F02.007
M2.5*6.0 Ni	2	86.R4F02.003
M2.5*5.0	21	86.R4F02.001
M3.0*3.0 Ni	4	86.R4F02.005
ICW50 CPU Thermal Screw	4	86.R4F02.008

# Maintenance Flowchart

The flowchart in Figure 3-1 shows a graphic representation of the module removal and installation sequences. It shows information on what components may need to be removed and installed during servicing.

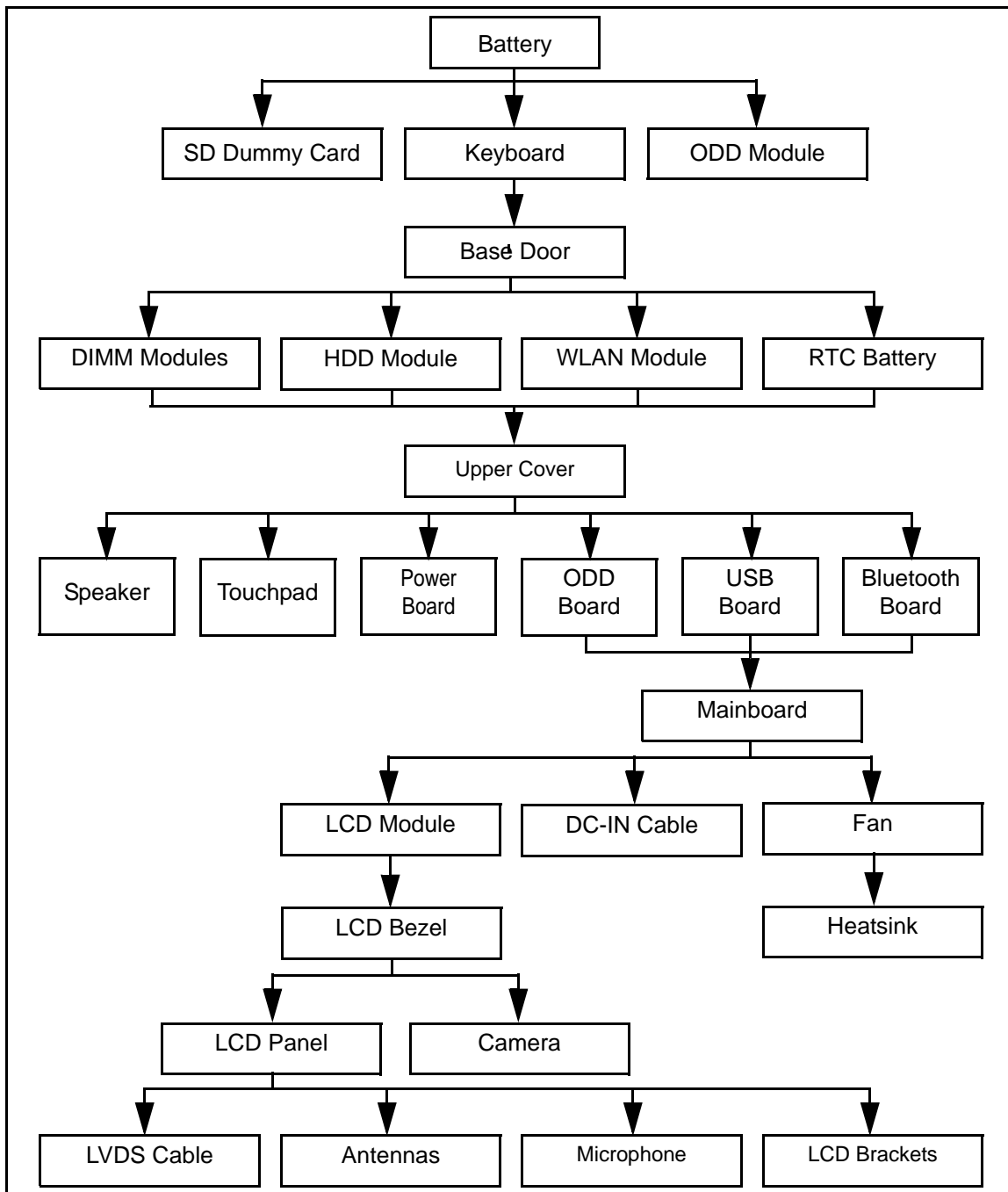

**Figure 3-1. Maintenance Flow**

# Getting Started

---

Flowchart [Figure 3-1](#) identifies sections for the removal and install sequence. Follow the order of the sequence to avoid damage to any of the hardware components.

Do the following prior to starting any maintenance procedures:

1. Remove power (A) from the system and peripherals.
2. Remove all cables from system.



---

**Figure 3-2. AC Adapter Outlet**

3. Put system on a stable work surface.

## Battery Pack Removal

---

1. Put computer on flat surface, battery side up.
2. Push battery lock/unlock latch (A) to unlock position. (Figure 3-3)
3. Push and hold battery release latch (B) to release position. (Figure 3-3)
4. Lift battery pack (C) from battery bay. (Figure 3-3)

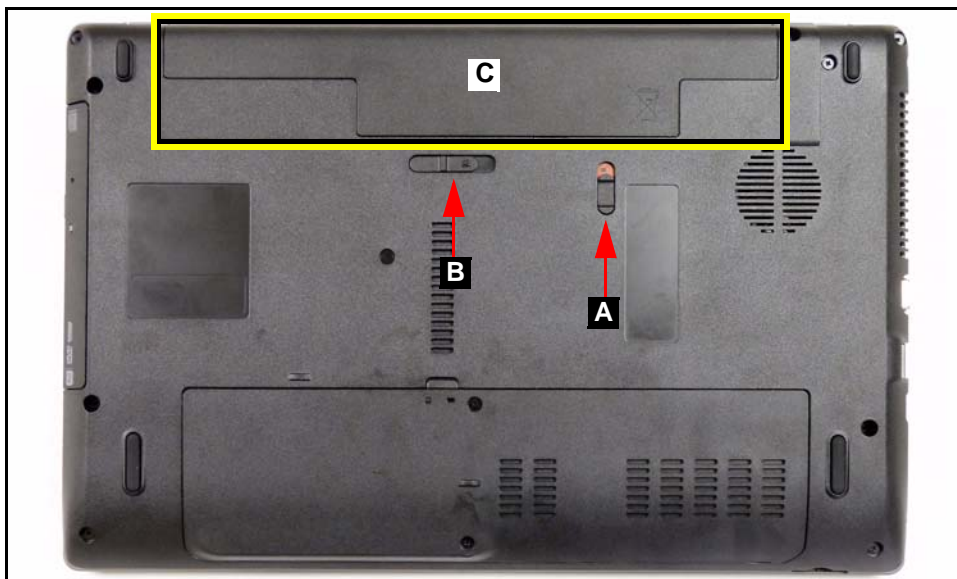

Figure 3-3. Battery

+ **IMPORTANT:**

Follow local regulations for battery (C) disposal. (Figure 3-3)

## Battery Pack Installation

---

1. Hold latch (B) in release position and install battery (C). (Figure 3-3)
2. Lock battery lock/unlock latch (A). (Figure 3-3)



## Dummy Card Removal

---

1. Push dummy card (A) in to release it from the spring latch. (Figure 3-4)
2. Remove dummy card (A). (Figure 3-4)



---

**Figure 3-4. Dummy Card**

## Dummy Card Installation

---

1. Insert dummy card (A). (Figure 3-4)
2. Push card until spring latch locks.

# Keyboard Removal

---

## Prerequisite:

### Battery Pack Removal

1. Release seven (7) latches from the keyboard. (Figure 3-5)



**Figure 3-5. Keyboard Latches**

2. Turn the keyboard over so that the keys are face down on the palm rest (C). (Figure 3-6)
3. Disconnect keyboard FPC (A) from mainboard connector (B). (Figure 3-6)

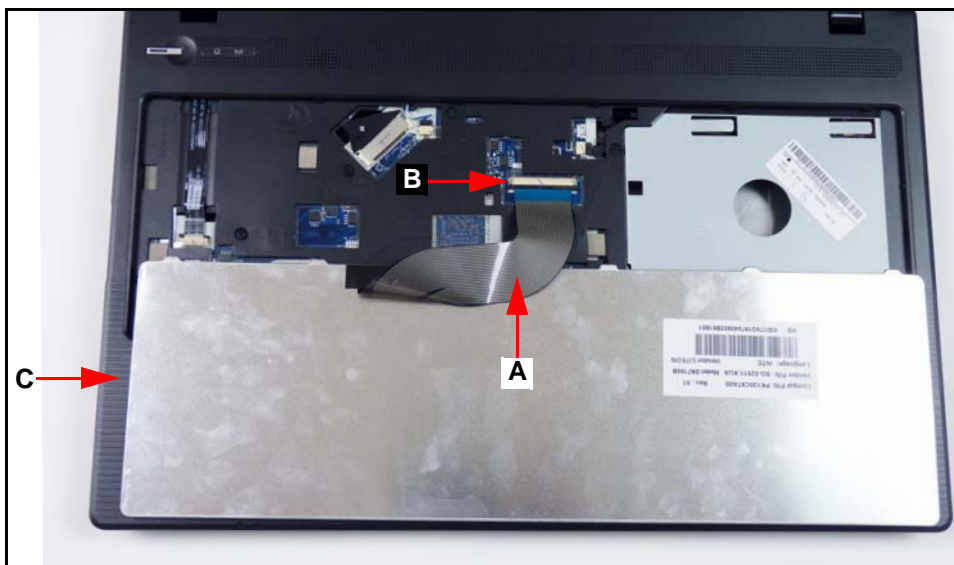

**Figure 3-6. Keyboard FPC**

**⚠ CAUTION:**

Keyboard FPC (Flexible Printed Circuit) can be damaged if removed while mainboard connector is locked.

## Keyboard Installation

---

1. Put the keyboard face down on the palm rest (C). ([Figure 3-6](#))
2. Connect keyboard FPC (A) to mainboard connector (B). ([Figure 3-6](#))
3. Turn the keyboard over and align the keyboard with the indentation in the upper cover.
4. Press down to secure the latches on the upper cover. ([Figure 3-5](#))
5. Install battery.

# ODD (Optical Disk Drive) Module Removal

---

## Prerequisite:

### Battery Pack Removal

1. Remove one (1) screw (A) from lower cover. (Figure 3-7)

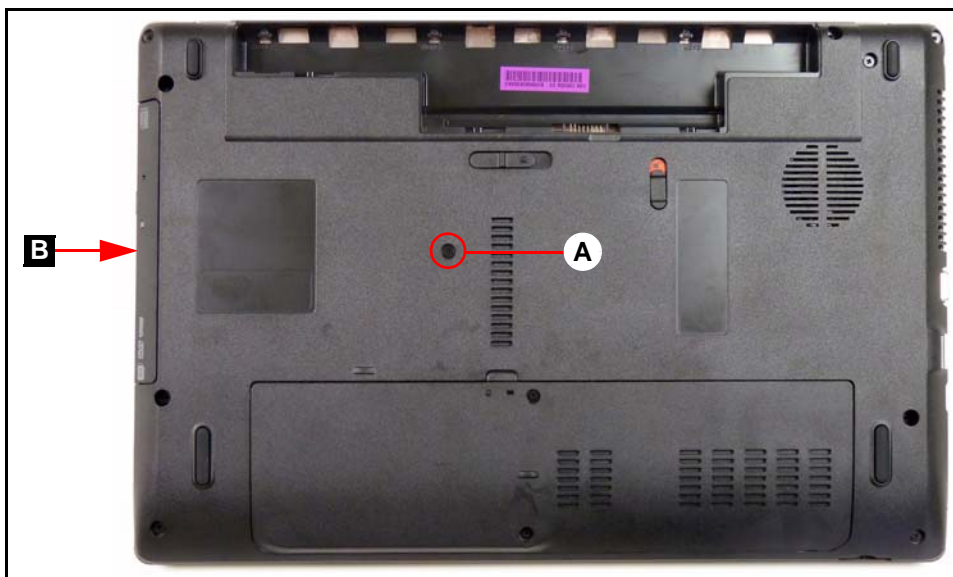

**Figure 3-7. ODD Module in Lower Cover**

2. Remove ODD module (B) from ODD bay. (Figure 3-7)
3. Remove two (2) screws (C) from ODD module. (Figure 3-8)
4. Remove ODD bracket (D) from ODD module.
5. Remove ODD bezel (E) from ODD module.





**Figure 3-8. ODD Module**

## ODD Module Installation

---

1. Install ODD bezel (E) on ODD module.([Figure 3-8](#))
2. Install ODD bracket (D) on ODD module and secure two (2) screws (C). ([Figure 3-8](#))
3. Insert ODD module (B) into ODD module bay. ([Figure 3-7](#))
4. Install and secure screw (A) to lower cover. ([Figure 3-7](#))
5. Install battery.

ID	Size	Quantity	Screw Type
A	M2.5*6.0	1	
C	M2.0*3.0	2	

## Base Door Removal

---

### Prerequisite:

#### Battery Pack Removal

1. Locate base door (B) on lower cover. (Figure 3-9)
2. Remove two (2) screws (A). (Figure 3-9)
3. Remove door from lower cover.

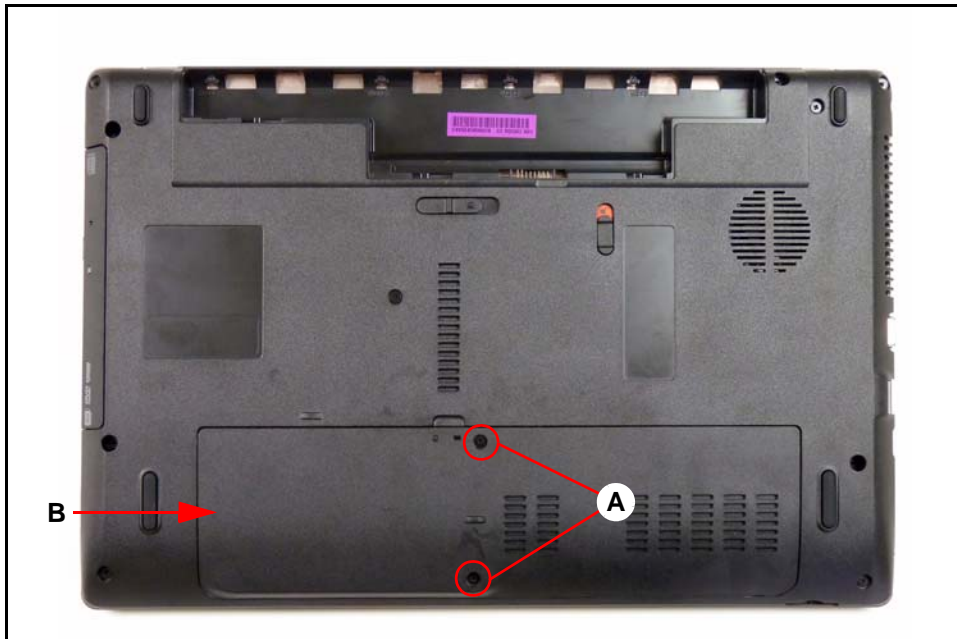

---

**Figure 3-9. Base Door**

## Base Door Installation

---

1. Insert door flanges into slots (B) on lower cover. (Figure 3-9)
2. Secure door to lower cover with two (2) screws (A). (Figure 3-9)
3. Install battery pack.

# DIMM (Dual In-line Memory Module) Module Removal

## Prerequisite:

### Base Door Removal

1. Find DIMM (D) in the component bay. (Figure 3-10)

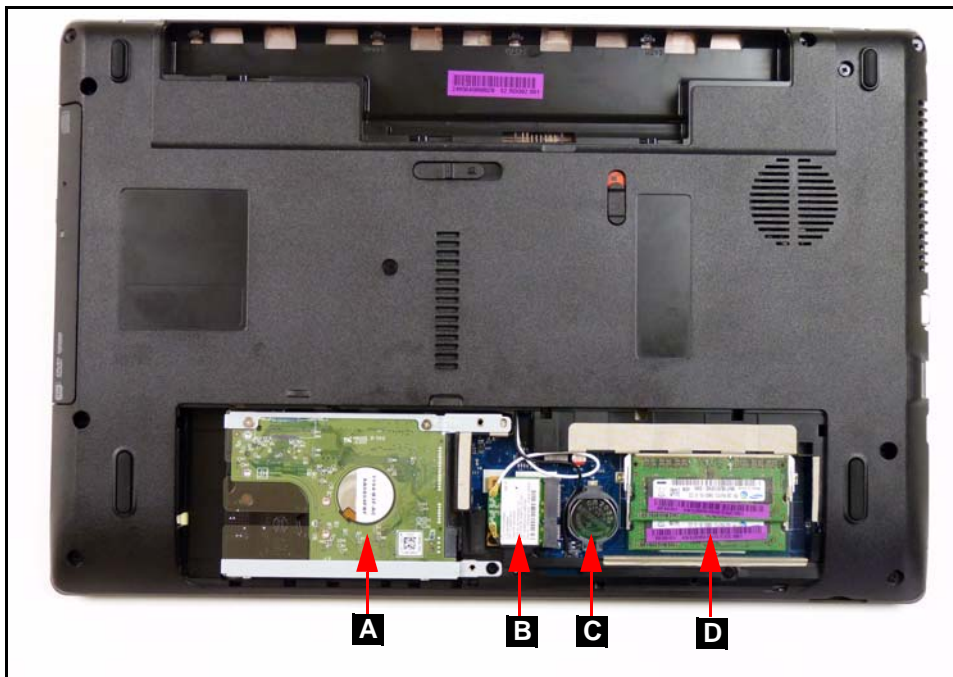

Figure 3-10. Component Location

2. Push DIMM clips (A) outwards. (Figure 3-11)

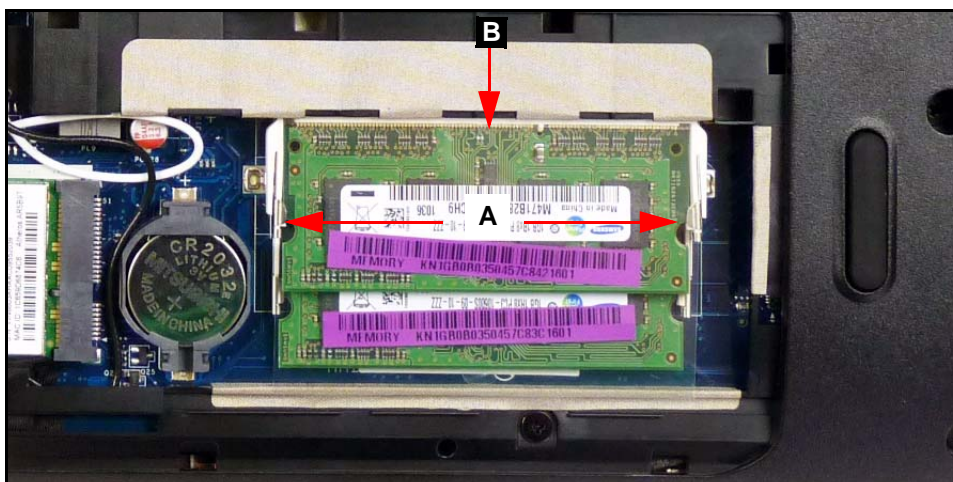

Figure 3-11. DIMM Modules

3. Disconnect DIMM out of mainboard connector (B). ([Figure 3-11](#))
4. Repeat steps 2 and 3 for remaining modules.

## DIMM Module Installation

---

1. Connect DIMM into mainboard connector (B). ([Figure 3-11](#))
2. Push down on DIMM until module clips (A) lock in position. ([Figure 3-11](#))
3. Repeat steps 2 and 3 for remaining modules.
4. Install base door.



# WLAN (Wireless Local Area Network) Board Removal

## Prerequisite:

### Base Door Removal

1. Find WLAN board (B) in the component bay. (Figure 3-10)
2. Disconnect main (B) and auxiliary (A) antenna cables from WLAN board. (Figure 3-12)

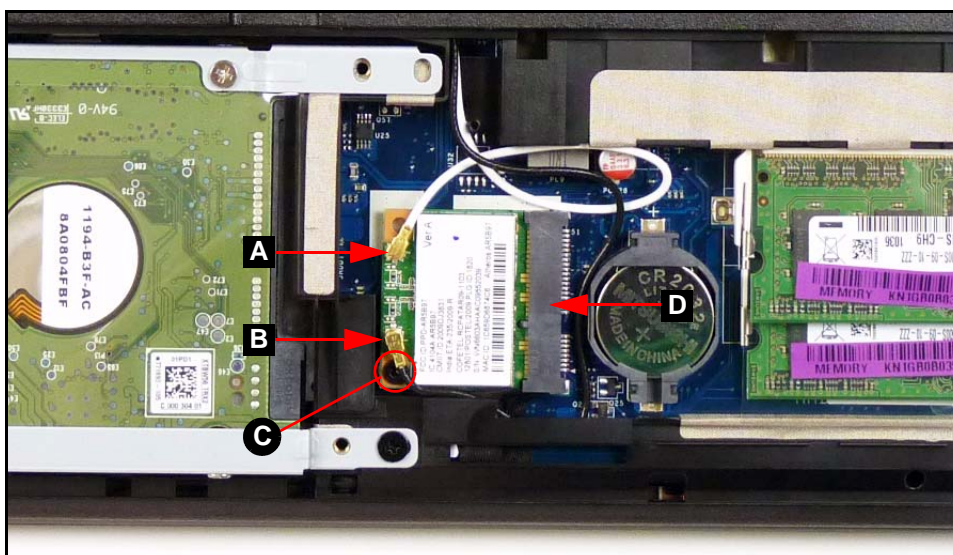

**Figure 3-12. WLAN Board**

3. Remove one (1) screw (C). (Figure 3-12)
4. Remove WLAN board from mainboard connector (D). (Figure 3-12)

## WLAN Board Installation

1. Put WLAN board into mainboard connector (D). (Figure 3-12)
2. Install and secure one (1) screw (D). (Figure 3-12)
3. Install main (B) and auxiliary (A) antenna cables on WLAN board. (Figure 3-12)
4. Install base door.

ID	Size	Quantity	Screw Type
D	M2.5*3.0	1	

## RTC Battery Removal

---

### Prerequisite:

#### Base Door Removal

1. Find RTC (Real Time Clock) battery (C) on mainboard. (Figure 3-10)
2. Using plastic tweezers, push the RTC battery in using the gap in the mainboard connector (A) to release the battery. (Figure 3-13)

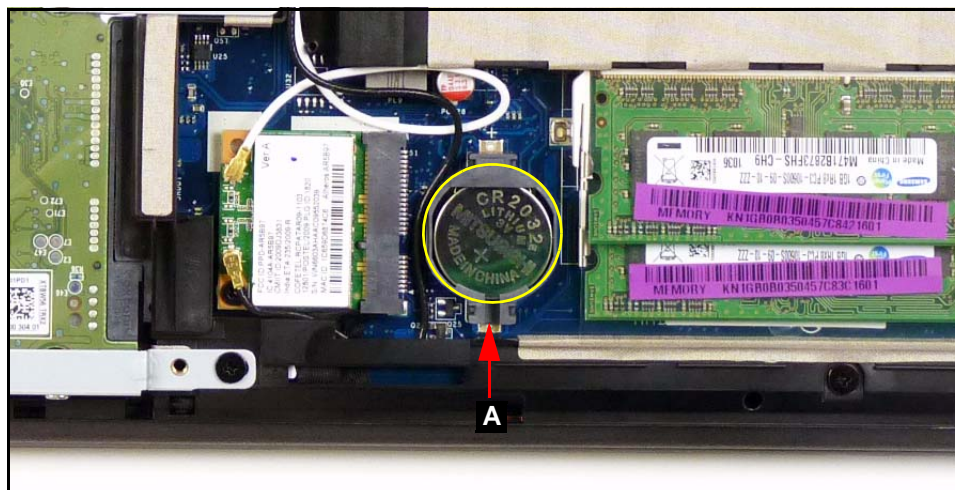

**Figure 3-13. RTC Battery**

#### + IMPORTANT:

Follow local regulations for battery (Figure 3-13) disposal.

3. Remove RTC battery from mainboard connector. (Figure 3-13)

## RTC Battery Installation

---

1. Put RTC battery (A) into the mainboard connector and press down to secure it. (Figure 3-13)
2. Install base door.

# HDD (Hard Disk Drive) Module Removal

---

## Prerequisite:

### [Base Door Removal](#)

1. Find HDD module (A) in component bay. (Figure 3-14)
2. Remove one (1) screw (A). (Figure 3-14)



**Figure 3-14. HDD Module**

3. Slide HDD module away from the mainboard connector (B) to disconnect it. (Figure 3-14)
4. Lift HDD module from component bay.
5. Remove four (4) screws (C) from HDD bracket (D). (Figure 3-15)

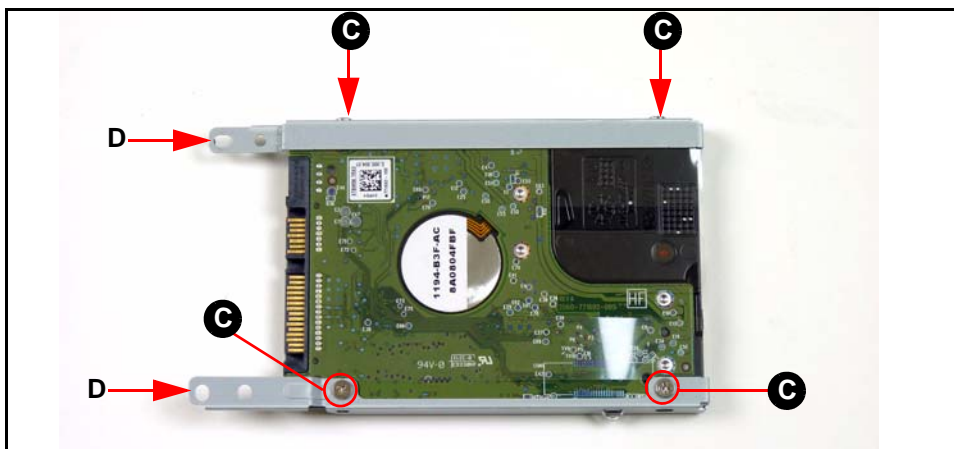



**Figure 3-15. HDD Module**

6. Remove HDD bracket (D) from HDD module.

## HDD Module Installation

---

1. Put HDD brackets onto HDD module. (Figure 3-15)
2. Install four (4) screws (C) to secure HDD brackets (D) to HDD module. (Figure 3-15)
3. Put HDD module into component bay. (Figure 3-14)
4. Slide the HDD module towards the mainboard connector (B) to secure it. (Figure 3-14)
5. Install one (1) screw (A) to secure HDD module. (Figure 3-14)
6. Install base door.

ID	Size	Quantity	Screw Type
A	M2.5*8.0	1	
C	M3.0*3.0	4	

## Upper Cover Removal

---

### Prerequisite:

#### [HDD \(Hard Disk Drive\) Module Removal](#)

1. Remove fourteen (14) securing screws from the lower cover. (Figure 3-16)

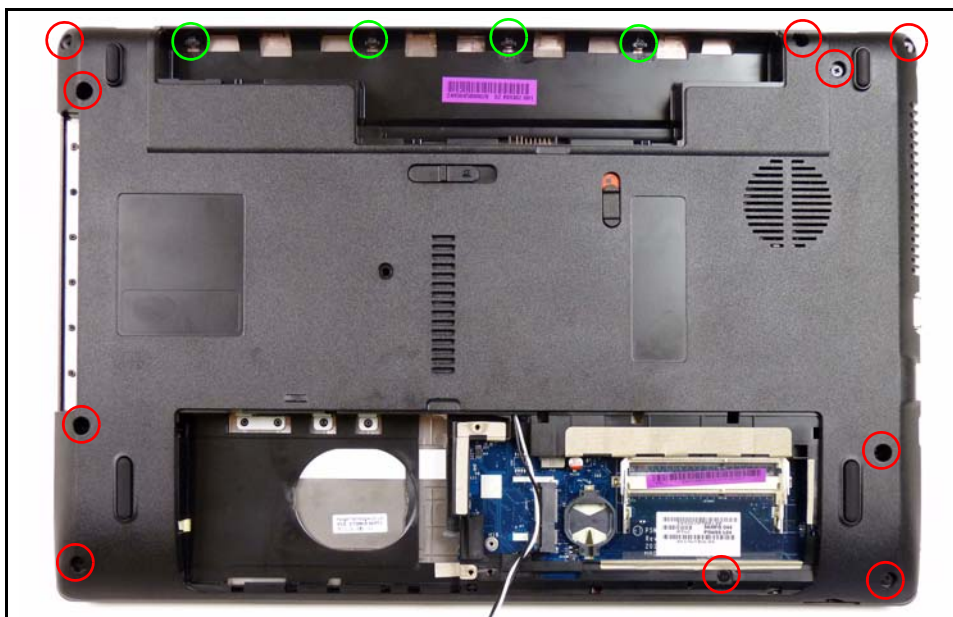

**Figure 3-16. Lower Cover Screw Location**

2. Remove eight (8) securing screws (A) from the upper cover. (Figure 3-17)

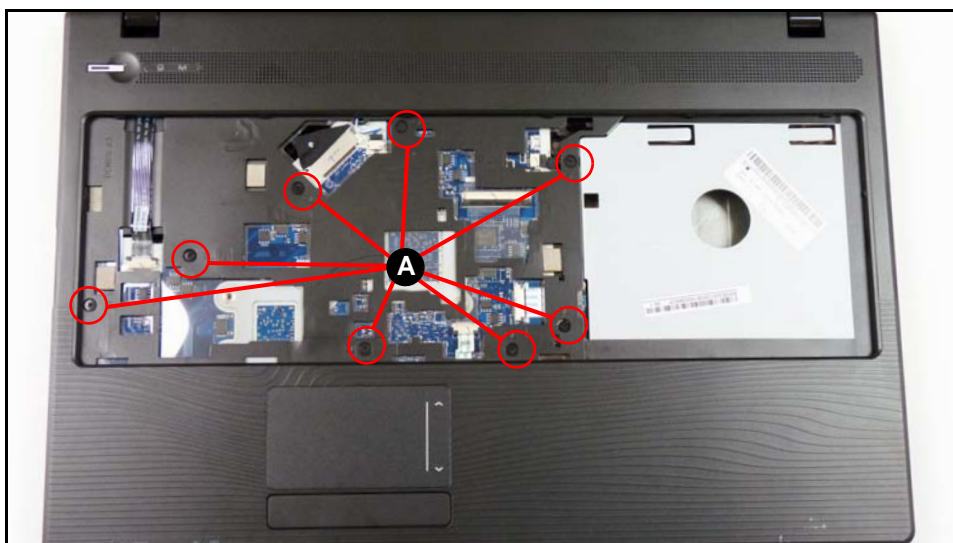

**Figure 3-17. Upper Cover Screw Location**

3. Grasp the lower cover by the ODD bay (B) and lift the upper cover up to release the latches securing it to the lower cover. (Figure 3-18)



**Figure 3-18. Lower Cover Removal**

4. Continue lifting along the edges of the upper cover to release the latches. (Figure 3-19)





**Figure 3-19. Lower Cover Removal**

5. Remove the upper cover from the lower cover.

## Upper Cover Installation

---

1. Align and install upper cover onto the lower cover. (Figure 3-19)
2. Press down on the edges of the upper cover to secure the latches.
3. Install and secure eight (8) screws (A) to upper cover. (Figure 3-17)
4. Install and secure fourteen (14)screws to the lower cover. (Figure 3-16)
5. Install HDD module.

ID	Size	Quantity	Screw Type
Green Callout	M2.0*3.0	4	
Red Callout	M2.5*8.0	10	
A	M2.5*5.0 (red call out)	8	

# Speaker Removal

---

## Prerequisite:

### Upper Cover Removal

1. Find speaker (A) on upper cover. (Figure 3-20)

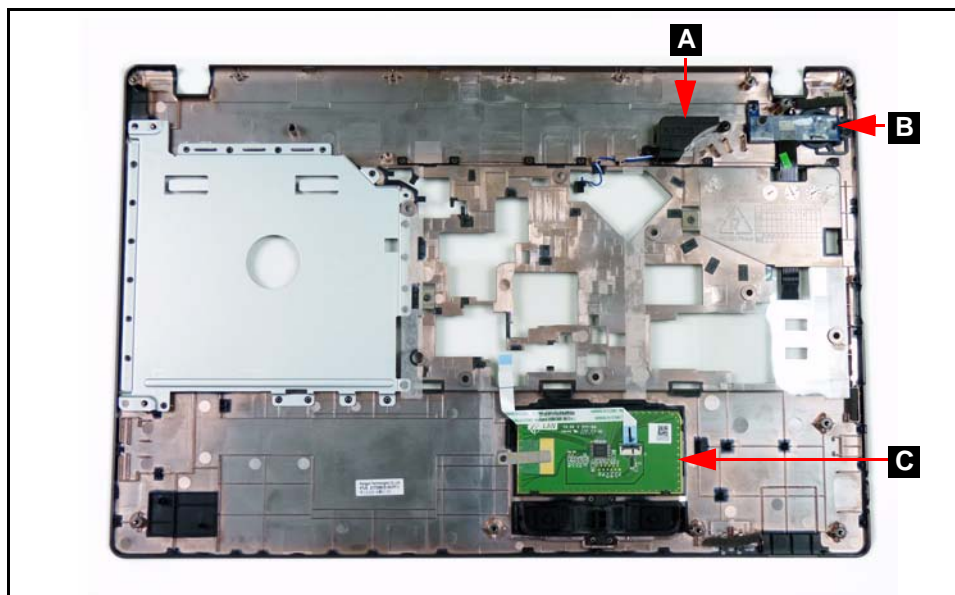

**Figure 3-20. Upper Cover Component Location**

2. Remove speaker cable (B) from cable guides (C). (Figure 3-21)
3. Remove two (2) screws (D) from upper cover. (Figure 3-21)

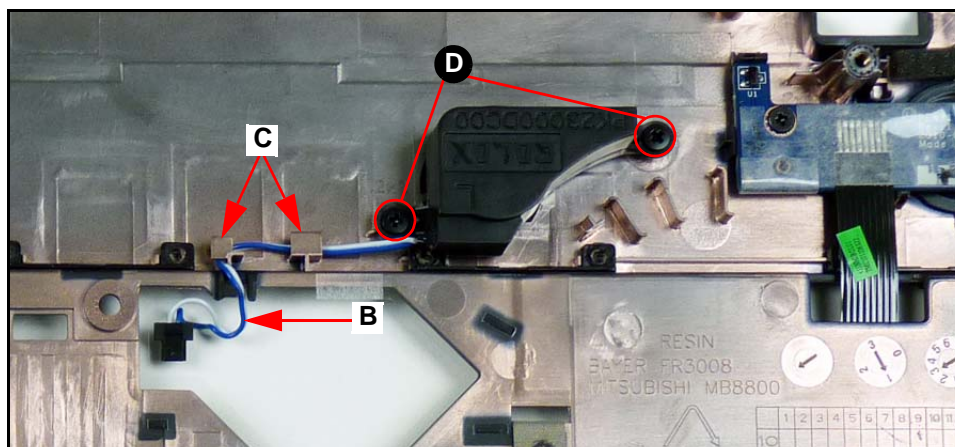

**Figure 3-21. Speaker**

4. Remove speaker from upper cover.



## Speaker Installation

---

1. Install speaker (A) on upper cover. (Figure 3-20)
2. Install and secure two (2) screws (D). (Figure 3-21)
3. Install speaker cable (B) into cable guides (C). (Figure 3-21)
4. Install upper cover.

ID	Size	Quantity	Screw Type
D	M2.5*3.0	2	

# Power Board Removal

---

## Prerequisite:

### Upper Cover Removal

1. Find power board (B) on upper cover. (Figure 3-20)
2. Remove power board FFC (Flat Flex Cable) (A) from upper cover. (Figure 3-22)
3. Remove one (1) screw (B). (Figure 3-22)

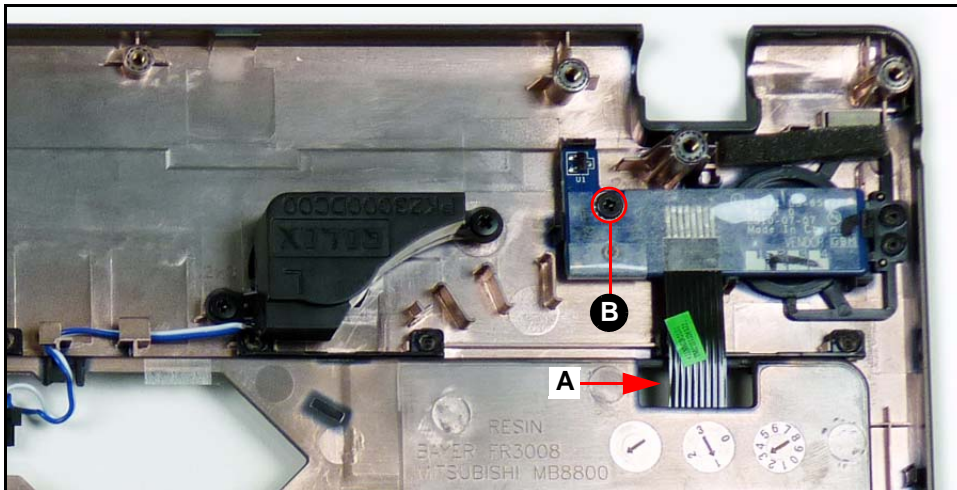

**Figure 3-22. Power Board**

4. Remove power board from upper cover.

# Power Board Installation

---

1. Install power board (B) on upper cover. (Figure 3-20)
2. Install power board FFC (A) on upper cover. (Figure 3-22)
3. Install and secure one (1) screw (B) to lower cover. (Figure 3-22)
4. Install upper cover.

ID	Size	Quantity	Screw Type
B	M2.5*3.0	1	

# Touchpad Removal

---

## Prerequisite:

### Upper Cover Removal

1. Find touchpad (C) on upper cover. (Figure 3-20)
2. Remove touchpad FFC (A) from touchpad. (Figure 3-23)
3. Disconnect and remove touchpad FFC (A) from touchpad connector (B). (Figure 3-23)

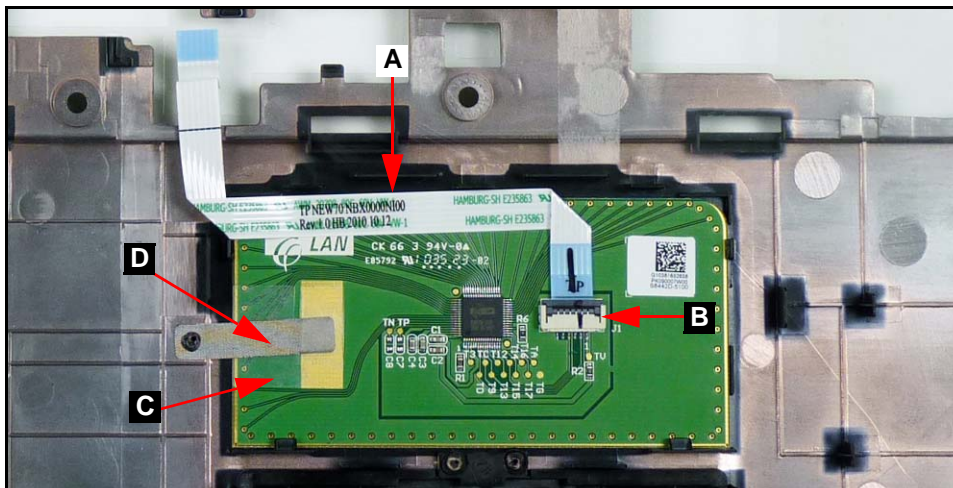

**Figure 3-23. Touchpad**

4. Lift plastic cover (C) securing the grounding tape and remove grounding tape (D) from touchpad. (Figure 3-23)
5. Remove touchpad from upper cover.

# Touchpad Installation

---

1. Install touchpad (C) on upper cover. (Figure 3-20)
2. Lift plastic cover (C) and install grounding tape (D) onto touchpad. (Figure 3-23)

### ⇒ NOTE:

Make sure the grounding tape is touching the connective section of the touchpad as shown in Figure 3-23.

3. Connect touchpad FFC (A) to touchpad connector (B). (Figure 3-23)
4. Install touchpad FFC to touchpad. (Figure 3-23)
5. Install upper cover.

# USB Board Removal

---

## Prerequisite:

### Upper Cover Removal

1. Find USB (Universal Serial Bus) board (A) on lower cover. (Figure 3-24)

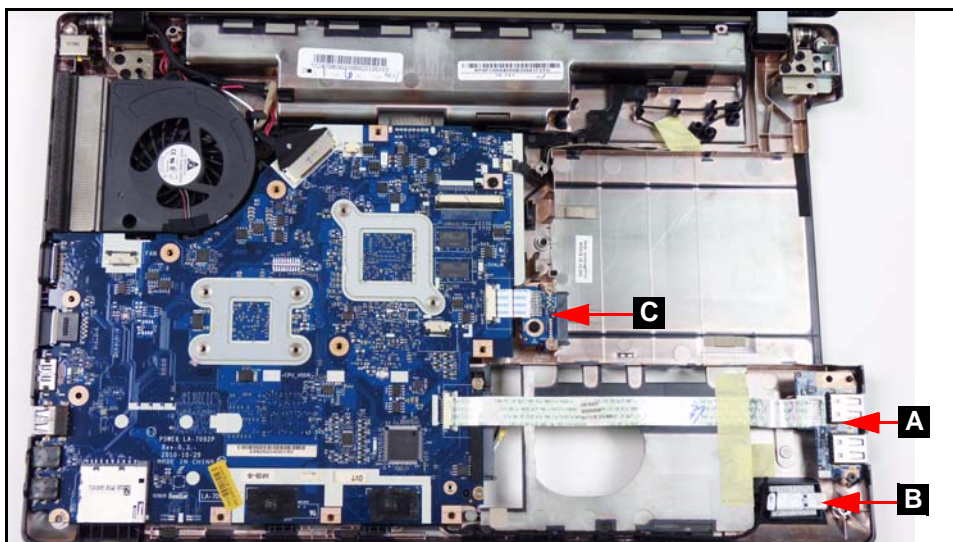

**Figure 3-24. Component Location**

2. Remove adhesive tape securing the USB board FFC. (Figure 3-25)
3. Disconnect USB board FFC (A) from module connector (B). (Figure 3-25)
4. Disconnect and remove USB board FFC (A) from mainboard connector (C). (Figure 3-25)

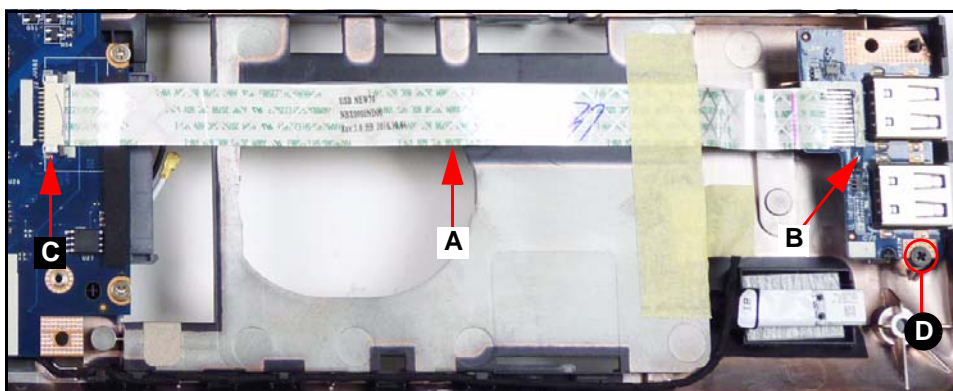

**Figure 3-25. USB Module**

5. Remove screw (D) from lower cover. (Figure 3-25)
6. Remove USB module from lower cover.

## USB Board Installation

---

1. Install USB board (F) on lower cover. ([Figure 3-24](#))
2. Install and secure screw (D) to lower cover. ([Figure 3-25](#))
3. Connect USB board FFC (A) to module connector (B). ([Figure 3-25](#))
4. Connect USB board FFC (A) to mainboard connector (C). ([Figure 3-25](#))
5. Install upper cover.

ID	Size	Quantity	Screw Type
D	M2.5*3.0	1	

## ODD Board Removal

---

### Prerequisite:

#### Upper Cover Removal

1. Find ODD board (C) on lower cover. (Figure 3-24)
2. Disconnect ODD board FFC from mainboard connector (A). (Figure 3-26)

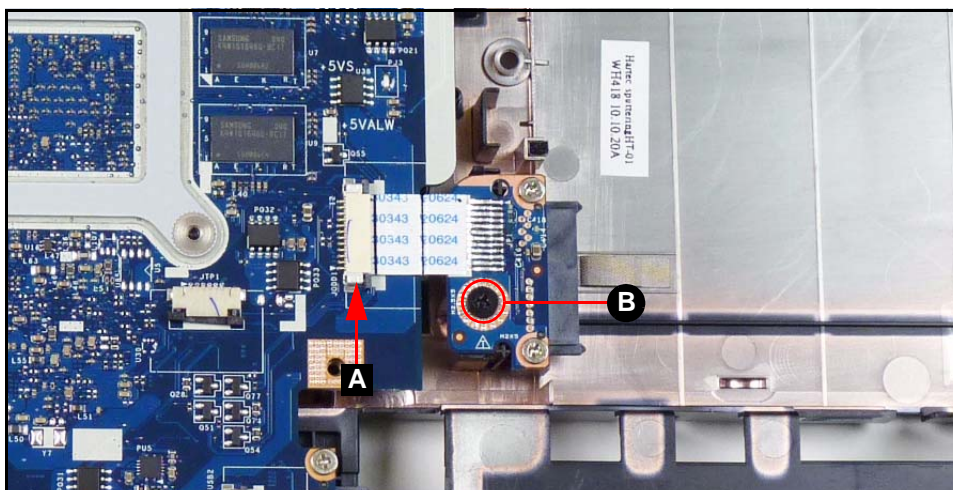

**Figure 3-26. ODD Board**

3. Remove screw (B) from lower cover. (Figure 3-26)
4. Remove ODD board from lower cover.

## ODD Board Installation

---

1. Install USB module (C) on lower cover. (Figure 3-24)
2. Install and secure screw (B) to lower cover. (Figure 3-26)
3. Connect ODD board FFC to mainboard connector (A). (Figure 3-26)
4. Install upper cover.

ID	Size	Quantity	Screw Type
B	M2.5*5.0	1	

## Bluetooth Board Removal

---

### Prerequisite:

#### Upper Cover Removal

1. Find Bluetooth board (B) on upper cover. (Figure 3-24)
2. Disconnect Bluetooth cable (B) from Bluetooth board connector (A). (Figure 3-27)

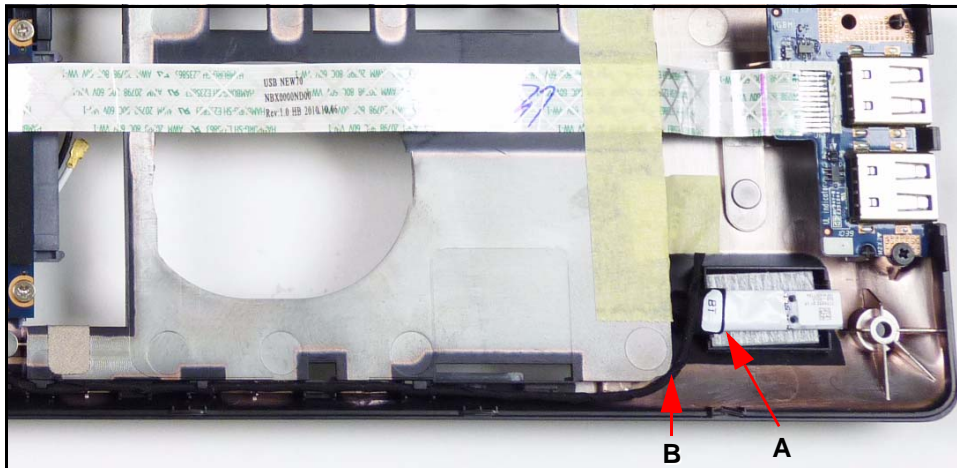

**Figure 3-27. Bluetooth Module**

3. Remove the Bluetooth board from the lower cover. (Figure 3-27)

## Bluetooth Board Installation

---

1. Connect Bluetooth cable (B) to Bluetooth board connector (A). (Figure 3-27)
2. Install and secure Bluetooth board to lower cover. (Figure 3-27)
3. Install upper cover.

# Mainboard Removal

---

## Prerequisite:

[ODD Board Removal](#)

[Bluetooth Board Removal](#)

[USB Board Removal](#)

1. Find mainboard (A) on lower cover. (Figure 3-28)

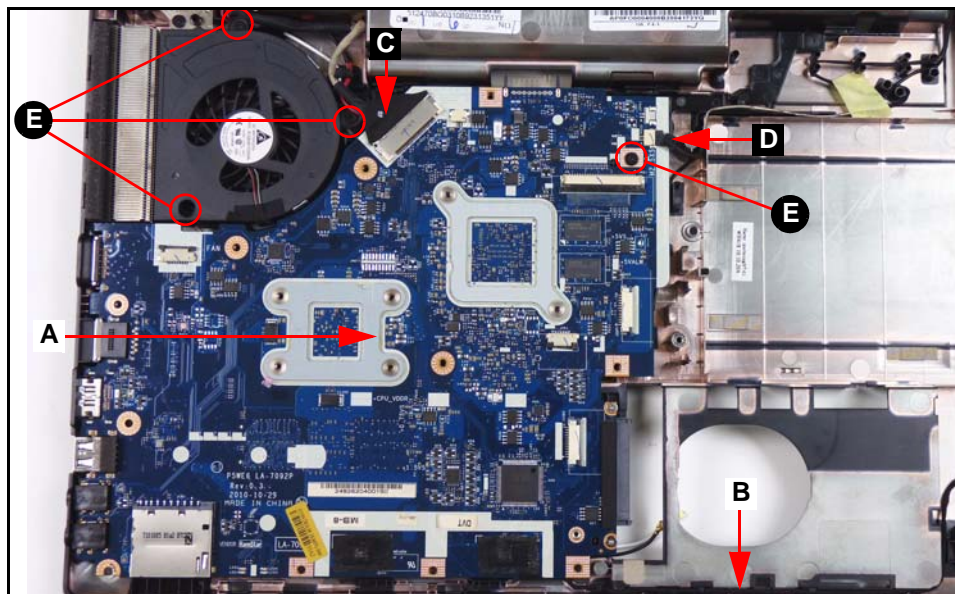
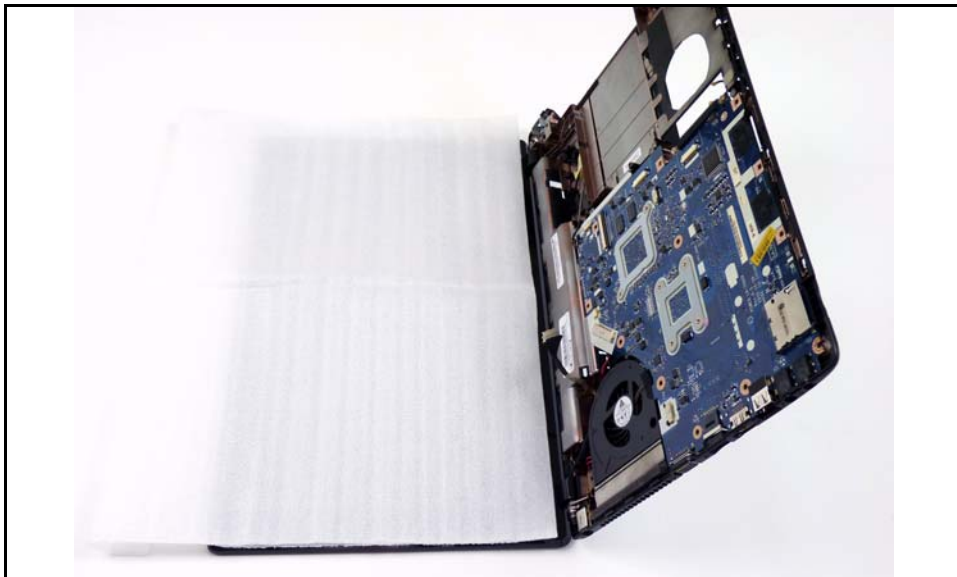

**Figure 3-28. Mainboard Location**

2. Remove Bluetooth cable (B) from cable guides. (Figure 3-28)
3. Disconnect LVDS cable from mainboard connector (C). (Figure 3-28)
4. Disconnect microphone cable from mainboard connector (D). (Figure 3-28)
5. Remove four (4) screws (E) from the mainboard and thermal module. (Figure 3-28)
6. Put computer with the LCD module flat on the surface. ([Figure 3-29](#))



7. To avoid damage, put a nonabrasive, protective cover over the LCD panel. (Figure 3-29)

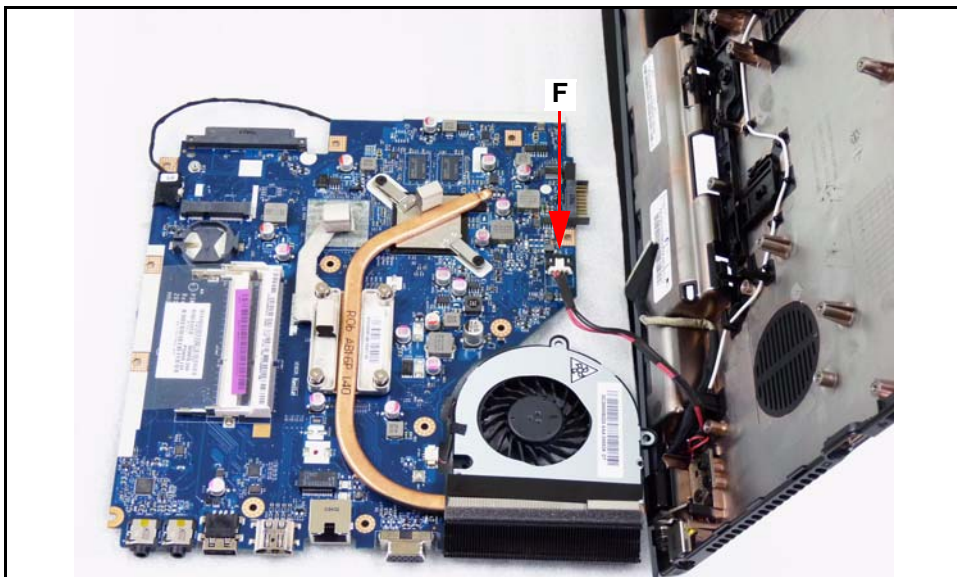

**Figure 3-29. Mainboard**

8. Lift the mainboard from the lower cover and turn it over onto the LCD panel. (Figure 3-30)

**⚠ CAUTION:**

Do not remove the mainboard completely. The DC-IN cable is still connected to the mainboard.



**Figure 3-30. Mainboard**

9. Disconnect the DC-IN cable from the mainboard connector (F). (Figure 3-30)
10. Remove mainboard from the device.

11. Disconnect Bluetooth cable from mainboard connector (G). (Figure 3-28)

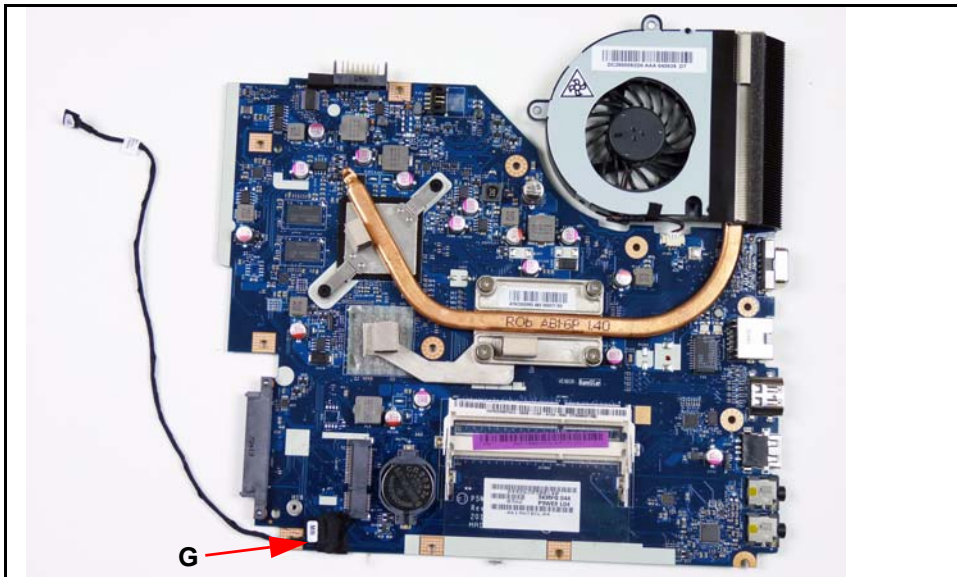

**Figure 3-31. Mainboard**

## Mainboard Installation

1. Connect Bluetooth cable to mainboard connector (G). (Figure 3-31)
2. Put computer with the LCD module flat on the surface. (Figure 3-29)
3. Put a nonabrasive, protective cover over the LCD panel. (Figure 3-29)
4. Connect DC-IN cable to mainboard connector (F). (Figure 3-30)
5. Put mainboard into lower cover. (Figure 3-28)
6. Install and secure four (4) screws (E) to mainboard. (Figure 3-28)
7. Connect LVDS cable (C) to mainboard connector. (Figure 3-28)
8. Connect microphone cable (D) to mainboard connector. (Figure 3-28)
9. Put Bluetooth cable (B) into cable guides. (Figure 3-28)
10. Install USB board.
11. Install ODD board.
12. Install Bluetooth board.

ID	Size	Quantity	Screw Type
E	M2.5*5.0	4	

# Fan Removal

---

## Prerequisite:

### Mainboard Removal

1. Find fan (A) on mainboard. (Figure 3-32)

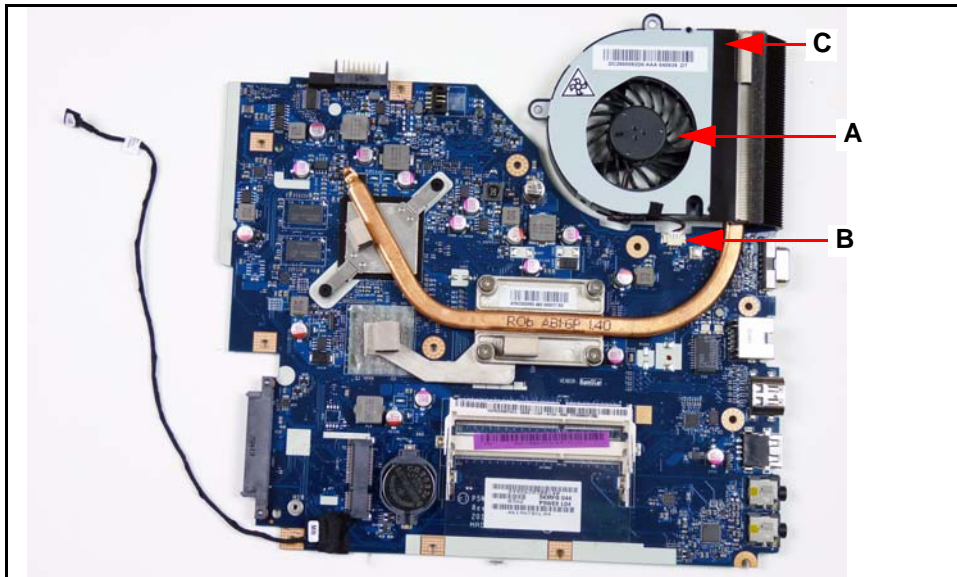

**Figure 3-32. Fan Location**

2. Disconnect fan cable from mainboard connector (B). (Figure 3-32)
3. Remove adhesive tape (C) securing the fan to the heatsink. (Figure 3-32)
4. Remove fan from heatsink.

# Fan Installation

---

1. Put flat edge of fan next to heatsink. (Figure 3-32)
2. Secure fan to heatsink with adhesive tape (C). (Figure 3-32)
3. Connect fan to mainboard connector (B). (Figure 3-32)
4. Install mainboard.

# Heatsink Removal

---

## Prerequisite:

### Fan Removal

1. Find heatsink (A) on mainboard. (Figure 3-33)
2. Remove four (4) thermal screws (B) from heatsink. (Figure 3-33)
3. Loosen two (2) captive screws (C) from heatsink. (Figure 3-33)

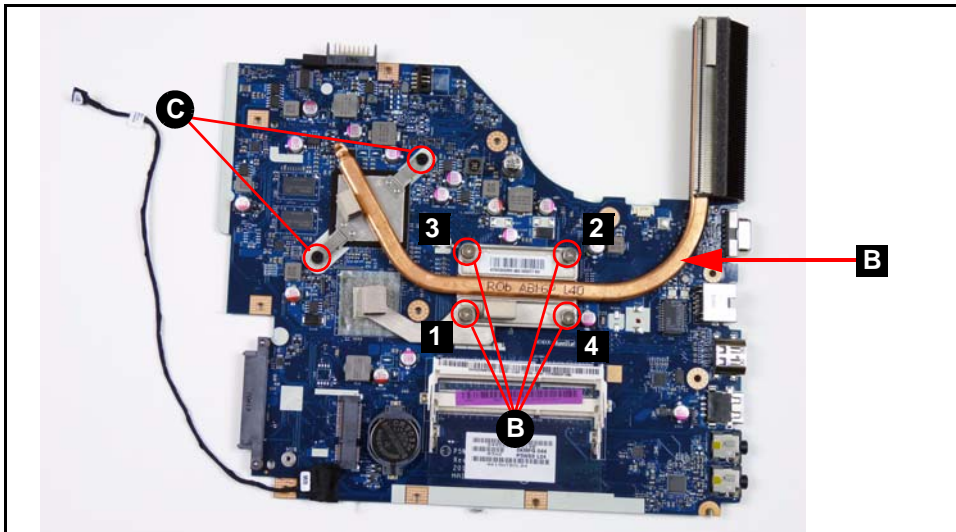

**Figure 3-33. Thermal Module**

4. Remove heatsink from mainboard.

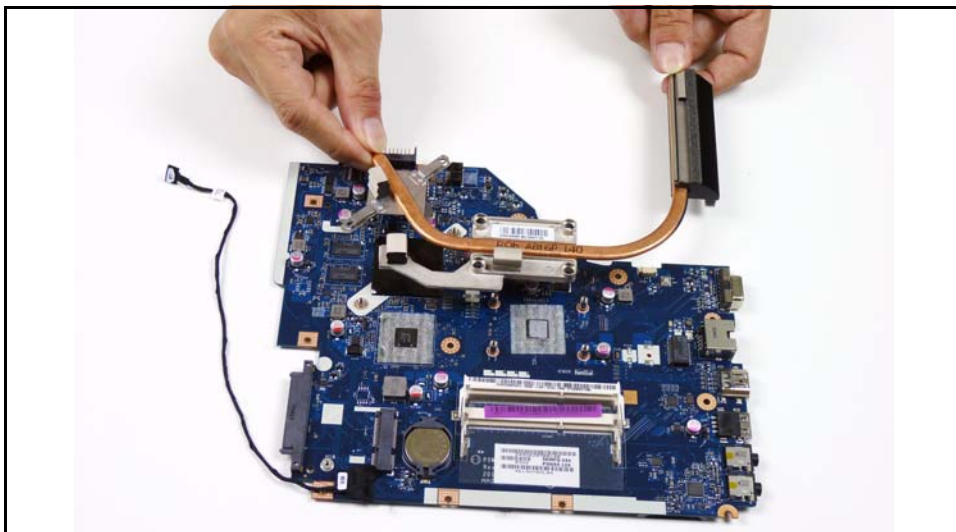

**Figure 3-34. Thermal Module**

# Heatsink Installation

---

+ **IMPORTANT:**

Apply suitable thermal grease and make sure all heat pads are in position before replacing module.

**⚠ CAUTION:**

Thermal grease can damage mainboard. Use caution when applying.

The following thermal grease types are approved for use:

- Silmore GP50
- Honeywell
- Jet Motor 7762

The following thermal pads are approved for use:

- Eapus XR-PE
1. Remove all traces of thermal grease from CPU using a lint-free cloth or cotton swab and Isopropyl Alcohol, Acetone, or other approved cleaning agent.
  2. Apply small amount of thermal grease to center of CPU.

**⇒ NOTE:**

Force used during installation of thermal module is sufficient to spread grease over CPU top.

3. Install and secure four (4) thermal screws (B) in numerical order from one (1) to four (4) to mainboard. (Figure 3-32)
4. Install and secure two (2) captive screws (C) to mainboard. (Figure 3-32)
5. Install fan.



**Figure 3-35. Thermal Module**

+ **IMPORTANT:**

Circuit boards >10 cm<sup>2</sup> have been highlighted with a yellow rectangle as shown in Figure 3-35. Remove the Circuit board and follow local regulations for disposal.

ID	Size	Quantity	Screw Type
B	ICW50 CPU Thermal Screw	4	

# LCD (Liquid Crystal Display) Module Removal

---

## Prerequisite:

[Mainboard Removal](#)

1. Remove four (4) screws (A) from LCD hinges. (Figure 3-36)

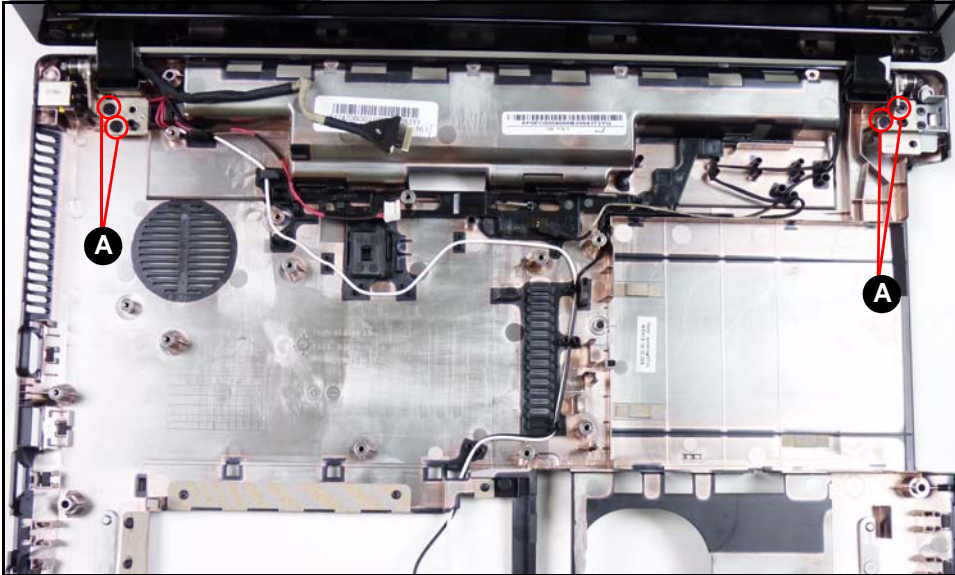

**Figure 3-36. LCD Hinge Screws**

2. Remove the upper cover from the LCD module. (Figure 3-37)

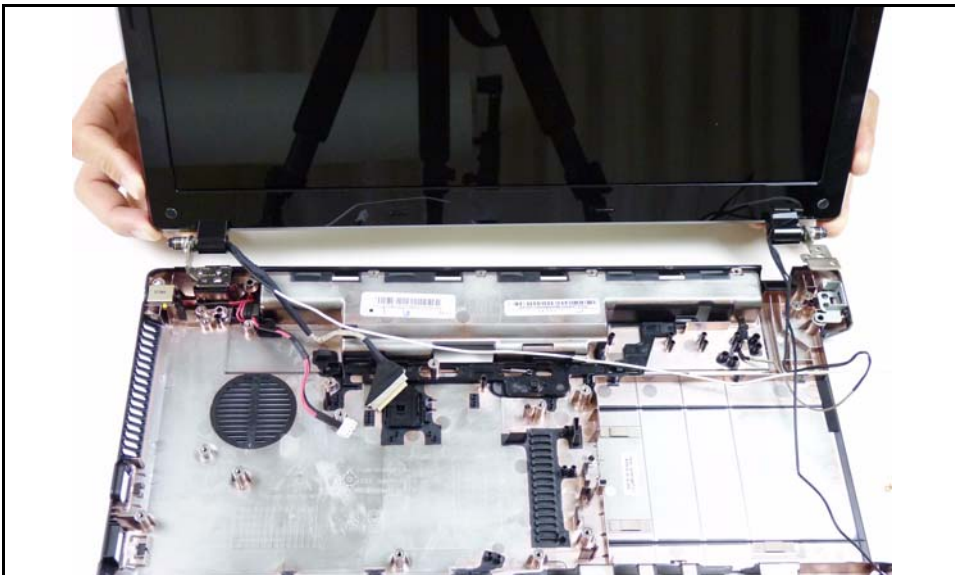

**Figure 3-37. LCD Module**

**⚠ CAUTION:**

Make sure all cables are moved away from the device to avoid damage during removal.

## LCD Module Installation

---

1. Align LCD hinges with the hinge guides on the upper cover. ([Figure 3-37](#))
2. Install and secure four (4) screws (A). ([Figure 3-36](#))
3. Install mainboard.

ID	Size	Quantity	Screw Type
A	M2.5*5.0	4	



# DC-IN Cable Removal

---

## Prerequisite:

[Mainboard Removal](#)

1. Find DC-IN (Direct Current Input) cable (A) in lower cover. (Figure 3-38)

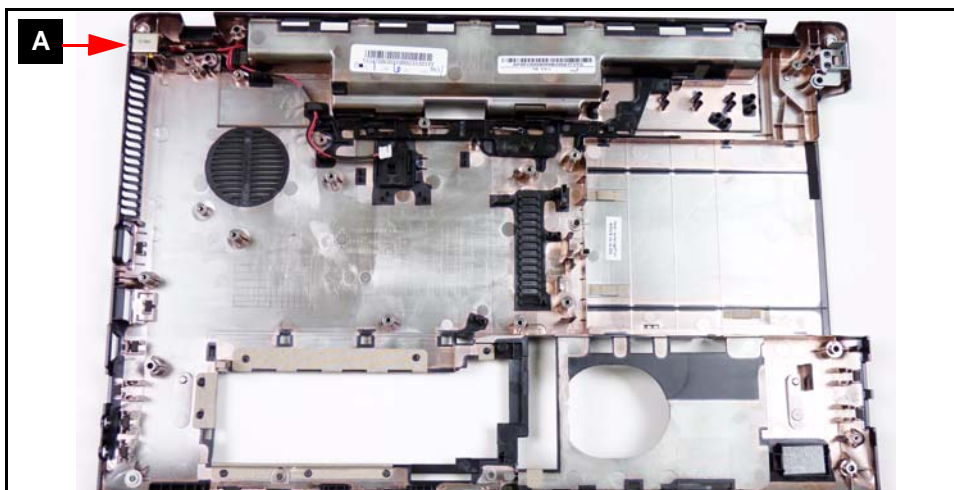

---

**Figure 3-38. DC-IN Cable Location**

2. Remove DC-IN cable from cable guides (B). (Figure 3-39)

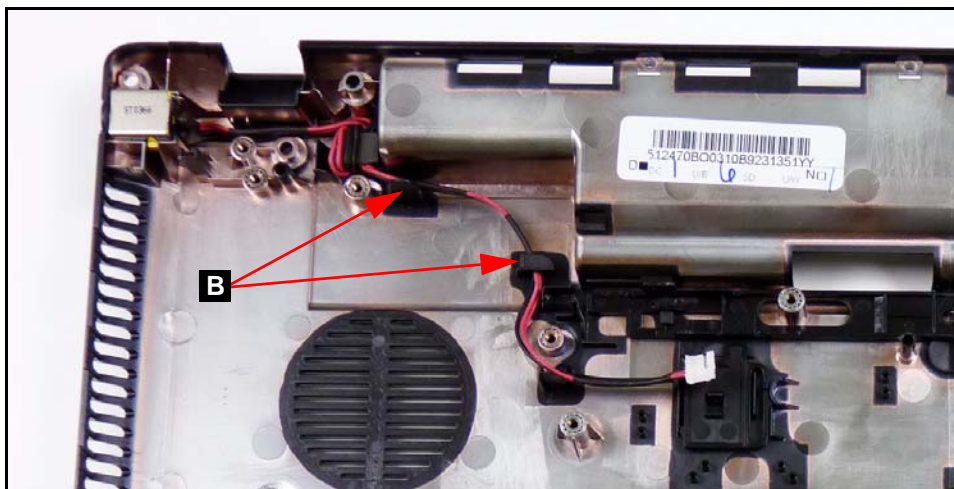

---

**Figure 3-39. DC-IN Cable**

3. Remove DC-IN cable from lower cover. (Figure 3-39)

## DC Cable Installation

---

1. Install DC-IN cable to lower cover (A). ([Figure 3-38](#))
2. Install DC-IN cable into cable guides (B). ([Figure 3-39](#))
3. Install mainboard.

## LCD Bezel Removal

---

### Prerequisite:

#### [LCD \(Liquid Crystal Display\) Module Removal](#)

1. Remove two screw caps. (Figure 3-40)
2. Remove two (2) screws (A) from the LCD module. (Figure 3-40)

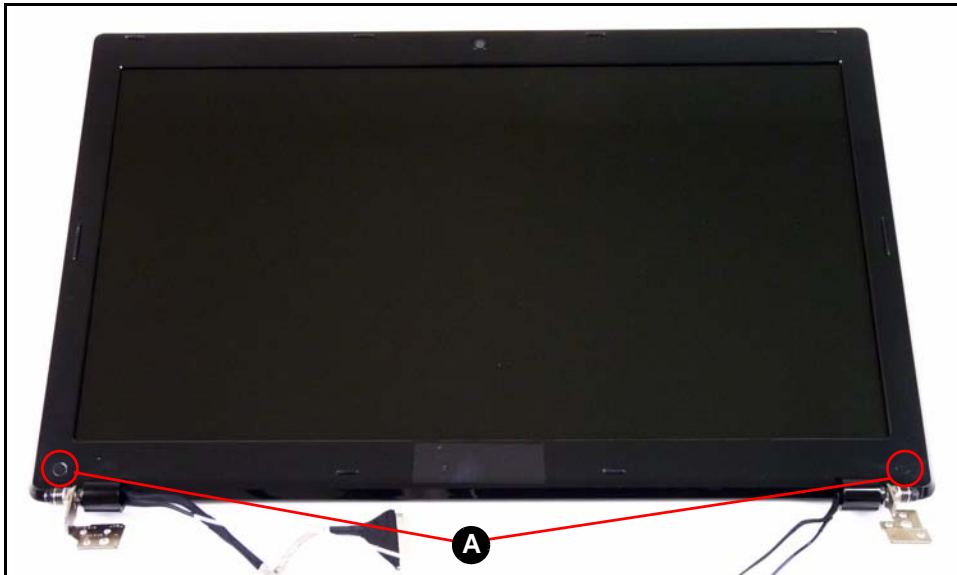

---

**Figure 3-40. LCD Bezel**

3. Lift the bottom of the bezel up releasing it from the latches. (Figure 3-41)

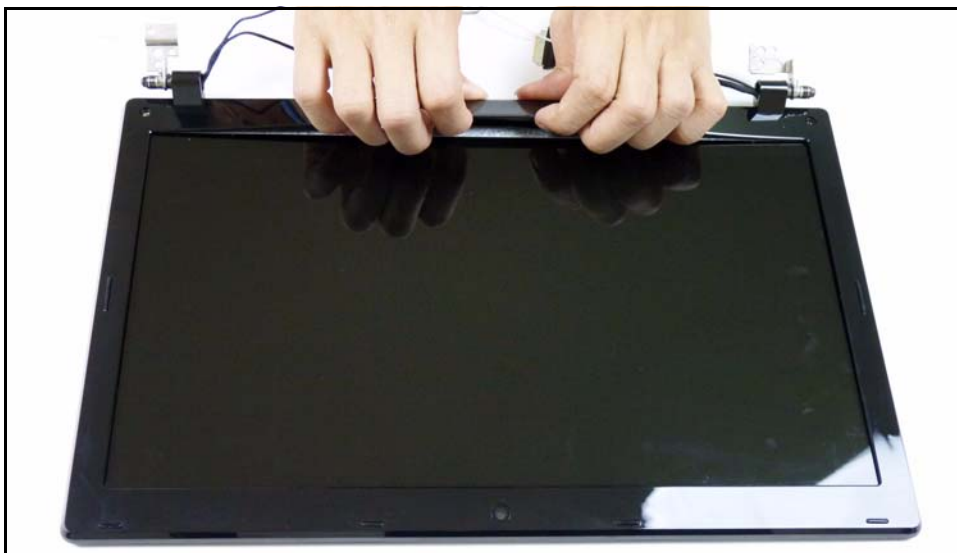

---

**Figure 3-41. LCD Bezel**

4. Continue releasing the latches along the sides of the bezel. (Figure 3-42)



**Figure 3-42. LCD Bezel**

5. Lift the bezel from LCD module. (Figure 3-43)

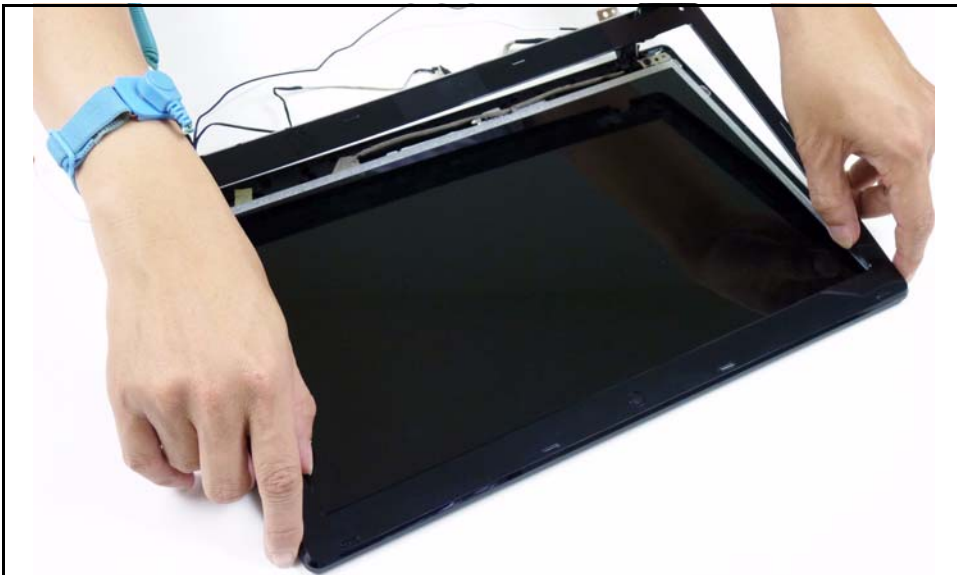

**Figure 3-43. LCD Bezel**

## LCD Bezel Installation

---

1. Put LCD bezel on the LCD module. (Figure 3-40)
2. Press along the edges of the LCD bezel to secure the latches on the LCD module.
3. Install and secure two (2) screws (A) to the LCD bezel. (Figure 3-40)
4. Install LCD module to lower cover.

ID	Size	Quantity	Screw Type
A	M2.5*6.0	2	

# Camera Module Removal

---

## Prerequisite:

[LCD Bezel Removal](#)

1. Find the camera module (A) in the LCD module. (Figure 3-44)



---

**Figure 3-44. Camera Module Location**

2. Disconnect the camera cable (B) from the camera module connector (C). (Figure 3-45)

⇒ **NOTE:**

Take care not to damage the cable.

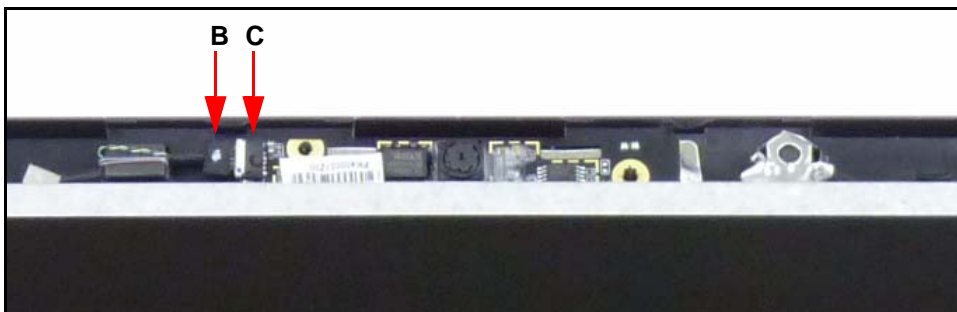

---

**Figure 3-45. Camera Cable**

3. Lift the camera module from the LCD cover.

## Camera Module Installation

---

1. Put camera module (A) on the LCD module. ([Figure 3-44](#))
2. Connect the camera cable (B) to the camera module connector (C). ([Figure 3-45](#))
3. Install LCD bezel.

# LCD Panel Removal

---

## Prerequisite:

[LCD Bezel Removal](#)

1. Remove the four (4) securing screws (A) from the LCD panel (B). (Figure 3-46)

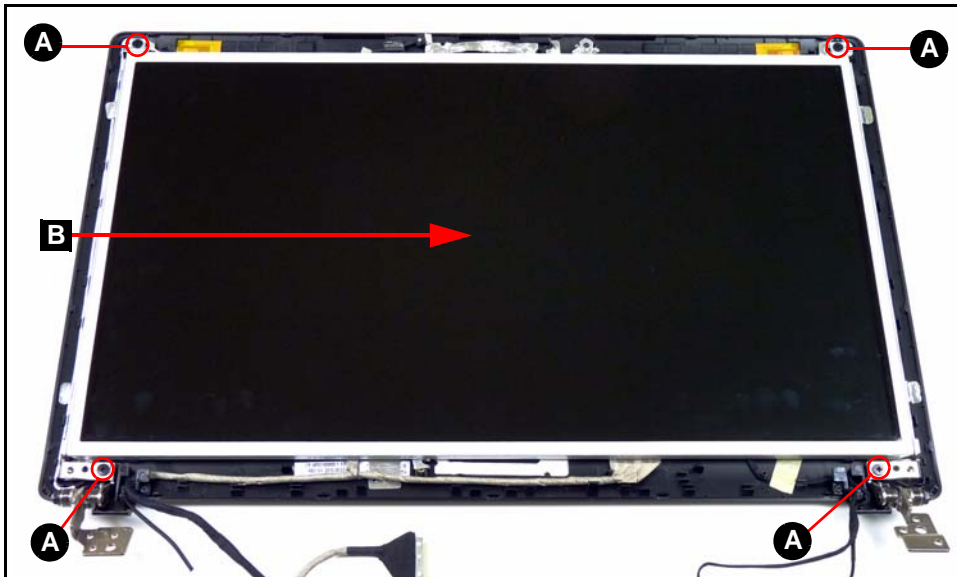

---

**Figure 3-46. LCD Panel**

2. Remove the LVDS cable (C) from the cable guides. (Figure 3-47)

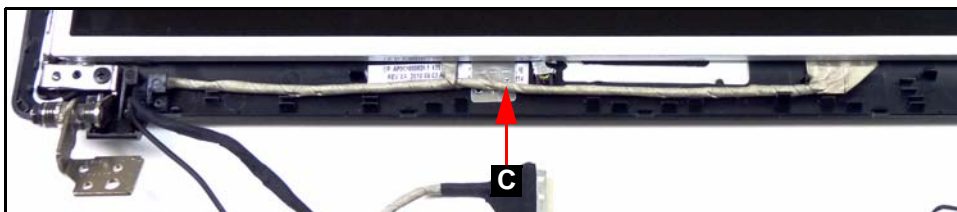

---

**Figure 3-47. LVDS Cable**

3. Lift the LCD panel (B) from LCD cover. (Figure 3-46)



## LCD Panel Installation

---

1. Put LCD panel (B) on the LCD cover. (Figure 3-46)
2. Put LVDS cable (C) in the cable guides. (Figure 3-47)
3. Install and secure four (4) screws (A) to the LCD panel. (Figure 3-46)
4. Install LCD bezel.

ID	Size	Quantity	Screw Type
A	M2.5*4.0	6	

# LCD Bracket Removal

---

## Prerequisite:

[LCD Panel Removal](#)

1. Remove the six (6) screws (A). (Figure 3-48)



**Figure 3-48. LCD Bracket**

2. Remove LCD bracket from the LCD panel.

# LCD Bracket Installation

---

1. Put LCD bracket on the LCD panel. (Figure 3-48)
2. Install and secure six (6) screws (A) to the LCD bracket. (Figure 3-48)
3. Install LCD panel to LCD cover.

ID	Size	Quantity	Screw Type
A	M2.0*3.0	6	

# LVDS Cable Removal

---

## Prerequisite:

### [LCD Panel Removal](#)

1. Remove LVDS (Low-voltage Differential Signaling) cable (A) from the adhesive on the rear of the LCD panel. (Figure 3-49)

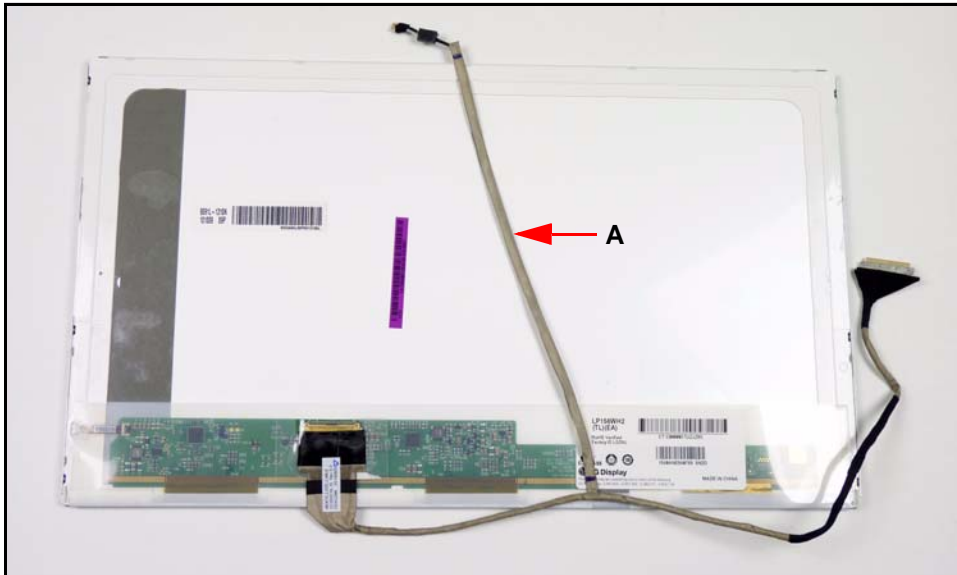

---

**Figure 3-49. LVDS Cable**

2. Starting from the top, remove the clear mylar tape (B). (Figure 3-50)
3. Disconnect the LVDS cable from the LCD panel connector (C). (Figure 3-50)

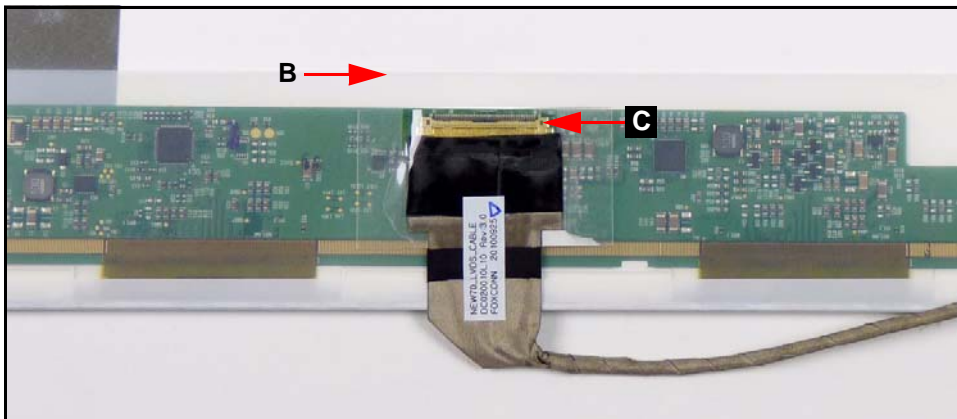

---

**Figure 3-50. LVDS Cable**

## LVDS Cable Installation

---

1. Put LVDS cable into the LCD panel connector (C) and secure the clear mylar tape (B).  
([Figure 3-50](#))
2. Put LVDS cable (A) on the rear of the LCD panel. ([Figure 3-49](#))
3. Install LCD panel to LCD cover.

# Microphone Set Removal

---

## Prerequisite:

[LCD Panel Removal](#)

1. Locate microphone set (A) in LCD cover. (Figure 3-51)

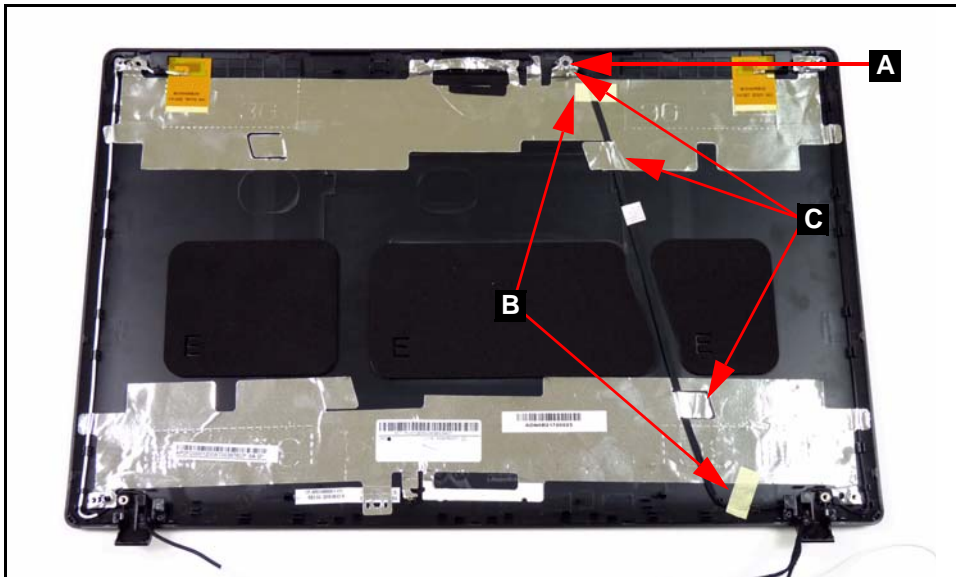

---

**Figure 3-51. Microphone Set**

2. Remove adhesive tape (B) securing the microphone cable. (Figure 3-51)
3. Remove tabs (C) away from microphone set. (Figure 3-51)
4. Remove microphone set from LCD cover.

# Microphone Set Installation

---

1. Put microphone set on LCD cover. (Figure 3-51)
2. Fold tabs (C) over to secure microphone set. (Figure 3-51)
3. Put adhesive tape onto microphone cable to secure it to LCD cover. (Figure 3-51)
4. Install LCD panel.

# WLAN Antenna Removal

---

## Prerequisite:

[LCD Panel Removal](#)

1. Remove black (B) and white (A) WLAN antennas. (Figure 3-52)

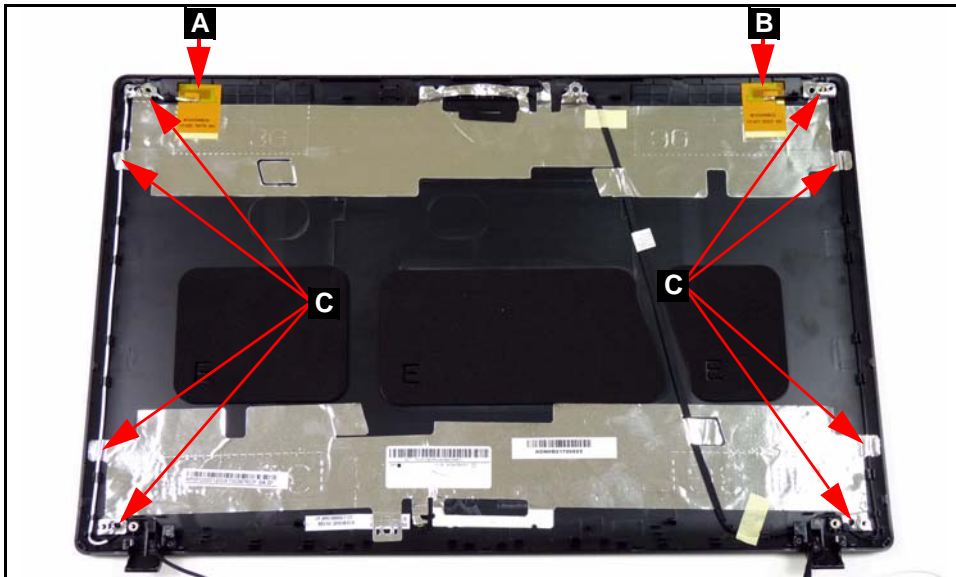

---

**Figure 3-52. WLAN Antenna**

2. Lift foil (C) from antenna cables. (Figure 3-52)
3. Remove antenna cables from cable guides. (Figure 3-52)

# WLAN Antenna Installation

---

1. Put antenna cables into cable guides. (Figure 3-52)
2. Replace foil (C) to secure antenna cables. (Figure 3-52)
3. Put black (A) and white (B) antennas onto LCD cover. (Figure 3-52)
4. Install LCD panel.

# CHAPTER 4

## Troubleshooting

---

<b>Introduction</b> .....	<b>4-3</b>
<b>General Information</b> .....	<b>4-3</b>
Power On Issues .....	4-4
No Display Issues .....	4-5
LCD Failure .....	4-7
Keyboard Failure .....	4-8
Touchpad Failure .....	4-9
Internal Speaker Failure .....	4-10
Microphone Failure .....	4-12
USB Failure .....	4-13
Wireless Failure .....	4-14
Bluetooth Failure .....	4-15
Card Reader Failure .....	4-16
Thermal Module Failure .....	4-17
Cosmetic Failure .....	4-18
Other Functions Failure .....	4-19
<b>Intermittent Problems</b> .....	<b>4-20</b>
<b>Undetermined Problems</b> .....	<b>4-20</b>
<b>Post Codes</b> .....	<b>4-21</b>



# Troubleshooting

---

## Introduction

---

This chapter contains information about troubleshooting common problems associated with the notebook.

## General Information

---

The following procedures are a guide for troubleshooting computer problems. The step by step procedures are designed to be performed as described.

⇒ **NOTE:**

The diagnostic tests are intended for Acer products only. Non-Acer products, prototype cards, or modified options can give false errors and invalid system responses.

1. Obtain as much detailed information as possible about the problem.
2. If possible, verify the symptoms by re-creating the failure through diagnostic tests or repeating the operation that led to the problem.
3. Use Table 4-1 with the verified symptom to determine the solution.

**Table 4-1. Common Problems**

Symptoms (Verified)
<a href="#">Power On Issues</a>
<a href="#">No Display Issues</a>
<a href="#">LCD Failure</a>
<a href="#">Keyboard Failure</a>
<a href="#">Touchpad Failure</a>
<a href="#">Internal Speaker Failure</a>
<a href="#">Microphone Failure</a>
<a href="#">USB Failure</a>
<a href="#">Wireless Failure</a>
<a href="#">Bluetooth Failure</a>
<a href="#">Card Reader Failure</a>
<a href="#">Thermal Module Failure</a>
<a href="#">Cosmetic Failure</a>
<a href="#">Other Functions Failure</a>
<a href="#">Intermittent Problems</a>
<a href="#">Undetermined Problems</a>

4. If the Issue is still not resolved, refer to [Online Support Information](#).

⇒ **NOTE:**

Do not replace non-defective FRU parts.

# Power On Issues

---

If the system does not power on, perform the following:

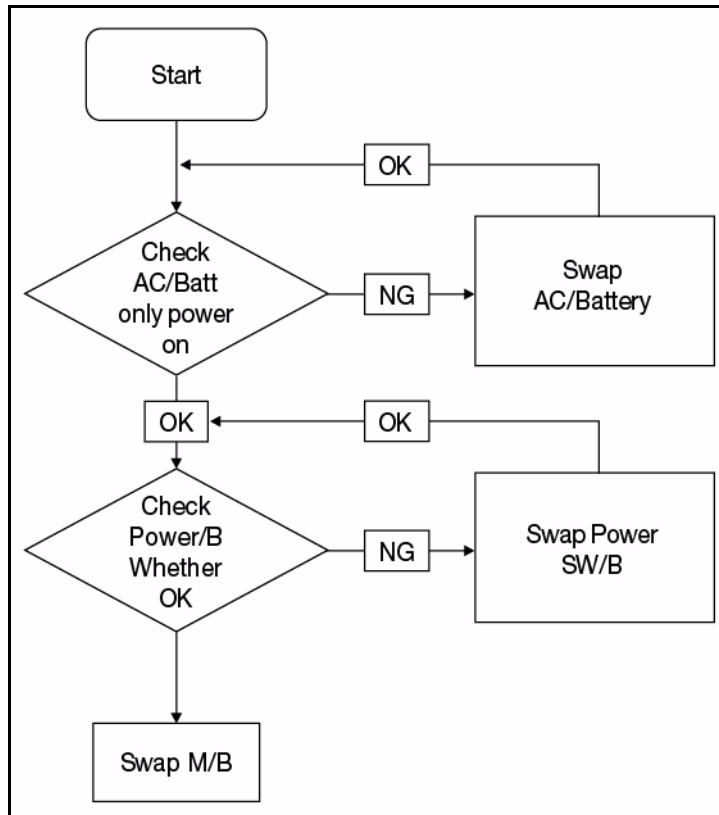

---

**Figure 4-1. Power On Issue**

## Computer Shuts Down Intermittently

If the system powers off at intervals, perform the following.

1. Make sure the power cable is properly connected to the computer and the electrical outlet.
2. Remove all extension cables between the computer and the outlet.
3. Remove all surge protectors between the computer and the electrical outlet. Plug the computer directly into a known serviceable electrical outlet.
4. Disconnect the power and open the casing to check the thermal unit and fan airways are free of obstructions.
5. Remove all external and non-essential hardware connected to the computer that are not necessary to boot the computer to the failure point.
6. Remove any recently installed software.
7. If the Issue is still not resolved, refer to [Online Support Information](#).

# No Display Issues

If the Display does not work, perform the following:

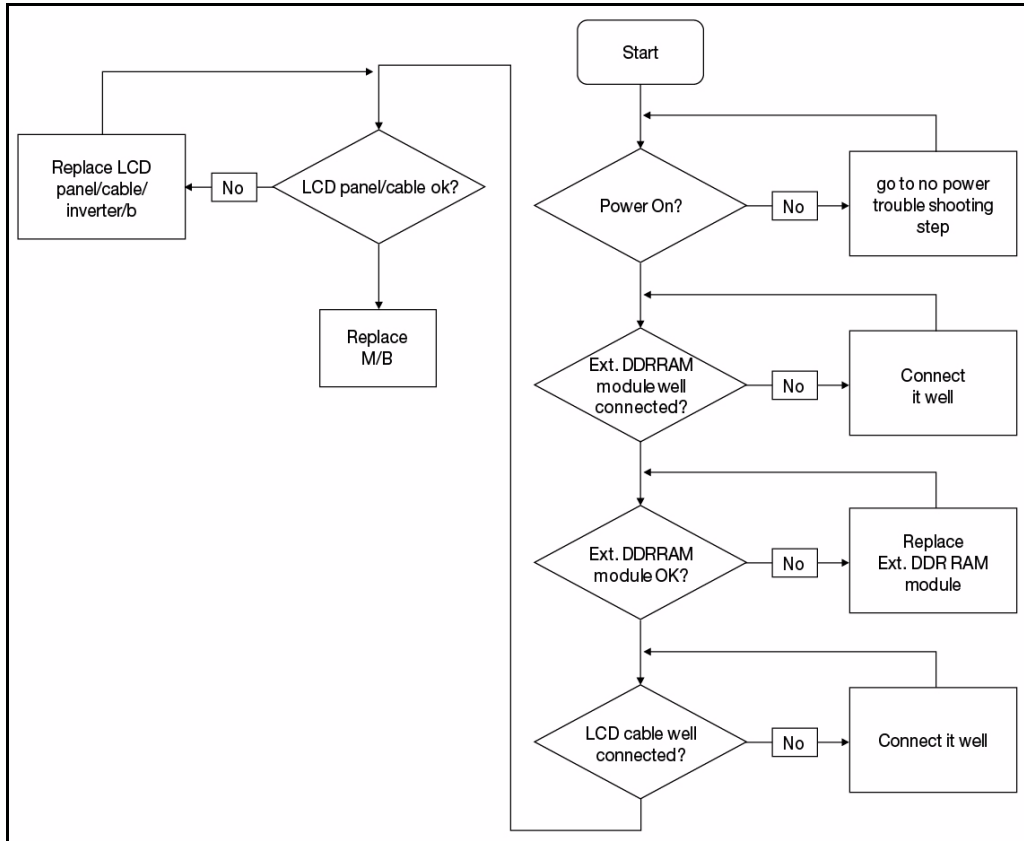

**Figure 4-2. No Display Issue**

## No POST or Video

If the POST or video does not appear, perform the following:

1. Make sure that internal display is selected. Switching between internal and external by pressing **Fn+F5**. Reference product pages for specific model procedures.
2. Make sure the computer has power by checking for one of the following:
  - Fans start up
  - Status LEDs illuminate

If no power, refer to [Power On Issues](#).

3. Drain stored power by removing the power cable and battery. Hold the power button for 10 seconds.
4. Connect the power and reboot the computer.
5. Connect an external monitor to the computer and switch between the internal display and the external display by pressing **Fn+F5**.

6. If the POST or video appears on the external display only, refer to [LCD Failure](#).
7. Disconnect power and all external devices including port replicators or docking stations. Remove any memory cards and CD/DVD discs.
8. Start the computer. If the computer boots correctly, add the devices one by one until the failure point is discovered.
9. Reseat the memory modules.
10. Remove the drives (refer to [Maintenance Flowchart](#)).
11. If the Issue is still not resolved, refer to [Online Support Information](#).

## Abnormal Video

If the video appears abnormal, perform the following:

1. Boot the computer.
  - If permanent vertical/horizontal lines or dark spots appear in the same location, the LCD is faulty and should be replaced. Refer to Disassembly Process.
  - If extensive pixel damage is present (different colored spots in the same locations on the screen), the LCD is faulty and should be replaced. Refer to [Maintenance Flowchart](#).

### ⇒ NOTE:

Make sure that the computer is not running on battery alone as this may reduce display brightness.

2. Adjust the brightness to its highest level. Refer to the User Manual for instructions on adjusting the settings. If the display is too dim at the highest brightness setting, the LCD is faulty and should be replaced. Refer to *Disassembly Process*.
3. Check the display resolution is correctly configured:
  - Minimize or close all Windows.
  - If display size is only abnormal in an application, check the view settings and control/mouse wheel zoom feature in the application.
  - If desktop display resolution is not normal, right-click on the desktop and select *Personalize Display Settings*.
  - Click and drag the Resolution slider to the desired resolution.
  - Click **Apply** and check the display. Readjust if necessary.
4. Roll back the video driver to the previous version if updated.
5. Remove and reinstall the video driver.
6. Check the Device Manager to determine that:
  - The device is properly installed. There are no red Xs or yellow exclamation marks
  - There are no device conflicts
  - No hardware is listed under *Other Devices*
7. If the Issue is still not resolved, refer to [Online Support Information](#).
8. Run the *Windows Memory Diagnostic* from the operating system DVD and follow the on-screen prompts.
9. If the issue is still not resolved, refer to [Online Support Information](#).

# LCD Failure

---

If the LCD fails, perform the following:

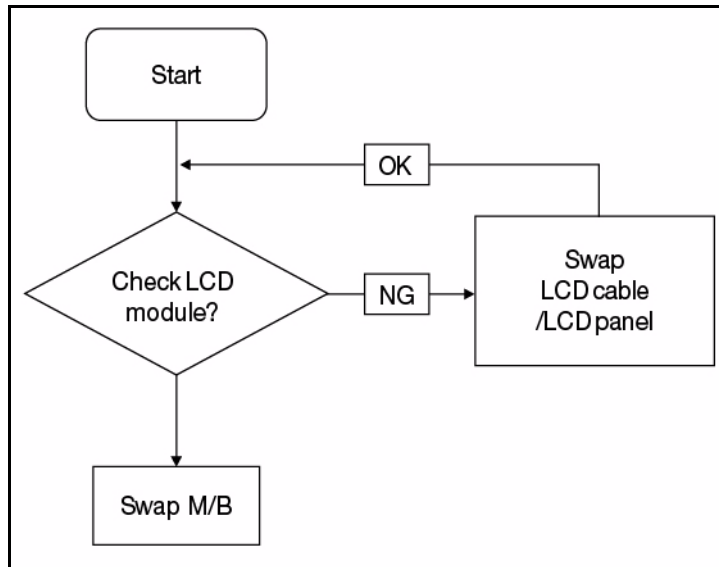

---

**Figure 4-3. LCD Failure**

# Keyboard Failure

---

If the Keyboard fails, perform the following:

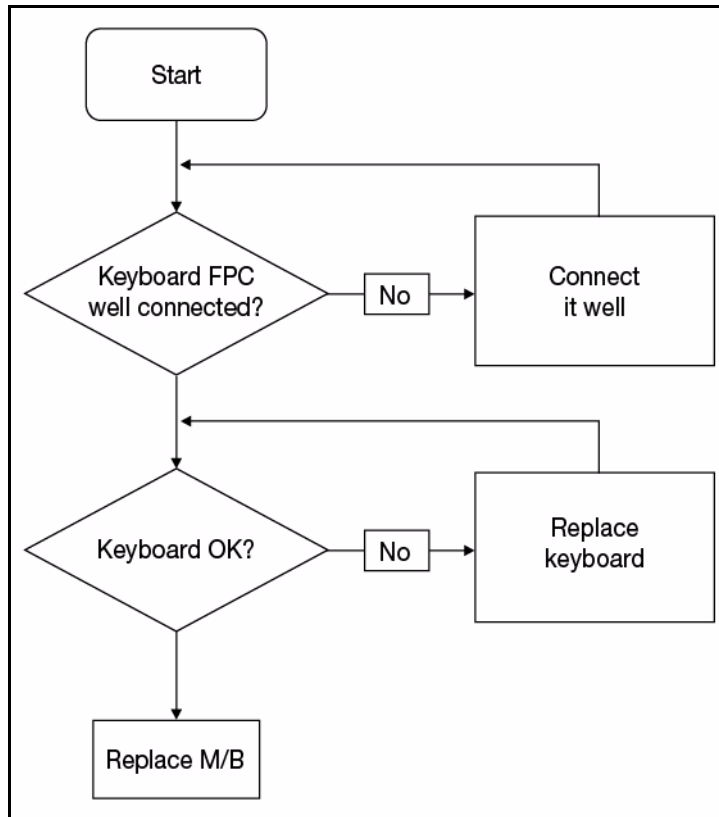

---

**Figure 4-4. Keyboard Failure**

# Touchpad Failure

---

If the Touchpad fails, perform the following:

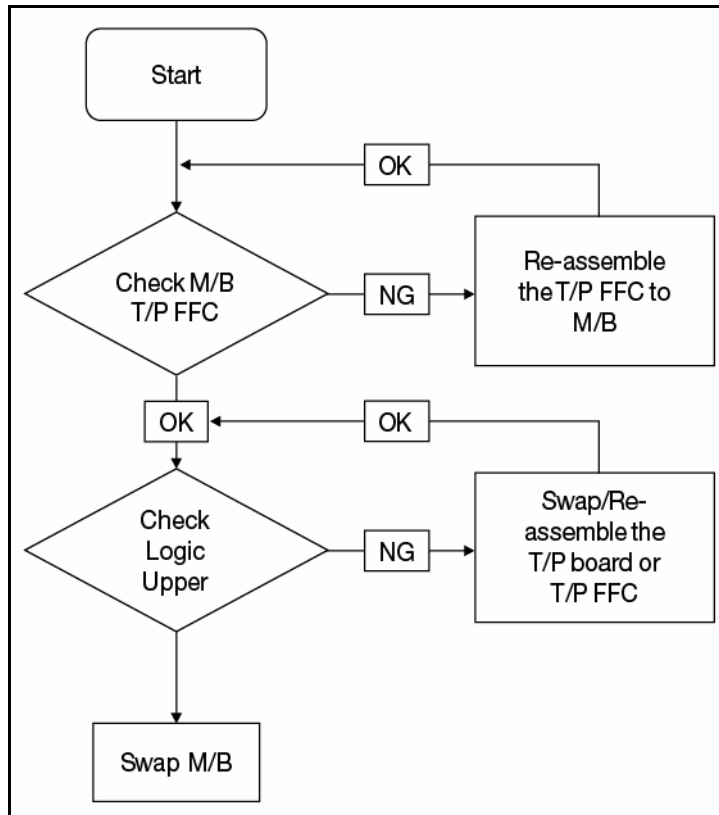

---

**Figure 4-5. Touchpad Failure**

# Internal Speaker Failure

---

If internal Speakers fail, perform the following:

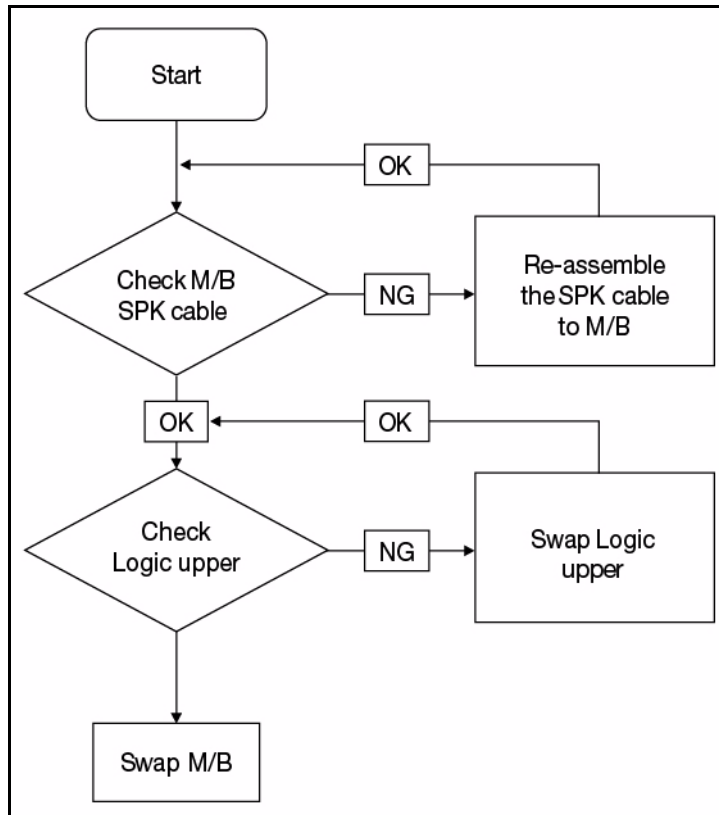

---

**Figure 4-6. Internal Speaker Failure**

## Sound Problems

Perform the following:

1. Boot the computer.
2. Navigate to **Start** → **Control Panel** → **System and Maintenance** → **System** → **Device Manager**. Check the Device Manager to determine that:
  - The device is properly installed
  - There are no red Xs or yellow exclamation marks
  - There are no device conflicts
  - No hardware is listed under Other Devices
3. If updated recently, roll back the audio driver to the previous version.
4. Remove and reinstall the audio driver.
5. Make sure that all volume controls are set mid range:
  - Click the volume icon on the taskbar
  - Drag the slider to 50. Confirm that the volume is not muted.
  - Click Mixer to verify that other audio applications are set to 50 and not muted.



6. Navigate to **Start** → **Control Panel** → **Hardware and Sound** → **Sound**. Confirm that Speakers are selected as the default audio device (green check mark).

⇒ **NOTE:**

If Speakers does not show, right-click on the Playback tab and select **Show Disabled Devices** (clear by default).

7. Select Speakers and click **Configure** to start Speaker Setup. Follow the on-screen prompts to configure the speakers.
8. Remove any recently installed hardware or software.
9. Restore system and file settings from a known good date using System Restore.
10. If the issue is remains, repeat step 9, selecting an earlier time and date.
11. Reinstall the operating system.
12. If the issue is still not resolved, refer to [Online Support Information](#).

# Microphone Failure

---

If internal or external Microphones fail, perform the following:

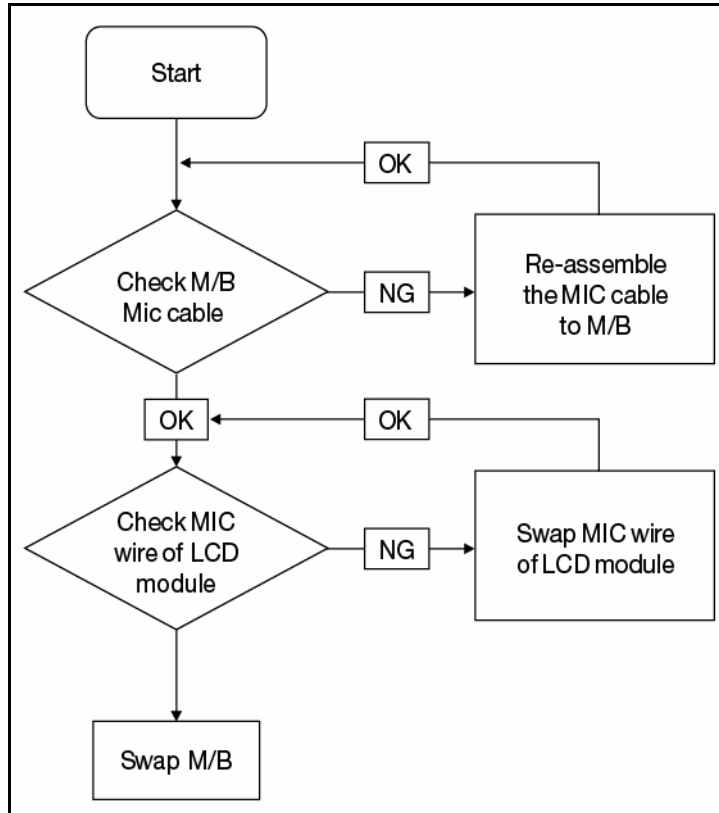

---

**Figure 4-7. Microphone Failure**

1. Check that the microphone is enabled. Navigate to **Start** → **Control Panel** → **Hardware and Sound** → **Sound** and select the **Recording** tab.
2. Right click on the **Recording** tab and select **Show Disabled Devices** (clear by default). The microphone appears on the **Recording** tab.
3. Right click on the microphone and select **Enable**.
4. Select the microphone then click **Properties**. Select the **Levels** tab.
5. Increase the volume to the maximum setting and click **OK**.
6. Test the microphone hardware:
  - Select the microphone and click **Configure**.
  - Select **Set up microphone**.
  - Select the microphone type from the list and click **Next**.
  - Follow the on-screen prompts to complete the test.
7. If the Issue is still not resolved, refer to [Online Support Information](#).

# USB Failure

---

If the USB fails, perform the following:

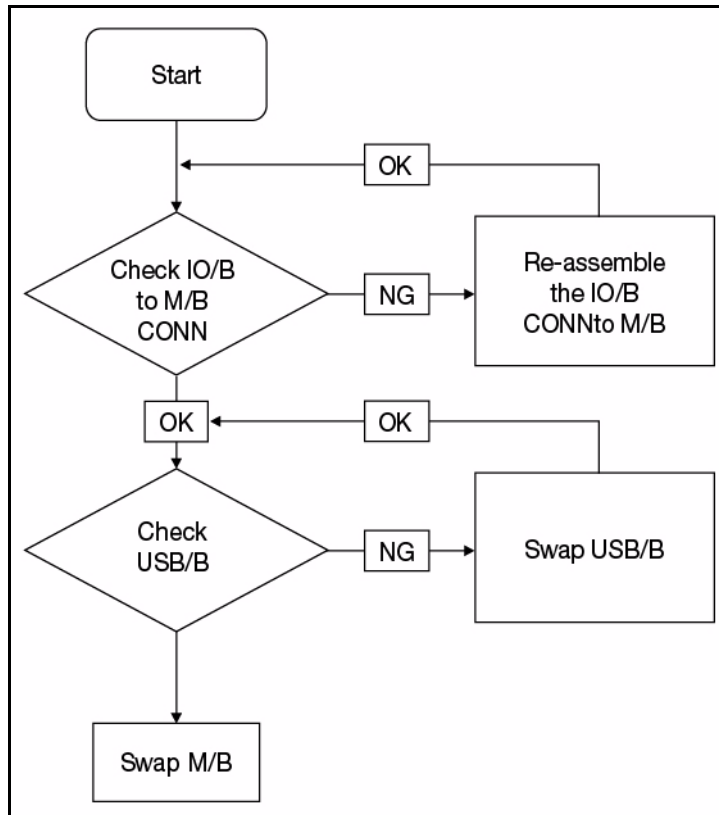

---

**Figure 4-8. USB Failure**

# Wireless Failure

---

If the wireless fails, perform the following:

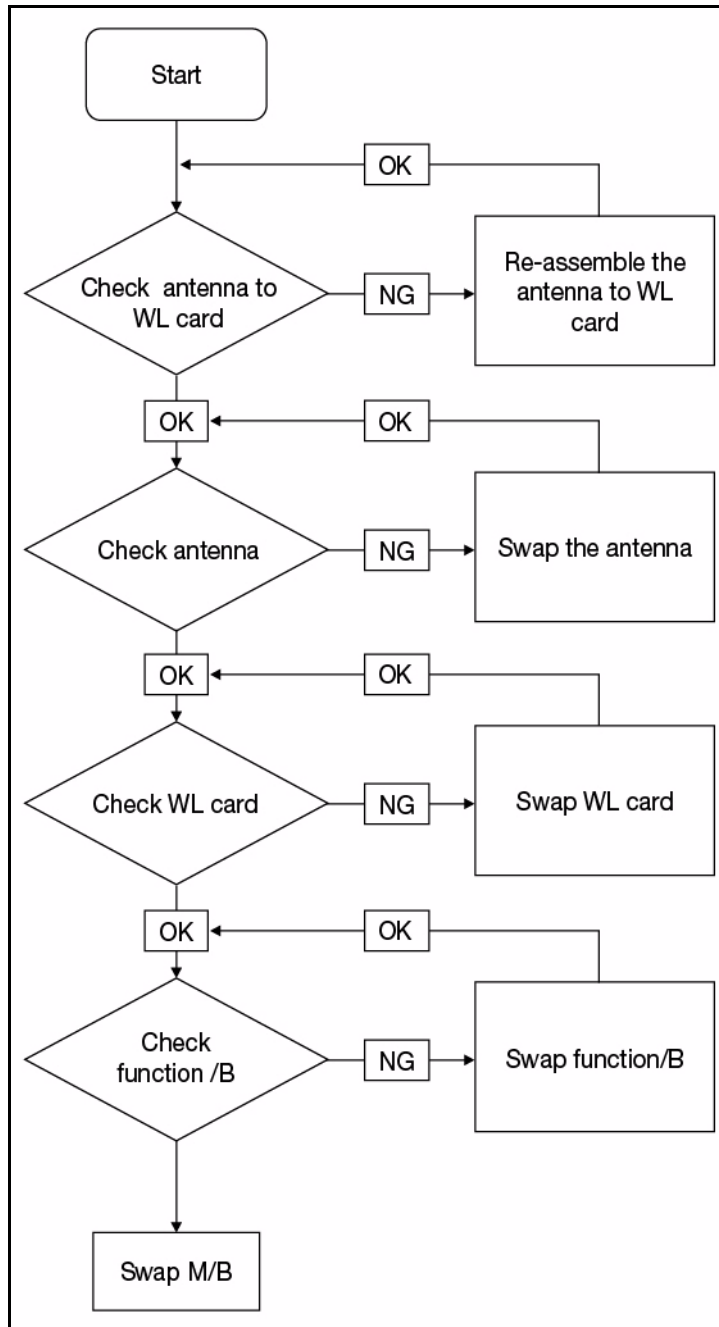

---

**Figure 4-9. Wireless Failure**

# Bluetooth Failure

---

If the wireless fails, perform the following:

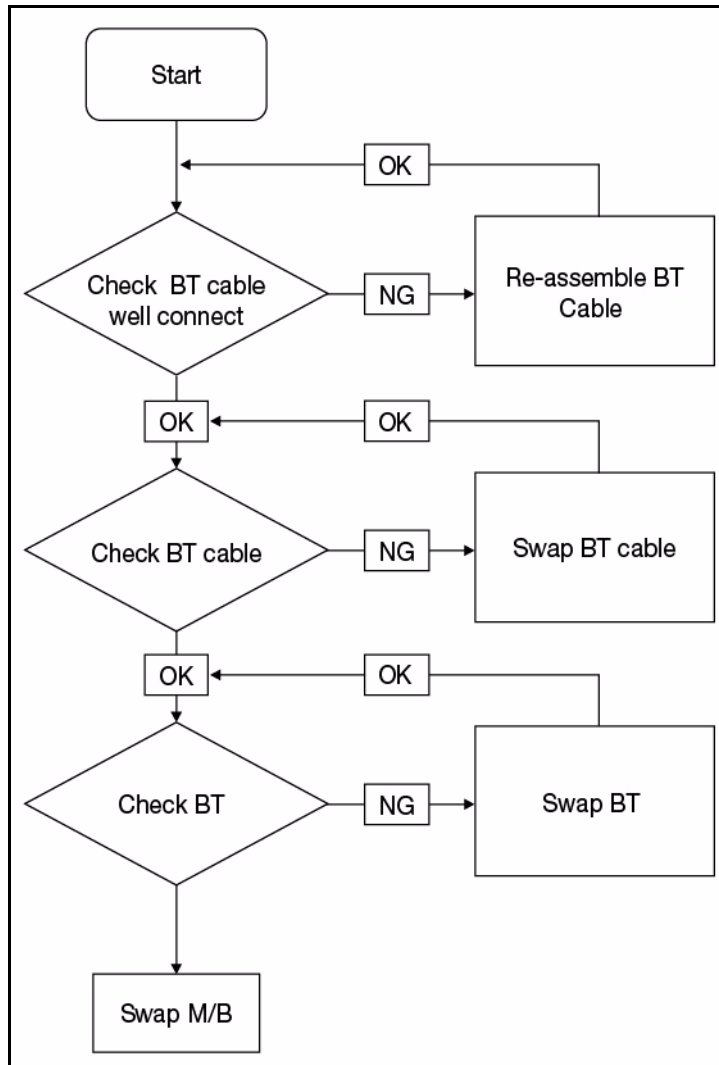

---

**Figure 4-10. Bluetooth Failure**

# Card Reader Failure

---

If the card reader fails, perform the following:

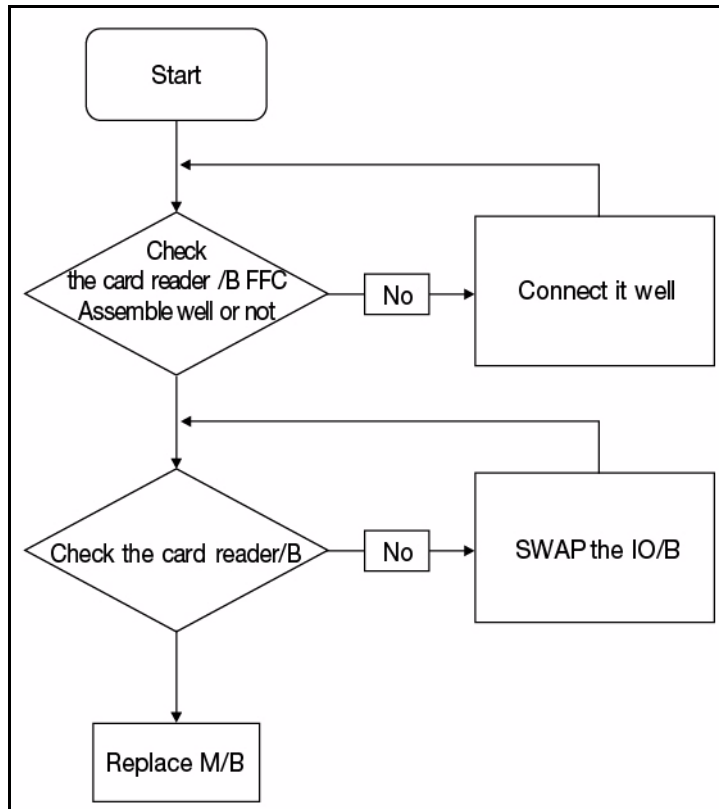

---

**Figure 4-11. Card Reader Failure**

# Thermal Module Failure

---

If the thermal module fails, perform the following:

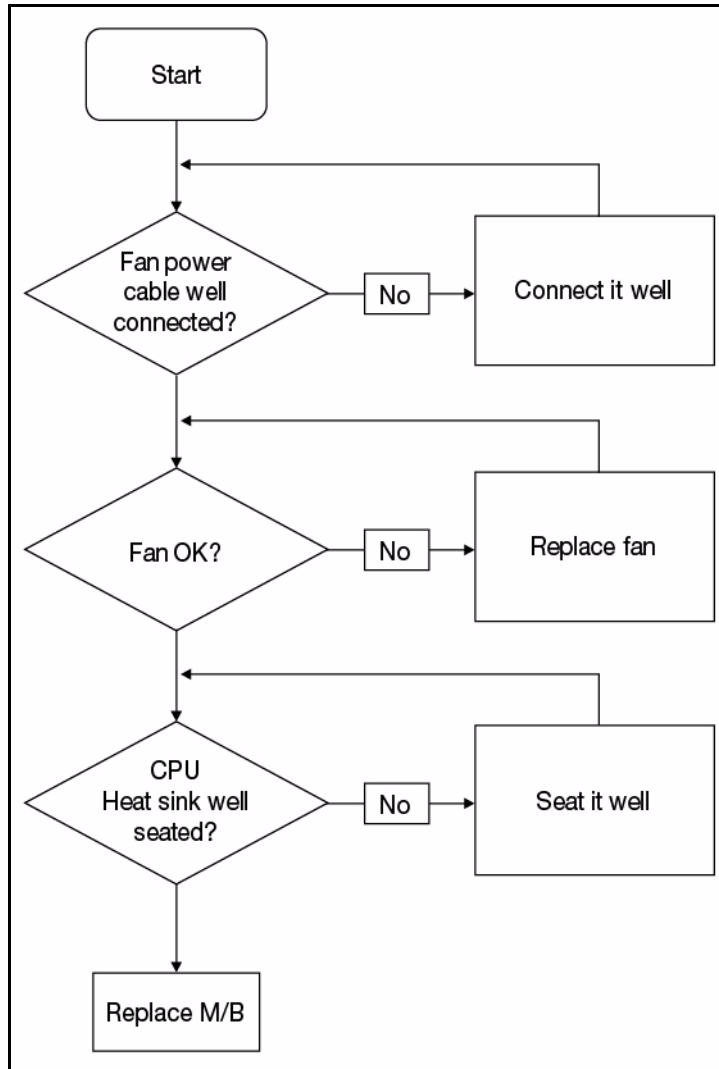

---

**Figure 4-12. Thermal Module Failure**

# Cosmetic Failure

If there are any cosmetic defects, perform the following:

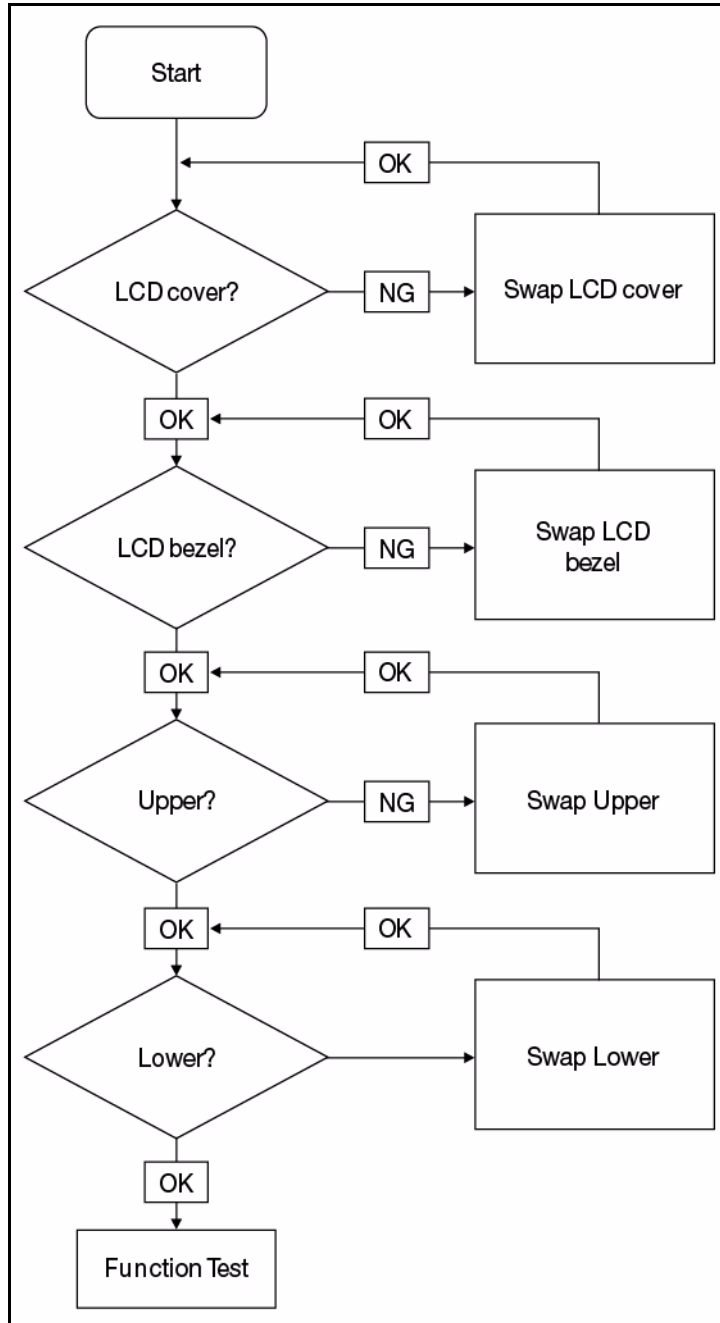

**Figure 4-13. Cosmetic Failure**



## Other Functions Failure

---

1. Check if drives are functioning correctly.
2. Check if external modules are functioning correctly.
3. Change mainboard to check if current one is defective.

# Intermittent Problems

---

Intermittent system hang problems can be caused by a variety of reasons that have nothing to do with a hardware defect, such as: cosmic radiation, electrostatic discharge, or software errors. FRU replacement should be considered only when a recurring problem exists.

When analyzing an intermittent problem, perform the following:

1. Run the advanced diagnostic test for the system board in loop mode at least 10 times.
2. If no error is detected, do not replace any FRU.
3. If an error is detected, replace the FRU. Rerun the test to verify that there are no more errors.

# Undetermined Problems

---

The diagnostic problems do not identify which adapter or device failed, which installed devices are incorrect, whether a short circuit is suspected, or whether the system is inoperative.

Perform the following procedures to isolate the failing FRU (do not isolate non-defective FRU).

⇒ **NOTE:**

Verify that all attached devices are supported by the computer.

⇒ **NOTE:**

Verify that the power supply being used at the time of the failure is operating correctly. (Refer to [Power On Issues](#)).

1. Remove power from the computer.
2. Visually check components for damage. If any problems are found, replace the FRU.
3. Remove or disconnect all of the following devices:
  - Non-Acer devices
  - Printer, mouse, and other external devices
  - Battery pack
  - Hard disk drive
  - DIMM
  - CD-ROM/Diskette drive Module
  - PC Cards
4. Apply power to the computer.
5. Determine if the problem has changed.
6. If the problem does not recur, connect the removed devices one at a time until failing FRU is found.
7. If the problem remains, replace the following FRUs one at a time. Do not replace a non-defective FRU:
  - System board
  - LCD assembly

# Post Codes

The following are the InsydeH2O™ Functionality POST code tables. The components of the POST code table includes: SEC phase, PEI phase, DXE phase, BDS phase, CSM functions, S3 functions and ACPI functions.

**Table 4-2. POST Code Range**

Phase	POST Code Range
SEC	0x01 - 0x0F
PEI	0x70 - 0x9F
DXE	0x40 - 0x6F
BDS	0x10 - 0x3F
SMM	0xA0 - 0xBF
S3	0xC0 - 0xCF
ASL	0x51 – 0x55 0xE1 – 0xE4
PostBDS	0xF9 – 0xFE
InsydeH2ODDT™ Reserve	0xD0 – 0xD7
OEM Reserve	0xE8 – 0xEB
Reserved	0xD8 – 0xE0 0xE5 – 0xE7 0xEC – 0xF8

**Table 4-3. SEC Phase POST Code Table**

Functionality Name (Include\ PostCode.h)	Phase	PostCode	Description
SEC_SYSTEM_POWER_ON	SEC	01	CPU power on and switch to Protected mode
SEC_BEFORE_MICROCODE_PATCH	SEC	02	Patching CPU microcode
SEC_AFTER_MICROCODE_PATCH	SEC	03	Setup Cache as RAM
SEC_ACCESS_CSR*	SEC	04	PCIE MMIO Base Address initial
SEC_GENERIC_MSRRINIT*	SEC	05	CPU Generic MSR initialization
SEC_CPU_SPEEDCFG*	SEC	06	Setup CPU speed
SEC_SETUP_CAR_OK	SEC	07	Cache as RAM test
SEC_FORCE_MAX_RATIO*	SEC	08	Tune CPU frequency ratio to maximum level

**Table 4-3. SEC Phase POST Code Table**

Functionality Name (Include\ PostCode.h)	Phase	PostCode	Description
SEC_GO_TO_SECSTARTUP	SEC	09	Setup BIOS ROM cache
SEC_GO_TO_PEICORE	SEC	0A	Enter Boot Firmware Volume
* 3rd party relate functions – Platform dependence.			

**Table 4-4. PEI Phase POST Code Table**

Functionality Name (Include\ PostCode.h)	Phase	Post Code	Description
PEI_SIO_INIT	PEI	70	Super I/O Initialization
PEI_CPU_REG_INIT	PEI	71	CPU Early Initialization
PEI_CPU_AP_INIT*	PEI	72	Multi-processor Early Initial
PEI_CPU_HT_RESET*	PEI	73	HyperTransport Initialization
PEI_PCIE_MMIO_INIT	PEI	74	PCIE MMIO BAR Initialization
PEI_NB_REG_INIT	PEI	75	North Bridge Early Initialization
PEI_SB_REG_INIT	PEI	76	South Bridge Early Initialization
PEI_PCIE_TRAINING*	PEI	77	PCIE Training
PEI_TPM_INIT	PEI	78	TPM Initialization
PEI_SMBUS_INIT	PEI	79	SMBUS Early Initialization
PEI_PROGRAM_CLOCK_GEN	PEI	7A	Clock Generator Initialization
PEI_IGD_EARLY_INITIAL *	PEI	7B	Internal Graphic device early Initialization
PEI_HECI_INIT*	PEI	7C	HECI Initialization
PEI_WATCHDOG_INIT*	PEI	7D	Watchdog timer Initialization
PEI_MEMORY_INIT	PEI	7E	Memory Initial for Normal boot.
PEI_MEMORY_INIT_FOR_CRISIS	PEI	7F	Memory Initial for Crisis Recovery
PEI_MEMORY_INSTALL	PEI	80	Simple Memory test
PEI_TXTPEI*	PEI	81	TXT function early Initialization
PEI_SWITCH_STACK	PEI	82	Start to use Memory
PEI_MEMORY_CALLBACK	PEI	83	Set cache for physical memory
PEI_ENTER_RECOVERY_MODE	PEI	84	Recovery device Initialization
PEI_RECOVERY_MEDIA_FOUND	PEI	85	Found Recovery image
PEI_RECOVERY_MEDIA_NOT_FOUND	PEI	86	Recovery image not found
PEI_RECOVERY_LOAD_FILE_DONE	PEI	87	Load Recovery Image completed

**Table 4-4. (Continued)PEI Phase POST Code Table**

Functionality Name (Include\ PostCode.h)	Phase	Post Code	Description
PEI_RECOVERY_START_FLASH	PEI	88	Start Flash BIOS with Recovery image
PEI_ENTER_DXEIPL	PEI	89	Loading BIOS image to RAM
PEI_FINDING_DXE_CORE	PEI	8A	Loading DXE core
PEI_GO_TO_DXE_CORE	PEI	8B	Enter DXE core
* 3rd party relate functions – Platform dependence.			

**Table 4-5. DXE Phase POST Code Table**

Functionality Name (Include\ PostCode.h)	Phase	Post Code	Description
DXE_TCGDXE*	DXE	40	TPM initial in DXE
DXE_SB_SPI_INIT*	DXE	41	South bridge SPI initialization
DXE_CF9_RESET*	DXE	42	Setup Reset service
DXE_SB_SERIAL_GPIO_INIT*	DXE	43	South bridge Serial GPIO initialization
DXE_SMMACCESS*	DXE	44	Setup SMM ACCE SS service
DXE_SIO_INIT*	DXE	46	Super I/O DXE initialization
DXE_LEGACY_REGION*	DXE	47	Setup Legacy Region service
DXE_SB_INIT*	DXE	48	South Bridge Middle initialization
DXE_IDENTIFY_FLASH_DEVICE*	DXE	49	Identify Flash device
DXE_FTW_INIT	DXE	4A	Fault Tolerant Write verification
DXE_VARIABLE_INIT	DXE	4B	Variable Service initialization
DXE_VARIABLE_INIT_FAIL	DXE	4C	Fail to initial Variable Service
DXE_MTC_INIT	DXE	4D	MTC Initial
DXE_CPU_INIT	DXE	4E	CPU Middle Initialization
DXE_MP_CPU_INIT	DXE	4F	Multi-processor Middle Initialization
DXE_SMBUS_INIT	DXE	50	SMBUS Driver Initialization
DXE_SMART_TIMER_INIT	DXE	51	8259 Initialization
DXE_PCRTC_INIT	DXE	52	RTC Initialization
DXE_SATA_INIT*	DXE	53	SATA Controller early Initialization
DXE_SMM_CONTROLER_INIT*	DXE	54	Setup SMM Control service
DXE_LEGACY_INTERRUPT*	DXE	55	Setup Legacy Interrupt service

**Table 4-5. (Continued)DXE Phase POST Code Table**

Functionality Name (Include\ PostCode.h)	Phase	Post Code	Description
DXE_RELOCATE_SMBASE	DXE	56	Relocate SMM BASE
DXE_FIRST_SMI	DXE	57	SMI test
DXE_VTD_INIT*	DXE	58	VTD Initial
DXE_BEFORE_CSM16_INIT	DXE	59	Legacy BIOS Initialization
DXE_AFTER_CSM16_INIT	DXE	5A	Legacy interrupt function Initialization
DXE_LOAD_ACPI_TABLE	DXE	5B	ACPI Table Initialization
DXE_SB_DISPATCH*	DXE	5C	Setup SB SMM Dispatcher service
DXE_SB_IOTRAP_INIT*	DXE	5D	Setup SB IOTRAP Service
DXE_SUBCLASS_DRIVER*	DXE	5E	Build AMT Table
DXE_PPM_INIT*	DXE	5F	PPM Initialization
DXE_HECIDRV_INIT*	DXE	60	HECIDRV Initialization
* 3rd party relate functions – Platform dependence.			

**Table 4-6. BDS Phase POST Code Table**

Functionality Name (Include\ PostCode.h)	Phase	Post Code	Description
BDS_ENTER_BDS	BDS	10	Enter BDS entry
BDS_INSTALL_HOTKEY	BDS	11	Install Hotkey service
BDS_ASF_INIT*	BDS	12	ASF Initialization
BDS_PCI_ENUMERATION_START	BDS	13	PCI enumeration
BDS_BEFORE_PCIIO_INSTALL	BDS	14	PCI resource assign complete
BDS_PCI_ENUMERATION_END	BDS	15	PCI enumeration complete
BDS_CONNECT_CONSOLE_IN	BDS	16	Keyboard Controller, Keyboard and Mouse initialization
BDS_CONNECT_CONSOLE_OUT	BDS	17	Video device initialization
BDS_CONNECT_STD_ERR	BDS	18	Error report device initialization
BDS_CONNECT_USB_HC	BDS	19	USB host controller initialization
BDS_CONNECT_USB_BUS	BDS	1A	USB BUS driver initialization
BDS_CONNECT_USB_DEVICE	BDS	1B	USB device driver initialization
BDS_NO_CONSOLE_ACTION	BDS	1C	Console device initial fail
BDS_DISPLAY_LOGO_SYSTEM_INFO	BDS	1D	Display logo or system information

**Table 4-6. (Continued)BDS Phase POST Code Table**

Functionality Name (Include\ PostCode.h)	Phase	Post Code	Description
BDS_START_IDE_CONTROLLER	BDS	1E	IDE controller initialization
BDS_START_SATA_CONTROLLER	BDS	1F	SATA controller initialization
BDS_START_ISA_ACPI_CONTROLLER	BDS	20	SIO controller initialization
BDS_START_ISA_BUS	BDS	21	ISA BUS driver initialization
BDS_START_ISA_FDD	BDS	22	Floppy device initialization
BDS_START_ISA_SEIRAL	BDS	23	Serial device initialization
BDS_START_IDE_BUS	BDS	24	IDE device initialization
BDS_START_AHCI_BUS	BDS	25	AHCI device initialization
BDS_CONNECT_LEGACY_ROM	BDS	26	Dispatch option ROMs
BDS_ENUMERATE_ALL_BOOT_OPTION	BDS	27	Get boot device information
BDS_END_OF_BOOT_SELECTION	BDS	28	End of boot selection
BDS_ENTER_SETUP	BDS	29	Enter Setup Menu
BDS_ENTER_BOOT_MANAGER	BDS	2A	Enter Boot manager
BDS_BOOT_DEVICE_SELECT	BDS	2B	Try to boot system to OS
BDS_EFI64_SHADOW_ALL_LEGACY_ROM	BDS	2C	Shadow Misc Option ROM
BDS_ACPI_S3SAVE	BDS	2D	Save S3 resume required data in RAM
BDS_READY_TO_BOOT_EVENT	BDS	2E	Last Chipset initial before boot to OS
BDS_GO_LEGACY_BOOT	BDS	2F	Start to boot Legacy OS
BDS_GO_UEFI_BOOT	BDS	30	Start to boot UEFI OS
BDS_LEGACY16_PREPARE_TO_BOOT	BDS	31	Prepare to Boot to Legacy OS
BDS_EXIT_BOOT_SERVICES*	BDS	32	Send END of POST Message to ME via HECI
BDS_LEGACY_BOOT_EVENT	BDS	33	Last Chipset initial before boot to Legacy OS.
BDS_ENTER_LEGACY_16_BOOT	BDS	34	Ready to Boot Legacy OS.
BDS_RECOVERY_START_FLASH	BDS	35	Fast Recovery Start Flash.
* 3rd party relate functions – Platform dependence.			

**Table 4-7. S3 Functions POST Code Table**

Functionality Name (Include\ PostCode.h)	Phase	Post Code	Description
S3_RESTORE_MEMORY_CONTROLLER	PEI	C0	Memory initial for S3 resume
S3_INSTALL_S3_MEMORY	PEI	C1	Get S3 resume required data from memory
S3_SWITCH_STACK	PEI	C2	Start to use memory during S3 resume
S3_MEMORY_CALLBACK	PEI	C3	Set cache for physical memory during S3 resume
S3_ENTER_S3_RESUME_PEIM	PEI	C4	Start to restore system configuration
S3_BEFORE_ACPI_BOOT_SCRIPT	PEI	C5	Restore system configuration stage1
S3_BEFORE_RUNTIME_BOOT_SCRIPT	PEI	C6	Restore system configuration stage2
S3_BEFORE_RELOCATE_SMM_BASE	PEI	C7	Relocate SMM BASE during S3 resume
S3_BEFORE_MP_INIT	PEI	C8	Multi-processor initial during S3 resume
S3_BEFORE_RESTORE_ACPI_CALLBACK	PEI	C9	Start to restore system configuration in SMM
S3_AFTER_RESTORE_ACPI_CALLBACK	PEI	CA	Restore system configuration in SMM complete
S3_GO_TO_FACS_WAKING_VECTOR	PEI	CB	Back to OS

**Table 4-8. ACPI Functions POST Code Table**

Functionality Name (Include\ PostCode.h)	Phase	Post Code	Description
ASL_ENTER_S1	ASL	51	Prepare to enter S1
ASL_ENTER_S3	ASL	53	Prepare to enter S3
ASL_ENTER_S4	ASL	54	Prepare to enter S4
ASL_ENTER_S5	ASL	55	Prepare to enter S5
ASL_WAKEUP_S1	ASL	E1	System wake up from S1
ASL_WAKEUP_S3	ASL	E3	System wake up from S3
ASL_WAKEUP_S4	ASL	E4	System wake up from S4



**Table 4-9. SMM Functions POST Code Table**

Functionality Name (Include\ PostCode.h)	Phase	Post Code	Description
SMM_IDENTIFY_FLASH_DEVICE	SMM	0xA0	Identify Flash device in SMM
SMM_SMM_PLATFORM_INIT	SMM	0xA2	SMM service initial
SMM_ACPI_ENABLE_START	SMM	0xA6	OS call ACPI enable function
SMM_ACPI_ENABLE_END	SMM	0xA7	ACPI enable function complete
SMM_S1_SLEEP_CALLBACK	SMM	0xA1	Enter S1
SMM_S3_SLEEP_CALLBACK	SMM	0xA3	Enter S3
SMM_S4_SLEEP_CALLBACK	SMM	0xA4	Enter S4
SMM_S5_SLEEP_CALLBACK	SMM	0xA5	Enter S5
SMM_ACPI_DISABLE_START	SMM	0xA8	OS call ACPI disable function
SMM_ACPI_DISABLE_END	SMM	0xA9	ACPI disable function complete

**Table 4-10. InsydeH2ODDT Debugger POST Code Table**

Functionality Name (Include\ PostCode.h)	PostCode	Description
Used by Insyde debugger	0x0D	Waiting for device connect
Used by Insyde debugger	0xD0	Waiting for device connect
Used by Insyde debugger	0xD1	InsydeH2ODDT Ready
Used by Insyde debugger	0xD2	EHCI not found
Used by Insyde debugger	0xD3	Debug port connect low speed device
Used by Insyde debugger	0xD4	DDT Cable become low speed device
Used by Insyde debugger	0xD5	DDT Cable Transmission Error (Get descriptor fail)
Used by Insyde debugger	0xD6	DDT Cable Transmission Error (Set Debug mode fail)
Used by Insyde debugger	0xD7	DDT Cable Transmission Error (Set address fail)



# CHAPTER 5

## Jumper and Connector Locations

---

<b>Mainboard Jumper and Connector Locations</b> .....	<b>5-3</b>
<b>USB Board Jumper and Connector Locations</b> .....	<b>5-5</b>
<b>Power Board Jumper and Connector Locations</b> .....	<b>5-6</b>
<b>Clearing Password Check and BIOS Recovery</b> .....	<b>5-7</b>
Clearing Password Check .....	5-7
Clear CMOS Jumper .....	5-8
BIOS Recovery by Crisis Disk .....	5-8

# Jumper and Connector Locations

## Mainboard Jumper and Connector Locations

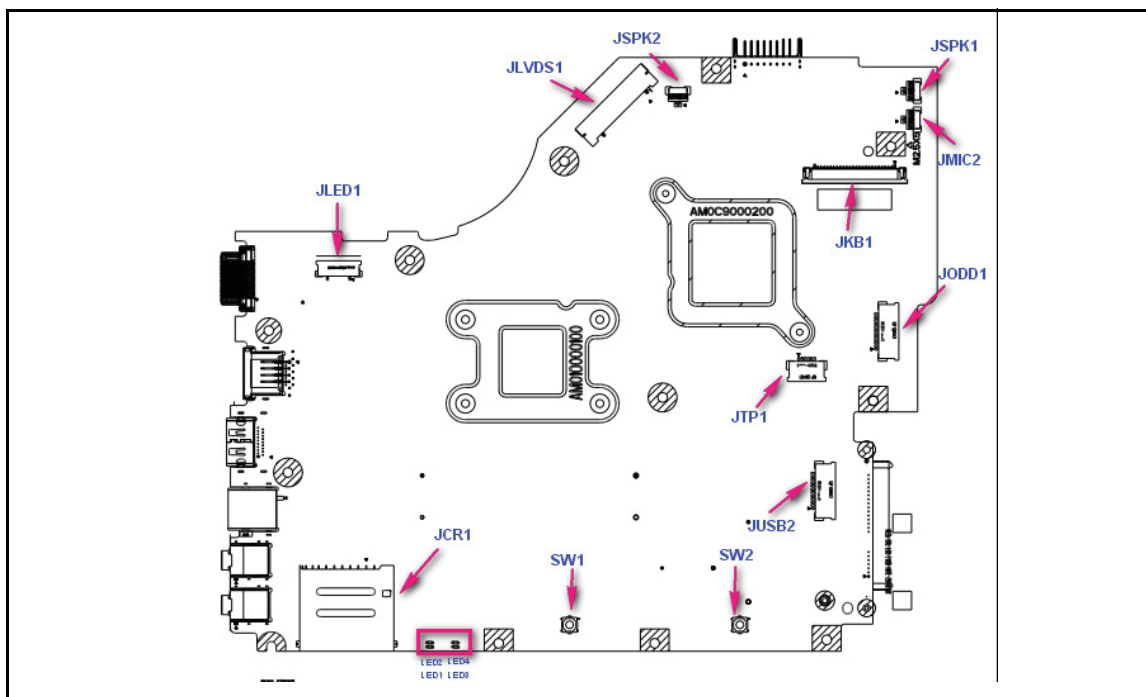

Figure 5-1. Mainboard Top

Table 5-1. Mainboard Top

Item	Description	Item	Description
JLVDS1	Connect to LED / CCFL Panel	JCR1	Connector of 2 in 1 Card Reader
JSPK1	Connect to Right Speaker	JLED1	Connect to Power board (with FFC)
JSPK2	Connect to Left Speaker	JMIC2	Connect to Internal MIC
JKB1	Connect to Keyboard	SW1 / SW2	Left button / Right button
JTP1	Connect to Touchpad (with FFC)	LED1 / LED2	Power State Indicator
JUSB2	Connect to USB board (with FFC)	LED3 / LED4	Battery Charging Indicator

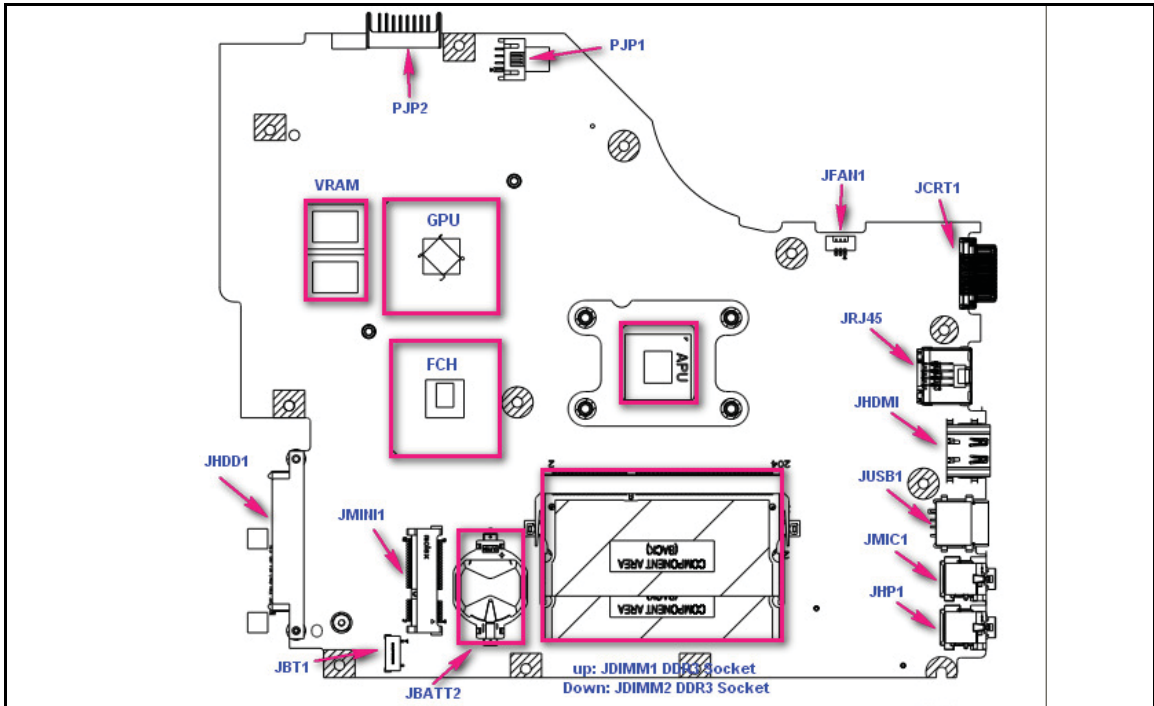

Figure 5-2. Mainboard Bottom

Table 5-2. Mainboard Bottom

Item	Description	Item	Description
PJP2	Connect of Battery	JHP1	Connect to external headphone
PJP1	DC-IN Jack	JBT1	Connect JBT1 to BT (With Cable)
JDIMM1 / JDIMM2	DDR3 Memory Socket	JHDD1	Connect to SATA HDD
JCRT1	Connector of D-Sub	JODD1	Connect to SATA ODD
JRJ45	RJ45 of GLAN	JFAN1	Connect to FAN
JHDMI1	HDMI Connector	JSPK1	Connect to external speaker
JMINI1	Connector of WLAN Module	JSPK2	Connect to external speaker
JUSB1	USB Connector	U22	APU
JMIC1	Connect to External Microphone	U31	FCH

# USB Board Jumper and Connector Locations

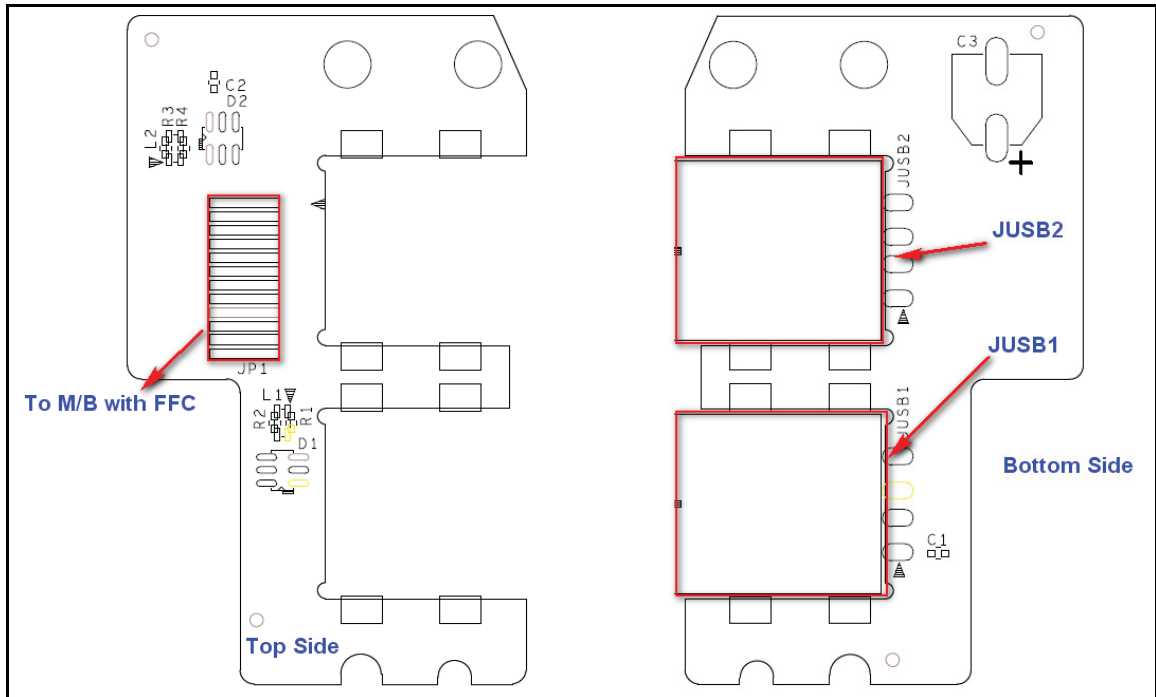

Figure 5-3. USB Board

Table 5-3. USB Board

Item	Description
JUSB1 / JUSB2	USB connector
JP1	Connect to mainboard (w/ FFC)

# Power Board Jumper and Connector Locations

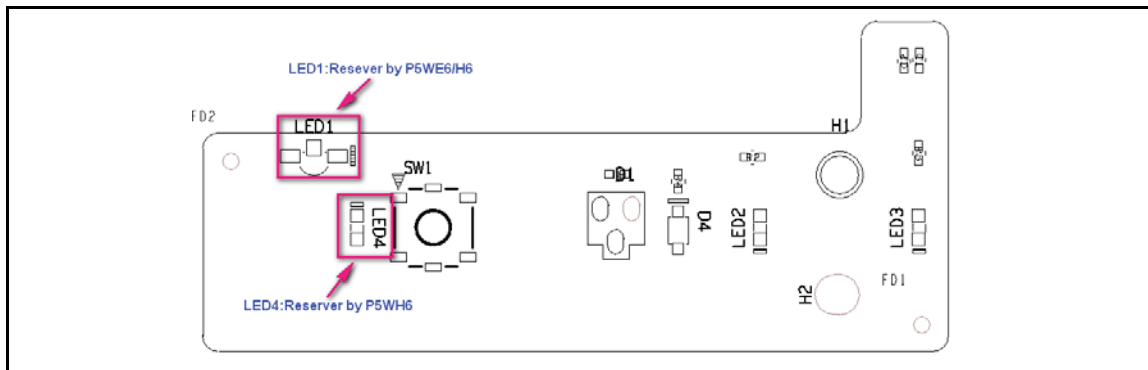

Figure 5-4. Power Board Top

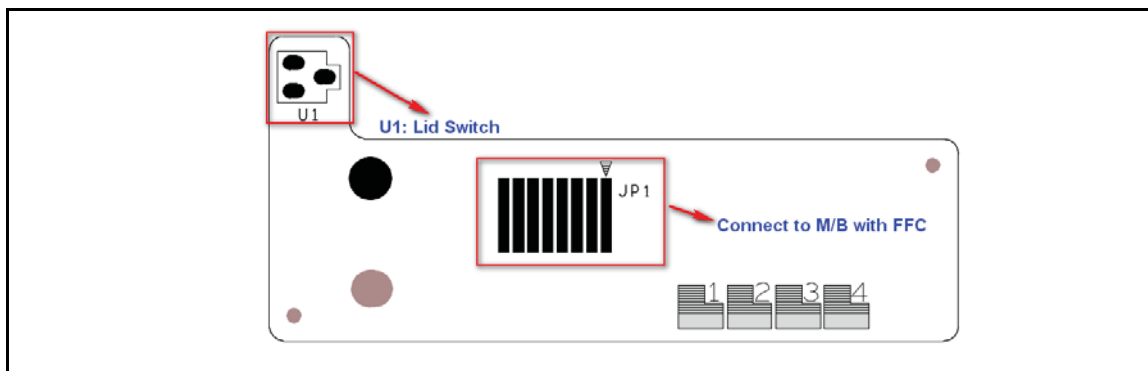

Figure 5-5. Power Board Bottom

Table 5-4. Power Board

Item	Description
JP1	Connect to mainboard (w/ FFC)



# Clearing Password Check and BIOS Recovery

---

This section provides users with the standard operating procedures of clearing password and BIOS recovery for the Packard Bell EasyNote TK11BZ/TK13BZ. The machine provides one Hardware Open Gap on main board for clearing password check, and one hot key for enabling BIOS Recovery.

## Clearing Password Check

---

### ⇒ NOTE:

The following procedure is only for clearing BIOS Password (Supervisor Password and User Password).

### Steps for Clearing BIOS Password Check

If users set BIOS Password (Supervisor Password and/or User Password) for a security reason, BIOS will ask the password during systems POST or when systems enter to BIOS Setup menu. However, once it is necessary to bypass the password check, users need to short the HW Gap to clear the password by the following steps:

1. Remove power from the system.
2. Remove HDD, AC and Battery.
3. Disconnect the RTC Battery
4. Locate the R582 jumper.
5. Use an electric conductivity tool to short the two points of the R582 jumper.
6. Plug in AC, keeping the R582 jumper shorted.
7. Press *Power Button* until BIOS POST is finished, then remove the conductivity tool from the R582 jumper.
8. Restart the system. Press **F2** to enter BIOS Setup menu.
9. If there is no Password request, BIOS Password is cleared.
10. If a password is requested, repeat Steps 1 through 9.

## Clear CMOS Jumper

---

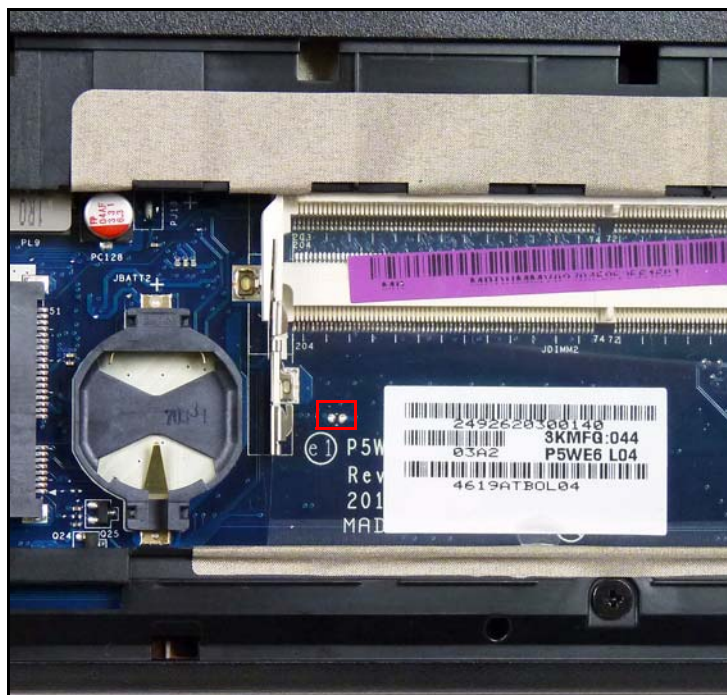

Figure 5-6. CMOS Jumper

Table 5-5. CMOS Jumper

Item	Description
R582	Clear CMOS Jumper

## BIOS Recovery by Crisis Disk

---

### BIOS Recovery Boot Block

BIOS Recovery Boot Block is a special block of BIOS. It is used to boot up the system with minimum BIOS initialization. Users can enable this feature to restore the BIOS firmware to a successful one once the previous BIOS flashing process failed.

### BIOS Recovery Hot key

The system provides a function hot key, **<Fn+Esc>**, for enable BIOS Recovery process when system is powered on during BIOS POST. To use this function, it is strongly recommended to have the AC adapter and Battery present. If this function is enabled, the system will force the BIOS to enter a special BIOS block, called Boot Block.

## Steps for BIOS Recovery from USB Storage

### ⇒ NOTE:

Prior to performing the recovery, prepare a Crisis USB key. The Crisis USB key is created by executing the Crisis Disk program on another system with Windows 7 OS.

To Create a Crisis USB key, perform the following:

1. Format the USB storage disk using the Fast Format option.
2. Save ROM file (file name: **NEW70x64.fd**) to the root directory of USB storage. Make sure that there is no other BIOS file saved in the same directory.
3. Plug USB storage into USB port.
4. Press <Fn + Esc> button then plug in AC power.
5. The Power button flashes once.
6. Press **Power** button to initiate system CRISIS mode.
7. When CRISIS is complete, the system auto restarts with a workable BIOS.
8. Update the latest version BIOS for this machine by regular BIOS flashing process.



# CHAPTER 6

## FRU (Field Replaceable Unit) List

---

<b>Exploded Diagrams</b> .....	<b>6-4</b>
<b>FRU List</b> .....	<b>6-6</b>
<b>Screw List</b> .....	<b>6-21</b>

# FRU (Field Replaceable Unit) List

---

This chapter provides users with a FRU (Field Replaceable Unit) listing in global configurations for the Packard Bell EasyNote TK11BZ/TK13BZ. Refer to this chapter whenever ordering for parts to repair or for RMA (Return Merchandise Authorization).

**⇒ NOTE:**

WHEN ORDERING FRU PARTS, check the most up-to-date information available on the regional web or channel. Part number changes will not be noted on the printed Service Guide. For ACER AUTHORIZED SERVICE PROVIDERS, the Acer office may have a DIFFERENT part number code from those given in the FRU list of this printed Service Guide. Users MUST use the local FRU list provided by the regional Acer office to order FRU parts for repair and service of customer machines.

**⇒ NOTE:**

To scrap or to return the defective parts, users should follow the local government ordinance or regulations on how to dispose it properly, or follow the rules set by the regional Acer office on how to return it.

# Exploded Diagrams

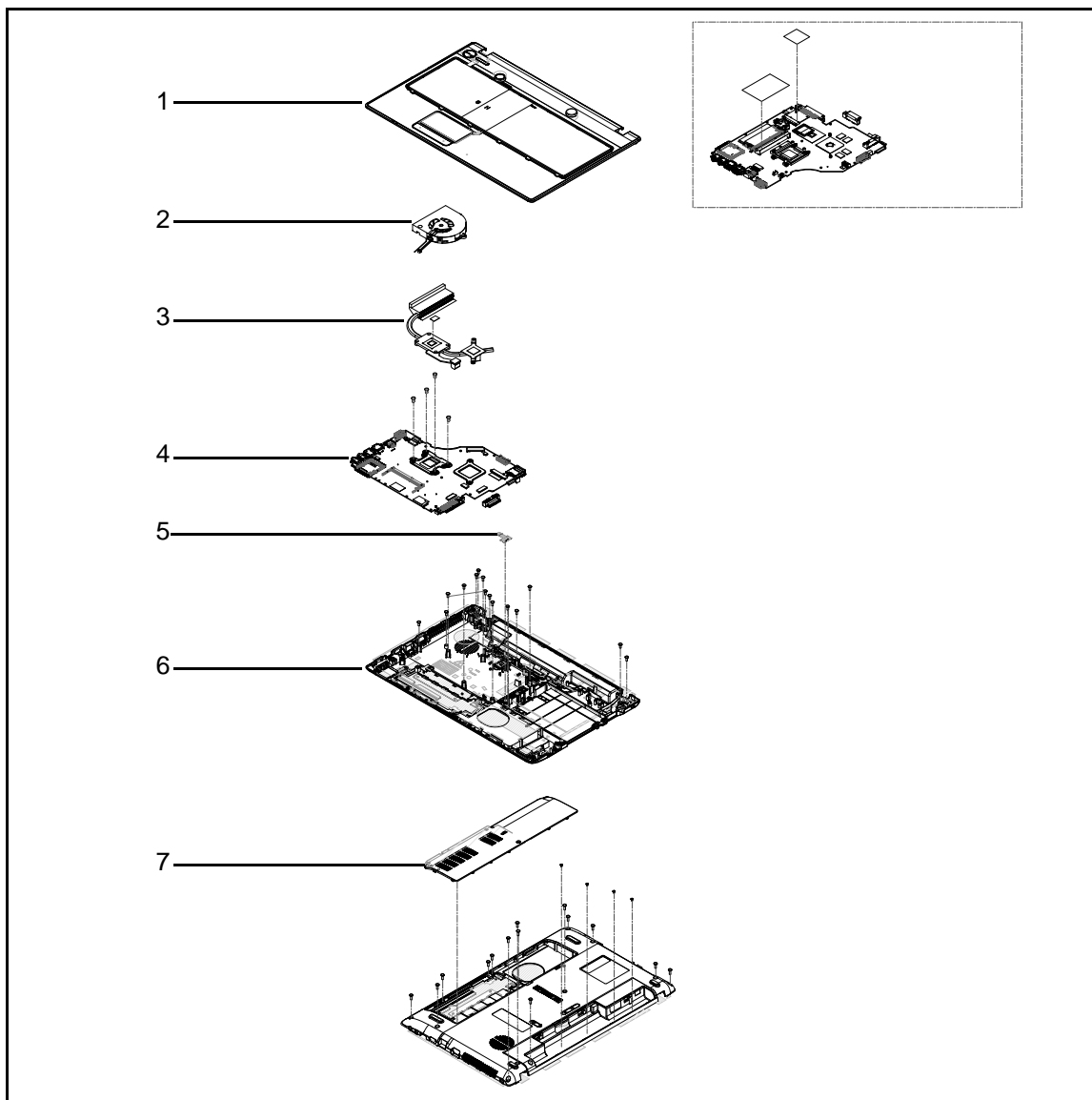
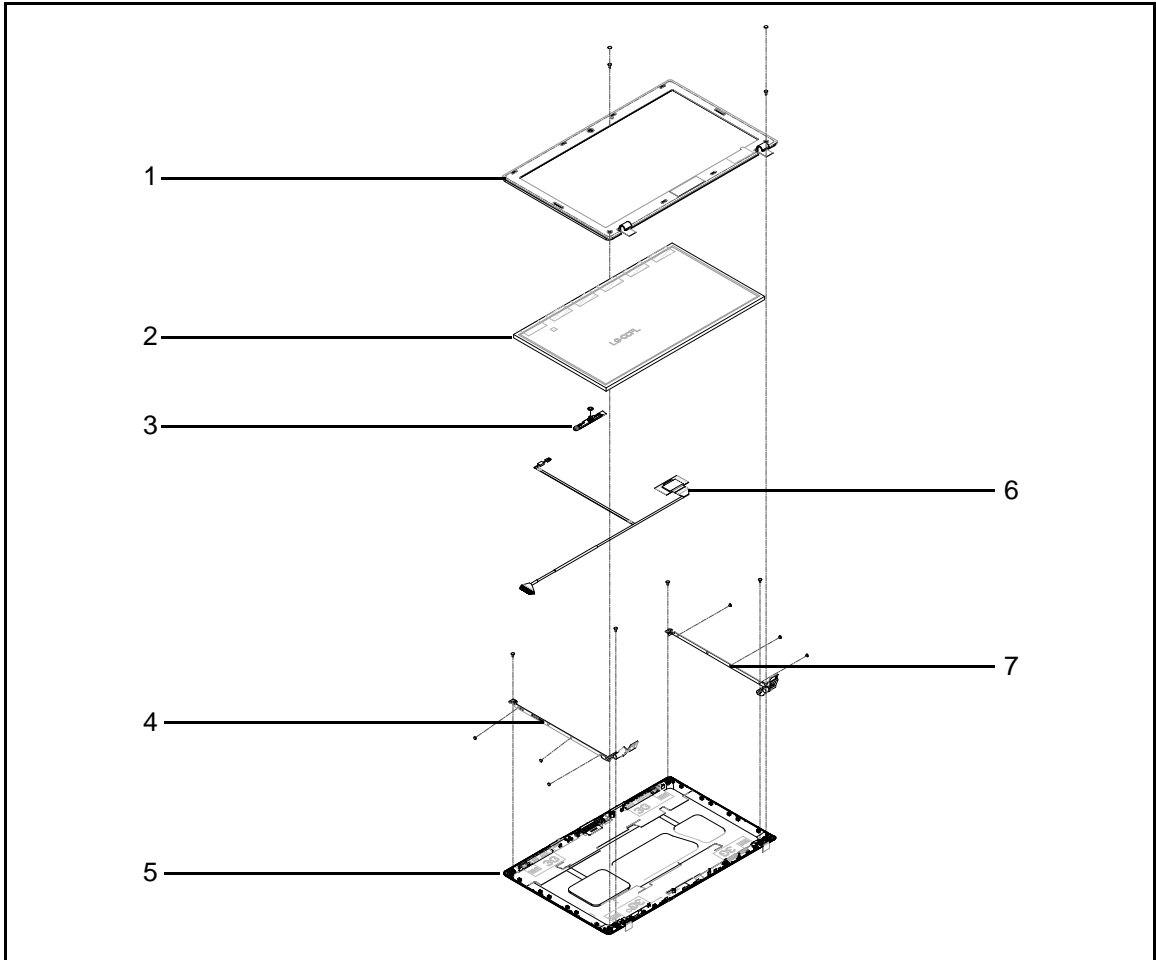

**Figure 6-1. Upper & Lower Cover Exploded Diagram**

**Table 6-1. Upper & Lower Cover Exploded Diagram**

No.	Description	Acer Part No.	No.	Description	Acer Part No.
1	Upper Cover	60.WVZ02.001	5	ODD Board	55.WVZ02.003
2	Fan	23.RD502.001	6	Lower Cover	60.R4F02.002
3	Heatsink	60.RDS02.001	7	Lower Logic Door	42.R4F02.001
4	Mainboard	MB.NCY02.001			





**Figure 6-2. LCD Assembly Exploded Diagram**

**Table 6-2. LCD Assembly Exploded Diagram**







No.	Description	Acer Part No.	No.	Description	Acer Part No.
1	LCD Bezel	60.BQ502.004	5	LCD Cover	60.BQ502.003
2	LED Panel	LK.15605.010	6	LVDS w/ Camera	50.R4F02.009
3	Camera	57.WW102.001	7	LCD Bracket (R)	33.R4F02.004
4	LCD Bracket (L)	33.R4F02.004			

# FRU List

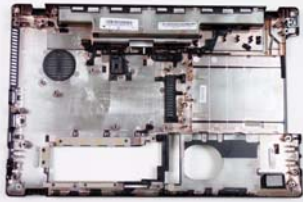

Table 6-3. FRU List

Category	Description	Acer Part No.
<b>ADAPTER</b>		
	Adapter DELTA 65W 19V 1.7x5.5x11 Yellow ADP-65JH DB A, LV5 LED LF	AP.06501.026
	Adapter LITE-ON 65W 19V 1.7x5.5x11 Yellow PA-1650-22AC LV5 LED LF	AP.06503.024
	Adapter DELTA 65W 19V 1.7x5.5x11 Yellow ADP-65VH BA, LV5, Low profile LED LF	AP.06501.033
	Adapter LITE-ON 65W 19V 1.7x5.5x11 Yellow PA-1650-69AW, LV5, Low profile LED LF	AP.06503.029
	Adapter Chicony Power 65W 19V 1.7x5.5x11 Yellow CPA09-A065N1, LV5, low profile LF	AP.0650A.017
	Adapter HIPRO 65W 19V 1.7x5.5x11 Yellow HP-A0652R3B 1LF, LV5 LED LF	AP.0650A.012
<b>BATTERY</b>		
	Battery SANYO AS10D Li-Ion 3S2P SANYO 6 cell 4400mAh Main COMMON ID:AS10D31	BT.00603.111
	Battery SONY AS10D Li-Ion 3S2P SONY 6 cell 4400mAh Main COMMON ID:AS10D41	BT.00604.049
	Battery PANASONIC AS10D Li-Ion 3S2P PANASONIC 6 cell 4400mAh Main COMMON ID:AS10D51	BT.00605.062
	Battery SAMSUNG AS10D Li-Ion 3S2P SAMSUNG 6 cell 4400mAh Main COMMON ID:AS10D61	BT.00606.008
	Battery SIMPLO AS10D Li-Ion 3S2P PANASONIC 6 cell 4400mAh Main COMMON ID:AS10D71	BT.00607.125
	Battery SIMPLO AS10D Li-Ion 3S2P SAMSUNG 6 cell 4400mAh Main COMMON ID:AS10D	BT.00607.127
<b>BOARD</b>		
	FOXCONN BLUETOOTH BRM 2070 (T77H114.01) BT 3.0	BH.21100.010
	FOXCONN BLUETOOTH ATH BU12	BH.21100.011

**Table 6-3. FRU List**

Category	Description	Acer Part No.
	POWER BOARD	55.WVZ02.001
	USB BOARD	55.WVZ02.002
	ODD BOARD	55.WVZ02.003
	LITEON WIRELESS LAN ATHERIS HB97 2X2 BGN (HM) WN6603AH	NI.23600.073
	FOXCONN WIRELESS LAN ATHEROS HB97 2X2 BGN (HM)	NI.23600.072
	FOXCONN WIRELESS LAN ATHEROS HB95BG (HM) T77H121.10	NI.23600.077
	LITEON WIRELESS LAN BROADCOM 43225 2X2 BGN	NI.23600.081
	LITEON WIRELESS LAN REALTEK 8192SE BGN WN6603LH(2X2 BGN)	NI.23600.065
<b>CABLE</b>		
	BLUE TOOTH CABLE-6PIN	50.R4F02.002
	TP FFC	50.R4F02.003
	DC-IN CABLE-65W	50.R4F02.004
	LED CABLE FOR W/O CMOS	50.R4F02.010
	POWER CORD US 3 PIN	27.TAVV5.001

**Table 6-3. FRU List**

Category	Description	Acer Part No.
	POWER CORD EU 3 PIN	27.TAVV5.002
	POWER CORD AUS 3 PIN	27.TAVV5.003
	POWER CORD UK 3 PIN	27.TAVV5.004
	POWER CORD CHINA 3 PIN	27.TAVV5.005
	POWER CORD SWISS 3 PIN	27.TAVV5.006
	POWER CORD ITALIAN 3 PIN	27.TAVV5.007
	POWER CORD DENMARK 3 PIN	27.TAVV5.008
	POWER CORD JP 3 PIN	27.TAVV5.009
	POWER CORD SOUTH AFRICA 3 PIN	27.TAVV5.010
	POWER CORD KOREA 3 PIN	27.TAVV5.011
	POWER CORD ISRAEL 3 PIN	27.TAVV5.012
	POWER CORD INDIA 3 PIN	27.TAVV5.013
	POWER CORD TWN 3 PIN	27.TAVV5.014
	POWER CORD ARGENTINA 3 PIN	27.APV02.001
	POWER CORD 3 PIN BRAZIL	27.SAD02.001
<b>CASE/COVER/BRACKET ASSEMBLY</b>		
	UPPER CASE ASSY BLACK	60.WVZ02.001
	UPPER CASE ASSY RED	60.WW102.001
	LOWER CASE-UMA	60.R4F02.002
	LOGIC LOWER DOOR-UMA	42.R4F02.001
	HDD CARRIER-UMA	33.R4F02.001

**Table 6-3. FRU List**

Category	Description	Acer Part No.
<b>DVD RW DRIVE</b>		
	ODD SUPER-MULTI DRIVE MODULE	6M.R4G02.003
	ODD BRACKET	33.R4F02.002
	ODD BEZEL-SM	42.R4F02.002
	ODD SONY Super-Multi DRIVE 12.7mm Tray DL 8X AD-7585H LF W/O bezel SATA (HF + Windows 7)	KU.0080E.027
	ODD PANASONIC Super-Multi DRIVE 12.7mm Tray DL 8X UJ890A LF W/O bezel SATA (HF + Windows 7)	KU.00807.070
	ODD HLDS Super-Multi DRIVE 12.7mm Tray DL 8X GT34N LF W/O bezel SATA Zero Power Supported, PCC LD (HF + Windows 7)	KU.0080D.057
	ODD HLDS Super-Multi DRIVE 12.7mm Tray DL 8X GT32N (R5-2) LF W/O bezel SATA with Renesas solution + PCC LD (HF + Windows 7)	KU.0080D.055
	ODD PIONEER Super-Multi DRIVE 12.7mm Tray DL 8X DVR-TD10RS LF W/O bezel 1.00 SATA	KU.00805.049
	ODD PANASONIC Super-Multi DRIVE 12.7mm Tray DL 8X UJ8A0 LF W/O bezel SATA (HF + Windows 7) Foxconn Yentai Factory	KU.00807.075
	ODD TOSHIBA Super-Multi DRIVE 12.7mm Tray DL 8X TS-L633F LF W/O bezel SATA (HF + Windows 7)	KU.00801.040
<b>HDD/HARD DISK DRIVE</b>		
	HDD HGST 2.5" 5400rpm 250GB HTS545025B9A300 Panther B SATA LF F/W:C60F Disk imbalance criteria = 0.014g-cm	KH.25007.016
	HDD SEAGATE 2.5" 5400rpm 250GB ST9250315AS, 9HH132-189, Wyatt with new pcb SATA 8MB LF F/W:0001SDM1	KH.25001.019
	HDD TOSHIBA 2.5" 5400rpm 250GB MK2565GSX, Capricorn BS, 320G/P SATA 8MB LF F/W:GJ002J	KH.25004.005

**Table 6-3. FRU List**

Category	Description	Acer Part No.
	HDD WD 2.5" 5400rpm 250GB WD2500BPVT-22ZEST0,ML320S-AF, 4K drive SATA 8MB LF F/W:01.01A01 4K drive	KH.25008.029
	HDD HGST 2.5" 5400rpm 320GB HTS545032B9A300 Panther B SATA LF F/W:C60F Disk imbalance criteria = 0.014g-cm	KH.32007.008
	HDD HGST 2.5" 5400rpm 320GB HTS543232A7A384,0J11523, Eagle B7 SATA 8MB LF F/W:A60W 7mmzh	KH.32007.012
	HDD SEAGATE 2.5" 5400rpm 320GB ST9320310AS,9RN132-188, Cameron 320G/P SATA 8MB LF F/W:0001SDM1	KH.32001.019
	HDD WD 2.5" 5400rpm 320GB WD3200BPVT-22ZEST0, ML320S, 4K drive SATA 8MB LF F/W: 01.01A01	KH.32008.022
	HDD TOSHIBA 2.5" 5400rpm 320GB Capricorn BS,MK3265GSX SATA 8MB LF F/W:GJ002J	KH.32004.004
	HDD HGST 2.5" 5400rpm 500GB HTS545050B9A300 Panther B SATA LF F/W:C60F Disk imbalance criteria = 0.014g-cm	KH.50007.010
	HDD TOSHIBA 2.5" 5400rpm 500GB MK5065GSX,Capricorn BS, 320G/P SATA 8MB LF F/W:GJ002J	KH.50004.002
	HDD SEAGATE 2.5" 5400rpm 500GB ST9500325AS,9HH134-189, Wyatt with new pcb SATA 8MB LF F/W:0001SDM1	KH.50001.017
	HDD WD 2.5" 5400rpm 500GB WD5000BPVT-22HXZT1,ML375_AF, 4K drive SATA 8MB LF+HF F/W:01.01A01	KH.50008.021
	HDD TOSHIBA 2.5" 5400rpm 640GB MK6465GSX,Capricorn BS,320G/P SATA 8MB LF F/W:GJ002J	KH.64004.001
	HDD WD 2.5" 5400rpm 640GB WD6400BPVT-22HXZT1, ML375M SATA 8MB LF F/W: 01.01A01	KH.64008.005
	HDD TOSHIBA 2.5" 5400rpm 750GB MK7559GSXP, 375G/P, Capricorn BS, 4K drive SATA 8MB LF+HF F/W:GN003J	KH.75004.001
	HDD WD 2.5" 5400rpm 750GB WD7500BPVT-22HXZT1, ML375M, 4K drive SATA 8MB LF F/W:01.01A01	KH.75008.009

**Table 6-3. FRU List**

Category	Description	Acer Part No.
<b>KEYBOARD</b>		
	Keyboard GATEWAY AC7T_G10B AC7T Internal 17 Standard 103KS Black US International Texture	KB.I170G.197
	Keyboard GATEWAY AC7T_G10B AC7T Internal 17 Standard 103KS Black Greek Texture	KB.I170G.181
	Keyboard GATEWAY AC7T_G10B AC7T Internal 17 Standard 103KS Black Arabic Texture	KB.I170G.172
	Keyboard GATEWAY AC7T_G10B AC7T Internal 17 Standard 103KS Black Chinese Texture	KB.I170G.176
	Keyboard GATEWAY AC7T_G10B AC7T Internal 17 Standard 103KS Black Russian Texture	KB.I170G.189
	Keyboard GATEWAY AC7T_G10B AC7T Internal 17 Standard 103KS Black US International w/ Hebrew Texture	KB.I170G.198
	Keyboard GATEWAY AC7T_G10B AC7T Internal 17 Standard 103KS Black Thailand Texture	KB.I170G.194
	Keyboard GATEWAY AC7T_G10B AC7T Internal 17 Standard 104KS Black UK Texture	KB.I170G.196
	Keyboard GATEWAY AC7T_G10B AC7T Internal 17 Standard 104KS Black German Texture	KB.I170G.180
	Keyboard GATEWAY AC7T_G10B AC7T Internal 17 Standard 104KS Black Swiss/G Texture	KB.I170G.193
	Keyboard GATEWAY AC7T_G10B AC7T Internal 17 Standard 104KS Black Belgium Texture	KB.I170G.173
	Keyboard GATEWAY AC7T_G10B AC7T Internal 17 Standard 104KS Black Danish Texture	KB.I170G.177
	Keyboard GATEWAY AC7T_G10B AC7T Internal 17 Standard 104KS Black Italian Texture	KB.I170G.183
	Keyboard GATEWAY AC7T_G10B AC7T Internal 17 Standard 104KS Black French Texture	KB.I170G.179

**Table 6-3. FRU List**

Category	Description	Acer Part No.
	Keyboard GATEWAY AC7T_G10B AC7T Internal 17 Standard 104KS Black Hungarian Texture	KB.I170G.182
	Keyboard GATEWAY AC7T_G10B AC7T Internal 17 Standard 104KS Black Norwegian Texture	KB.I170G.187
	Keyboard GATEWAY AC7T_G10B AC7T Internal 17 Standard 104KS Black Portuguese Texture	KB.I170G.188
	Keyboard GATEWAY AC7T_G10B AC7T Internal 17 Standard 104KS Black Spanish Texture	KB.I170G.191
	Keyboard GATEWAY AC7T_G10B AC7T Internal 17 Standard 104KS Black US w/ Canadian French Texture	KB.I170G.199
	Keyboard GATEWAY AC7T_G10B AC7T Internal 17 Standard 104KS Black Turkish Texture	KB.I170G.195
	Keyboard GATEWAY AC7T_G10B AC7T Internal 17 Standard 104KS Black Sweden Texture	KB.I170G.192
	Keyboard GATEWAY AC7T_G10B AC7T Internal 17 Standard 104KS Black FR/Arabic Texture	KB.I170G.178
	Keyboard GATEWAY AC7T_G10B AC7T Internal 17 Standard 104KS Black Nordic Texture	KB.I170G.186
	Keyboard GATEWAY AC7T_G10B AC7T Internal 17 Standard 104KS Black SLO/CRO Texture	KB.I170G.190
	Keyboard GATEWAY AC7T_G10B AC7T Internal 17 Standard 104KS Black CZ/SK Texture	KB.I170G.175
	Keyboard GATEWAY AC7T_G10B AC7T Internal 17 Standard 104KS Black Brazilian Portuguese Texture	KB.I170G.174
	Keyboard GATEWAY AC7T_G10B AC7T Internal 17 Standard 107KS Black Japanese Texture	KB.I170G.184



**Table 6-3. FRU List**

Category	Description	Acer Part No.
<b>LCD</b>		
	ASSY LED LCD MODULE 15.6"W WXGA GLARE W/ANTENNA*2, CCD 1.3M, BLACK - PB	6M.BQ502.003
	ANTENNA WLAN-MAIN	50.R4F02.005
	ANTENNA WLAN-AUX	50.R4F02.006
	LED CABLE FOR W/CMOS	50.R4F02.009
	LED COVER-BLACK PB	60.BQ502.003
	LCD BEZEL FOR W/CMOS PB	60.BQ502.004
	LED BRACKET R&L	33.R4F02.004
	CAMERA 1.3M	57.WW102.001

**Table 6-3. FRU List**

Category	Description	Acer Part No.
	LED LCD AUO 15.6"W WXGA Glare B156XW02 V2 LF 200nit 8ms 500:1 (power saving)	LK.15605.010
	LED LCD SAMSUNG 15.6"W WXGA Glare LTN156AT02-A11 LF 220nit 8ms 500:1	LK.15606.012
	LED LCD LPL 15.6"W WXGA Glare LP156WH2-TLEA LF 220nit 16ms 500:1 (color engine)	LK.15608.011
	LED LCD CMO 15.6"W WXGA Glare N156B6-L0B LF 220nit 8ms 650:1	LK.1560D.010
	LED LCD CPT 15.6"W WXGA Glare CLAA156WB11A LF 220nit 8ms 600:1	LK.1560A.004
	LED LCD AUO 15.6"W WXGA Glare B156XW02 V6 LF 200nit 8ms 400:1	LK.15605.019
<b>LCD</b>		
	ASSY LED LCD MODULE 15.6"W WXGA GLARE W/ANTENNA*2, CCD 1.3M, RED - PB	6M.BQ702.003
	ANTENNA WLAN-MAIN	50.R4F02.005
	ANTENNA WLAN-AUX	50.R4F02.006
	LED CABLE FOR W/CMOS	50.R4F02.009



**Table 6-3. FRU List**

Category	Description	Acer Part No.
	LED COVER-RED PB	60.BQ702.002
	LCD BEZEL FOR W/CMOS PB	60.BQ502.004
	LED BRACKET R&L	33.R4F02.004
	CAMERA 1.3M	57.WW102.001
	LED LCD AUO 15.6"W WXGA Glare B156XW02 V2 LF 200nit 8ms 500:1 (power saving)	LK.15605.010
	LED LCD SAMSUNG 15.6"W WXGA Glare LTN156AT02-A11 LF 220nit 8ms 500:1	LK.15606.012
	LED LCD LPL 15.6"W WXGA Glare LP156WH2-TLEA LF 220nit 16ms 500:1 (color engine)	LK.15608.011
	LED LCD CMO 15.6"W WXGA Glare N156B6-L0B LF 220nit 8ms 650:1	LK.1560D.010
	LED LCD CPT 15.6"W WXGA Glare CLAA156WB11A LF 220nit 8ms 600:1	LK.1560A.004
	LED LCD AUO 15.6"W WXGA Glare B156XW02 V6 LF 200nit 8ms 400:1	LK.15605.019
<b>LCD</b>		
	ASSY LED LCD MODULE 15.6"W WXGA GLARE W/ANTENNA*2, CCD 1.3M, BLACK - GTW	6M.WSG02.003

**Table 6-3. FRU List**

Category	Description	Acer Part No.
	ANTENNA WLAN-MAIN	50.R4F02.005
	ANTENNA WLAN-AUX	50.R4F02.006
	LED CABLE FOR W/CMOS	50.R4F02.009
	LED COVER-BLACK GW	60.WSG02.002
	LCD BEZEL FOR W/CMOS GW	60.WSG02.003
	LED BRACKET R&L	33.R4F02.004
	CAMERA 1.3M	57.WW102.001



**Table 6-3. FRU List**

Category	Description	Acer Part No.
	LED LCD AUO 15.6"W WXGA Glare B156XW02 V2 LF 200nit 8ms 500:1 (power saving)	LK.15605.010
	LED LCD SAMSUNG 15.6"W WXGA Glare LTN156AT02-A11 LF 220nit 8ms 500:1	LK.15606.012
	LED LCD LPL 15.6"W WXGA Glare LP156WH2-TLEA LF 220nit 16ms 500:1 (color engine)	LK.15608.011
	LED LCD CMO 15.6"W WXGA Glare N156B6-L0B LF 220nit 8ms 650:1	LK.1560D.010
	LED LCD CPT 15.6"W WXGA Glare CLAA156WB11A LF 220nit 8ms 600:1	LK.1560A.004
	LED LCD AUO 15.6"W WXGA Glare B156XW02 V6 LF 200nit 8ms 400:1	LK.15605.019
<b>LCD</b>		
	ASSY LED LCD MODULE 15.6"W WXGA GLARE W/ANTENNA*2, CCD 1.3M, RED - GTW	6M.WSX02.003
	ANTENNA WLAN-MAIN	50.R4F02.005
	ANTENNA WLAN-AUX	50.R4F02.006
	LED CABLE FOR W/CMOS	50.R4F02.009





**Table 6-3. FRU List**

Category	Description	Acer Part No.
	LED COVER-RED GW	60.WSX02.002
	LCD BEZEL FOR W/CMOS GW	60.WSG02.003
	LED BRACKET R&L	33.R4F02.004
	CAMERA 1.3M	57.WW102.001
	LED LCD AUO 15.6"W WXGA Glare B156XW02 V2 LF 200nit 8ms 500:1 (power saving)	LK.15605.010
	LED LCD SAMSUNG 15.6"W WXGA Glare LTN156AT02-A11 LF 220nit 8ms 500:1	LK.15606.012
	LED LCD LPL 15.6"W WXGA Glare LP156WH2-TLEA LF 220nit 16ms 500:1 (color engine)	LK.15608.011
	LED LCD CMO 15.6"W WXGA Glare N156B6-L0B LF 220nit 8ms 650:1	LK.1560D.010
	LED LCD CPT 15.6"W WXGA Glare CLAA156WB11A LF 220nit 8ms 600:1	LK.1560A.004
	LED LCD AUO 15.6"W WXGA Glare B156XW02 V6 LF 200nit 8ms 400:1	LK.15605.019
<b>MAINBOARD</b>		
	Mainboard eME644 AMD LF UMA sku (AS5253/ENTK11/ENTK13/NV51B)	MB.NCV02.001

**Table 6-3. FRU List**

Category	Description	Acer Part No.
	Mainboard eME644G AMD LF SEMOUR_XT VRAM 512MB (AS5253G/ENTK11/ENTK13/NV51B)	MB.NCY02.001
<b>MEMORY</b>		
	Memory SAMSUNG SO-DIMM DDRIII 1333 1GB M471B2873FHS-CH9 LF 128*8 46nm	KN.1GB0B.035
	Memory KINGSTON SO-DIMM DDRIII 1333 1GB ACR128X64D3S1333C9 LF 128*8 0.065um	KN.1GB07.004
	Memory UNIFOSA SO-DIMM DDRIII 1333 1GB GU672203EP0200 LF 128*8 0.065um	KN.1GB0H.017
	Memory ELPIDA SO-DIMM DDRIII 1333 2GB EBJ21UE8BFU0-DJ-F LF 128*8 0.065um	KN.2GB09.009
	Memory HYNIX SO-DIMM DDRIII 1333 2GB HMT325S6BFR8C-H9 LF 256*8 46nm	KN.2GB0G.018
	Memory KINGSTON SO-DIMM DDRIII 1333 2GB ACR256X64D3S1333C9 LF 128*8 0.065um	KN.2GB07.004
	Memory NANYA SO-DIMM DDRIII 1333 2GB NT2GC64B88B0NS-CG LF 256*8 0.055um	KN.2GB03.021
	Memory SAMSUNG SO-DIMM DDRIII 1333 2GB M471B5773DH0-CH9 LF 256*8	KN.2GB0B.030
	Memory SAMSUNG SO-DIMM DDRIII 1066 4GB M471B5273BH1-CF8 LF 256*8 0.055um	KN.4GB0B.007
	Memory ELPIDA SO-DIMM DDRIII 1333 4GB EBJ41UF8BAS0-DJ-F LF 256*8 0.055um	KN.4GB09.001
<b>HEATSINK</b>		
	THERMAL MODULE-UMA W/O FAN	60.RD502.002

**Table 6-3. FRU List**

Category	Description	Acer Part No.
	THERMAL MODULE-DIS W/O FAN	60.RDS02.001
	FAN	23.RD502.001
<b>SPEAKER</b>		
	MIC SET-DIS & UMA FOR AS5336, AS5736Z, ENTK36, ENTK37, NV51M	23.R5202.001
	SPEAKER L	23.R4F02.003
<b>MISCELLANEOUS</b>		
	LCD SCREW PAD	47.R4F02.001



# Screw List

---

**Table 6-4. Screw List**

Category	Description	Acer Part No.
	SCREW 2.5D 5L K 5.5D ZK NL + CR3	86.R4F02.001
	SCREW 2.45D 8.0L K 5.5D 0.8T ZK NL	86.R4F02.002
	SCREW 2.5D 6L K 5.5D NI NL	86.R4F02.003
	SCREW 1.98D 3.0L K 4.6D 0.8T ZK NL	86.R4F02.004
	SCREW 3.0D 3.0L K 4.9D NI	86.R4F02.005
	SCREW 2.5D 3.2L K 6D NI	86.R4F02.006
	SCREW 2.0D 3L K 3.5D ZK NL	86.R4F02.007
	SCREW ASSY CPU THERMAL	86.R4F02.008



# CHAPTER 7

## Model Definition and Configuration

---

**Packard Bell EasyNote TK11BZ/TK13BZ .....7-3**

# Model Definition and Configuration

## Packard Bell EasyNote TK11BZ/TK13BZ

**Table 7-1. RO, Description**

Model	RO	Country	Acer Part No	Description
ENTK11BZ-E 352G32Mnkk	EMEA	Holland	LX.BSG02.001	ENTK11BZ-E352G32Mnkk W7HP64BSNL1 UMACKk_3 1*2G/320/6L2.2/2R/CB_bgn_1.3C_ AUK_NL31 EASYNOTE_TK11BZ-002NL
ENTK11BZ-E 352G50Mnkk	EMEA	Russia	LX.BSG08.001	ENTK11BZ-E352G50Mnkk W7ST32RUBSRU2 UMACKk_3 1*2G/500_L/6L2.2/2R/CB_GN_1.3C_ _AUK_RU41 EASYNOTE_TK11-BZ-101RU
ENTK11BZ-E 353G50Mnkk	EMEA	Hungary	LX.BSG0C.001	ENTK11BZ-E353G50Mnkk LNPUSBHU1 UMACKk_3 2G+1G/500_L/6L2.2/2R/CB_GN_1. 3C_AUK_EN41 EASYNOTE_F4011-BZ-132HG
ENTK11BZ-E 353G50Mnkk	EMEA	Russia	LX.BSG01.001	ENTK11BZ-E353G50Mnkk W7HB64RUBSRU2 UMACKk_3 2G+1G/500_L/6L2.2/2R/CB_GN_1. 3C_AUK_RU41 EASYNOTE_TK11-BZ-003RU
ENTK11BZ-E 353G50Mnkk	EMEA	Russia	LX.BSG02.002	ENTK11BZ-E353G50Mnkk W7HP64RUBSRU2 UMACKk_3 2G+1G/500_L/BT/6L2.2/2R/CB_GN _1.3C_AUK_RU41 EASYNOTE_TK11-BZ-104RU
ENTK13BZ-E 352G32Mnrr	EMEA	Holland	LX.BSJ02.001	ENTK13BZ-E352G32Mnrr W7HP64BSNL1 UMACrr_3 1*2G/320/6L2.2/2R/CB_bgn_1.3C_ AUr_NL31 EASYNOTE_TK13BZ-002NL

**Table 7-2. CPU, LCD, VGA Chip**

Model	Country	Acer Part No	CPU	LCD	VGA Chip
ENTK11BZ-E 352G32Mnkk	Holland	LX.BSG02.001	AMDE350B	NLED15.6WXGAG	UMA
ENTK11BZ-E 352G50Mnkk	Russia	LX.BSG08.001	AMDE350B	NLED15.6WXGAG	UMA

**Table 7-2. CPU, LCD, VGA Chip (Continued)**

Model	Country	Acer Part No	CPU	LCD	VGA Chip
ENTK11BZ-E 353G50Mnkk	Hungary	LX.BSG0C.001	AMDE350B	NLED15.6WXGAG	UMA
ENTK11BZ-E 353G50Mnkk	Russia	LX.BSG01.001	AMDE350B	NLED15.6WXGAG	UMA
ENTK11BZ-E 353G50Mnkk	Russia	LX.BSG02.002	AMDE350B	NLED15.6WXGAG	UMA
ENTK13BZ-E 352G32Mnrr	Holland	LX.BSJ02.001	AMDE350B	NLED15.6WXGAG	UMA

**Table 7-3. Memory 1, Memory 2, HDD**

Model	Country	Acer Part No	Memory 1	Memory 2	HDD (GB)
ENTK11BZ-E3 52G32Mnkk	Holland	LX.BSG02.001	SO2GBIII10	N	N320GB5.4KS_4K
ENTK11BZ-E3 52G50Mnkk	Russia	LX.BSG08.001	SO2GBIII10	N	N500GB5.4KS
ENTK11BZ-E3 53G50Mnkk	Hungary	LX.BSG0C.001	SO2GBIII10	SO1GBIII10	N500GB5.4KS
ENTK11BZ-E3 53G50Mnkk	Russia	LX.BSG01.001	SO2GBIII10	SO1GBIII10	N500GB5.4KS
ENTK11BZ-E3 53G50Mnkk	Russia	LX.BSG02.002	SO2GBIII10	SO1GBIII10	N500GB5.4KS
ENTK13BZ-E 352G32Mnrr	Holland	LX.BSJ02.001	SO2GBIII10	N	N320GB5.4KS_4K

**Table 7-4. ODD, Extra SW, Card Reader**

Model	Country	Acer Part No	ODD	Extra SW	Card Reader
ENTK11BZ-E 352G32Mnkk	Holland	LX.BSG02.001	NSM8XS	NIS	2-in-1 card reader
ENTK11BZ-E 352G50Mnkk	Russia	LX.BSG08.001	NSM8XS	NIS	2-in-1 card reader
ENTK11BZ-E 353G50Mnkk	Hungary	LX.BSG0C.001	NSM8XS	N	2-in-1 card reader
ENTK11BZ-E 353G50Mnkk	Russia	LX.BSG01.001	NSM8XS	NIS	2-in-1 card reader
ENTK11BZ-E 353G50Mnkk	Russia	LX.BSG02.002	NSM8XS	NIS	2-in-1 card reader
ENTK13BZ-E 352G32Mnrr	Holland	LX.BSJ02.001	NSM8XS	NIS	2-in-1 card reader

**Table 7-5. Wireless, Bluetooth, NB Chipset**

Model	Country	Acer Part No	Wireless LAN	Bluetooth	NB Chipset
ENTK11BZ-E 352G32Mnkk	Holland	LX.BSG02.001	3rd WiFi 2x2 BGN	N	AMD A50M FCH
ENTK11BZ-E 352G50Mnkk	Russia	LX.BSG08.001	3rd WiFi 2x2 BGN	N	AMD A50M FCH
ENTK11BZ-E 353G50Mnkk	Hungary	LX.BSG0C.001	3rd WiFi 2x2 BGN	N	AMD A50M FCH
ENTK11BZ-E 353G50Mnkk	Russia	LX.BSG01.001	3rd WiFi 2x2 BGN	N	AMD A50M FCH
ENTK11BZ-E 353G50Mnkk	Russia	LX.BSG02.002	3rd WiFi 2x2 BGN	BT 3.0	AMD A50M FCH
ENTK13BZ-E 352G32Mnrr	Holland	LX.BSJ02.001	3rd WiFi 2x2 BGN	N	AMD A50M FCH

**Table 7-6. Battery, Adapter, Camera**

Model	Country	Acer Part No	Battery	Adapter	Camera
ENTK11BZ-E 352G32Mnkk	Holland	LX.BSG02.001	6CELL2.2	65W	1.3M
ENTK11BZ-E 352G50Mnkk	Russia	LX.BSG08.001	6CELL2.2	65W	1.3M
ENTK11BZ-E 353G50Mnkk	Hungary	LX.BSG0C.001	6CELL2.2	65W	1.3M
ENTK11BZ-E 353G50Mnkk	Russia	LX.BSG01.001	6CELL2.2	65W	1.3M
ENTK11BZ-E 353G50Mnkk	Russia	LX.BSG02.002	6CELL2.2	65W	1.3M
ENTK13BZ-E 352G32Mnrr	Holland	LX.BSJ02.001	6CELL2.2	65W	1.3M





# CHAPTER 8

## Test Compatible Components

---

**Microsoft® Windows® 7 Environment Test . . . . .8-4**

# Test Compatible Components

---

This computer's compatibility is tested and verified by Acer's internal testing department. All of its system functions are tested under Windows® 7 environment.

Refer to the following lists for components, adapter cards, and peripherals which have passed these tests. Regarding configuration, combination and test procedures, please refer to the Packard Bell EasyNote TK11BZ/TK13BZ. Compatibility Test Report released by the Acer Mobile System Testing Department.

# Microsoft® Windows® 7 Environment Test

**Table 8-1. Test Compatible Components**

Vendor	Type	Description	Part No.
<b>Accessory</b>			
10001061 TSS	Power DVD 10	Software POWER DVD 10, V10.0.2318.52	LZ.23800.071
10001061 TSS	Power DVD 9	Software POWER DVD 9, V9.0.2723.50	SR.23900.009
<b>Adapter</b>			
10001023 LITE-ON	65W	Adapter LITE-ON 65W 19V 1.7x5.5x11 Yellow PA-1650-22AC LV5 LED LF	AP.06503.024
10001023 LITE-ON	65W	Adapter LITE-ON 65W 19V 1.7x5.5x11 Yellow PA-1650-69AW, LV5, Low profile LED LF	AP.06503.029
10001081 DELTA	65W	Adapter DELTA 65W 19V 1.7x5.5x11 Yellow ADP-65JH DB A, LV5 LED LF	AP.06501.026
10001081 DELTA	65W	Adapter DELTA 65W 19V 1.7x5.5x11 Yellow ADP-65VH BA, LV5, Low profile LED LF	AP.06501.033
60002015 HIPRO	65W	Adapter HIPRO 65W 19V 1.7x5.5x11 Yellow HP-A0652R3B 1LF, LV5 LED LF	AP.0650A.012
60016453 CHICONY POWER	65W	Adapter Chicony Power 65W 19V 1.7x5.5x11 Yellow CPA09-A065N1, LV5, low profile LF	AP.0650A.017
<b>Audio Codec</b>			
PLM00004 Conexant	Conexant CX-20584	Conexant Audio Codec CX-20584	LZ.21000.086
<b>Battery</b>			
10001063 SONY	6CELL2.2	Battery SONY AS10D Li-Ion 3S2P SONY 6 cell 4400mAh Main COMMON ID:AS10D41	BT.00604.049
60001535 PANASONIC	6CELL2.2	Battery PANASONIC AS10D Li-Ion 3S2P PANASONIC 6 cell 4400mAh Main COMMON ID:AS10D51	BT.00605.062

**Table 8-1. Test Compatible Components**

Vendor	Type	Description	Part No.
60001921 SANYO	6CELL2.2	Battery SANYO AS10D Li-Ion 3S2P SANYO 6 cell 4400mAh Main COMMON ID:AS10D31	BT.00603.111
60002162 SIMPLO	6CELL2.2	Battery SIMPLO AS10D Li-Ion 3S2P PANASONIC 6 cell 4400mAh Main COMMON ID:AS10D71	BT.00607.125
60002162 SIMPLO	6CELL2.2	Battery SIMPLO AS10D Li-Ion 3S2P SAMSUNG 6 cell 4400mAh Main COMMON ID:AS10D	BT.00607.127
60002162 SIMPLO	6CELL2.2	Battery SIMPLO AS10H Li-Ion 3S2P SAMSUNG 6 cell 4400mAh Main COMMON ID:AS10H75	BT.00607.132
60013145 SAMSUNG SDI	6CELL2.2	Battery SAMSUNG AS10D Li-Ion 3S2P SAMSUNG 6 cell 4400mAh Main COMMON ID:AS10D61	BT.00606.008
<b>Bluetooth</b>			
10001018 HON HAI	BT 3.0	Foxconn Bluetooth BRM 2070 (T77H114.01) BT 3.0	BH.21100.010
10001018 HON HAI	BT 3.0	Foxconn Bluetooth ATH BU12	BH.21100.011
23707801 FOXCONN TW	BT 2.1	Foxconn Bluetooth BRM 2070 (T77H114.01)	BH.21100.007
<b>Camera</b>			
10001023 LITE-ON	1.3M	Liteon 1.3M LT9665AL (09P2SF119)	AM.21400.069
10001023 LITE-ON	1.3M	Liteon 1.3M LT6AASP(09P2BF127)	AM.21400.070
10001044 CHICONY	1.3M	Chicony 1.3M CH9665SN (CNF9157)	AM.21400.067
PLM00012 Suyin	1.3M	Suyin 1.3M SY9665SN	AM.21400.068
<b>Card Reader</b>			
10000981 MISC	2-in-1 card reader	2-in-1 card reader	CR.21500.030
<b>CPU</b>			
60002168 AMD	AMDC50B	CPU AMD - C50 BGA 1.0G / 9W	KC.C0002.500
60002168 AMD	AMDE240B	CPU AMD - E240 BGA 1.5G 18W	KC.E0002.240
60002168 AMD	AMDE350B	CPU AMD - E350 BGA 1.6G 18W	KC.E0002.350

**Table 8-1. Test Compatible Components**

Vendor	Type	Description	Part No.
<b>HDD</b>			
60001922 TOSHIBA DIGI	N250GB5.4KS	HDD TOSHIBA 2.5" 5400rpm 250GB MK2565GSX, Capricorn BS, 320G/P SATA 8MB LF F/W:GJ002J	KH.25004.005
60001922 TOSHIBA DIGI	N320GB5.4KS	HDD TOSHIBA 2.5" 5400rpm 320GB Capricorn BS,MK3265GSX SATA 8MB LF F/W:GJ002J	KH.32004.004
60001922 TOSHIBA DIGI	N500GB5.4KS	HDD TOSHIBA 2.5" 5400rpm 500GB MK5065GSX,Capricorn BS, 320G/P SATA 8MB LF F/W:GJ002J	KH.50004.002
60001922 TOSHIBA DIGI	N640GB5.4KS	HDD TOSHIBA 2.5" 5400rpm 640GB MK6465GSX,Capricorn BS,320G/P SATA 8MB LF F/W:GJ002J	KH.64004.001
60001922 TOSHIBA DIGI	N750GB5.4KS	HDD TOSHIBA 2.5" 5400rpm 750GB MK7559GSXP, 375G/P, Capricorn BS, 4K drive SATA 8MB LF+HF F/W:GN003J	KH.75004.001
60001994 WD	N250GB5.4KS	HDD WD 2.5" 5400rpm 250GB WD2500BPVT-22ZEST0,ML32 0S-AF, 4K drive SATA 8MB LF F/W:01.01A01 4K drive	KH.25008.029
60001994 WD	N320GB5.4KS_4K	HDD WD 2.5" 5400rpm 320GB WD3200BPVT-22ZEST0, ML320S, 4K drive SATA 8MB LF F/W: 01.01A01	KH.32008.022
60001994 WD	N500GB5.4KS	HDD WD 2.5" 5400rpm 500GB WD5000BPVT-22HXZT1,ML37 5_AF, 4K drive SATA 8MB LF+HF F/W:01.01A01	KH.50008.021
60001994 WD	N640GB5.4KS	HDD WD 2.5" 5400rpm 640GB WD6400BPVT-22HXZT1, ML375M SATA 8MB LF F/W: 01.01A01	KH.64008.005
60001994 WD	N750GB5.4KS	HDD WD 2.5" 5400rpm 750GB WD7500BPVT-22HXZT1, ML375M, 4K drive SATA 8MB LF F/W:01.01A01	KH.75008.009

**Table 8-1. Test Compatible Components**

Vendor	Type	Description	Part No.
60002005 HGST SG	N250GB5.4KS	HDD HGST 2.5" 5400rpm 250GB HTS545025B9A300 Panther B SATA LF F/W:C60F Disk imbalance criteria = 0.014g-cm	KH.25007.016
60002005 HGST SG	N320GB5.4KS	HDD HGST 2.5" 5400rpm 320GB HTS545032B9A300 Panther B SATA LF F/W:C60F Disk imbalance criteria = 0.014g-cm	KH.32007.008
60002005 HGST SG	N320GB5.4KS	HDD HGST 2.5" 5400rpm 320GB HTS543232A7A384,0J11523, Eagle B7 SATA 8MB LF F/W:A60W 7mmzh	KH.32007.012
60002005 HGST SG	N500GB5.4KS	HDD HGST 2.5" 5400rpm 500GB HTS545050B9A300 Panther B SATA LF F/W:C60F Disk imbalance criteria = 0.014g-cm	KH.50007.010
60002005 HGST SG	N750GB5.4KS	HDD HGST 2.5" 5400rpm 750GB HTS547575A9E384, 0J15083, Jet B, 375G/P SATA 8MB LF F/W:DA3872	KH.75007.004
60002036 SEAGATE	N250GB5.4KS	HDD SEAGATE 2.5" 5400rpm 250GB ST9250315AS, 9HH132-189, Wyatt with new pcb SATA 8MB LF F/W:0001SDM1	KH.25001.019
60002036 SEAGATE	N320GB5.4KS	HDD SEAGATE 2.5" 5400rpm 320GB ST9320310AS,9RN132-188, Cameron 320G/P SATA 8MB LF F/W:0001SDM1	KH.32001.019
60002036 SEAGATE	N500GB5.4KS	HDD SEAGATE 2.5" 5400rpm 500GB ST9500325AS,9HH134-189, Wyatt with new pcb SATA 8MB LF F/W:0001SDM1	KH.50001.017
60002036 SEAGATE	N750GB5.4KS	HDD SEAGATE 2.5" 5400rpm 750GB ST9750423AS,9ZW14G-188, Desaru5, 375G/P. SATA 8MB LF+HF F/W:0001SDM1	KH.75001.011

**Table 8-1. Test Compatible Components**

Vendor	Type	Description	Part No.
<b>Keyboard</b>			
60004864 DARFON	AC7T_G10B	Keyboard GATEWAY AC7T_G10B AC7T Internal 17 Standard Black NONE Y2010 GTW_PB Legend Texture	KB.I170G.142
<b>LAN</b>			
10017383 Atheros	AR8151L	Atheros AR8151L	NI.22400.048
<b>LCD</b>			
10001038 CMO	NLED15.6WXGAG	LED LCD CMO 15.6"W WXGA Glare N156B6-L0B LF 220nit 8ms 650:1	LK.1560D.010
60001927 CPT	NLED15.6WXGAG	LED LCD CPT 15.6"W WXGA Glare CLAA156WB11A LF 220nit 8ms 600:1	LK.1560A.004
60002215 SAMSUNG	NLED15.6WXGAG	LED LCD SAMSUNG 15.6"W WXGA Glare LTN156AT02-A11 LF 220nit 8ms 500:1	LK.15606.012
60003089 LG	NLED15.6WXGAG	LED LCD LPL 15.6"W WXGA Glare LP156WH2-TLEA LF 220nit 16ms 500:1 (color engine)	LK.15608.011
60003316 AUO	NLED15.6WXGAG	LED LCD AUO 15.6"W WXGA Glare B156XW02 V2 LF 200nit 8ms 500:1 (power saving)	LK.15605.010
60003316 AUO	NLED15.6WXGAG	LED LCD AUO 15.6"W WXGA Glare B156XW02 V6 LF 200nit 8ms 400:1	LK.15605.019
<b>Memory</b>			
60001993 NANYA	SO1GBIII13	Memory NANYA SO-DIMM DDRIII 1333 1GB NT1GC64BH4B0PS-CG LF 128*16 0.055um	KN.1GB03.034
60001993 NANYA	SO2GBIII13	Memory NANYA SO-DIMM DDRIII 1333 2GB NT2GC64B88B0NS-CG LF 256*8 0.055um	KN.2GB03.021
60002000 UNIFOSA	SO1GBIII13	Memory UNIFOSA SO-DIMM DDRIII 1333 1GB GU672203EP0200 LF 128*8 0.065um	KN.1GB0H.017
60002041 QIMONDA	SO1GBIII10	Memory NONE REG-ECC DDRIII 1066 1GB phantom p/n LF	KN.1GB00.003



**Table 8-1. Test Compatible Components**

<b>Vendor</b>	<b>Type</b>	<b>Description</b>	<b>Part No.</b>
60002045 HYNIX	SO2GBIII13	Memory HYNIX SO-DIMM DDRIII 1333 2GB HMT325S6BFR8C-H9 LF 256*8 46nm	KN.2GB0G.018
60002215 SAMSUNG	SO1GBIII13	Memory SAMSUNG SO-DIMM DDRIII 1333 1GB M471B2873FHS-CH9 LF 128*8 46nm	KN.1GB0B.035
60002215 SAMSUNG	SO2GBIII10	Memory NONE SO-DIMM DDRIII 1066 2GB dummy 1066 LF	KN.2GB00.001
60002215 SAMSUNG	SO2GBIII13	Memory SAMSUNG SO-DIMM DDRIII 1333 2GB M471B5773DH0-CH9 LF 256*8	KN.2GB0B.030
60002215 SAMSUNG	SO4GBIII10	Memory SAMSUNG SO-DIMM DDRIII 1066 4GB M471B5273BH1-CF8 LF 256*8 0.055um	KN.4GB0B.007
60004668 ELPIDA	SO2GBIII13	Memory ELPIDA SO-DIMM DDRIII 1333 2GB EBJ21UE8BFU0-DJ-F LF 128*8 0.065um	KN.2GB09.009
60004668 ELPIDA	SO4GBIII10	Memory NONE SO-DIMM DDRIII 1066 4GB dummy P/N LF	KN.4GB00.001
60004668 ELPIDA	SO4GBIII13	Memory ELPIDA SO-DIMM DDRIII 1333 4GB EBJ41UF8BAS0-DJ-F LF 256*8 0.055um	KN.4GB09.001
60024207 KINGSTON	SO1GBIII13	Memory KINGSTON SO-DIMM DDRIII 1333 1GB ACR128X64D3S1333C9 LF 128*8 0.065um	KN.1GB07.004
60024207 KINGSTON	SO2GBIII13	Memory KINGSTON SO-DIMM DDRIII 1333 2GB ACR256X64D3S1333C9 LF 128*8 0.065um	KN.2GB07.004
<b>NB Chipset</b>			
60002168 AMD	AMD A50M FCH	AMD NB Chipset A50M	KI.22600.055
<b>ODD</b>			
10001063 SONY	NSM8XS	ODD SONY Super-Multi DRIVE 12.7mm Tray DL 8X AD-7585H LF W/O bezel SATA (HF + Windows 7)	KU.0080E.027

**Table 8-1. Test Compatible Components**

Vendor	Type	Description	Part No.
10001070 PHILIPS	NBDCB4XS	ODD PLDS BD COMBO 12.7mm Tray DL 4X DS-6E2SH LF W/O bezel SATA (HF + Win7 + 3D)	KO.0040F.006
10001070 PHILIPS	NSM8XS	ODD PLDS Super-Multi DRIVE 12.7mm Tray DL 8X DS-8A5SH LF+HF W/O bezel SATA With TI + Rohm Solution (HF + Windows 7)	KU.0080F.014
60001535 PANASONIC	NBDCB4XS	ODD PANASONIC BD COMBO 12.7mm Tray DL 4X UJ141AL LF W/O bezel SATA Windows 7	KO.00407.004
60001535 PANASONIC	NSM8XS	ODD PANASONIC Super-Multi DRIVE 12.7mm Tray DL 8X UJ8A0 LF W/O bezel SATA (HF + Windows 7) Foxconn Yentai Factory	KU.00807.075
60001535 PANASONIC	NSM8XS	ODD PANASONIC Super-Multi DRIVE 12.7mm Tray DL 8X UJ890A LF W/O bezel SATA (HF + Windows 7)	KU.00807.070
60001922 TOSHIBA DIGI	NSM8XS	ODD TOSHIBA Super-Multi DRIVE 12.7mm Tray DL 8X TS-L633F LF W/O bezel SATA (HF + Windows 7)	KU.00801.040
60001939 PIONEER	NBDCB4XS	ODD PIONEER BD COMBO 12.7mm Tray DL 4X BDC-TD03RS LF W/O bezel 1.01 SATA (Windows 7)	KO.00405.006
60001939 PIONEER	NSM8XS	ODD PIONEER Super-Multi DRIVE 12.7mm Tray DL 8X DVR-TD10RS LF W/O bezel 1.00 SATA	KU.00805.049
60003901 HITACHI EAST	NBDCB4XS	ODD HLDS BD COMBO 12.7mm Tray DL 4X CT30N LF W/O bezel 1.00 SATA (HF + Windows 7 + 3D)	KO.0040D.005
60003901 HITACHI EAST	NSM8XS	ODD HLDS Super-Multi DRIVE 12.7mm Tray DL 8X GT34N LF W/O bezel SATA Zero Power Supported, PCC LD (HF + Windows 7)	KU.0080D.057
610105 HLDS	NBDCB4XS	ODD HLDS BD COMBO 12.7mm Tray DL 4X CT21N LF W/O bezel 1.00 SATA (HF + Windows 7)	KO.0040D.004

**Table 8-1. Test Compatible Components**

Vendor	Type	Description	Part No.
610105 HLDS	NSM8XS	ODD HLDS Super-Multi DRIVE 12.7mm Tray DL 8X GT32N (R5-2) LF W/O bezel SATA with Renesas solution + PCC LD (HF + Windows 7)	KU.0080D.055
<b>SB Chipset</b>			
9999995 ONE TIME VENDER	N	N	KI.22800.011
<b>Software</b>			
10000981 MISC	NIS	Antivirus application NIS	SR.23900.002
<b>VGA Chip</b>			
22554573 AMD	UMA	UMA (AMD)	KI.23200.154
60002168 AMDISS	SEYMOUR_XT	VGA Chip AMD SEYMOUR_XT 40nm 29mm*29mm M2 package	KG.SEY0A.001
<b>VRAM</b>			
10000981 MISC	1G-DDR3 (128*16*4)	1G-DDR3 128*16*4	KI.23300.029
10000981 MISC	512M-DDR3 (64*16*4)	512M-DDR3 64*16*4	KI.23300.019
60002045 HYNIX	VR1GbIII9	VRAM HYNIX Graphic DDRIII 900 1Gb H5TQ1G63DFR-11C LF 64*16 46nm	VR.1GB0G.006
60002215 SAMSUNG	VR1GbIII9	VRAM SAMSUNG Graphic DDRIII 900 1Gb K4W1G1646G-BC11 LF 64*16 35nm	VR.1GB0B.008
9999995 ONE TIME VENDER	N	N no VRAM	KI.23300.014
<b>WiFi Antenna</b>			
10000105 WNC	PIFA	PIFA	LZ.23500.006
<b>Wireless LAN</b>			
10001023 LITE-ON	3rd WiFi 2x2 BGN	Liteon Wireless LAN Atheros HB97 2x2 BGN (HM) WN6603AH	NI.23600.073
10001023 LITE-ON	3rd WiFi 2x2 BGN	Liteon Wireless LAN Realtek 8192SE BGN WN6603LH(2x2 BGN)	NI.23600.065
10001023 LITE-ON	3rd WiFi 2x2 BGN	Liteon Wireless LAN Broadcom 43225 2x2 BGN	NI.23600.081

**Table 8-1. Test Compatible Components**

<b>Vendor</b>	<b>Type</b>	<b>Description</b>	<b>Part No.</b>
23707801 FOXCONN TW	3rd WiFi 2x2 BGN	Foxconn Wireless LAN Atheros HB97 2x2 BGN (HM)	NI.23600.072
23707801 FOXCONN TW	3rd WiFi 2x2 BGN	Foxconn Wireless LAN Broadcomm 43225 2x2 BGN (HM) T77H103.00	NI.23600.066
23707801 FOXCONN TW	3rd WiFi BG	Foxconn Wireless LAN Atheros HB95BG (HM) T77H121.10	NI.23600.077

# CHAPTER 9

## Online Support Information

---

**Introduction . . . . .9-3**

# Online Support Information

---

## Introduction

---

This section describes online technical support services available to help users repair their Acer Systems.

For distributors, dealers, ASP or TPM, refer the technical queries to a local Acer branch office. Acer Branch Offices and Regional Business Units may access our website. However some information sources will require a user i.d. and password. These can be obtained directly from Acer CSD Taiwan.

Acer's Website offers convenient and valuable support resources.

In the Technical Information section users can download information on all of Acer's Notebook, Desktop and Server models including:

- Service guides for all models
- BIOS updates
- Software utilities
- Spare parts lists
- TABs (Technical Announcement Bulletin)

For these purposes, we have included an Acrobat File to facilitate the problem-free downloading of our technical material.

Also contained on this website are:

- Detailed information on Acer's International Traveller's Warranty (ITW)
- Returned material authorization procedures
- An overview of all the support services we offer, accompanied by a list of telephone, fax and e-mail contacts for all technical queries.

We are always looking for ways to optimize and improve our services, so do not hesitate to direct any suggestions or comments to us.





## Free Manuals Download Website

<http://myh66.com>

<http://usermanuals.us>

<http://www.somanuals.com>

<http://www.4manuals.cc>

<http://www.manual-lib.com>

<http://www.404manual.com>

<http://www.luxmanual.com>

<http://aubethermostatmanual.com>

Golf course search by state

<http://golfingnear.com>

Email search by domain

<http://emailbydomain.com>

Auto manuals search

<http://auto.somanuals.com>

TV manuals search

<http://tv.somanuals.com>