

Packard Bell EasyNote LJ61 Service Guide

Service guide files and updates are available on the ACER/CSD web; for more information, please refer to <http://csd.acer.com.tw>

PRINTED IN TAIWAN

Revision History

Please refer to the table below for the updates made to this service guide.

Date	Chapter	Updates

Copyright

Copyright © 2009 by Acer Incorporated. All rights reserved. No part of this publication may be reproduced, transmitted, transcribed, stored in a retrieval system, or translated into any language or computer language, in any form or by any means, electronic, mechanical, magnetic, optical, chemical, manual or otherwise, without the prior written permission of Acer Incorporated.

Disclaimer

The information in this guide is subject to change without notice.

Acer Incorporated makes no representations or warranties, either expressed or implied, with respect to the contents hereof and specifically disclaims any warranties of merchantability or fitness for any particular purpose. Any Acer Incorporated software described in this manual is sold or licensed "as is". Should the programs prove defective following their purchase, the buyer (and not Acer Incorporated, its distributor, or its dealer) assumes the entire cost of all necessary servicing, repair, and any incidental or consequential damages resulting from any defect in the software.

Acer is a registered trademark of Acer Corporation.

Intel is a registered trademark of Intel Corporation.

Pentium and Pentium II/III are trademarks of Intel Corporation.

Other brand and product names are trademarks and/or registered trademarks of their respective holders.

Conventions

The following conventions are used in this manual:

SCREEN MESSAGES	Denotes actual messages that appear on screen.
NOTE	Gives bits and pieces of additional information related to the current topic.
WARNING	Alerts you to any damage that might result from doing or not doing specific actions.
CAUTION	Gives precautionary measures to avoid possible hardware or software problems.
IMPORTANT	Reminds you to do specific actions relevant to the accomplishment of procedures.

Preface

Before using this information and the product it supports, please read the following general information.

1. This Service Guide provides you with all technical information relating to the BASIC CONFIGURATION decided for Acer's "global" product offering. To better fit local market requirements and enhance product competitiveness, your regional office MAY have decided to extend the functionality of a machine (e.g. add-on card, modem, or extra memory capability). These LOCALIZED FEATURES will NOT be covered in this generic service guide. In such cases, please contact your regional offices or the responsible personnel/channel to provide you with further technical details.
2. Please note WHEN ORDERING FRU PARTS, that you should check the most up-to-date information available on your regional web or channel. If, for whatever reason, a part number change is made, it will not be noted in the printed Service Guide. For ACER-AUTHORIZED SERVICE PROVIDERS, your Acer office may have a DIFFERENT part number code to those given in the FRU list of this printed Service Guide. You MUST use the list provided by your regional Acer office to order FRU parts for repair and service of customer machines.

System Specifications	1
Features	1
System Block Diagram	4
Your Notebook tour	5
Front View	5
Left View	6
Right View	7
Rear View	7
Bottom View	8
Keyboard Area (selected models)	9
LCD Panel	10
Status Indicators	11
TouchPad Basics	12
Using the Keyboard	13
Key Types	13
Windows Keys	14
System Keys	15
Using the System Utilities	16
Acer GridVista (dual-display compatible)	16
Hardware Specifications and Configurations	17
 System Utilities	 27
BIOS Setup Utility	27
Navigating the BIOS Utility	27
Information	28
Main	29
Security	30
Boot	33
Exit	34
BIOS Flash Utilities	35
DOS Flash Utility	36
WinFlash Utility	38
Remove HDD/BIOS Password Utilities	39
 Machine Disassembly and Replacement	 43
Disassembly Requirements	43
General Information	44
Pre-disassembly Instructions	44
Disassembly Process	44
External Module Disassembly Process	45
External Modules Disassembly Flowchart	45
Removing the Battery Pack	46
Removing the SD dummy card	47
Removing the Lower Covers	48
Removing the Optical Drive Module	49
Removing the DIMM Modules	51
Removing the WLAN Module	52
Removing the Primary HDD Module	54
Removing the Secondary HDD Module	56
Main Unit Disassembly Process	58
Main Unit Disassembly Flowchart	58
Removing the Switch Cover	59
Removing the Media Board	62
Removing the Keyboard	63

Table of Contents

Removing the LCD Module	65
Removing the Upper Cover	70
Removing the TouchPad Bracket	74
Removing the Media Board FFC	75
Removing the LED Board	76
Removing the Speaker Module	77
Removing the RTC Battery	79
Removing the Modem Board	80
Removing the USB Board	82
Removing the Mainboard	84
Removing the RJ-11 Jack	85
Removing the CPU Fan	87
Removing the Thermal Module	88
Removing the CPU	89
LCD Module Disassembly Process	90
LCD Module Disassembly Flowchart	90
Removing the LCD Bezel	91
Removing the Camera Module	92
Removing the LCD Panel	93
Removing the Power Board	94
Removing the LCD Brackets and FPC Cable	95
Removing the Microphone Module	97
Removing the Antennas	98
LCD Module Reassembly Procedure	100
Replacing the Antennas, Power Board, and MIC	100
Replacing the LCD Panel	103
Replacing the Camera Module	105
Replacing the LCD Bezel	106
Main Module Reassembly Procedure	108
Replacing the CPU	108
Replacing the Thermal Module	108
Replacing the CPU Fan	109
Replacing the RJ-11 Jack	110
Replacing the Mainboard	111
Replacing the USB Board	112
Replacing the Modem Board	113
Replacing the Speaker Module	114
Replacing the LED Board	115
Replacing the Media Board FFC	115
Replacing the TouchPad Bracket	116
Replacing the Upper Cover	116
Replacing the LCD Module	120
Replacing the Keyboard	123
Replacing the Media Board	124
Replacing the Switch Cover	125
Replacing the Hard Disk Drive Modules	127
Replacing the WLAN Module	128
Replacing the DIMM Modules	128
Replacing the ODD Module	129
Replacing the Lower Covers	129
Replacing the SD Dummy Card	131
Replacing the Battery	131

Troubleshooting

133

Common Problems	133
---------------------------	-----

Table of Contents

Power On Issue	134
No Display Issue	135
Random Loss of BIOS Settings	136
LCD Failure	137
Built-In Keyboard Failure	137
TouchPad Failure	138
Internal Speaker Failure	138
Internal Microphone Failure	140
HDD Not Operating Correctly	141
ODD Failure	142
USB Failure	145
Modem Function Failure	145
Wireless Function Failure	146
BT Unit Failure	147
Function Board Failure	148
Thermal Unit Failure	148
External Mouse Failure	149
Other Failures	149
Intermittent Problems	150
Undetermined Problems	150
Post Codes	151
Chipset POST Codes	151
Jumper and Connector Locations	155
Top View	155
Bottom View	156
Clearing Password Check and BIOS Recovery	157
Clearing Password Check	157
BIOS Recovery by Crisis Disk	158
FRU (Field Replaceable Unit) List	161
Packard Bell EasyNote LJ61 Exploded Diagrams	162
Main Assembly	162
Rear Assembly	163
LCD Assembly	164
Base Top Assembly	165
Packard Bell EasyNote LJ61 FRU List	166
Screw List	174
Model Definition and Configuration	176
Packard Bell EasyNote LJ61 Series	176
Test Compatible Components	181
Microsoft® Windows® Vista Environment Test	182
Online Support Information	187
Index	189

Table of Contents

System Specifications

Features

Below is a brief summary of the computer's many features:

NOTE: Items marked with * denote only selected models.

Operating System

- Genuine Windows® Vista™

Platform

- AMD Athlon X2 QL-64 2.1GHz
- 1MB Cache
- 667MHz Bus Speed

System Memory

- 3072MB DDR2
- On board with two 200-pin +1.8V DDRII SO-DIMM connector, supporting DDR II 667/800 SDRAM memory interface design, 0MB DDR RAM on board, Two DDR SODIMM slot. Maximum memory: 2GB per slot. 4GB total.

Display

- Screen resolution: 1600x900
- Monitor size 17.3 inch
- Technology and ratio TFT

Graphics

- ATI Mobility Radeon™ HD3200 up to 1407MB Hypermemory

Storage subsystem

- SATA
- 9.5mm, 2.5" HDD Support with 120GB/160GB/200GB/250GB
- Support Ultra DMA100, S.M.A.R.T
- 5400 RPM
- External USB FDD

Optical Drive

- DVDRW R9

Audio

- Chipset: Realtek ALC272
- Integrated on motherboard or on PCI Slot Integrated
- Sound Stereo
- Dolby sound room

I/O Interface

- 15 pin CRT port
- HDMI port
- MIC In
- 90W DC-in jack for AC Adapter
- Four External USB 2.0 jacks
- RJ-11 jack for Modem
- RJ-45 jack for LAN
- 5 in 1 connector

Dimensions and Weight

- Chassis dimensions: 412mmx280mmx38.6mm
- Weight: 3.4Kg

Communication

- Ethernet: 10/100/ GigaLAN Ethernet
- WIFI: Wireless b/g

Power subsystem

- Full ACPI 1.0B supported

Special keys and controls

- Power Button
- Launch Manager Button
- Backup Date Button
- Enable/Disable Wireless Button
- Enable/Disable Touch Pad Button
- Enable/Disable Mute Button
- Reduce Volume Button
- Increase Volume Button

Environment

- Temperature:
 - Operating: 5 °C to 35 °C
 - Non-operating: -20 °C to 65 °C

-
- Humidity (non-condensing):
 - Operating: 20% to 80%
 - Non-operating: 20% to 80%

NOTE: Items marked with * denote only selected models.

System Block Diagram

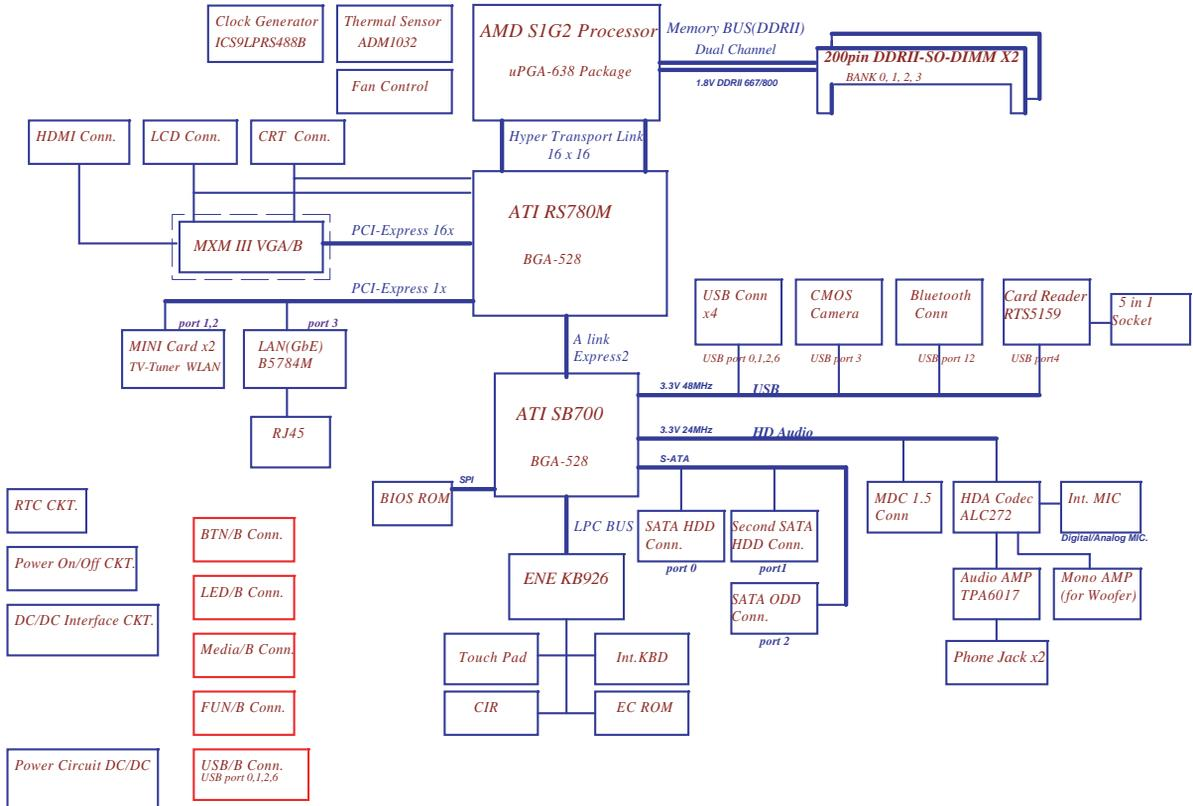

Your Notebook tour

After knowing your computer features, let us show you around your new computer.

Front View



Ventilation fan

Component	Icon	Description
Ventilation fan		<p>Helps cool internal components.</p> <p>Warning: Do not work with the notebook resting on your lap. If the air vents are blocked, the notebook may become hot enough to harm your skin.</p> <p>Caution: Do not block or insert objects into these slots. If these slots are blocked, your notebook may overheat resulting in unexpected shutdown or permanent damage to the notebook.</p> <p>Caution: Provide adequate space around your notebook so air vents are not obstructed. Do not use the notebook on a bed, sofa, rug, or other similar surface.</p>

Left View

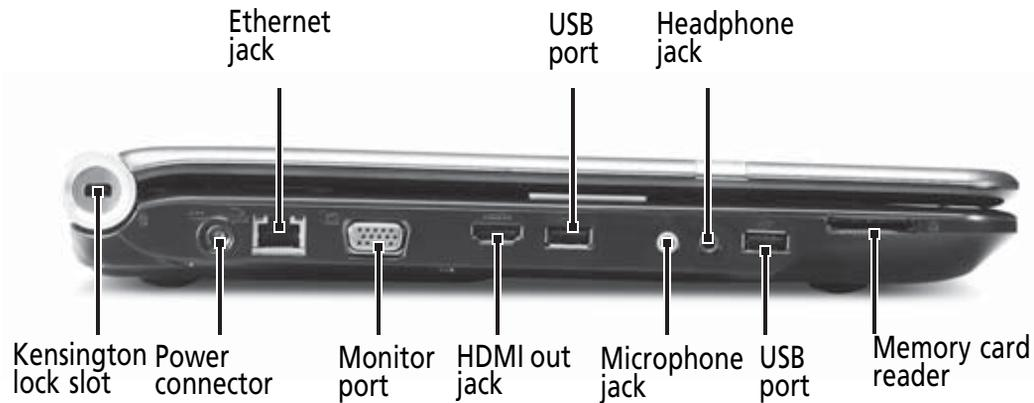

Component	Icon	Description
Kensington™ lock slot		Secure your notebook to an object by connecting a Kensington cable lock to this slot.
Power connector		Plug the AC adapter cable into this connector.
Ethernet jack		Plug an Ethernet network cable into this jack. Plug the other end of the cable into a cable modem, DSL modem, or an Ethernet network jack.
Monitor port		Plug an analog VGA monitor or projector into this port.
HDMI out jack	HDMI	HDMI Plug an HDMI device, such as a high definition television, into this optional jack.
USB port		Plug USB devices (such as a diskette drive, flash drive, printer, scanner, camera, keyboard, or mouse) into these ports.
Microphone jack		Plug a microphone into this jack.
Headphone jack		Plug amplified speakers or headphones into this jack. The built-in speakers are turned off when speakers or headphones are plugged into this jack. <ul style="list-style-type: none"> Headphone with SPDIF support
Memory card reader		Insert a memory card from a digital camera, MP3 player, PDA, or cellular telephone into the memory card reader. The memory card reader supports Memory Stick®, Memory Stick Pro®, MultiMediaCard™, Secure Digital™, and xD-Picture Card™ cards.

Right View



Component	Icon	Description
USB port		Plug a USB device (such as a diskette drive, flash drive, printer, scanner, camera, keyboard, or mouse) into this port.
DVD drive		Insert CDs or DVDs into this drive.
Modem jack		Plug a dial-up modem cable into this optional jack.
Power button		Press to turn the power on or off. You can also configure the power button for Sleep/Resume mode.

Rear View



Component	Icon	Description
Ventilation fan		<p>Helps cool internal components.</p> <p>Warning: Do not work with the notebook resting on your lap. If the air vents are blocked, the notebook may become hot enough to harm your skin.</p> <p>Caution: Do not block or insert objects into these slots. If these slots are blocked, your notebook may overheat resulting in unexpected shutdown or permanent damage to the notebook.</p> <p>Caution: Provide adequate space around your notebook so air vents are not obstructed. Do not use the notebook on a bed, sofa, rug, or other similar surface.</p>

Bottom View

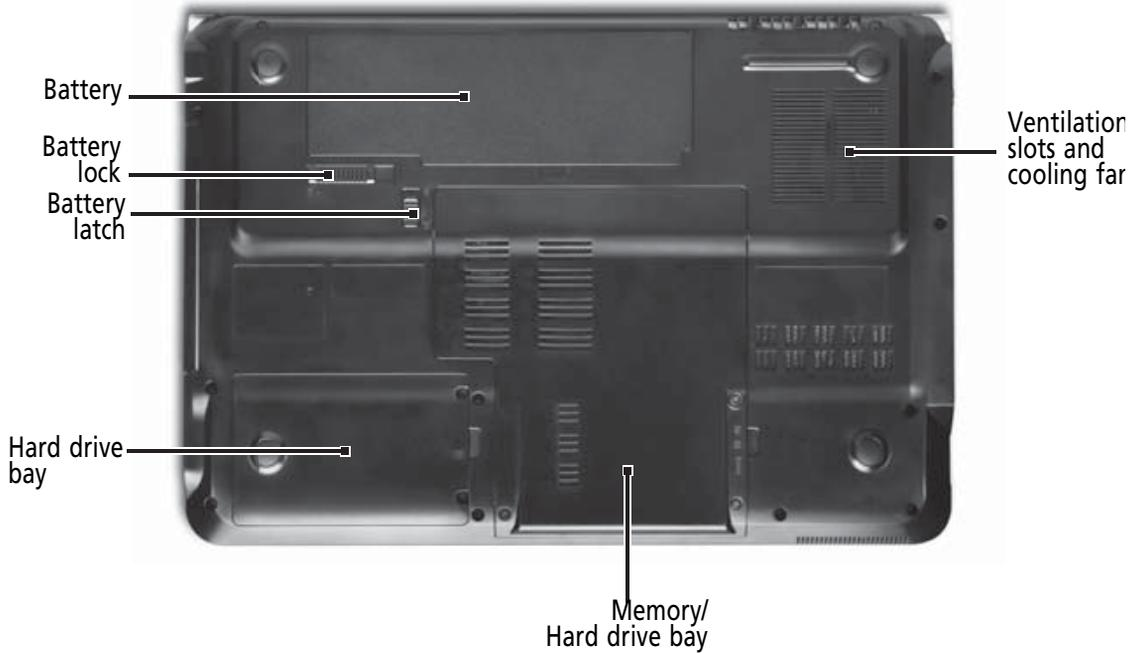

Component	Icon	Description
Battery		Provides power when the notebook is not plugged into AC power.
Battery lock		Slide to unlock the battery.
Battery latch		Slide to release the battery.
Memory bay		Memory modules are located in this bay.
Hard drive bay		The hard drive is located in this bay.
Ventilation slots and cooling fan		<p>Helps cool internal components.</p> <p>Warning: Do not work with the notebook resting on your lap. If the air vents are blocked, the notebook may become hot enough to harm your skin.</p> <p>Caution: Do not block or insert objects into these slots. If these slots are blocked, your notebook may overheat resulting in unexpected shutdown or permanent damage to the notebook.</p> <p>Caution: Provide adequate space around your notebook so air vents are not obstructed. Do not use the notebook on a bed, sofa, rug, or other similar surface.</p>

Keyboard Area (selected models)



Component	Icon	Description
Speakers		Left and right speakers deliver stereo audio output.
Status indicators		Inform you when a drive is in use or when a button has been pressed that affects how the keyboard is used.
Keyboard		Provides all the features of a full-sized, computer keyboard.
Power indicator		<ul style="list-style-type: none"> LED on - Notebook is on. LED blinking - Notebook is in Sleep or Hybrid Sleep mode. LED off - Notebook is off.
Battery charge indicator		<ul style="list-style-type: none"> LED orange - Battery is fully charged. LED blinking orange - Battery is charging. LED blinking red - Battery charge is very low. LED solid red - Battery is malfunctioning. <p>Important: This LED only lights up when your notebook is connected to AC power or the battery charge is very low.</p>
Touchpad		Provides all the functionality of a mouse.
Capacitive touch keys		Press to access capacitive touch key function.

LCD Panel



Component	Icon	Description
Webcam		Use to let others see who they are communicating with when making VoIP calls.
Microphone		Use to talk through when making Voice over Internet Protocol (VoIP) calls.

Status Indicators

Status indicators inform you when a drive is being used or when a button has been pressed that affects how the keyboard is used. The status indicators are located below the screen.

Indicator	Icon	Description
Bluetooth		<ul style="list-style-type: none">• LED on - Bluetooth communication is turned on• LED off - Bluetooth communication is turned off
Hard drive or disk drive		<ul style="list-style-type: none">• LED blinking - The drive is being accessed• LED off - The drive is not being accessed
Num lock		<ul style="list-style-type: none">• LED on - Num lock is turned on• LED off - Num lock is turned off
Caps lock		<ul style="list-style-type: none">• LED on - Caps lock is turned on• LED off - Caps lock is turned off
Battery charge indicator		<ul style="list-style-type: none">• LED blue - Battery is fully charged• LED red - Battery is charging <p>Important: This LED only lights up when your notebook is connected to AC power.</p>
Power indicator		<ul style="list-style-type: none">• LED on - Notebook is on.• LED blinking - Notebook is in Sleep or Hybrid Sleep mode.• LED off - Notebook is off.

TouchPad Basics

The following items show you how to use the TouchPad:

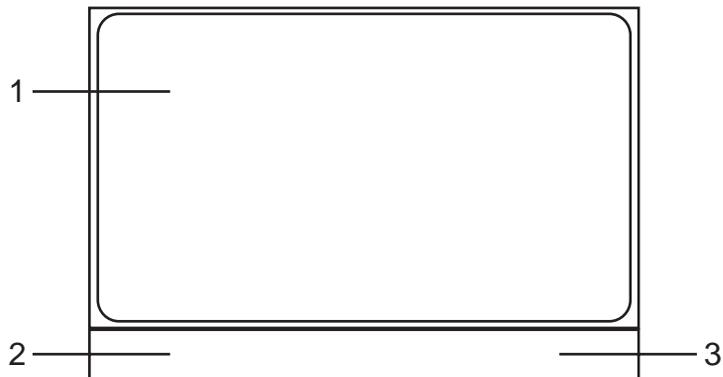

- Move your finger across the TouchPad (1) to move the cursor.
- Press the left (2) and right (3) buttons located beneath the TouchPad to perform selection and execution functions. These two buttons are similar to the left and right buttons on a mouse. Tapping on the TouchPad is the same as clicking the left button.

Function	Left Button (2)	Right Button (3)	Main TouchPad (1)
Execute	Quickly click twice.		Tap twice (at the same speed as double-clicking a mouse button).
Select	Click once.		Tap once.
Drag	Click and hold, then use finger on the TouchPad to drag the cursor.		Tap twice (at the same speed as double-clicking a mouse button); rest your finger on the TouchPad on the second tap and drag the cursor.
Access context menu		Click once.	

NOTE: When using the TouchPad, keep it - and your fingers - dry and clean. The TouchPad is sensitive to finger movement; hence, the lighter the touch, the better the response. Tapping too hard will not increase the TouchPad's responsiveness.

Using the Keyboard

Your notebook features a full-size keyboard that functions the same as a desktop computer keyboard. Many of the keys have been assigned alternate functions, including shortcut keys for Windows, function keys for specific system operations, and the Num Lock keys for the numeric keypad.



Key Types

The keyboard has several different types of keys. Some keys perform specific actions when pressed alone and other actions when pressed in combination with another key.

Icon	Key Type	Description
	Function keys	Press these keys labeled F1 to F12 to perform actions in programs. For example, pressing F1 may open help. Each program uses different function keys for different purposes. See the program documentation to find out more about the function key actions.
	System keys	Press these colored keys in combination with the Fn key to perform specific actions. See "System Keys" on page 15.
	Navigation keys	Press these keys to move the cursor to the beginning of a line, to the end of a line, up the page, down the page, to the beginning of a document, or to the end of a document.
	Fn key	Press the Fn key in combination with a colored system key to perform a specific action.
	Windows key	Press this key to open the Windows Start menu. This key can also be used in combination with other keys to open utilities. See "Windows Keys" on page 14.
	Application key	Press this key for quick access to shortcut menus and help assistants in Windows.
	Arrow keys	Press these keys to move the cursor up, down, right, or left.

Windows Keys

The keyboard has two keys that perform Windows-specific functions.

Key	Description
 Windows key	<p>Pressed alone, this key has the same effect as clicking on the Windows Start button; it launches the Start menu. It can also be used with other keys to provide a variety of functions:</p> <ul style="list-style-type: none"><>: Open or close the Start menu<> + <D>: Display the desktop<> + <E>: Open Windows Explore<> + <F>: Search for a file or folder<> + <G>: Cycle through Sidebar gadgets<> + <L>: Lock your computer (if you are connected to a network domain), or switch users (if you're not connected to a network domain)<> + <M>: Minimizes all windows<> + <R>: Open the Run dialog box<> + <T>: Cycle through programs on the taskbar<> + <U>: Open Ease of Access Center<> + <X>: Open Windows Mobility Center<> + <BREAK>: Display the System Properties dialog box<> + <SHIFT+M>: Restore minimized windows to the desktop<> + <TAB>: Cycle through programs on the taskbar by using Windows Flip 3-D<> + <SPACEBAR>: Bring all gadgets to the front and select Windows Sidebar<CTRL> + <> + <F>: Search for computers (if you are on a network)<CTRL> + <> + <TAB>: Use the arrow keys to cycle through programs on the taskbar by using Windows Flip 3-D <p>Note: Depending on your edition of Windows Vista, some shortcuts may not function as described.</p>

System Keys

The computer employs hotkeys or key combinations to access most of the computer's controls like screen brightness, Bluetooth and WiFi.

To activate hot keys, press and hold the <Fn> key before pressing the other key in the hotkey combination.

Function Key	Description
	Turn the capacitive touch key LEDs on or off.
	Enter Sleep mode or Hybrid Sleep mode. Press the power button to leave Sleep mode.
	Toggle the notebook display in the following order: The LCD. An external monitor or projector (a monitor or projector must be plugged into the monitor port or HDMI port on your notebook). Both displays at the same time.
	Turn the optional Bluetooth radio on or off. Warning: Radio frequency wireless communication can interfere with equipment on commercial aircraft. Current aviation regulations require wireless devices to be turned off while traveling in an airplane. Bluetooth communication devices are examples of devices that provide wireless communication. Important: The wireless network switch must be in the ON position for this button to work.
	Mute the sound. Press the key combination again to restore the sound.
	Turns the display screen backlight off to save power. Press any key to return.
	Play/ Pause—Plays or pauses the CD or DVD.
	Stop—Stops playing the CD or DVD.
	Previous—Skips back one CD track or DVD chapter.
	Next—Skips ahead one CD track or DVD chapter.

Using the System Utilities

Acer GridVista (dual-display compatible)

NOTE: This feature is only available on certain models.

To enable the dual monitor feature of the notebook, first ensure that the second monitor is connected, then select **Start, Control Panel, Display** and click on **Settings**. Select the secondary monitor (**2**) icon in the display box and then click the check box **Extend my windows desktop onto this monitor**. Finally, click **Apply** to confirm the new settings and click **OK** to complete the process.



Acer GridVista is a handy utility that offers four pre-defined display settings so you can view multiple windows on the same screen. To access this function, please go to **Start → All Programs** and click on **Acer GridVista**. You may choose any one of the four display settings indicated below:



Double (vertical), Triple (primary at left), Triple (primary at right), or Quad Acer GridVista is dual-display compatible, allowing two displays to be partitioned independently.

Acer GridVista is dual-display compatible, allowing two displays to be partitioned independently.

AcerGridVista is simple to set up:

1. Run Acer GridVista and select your preferred screen configuration for each display from the task bar.
2. Drag and drop each window into the appropriate grid.
3. Enjoy the convenience of a well-organized desktop.

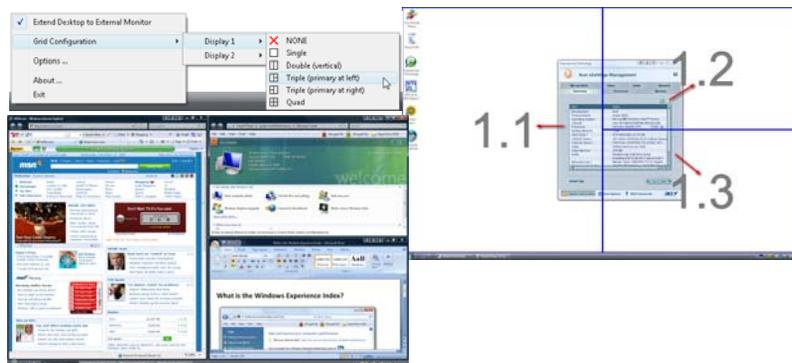

NOTE: Please ensure that the resolution setting of the second monitor is set to the manufacturer's recommended value.

Hardware Specifications and Configurations

Processor

Item	Specification
CPU	Mobile AMD Family 11h Processor
Core Logic	·AMD RS780MN ·AMD SB700
CPU Package	S1g2 package CPU
Power	35 / 25 W

Processor Specifications

Item	CPU Speed	Cores	Mfg. Tech	cache Size	Package	Power	Acer P/N
Athlon64X2 QL60	1.9G	2	65nm	1M	PGA 638	35W	KC.AQL02.600
Athlon64X2 QL62	2.0G	2	65nm	1M	PGA 638	35W	KC.AQL02.620
Athlon64X2 QL64	2.1G	2	65nm		PGA 638	35W	KC.AQL02.640
Athlon QL65	2.1G	1	65nm	1M	PGA 638	35W	KC.AOL02.650
Turion RM72	2.1G	2	65nm	1M	PGA 638	35W	KC.TRM02.720
Turion RM74	2.2G	2	65nm	1M	PGA 638	35W	KC.TRM02.740
Turion RM75	2.2G	1	65nm	1M	PGA 638	35W	KC.TRM02.750
TurionX2 ZM82	2.2G	2	65nm	2M	PGA 638	35W	KC.TZM02.820
TurionX2 ZM84	2.3G	2	65nm	2M	PGA 638	35W	KC.TZM02.840
Turion Ultra ZM85	2.3G	1	65nm	2M	PGA 638	35W	KC.TZM02.850
TurionX2 ZM86	2.4G	2	65nm	2M	PGA 638	35W	KC.TZM02.860
Turion Ultra ZM87	2.4G	1	65nm	2M	PGA 638	35W	KC.TZM02.870
SempronM SI40	2.0G	1	65nm	512K	PGA 638	25W	KC.SSI02.400
SempronM SI42	2.1G	1	65nm	512K	PGA 638	25W	KC.SSI02.420

CPU Fan True Value Table

Fan On Temp (°C)	Fan Speed (rpm)	SPL Spec (dBA)
38	2700	31
42	2900	34
65	3200	37
75	3500	40

- Throttling 50%: On=100°C, Off=95°C
- OS Shutdown: 105°C
- H/W Shutdown: 86°C

BIOS

Item	Specification
BIOS vendor	Phoenix
BIOS Version	4.0

System Memory

Item	Specification
Memory controller	AMD RS780MN AMD SB700
Memory size	0MB (onboard)

Item	Specification
DIMM socket number	2
Supports memory size per socket	2048MB
Supports maximum memory size	4096MB
Supports DIMM type	200-pin DDRII SO-DIMM
Supports DIMM Speed	667/800 mHz
Supports DIMM voltage	+1.8V

Memory Combinations

Slot 1	Slot 2	Total Memory
0MB	512MB	512MB
0MB	1024MB	1024MB
0MB	2048MB	2048MB
512MB	512MB	1024MB
512MB	1024MB	1536MB
512MB	2048MB	2560MB
1024MB	0MB	1024MB
1024MB	512MB	1536MB
1024MB	1024MB	2048MB
1024MB	2048MB	3072MB
2048MB	0MB	2048MB
2048MB	512MB	2560MB
2048MB	1024MB	3072MB
2048MB	2048MB	4096MB

NOTE: Above table lists some system memory configurations. You may combine DIMMs with various capacities to form other combinations. On above table, the configuration of slot 1 and slot 2 could be reversed.

Graphics Controller

Item	Specification	
VGA Chip	ATI Mobility Radeon™ HD 4570	Intel® GL40/GM45 Express Chipset with integrated 3D graphics
Graphics Memory	2304 MB of HyperMemory™ (512 MB of dedicated DDR2 VRAM, up to 1792 MB of shared system memory)	Up to 1759 MB of Intel® Dynamic Video Memory Technology 5.0 (128 MB of dedicated video memory, up to 1631 MB of shared system memory)
Supports	<ul style="list-style-type: none"> Unified Video Decoder (UVD) OpenEXR High Dynamic-Range (HDR) technology Shader Model 4.1 Microsoft® DirectX® 10.1Mobile Dual independent display support 	<ul style="list-style-type: none"> Intel® Graphics Media Accelerator 4500M/4500MHD (Intel® GMA 4500M/4500MHD) Microsoft® DirectX® 10 Dual independent display support

Item	Specification
Resolution	External resolution/refresh rate:- 2048 x 1536: 75/60 Hz 1920 x 1440: 85/75/60 Hz 1920 x 1200: 75/60 Hz 1920 x 1080: 100/85/75/60 Hz 1680 x 945: 100/85/75/60 Hz 1600 x 1200: 120/100/85/75/60 Hz 1600 x 900: 120/100/85/75/60 Hz 1400 x 1050: 85/75/60 Hz 1366 x 768: 85/75/60 Hz 1280 x 1024: 120/100/85/75/60 Hz 1280 x 960: 85/75/60 Hz 1280 x 768: 85/75/60 Hz 1280 x 720: 100/85/75/60 Hz 1024 x 768: 120/100/85/75/60 Hz 800 x 600: 120/100/85/72/60 Hz
Supports	<ul style="list-style-type: none"> • 16.7 million colors • MPEG-2/DVD decoding • WMV9 (VC-1) and H.264 (AVC) decoding • HDMI™ (High-Definition Multimedia Interface) with HDCP (High-bandwidth Digital Content Protection) support

Item	Specification		
VGA Chip	ATI Mobility Radeon™ HD 4570	NVIDIA® GeForce® GT 130M	Mobile Intel® GM457 Express Chipset with integrated 3D graphics
Graphics Memory	2304 MB of HyperMemory™ (512 MB of dedicated DDR2 VRAM, up to 1792 MB of shared system memory)	Up to 2815 MB of TurboCache™ (1024 MB of dedicated DDR2 VRAM, up to 1791 MB of shared system memory)	Up to 1759 MB of Intel® Dynamic Video Memory Technology 5.0 (128 MB of dedicated video memory, up to 1631 MB of shared system memory)
Supports	<ul style="list-style-type: none"> • Unified Video Decoder (UVD) • OpenEXR High Dynamic-Range (HDR) technology • Shader Model 4.1 • Microsoft® DirectX® 10.1Mobile • Dual independent display support 	<ul style="list-style-type: none"> • NVIDIA® CUDA™ • PureVideo® HD technology • OpenEXR High Dynamic-Range (HDR) technology • Shader Model 4.0 • Microsoft® DirectX® 10 	<ul style="list-style-type: none"> • Intel® Graphics Media Accelerator 4500MHD (Intel® GMA 4500MHD) • Microsoft® DirectX® 10

Item	Specification
Resolution	External resolution/refresh rate:- 2048 x 1536: 75/60 Hz 1920 x 1440: 85/75/60 Hz 1920 x 1200: 75/60 Hz 1920 x 1080: 100/85/75/60 Hz 1680 x 945: 100/85/75/60 Hz 1600 x 1200: 120/100/85/75/60 Hz 1600 x 900: 120/100/85/75/60 Hz 1400 x 1050: 85/75/60 Hz 1366 x 768: 85/75/60 Hz 1280 x 1024: 120/100/85/75/60 Hz 1280 x 960: 85/75/60 Hz 1280 x 768: 85/75/60 Hz 1280 x 720: 100/85/75/60 Hz 1024 x 768: 120/100/85/75/60 Hz 800 x 600: 120/100/85/72/60 Hz
Supports	<ul style="list-style-type: none"> • 16.7 million colors • MPEG-2/DVD decoding • WMV9 (VC-1) and H.264 (AVC) decoding • HDMI™ (High-Definition Multimedia Interface) with HDCP (High-bandwidth Digital Content Protection) support

LAN Interface

Item	Specification
LAN Chipset	Broadcom BCM5784 for 10/100/1000LAN
LAN connector type	RJ45
LAN connector location	Left side
Features	Support for 10/100/1000

Wireless Module 802.11b/g

Item	Specification
Manufacturer	
Model	
Modem Device	•
Interface	

Bluetooth

Item	Specification
Model	
Operating Frequency	
Channel Numbers	
Transmitter Output Power	
Coverage	
Receiver Sensitivity	
Maximum Receiver Signal	
Operating Voltage	
Interface	

Hard Disk Drive Interface

Item	Specification		
Vendor	Seagate		
Model Name	ST9160310AS	ST9320320AS	ST9500325AS
Capacity (MB)	160	320	500
Bytes per sector	512		
Data heads	2	4	4
Drive Format			
Disks	1	2	2
Spindle speed (RPM)	5,400		
Performance Specifications			
Buffer size	8 MB		
Interface	SATA		
Internal transfer rate (Mbits/sec max)	830		1175
I/O data transfer rate (Mbytes/sec max)	300		
DC Power Requirements			
Voltage tolerance	5V(DC) +/- 5%		

Item	Specifications	
Vendor & Model Name	Toshiba MK5055/2555GSX	Toshiba MK3255/1655GSX
Capacity	500/250GB	320/160GB
Bytes per sector	512	
Data heads	4/2	4/2
Drive Format		
Disks	2/1	2/1
Spindle speed (RPM)	5400	
Performance Specifications		
Buffer size	8MB	
Interface	SATA	
Internal transfer rate (Mbits/sec, max)	363 ~ 952 typical	
I/O data transfer rate	3Gbits/s	
DC Power Requirements		
Voltage	+5.0V ± 5%.	

Hard Disk Drive Interface (cont)

Item	Specifications			
Vendor & Model Name	HTS545050 B9A300	HTS545032 B9A300	HTS545025 B9A300	HTS543216 L9A300
Capacity (MB)	500	320	250	160
Bytes per sector	512			
Data heads	4	3	2	2
Drive Format				
Disks	2	2	1	1
Spindle speed (RPM)	5400			
Performance Specifications				
Buffer size	8MB			
Interface	SATA			
Internal transfer rate	875 MB/s			845 MB/s
I/O data transfer rate	3 GB/s			
DC Power Requirements				
Voltage	+5.0V ± 5%			

Item	Specifications			
Vendor & Model Name	WD WD1600BEVT	WD WD2500BEVT	WD WD3200BEVT	WD WD5000BEVT
Capacity (MB)	160	250	320	500
Bytes per sector	512			
Data heads	2	2	3	4
Drive Format				
Disks	1	1	2	2
Spindle speed (RPM)	5400			
Performance Specifications				
Buffer size	8 MB			
Interface	SATA			
Internal transfer rate (Mbits/sec, max)	106 MB max.			
I/O data transfer rate	3 GB/s			
DC Power Requirements				
Voltage	+5.0V ± 5%			

Super-Multi Drive Module

Item	Specification	
Vendor & model name	HLDS/GSA-T50, Toshiba Digi/TS-L633A	
Performance Specification	With CD Diskette	With DVD Diskette
Transfer rate (MB/sec)	Sustained: Max 3.5 Mbytes/sec	Sustained: Max 10 Mbytes/sec
Buffer Memory	2MB	
Interface	SATA	
Applicable disc format	Applicable media types: Writing: Confirms to DVD+R Version 1.2 and DVD+RW Version 1.3 / DVD+R DL Version 1.0 / DVD-R Version 2.0 / DVD-RW Version 1.2 / DVD-R DL Version 3.0. Reading: DVD single/dual layer (PTP, OTP), DVD-R single/dual layer DVD+R single/double layer DVD-RW DVD+RW CD-DA CD-ROM CD-ROM/XA Photo-CD, Multi-session, Video CD CD-I FMV, CD Extra, CD Plus, CD-R, and CD-RW	
Loading mechanism	Drawer (Solenoid Open) Tact SW (Open) Emergency Release (draw open hole)	
Power Requirement		
Input Voltage	DC 5 V +/- 5%	

Item	Specification	
Vendor & model name	SONY AD-7583S	
Performance Specification	With CD Diskette	With DVD Diskette
Transfer rate (MB/sec)	Sustained: 3650 (max.)	Sustained: 10,993 (max.)
Buffer Memory	2 MB	
Interface	SATA	
Applicable disc format	Write: DVD Data & Video CD-DA, CD-ROM Mode-1, CD-ROM/XA Mode-2 Form-1 and Mode-2 Form-2, CD-i, Video-CD, CD-Text Read: DVD-ROM (DVD-5, DVD-9, DVD-10, DVD-18), DVD-Video, DVD-Audio, SACD (Hybrid), UDF DVD, DVD-R, DVD-R DL, DVD-R 3.95 GB, DVD-R Authoring, DVD-R Multi-Border, DVD-RW, DVD+R, DVD+R DL, DVD+R Multi-Session, DVD+RW, DVD-RAM V1.0, DVDRAM V2.0 & 2.1 & 2.2 CD-DA, CD-ROM Mode-1, CD-ROM/XA Mode-2 Form-1 and Mode-2 Form-2, CD-i, CD-i Bridge, Video-CD (MPEG-1), Karaoke CD, Photo-CD, Enhanced CD, CD Plus, CD Extra, itrax CD, CD-Text, UDF CD, CD-R, and CD-RW	

Item	Specification
Loading mechanism	Drawer (Solenoid Open) Tact SW (Open) Emergency Release (draw open hole)
Power Requirement	
Input Voltage	DC 5 V +/- 5%

Blue-Ray Combo Drive Module

Item	Specification
Vendor & model name	Sony BC-5500S
Performance Specification	With CD Diskette With DVD Diskette
Transfer rate (MB/sec)	Sustained: Max 2.4 Mbytes/sec Sustained: Max 11 Mbytes/sec
Buffer Memory	4.5 MB
Interface	SATA
Applicable disc format	Applicable media types: BD-ROM (Single and Dual Layer) BD-R (Single and Dual Layer) BD-RE (Single and Dual Layer) DVD-ROM (Single and Dual Layer) DVD+R (Single and Double Layer) DVD-R (Single and Dual Layer) DVD+RW (Single Layer) and DVD-RW (Single Layer) discs DVD-RAM (Ver.2) CD-ROM CD-R CD-RW
Loading mechanism	Drawer (Solenoid Open), Tact SW (Open), Emergency Release (draw open hole)
Power Requirement	
Input Voltage	DC 5 V +/- 5%

Item	Specification
Vendor & model name	PLDS BD Combo DS-4E1S
Performance Specification	With CD Diskette With DVD Diskette Bluera y
Transfer rate (KB/sec)	Sustained: 3,500 (min.) Sustained: 10,000 (min.) Sustained: 18,000 (min.)
Buffer Memory	2 MB
Interface	SATA
Applicable disc format	CD-DA, CD-TEXT, CD ROM Mode-1, CD-ROM/XA Mode-2 Form-1 and Form-2, CD-I Ready, Video-CD (MPEG-1), Photo-CD, Enhance CD, CD extra, I-Trax CD and UDF DVD-ROM, DVD-Video, DVD-Audio, DVD-R single/multi border(s) DVD+R single/multi session(s) DVD-RW DVD+RW DVD-RAM BD-ROM ver2.0, UDF2.5 BD-R ver1.0 and ver2.0, UDF2.5 BD-RE ver2.0 and ver3.0, UDF2.5 BD-hybrid (only BD part)
Loading mechanism	Drawer (Solenoid Open), Tact SW (Open), Emergency Release (draw open hole)
Power Requirement	
Input Voltage	DC 5 V +/- 5%

Audio Interface

Item	Specification
Audio Controller	Realtek ALC272 Azalia Codec and Amplifier G1454
<ul style="list-style-type: none"> Features 	<ul style="list-style-type: none"> HD Audio SNR > 85, High-performance DACs with 95dB SNR (A-Weighting), ADCs with 85dB SNR (A-Weighting) Internal Digital Microphone Two speakers, max. 1W output for each Meets performance and function requirements for Microsoft WLP 3.10, and stricter performance requirements for future WLP Two stereo DAC support 16/20/24-bit PCM for two independent playback (multiple streaming) Two stereo ADC supports 16/20/24-bit PCM format for two independent recording All DACs support independent 44.1k/48k/96k/192kHz sample rate All ADCs support independent 44.1k/48k/96k/192kHz sample rate Two independent SPDIF outputs support 16/20/24-bit format and 44.1k/48k/88.2k/96k/192kHz rate All analog jack ports except MONO, BEEP-IN and HP-OUT are stereo input and output re-tasking Supports line level mono output Supports analog PCBEEP input, and features an integrated digital BEEP generator Support two stereo digital microphone input for microphone array AEC/BF application Each stereo digital microphone interface has its own clock output to support independent sample rate Supports legacy analog mixer architecture Built-in five headphone amplifiers on port-A and port-D, port-E, port-F and port-I. Headphone amplifier on port-I (HP-OUT) is designed to drive output without external DC blocking capacitors Software selectable 2.5V and 3.2V reference output for microphone bias Software selectable boost gain (+10/+20/+30dB) for analog microphone input Two jack detection pins; each supports detection of up to 4 jacks Supports two GPIO (General Purpose Input/Output) pins (pin sharing with digital microphone interface) Supports EAPD (External Amplifier Power Down) control for external amplifier Supports anti-pop mode when analog power AVDD is on and digital power is off Supports 1.5V~3.3V scalable I/O for HD Audio link 48-pin LQFP 'Green' package

Power and Keyboard Controller

Item	Specification
Controller	KB926
Total number of keypads	86/87/91
Windows logo key	Yes

Item	Specification
Internal & external keyboard work simultaneously	Yes
Features	<ul style="list-style-type: none"> Support Application keys for Windows XP version

Battery

Item	Specification	
	6 Cell	8 Cell
Vendor & model name	SONY AS-2007B/SIMPLO AS-2007B/SANYO AS-2007B/PANASONIC AS-2007B	SONY AS-2007B/SIMPLO AS-2007B/SANYO AS-2007B/PANASONIC AS-2007B
Battery Type	Li-ion	Li-ion
Pack capacity	4400 mAh	4800 mAh
Normal Voltage	11.1V	14.8
Charge Voltage	12.6V	12.6V
Fast Charge Current	2.94~3.5A	3.1A
Package configuration	3S2P	4S2P

LCD

Item	Specification
Vendor/model name	CMO N173O6-L02 AUO B173RW01 Samsung LTN173KT01-A01 LPL LP173WD1-TLA1
Screen Diagonal (mm)	439.4
Display Area (mm)	382.08 x 214.92
Display resolution (pixels)	1600x900
Pixel Pitch	0.2388
Display Mode	Normal white
Typical White Luminance (cd/m ²) (also called Brightness)	220
Contrast Ratio	500:1
Response Time (Optical Rise Time/ Fall Time) msec	8
Typical Power Consumption (watt)	7
Weight (g)	580 Max.
Physical Size (mm)	398.1 x 232.8 x 5.5
Electrical Interface	LVDS
Support Color	262K
Viewing Angle (U/D/R/L)	20/45/45/45

System Utilities

BIOS Setup Utility

The BIOS Setup Utility is a hardware configuration program built into your computer's BIOS (Basic Input/Output System).

Your computer is already properly configured and optimized, and you do not need to run this utility. However, if you encounter configuration problems, you may need to run Setup. Please also refer to Chapter 4 Troubleshooting when problem arises.

To activate the BIOS Utility, press **F2** during POST (when "Press <F2> to enter Setup" message is prompted on the bottom of screen).

Press **F2** to enter setup. The default parameter of F12 Boot Menu is set to "disabled". If you want to change boot device without entering BIOS Setup Utility, please set the parameter to "enabled".

Press <F12> during POST to enter multi-boot menu. In this menu, user can change boot device without entering BIOS SETUP Utility.

Navigating the BIOS Utility

There are six menu options: Information, Main, Advanced, Security, Boot, and Exit.

Follow these instructions:

- To choose a menu, use the left and right arrow keys.
- To choose an item, use the up and down arrow keys.
- To change the value of a parameter, press **F5** or **F6**.
- A plus sign (+) indicates the item has sub-items. Press **Enter** to expand this item.
- Press **Esc** while you are in any of the menu options to go to the Exit menu.
- In any menu, you can load default settings by pressing **F9**. You can also press **F10** to save any changes made and exit the BIOS Setup Utility.

NOTE: You can change the value of a parameter if it is enclosed in square brackets. Navigation keys for a particular menu are shown on the bottom of the screen. Help for parameters are found in the Item Specific Help part of the screen. Read this carefully when making changes to parameter values. **Please note that system information is subject to different models.**

Information

The Information screen displays a summary of your computer hardware information.

PhoenixBIOS Setup Utility

Information
Main
Security
Boot
Exit

CPU Type	AMD Athlon(tm) 64 X2 Dual-Core Processor TK-42		
CPU Speed	1600 MHz		
HDD Model Name:	WDC WD2500BEVT-22ZCCT0	-(PM)	
HDD Serial Number:	WD-WXHZ08604954		
ATAPI Model Name:	Optiarc DVD RW AD-7580S	-(SM)	
System BIOS Version:	V0.11T04_C-Build		
VGA BIOS Version:	V010.055.000.050.030632		
Serial Number:			
Asset Tag Number:			
Product Name:	eMachines E625		
Manufacturer Name:	eMachines		
UUID:	39353164386665643635001EECE1D377		

F1 Help	↑↓ Select Item	F5/F6 Change Values	F9 Setup Defaults
Esc Exit	← Select Menu	Enter Select	▶ Sub-Menu
			F10 Save and Exit

NOTE: The screen above is for your reference only. Actual values may differ according to model.

The table below describes the parameters in this screen.

Parameter	Description
CPU Type	This field shows the CPU type and speed of the system.
CPU Speed	This field shows the speed of the CPU.
HDD Model Name	This field shows the model name of HDD installed on primary IDE master.
HDD Serial Number	This field displays the serial number of HDD installed on primary IDE master.
ATAPI Model Name	This field shows the model name of the Optical device installed in the system.
System BIOS Version	Displays system BIOS version.
VGA BIOS Version	This field displays the VGA firmware version of the system.
Serial Number	This field displays the serial number of this unit.
Asset Tag Number	This field displays the asset tag number of the system.
Product Name	This field shows product name of the system.
Manufacturer Name	This field displays the manufacturer of this system.
UUID	Universally Unique Identifier (UUID) is an identifier standard used in software construction, standardized by the Open Software Foundation (OSF) as part of the Distributed Computing Environment (DCE).

Main

The Main screen allows the user to set the system time and date as well as enable and disable boot option and recovery.

PhoenixBIOS Setup Utility		
Information	Main	Security Boot Exit
System Time:	[19:10:59]	Item Specific Help <Tab>, <Shift-Tab>, or <Enter> selects field.
System Date:	[12/12/2008]	
System Memory:	634 KB	
Extended Memory:	1790 MB	
Video Memory:	[256MB]	
Quiet Boot:	[Enabled]	
Network Boot:	[Enabled]	
F12 Boot Menu:	[Disabled]	
D2D Recovery:	[Enabled]	
SATA Mode:	[IDE AHCI]	
F1 Help ↑↓ Select Item F5/F6 Change Values F9 Setup Defaults Esc Exit ← Select Menu Enter Select ► Sub-Menu F10 Save and Exit		

NOTE: The screen above is for your reference only. Actual values may differ.

The table below describes the parameters in this screen.

Parameter	Description	Format/Option
System Time	Sets the system time. The hours are displayed with 24-hour format.	Format: HH:MM:SS (hour:minute:second)
System Date	Sets the system date.	Format MM/DD/YYYY (month/day/year)
System Memory	Displays the memory available on the CPU cache.	N/A
Extended Memory	Displays the memory available on the DRAM chips	
Video Memory	Displays the available memory for Video.	N/A
Quiet Boot	Allows startup to skip certain tests while booting, decreasing the time needed to boot the system.	Option: Enabled or Disabled
Network Boot	Enables, disables the system boot from LAN (remote server).	Option: Enabled or Disabled
F12 Boot Menu	Enables, disables Boot Menu during POST.	Option: Enabled or Enabled
D2D Recovery	Enables, disables D2D Recovery function. The function allows the user to create a hidden partition on hard disc drive to store operation system and restore the system to factory defaults.	Option: Enabled or Disabled
SATA Mode	Control the mode in which the SATA controller should operate.	Option: AHCI or IDE

Security

The Security screen contains parameters that help safeguard and protect your computer from unauthorized use.

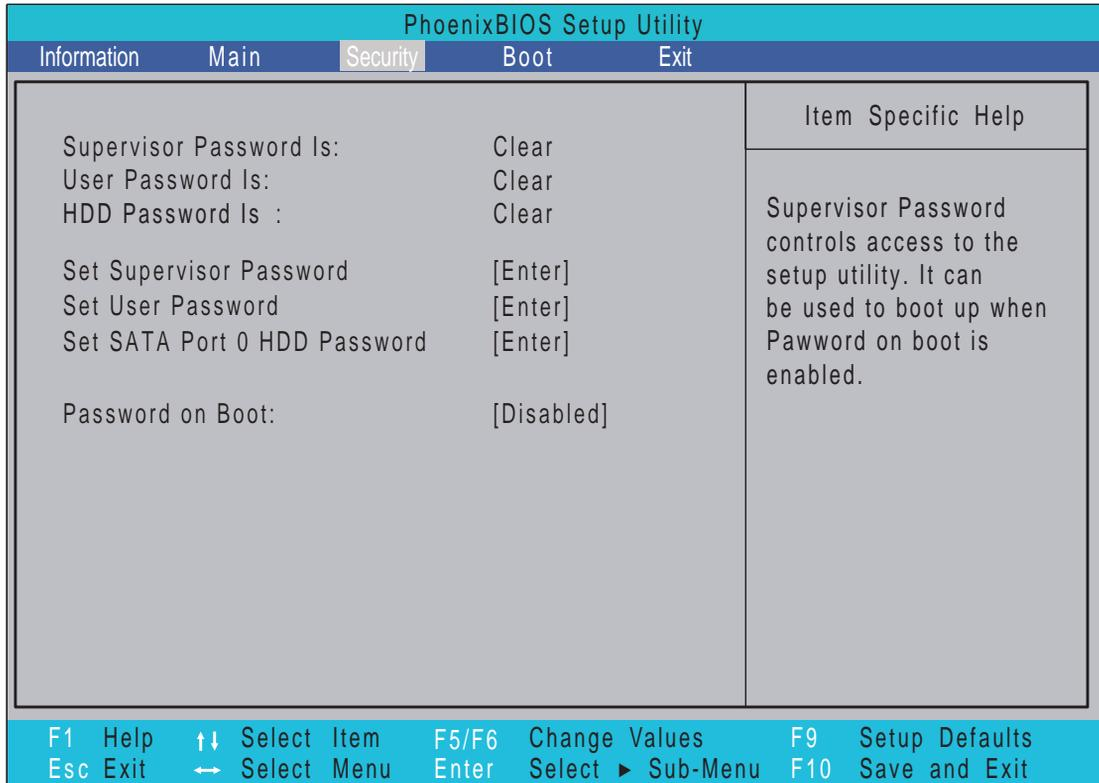

The table below describes the parameters in this screen. Settings in **boldface** are the default and suggested parameter settings.

Parameter	Description	Option
Supervisor Password Is	Shows the setting of the Supervisor password	Clear or Set
User Password Is	Shows the setting of the user password.	Clear or Set
HDD Password Is	Shows the setting of the hard disk password.	Clear or Set
Set Supervisor Password	Press Enter to set the supervisor password. When set, this password protects the BIOS Setup Utility from unauthorized access. The user can not either enter the Setup menu nor change the value of parameters.	N/A
Set User Password	Press Enter to set the user password. When user password is set, this password protects the BIOS Setup Utility from unauthorized access. The user can enter Setup menu only and does not have right to change the value of parameters.	N/A
Set SATA Port0 HDD Password	Enter HDD Password.	N/A
Password on Boot	Defines whether a password is required or not while the events defined in this group happened. The following sub-options are all requires the Supervisor password for changes and should be grayed out if the user password was used to enter setup.	Disabled or Enabled

NOTE: When entering a password, you have three tries before the system halts. Don't forget your password. If you forget your password, you may have to return your notebook computer to your dealer to reset it.

Setting a Password

Follow these steps as you set the user or the supervisor password:

1. Use the ↑ and ↓ keys to highlight the Set Supervisor Password parameter and press the **Enter** key. The Set Supervisor Password box appears:



Set Supervisor Password	
Enter New Password	[REDACTED]
Confirm New Password	[REDACTED]

2. Type a password in the “Enter New Password” field. The password length can not exceed 8 alphanumeric characters (A-Z, a-z, 0-9, not case sensitive). Retype the password in the “Confirm New Password” field.

IMPORTANT: Be very careful when typing your password because the characters do not appear on the screen.

3. Press **Enter**. After setting the password, the computer sets the User Password parameter to “Set”.
4. If desired, you can opt to enable the Password on boot parameter.
5. When you are done, press F10 to save the changes and exit the BIOS Setup Utility.

Removing a Password

Follow these steps:

1. Use the ↑ and ↓ keys to highlight the Set Supervisor Password parameter and press the **Enter** key. The Set Password box appears:



Set Supervisor Password	
Enter Current Password	[REDACTED]
Enter New Password	[REDACTED]
Confirm New Password	[REDACTED]

2. Type the current password in the Enter Current Password field and press **Enter**.
3. Press **Enter** twice **without** typing anything in the Enter New Password and Confirm New Password fields. The computer then sets the Supervisor Password parameter to “Clear”.
4. When you have changed the settings, press u to save the changes and exit the BIOS Setup Utility.

Changing a Password

1. Use the ↑ and ↓ keys to highlight the Set Supervisor Password parameter and press the **Enter** key. The Set Password box appears.



The screenshot shows a blue-themed BIOS screen titled "Set Supervisor Password". It contains three input fields: "Enter Current Password" with a blacked-out field, "Enter New Password" with an empty field, and "Confirm New Password" with an empty field. Each field is followed by a pair of square brackets [] indicating the input area.

2. Type the current password in the Enter Current Password field and press **Enter**.
3. Type a password in the Enter New Password field. Retype the password in the Confirm New Password field.
4. Press **Enter**. After setting the password, the computer sets the User Password parameter to "Set".
5. If desired, you can enable the Password on boot parameter.
6. When you are done, press F10 to save the changes and exit the BIOS Setup Utility.

If the verification is OK, the screen will display as following.

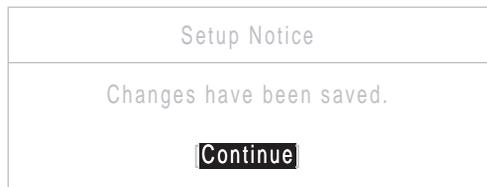

The screenshot shows a white-themed BIOS screen titled "Setup Notice". The text "Changes have been saved." is displayed in the center. Below the text is a black button with the word "Continue" in white.

The password setting is complete after the user presses **Enter**.

If the current password entered does not match the actual current password, the screen will show you the Setup Warning.



The screenshot shows a white-themed BIOS screen titled "Setup Warning" in red text. Below the title, the text "Invalid Password." is displayed in red. At the bottom, there is a black button with the word "Continue" in white.

If the new password and confirm new password strings do not match, the screen will display the following message.



The screenshot shows a white-themed BIOS screen titled "Setup Warning" in red text. Below the title, the text "Passwords do not match. Re-enter password." is displayed in red. At the bottom, there is a black button with the word "Continue" in white.

Boot

This menu allows the user to decide the order of boot devices to load the operating system. Bootable devices includes the USB diskette drives, the onboard hard disk drive and the DVD drive in the module bay.

Select Boot Devices to select specific devices to support boot.

PhoenixBIOS Setup Utility				
Information	Main	Security	Boot	Exit
Boot priority order: 1: IDE0: WDC WD2500BEVT-22ZCT0-(S1) 2: IDE1: Optiarc DVD RW AD-7580S-(S2) 3: USB FDD: 4: Network boot: MBA v11.0.14 Slot 0B00 5: USB HDD: 6: USB KEY: 7: USB CD/DVD ROM:			Item Specific Help	
F1 Help	↑↓ Select Item	F5/F6 Change Values	F9 Setup Defaults	
Esc Exit	← Select Menu	Enter Select ► Sub-Menu	F10 Save and Exit	

Exit

The Exit screen allows you to save or discard any changes you made and quit the BIOS Utility.

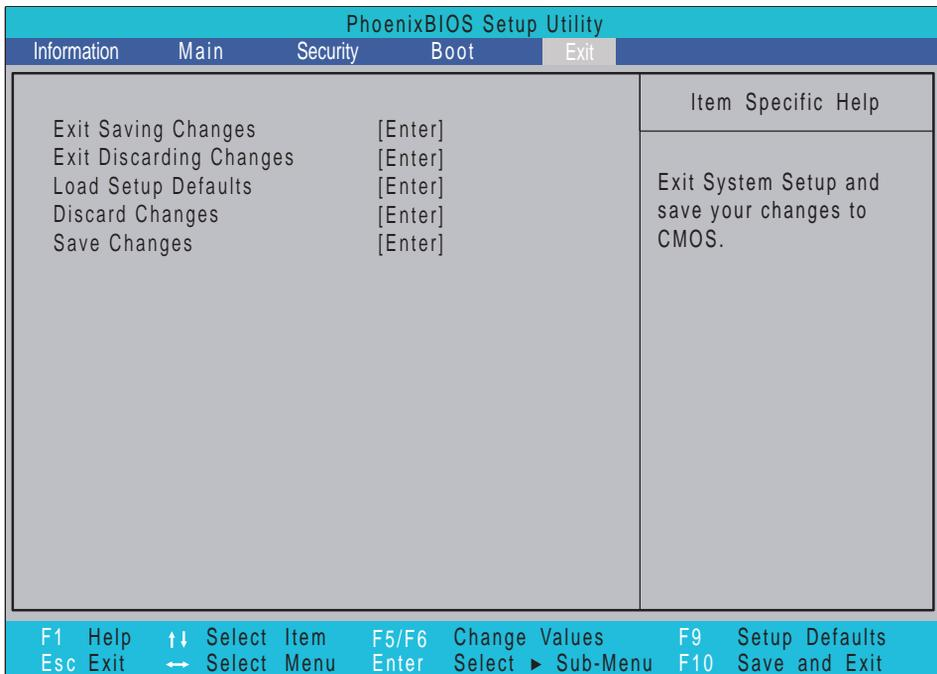

The table below describes the parameters in this screen.

Parameter	Description
Exit Saving Changes	Exit System Setup and save your changes to CMOS.
Exit Discarding Changes	Exit utility without saving setup data to CMOS.
Load Setup Default	Load default values for all SETUP item.
Discard Changes	Load previous values from CMOS for all SETUP items.
Save Changes	Save Setup Data to CMOS.

BIOS Flash Utilities

The BIOS flash memory update is required for the following conditions:

- New versions of system programs
- New features or options
- Restore a BIOS when it becomes corrupted.

Use the Phlash utility to update the system BIOS flash ROM.

NOTE: If you do not have a crisis recovery diskette at hand, then you should create a **Crisis Recovery Diskette** before you use the Phlash utility.

NOTE: Do not install memory-related drivers (XMS, EMS, DPMI) when you use the Phlash.

NOTE: Please use the AC adaptor power supply when you run the Phlash utility. If the battery pack does not contain enough power to finish BIOS flash, you may not boot the system because the BIOS is not completely loaded.

Follow the steps below to run the Phlash.

1. Prepare a bootable diskette.
2. Copy the flash utilities to the bootable diskette.
3. Then boot the system from the bootable diskette. The flash utility has auto-execution function.

DOS Flash Utility

Perform the following steps to use the DOS Flash Utility:

1. Press F2 during boot to enter the Setup Menu.
2. Select **Boot Menu** to modify the boot priority order, for example, if using USB HDD to Update BIOS, move USB HDD to position 1.

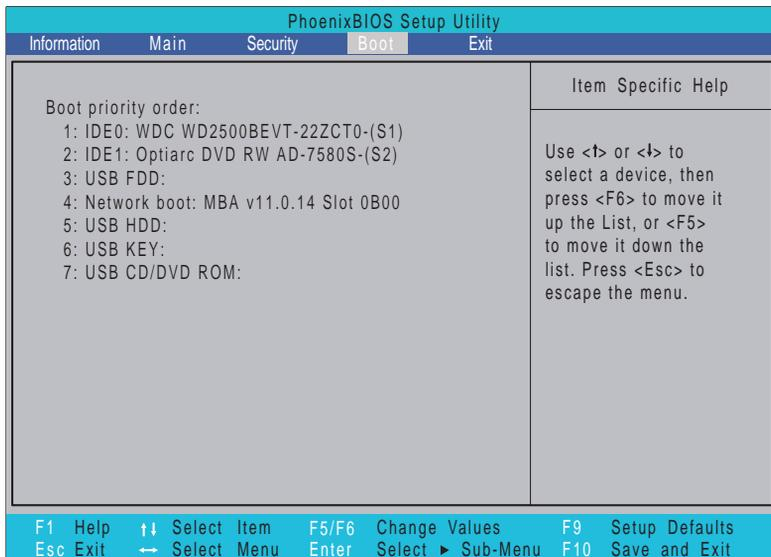

3. Execute the **FLASH.BAT** batch file to update BIOS.

The flash process begins as shown.

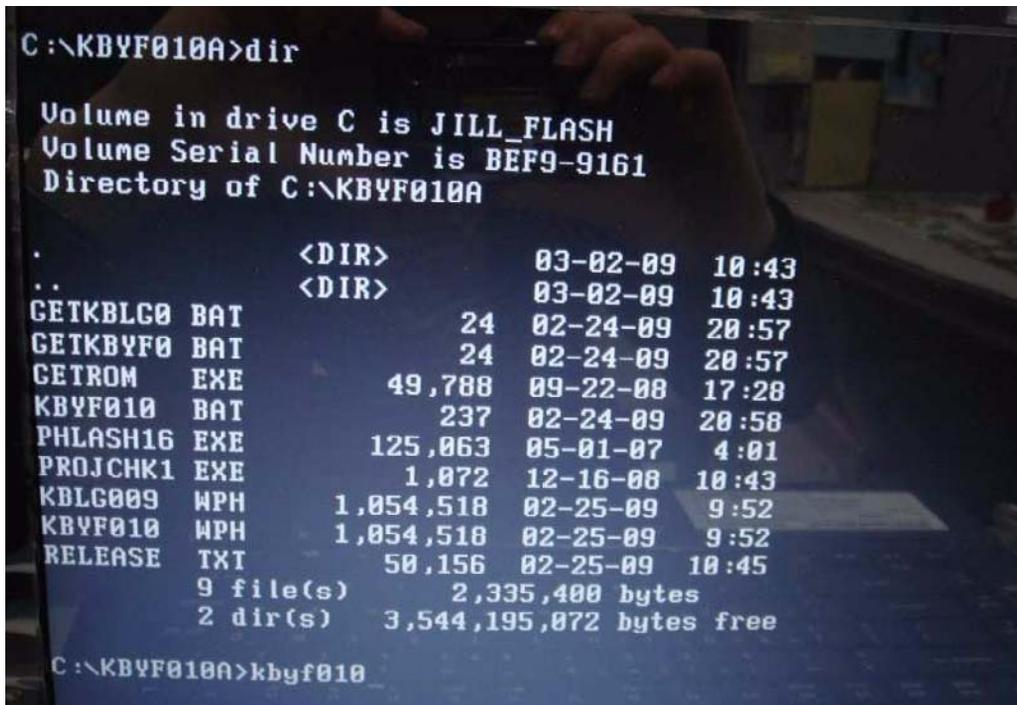

4. In flash BIOS, the message **Please do not remove AC Power Source** displays.

NOTE: If the AC power is not connected, the following message displays.

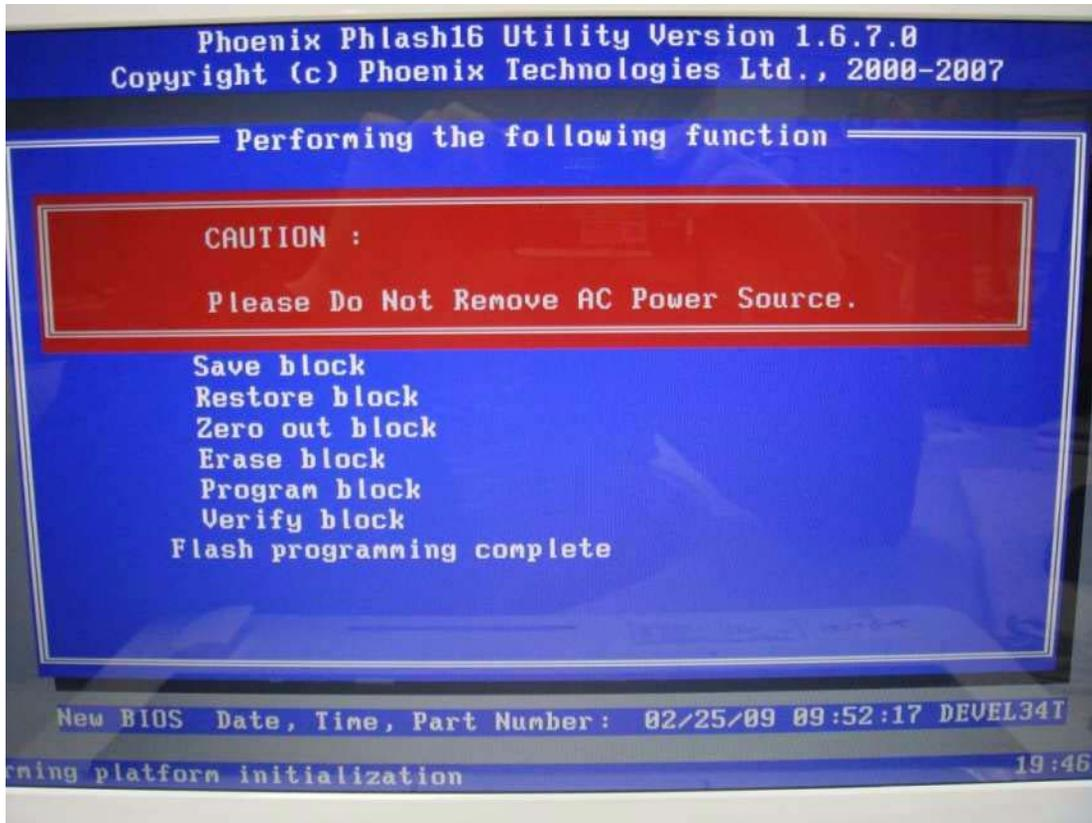

Plug in the AC power to continue.

5. Flash is complete when the message **Flash programming complete** displays.

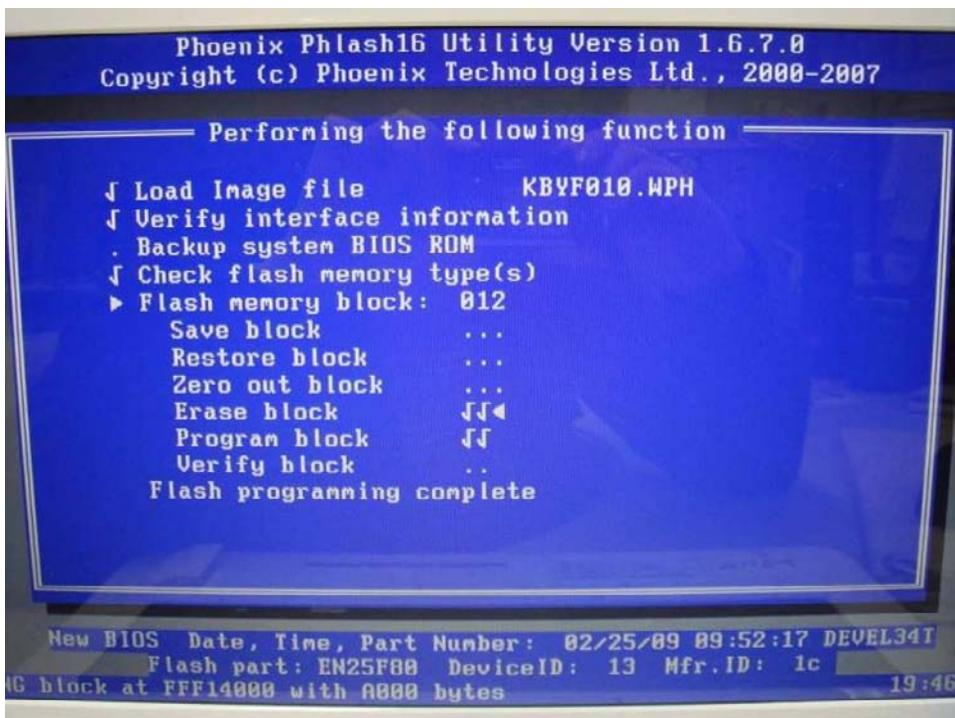

WinFlash Utility

Perform the following steps to use the WinFlash Utility:

1. Double-click the WinFlash executable. Click **Start**.

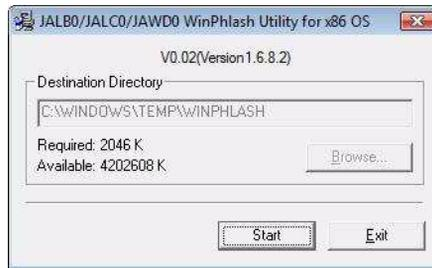

2. Make sure that AC power is plugged in and click **OK** to begin the update.

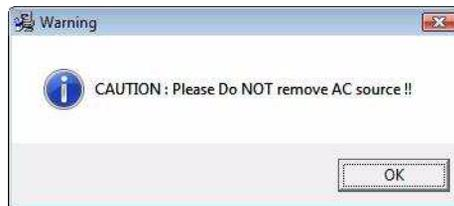

A progress screen displays.

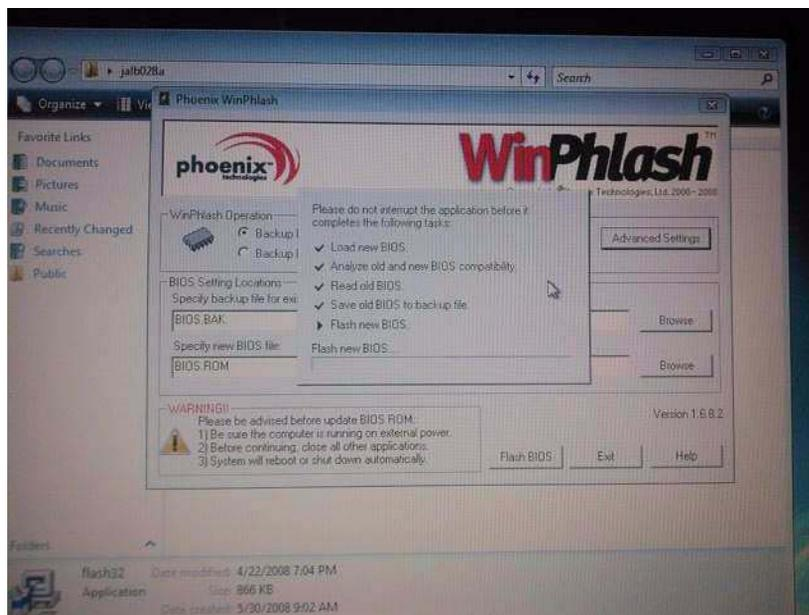

Remove HDD/BIOS Password Utilities

Remove HDD Password:

If you key in the wrong HDD password three times, an error is generated along with an error code. Note down this code.



To reset the HDD password, perform the following steps:

1. In DOS mode, use the code generated previously to execute the command **Unlock6.exe 09652 00** and then select option **2** to get the password. Note down the password, e.g.: **XXGL9XF**

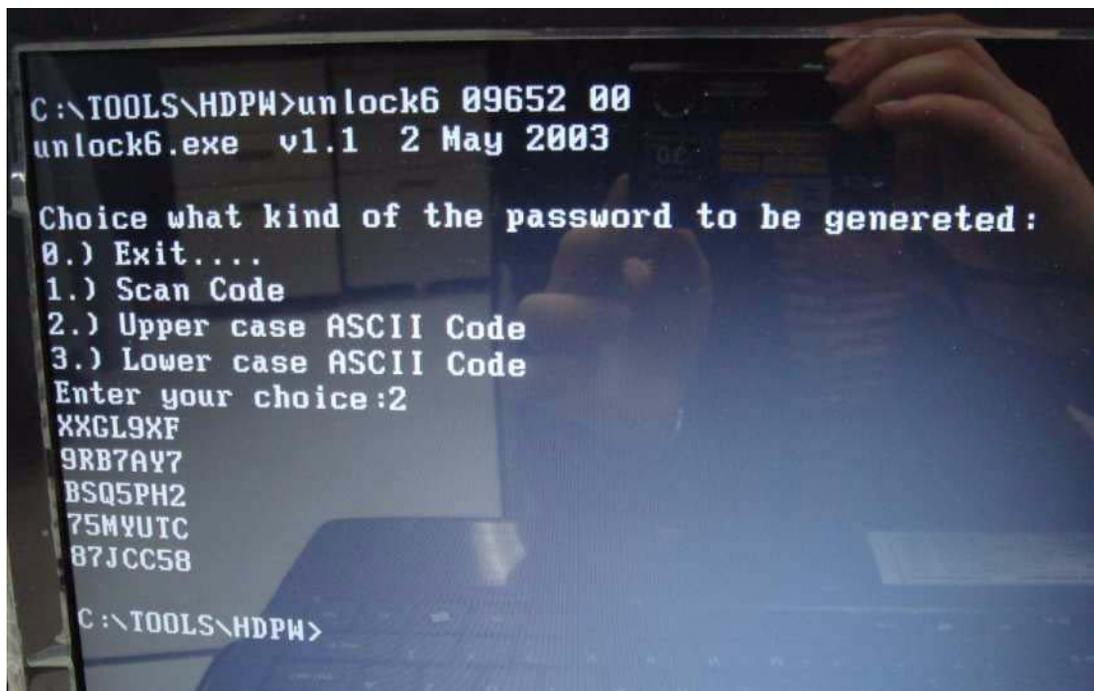

2. Shut down the computer by holding down the Power button for 4 seconds. Power on the computer and input the HDD password from previous steps to unlock the HDD.

Cleaning BIOS Passwords

To clean the User or Supervisor passwords, perform the following steps:

1. From a DOS prompt, execute **cInpwd.exe**
2. Press **1** or **2** to clean the desired password shown on the screen.

```
d:\CInpwd>cInpwd
ACER Clean Password Utility V1.00
Press 1 or 2 to clean any password shown as below
    1.User Password
    2.Supervisor Password

Clean User Password Successfully!
```

The onscreen message determines whether the function is successful or not.

Using Boot Sequence Selector

The Boot Sequence Selector allows the boot order to be changed without accessing the BIOS. To use Boot Sequence Selector, perform the following steps:

1. Enter into DOS.
2. Execute **BS.exe** to display the usage screen.

```
d:\BOOTSEQ>bs
*** Boot Sequence Selector Version 0.03 ***
Create by Rockwell Chuang 10/01/2005.

Usage:
    BS [ 1 | 2 | 3 | 4 ]

BS 1 : [ Floppy ] => [ HardDisk ] => [ CD-ROM ] => [ LAN ]
BS 2 : [ HardDisk ] => [ CD-ROM ] => [ LAN ] => [ Floppy ]
BS 3 : [ CD-ROM ] => [ HardDisk ] => [ LAN ] => [ Floppy ]
BS 4 : [ LAN ] => [ Floppy ] => [ HardDisk ] => [ CD-ROM ]

d:\BOOTSEQ>
```

3. Select the desired boot sequence by entering the corresponding sequence. For example, enter **BS2** to change the boot sequence to HDD | CD ROM | LAN | Floppy.

Using DMITools

The DMI (Desktop Management Interface) Tool copies BIOS information to EEPROM to be used in the DMI pool for hardware management.

When the BIOS displays **Verifying DMI pool data** it is checking that the table correlates with the hardware before sending to the operating system (Windows, etc.).

To update the DMI Pool, perform the following steps:

1. Boot into DOS.
2. Execute **dmitools**. The following messages report to screen to confirm completion:
 - `dmitools /r ==>` Read dmi string from bios
 - `dmitools /wm xxxx ==>` Write manufacturer name to eeprom (max. 16 characters)
 - `dmitools /wp xxxx ==>` Write product name to eeprom (max. 16 characters)
 - `dmitools /ws xxxx ==>` Write serial number to eeprom (max. 22 characters)
 - `dmitools /wu xxxx ==>` Write uuid to eeprom
 - `dmitools /wa xxxx ==>` Write asset tag to eeprom (max. 32 characters)

The following examples show the commands and the corresponding output information.

Read DMI Information from Memory

Input:

```
dmitools /r
```

Output:

```
Manufacturer (Type1, Offset04h): Acer
Product Name (Type1, Offset05h): TravelMate xxxxx
Serial Number (Type1, Offset07h): 01234567890123456789
UUID String (Type1, Offset08h): xxxxxxxx-xxxx-xxxx-xxxx-xxxxxxxxxxxxx
Asset Tag (Type3, Offset04h): Acet Asstag
```

Write Product Name to EEPROM

Input:

```
dmitools /wp Acer
```

Write Serial Number to EEPROM

Input:

```
dmitools /ws 01234567890123456789
```

4). Write UUID to EEPROM (Create UUID from Intel WFM20.pdf)

Input:

```
dmitools /wu
```

5). Write Asset Tag to EEPROM

Input:

```
dmitools /wa Acet Asstag
```

NOTE: When using any of the Write options, restart the system to make the new DMI data effective.

Using the LAN MAC EEPROM Utility

You can use the MAC.BAT utility to write the MAC.CFG file to the EEPROM under DOS mode.

1. Use a text editor (for example: Notepad) to open the MAC.CFG file. You can see the MAC.CFG contents as below:



```
MAC.CFG - 記事本
檔案(F) 編輯(E) 格式(O) 檢視(V) 說明(H)
Title= MAC Address byte
WriteData='001122334455'
StartAddr=7A
WriteLeng=6
KeepByte=0
```

WriteData = '001122334455'	MAC value
StartAddr=7A	MAC address
WriteLeng=6	MAC value length
KeepByte=0	don't care

2. In DOS mode, run the **MAC.BAT** file to write MAC values to eeprom.

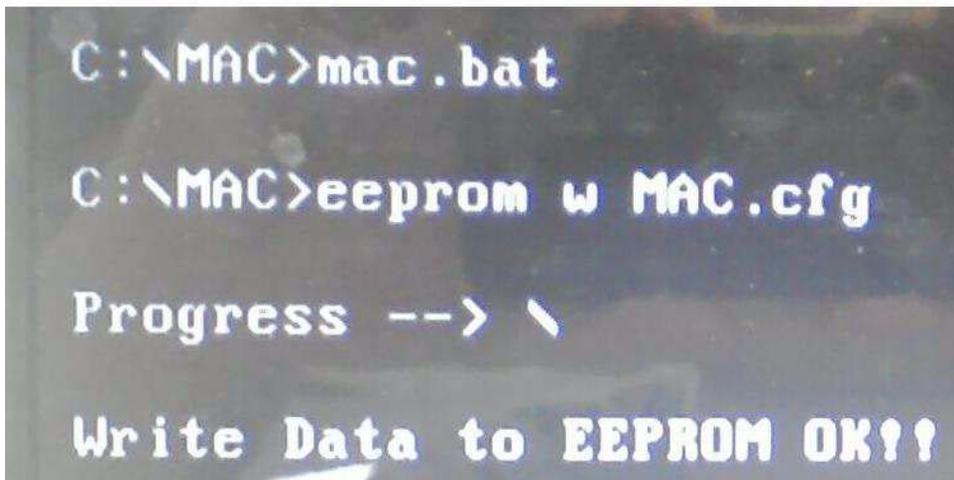

```
C:\MAC>mac.bat
C:\MAC>eeprom w MAC.cfg
Progress --> \
Write Data to EEPROM OK!!
```

Machine Disassembly and Replacement

IMPORTANT: The outside housing and color may vary from the mass produced model.

This chapter contains step-by-step procedures on how to disassemble the notebook computer for maintenance and troubleshooting.

Disassembly Requirements

To disassemble the computer, you need the following tools:

- Wrist grounding strap and conductive mat for preventing electrostatic discharge
- Flat screwdriver
- Philips screwdriver
- Plastic flat screwdriver
- Plastic tweezers

NOTE: The screws for the different components vary in size. During the disassembly process, group the screws with the corresponding components to avoid mismatch when putting back the components.

General Information

Pre-disassembly Instructions

Before proceeding with the disassembly procedure, make sure that you do the following:

1. Turn off the power to the system and all peripherals.
2. Unplug the AC adapter and all power and signal cables from the system.



3. Place the system on a flat, stable surface.
4. Remove the battery pack.

Disassembly Process

IMPORTANT:The LCD Module cannot be disassembled outside of factory conditions. If any part of the LCD Module is faulty, such as the camera, antenna or LCD panel, the whole module must be replaced.

The disassembly process is divided into the following stages:

- External module disassembly
- Main unit disassembly

The flowcharts provided in the succeeding disassembly sections illustrate the entire disassembly sequence. Observe the order of the sequence to avoid damage to any of the hardware components. For example, if you want to remove the mainboard, you must first remove the keyboard, then disassemble the inside assembly frame in that order.

Main Screw List

Screw	Quantity	Part Number
M2.45D 8.0L K 5.5D 0.8T ZKNL	14	86.WBF02.001
M2.5D 5L K 5.5D ZK NL + CR3	23	86.WBF02.010
M2.46D 3.0L K 5.5D 0.8T ZKNL	3	86.WBF02.002
M1.98D 3.0L K 4.6D 0.8T ZKNL	20	86.WBF02.003
M3.0D 3.0L K 4.9D NI	8	86.WBF02.005
M2D 4.0L K 4.6D NI NL	2	86.WBF02.007
ASSY THML SPRING	4	86.WBF02.009

External Module Disassembly Process

IMPORTANT:The outside housing and color may vary from the mass produced model.

External Modules Disassembly Flowchart

The flowchart below gives you a graphic representation on the entire disassembly sequence and instructs you on the components that need to be removed during servicing. For example, if you want to remove the main board, you must first remove the keyboard, then disassemble the inside assembly frame in that order.

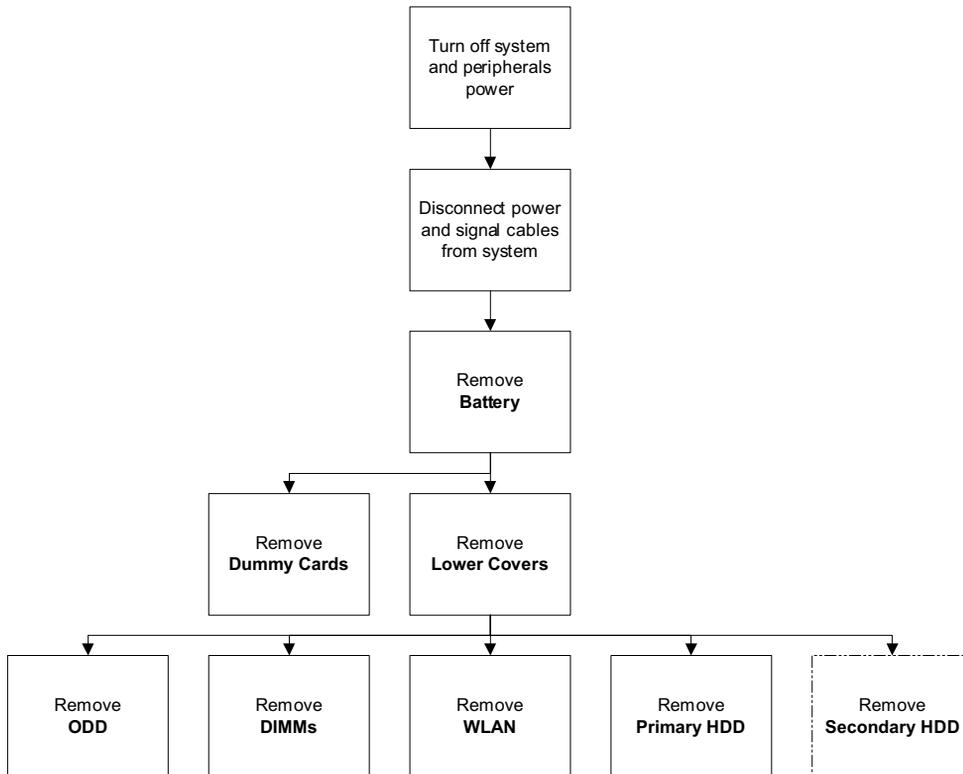

NOTE: Items enclosed with broken lines (— - - —) are optional and may not be present.

Screw List

Step	Screw	Quantity	Part No.
WLAN Module	M2*3	1	86.WBF02.003
ODD Module	M2.5*5	1	86.WBF02.010
ODD Bracket	M2*3	2	86.WBF02.003
Primary HDD Carrier	M3*3	4	86.WBF02.005
Secondary HDD Carrier	M3*3	4	86.WBF02.005

Removing the Battery Pack

1. Turn computer over. Slide the battery lock in the direction shown.



2. Slide and hold the battery release latch to the release position (1), then lift out the battery pack from the main unit (2).



Removing the SD dummy card

1. Push the SD dummy card all the way in to eject it.



2. Pull the card out from the slot.



Removing the Lower Covers

1. See "Removing the Battery Pack" on page 46.
2. Loosen the five captive screws in the memory and HDD covers.

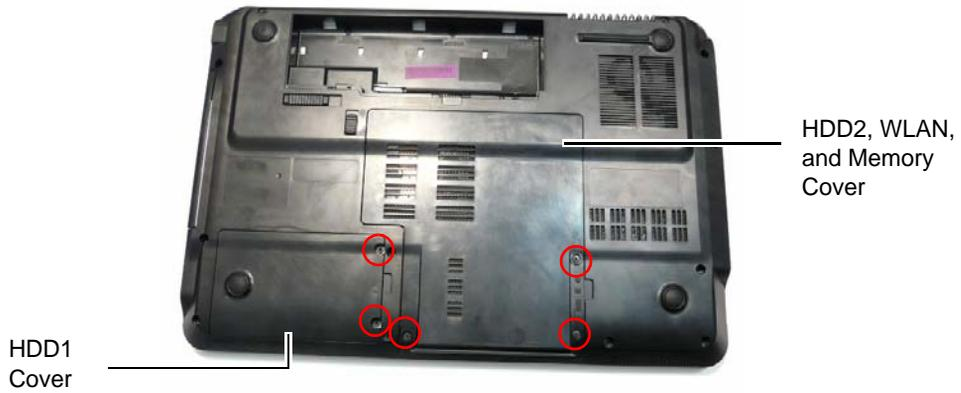

3. Remove the HDD1 Cover.



4. Remove the HDD2, WLAN, and Memory Cover as shown.



Removing the Optical Drive Module

1. See "Removing the Lower Covers" on page 48.
2. Remove the screw securing the ODD module.

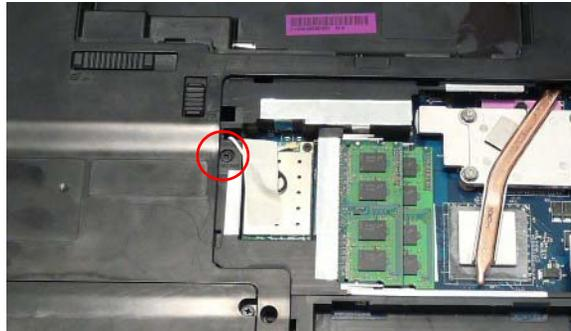

Step	Size	Quantity	Screw Type
ODD Module	M2.5*5	1	

3. Insert a suitable tool into the access slot as shown. Gently lever the ODD module out of the chassis.
4. Pull the optical drive module out from the chassis.



5. Remove the two screws securing the ODD bracket and remove the ODD bracket from the optical disk drive module.



Step	Size	Quantity	Screw Type
ODD Bracket	M2*3	2	

6. Remove the ODD bezel by rotating the top edge downward and pulling it clear of the module.



Removing the DIMM Modules

1. See "Removing the Lower Covers" on page 48.
2. Push out the release latches on both sides of the DIMM socket to release the DIMM module.

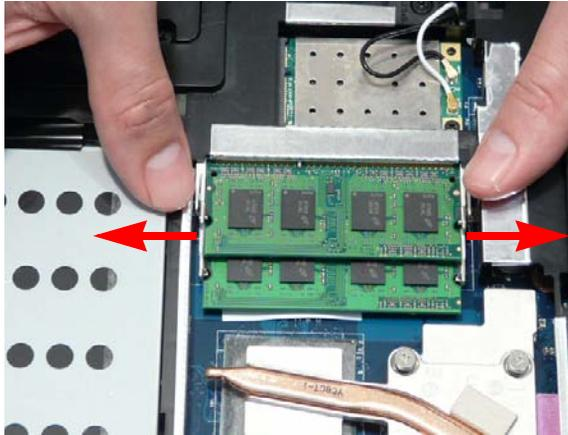

3. Remove the DIMM module.

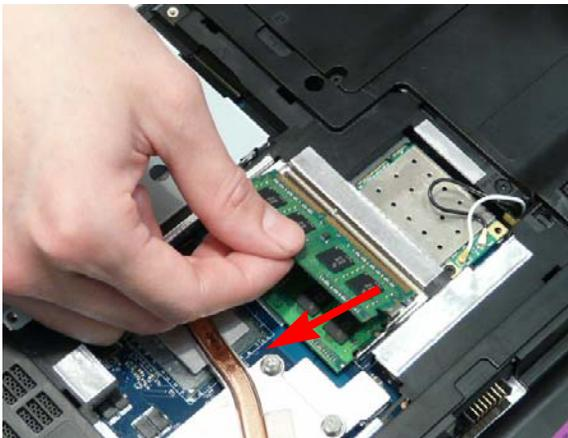

4. Repeat steps for the second DIMM module if present.

Removing the WLAN Module

1. See "Removing the Lower Covers" on page 48.
2. Remove the adhesive tape securing the Antenna cables in place.

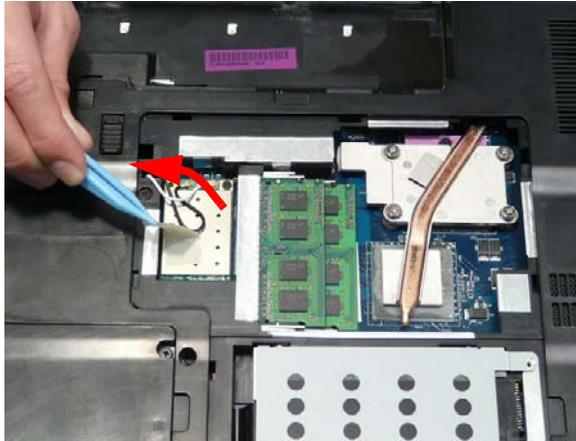

3. Disconnect the antenna cables from the WLAN Module.



NOTE: Cable placement is **Black** to the **MAIN** terminal (left) and **White** to the **AUX** terminal (right).

4. Move the Antennas away and remove the two screws to release the WLAN Module.

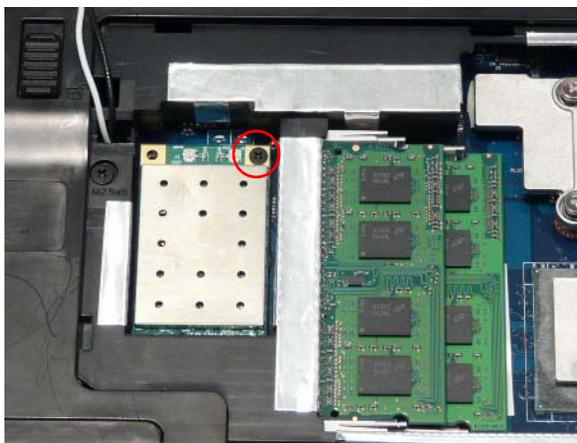

Step	Size	Quantity	Screw Type
WLAN Module	M2*3	1	

5. Detach the WLAN Module from the WLAN socket.

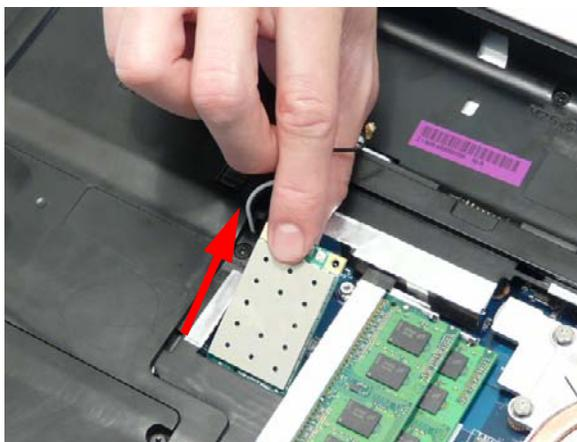

NOTE: When reattaching the antennas, ensure the cables are tucked into the chassis to prevent damage.

Removing the Primary HDD Module

1. See "Removing the Lower Covers" on page 48.
2. Using the pull-tab, slide the HDD Module in the direction of the arrow to disconnect the interface.

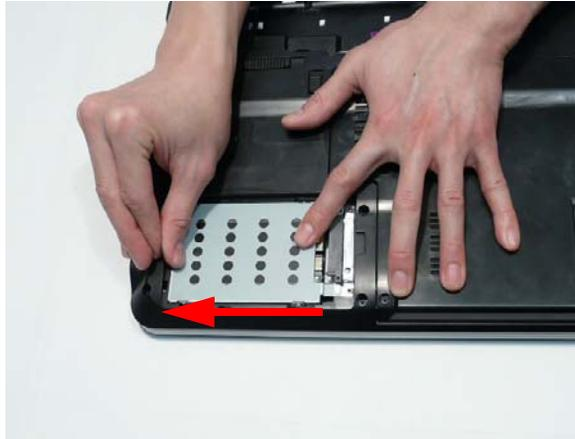

3. Lift the HDD Module clear of the HDD bay.
NOTE: To prevent damage to device, avoid pressing down on it or placing heavy objects on top of it.
4. Remove the four screws (two each side) securing the hard disk to the carrier.

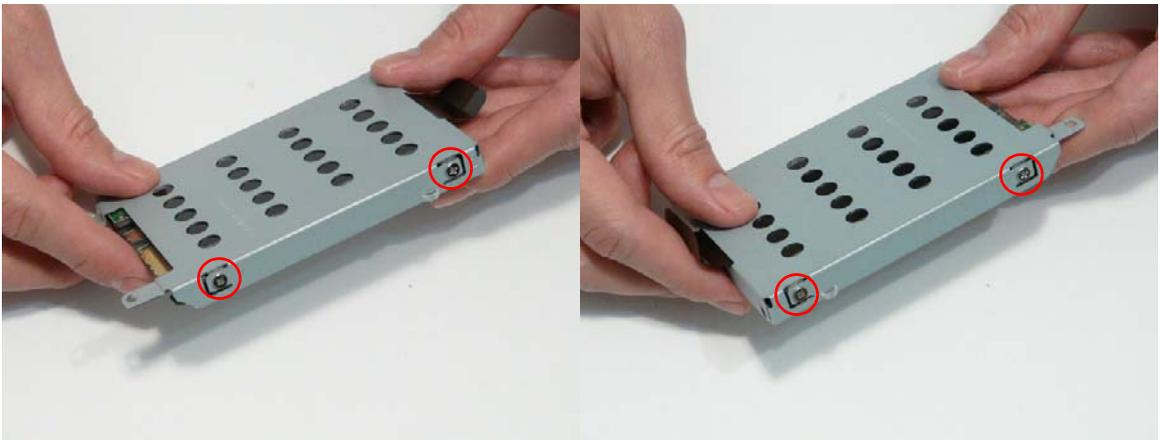

Step	Size	Quantity	Screw Type
HDD Carrier	M3*3	4	

5. Remove the HDD from the carrier.

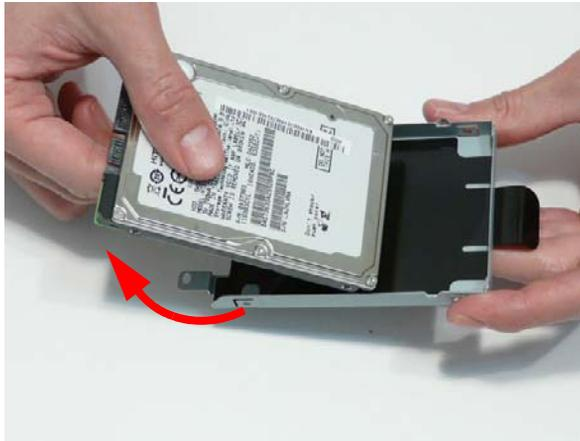

Removing the Secondary HDD Module

NOTE: The Secondary HDD is optional and may not be present.

1. See "Removing the Lower Covers" on page 48.
2. Using the pull-tab, slide the HDD Module in the direction of the arrow to disconnect the interface.

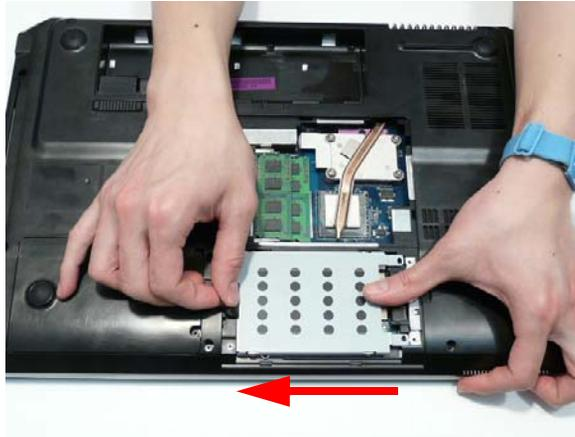

3. Lift the HDD Module clear of the HDD bay.



NOTE: To prevent damage to device, avoid pressing down on it or placing heavy objects on top of it.

4. Remove the four screws (two each side) securing the hard disk to the carrier.

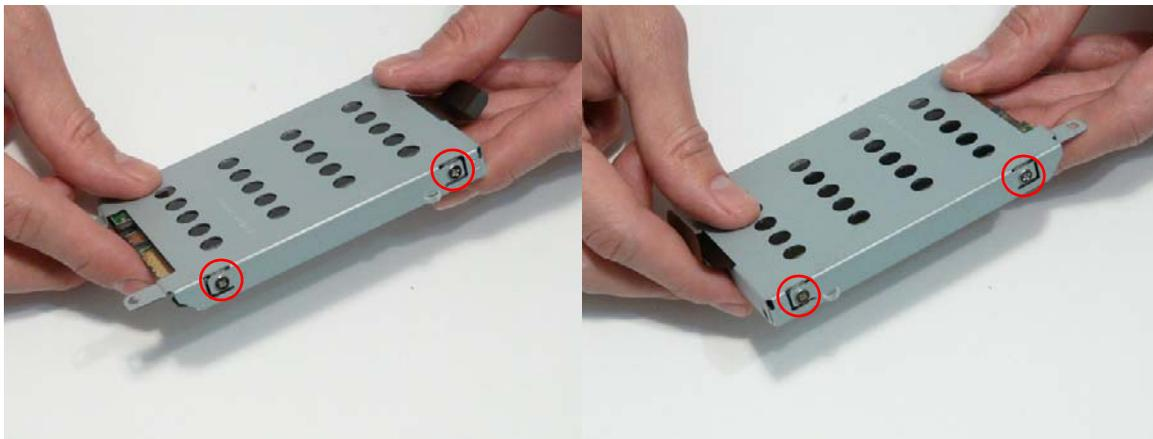

Step	Size	Quantity	Screw Type
HDD Carrier	M3*3	4	

5. Remove the HDD from the carrier.



Main Unit Disassembly Process

Main Unit Disassembly Flowchart

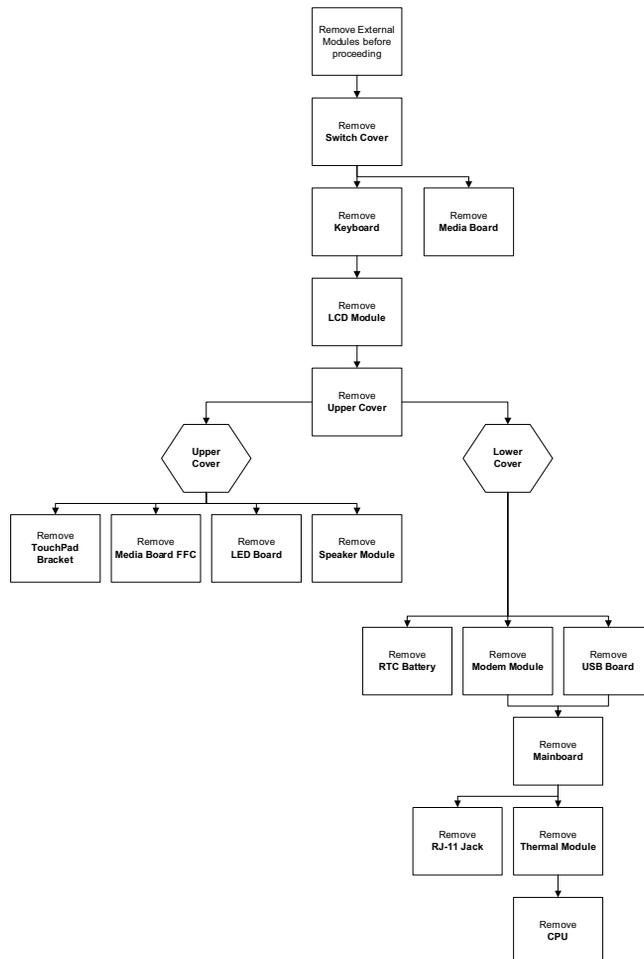

Screw List

Step	Screw	Quantity	Part No.
Switch Cover	M2.5*5	3	86.WBF02.010
LCD Module	M2.5*8	4	86.WBF02.001
	M2.5*5	2	86.WBF02.010
Upper Cover	M2.5*8	10	86.WBF02.001
	M2.5*5	9	86.WBF02.010
	M2.5*3	3	86.WBF02.002
TouchPad Bracket	M2*3	1	86.WBF02.003
Speaker Module	M2*3	4	86.WBF02.003
Modem Board	M2*3	2	86.WBF02.003
USB Board	M2.5*5	1	86.WBF02.010
Mainboard	M2.5*5	1	86.WBF02.010
CPU Fan	M2*3	3	86.WBF02.003
Thermal Module	M2.5*6.5	4	86.WBF02.009

Removing the Switch Cover

1. See "Removing the Battery Pack" on page 46.
2. Lift the Media Board FFC cover as shown to expose the FFC connector.



3. Open the FFC locking latch and disconnect the Media Board FFC.

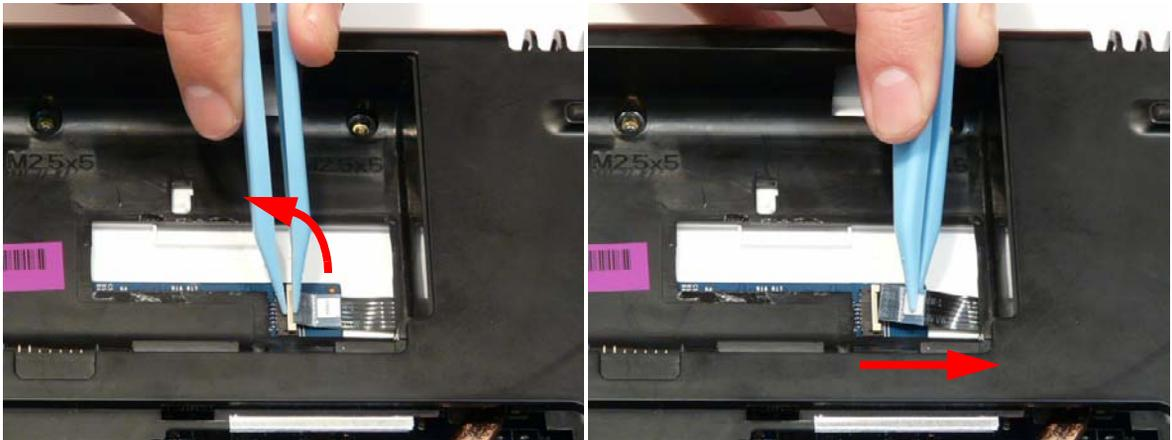

4. Remove the three securing screws from the Lower Cover.

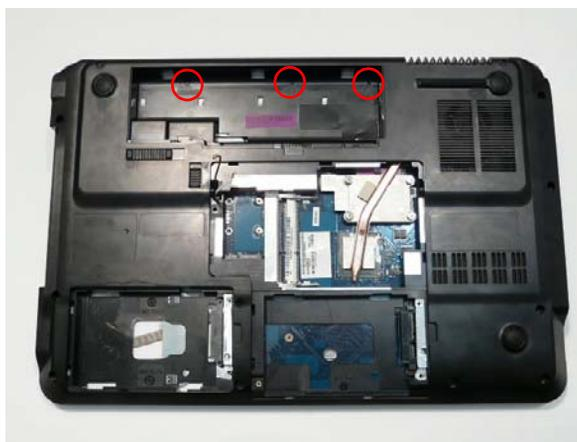

Step	Size	Quantity	Screw Type
Switch Cover	M2.5*5	3	

-
5. Open the computer lid to approximately 45° and push the Switch Cover from the underside of the computer to release the locking latches securing the cover in place.



6. Turn the computer over and open the lid fully. Lift the left side of the Switch Cover as shown.

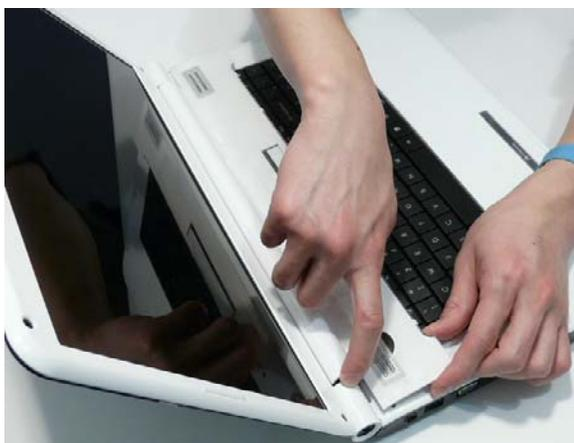

7. Working along the Switch Cover toward the right hinge, gently pry up the cover as shown.

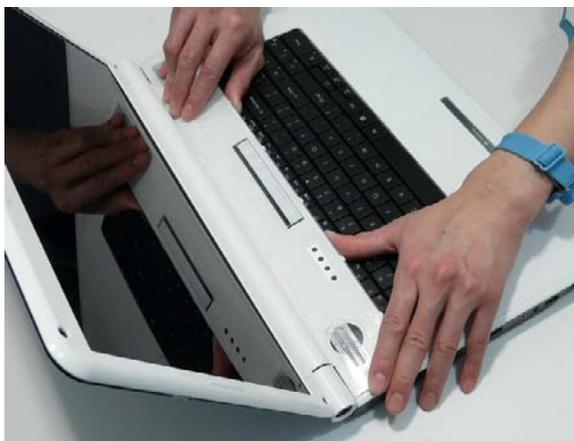

8. Rotate the Switch Cover toward the LCD panel and lift it away from the Upper Cover.



Removing the Media Board

1. See "Removing the Switch Cover" on page 59.
2. Pry the Media Board away from the Switch Cover as shown.
NOTE: A very strong adhesive is used to secure the board in place.



3. Pry the board away from the Upper Cover and remove it completely.

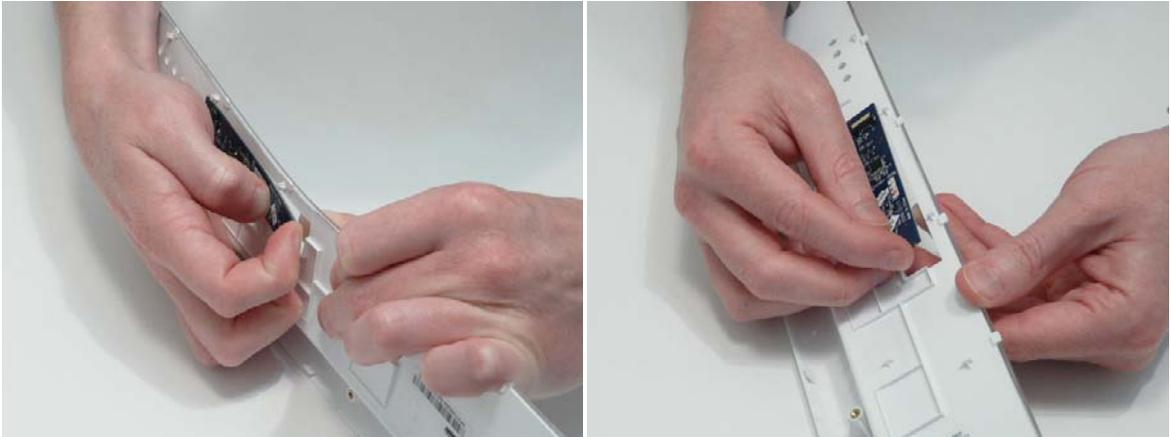

Removing the Keyboard

1. See "Removing the Switch Cover" on page 59.
2. Lift the keyboard from the centre as shown to release the securing clips on each side.



3. Turn the Keyboard over on the TouchPad to expose the FFC cable.

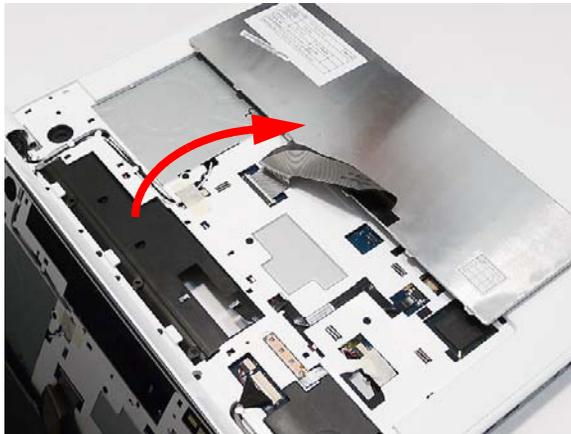

4. Open the locking latch on the FFC as shown.

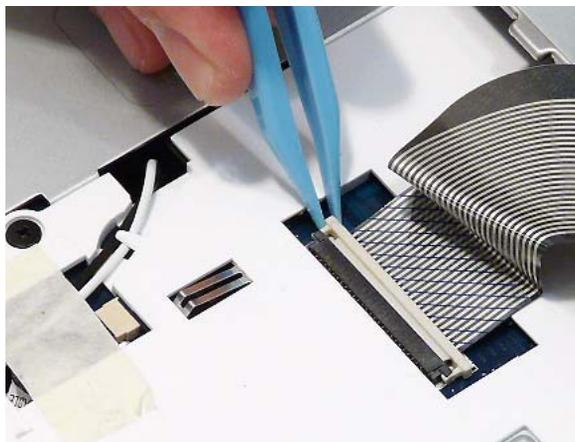

5. Disconnect the FFC cable from the mainboard.

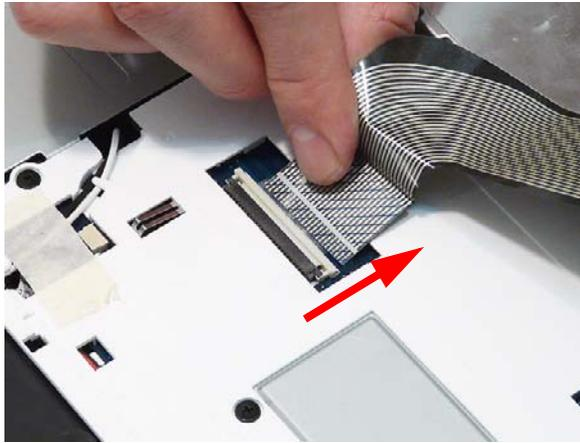

6. Lift the keyboard clear of the chassis.

Removing the LCD Module

1. See "Removing the Keyboard" on page 63.
2. Turn the computer over. Remove the two securing screws from the bottom of the chassis.



Step	Size	Quantity	Screw Type
LCD Module	M2.5*8	2	

3. Open the computer lid and stand the chassis on its edge. Ensure the Antenna Cables are free from obstructions as shown.

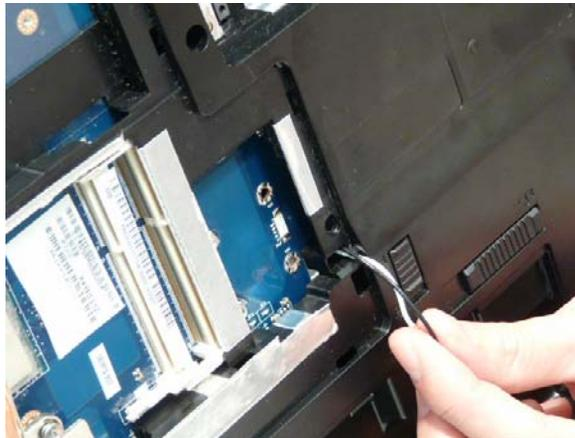

4. Remove the adhesive tape securing the cables in place and pull the Antenna cables through the casing as shown.

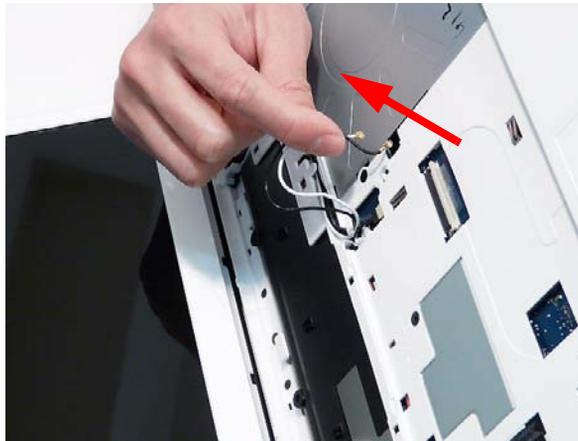
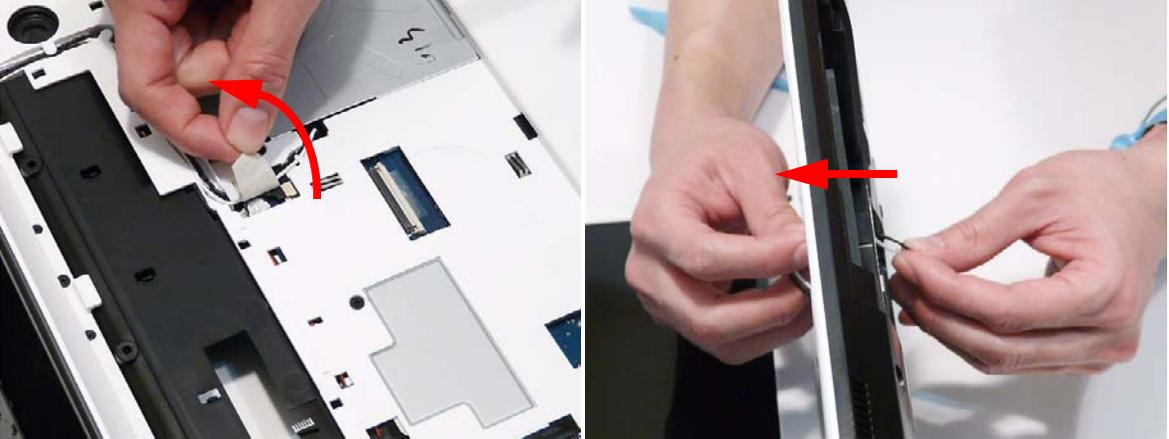

5. Remove the cables from the cable channel as shown. Ensure that the cables are completely free of the retaining clips all the way to the hinge well.

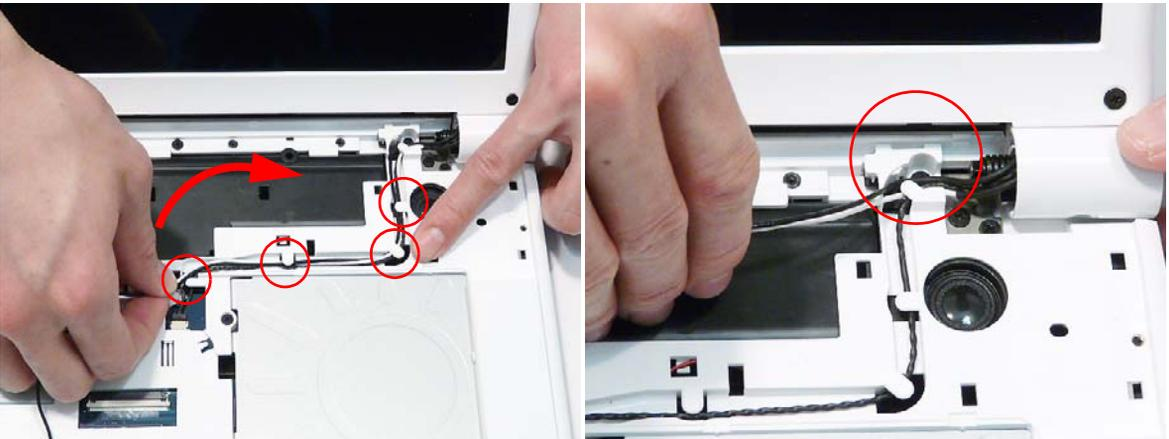

6. Disconnect the Power Board cable from the Mainboard.

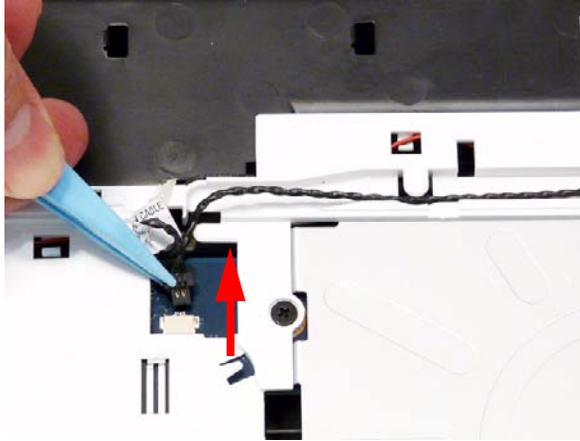

7. Remove the cable from the cable channel as shown. Ensure that the cable is completely free of the retaining clips all the way to the hinge well.

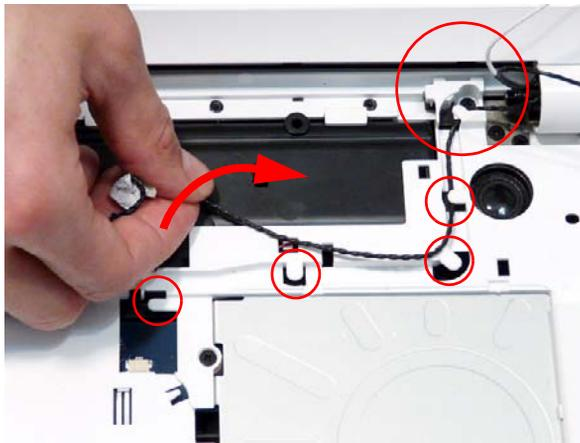

8. Disconnect the power cable from the Mainboard as shown. Ensure that the cable is completely free of the retaining clips all the way to the hinge well.

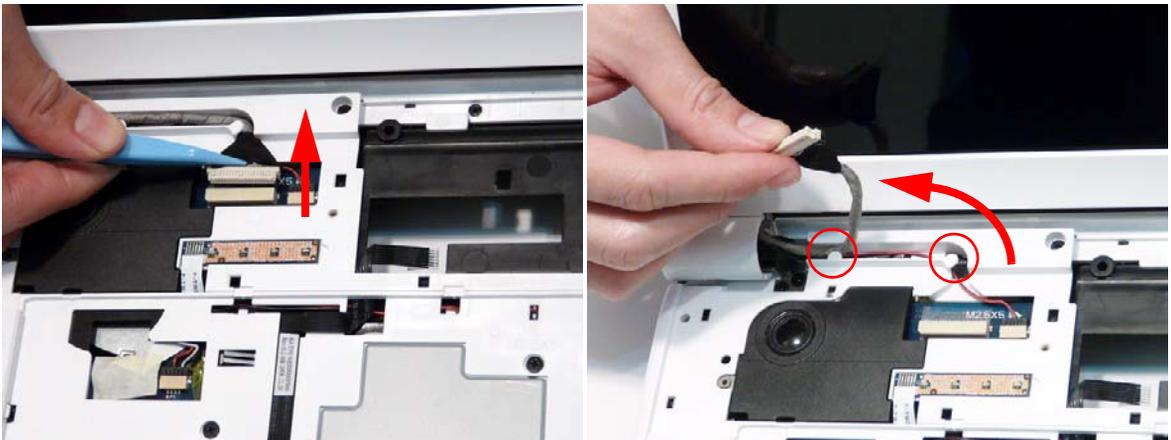

9. Disconnect the MIC cable from the Mainboard as shown. Ensure that the cable is completely free of the retaining clips all the way to the hinge well.



10. Remove the four securing screws (two each side) from the LCD module.

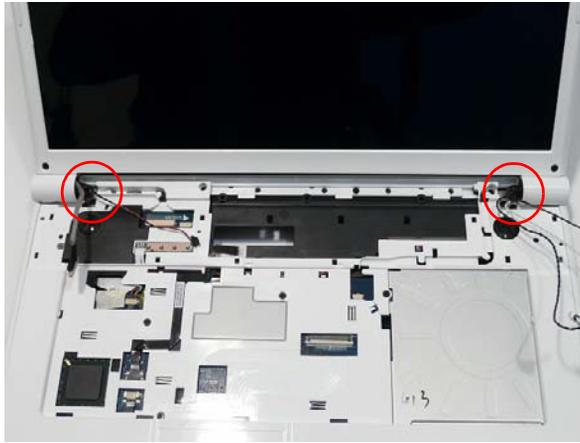

Step	Size	Quantity	Screw Type
LCD Module (red callout)	M2.5*8	2	
LCD Module (green callout)	M2.5*5	2	

11. Carefully remove the LCD module from the chassis.

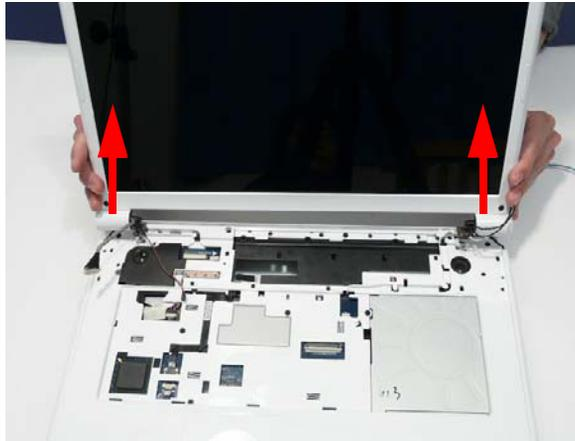

Removing the Upper Cover

1. See "Removing the LCD Module" on page 65.
2. Turn the computer over. Remove the thirteen screws on the bottom panel.



Step	Size	Quantity	Screw Type
Upper Cover (red callout)	M2.5*8	10	
Upper Cover (green callout)	M2.5*5	1	
Upper Cover (blue callout)	M2.5*3	2	

3. Turn the computer over. Remove the nine screws on the top panel.

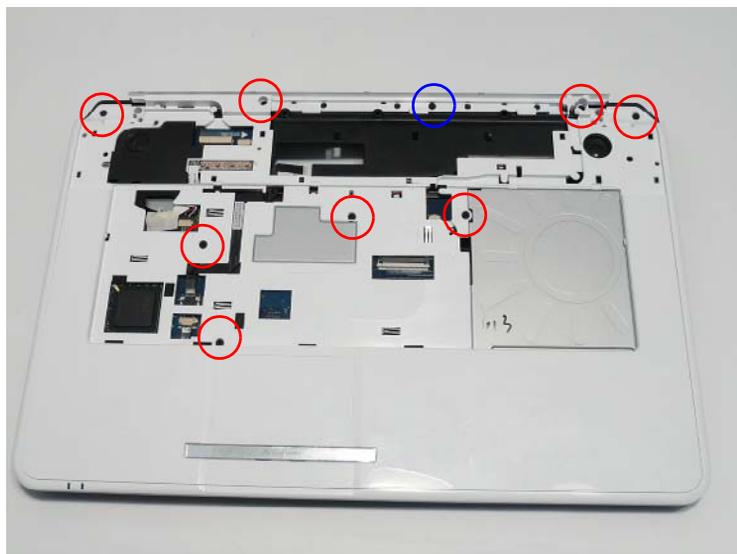

Step	Size	Quantity	Screw Type
Upper Cover (red callout)	M2.5*5	8	
Upper Cover (blue callout)	M2.5*3	1	

4. Remove the adhesive tape holding the cables in place.

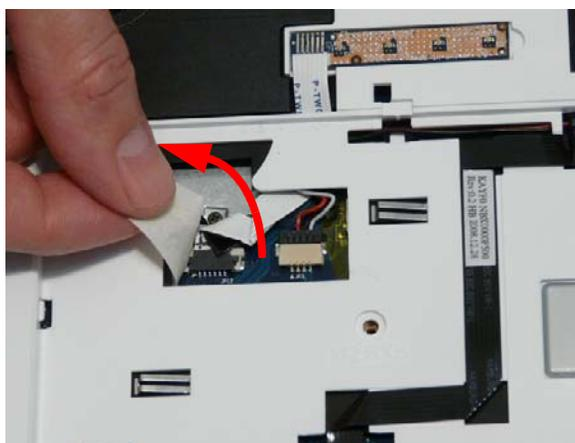

5. Disconnect the following cables from the Mainboard.



6. Disconnect A as shown.

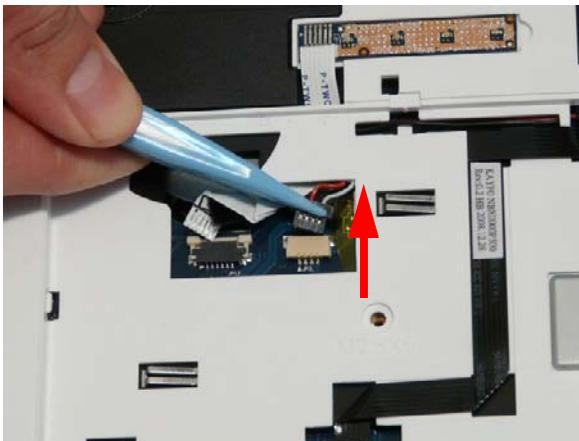

7. Release the locking latch and remove B as shown.

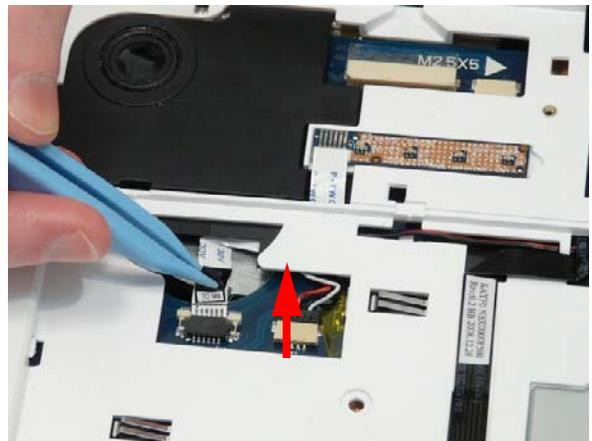

8. Release the locking latch and remove C as shown.

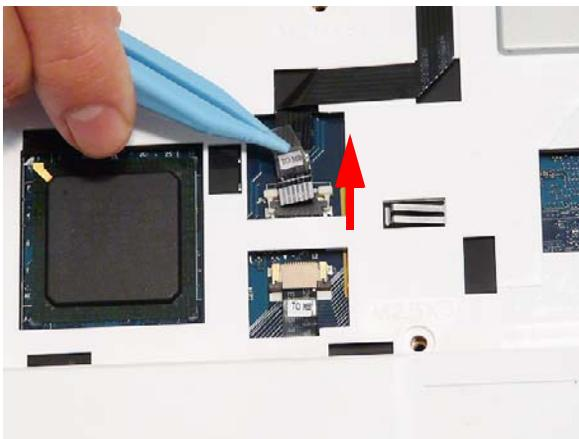

9. Release the locking latch and remove D as shown.

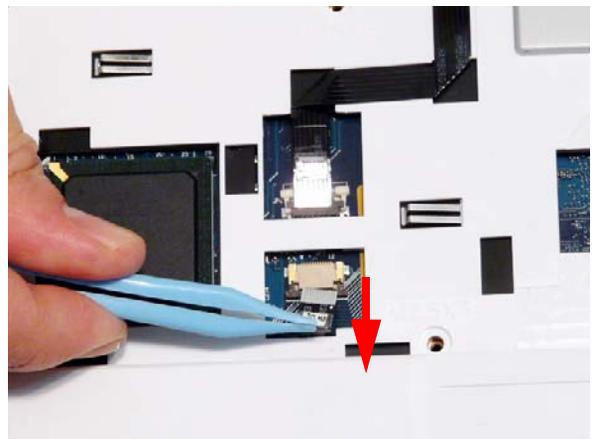

NOTE: Avoid pulling on cables directly to prevent damage to the connectors. Use the pull-tabs on FFC cables whenever available to prevent damage.

10. Starting at the top-inside edges of the Upper Cover above the Battery Bay, lift the Upper Cover away from the Lower Cover as shown.

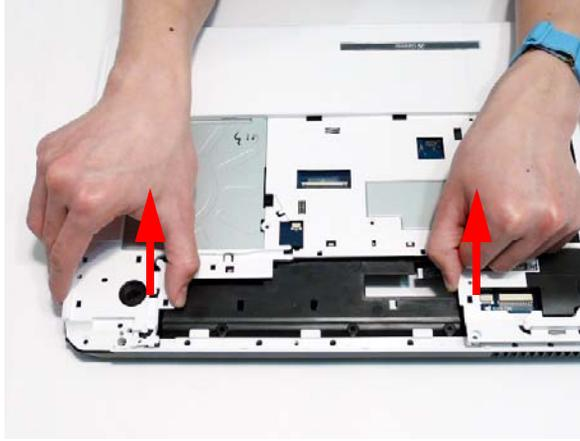

11. Work along the top edge prying the casing apart as shown.



12. Pry apart the left and right sides of the casing and lift the Upper Cover away from the Lower Cover.

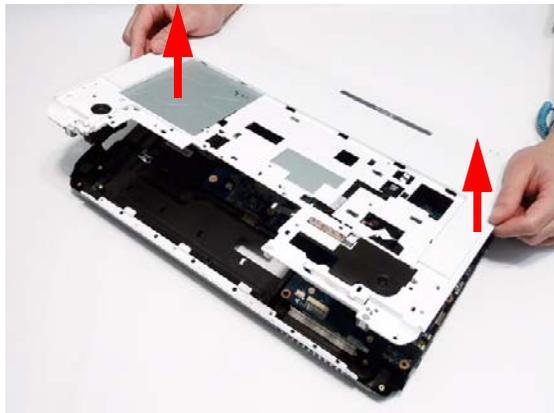

Removing the TouchPad Bracket

1. See "Removing the Upper Cover" on page 70.
2. Release the FFC locking latch and disconnect the TouchPad FFC from the cover.



3. Remove the single screw securing the TouchPad Bracket to the Upper Cover.

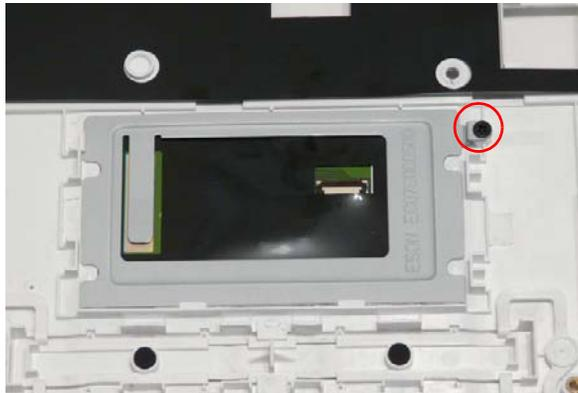

Step	Size	Quantity	Screw Type
TouchPad Bracket	M2*3	1	

4. Hold down the left side of the bracket as shown. Lift and pivot the right edge in the direction of the arrow to release the locking latches on the front edge.

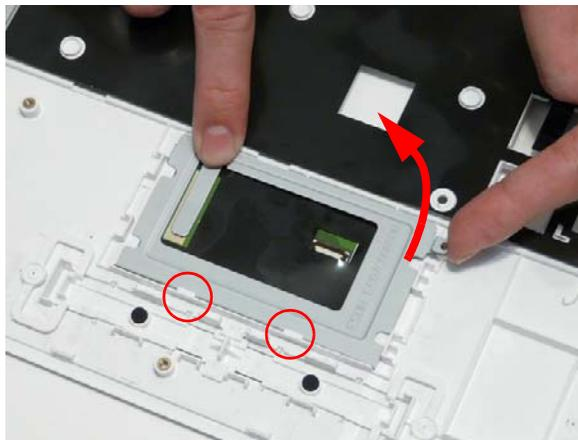

5. Remove the bracket from the Upper Cover.

Removing the Media Board FFC

1. See "Removing the Upper Cover" on page 70.
2. Lift the Media Board FFC as shown to release the adhesive securing it to the Upper Cover.

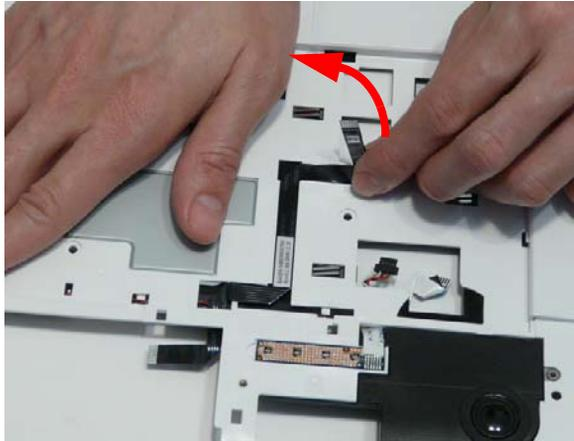

3. Pull the FFC through the Upper Cover as shown. Ensure that the cable passes through the casing completely.

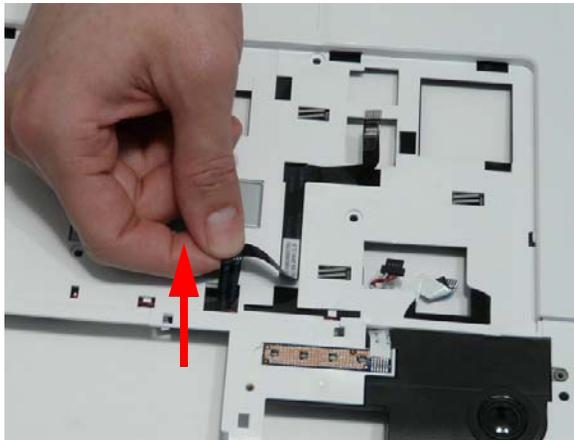

4. Lift the FFC to remove it from the Upper Cover.

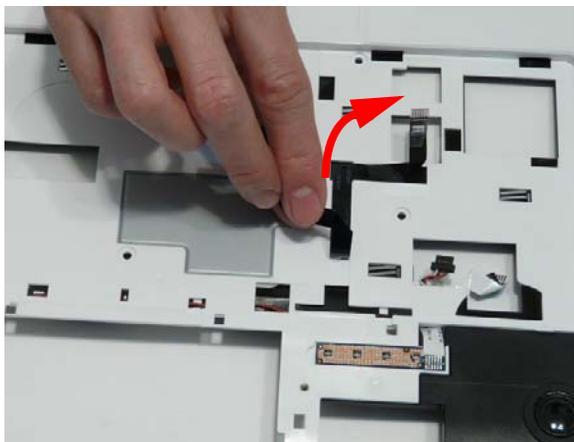

Removing the LED Board

1. See "Removing the Upper Cover" on page 70.
2. Lift the right edge of the LED Board to release the adhesive securing the board to the Upper Cover.



3. Lift the LED Board away from the Upper Cover as shown.

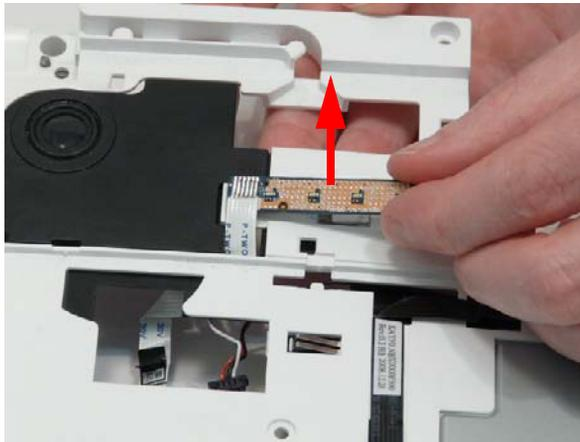

4. Remove the LED Board from the chassis and slide the FFC through the casing as shown.

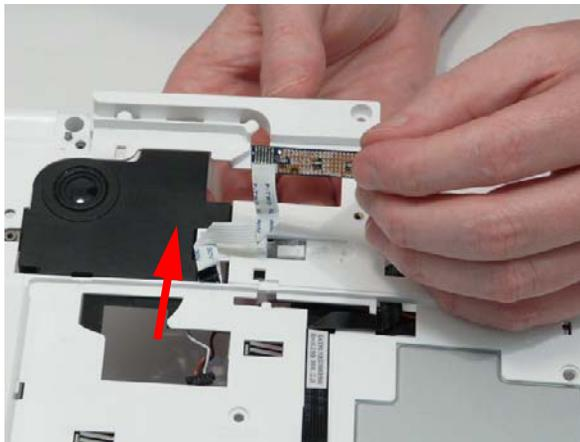

Removing the Speaker Module

1. See "Removing the Upper Cover" on page 70.
2. Remove the four screws from the speaker modules.

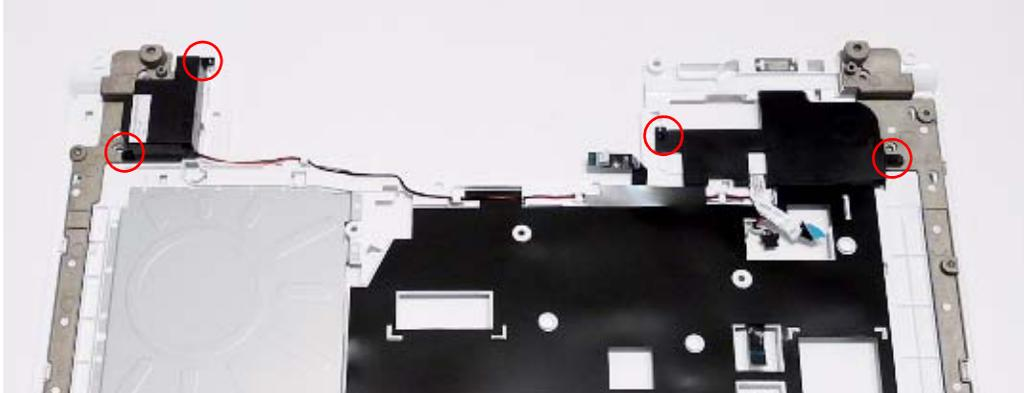

Step	Size	Quantity	Screw Type
Speaker Module	M2*3	4	

3. Remove the right side Speaker cable from the channel as shown.

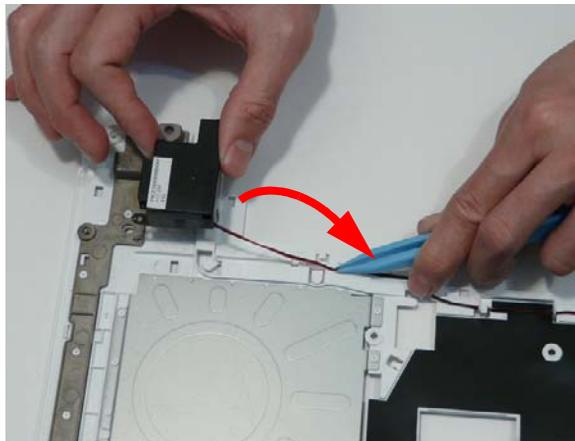

4. Lift the mylar sheet away from the Upper Cover to expose the Speaker cable. Remove the cable from the Upper Cover.

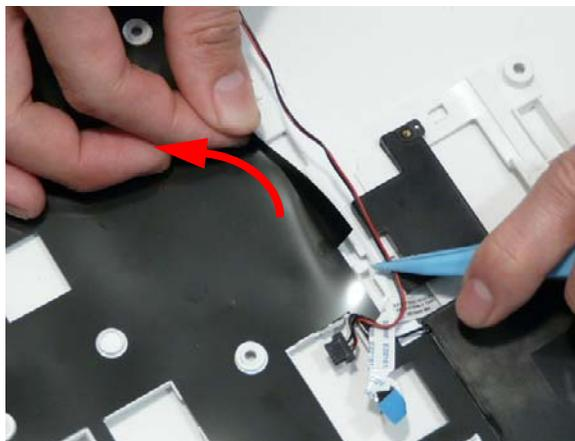

5. Lift the entire Speaker assembly clear of the Upper Cover.

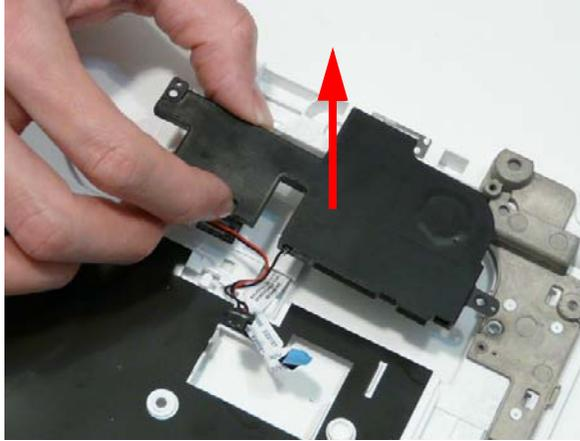

Removing the RTC Battery

IMPORTANT: Follow local regulations for disposal of all batteries.

1. See "Removing the Upper Cover" on page 70.
2. The RTC Battery is soldered to the Mainboard. To replace the battery, solder the new battery to the connections shown.

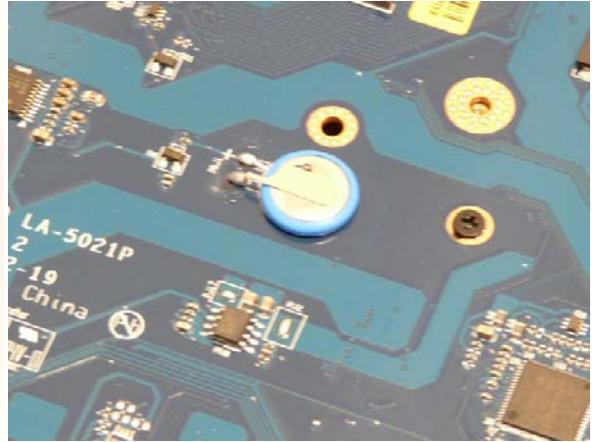

Removing the Modem Board

1. See "Removing the Upper Cover" on page 70.
2. Remove the two securing screws from the Modem Board.

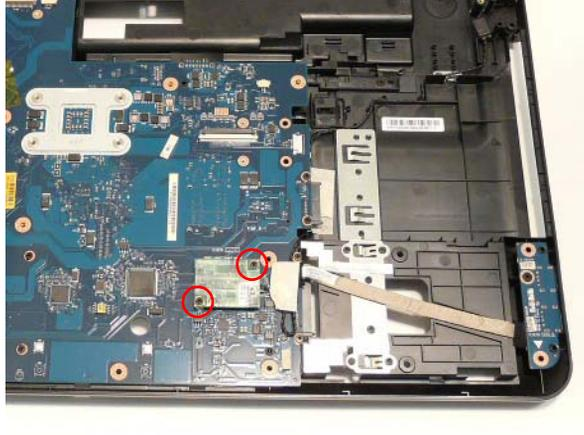

Step	Size	Quantity	Screw Type
Modem Board	M2*3	2	

3. Remove the adhesive tape securing the Modem cable to the Mainboard.

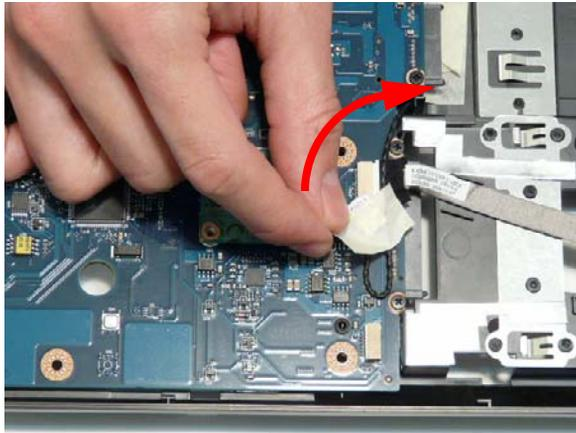

-
4. Lift the Modem Board away from the Mainboard, taking care not to damage the cable attached to the underside of the board.

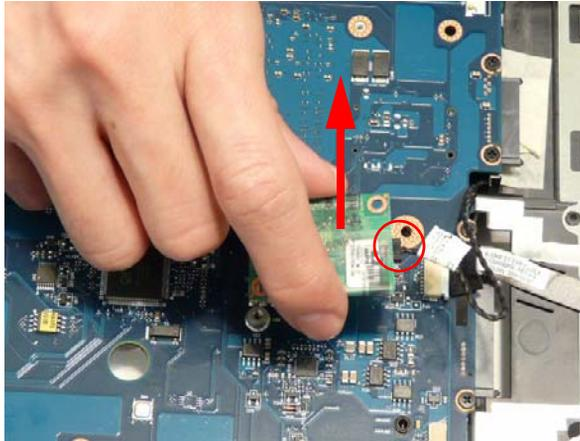

5. Disconnect the cable from the underside of the Modem Board and lift the board clear of the chassis.

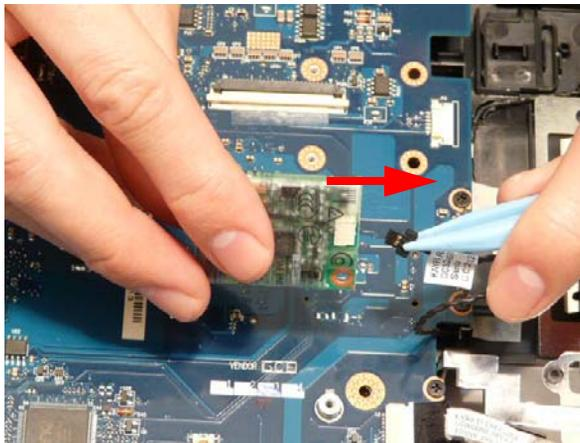

Removing the USB Board

1. See "Removing the Upper Cover" on page 70.
2. Disconnect the USB Board cable from the Mainboard connector.

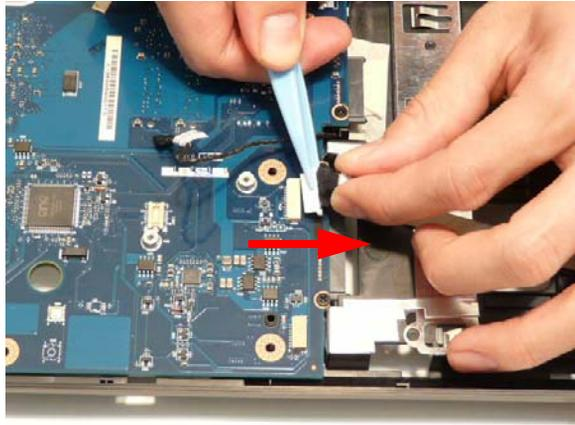

3. Lift the USB cable away from Lower Cover to detach the adhesive.

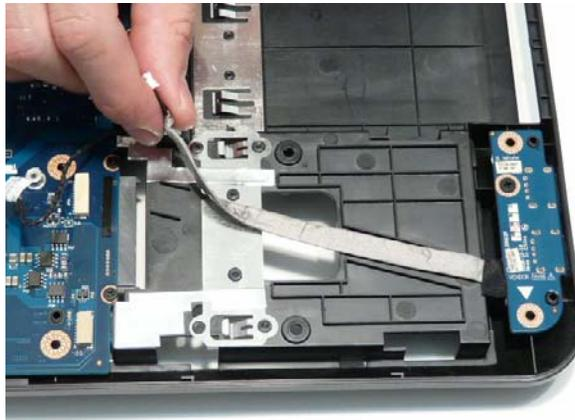

4. Remove the single screw securing the USB Board to the Lower Cover.

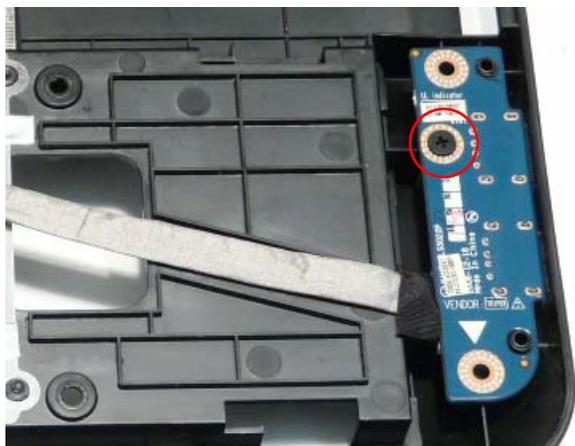

Step	Size	Quantity	Screw Type
USB Board	M2.5*5	1	

5. Lift the USB Board out of the Lower Cover as shown.



6. Remove the USB Board cable from the board connector.

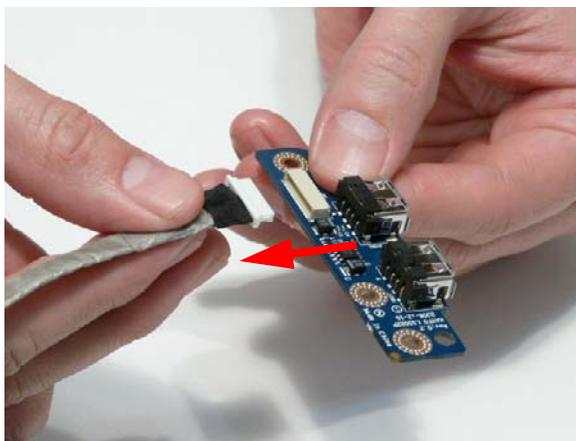

Removing the Mainboard

1. See "Removing the Modem Board" on page 80.
2. See "Removing the USB Board" on page 82.
3. Remove the single screw securing the Mainboard to the Lower Cover.



Step	Size	Quantity	Screw Type
Mainboard	M2.5*5	1	

4. Lift the Mainboard from the Lower Cover right side first, and place it on a clean, dust-free surface.

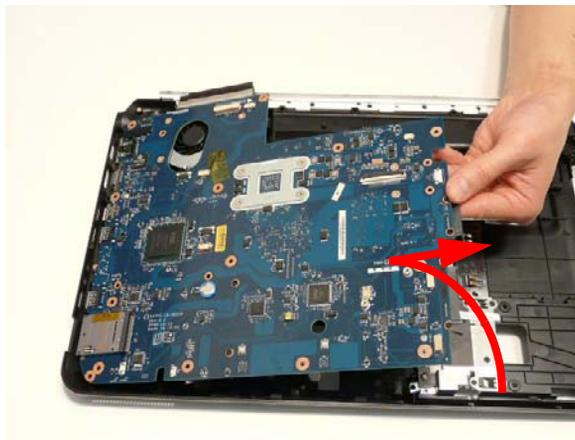

Removing the RJ-11 Jack

1. See "Removing the Mainboard" on page 84.
2. Remove the adhesive tape securing the RJ-11 cable to the Lower Cover.

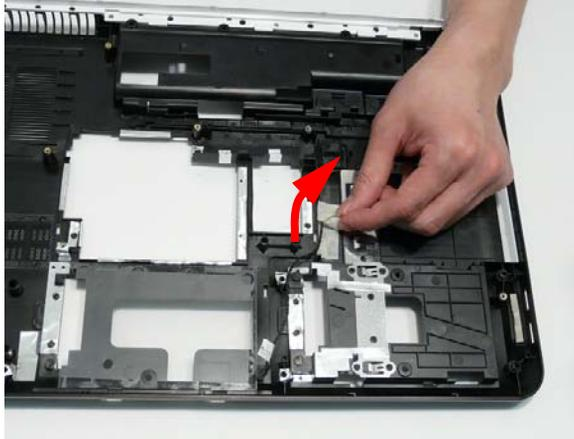

3. Remove the RJ-11 cable from the cable channel. Ensure that the cable is free from all cable clips.

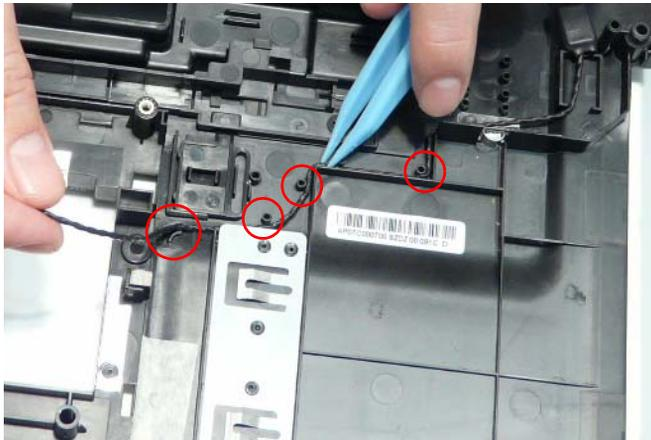

4. Lift the cable bundle away from the Lower Cover to detach the adhesive securing it in place.

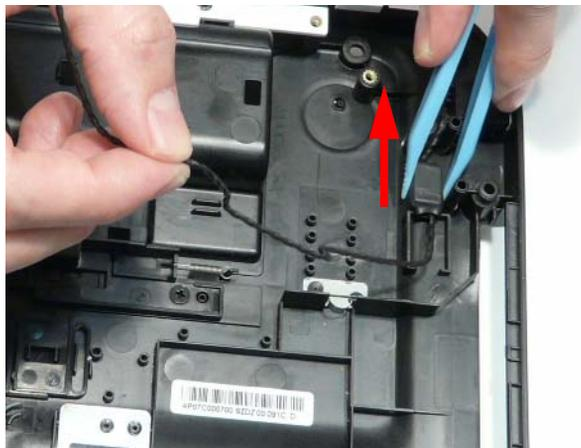

-
5. Lift the RJ-11 Jack away from the Lower Cover to detach the adhesive securing it in place.

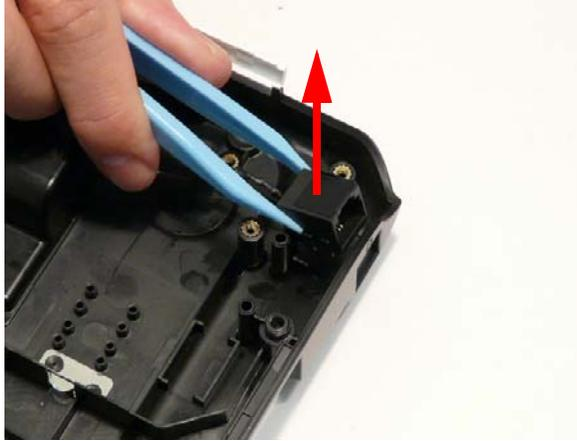

Removing the CPU Fan

1. See "Removing the Mainboard" on page 84.
2. Disconnect the CPU Fan power cable from the Mainboard.

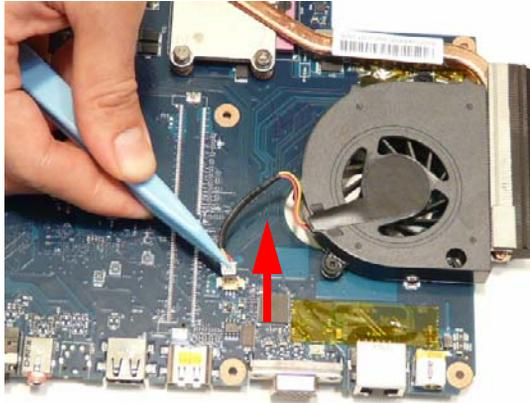

3. Remove the three securing screws from the CPU Fan.

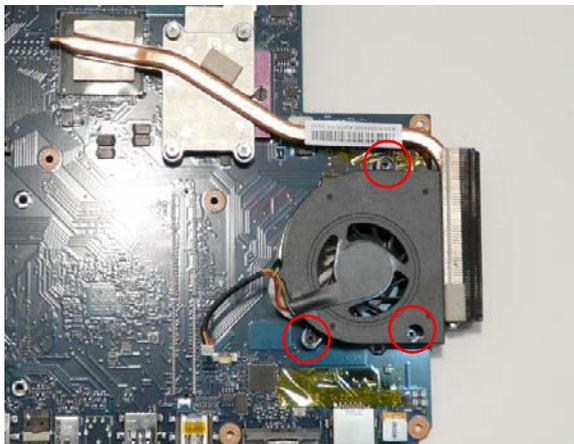

Step	Size	Quantity	Screw Type
CPU Fan	M2*3	3	

4. Remove the CPU Fan from the Mainboard.

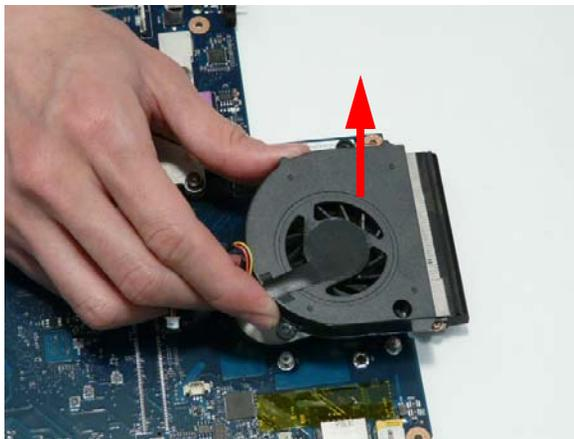

Removing the Thermal Module

1. See "Removing the Mainboard" on page 84.
2. Remove the four screws securing the Thermal Module to the Mainboard in reverse numerical order from 4 to 1.

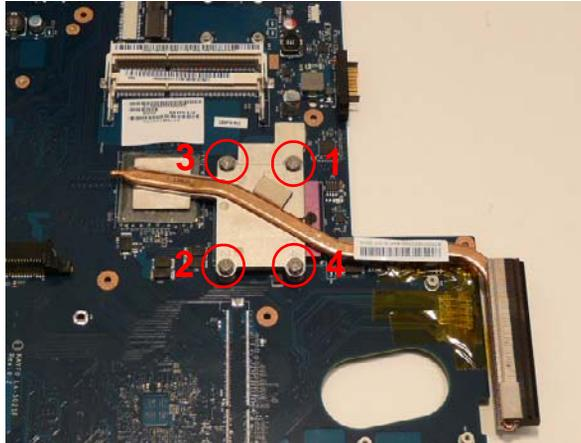

Step	Size	Quantity	Screw Type
Thermal Module	M2.5*6.5	4	

3. Using both hands, lift the Thermal Module clear of the Mainboard.

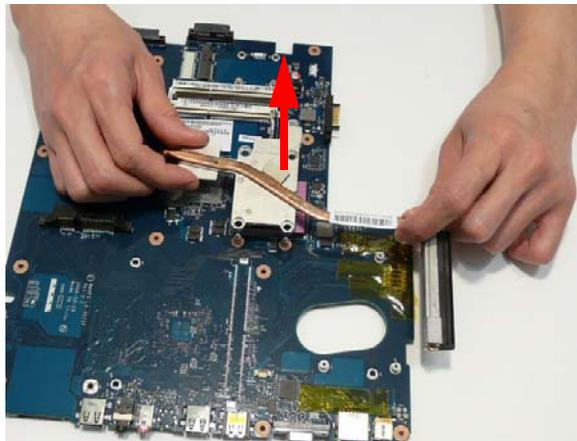

Removing the CPU

1. See “Removing the Thermal Module” on page 88.
2. Using a flat-bladed screw driver, rotate the CPU locking screw 180° counter-clockwise as shown.

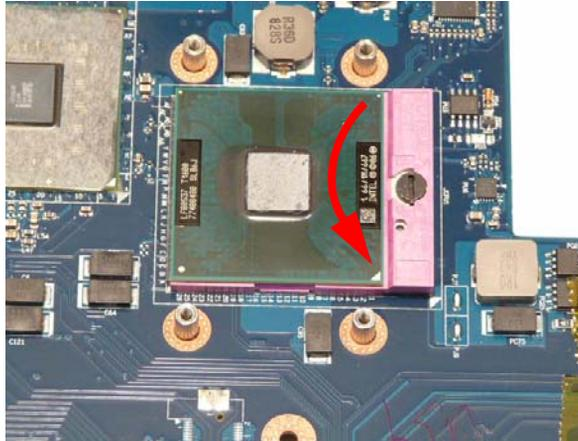

3. Lift the CPU clear of the socket as shown.

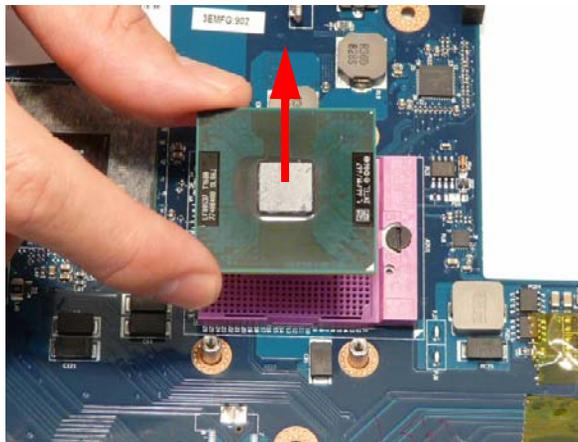

LCD Module Disassembly Process

LCD Module Disassembly Flowchart

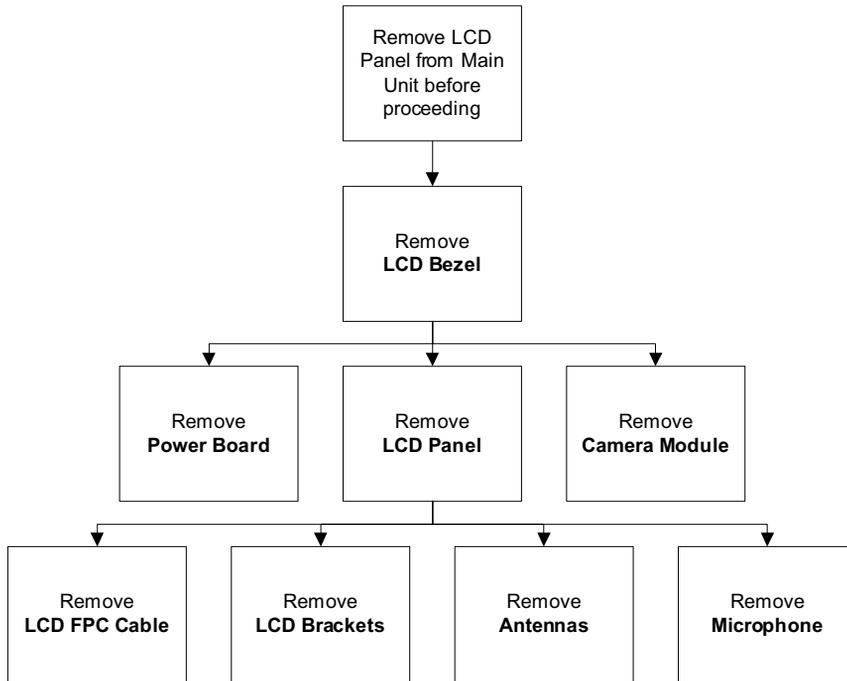

Screw List

Step	Screw	Quantity	Part No.
LCD Bezel	M2.5*5	4	86.WBF02.010
	M2*4	2	86.WBF02.007
LCD Panel	M2.5*5	2	86.WBF02.010
Power Board	M2*3	1	86.WBF02.003
LCD Brackets	M2*3	6	86.WBF02.003

Removing the LCD Bezel

1. See "Removing the LCD Module" on page 65.
2. Remove the four screw caps and six screws (four on the Bezel and two on the Hinge Covers).



Step	Size	Quantity	Screw Type
LCD Bezel (red callout)	M2.5*5	4	
LCD Bezel (green callout)	M2*4	2	

3. Starting from the top centre of the bezel, pry the bezel upwards and away from the panel. Move along the top edge and down each side until all sides of the bezel are removed.

NOTE: If necessary, use a pry to lift up the outside edges of the bezel.

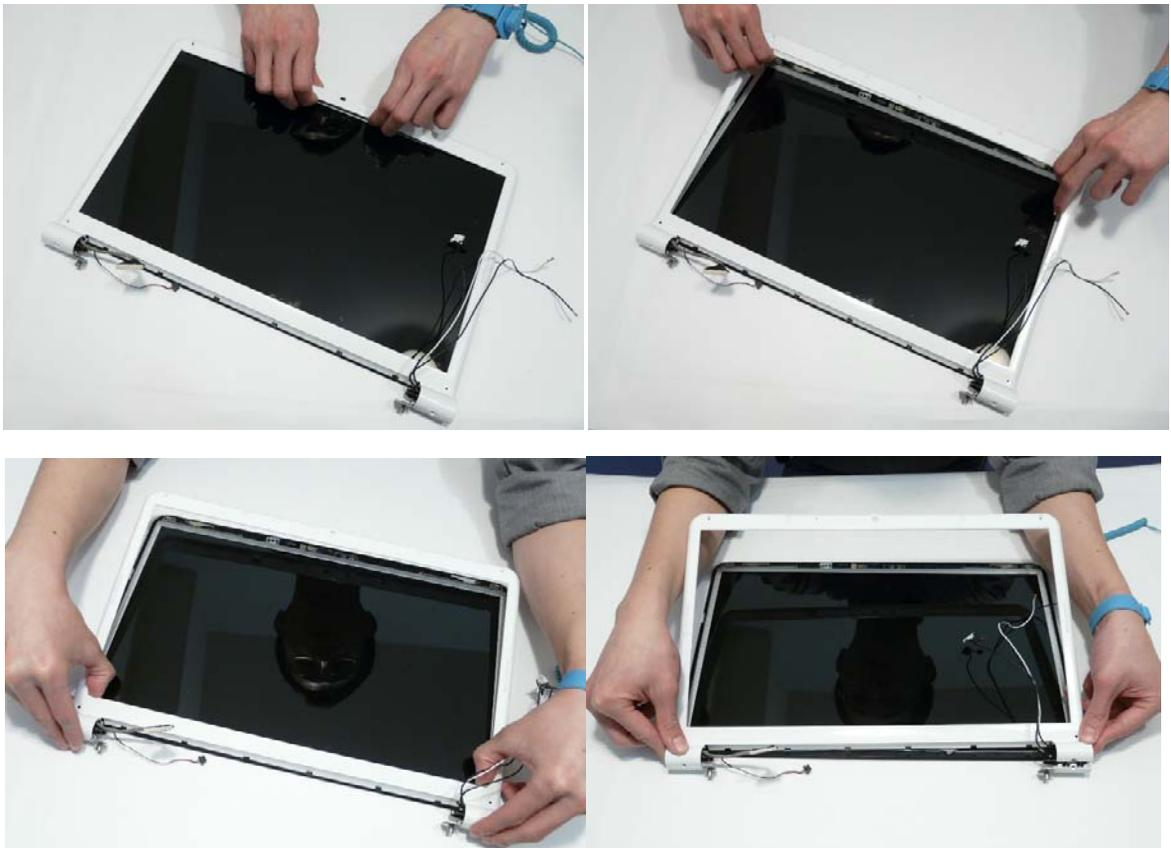

Removing the Camera Module

1. See "Removing the LCD Bezel" on page 91.
2. Disconnect the camera cable.

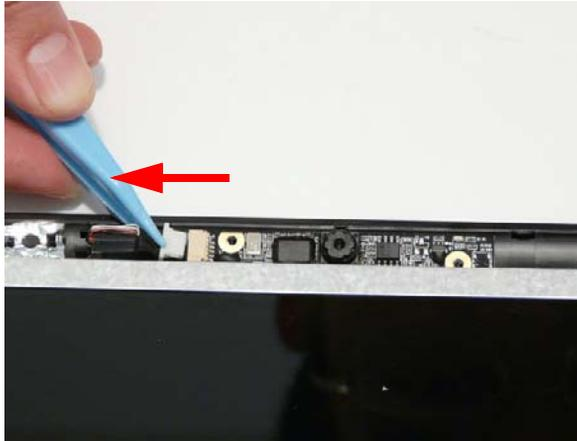

3. Remove the Camera from the module.

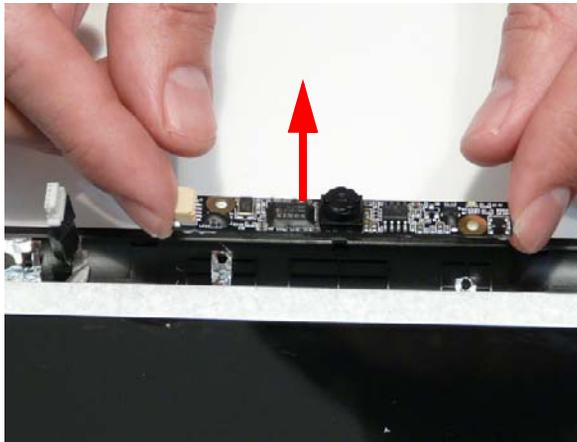

Removing the LCD Panel

1. See "Removing the Camera Module" on page 92.
2. Remove the two securing screws from the LCD Panel.



Step	Size	Quantity	Screw Type
LCD Panel	M2.5*5	2	

3. Lift the LCD Panel out of the module, rear edge first, as shown.



The LCD Module appears as follows when the LCD Panel is removed.



Removing the Power Board

1. See "Removing the LCD Panel" on page 93.
2. Remove the single screw securing the Power Board Bracket to the LCD Module.

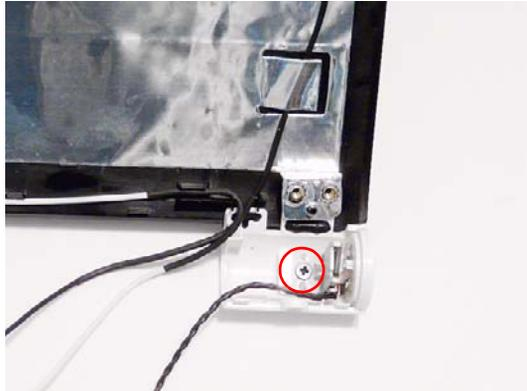

Step	Size	Quantity	Screw Type
Power Board	M2*3	1	

3. Lift the Power Board Bracket from the LCD Panel as shown.

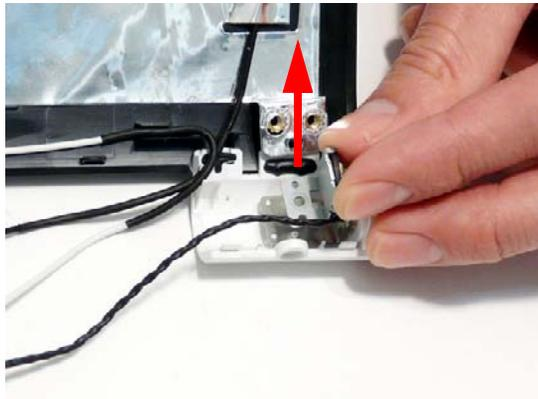

4. Remove the Power Board from the bracket as shown.

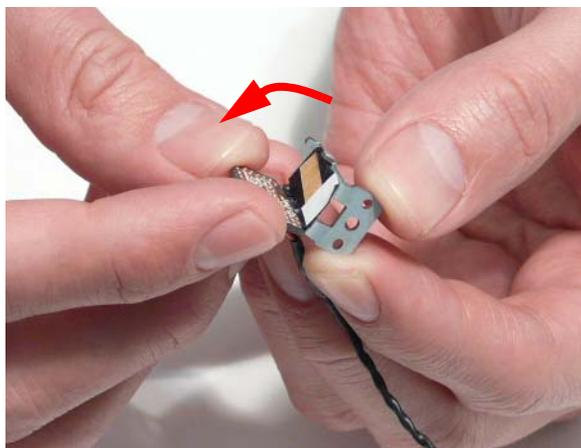

Removing the LCD Brackets and FPC Cable

1. See "Removing the LCD Panel" on page 93.
2. Turn the LCD panel over to expose the rear. Lift the cable as shown to disengage the adhesive strip securing it in place.

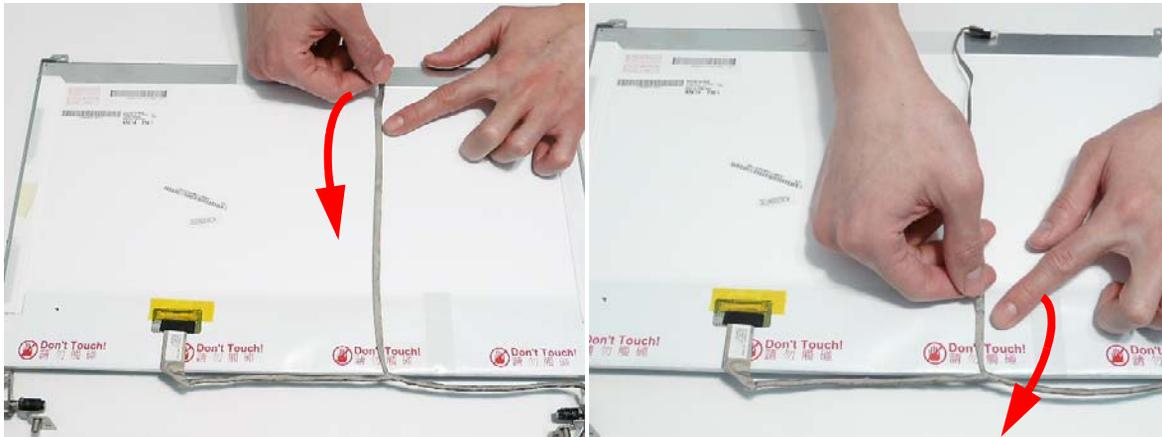

3. Remove the adhesive tape and lift the adhesive protector securing the cable to the LCD Panel.

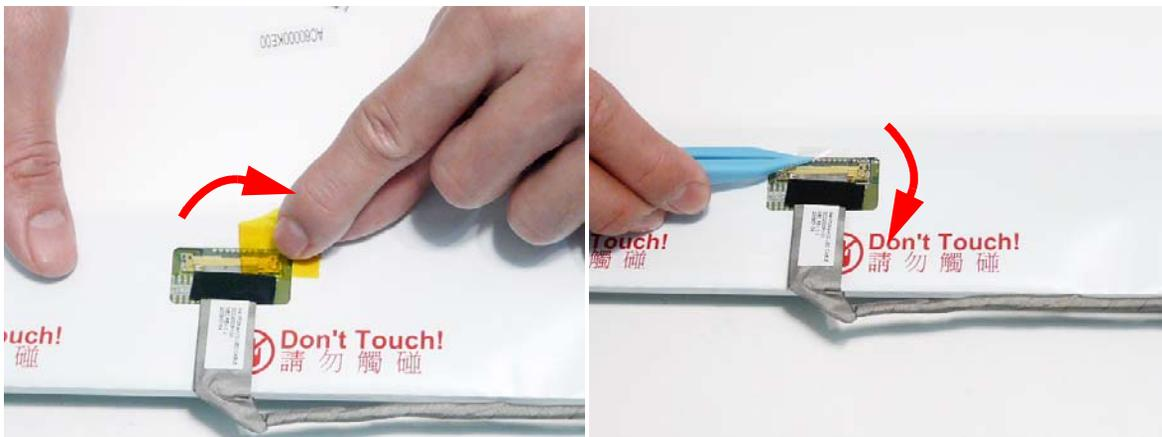

4. Disconnect the cable from the panel connector and lift the FPC cable from the panel.

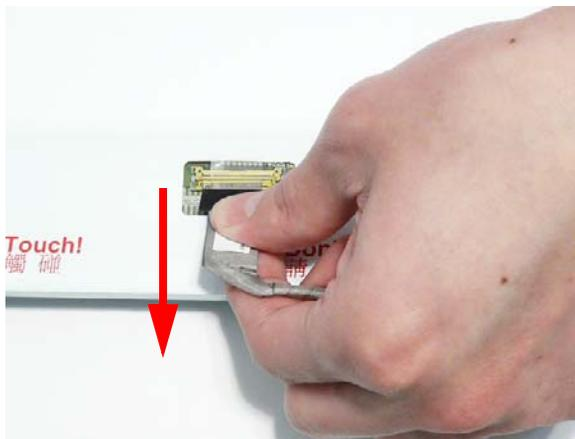

5. Remove the six securing screws (three on each side) from the LCD Panel brackets.

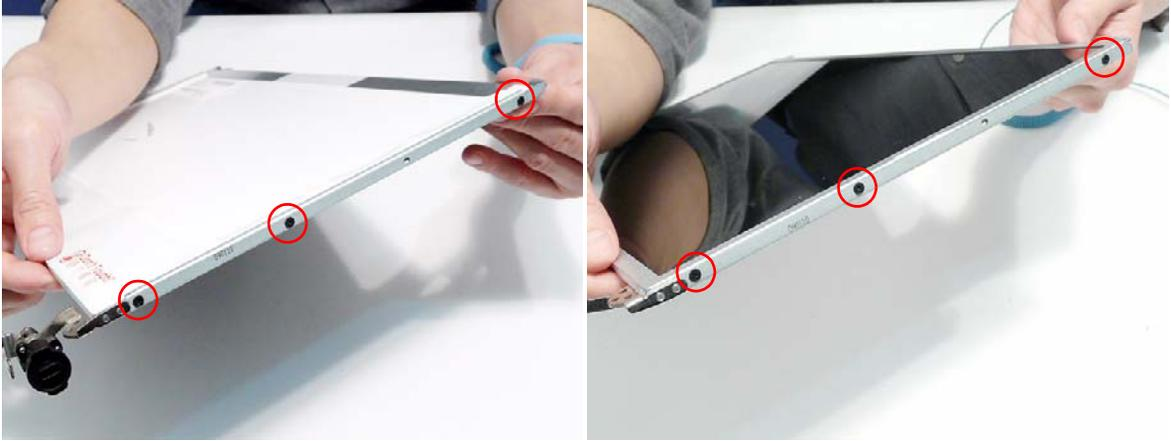

Step	Size	Quantity	Screw Type
LCD Brackets	M2*3	6	

6. Remove the LCD Brackets by pulling away from the LCD Panel.

Removing the Microphone Module

1. See "Removing the LCD Panel" on page 93.
2. Remove the strips holding the microphone cable in place. Ensure the cable is free from obstructions.

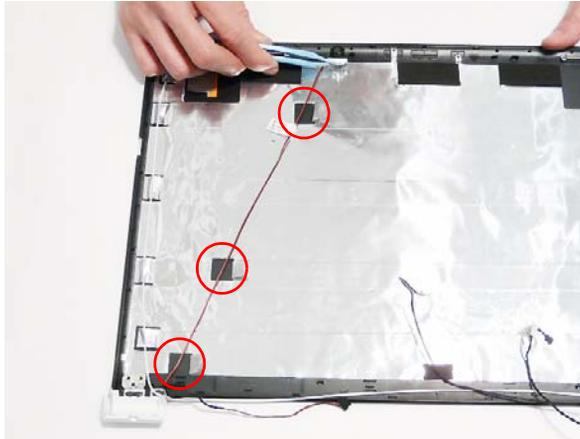

3. Lift the Microphone Module clear of the module.

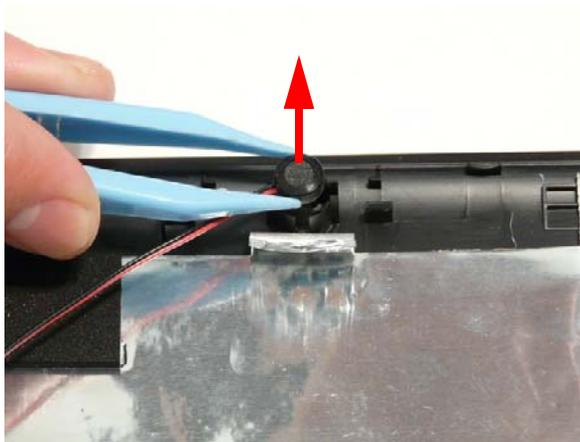

Removing the Antennas

1. See "Removing the LCD Panel" on page 93.
2. Starting from the right hinge, remove the white Antenna cable from the cable channel running along the bottom edge of the LCD Module.

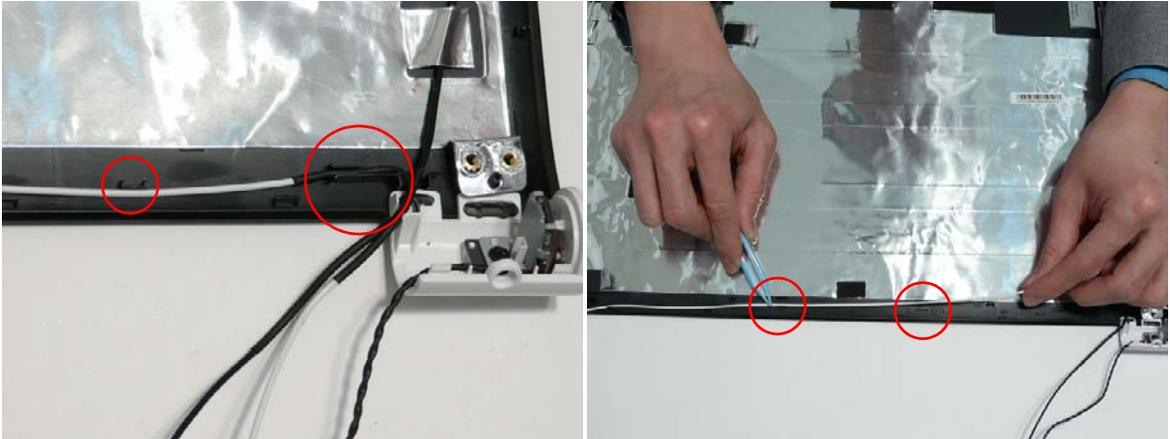

3. Remove the adhesive strips holding the left Antenna cable in place. Ensure the cable is free from obstructions.

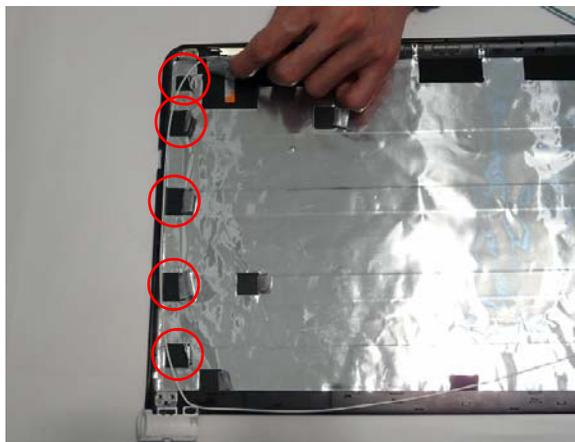

4. Remove the adhesive tape (green callout) and lift the left side Antenna from the LCD module as shown.

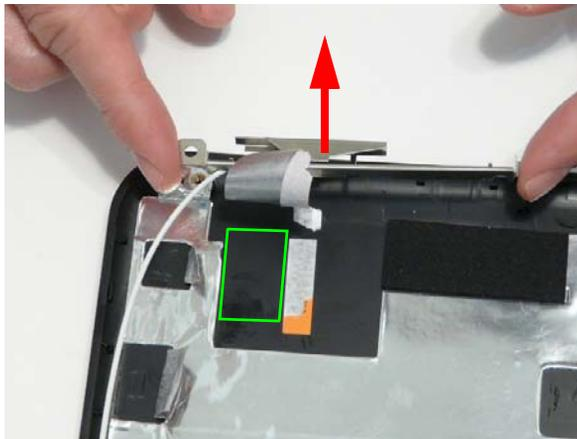

5. Remove the adhesive strips holding the right Antenna cable in place. Ensure the cable is free from obstructions.



6. Remove the adhesive tape (green callout) and lift the right side Antenna from the LCD module as shown.



LCD Module Reassembly Procedure

Replacing the Antennas, Power Board, and MIC

1. Replace the left and right antennas as shown. Ensure that the locating pin on each antenna is correctly seated. Press down on the adhesive pads (green callout) to secure the antennas in place.

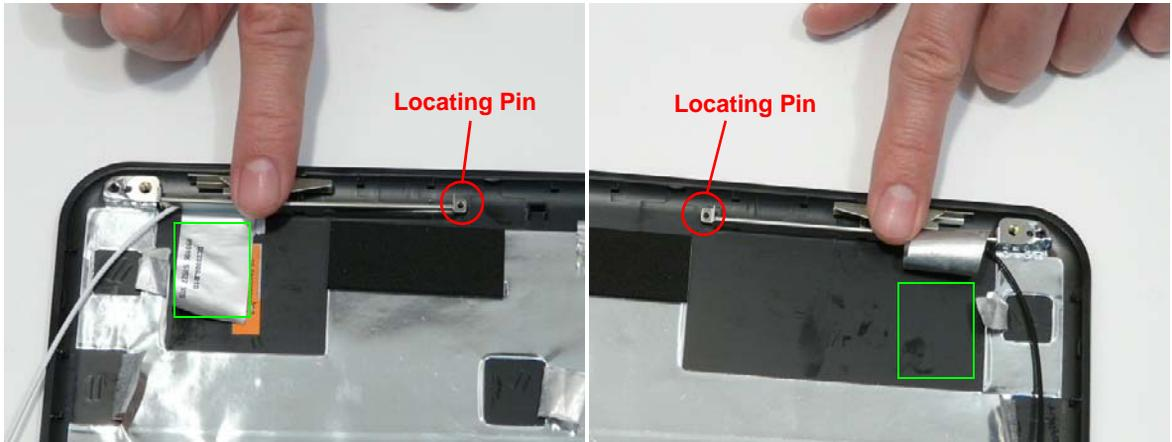

2. Replace the left antenna cable (white) as shown. Ensure that the cable is inserted along the cable channel and secured under each adhesive tab strip.

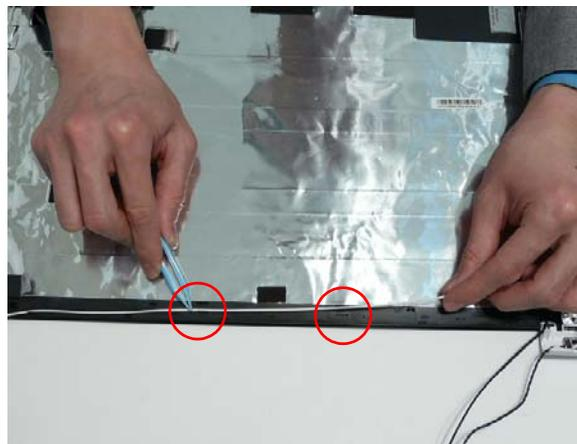
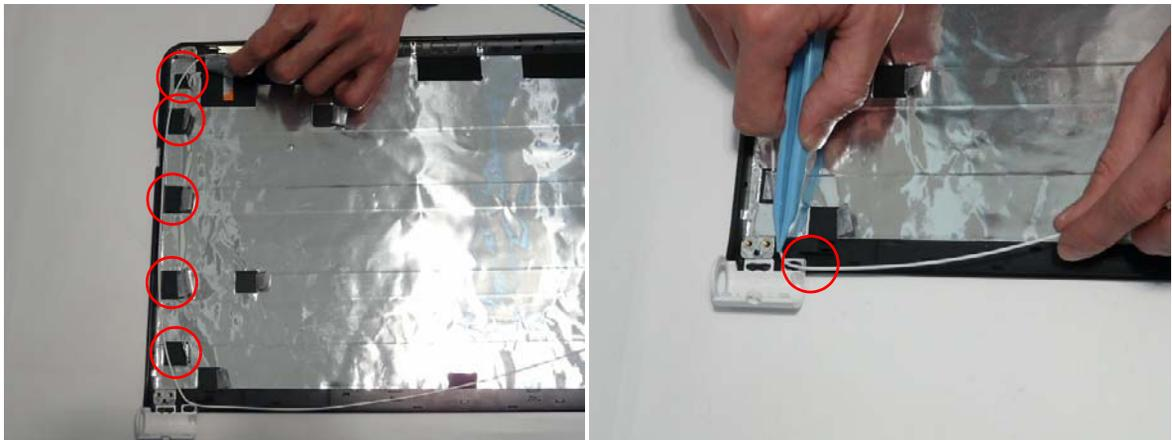

3. Replace the right antenna cable (black) as shown. Ensure that the cable is secured under each adhesive tab strip.
4. Place the Power Board in to the bracket as shown.

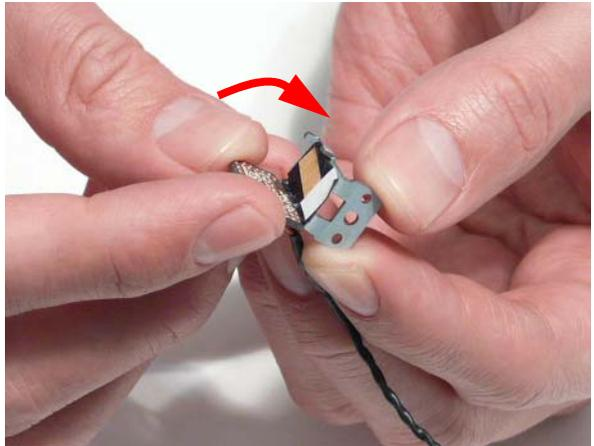
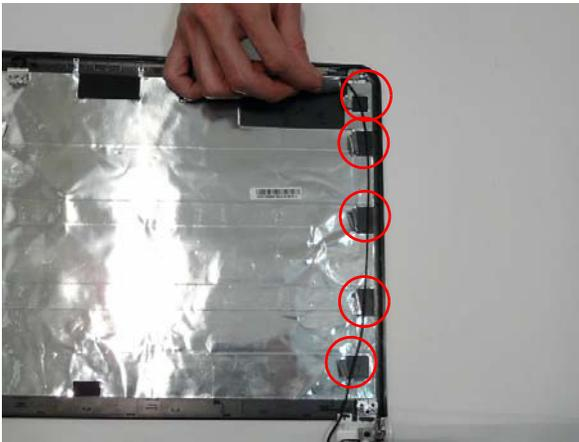

5. Place the Power Board Bracket in the LCD Module as shown.
6. Replace the single screw to secure the bracket in place.

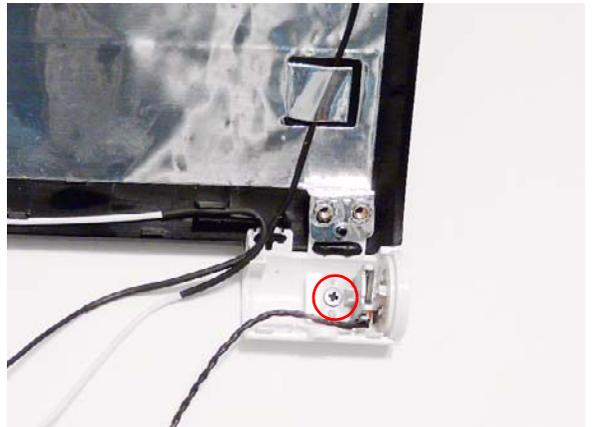
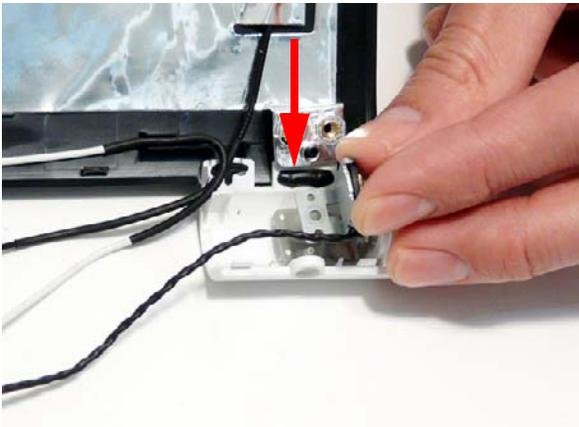

7. Place the Microphone Module in the LCD Module, as shown, and press down to secure it in place.
8. Run the cable as shown and secure it using the adhesive tabs.

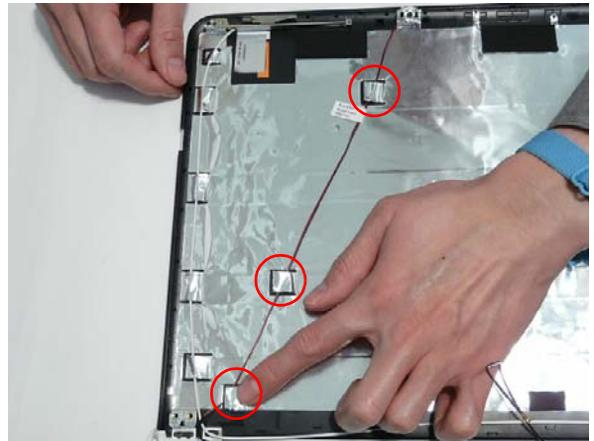

NOTE: The LCD Module appears as shown when the Antennas, Power Board, and MIC are replaced correctly.

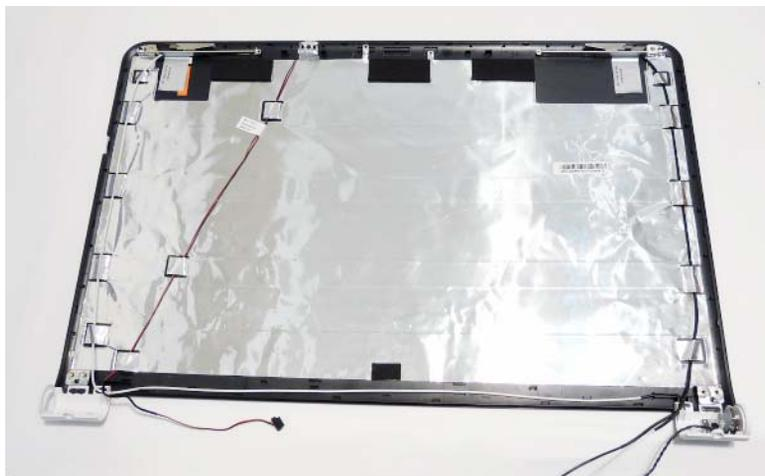

Replacing the LCD Panel

1. Align the LCD brackets with the screw holes on the panel.
2. Starting with the top most screws (marked with Δ), replace the six screws in the brackets as shown.

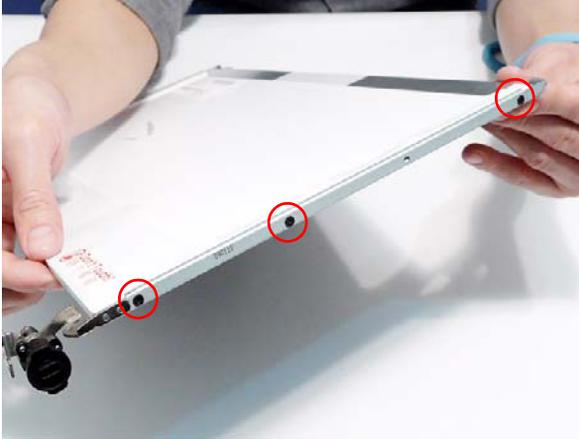

3. Insert the LCD Panel cable into the LCD Panel connector as shown.

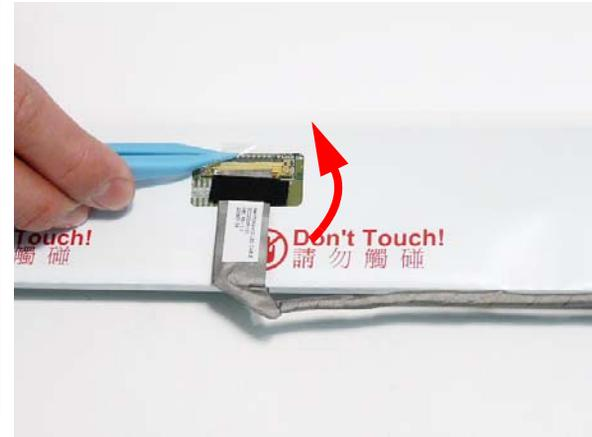
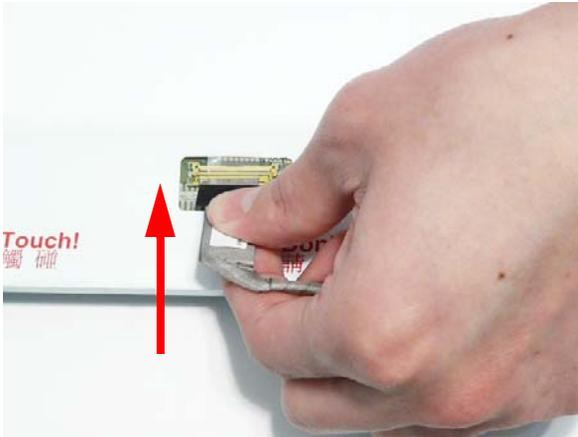

5. Replace the adhesive strip as shown.

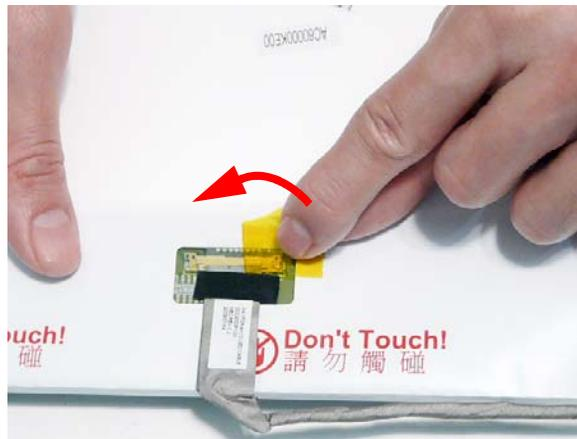

-
6. Replace the LCD cable as shown and press down along the cable's length to secure the cable to the panel.

IMPORTANT: Ensure the cable is placed between the green callouts to avoid trapping when the panel is replaced.

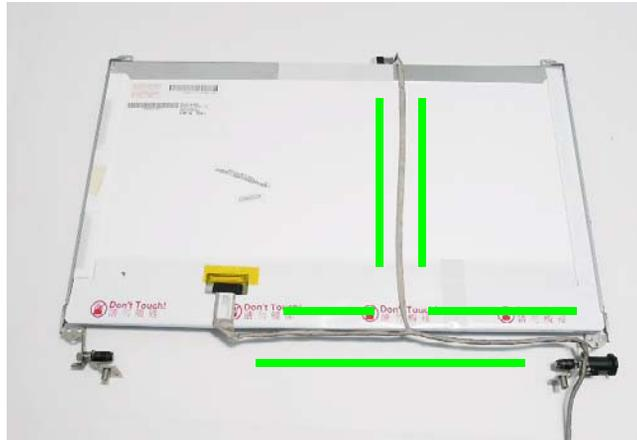

7. Place the LCD Panel in the back cover, bottom edge first, and lower it in to place as indicated.



IMPORTANT: Ensure that the LCD cables pass through the hinge wells and are not trapped under the panel.

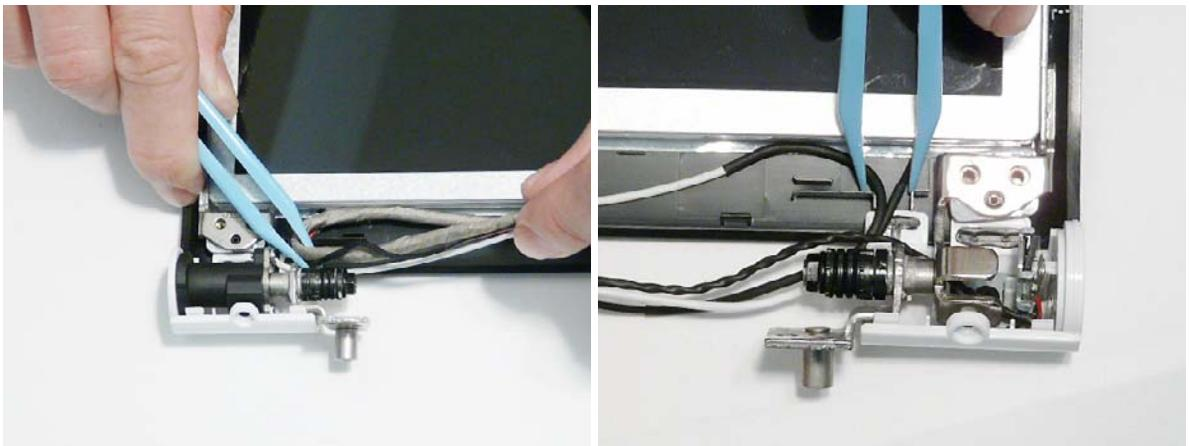

-
8. Replace the two screws to secure the panel in the LCD Module.



Replacing the Camera Module

1. Align the Camera Board with the locating pins and place the camera in the LCD Module.
2. Connect the cable to the Camera Board.

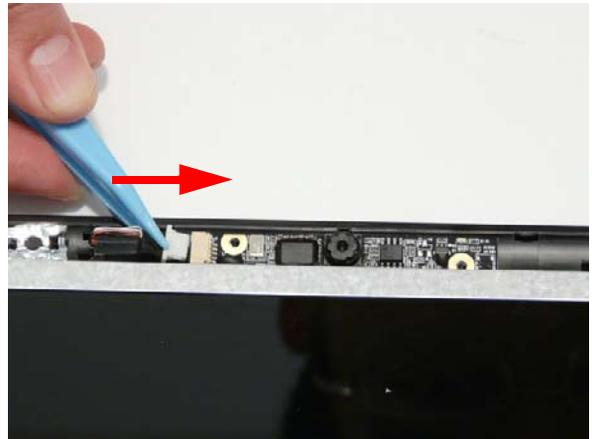
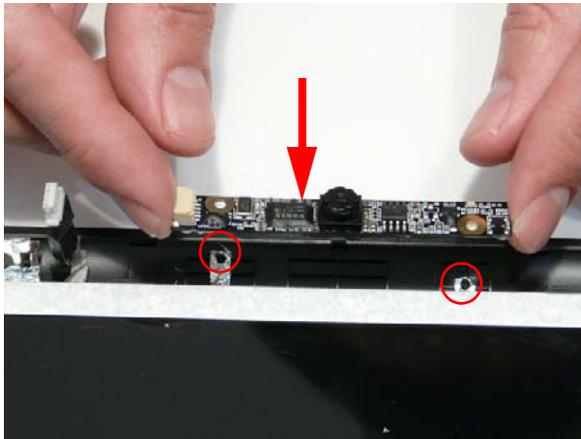

Replacing the LCD Bezel

1. Locate the bezel bottom edge first and press down until there are no gaps between the bezel and the LCD Module.

IMPORTANT: Ensure that the LCD cables pass through the hinge wells and are not trapped by the bezel.



2. Press down around the entire perimeter of the bezel until there are no gaps between the bezel and the LCD Module.

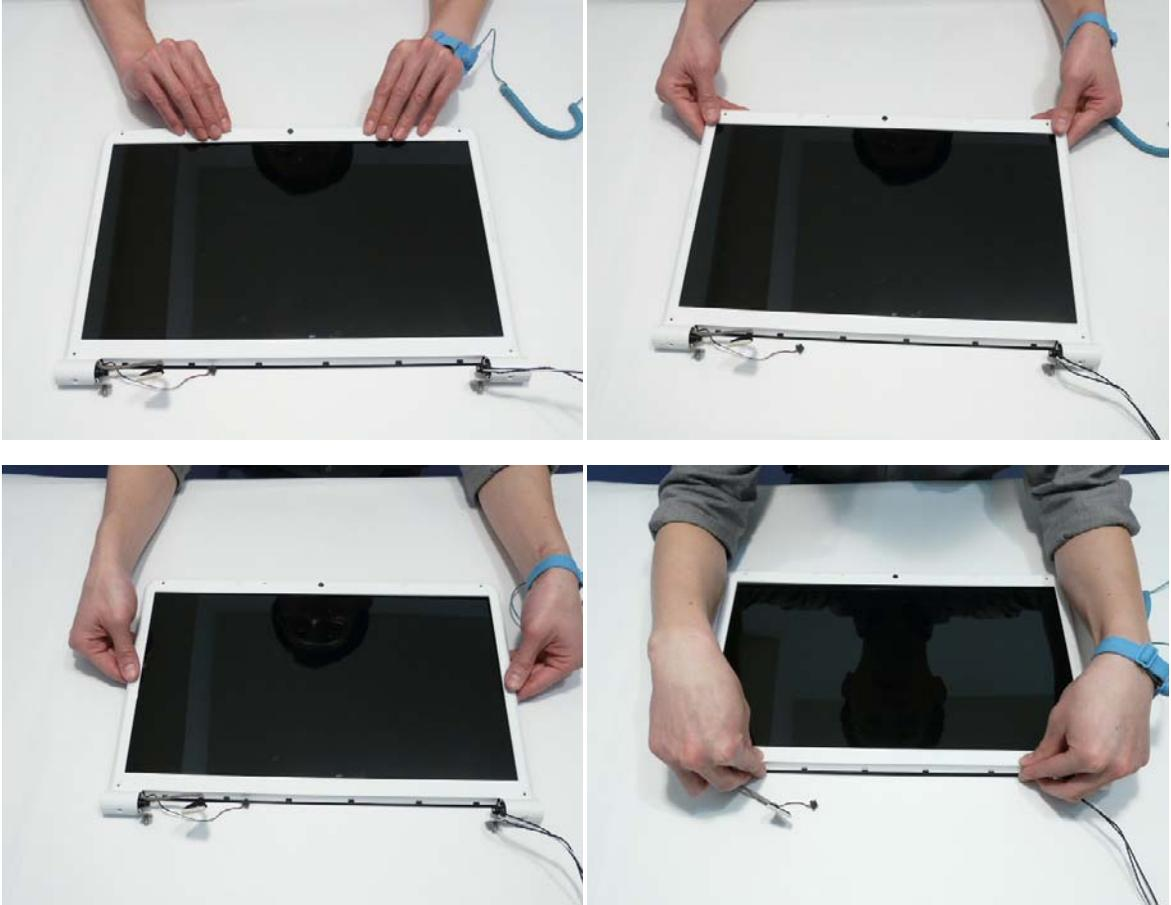

3. Replace the six screws as indicated.

NOTE: The Bezel securing screws differ in size: Red callout—M2.5*5, Green callout—M2*4.



Main Module Reassembly Procedure

Replacing the CPU

IMPORTANT: The CPU has a Pin1 locator that must be positioned corresponding to the marker on the CPU socket.

1. Place the CPU into the CPU socket as shown, taking note of the Pin1 locator.

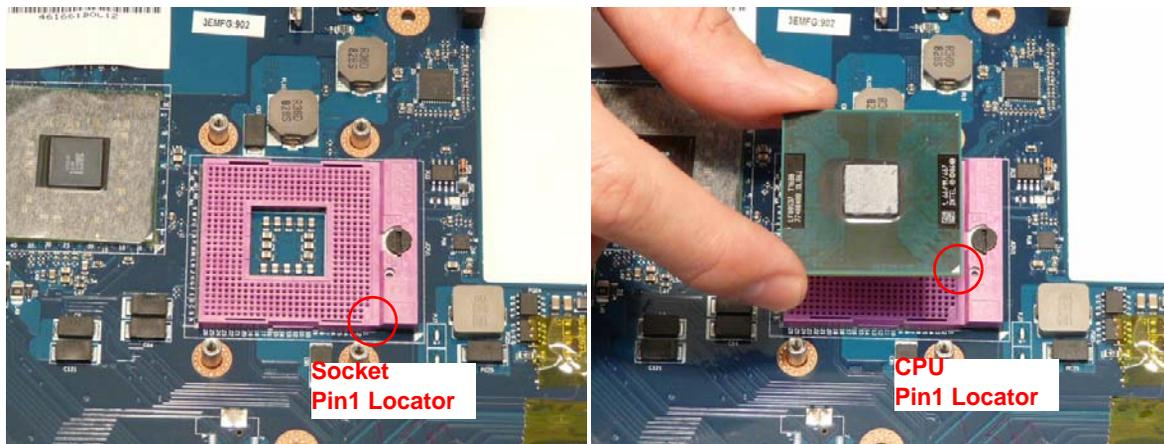

2. Using a flat-bladed screw driver, rotate the CPU locking screw 180° clockwise to secure the CPU in place.

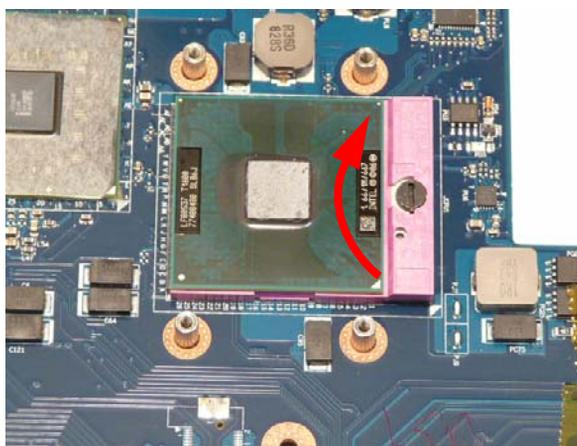

Replacing the Thermal Module

IMPORTANT: Apply a suitable thermal grease and ensure all heat pads are in place before replacing the Thermal Module.

The following thermal grease types are approved for use:

- Silmore GP50
- Honeywell PCM45F-SP
- ShinEtsu 7762

The following thermal pads are approved for use:

Eapus XR-PE

1. Remove all traces of thermal grease from the CPU using a lint-free cloth or cotton swab and Isopropyl Alcohol, Acetone, or other approved cleaning agent.
2. Apply a small amount of thermal grease to the centre of the CPU—there is no need to spread the grease manually, the force used during the installation of the Thermal Module is sufficient.

- Align the four screw holes on the Thermal Module and Mainboard and lower the module into place. Keep the module as level as possible to spread the thermal grease evenly.
- Secure the four screws (in numerical order from screw 1 to screw 4) in the Thermal Module as shown.

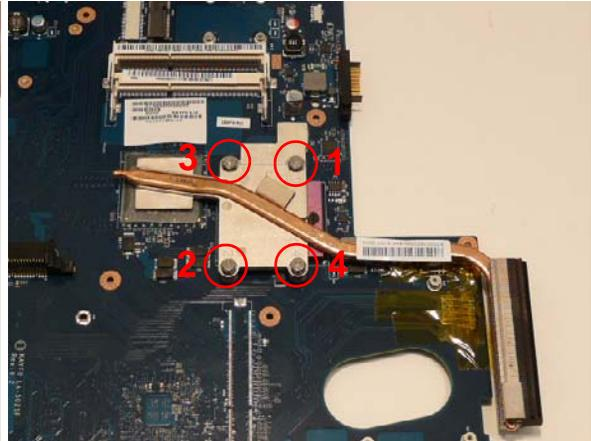

Replacing the CPU Fan

- Align the three screw holes on the CPU Fan and Mainboard and lower the module into place.
- Secure the three screws in the CPU Fan as shown.

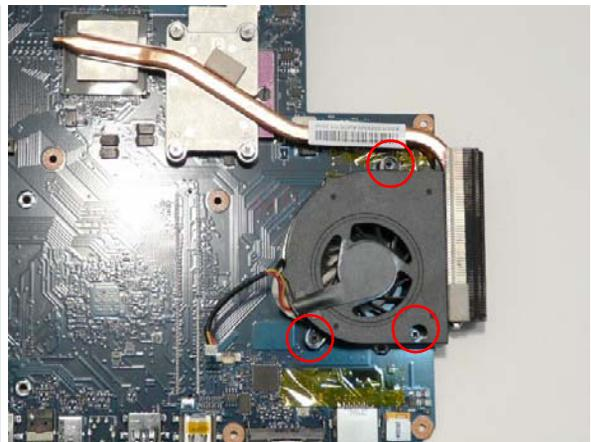
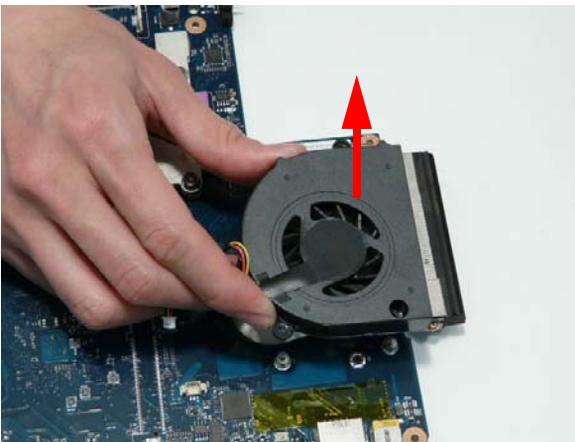

- Connect the CPU Fan power cable to the Mainboard connector as shown.

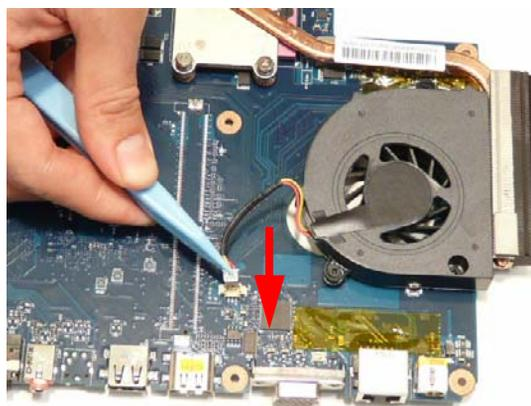

Replacing the RJ-11 Jack

1. Place the RJ-11 Jack in the Lower Cover as shown.

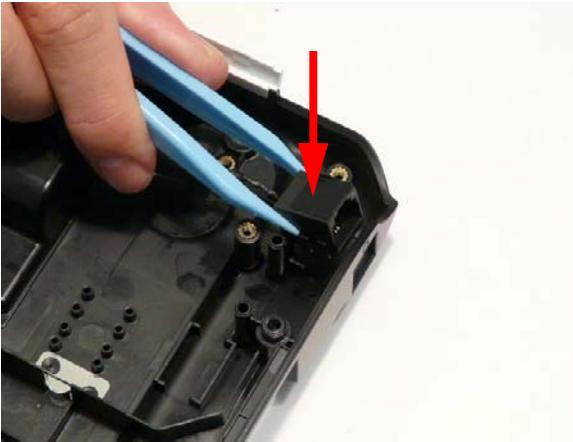

2. Replace the cable bundle and press down to secure the adhesive in place

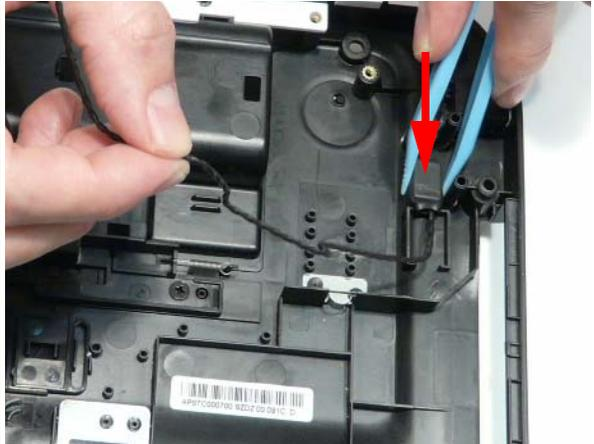

3. Run the cable along the Lower Cover as shown, using all available cable clips.

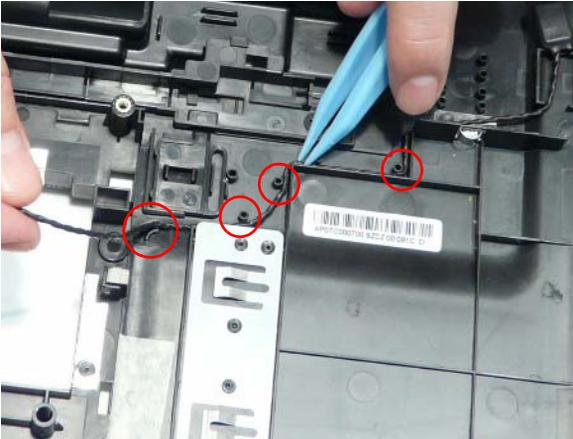

4. Secure the cable in place with an adhesive strip.

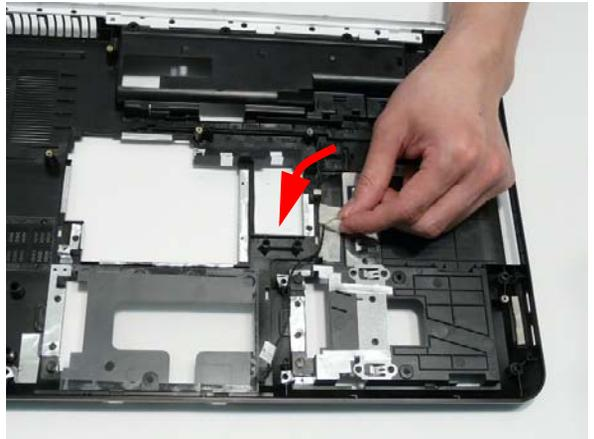

Replacing the Mainboard

1. Ensure that the Mainboard is face up (the CPU is not visible). Place the Mainboard in the chassis, left side first (1), then rotate it downward into position (2).
2. Ensure that the RJ-11 (Modem) cable is accessible when the Mainboard is replaced as shown.

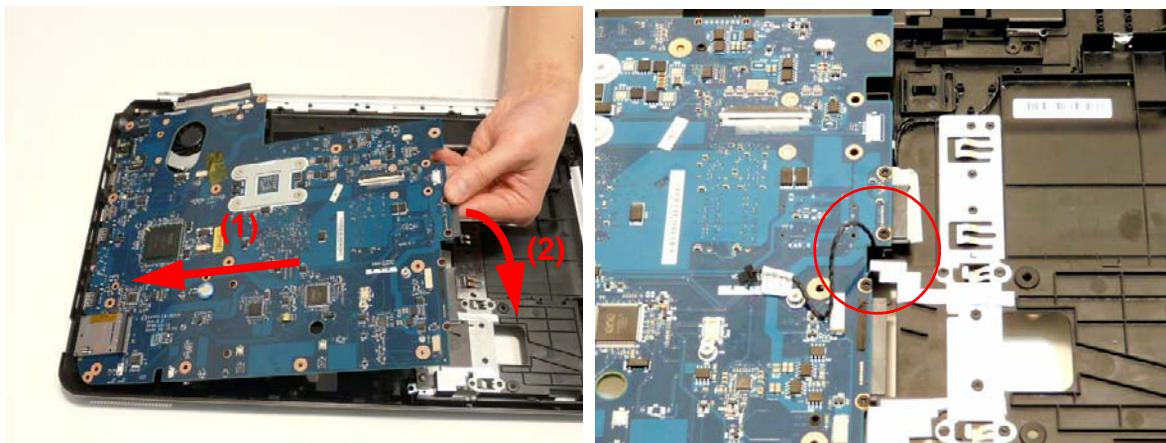

3. Replace the single securing screw in the mainboard.



Replacing the USB Board

1. Reconnect the USB Board cable to the USB Board.
2. Align the locating holes and pins on the Lower Cover and replace the USB Board.

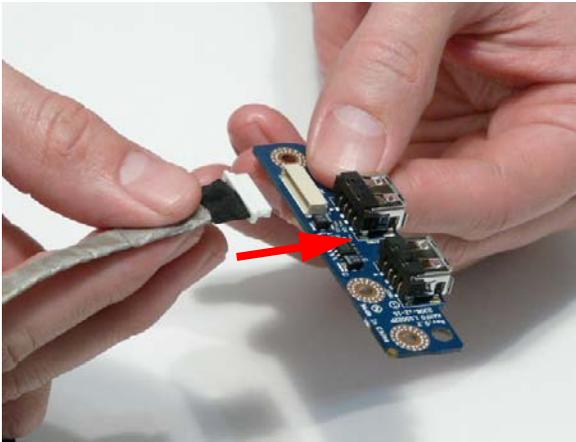

3. Replace the single screw securing the board to the Lower Cover.
4. Replace the cable in the cable channel as shown and press down to secure it in place.

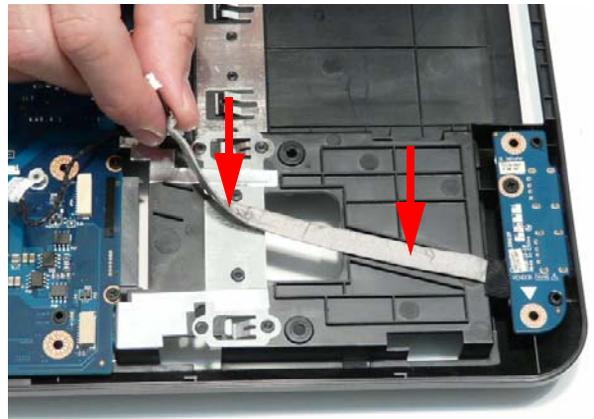

5. Reconnect the USB cable to the USB Board.



Replacing the Modem Board

1. Reconnect the RJ-11 cable to the Modem Board.
2. Align the screw holes on the Modem and Lower Cover and replace the board.

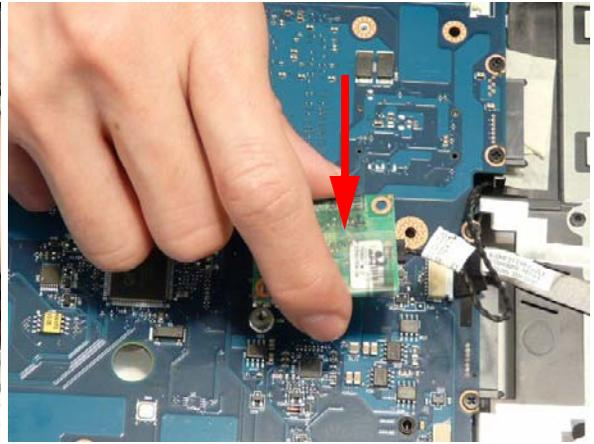
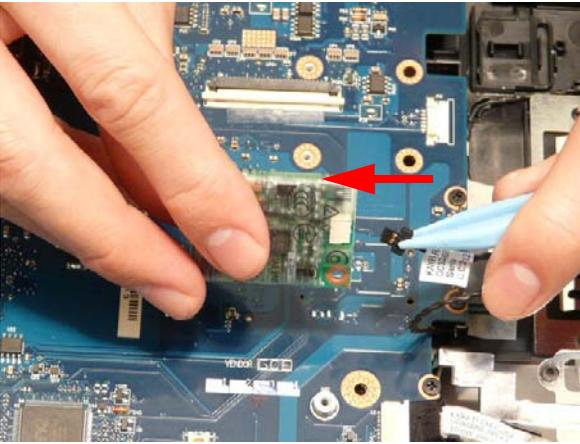

3. Secure the cable in place with adhesive tape.
4. Press down as indicated to connect the board-to-board interface.

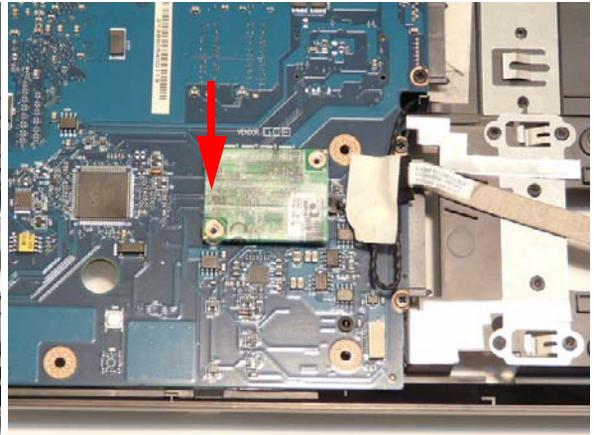
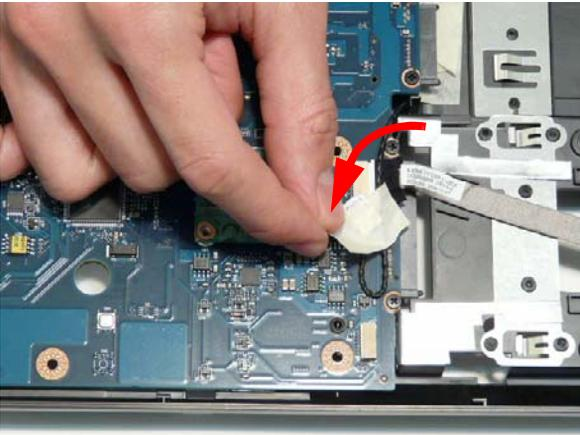

5. Secure the Modem Board to the Mainboard with two screws.

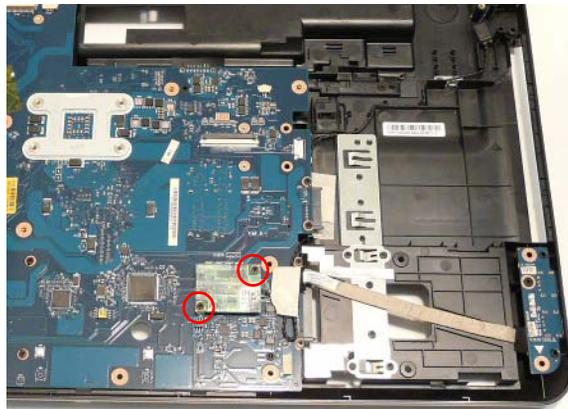

Replacing the Speaker Module

1. Place the left Speaker Module in the chassis as shown, ensuring that the locating pins are seated correctly.

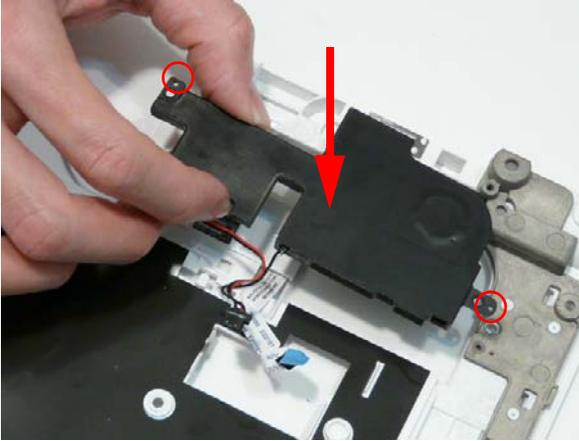

2. Lift the mylar sheet away from the Upper Cover and run the Speaker cable along the Upper Cover using all available cable clips.

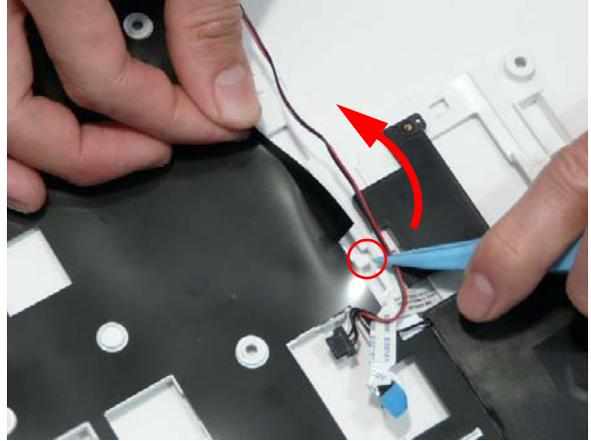

3. Continue running the cable along the Upper Cover using all available cable clips.

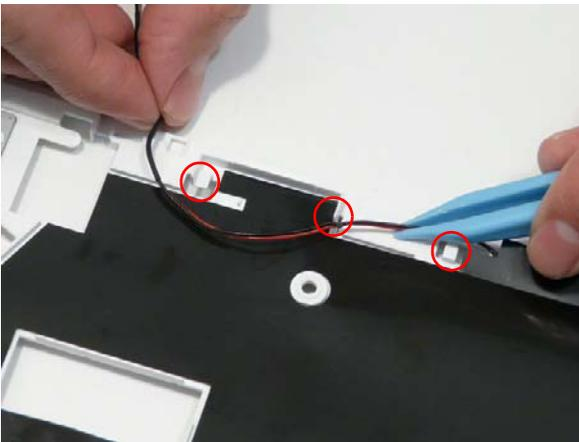

4. Place the right Speaker Module in the chassis as shown, ensuring that the locating pins are seated correctly.

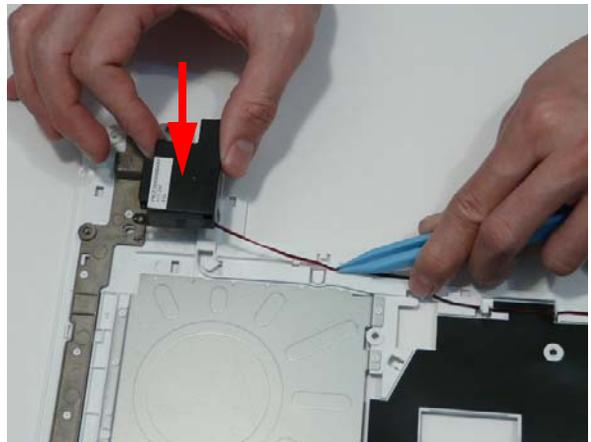

5. Replace the four securing screws.

NOTE: Ensure that the Speaker cable runs as shown in the image below to avoid trapping when the Upper Cover is replaced.

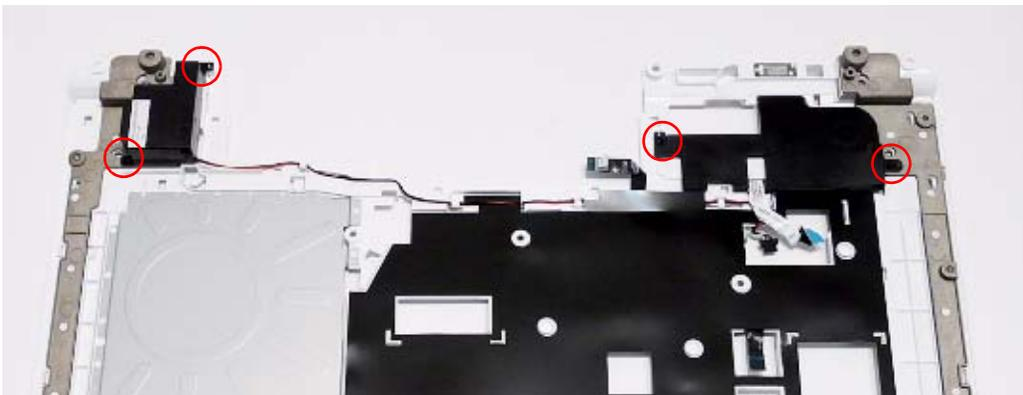

Replacing the LED Board

1. Pass the LED Board FFC through the Upper Cover as shown.
2. Place the LED Board in the Upper Cover and press down as indicated to secure the board in place.

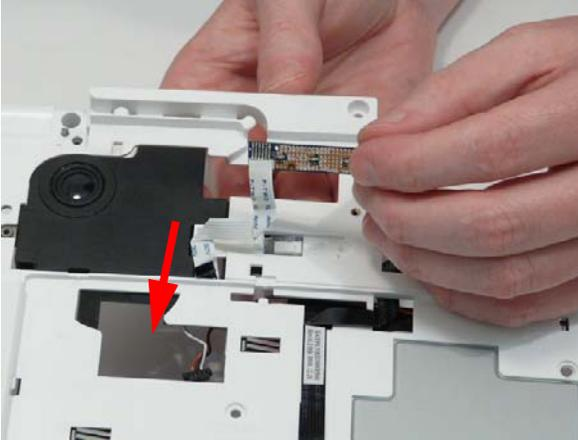

Replacing the Media Board FFC

1. Place the Media Board FFC on the Upper Cover as shown, and press down to secure the adhesive in place.
2. Pass the upper end of the cable through the Upper Cover as shown.

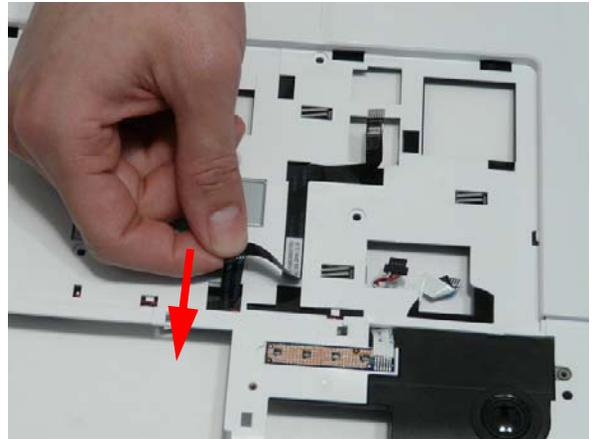
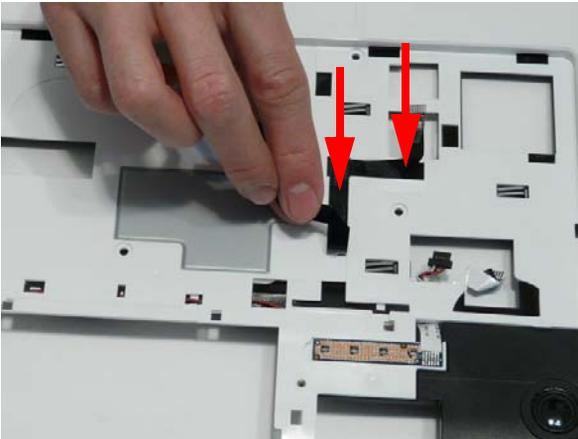

Replacing the TouchPad Bracket

1. Replace the TouchPad Bracket bottom edge first to engage the securing clips (1). Rotate the bracket on to the Upper Cover and press down as indicated (2).
2. Secure the bracket to the Upper Cover with a single screw.

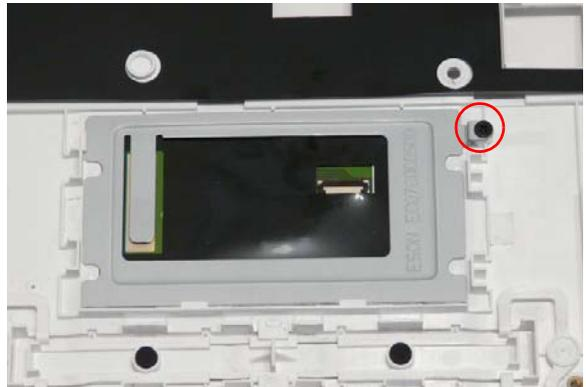
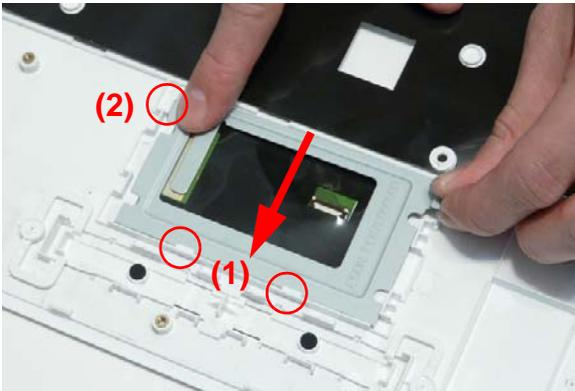

3. Insert the TouchPad FFC in to the connector as shown.
4. Close the FFC locking latch to secure the cable in place.

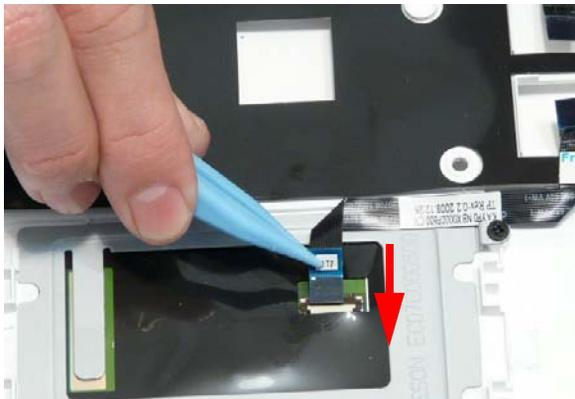

Replacing the Upper Cover

1. Place the upper cover on the lower cover front edge first and lower the cover into position.



2. Press down around the front and sides to secure the Upper Cover in place.
NOTE: Ensure that there are no gaps between the Upper and Lower Covers.

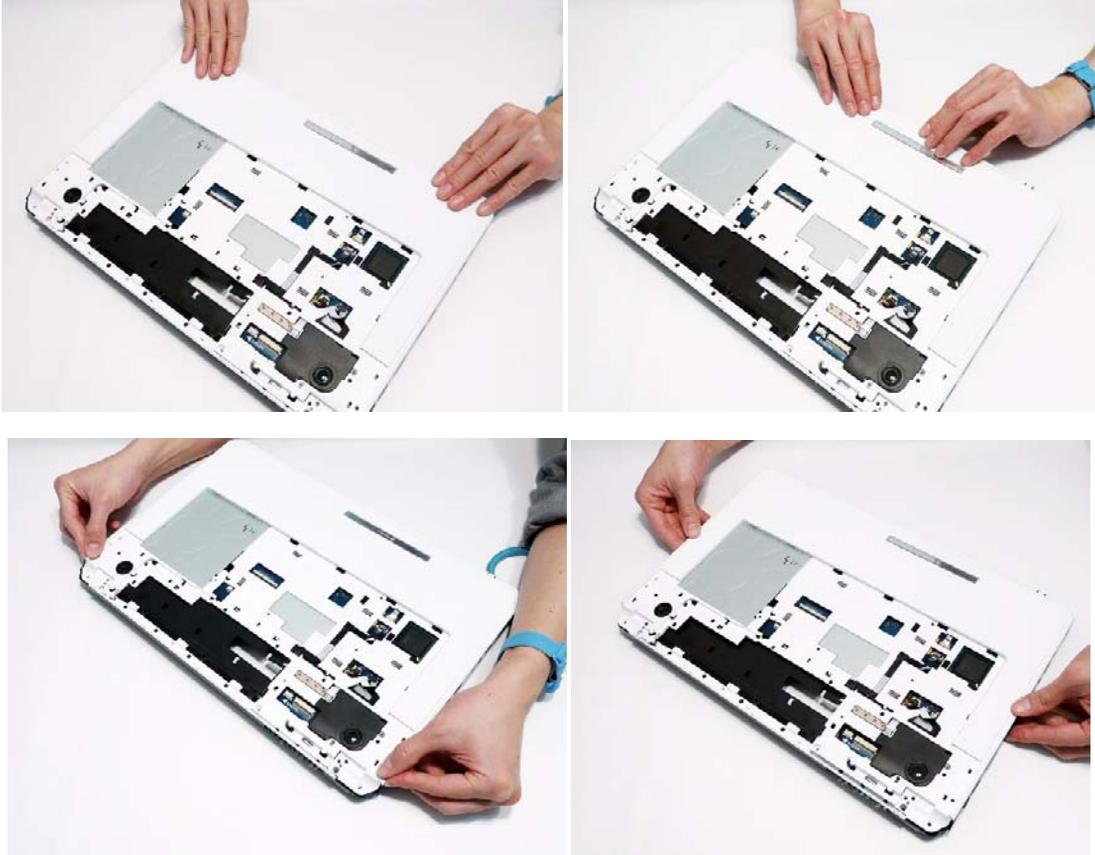

3. Reconnect the following cables as shown.



4. Connect A as shown.

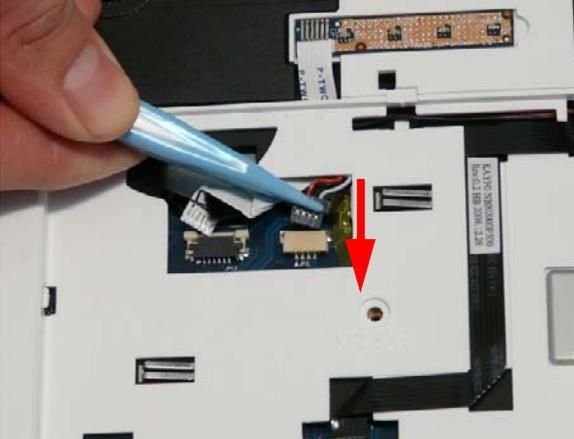

5. Insert B as shown and close the locking latch.

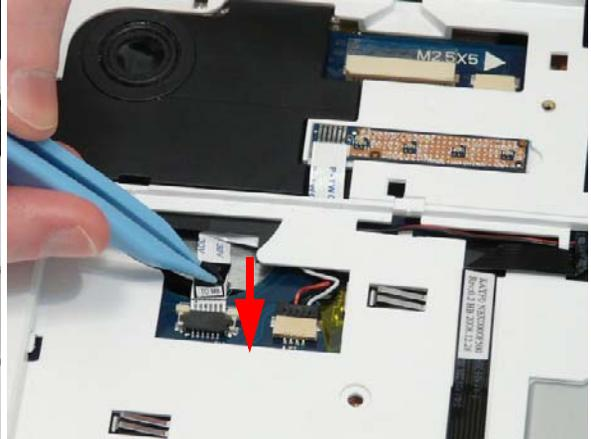

6. Insert C as shown and close the locking latch.

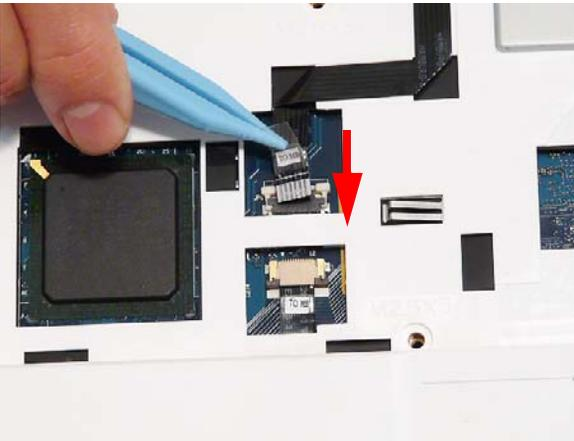

7. Insert D as shown and close the locking latch.

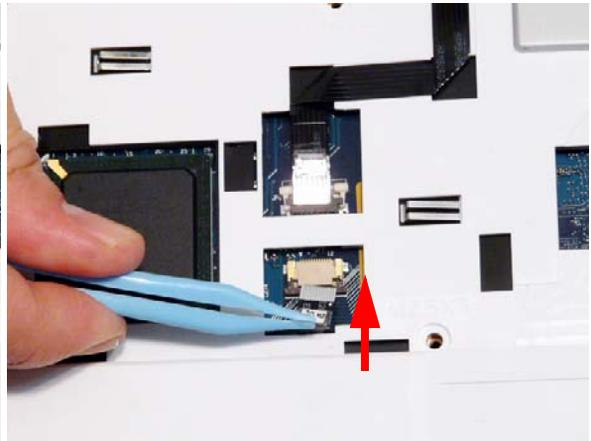

8. Secure cables A and B in place using adhesive tape.

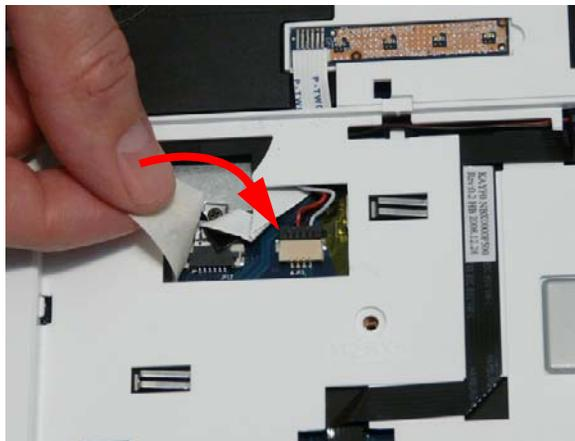

9. Replace the nine screws in the upper cover as shown.

NOTE: The securing screws differ in size: Red callout—M2.5*5, Blue callout—M2.5*3.

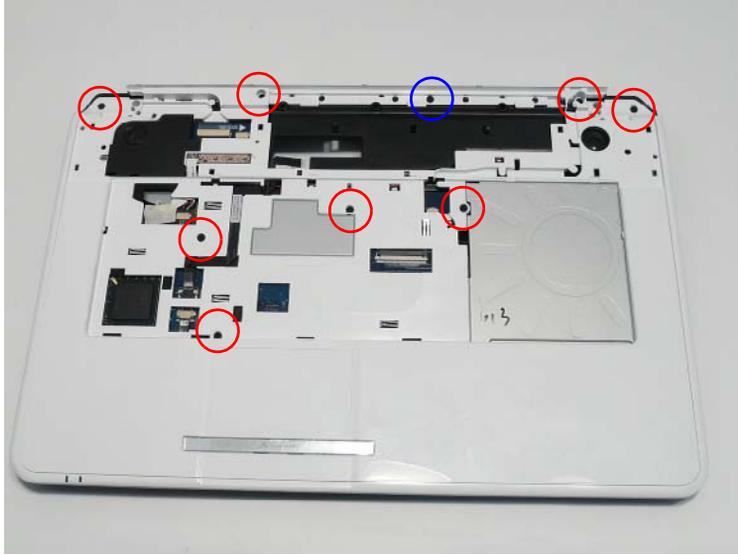

10. Turn the computer over and replace the thirteen screws as shown.

NOTE: The securing screws differ in size: Red callout—M2.5*8, Green callout—M2.5*5, Blue callout—M2.5*3.

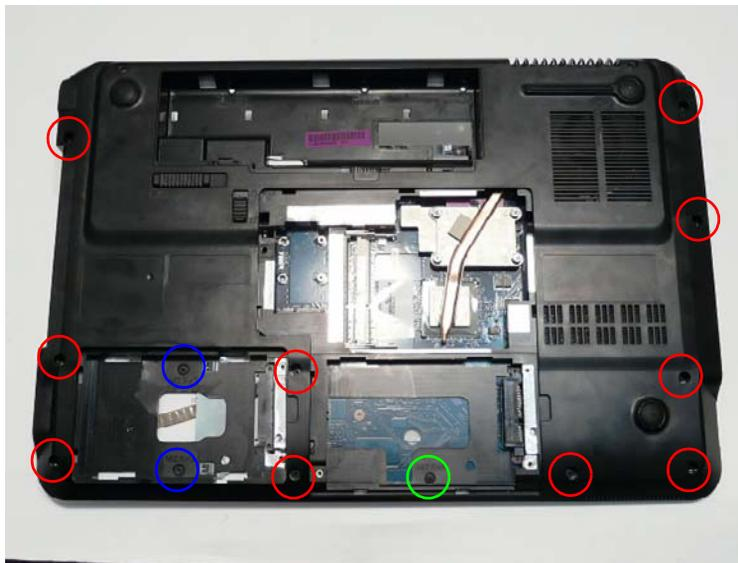

Replacing the LCD Module

1. Turn the computer over. Align the LCD hinges with the lower cover and replace the LCD module.

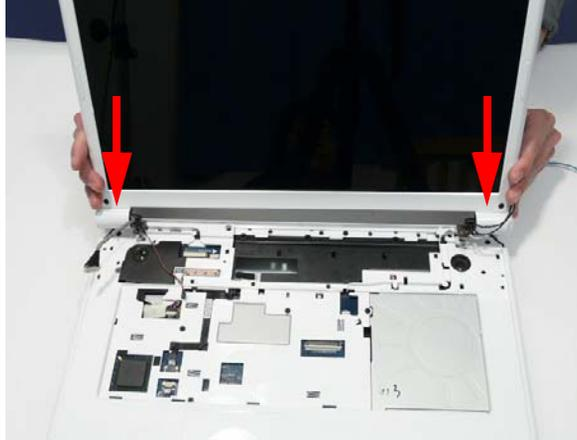

2. Replace the four securing screws (two each side), starting with the left side hinge. Ensure that the LCD cables are not trapped in the hinges.

NOTE: The securing screws differ in size: Red callout—M2.5*8, Green callout—M2.5*5.



3. Run the MIC cable along the cable channel as shown, using all the available cable clips.

4. Reconnect the MIC cable to the Mainboard as shown.

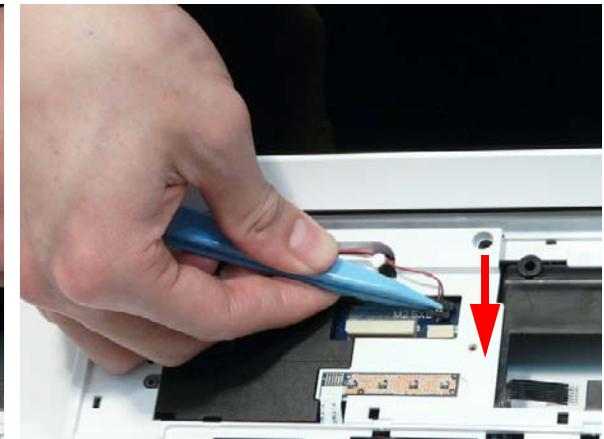
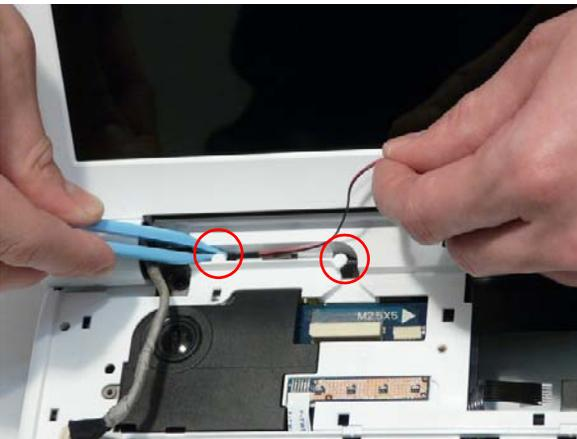

5. Run the LVDS cable along the cable channel as shown, using all the available cable clips.

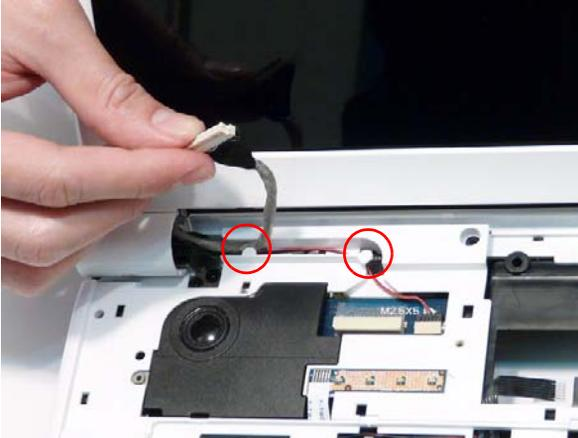

6. Reconnect the LVDS cable to the Mainboard as shown.

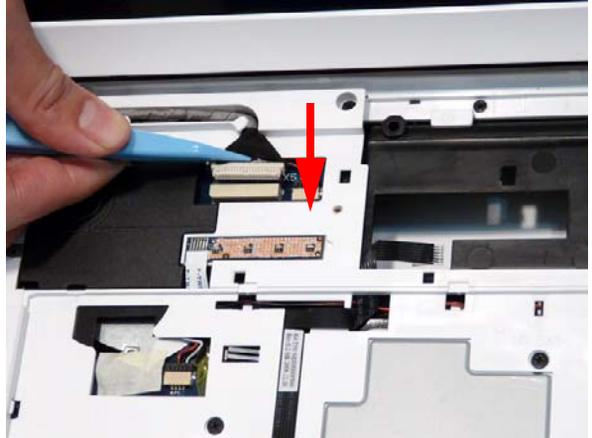

7. Run the Power Board cable along the cable channel using all available cable clips.

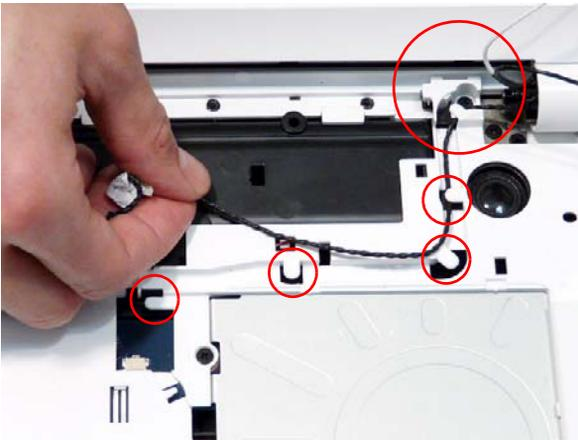

8. Connect the Power Board cable to the Mainboard as shown.

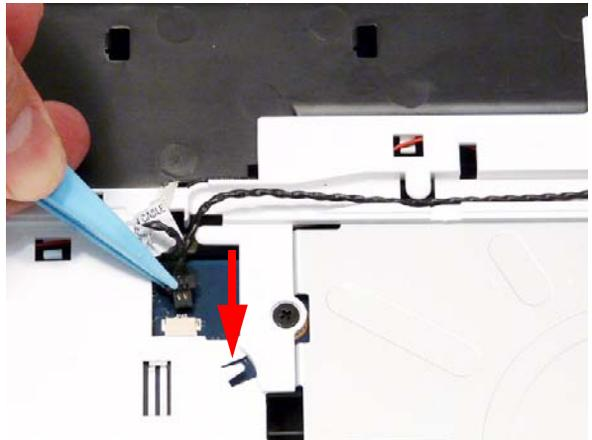

9. Run the Antenna cables along the cable channel using all available cable clips.

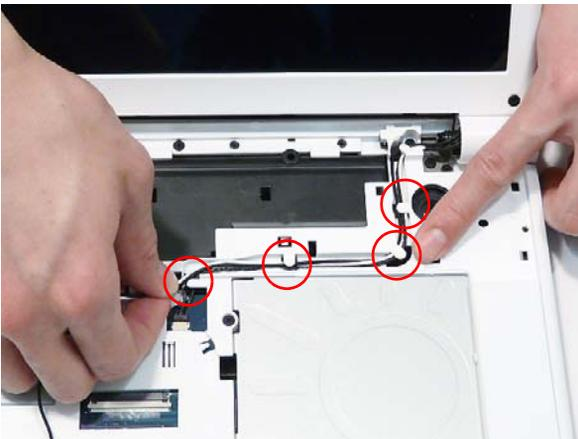

10. Insert the Antenna cables through the chassis as shown.

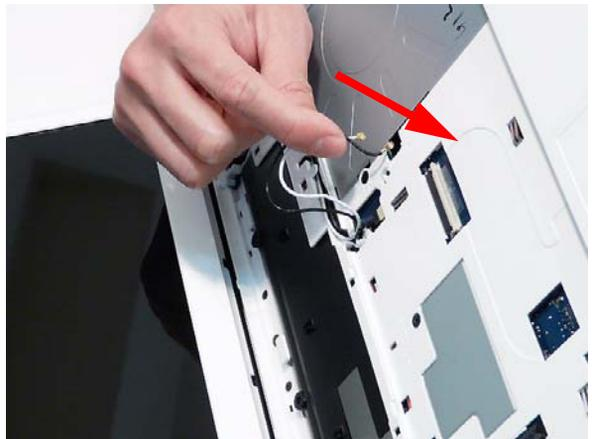

11. Pull the Antennas completely through from the under side of the computer.



12. Secure the cables in place with adhesive tape.

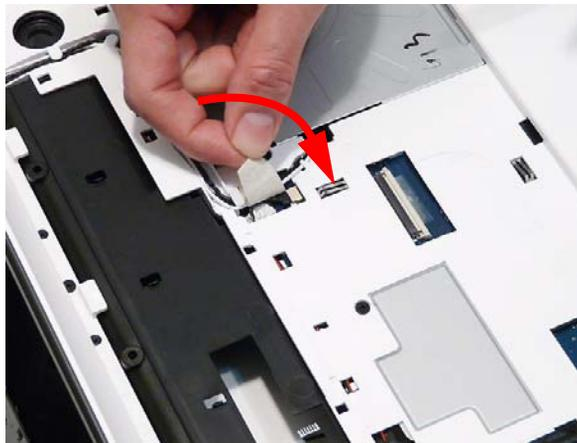

13. Replace the two securing screws.

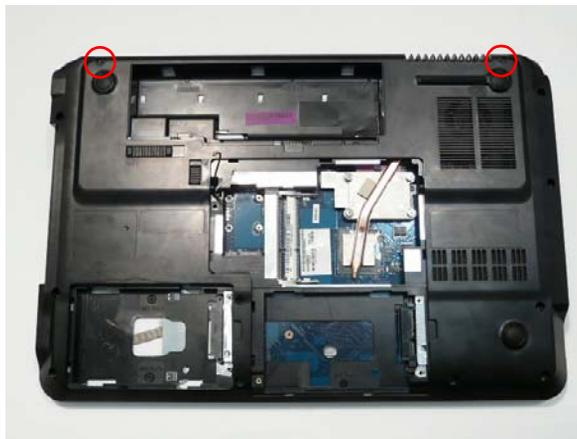

Replacing the Keyboard

1. Place the Keyboard face down on the TouchPad area. Reconnect the FFC as shown.
2. Close the FFC locking latch to secure the cable in place.

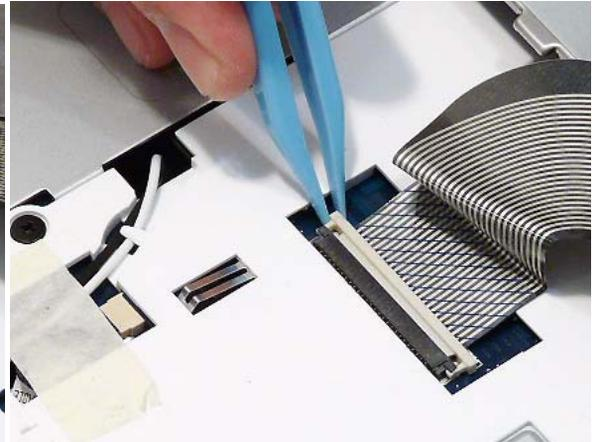
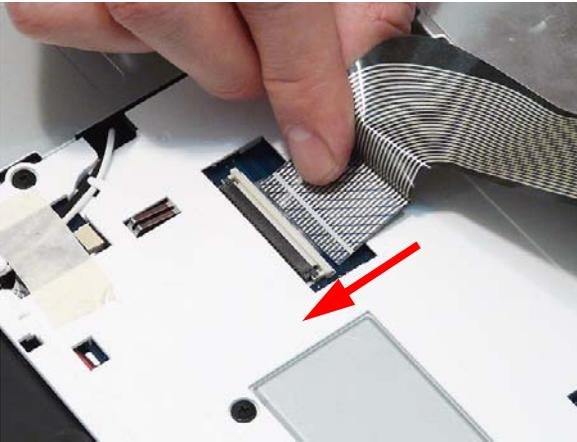

3. Turn the keyboard over and insert it front edge first into the chassis.
4. Press down as indicated to seat the Keyboard.

NOTE: Ensure that the six locating tabs are correctly seated.

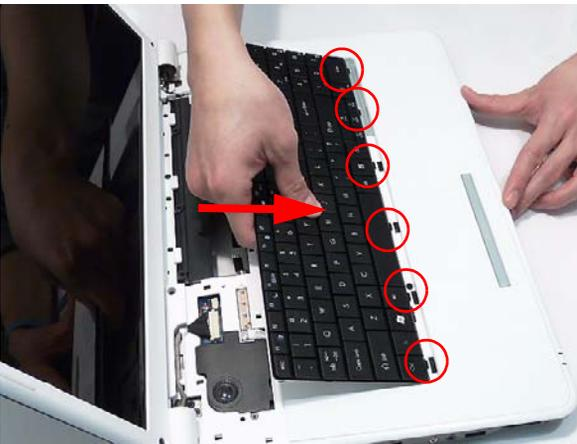

Replacing the Media Board

1. Align the Media Board with the transparent pane on the Switch Cover.
2. Press the Media Board down to secure it in place with adhesive.

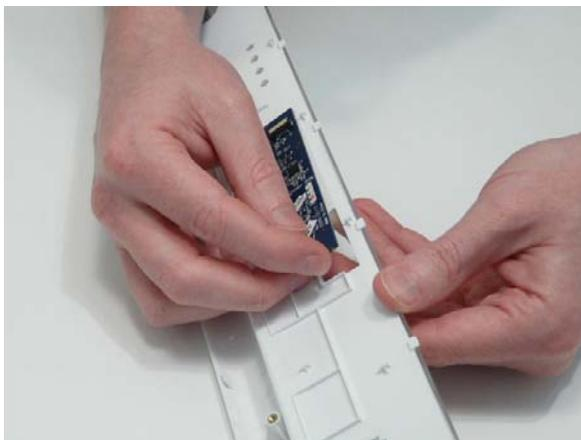

Replacing the Switch Cover

1. Place the Switch Cover rear edge first on to the Upper Cover. Rotate the Switch Cover downward on the Keyboard.



2. Press down the edges of the cover to snap it into place, then press the centre down until it snaps in to place.



3. Turn the computer over and replace the three securing screws as shown.

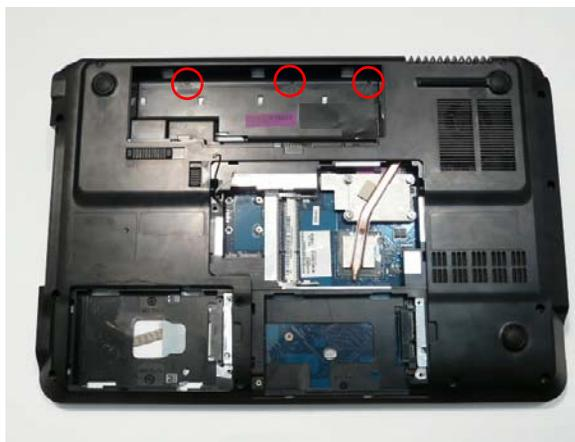

4. Lift the Media Board FFC cover as shown to expose the FFC connector.



5. Connect the FFC to the Media Board as shown.

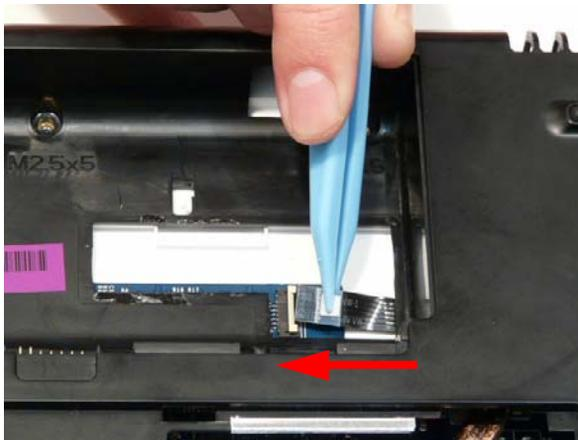

6. Close the FFC locking latch to secure the FFC in place.

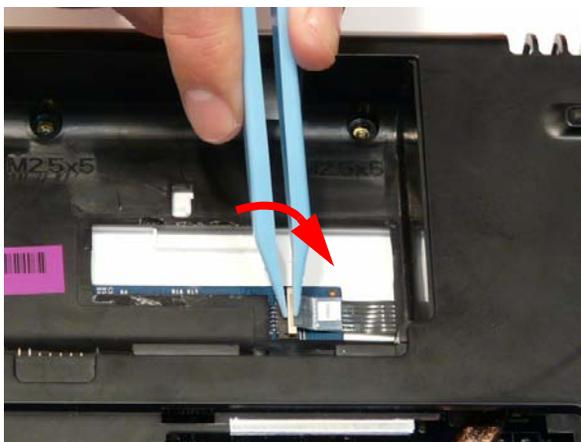

7. Replace the Media Board FFC cover.



Replacing the Hard Disk Drive Modules

1. Place the HDD in the HDD carrier.
2. Replace the four screws (two each side) to secure the carrier.

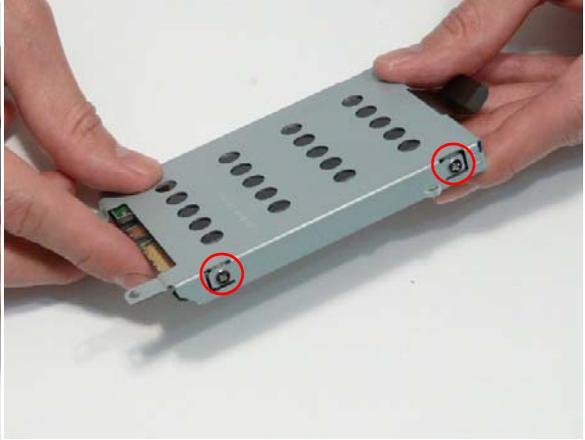

3. Insert the Secondary HDD, right side first, and lower it into place.
4. Slide the Secondary HDD to the right to connect the interface.

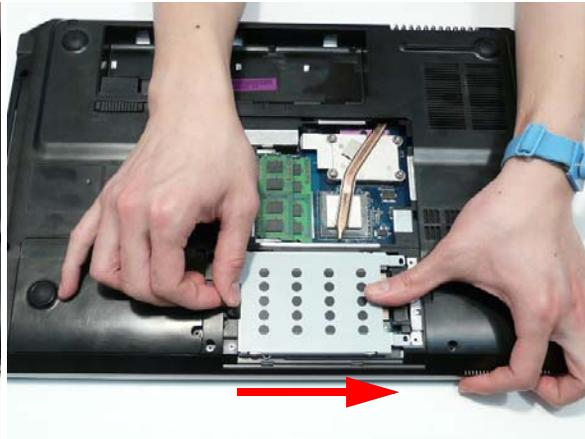

5. Insert the Primary HDD, right side first, and lower it into place. Slide the Primary HDD to the right to connect the interface.



Replacing the WLAN Module

1. Insert the WLAN Module into the WLAN socket.
2. Replace the single screw to secure the module.

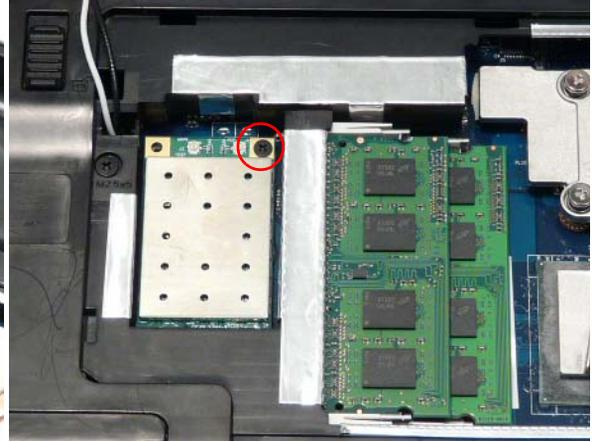
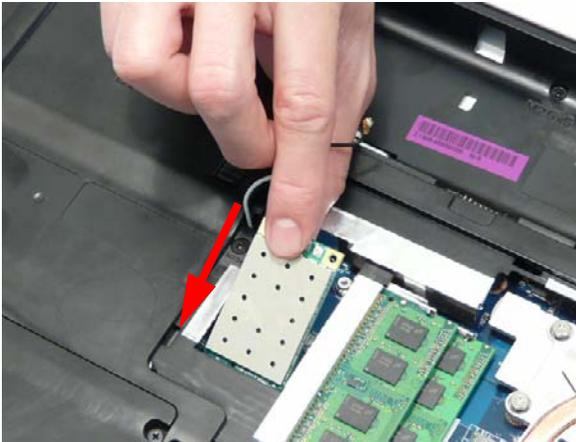

3. Connect the two antenna cables to the module.
4. After connecting the cables to the terminals, secure the cables in place using adhesive tape.

NOTE: Cable placement is **Black** to the **MAIN** terminal (left) and **White** to the **AUX** terminal (right).



Replacing the DIMM Modules

1. Insert the DIMM Module in place.
2. Press down to lock the DIMM module in place.

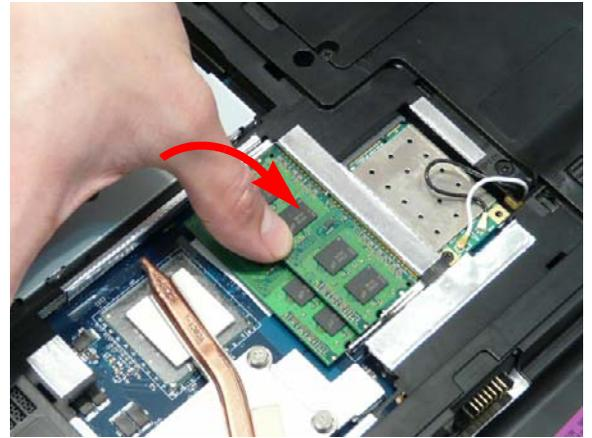
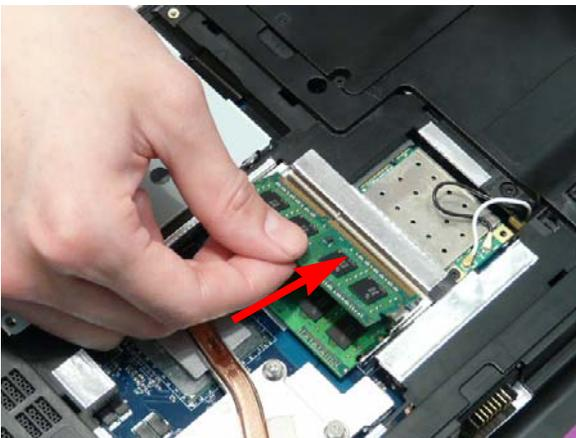

Replacing the ODD Module

1. Press the bezel into the tray, bottom edge first, to secure it to the ODD Module.
2. Secure the ODD bracket with the two screws.



3. Push the ODD Module into the ODD bay until it is flush with the casing.
4. Replace the single screw to secure the Module.



Replacing the Lower Covers

1. Replace the HDD2, WLAN, and Memory Cover back edge first as shown.



2. Replace the HDD1 Cover as shown.



IMPORTANT: Press down around the perimeter of the covers to ensure that all the securing tabs are correctly located in the casing.

3. Secure the five captive screws to hold the covers in place.

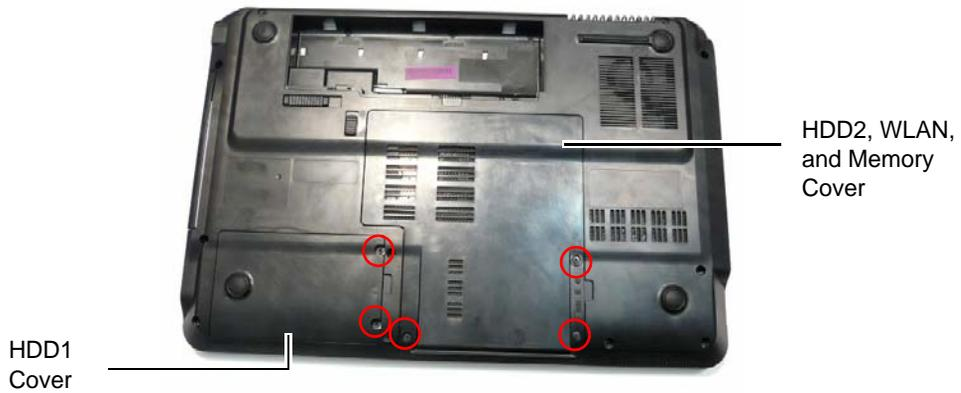

Replacing the SD Dummy Card

1. Insert the SD Dummy Card into the slot and push until the card clicks into place and is flush with the casing.



Replacing the Battery

1. Slide and hold the battery release latch to the release position (1), insert the battery pack and press down (2).
2. Slide the battery lock in the direction shown to secure the battery in place.



Troubleshooting

Common Problems

Use the following procedure as a guide for computer problems.

NOTE: The diagnostic tests are intended to test only Acer products. Non-Acer products, prototype cards, or modified options can give false errors and invalid system responses.

1. Obtain the failing symptoms in as much detail as possible.
2. Verify the symptoms by attempting to re-create the failure by running the diagnostic test or by repeating the same operation.
3. Use the following table with the verified symptom to determine which page to go to.

Symptoms (Verified)	Go To
Power On Issue	Page 134
No Display Issue	Page 135
LCD Failure	Page 137
Internal Keyboard Failure	Page 137
TouchPad Failure	Page 138
Internal Speaker Failure	Page 138
Internal Microphone Failure	Page 140
ODD Failure	Page 142
Modem Failure	Page 145
WLAN Failure	Page 146
Thermal Unit Failure	Page 148
Other Functions Failure	Page 149
Intermittent Failures	Page 150
Undermined Failures	Page 150

4. If the Issue is still not resolved, see "Online Support Information" on page 187.

Power On Issue

If the system doesn't power on, perform the following actions one at a time to correct the problem. Do not replace a non-defective FRUs:

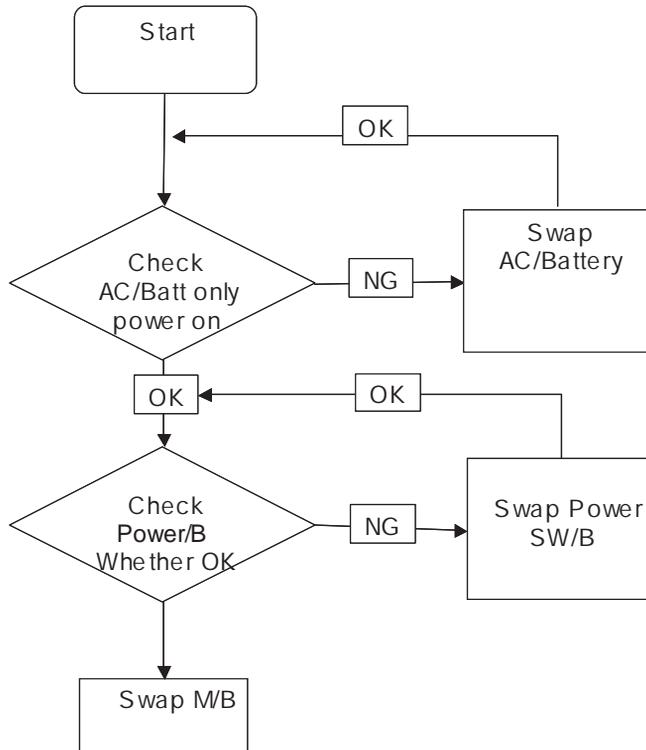

Computer Shutdown Intermittently

If the system powers off at intervals, perform the following actions one at a time to correct the problem.

1. Check the power cable is properly connected to the computer and the electrical outlet.
2. Remove any extension cables between the computer and the outlet.
3. Remove any surge protectors between the computer and the electrical outlet. Plug the computer directly into a known good electrical outlet.
4. Disconnect the power and open the casing to check the Thermal Unit (see "Thermal Unit Failure" on page 148) and fan airways are free of obstructions.
5. Remove all external and non-essential hardware connected to the computer that are not necessary to boot the computer to the failure point.
6. Remove any recently installed software.
7. If the Issue is still not resolved, see "Online Support Information" on page 187.

No Display Issue

If the **Display** doesn't work, perform the following actions one at a time to correct the problem. Do not replace a non-defective FRUs:

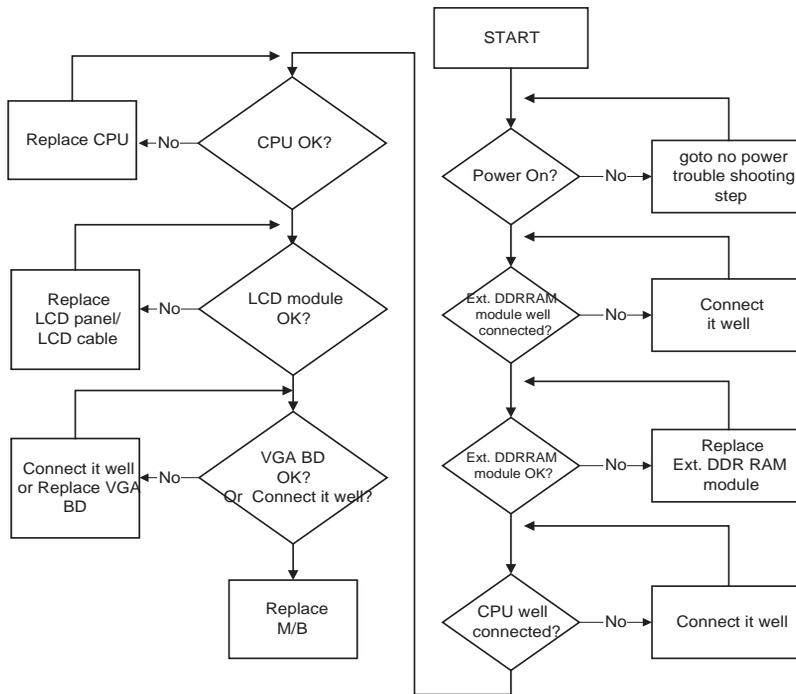

No POST or Video

If the POST or video doesn't display, perform the following actions one at a time to correct the problem.

1. Make sure that the internal display is selected. On this notebook model, switching between the internal display and the external display is done by pressing **Fn+F5**. Reference Product pages for specific model procedures.
2. Make sure the computer has power by checking at least one of the following occurs:
 - Fans start up
 - Status LEDs light up

If there is no power, see "Power On Issue" on page 134.

3. Drain any stored power by removing the power cable and battery and holding down the power button for 10 seconds. Reconnect the power and reboot the computer.
4. Connect an external monitor to the computer and switch between the internal display and the external display is by pressing **Fn+F5** (on this model).

If the POST or video appears on the external display, see "LCD Failure" on page 137.

5. Disconnect power and all external devices including port replicators or docking stations. Remove any memory cards and CD/DVD discs. Restart the computer.
If the computer boots correctly, add the devices one by one until the failure point is discovered.
6. Reseat the memory modules.
7. Remove the drives (see "Disassembly Process" on page 44).
8. If the Issue is still not resolved, see "Online Support Information" on page 187.

Abnormal Video Display

If video displays abnormally, perform the following actions one at a time to correct the problem.

1. Reboot the computer.
2. If permanent vertical/horizontal lines or dark spots display in the same location, the LCD is faulty and should be replaced. See "Disassembly Process" on page 44.
3. If extensive pixel damage is present (different colored spots in the same locations on the screen), the LCD is faulty and should be replaced. See "Disassembly Process" on page 44.
4. Adjust the brightness to its highest level. See the User Manual for instructions on adjusting settings.
NOTE: Ensure that the computer is not running on battery alone as this may reduce display brightness.
If the display is too dim at the highest brightness setting, the LCD is faulty and should be replaced. See "Disassembly Process" on page 44.
5. Check the display resolution is correctly configured:
 - a. Minimize or close all Windows.
 - b. If display size is only abnormal in an application, check the view settings and control/mouse wheel zoom feature in the application.
 - c. If desktop display resolution is not normal, right-click on the desktop and select **Personalize**→ **Display Settings**.
 - d. Click and drag the Resolution slider to the desired resolution.
 - e. Click **Apply** and check the display. Readjust if necessary.
6. Roll back the video driver to the previous version if updated.
7. Remove and reinstall the video driver.
8. Check the Device Manager to determine that:
 - The device is properly installed. There are no red Xs or yellow exclamation marks.
 - There are no device conflicts.
 - No hardware is listed under Other Devices.
9. If the Issue is still not resolved, see "Online Support Information" on page 187.
10. Run the Windows Memory Diagnostic from the operating system DVD and follow the onscreen prompts.
11. If the Issue is still not resolved, see "Online Support Information" on page 187.

Random Loss of BIOS Settings

If the computer is experiencing intermittent loss of BIOS information, perform the following actions one at a time to correct the problem.

1. If the computer is more than one year old, replace the CMOS battery.
2. Run a complete virus scan using up-to-date software to ensure the computer is virus free.
3. If the computer is experiencing HDD or ODD BIOS information loss, disconnect and reconnect the power and data cables between devices.
If the BIOS settings are still lost, replace the cables.
4. If HDD information is missing from the BIOS, the drive may be defective and should be replaced.
5. Replace the Motherboard.
6. If the Issue is still not resolved, see "Online Support Information" on page 187.

LCD Failure

If the **LCD** fails, perform the following actions one at a time to correct the problem. Do not replace a non-defective FRUs:

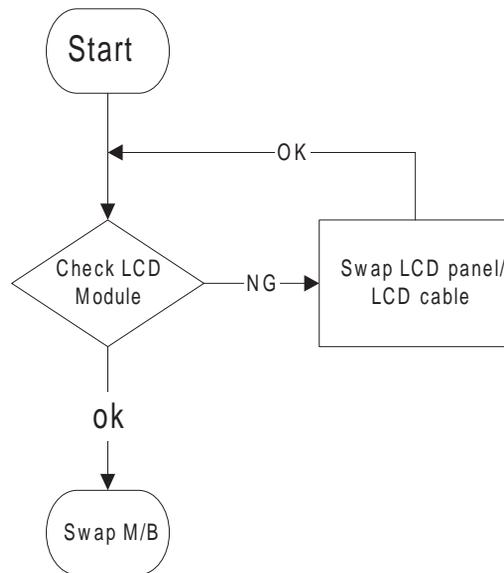

Built-In Keyboard Failure

If the built-in **Keyboard** fails, perform the following actions one at a time to correct the problem. Do not replace a non-defective FRUs:

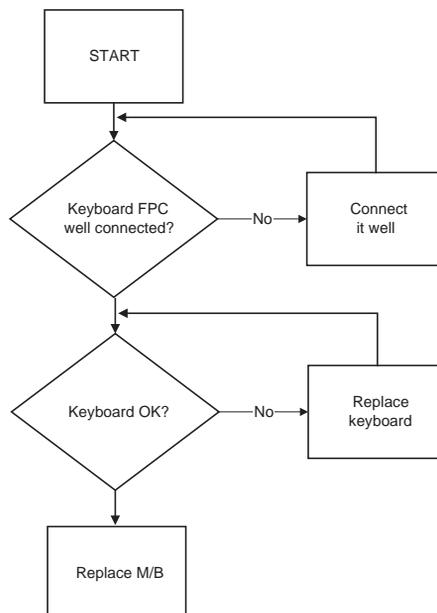

TouchPad Failure

If the **TouchPad** doesn't work, perform the following actions one at a time to correct the problem. Do not replace a non-defective FRUs:

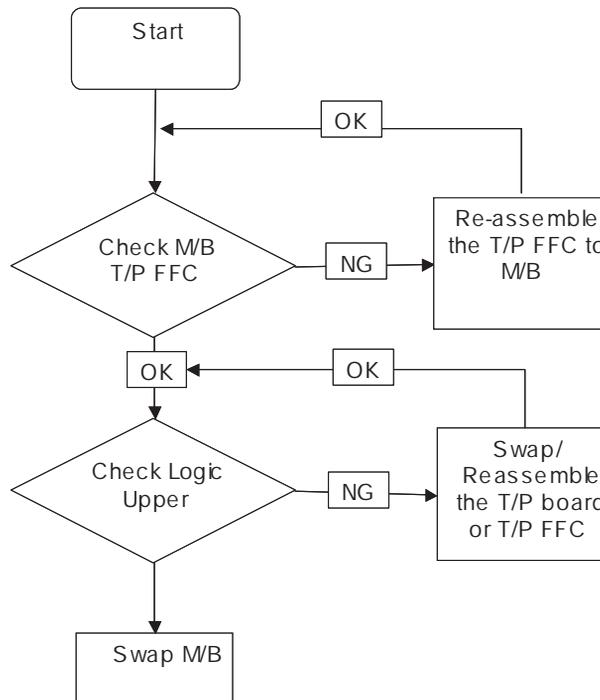

Internal Speaker Failure

If the internal **Speakers** fail, perform the following actions one at a time to correct the problem. Do not replace a non-defective FRUs:

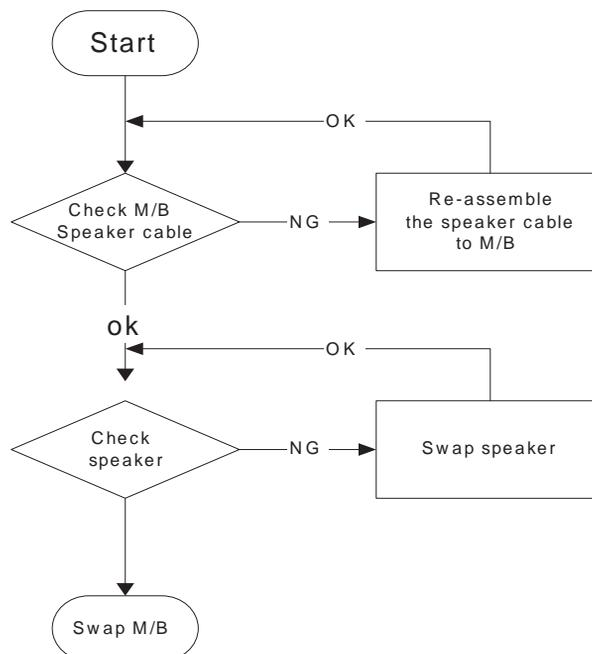

Sound Problems

If sound problems are experienced, perform the following actions one at a time to correct the problem.

1. Reboot the computer.
2. Navigate to **Start** → **Control Panel** → **System and Maintenance** → **System** → **Device Manager**. Check the Device Manager to determine that:
 - The device is properly installed.
 - There are no red Xs or yellow exclamation marks.
 - There are no device conflicts.
 - No hardware is listed under Other Devices.
3. Roll back the audio driver to the previous version, if updated recently.
4. Remove and reinstall the audio driver.
5. Ensure that all volume controls are set mid range:
 - a. Click the volume icon on the taskbar and drag the slider to 50. Ensure that the volume is not muted.
 - b. Click Mixer to verify that other audio applications are set to 50 and not muted.
6. Navigate to **Start** → **Control Panel** → **Hardware and Sound** → **Sound**. Ensure that Speakers are selected as the default audio device (green check mark).

NOTE: If Speakers does not show, right-click on the **Playback** tab and select **Show Disabled Devices** (clear by default).
7. Select Speakers and click **Configure** to start **Speaker Setup**. Follow the onscreen prompts to configure the speakers.
8. Remove and recently installed hardware or software.
9. Restore system and file settings from a known good date using **System Restore**.

If the issue is not fixed, repeat the preceding steps and select an earlier time and date.
10. Reinstall the Operating System.
11. If the Issue is still not resolved, see "Online Support Information" on page 187.

Internal Microphone Failure

If the internal **Microphone** fails, perform the following actions one at a time to correct the problem. Do not replace a non-defective FRUs:

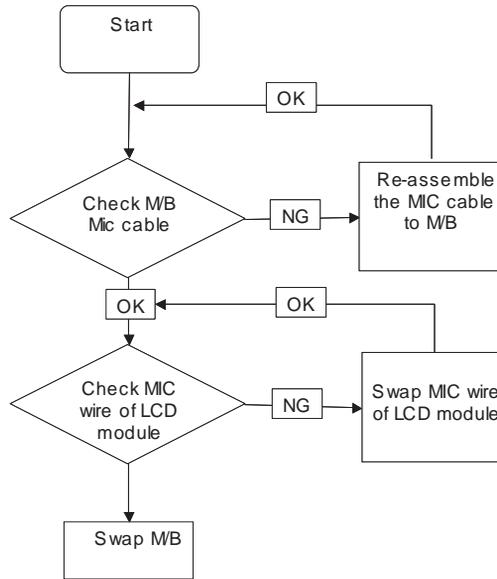

Microphone Problems

If internal or external **Microphones** do not operate correctly, perform the following actions one at a time to correct the problem.

1. Check that the microphone is enabled. Navigate to **Start** → **Control Panel** → **Hardware and Sound** → **Sound** and select the **Recording** tab.
2. Right-click on the **Recording** tab and select **Show Disabled Devices** (clear by default).
3. The microphone appears on the **Recording** tab.
4. Right-click on the microphone and select **Enable**.
5. Select the microphone then click **Properties**. Select the **Levels** tab.
6. Increase the volume to the maximum setting and click **OK**.
7. Test the microphone hardware:
 - a. Select the microphone and click **Configure**.
 - b. Select **Set up microphone**.
 - c. Select the microphone type from the list and click **Next**.
 - d. Follow the onscreen prompts to complete the test.
8. If the Issue is still not resolved, see "Online Support Information" on page 187.

HDD Not Operating Correctly

If the **HDD** does not operate correctly, perform the following actions one at a time to correct the problem.

1. Disconnect all external devices.
2. Run a complete virus scan using up-to-date software to ensure the computer is virus free.
3. Run the Windows Vista Startup Repair Utility:
 - a. insert the Windows Vista Operating System DVD in the ODD and restart the computer.
 - b. When prompted, press any key to start to the operating system DVD.
 - c. The **Install Windows** screen displays. Click **Next**.
 - d. Select **Repair your computer**.
 - e. The **System Recovery Options** screen displays. Click **Next**.
 - f. Select the appropriate operating system, and click **Next**.

NOTE: Click **Load Drivers** if controller drives are required.

- g. Select **Startup Repair**.
- h. Startup Repair attempts to locate and resolve issues with the computer.
- i. When complete, click **Finish**.

If an issue is discovered, follow the onscreen information to resolve the problem.

4. Run the Windows Memory Diagnostic Tool. For more information see Windows Help and Support.
5. Restart the computer and press F2 to enter the BIOS Utility. Check the BIOS settings are correct and that CD/DVD drive is set as the first boot device on the Boot menu.
6. Ensure all cables and jumpers on the HDD and ODD are set correctly.
7. Remove any recently added hardware and associated software.
8. Run the Windows Disk Defragmenter. For more information see Windows Help and Support.
9. Run Windows Check Disk by entering **chkdsk /r** from a command prompt. For more information see Windows Help and Support.
10. Restore system and file settings from a known good date using **System Restore**.

If the issue is not fixed, repeat the preceding steps and select an earlier time and date.
11. Replace the HDD. See "Disassembly Process" on page 44.

ODD Failure

If the **ODD** fails, perform the following actions one at a time to correct the problem. Do not replace a non-defective FRUs:

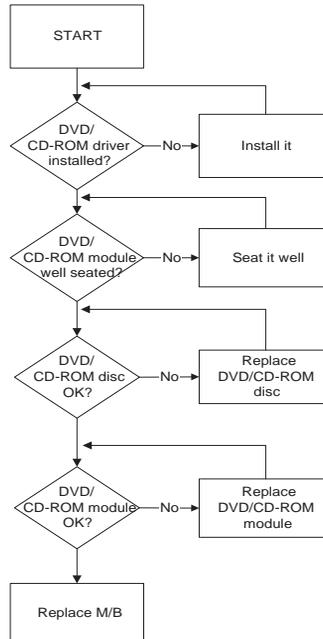

ODD Not Operating Correctly

If the **ODD** exhibits any of the following symptoms it may be faulty:

- Audio CDs do not play when loaded
- DVDs do not play when loaded
- Blank discs do not burn correctly
- DVD or CD play breaks up or jumps
- Optical drive not found or not active:
 - Not shown in My Computer or the BIOS setup
 - LED does not flash when the computer starts up
 - The tray does not eject
- Access failure screen displays
- The ODD is noisy

Perform the following general solutions one at a time to correct the problem.

1. Reboot the computer and retry the operation.
2. Try an alternate disc.
3. Navigate to **Start** → **Computer**. Check that the ODD device is displayed in the **Devices with Removable Storage** panel.
4. Navigate to **Start** → **Control Panel** → **System and Maintenance** → **System** → **Device Manager**.
 - a. Double-click **IDE ATA/ATAPI controllers**. If a device displays a down arrow, right-click on the device and click **Enable**.

-
- b. Double-click **DVD/CD-ROM drives**. If the device displays a down arrow, right-click on the device and click **Enable**.
 - c. Check that there are no yellow exclamation marks against the items in **IDE ATA/ATAPI controllers**. If a device has an exclamation mark, right-click on the device and uninstall and reinstall the driver.
 - d. Check that there are no yellow exclamation marks against the items in **DVD/CD-ROM drives**. If a device has an exclamation mark, right-click on the device and uninstall and reinstall the driver.
 - e. If the exclamation marker is not removed from the item in the lists, try removing any recently installed software and retrying the operation.

Discs Do Not Play

If discs do not play when inserted in the drive, perform the following actions one at a time to correct the problem.

1. Check that the disc is correctly seated in the drive tray and that the label on the disc is visible.
2. Check that the media is clean and scratch free.
3. Try an alternate disc in the drive.
4. Ensure that **AutoPlay** is enabled:
 - a. Navigate to **Start** → **Control Panel** → **Hardware and Sound** → **AutoPlay**.
 - b. Select **Use AutoPlay for all media and devices**.
 - c. In the Audio CD and DVD Movie fields, select the desired player from the drop down menu.
5. Check that the Regional Code is correct for the selected media:

IMPORTANT:Region can only be changed a limited number of times. After Changes remaining reaches zero, the region cannot be changed even Windows is reinstalled or the drive is moved to another computer.

- a. Navigate to **Start** → **Control Panel** → **System and Maintenance** → **System** → **Device Manager**.
- b. Double-click **DVD/CD-ROM drives**.
- c. Right-click **DVD drive** and click **Properties**, then click the **DVD Region** tab.
- d. Select the region suitable for the media inserted in the drive.

Discs Do Not Burn Properly

If discs can not be burned, perform the following actions one at a time to correct the problem.

1. Ensure that the default drive is record enabled:
 - a. Navigate to **Start** → **Computer** and right-click the writable ODD icon. Click **Properties**.
 - b. Select the **Recording** tab. In the **Desktop disc recording** panel, select the writable ODD from the drop down list.
 - c. Click **OK**.
2. Ensure that the software used for burning discs is the factory default. If using different software, refer to the software's user manual.

Playback is Choppy

If playback is choppy or jumps, perform the following actions one at a time to correct the problem.

1. Check that system resources are not running low:
 - a. Try closing some applications.
 - b. Reboot and try the operation again.
2. Check that the ODD controller transfer mode is set to DMA:
 - a. Navigate to **Start** → **Control Panel** → **System and Maintenance** → **System** → **Device Manager**.
 - b. Double-click **IDE ATA/ATAPI controllers**, then right-click ATA Device 0.

-
- c. Click **Properties** and select the **Advanced Settings** tab. Ensure that the **Enable DMA** box is checked and click **OK**.
 - d. Repeat for the other ATA Devices shown if applicable.

Drive Not Detected

If Windows cannot detect the drive, perform the following actions one at a time to correct the problem.

1. Restart the computer and press F2 to enter the BIOS Utility.
2. Check that the drive is detected in the **ATAPI Model Name** field on the Information page.
NOTE: Check that the entry is identical to one of the ODDs specified in “Hardware Specifications and Configurations” on page 17.
3. Turn off the power and remove the cover to inspect the connections to the ODD. See “Disassembly Process” on page 44.
 - a. Check for broken connectors on the drive, motherboard, and cables.
 - b. Check for bent or broken pins on the drive, motherboard, and cable connections.
 - c. Try an alternate cable, if available. If the drive works with the new cable, the original cable should be replaced.
4. Reseat the drive ensuring and all cables are connected correctly.
5. Replace the ODD. See “Disassembly Process” on page 44.

Drive Read Failure

If discs cannot be read when inserted in the drive, perform the following actions one at a time to correct the problem.

1. Remove and clean the failed disc.
2. Retry reading the CD or DVD.
 - d. Test the drive using other discs.
 - e. Play a DVD movie
 - f. Listen to a music CD

If the ODD works properly with alternate discs, the original disc is probably defective and should be replaced.

3. Turn off the power and remove the cover to inspect the connections to the ODD. See “Disassembly Process” on page 44.
 - a. Check for broken connectors on the drive, motherboard, and cables.
 - b. Check for bent or broken pins on the drive, motherboard, and cable connections.
 - c. Try an alternate cable, if available. If the drive works with the new cable, the original cable should be replaced.
4. Replace the ODD. See “Disassembly Process” on page 44.

USB Failure

If the USB fails, perform the following actions one at a time to correct the problem. Do not replace a non-defective FRU:

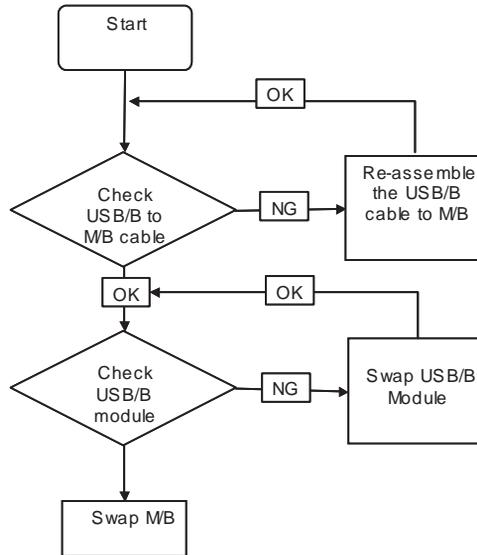

Modem Function Failure

If the internal **Modem** fails, perform the following actions one at a time to correct the problem. Do not replace a non-defective FRUs:

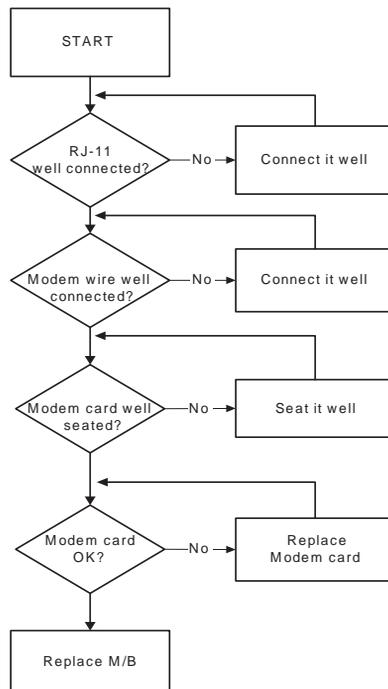

Wireless Function Failure

If the **WLAN** fails, perform the following actions one at a time to correct the problem. Do not replace a non-defective FRUs:

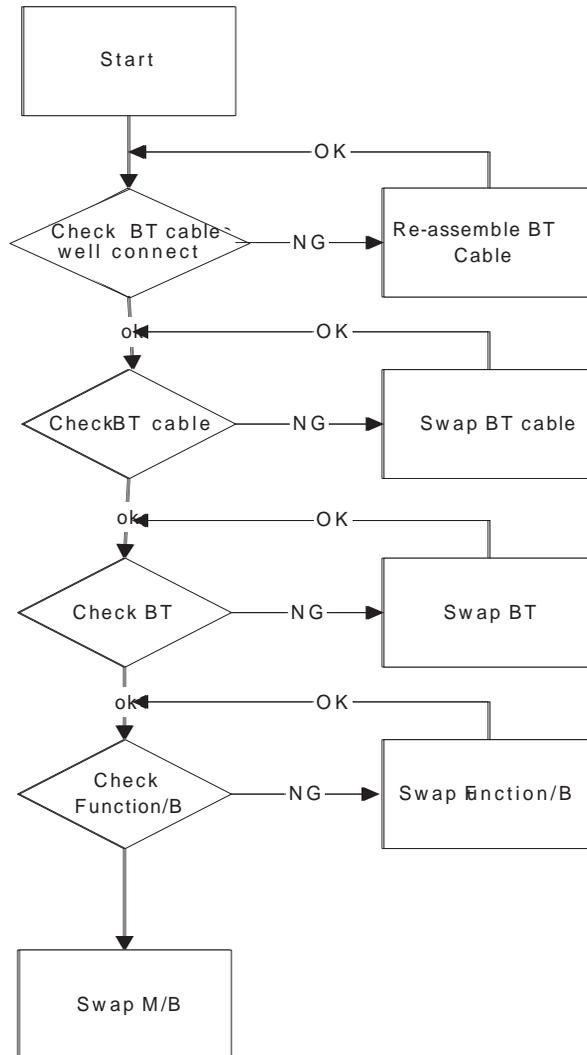

BT Unit Failure

If the **Bluetooth Module** fails, perform the following actions one at a time to correct the problem. Do not replace a non-defective FRU:

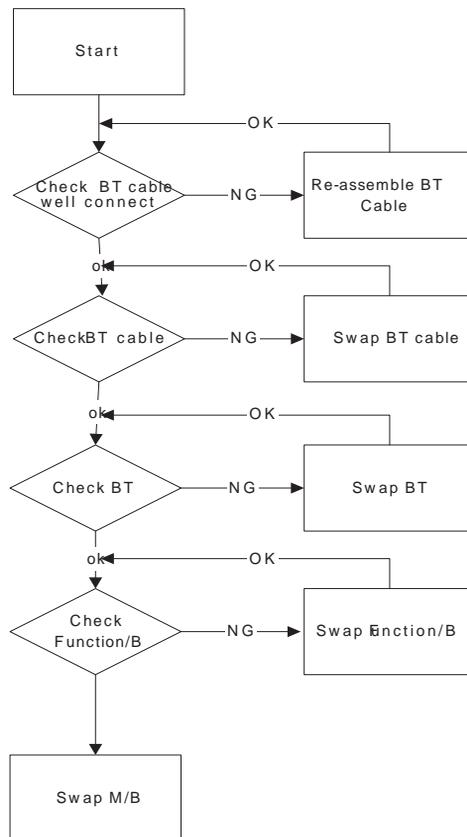

Function Board Failure

If the **Function Board** fails, perform the following actions one at a time to correct the problem. Do not replace a non-defective FRUs:

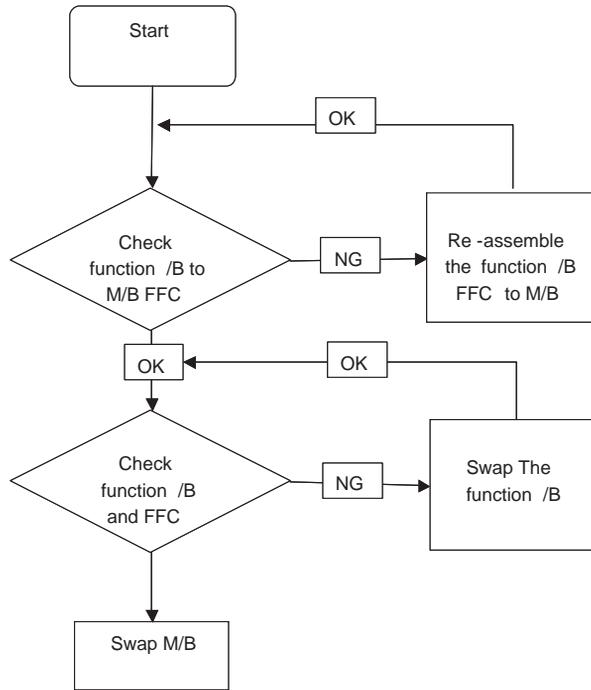

Thermal Unit Failure

If the **Thermal Unit** fails, perform the following actions one at a time to correct the problem. Do not replace a non-defective FRUs:

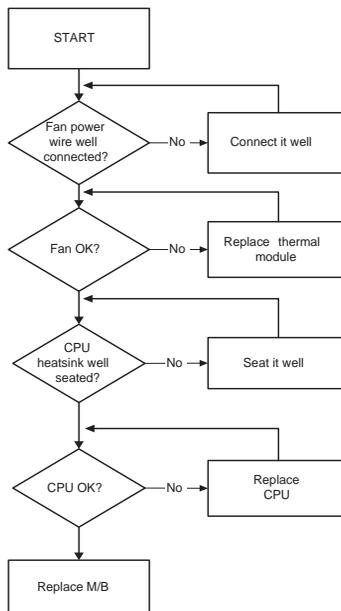

External Mouse Failure

If an external **Mouse** fails, perform the following actions one at a time to correct the problem.

1. Try an alternative mouse.
2. If the mouse uses a wireless connection, insert new batteries and confirm there is a good connection. See the mouse user manual.
3. If the mouse uses a USB connection, try an alternate USB port.
4. Try an alternative program to verify mouse operation. Reinstall the program experiencing mouse failure.
5. Restart the computer.
6. Remove any recently added hardware and associated software.
7. Remove any recently added software and reboot.
8. Restore system and file settings from a known good date using **System Restore**.
If the issue is not fixed, repeat the preceding steps and select an earlier time and date.
9. Run the Event Viewer to check the events log for errors. For more information see Windows Help and Support.
10. Roll back the mouse driver to the previous version if updated recently.
11. Remove and reinstall the mouse driver.
12. Check the Device Manager to determine that:
 - The device is properly installed. There are no red Xs or yellow exclamation marks.
 - There are no device conflicts.
 - No hardware is listed under Other Devices.
13. If the Issue is still not resolved, see "Online Support Information" on page 187.

Other Failures

If the CRT Switch, Dock, LAN Port, external MIC or Speakers, PCI Express Card, 5-in-1 Card Reader or Volume Wheel fail, perform the following general steps to correct the problem. Do not replace a non-defective FRUs:

1. Check Drive whether is OK.
2. Check Test Fixture is ok.
3. Swap M/B to Try.

Intermittent Problems

Intermittent system hang problems can be caused by a variety of reasons that have nothing to do with a hardware defect, such as: cosmic radiation, electrostatic discharge, or software errors. FRU replacement should be considered only when a recurring problem exists.

When analyzing an intermittent problem, do the following:

1. Run the advanced diagnostic test for the system board in loop mode at least 10 times.
2. If no error is detected, do not replace any FRU.
3. If any error is detected, replace the FRU. Rerun the test to verify that there are no more errors.

Undetermined Problems

The diagnostic problems does not identify which adapter or device failed, which installed devices are incorrect, whether a short circuit is suspected, or whether the system is inoperative.

Follow these procedures to isolate the failing FRU (do not isolate non-defective FRU).

NOTE: Verify that all attached devices are supported by the computer.

NOTE: Verify that the power supply being used at the time of the failure is operating correctly. (See "Power On Issue" on page 134.):

1. Power-off the computer.
2. Visually check them for damage. If any problems are found, replace the FRU.
3. Remove or disconnect all of the following devices:
 - Non-Acer devices
 - Printer, mouse, and other external devices
 - Battery pack
 - Hard disk drive
 - DIMM
 - CD-ROM/Diskette drive Module
 - PC Cards
4. Power-on the computer.
5. Determine if the problem has changed.
6. If the problem does not recur, reconnect the removed devices one at a time until you find the failing FRU.
7. If the problem remains, replace the following FRU one at a time. Do not replace a non-defective FRU:
 - System board
 - LCD assembly

Post Codes

These tables describe the POST codes and descriptions during the POST.

Chipset POST Codes

The following table details the chipset POST codes and functions used in the POST.

Code	Beeps	POST Routine Description
02h		Verify Real Mode
03h		Disable Non-Maskable Interrupt (NMI)
04h		Get CPU type
06h		Initialize system hardware
08h		Initialize chipset with initial POST values
09h		Set IN POST flag
0Ah		Initialize CPU registers
0Bh		Enable CPU cache
0Ch		Initialize caches to initial POST values
0Eh		Initialize I/O component
0Fh		Initialize the local bus IDE
10h		Initialize Power Management
11h		Load alternate registers with initial POST values
12h		Restore CPU control word during warm boot
13h		Initialize PCI Bus Mastering devices
14h		Initialize keyboard controller
16h	1-2-2-3	BIOS ROM checksum
17h		Initialize cache before memory autosize
18h		8254 timer initialization
1Ah		8237 DMA controller initialization
1Ch		Reset Programmable Interrupt Controller
20h	1-3-1-1	Test DRAM refresh
22h	1-3-1-3	Test 8742 Keyboard Controller
24h		Set ES segment register to 4 GB
26h		Enable A20 line
28h		Autosize DRAM
29h		Initialize POST Memory Manager
2Ah		Clear 512 KB base RAM
2Ch	1-3-4-1	RAM failure on address line xxxx*
2Eh	1-3-4-3	RAM failure on data bits xxxx* of low byte of memory
bus		
2Fh		Enable cache before system BIOS shadow
30h	1-4-1-1	RAM failure on data bits xxxx* of high byte of memory
bus		
32h		Test CPU bus-clock frequency
33h		Initialize Phoenix Dispatch Manager
36h		Warm start shut down

Code	Beeps	POST Routine Description
38h		Shadow system BIOS ROM
3Ah		Autosize cache
3Ch		Advanced configuration of chipset registers
3Dh		Load alternate registers with CMOS values
42h		Initialize interrupt vectors
45h		POST device initialization
46h	2-1-2-3	Check ROM copyright notice
48h		Check video configuration against CMOS
49h		Initialize PCI bus and devices
4Ah		Initialize all video adapters in system
4Bh		QuietBoot start (optional)
4Ch		Shadow video BIOS ROM
4Eh		Display BIOS copyright notice
50h		Display CPU type and speed
51h		Initialize EISA board
52h		Test keyboard
54h		Set key click if enabled
58h	2-2-3-1	Test for unexpected interrupts
59h		Initialize POST display service
5Ah		Display prompt "Press F2 to enter SETUP"
5Bh		Disable CPU cache
5Ch		Test RAM between 512 and 640 KB
60h		Test extended memory
62h		Test extended memory address lines
64h		Jump to UserPatch1
66h		Configure advanced cache registers
67h		Initialize Multi Processor APIC
68h		Enable external and CPU caches
69h		Setup System Management Mode (SMM) area
6Ah		Display external L2 cache size
6Bh		Load custom defaults (optional)
6Ch		Display shadow-area message
6Eh		Display possible high address for UMB recovery
70h		Display error messages
72h		Check for configuration errors
76h		Check for keyboard errors
7Ch		Set up hardware interrupt vectors
7Eh		Initialize coprocessor if present
80h		Disable onboard Super I/O ports and IRQs
81h		Late POST device initialization
82h		Detect and install external RS232 ports
83h		Configure non-MCD IDE controllers
84h		Detect and install external parallel ports

Code	Beeps	POST Routine Description
85h		Initialize PC-compatible PnP ISA devices
86h		Re-initialize onboard I/O ports.
87h		Configure Motherboard Configurable Devices (optional)
88h		Initialize BIOS Data Area
89h		Enable Non-Maskable Interrupts (NMIs)
8Ah		Initialize Extended BIOS Data Area
8Bh		Test and initialize PS/2 mouse
8Ch		Initialize floppy controller
8Fh		Determine number of ATA drives (optional)
90h		Initialize hard-disk controllers
91h		Initialize local-bus hard-disk controllers
92h		Jump to UserPatch2
93h		Build MPTABLE for multi-processor boards
95h		Install CD ROM for boot
96h		Clear huge ES segment register
97h		Fixup Multi Processor table
98h	2-1	Search for option ROMs. One long, two short beeps on
che		checksum failure
99h		Check for SMART Drive (optional)
9Ah		Shadow option ROMs
9Ch		Set up Power Management
9Dh		Initialize security engine (optional)
9Eh		Enable hardware interrupts
9Fh		Determine number of ATA and SCSI drives
A0h		Set time of day
A2h		Check key lock
A4h		Initialize Typematic rate
A8h		Erase F2 prompt
AAh		Scan for F2 key stroke
ACh		Enter SETUP
A Eh		Clear Boot flag
B0h		Check for errors
B2h		POST done - prepare to boot operating system
B4h	1	One short beep before boot
B5h		Terminate QuietBoot (optional)
B6h		Check password (optional)
B9h		Prepare Boot
BAh		Initialize DMI parameters
BBh		Initialize PnP Option ROMs
BCh		Clear parity checkers
BDh		Display MultiBoot menu
BEh		Clear screen (optional)
BFh		Check virus and backup reminders

Code	Beeps	POST Routine Description
C0h		Try to boot with INT 19
C1h		Initialize POST Error Manager (PEM)
C2h		Initialize error logging
C3h		Initialize error display function
C4h		Initialize system error handler
C5h		PnPnd dual CMOS (optional)
C6h		Initialize notebook docking (optional)
C7h		Initialize notebook docking late
C8h		Force check (optional)
C9h		Extended checksum (optional)
D2h		Unknown interrupt

Code	Beeps	POST Routine Description
E0h		Initialize the chipset
E1h		Initialize the bridge
E2h		Initialize the CPU
E3h		Initialize system timer
E4h		Initialize system I/O
E5h		Check force recovery boot
E6h		Checksum BIOS ROM
E7h		Go to BIOS
E8h		Set Huge Segment
E9h		Initialize Multi Processor
EAh		Initialize OEM special code
EBh		Initialize PIC and DMA
ECh		Initialize Memory type
EDh		Initialize Memory size
EEh		Shadow Boot Block
EFh		System memory test
F0h		Initialize interrupt vectors
F1h		Initialize Run Time Clock
F2h		Initialize video
F3h		Initialize System Management Mode
F4h	1	Output one beep before boot
F5h		Boot to Mini DOS
F6h		Clear Huge Segment
F7h		Boot to Full DOS

* If the BIOS detects error 2C, 2E, or 30 (base 512K RAM error), it displays an additional word-bitmap (xxxx) indicating the address line or bits that failed. For example, **2C 0002** means address line 1 (bit one set) has failed. **2E 1020** means data bits 12 and 5 (bits 12 and 5 set) have failed in the lower 16 bits. Note that error 30 cannot occur on 386SX systems because they have a 16 rather than 32-bit bus. The BIOS also sends the bitmap to the port-80 LED display. It first displays the check point code, followed by a delay, the high-order byte, another delay, and then the low-order byte of the error. It repeats this sequence continuously.

Jumper and Connector Locations

Top View

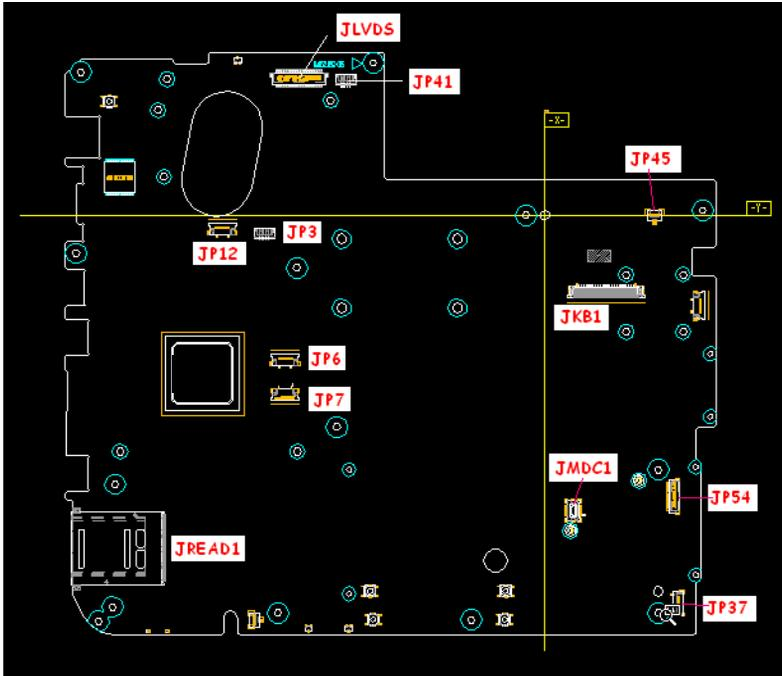

Item	Description
JLVD51	LCD Connector
JP41	Internal MIC
JP45	Power board Connector
JKB1	Internal Keyboard Connector
JMDC1	Internal MDC Connector
JP54	USB Board connector
JP37	B/T connector
JP6	Cap sensor board CONN
JP7	T/P Connector
JREAD1	Card Reader Socket
JP3	Speaker CONN
JP12	LED Board CONN

Bottom View

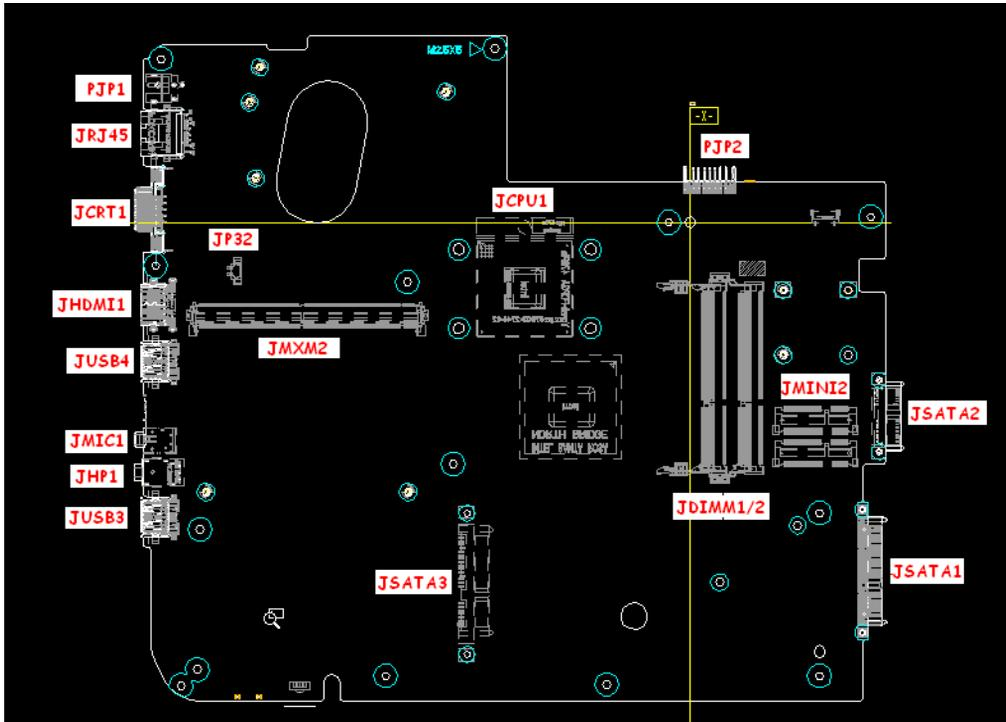

Item	Description
PJP2	Battery Connector
JMINI2	WLAN Connector
JSATA2	ODD Connector
JSATA1	HDD Connector
JDIMM1/2	RAM Connector
JCPU1	CPU Socket
JSATA3	2nd HDD Connector
JMXM2	MXM Board Connector
JP32	FAN Connector
JUSB3	USB Connector
JHP1	Head-Phone Jack
HMIC1	MIC-In Jack
JUSB4	USB Connector
JHDMI1	HDMI Connector
JCRT1	CRT Connector
JRJ45	RJ45 Connector
PJP1	AC-IN Jack

Clearing Password Check and BIOS Recovery

This section provide you the standard operating procedures of clearing password and BIOS recovery for Packard Bell EasyNote LJ61. Packard Bell EasyNote LJ61 provides one Hardware Open Gap on main board for clearing password check, and one Hotkey for enabling BIOS Recovery.

Clearing Password Check

Hardware Open Gap Description is as follows:

Item	Description	Location
G1	Clear CMOS Jumper	Thermal Module Bay, under Modem Board

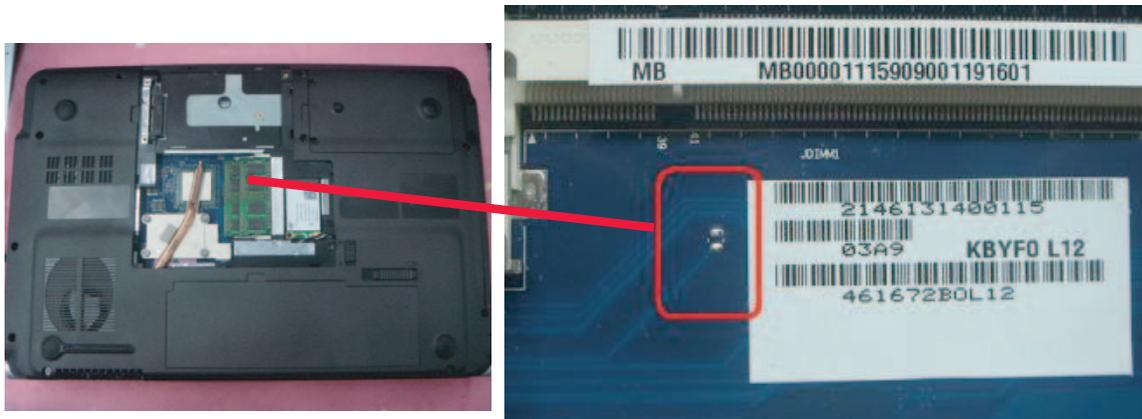

Steps for Clearing BIOS Password Check

If users set BIOS Password (Supervisor Password and/or User Password) for a security reason, BIOS will ask the password during systems POST or when systems enter to BIOS Setup menu. However, once it is necessary to bypass the password check, users need to short the HW Gap to clear the password by the following steps:

1. Power Off the system, and remove HDD, AC and Battery from the machine.
2. Open the back cover of the machine, and remove the Modem Board (see "Removing the Modem Board" on page 80).
3. Disconnect the RTC Battery cable and locate the G1 jumper.
4. Use an electric conductivity tool to short the two points of the HW Gap.
5. Plug in AC, keep the short condition on the HW Gap, and press Power Button to power on the system till BIOS POST finish. Then remove the tool from the HW Gap.
6. Restart system. Press **F2** key to enter BIOS Setup menu.
7. If there is no Password request, BIOS Password is cleared. Otherwise, please follow the steps and try again.

NOTE: These steps are only for clearing BIOS Password (Supervisor Password and User Password).

BIOS Recovery by Crisis Disk

BIOS Recovery Boot Block:

BIOS Recovery Boot Block is a special block of BIOS. It is used to boot up the system with minimum BIOS initialization. Users can enable this feature to restore the BIOS firmware to a successful one once the previous BIOS flashing process failed.

BIOS Recovery Hotkey:

The system provides a function hotkey: **Fn+Esc**, for enable BIOS Recovery process when system is powered on during BIOS POST. To use this function, it is strongly recommended to have the AC adapter and Battery present. If this function is enabled, the system will force the BIOS to enter a special BIOS block, called Boot Block.

Steps for BIOS Recovery from USB Storage:

Before doing this, prepare the Crisis USB key. The Crisis USB key could be made by executing the Crisis Disk program in another system with Windows XP OS.

Follow the steps below:

1. Save ROM file (file name: **JAL90x64.fd**) to the root directory of USB storage.
2. Plug USB storage into USB port.
3. Press **Fn + ESC** button then plug in AC.
The Power button flashes once.
4. Press **Power** button to initiate system CRISIS mode.
When CRISIS is complete, the system auto restarts with a workable BIOS.
5. Update the latest version BIOS for this machine by regular BIOS flashing process.

Steps for BIOS Recovery by Crisis Disk:

Before doing this, a Crisis Diskette should be prepared ready in hand. The Crisis Diskette could be made by executing the Crisis Disk program in another system with Windows XP OS.

Follow the steps below:

1. Power Off failed system.
2. Attach a USB floppy drive to the failed system.
3. Copy **xxxxx.wph** to tool's folder and rename it as **BIOS.wph**.
4. Execute **wincris.exe** to start the Crisis Disk Build.
5. Select **Removable** and click **Start**.
6. Select **Quick Format Disk** and click **Start**. A progress screen displays.
7. Click **OK** to complete the process.
8. Insert the Crisis Disk in to the USB floppy drive attached to the BIOS flash failed system.
9. In the power-off state, press and hold **Fn+Esc** then press the Power button.

The system powers on and the Crisis BIOS Recovery process begins.

BIOS Boot Block begins restoring the BIOS code from the Crisis floppy disk to BIOS ROM on the failed systems.

When the Crisis flash process is finished, the system restarts with a workable BIOS.

Update to the latest version BIOS for the system using the regular BIOS flashing process.

FRU (Field Replaceable Unit) List

This chapter gives you the FRU (Field Replaceable Unit) listing in global configurations of Packard Bell EasyNote LJ61. Refer to this chapter whenever ordering for parts to repair or for RMA (Return Merchandise Authorization).

Please note that WHEN ORDERING FRU PARTS, you should check the most up-to-date information available on your regional web or channel. For whatever reasons a part number change is made, it will not be noted on the printed Service Guide. For ACER AUTHORIZED SERVICE PROVIDERS, your Acer office may have a DIFFERENT part number code from those given in the FRU list of this printed Service Guide. You MUST use the local FRU list provided by your regional Acer office to order FRU parts for repair and service of customer machines.

NOTE: To scrap or to return the defective parts, you should follow the local government ordinance or regulations on how to dispose it properly, or follow the rules set by your regional Acer office on how to return it.

Packard Bell EasyNote LJ61 Exploded Diagrams

Main Assembly

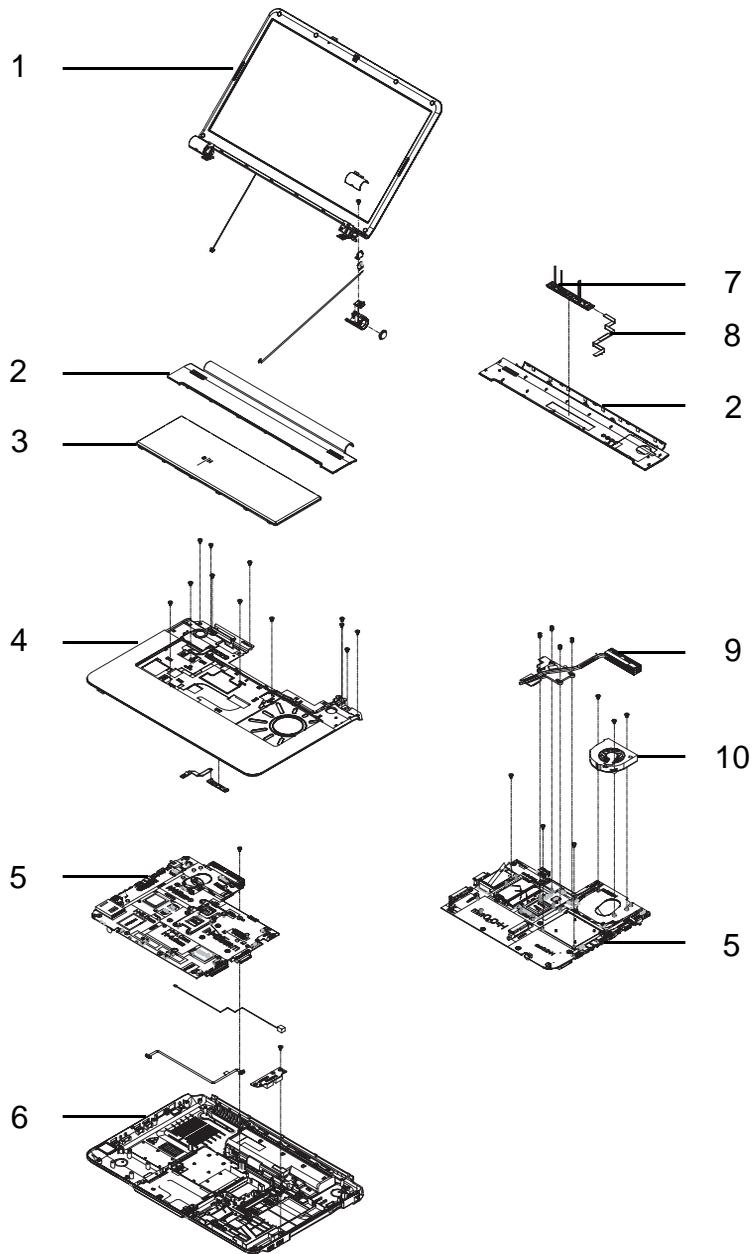

No.	Description	Acer P/N	No.	Description	Acer P/N
1	LCD Module	6M.WBF02.003	6	Lower Cover	60.WBF02.003
2	Switch Cover	60.WBF02.007	7	Media Board	55.WBF02.001
3	Keyboard	KB.I170G.029	8	Media Board FFC	50.WBF02.003
4	Upper Cover	60.WBF02.001	9	Thermal Module	60.WBT02.001
5	Mainboard	MB.B5802.001	10	CPU Fan	23.B5702.001

Rear Assembly

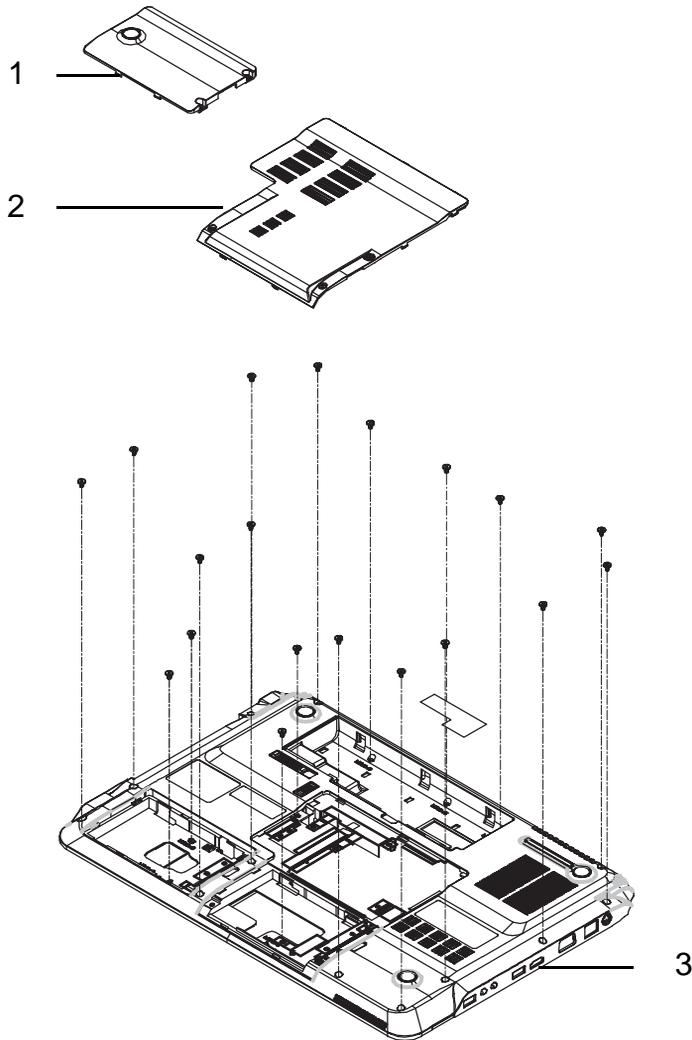

No.	Description	Acer P/N	No.	Description	Acer P/N
1	Primary HDD Cover	42.WBF02.001	3	Lower Cover	60.WBF02.003
2	Secondary HDD Door	42.WBF02.002			

LCD Assembly

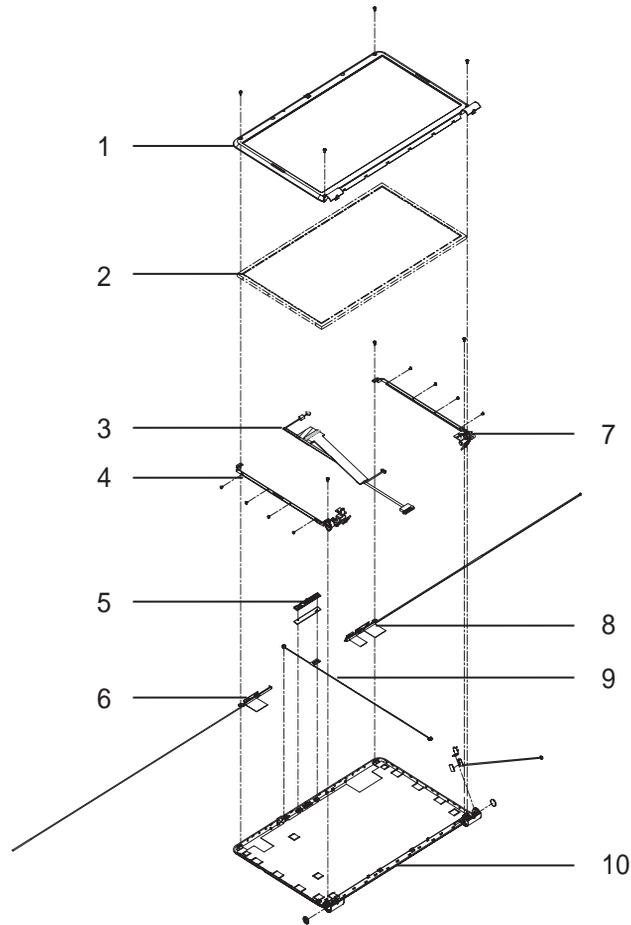

No.	Description	Acer P/N	No.	Description	Acer P/N
1	LCD Bezel	60.WBF02.009	6	Antenna_Left	50.WBF02.007
2	LCD Panel	LK.17305.001	7	LCD Bracket_Right	33.WBF02.004
3	LCD Cable	50.WBF02.008	8	Antenna_R	50.WBF02.006
4	LCD Bracket_Left	33.WBF02.004	9	Microphone Module	23.WBF02.001
5	Camera Module	57.WBF02.001	10	LCD Cover	60.WBF02.009

Base Top Assembly

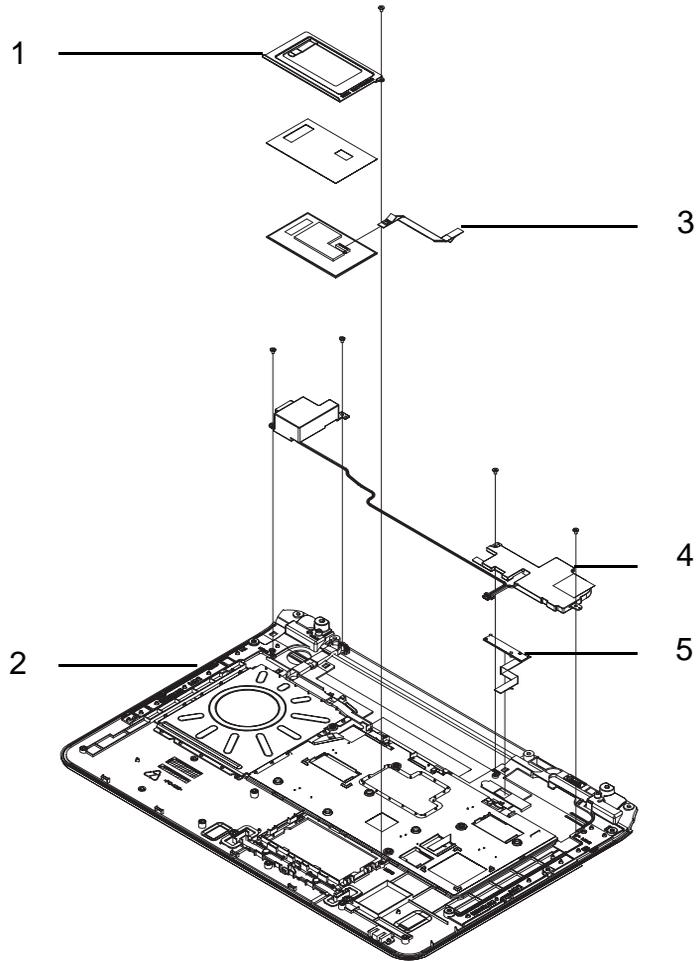

No.	Description	Acer P/N	No.	Description	Acer P/N
1	TouchPad Bracket	33.WBF02.002	4	Speaker Module	23.WBF02.002
2	Upper Cover	60.WBF02.001	5	LED Board	55.WBF02.002
3	TouchPad FFC	50.WBF02.002			

Packard Bell EasyNote LJ61 FRU List

Category	Description	Acer Part Number
BOARD		
	Foxconn Bluetooth FOX_BRM_2.0 F/W 300	BT.21100.005
	Lite-On Conexant -Unizion 1.5_3.3v AUS RD02-D330	FX.22500.021
	MEDIA BOARD	55.WBF02.001
	LED BOARD	55.WBF02.002
	USB BOARD	55.WBF02.003
	POWER BOARD	55.WBF02.004
	VGA BOARD 10PGE1-MSI (MS-V165A3 1G)	55.WBG02.001
	VGA BOARD 10PGE1-YUAN (YSTP801GP)	55.WBG02.002
	VGA BOARD M92M-MSI (MS-V164A3 512MB)	55.WBK02.001
	VGA BOARD M92M-FOX (T77Z108 512MB)	55.WBK02.002
	VGA BOARD M96M-MSI (MS-V164A3 1G)	55.WBY02.001
	VGA BOARD M96M-FOX (T77Z108 1G)	55.WBY02.002
	Lan Intel WLAN 512AN_MMWG Shirley Peak 5100 MM#895361	KI.SPM01.003
	Lan Intel WLAN 512AN_MMWG2 Shirley Peak 5100 ME enable / MM#899541	KI.SPM01.008
	Lan Intel WLAN 533AN_MMWG2 Shirley Peak 5300 ME enable / MM#899545	KI.SPM01.009
	Foxconn Wireless LAN Atheros HB93 1x2 BGN (HM)	NI.23600.046
	Foxconn FOX_ATH_XB63 Foxconn Atheros XB63 minicard b/g	NI.23600.007
	Foxconn Wireless LAN Broadcom 4312 minicard b/g	NI.23600.029
	Foxconn Wireless LAN Atheros AR5B91 1x2 BGN	NI.23600.030
	Foxconn Wireless LAN Wireless LAN Ralink RT2700E 1x2 BGN	NI.23600.031
CABLE		
	BLUE TOOTH CABLE	50.WBF02.001
	T/P FFC	50.WBF02.002

Category	Description	Acer Part Number
	MEDIA BOARD FFC	50.WBF02.003
	USB CABLE	50.WBF02.004
	RJ11 CABLE	50.WBF02.005
	POWER CORD US 3 PIN	27.TAVV5.001
	POWER CORD EU 3 PIN	27.TAVV5.002
	POWER CORD AUS 3 PIN	27.TAVV5.003
	POWER CORD UK 3 PIN	27.TAVV5.004
	POWER CORD CHINA 3 PIN	27.TAVV5.005
	POWER CORD SWISS 3 PIN	27.TAVV5.006
	POWER CORD ITALIAN 3 PIN	27.TAVV5.007
	POWER CORD DENMARK 3 PIN	27.TAVV5.008
	POWER CORD JP 3 PIN	27.TAVV5.009
	POWER CORD SOUTH AFRICA 3 PIN	27.TAVV5.010
	POWER CORD KOERA 3 PIN	27.TAVV5.011
	POWER CORD ISRAEL 3 PIN	27.TAVV5.012
	POWER CORD INDIA 3 PIN	27.TAVV5.013
	POWER CORD TWN 3 PIN	27.TAVV5.014
	POWER CORD ARGENTINA 3 PIN	27.APV02.001
CASE/COVER/BRACKET ASSEMBLY		
	UPPER CASE ASSY-GTW	60.WBF02.001
	UPPER CASE ASSY-PB	60.WBF02.002
	LOWER CASE DIS W/RJ11 F	60.WBF02.003
	LOWER CASE DIS W/O RJ11 F	60.WBF02.004
	LOWER CASE UMA W/RJ11 F	60.WBJ02.001
	LOWER CASE UMA W/O RJ11 F	60.WBJ02.002
	MIDDLE COVER	60.WBF02.007
	POWER BOARD BRACKET	33.WBF02.005
	TP BRACKET	33.WBF02.002

Category	Description	Acer Part Number
	MAIN HDD DOOR W/ RUBBER FOOT	42.WBF02.001
	HDD CARRIER	33.WBF02.001
	HDD DOOR FOR NB W/ 2 HDD	42.WBF02.002
KEYBOARD		
	Keyboard GATEWAY GP-7T white SJV70 Internal 17 Standard 103KS White US International	KB.I170G.029
	Keyboard GATEWAY GP-7T white SJV70 Internal 17 Standard 103KS White Greek	KB.I170G.014
	Keyboard GATEWAY GP-7T white SJV70 Internal 17 Standard 103KS White Arabic	KB.I170G.005
	Keyboard GATEWAY GP-7T white SJV70 Internal 17 Standard 103KS White Russian	KB.I170G.021
	Keyboard GATEWAY GP-7T white SJV70 Internal 17 Standard 103KS White Thailand	KB.I170G.026
	Keyboard GATEWAY GP-7T white SJV70 Internal 17 Standard 104KS White UK	KB.I170G.028
	Keyboard GATEWAY GP-7T white SJV70 Internal 17 Standard 104KS White German	KB.I170G.013
	Keyboard GATEWAY GP-7T white SJV70 Internal 17 Standard 104KS White Swiss/G	KB.I170G.025
	Keyboard GATEWAY GP-7T white SJV70 Internal 17 Standard 104KS White CZ/SK	KB.I170G.008
	Keyboard GATEWAY GP-7T white SJV70 Internal 17 Standard 104KS White Belgium	KB.I170G.006
	Keyboard GATEWAY GP-7T white SJV70 Internal 17 Standard 104KS White Danish	KB.I170G.010
	Keyboard GATEWAY GP-7T white SJV70 Internal 17 Standard 104KS White Italian	KB.I170G.016
	Keyboard GATEWAY GP-7T white SJV70 Internal 17 Standard 104KS White French	KB.I170G.012
	Keyboard GATEWAY GP-7T white SJV70 Internal 17 Standard 104KS White Hungarian	KB.I170G.015
	Keyboard GATEWAY GP-7T white SJV70 Internal 17 Standard 104KS White Norwegian	KB.I170G.019
Keyboard GATEWAY GP-7T white SJV70 Internal 17 Standard 104KS White Portuguese	KB.I170G.020	

Category	Description	Acer Part Number
	Keyboard GATEWAY GP-7T white SJV70 Internal 17 Standard 104KS White Spanish	KB.I170G.023
	Keyboard GATEWAY GP-7T white SJV70 Internal 17 Standard 104KS White Turkish	KB.I170G.027
	Keyboard GATEWAY GP-7T white SJV70 Internal 17 Standard 104KS White Sweden	KB.I170G.024
	Keyboard GATEWAY GP-7T white SJV70 Internal 17 Standard 104KS White SLO/CRO	KB.I170G.022
	Keyboard GATEWAY GP-7T white SJV70 Internal 17 Standard 104KS White Nordic	KB.I170G.018
	Keyboard GATEWAY GP-7T white SJV70 Internal 17 Standard 107KS White Japanese	KB.I170G.017
DVD-RW DRIVE		
	ODD SUPER-MULTI DRIVE MODULE	6M.WBF02.001
	ODD PANASONIC Super-Multi DRIVE 12.7mm Tray DL 8X UJ880A LF W/O bezel SATA	KU.00807.064
	ODD HLDS Super-Multi DRIVE 12.7mm Tray DL 8X GT20N LF W/O bezel SATA	KU.0080D.040
	ODD SONY Super-Multi DRIVE 12.7mm Tray DL 8X AD-7580S LF W/O bezel SATA	KU.0080E.017
	ODD PLDS Super-Multi DRIVE 12.7mm Tray DL 8X DS-8A3S LF W/O bezel SATA	KU.0080F.004
	ODD BEZEL-SUPER MULTI	42.WBF02.004
	ODD BRACKET	33.WBF02.003
	ODD BD COMBO MODULE	6M.WBF02.002
	ODD PLDS BD COMBO 12.7mm Tray DL 4X DS-4E1S LF W/O bezel SATA	KO.0040F.001
	ODD HLDS BD COMBO 12.7mm Tray DL 4X CT10 LF W/O bezel SATA	KO.0040D.002
	ODD PANASONIC BD COMBO 12.7mm Tray DL 4X UJ-130A LF W/O bezel SATA 2X Single Layer, 4X Double Layer	KO.00407.002
	ODD BEZEL-BD COMBO	42.WBF02.005
	ODD BRACKET	33.WBF02.003
LCD		
	ASSY LEC LCD MODULE 17.3" WXGA GLARE W/ ANTENNA *2, CAMERA, IMR	6M.WBF02.003

Category	Description	Acer Part Number
	LED LCD AUO 17.3" WXGA+ Glare B173RW01-V0 LF 220nit 8ms 600:1	LK.17305.001
	LED LCD SAMSUNG 17.3" WXGA+ Glare LTN173KT01-A01 LF 220nit 8ms 600:1	LK.17306.001
	LED LCD LPL 17.3" WXGA+ Glare LP173WD1-TLA1 LF 220nit 8ms 600:1	LK.17308.001
	LED LCD CMO 17.3" WXGA+ Glare N173O6-L02 LF 220nit 8ms 600:1	LK.1730D.001
	LCD COVER IMR-GTW	60.WBF02.009
	LCD COVER IMR-PB	60.WBF02.010
	ANTENNA MAIN (R -1X2)	50.WBF02.006
	ANTENNA AUX (L)	50.WBF02.007
	LCD BEZEL	60.WBF02.008
	LVDS CABLE	50.WBF02.008
	LCD BRACKET R+L	33.WBF02.004
	CAMERA 0.3M	57.WBF02.001
	ASSY LEC LCD MODULE 17.3" WXGA GLARE W/ ANTENNA *3, CAMERA, IMR	6M.WBK02.001
	LED LCD AUO 17.3" WXGA+ Glare B173RW01-V0 LF 220nit 8ms 600:1	LK.17305.001
	LED LCD SAMSUNG 17.3" WXGA+ Glare LTN173KT01-A01 LF 220nit 8ms 600:1	LK.17306.001
	LED LCD LPL 17.3" WXGA+ Glare LP173WD1-TLA1 LF 220nit 8ms 600:1	LK.17308.001
	LED LCD CMO 17.3" WXGA+ Glare N173O6-L02 LF 220nit 8ms 600:1	LK.1730D.001

Category	Description	Acer Part Number
	LCD COVER IMR-GTW	60.WBF02.009
	LCD COVER IMR-PB	60.WBF02.010
	ANTENNA MAIN (R -1X2)	50.WBF02.006
	ANTENNA AUX (L)	50.WBF02.007
	ANTENNA MIMO (R-3X3)	50.WBF02.009
	LCD BEZEL	60.WBF02.008
	LVDS CABLE	50.WBF02.008
	LCD BRACKET R+L	33.WBF02.004
	CAMERA 0.3M	57.WBF02.001
	ASSY LEC LCD MODULE 17.3" WXGA GLARE W/ ANTENNA *2, IMR, W/O CCD	6M.WBJ02.001
	LED LCD AUO 17.3" WXGA+ Glare B173RW01-V0 LF 220nit 8ms 600:1	LK.17305.001
	LED LCD SAMSUNG 17.3" WXGA+ Glare LTN173KT01-A01 LF 220nit 8ms 600:1	LK.17306.001
	LED LCD LPL 17.3" WXGA+ Glare LP173WD1-TLA1 LF 220nit 8ms 600:1	LK.17308.001
	LED LCD CMO 17.3" WXGA+ Glare N173O6-L02 LF 220nit 8ms 600:1	LK.1730D.001
	LCD COVER IMR-GTW	60.WBF02.009
	LCD COVER IMR-PB	60.WBF02.010
	ANTENNA MAIN (R -1X2)	50.WBF02.006

Category	Description	Acer Part Number
	ANTENNA AUX (L)	50.WBF02.007
	LCD BEZEL W/O CMOS	60.WBJ02.003
	LCD BRACKET R+L	33.WBF02.004
	ASSY LEC LCD MODULE 17.3" WXGA GLARE W/ ANTENNA *3, IMR, W/O CCD	6M.WBJ02.002
	LED LCD AUO 17.3" WXGA+ Glare B173RW01-V0 LF 220nit 8ms 600:1	LK.17305.001
	LED LCD SAMSUNG 17.3" WXGA+ Glare LTN173KT01-A01 LF 220nit 8ms 600:1	LK.17306.001
	LED LCD LPL 17.3" WXGA+ Glare LP173WD1-TLA1 LF 220nit 8ms 600:1	LK.17308.001
	LED LCD CMO 17.3" WXGA+ Glare N173O6-L02 LF 220nit 8ms 600:1	LK.1730D.001
	LCD COVER IMR-GTW	60.WBF02.009
	LCD COVER IMR-PB	60.WBF02.010
	ANTENNA MAIN (R -1X2)	50.WBF02.006
	ANTENNA AUX (L)	50.WBF02.007
	ANTENNA MIMO (R-3X3)	50.WBF02.009
	LCD BEZEL W/O CMOS	60.WBJ02.003
	LCD BRACKET R+L	33.WBF02.004

Category	Description	Acer Part Number
MAINBOARD		
	Mainboard ENLJ61_UMACck_NV76_72_UMACckM RS780 SB700 LF	MB.B5802.001
	Mainboard ENLJ61_M96_M92&NV76/72_M96_M92 RS780 SB700 LF	MB.B6002.001
HEATSINK		
	VGA THERMAL MODULE-M92M	60.WBW02.001
	VGA THERMAL MODULE-M96M	60.B6002.001
	CPU THERMAL MODULE	60.WBT02.001
	FAN-UMA	23.B5702.001
SPEAKER		
	MIC SET	23.WBF02.001
	SPEAKER	23.WBF02.002
MISCELLANEOUS		
	BATTERY MYLAR	42.WBF02.003
	RUBBER FOOT	47.WBF02.002
	NAME PLATE-NV78	40.WBG02.001
	NAME PLATE-NV74	40.WBF02.001
	NAME PLATE-ENLJ65	40.B5702.001
	LCD SCREW RUBBER	47.WBF02.001

Screw List

Category	Description	Part No.
Screw		
	SCREW M2.45D 8.0L K 5.5D 0.8T ZKNL	86.WBF02.001
	SCREW M2.5D 5L K 5.5D ZK NL + CR3	86.WBF02.010
	SCREW M2.46D 3.0L K 5.5D 0.8T ZKNL	86.WBF02.002
	SCREW M1.98D 3.0L K 4.6D 0.8T ZKNL	86.WBF02.003
	SCREW M2.5D 4.15L K 5.5D ZK NL CR3	86.WBF02.004
	SCREW M3.0D 3.0L K 4.9D NI	86.WBF02.005
	SCREW M2.5D 3.2L K 6D NI	86.WBF02.006
	SCREW M2D 4.0L K 4.6D NI NL	86.WBF02.007
	SCREW M2.0D 3L K 5D NI	86.WBF02.008
	SCREW ASSY THML SPRING	86.WBF02.009

Model Definition and Configuration

Packard Bell EasyNote LJ61 Series

Model	RO	Country	Acer Part No	Description	CPU
ENLJ61-644G50Mn	EMEA	France	LX.BA20Y.001	ENLJ61-644G50Mn VHB32BTFR1 M92XT512Cck2 2*2G/500_L/6L/5R/ CB_bgn_0.3D_GEc_FR61 EASYNOTE_LJ61-BG114FR	AAQL64
ENLJ61-644G32Mn	EMEA	France	LX.BA20X.001	ENLJ61-644G32Mn VHP32BTFR1 M92XT512Cck2 2*2G/320/6L/5R/ CB_bgn_0.3D_GEc_FR64 EASYNOTE_LJ61-SB112FR	AAQL64
ENLJ61-643G32Mn	EMEA	Holland	LX.BA20X.003	ENLJ61-643G32Mn VHP32BTNL1 M92XT512Cck2 1G+2G/320/6L/5R/ CB_bgn_0.3D_GEc_NL34 EASYNOTE_LJ61-SB-012NL	AAQL64
ENLJ61-644G50Mn	EMEA	Germany	LX.BA20X.002	ENLJ61-644G50Mn VHP32BTDE1 M92XT512Cck2 2*2G/500_L/6L/5R/ CB_bgn_0.3D_GEc_DE44 EASYNOTE_LJ61-SB-002GE	AAQL64
ENLJ61-824G25Mn	WW	WW	S2.B590Y.001	ENLJ616-824G25Mn VHB32BWW1 M92XT512Cck6 2*2G/250/BT/6L/ CB_bgn_0.3D_GEc_EN11	ATUZM82
ENLJ61-724G50Mn	EMEA	Germany	LX.B590X.002	ENLJ61-724G50Mn VHP32BTDE1 M92XT512Cck6 2*2G/500_L/BT/6L/5R/ CB_bgn_0.3D_GEk_DE44 EASYNOTE_LJ61-SB-003GE	ATRM72
ENLJ61-724G50Mn	EMEA	Portugal	LX.B590X.001	ENLJ61-724G50Mn VHP32BTP1 M92XT512Cck6 2*2G/500_L/6L/5R/ CB_bgn_0.3D_GEc_PT44 EASYNOTE_LJ61-SB-301PT	ATRM72
ENLJ61-644G50Mn	EMEA	Holland	LX.BAS0X.001	ENLJ61-644G50Mn VHP32BTNL1 M961GBCck2 2*2G/500_L/6L/5R/ CB_bgn_0.3D_GEc_NL34 EASYNOTE_LJ61-SB-016NL	AAQL64
ENLJ61-644G32Mn	EMEA	France	LX.BAS0X.004	ENLJ61-644G32Mn VHP32BTFR1 M961GBCck2 2*2G/320/6L/5R/ CB_bgn_0.3D_GEc_FR64 EASYNOTE_LJ61-SB-138FR	AAQL64
ENLJ61-644G32Mn	EMEA	Holland	LX.BAS0X.003	ENLJ61-644G32Mn VHP32BTNL1 M961GBCck2 2*2G/320/6L/5R/ CB_bgn_0.3D_GEc_NL34 EASYNOTE_LJ61-SB-015NL	AAQL64
ENLJ61-644G25Mn	EMEA	France	LX.BAS0X.002	ENLJ61-644G25Mn VHP32BTFR1 M961GBCck2 2*2G/250/6L/5R/ CB_bgn_0.3D_GEc_FR64 EASYNOTE_LJ61-SB116FR	AAQL64
ENLJ61-743G100Mn	EMEA	Nordic	LX.B600X.001	ENLJ61-743G100Mn VHP32BTND1 M961GBCck6 2G+1G/500_L+500_L/BT/6L/ 5R/CB_bgn_0.3D_GEc_ENU4 EASYNOTE_LJ61-SB-755NCD	ATRM74

Model	RO	Country	Acer Part No	Description	CPU
ENLJ61-644G50Mn	EMEA	Belgium	LX.B730X.003	ENLJ61-644G50Mn VHP32BTBE1 UMACck2 2*2G/500_L/6L/5R/ CB_bgn_0.3D_GEc_ENT4 EASYNOTE_LJ61-RB-001BE	AAQL64
ENLJ61-643G25Mn	EMEA	UK	LX.B730X.002	ENLJ61-643G25Mn VHP32BTGB1 UMACck2 1G+2G/250/6L/5R/ CB_bgn_0.3D_GEc_ENX4 EASYNOTE_LJ61-RB-110UK	AAQL64
ENLJ61-642G25Mn	EMEA	Nordic	LX.B730Y.004	ENLJ61-642G25Mn VHB32BTND1 UMACck2 2*1G/250/6L/5R/ CB_bgn_0.3D_GEc_ENU1 EASYNOTE_LJ61-RB-700NCD	AAQL64
ENLJ61-643G25Mn	EMEA	Belgium	LX.B730Y.003	ENLJ61-643G25Mn VHB32BTBE1 UMACck2 1G+2G/250/6L/5R/ CB_bgn_0.3D_GEc_ENT1 EASYNOTE_LJ61-RB-003BE	AAQL64
ENLJ61-644G25Mn	EMEA	Belgium	LX.B730X.006	ENLJ61-644G25Mn VHP32BTBE1 UMACck2 2*2G/250/6L/5R/ CB_bgn_0.3D_GEc_ENT4 EASYNOTE_LJ61-RB-002BE	AAQL64
ENLJ61-644G25Mn	EMEA	France	LX.B730Y.002	ENLJ61-644G25Mn VHB32BTFR1 UMACck2 2*2G/250/6L/5R/ CB_bgn_0.3D_GEc_FR61 EASYNOTE_LJ61-TB115FR	AAQL64
ENLJ61-644G32Mn	EMEA	Germany	LX.B730X.005	ENLJ61-644G32Mn VHP32BTDE1 UMACck2 2*2G/320/6L/5R/ CB_bgn_0.3D_GEc_DE44 EASYNOTE_LJ61-RB-001GE	AAQL64
ENLJ61-644G32Mn	EMEA	Portugal	LX.B730X.004	ENLJ61-644G32Mn VHP32BTPT1 UMACck2 2*2G/320/6L/5R/ CB_bgn_0.3D_GEc_PT44 EASYNOTE_LJ61-RB-300PT	AAQL64
ENLJ61-643G16Mi	EMEA	France	LX.B730Y.001	ENLJ61-643G16Mi VHB32BTFR1 UMACck2 1G+2G/160/6L/5R/CB_bg_0.3D_GEc_FR61 EASYNOTE_LJ61-TB110FR	AAQL64
ENLJ61-644G32Mn	EMEA	Spain	LX.B730X.001	ENLJ61-644G32Mn VHP32BTES1 UMACck2 2*2G/320/6L/5R/ CB_bgn_0.3D_GEc_ES54 EASYNOTE_LJ61-RB-302SP	AAQL64
ENLJ61-644G50Mn	EMEA	Belgium	LX.BBH0Y.001	ENLJ61-644G50Mn VHB32BTBE1 UMACck2 2*2G/500_L/6L/5R/ CB_bgn_0.3D_GEk_ENT1 EASYNOTE_LJ61-SB-004BE	AAQL64

Model	LCD	VGA Chip	VRAM 1	Memory 1	Memory 2	HDD 1 (GB)	HDD 2 (GB)
ENLJ61-644G50Mn	NLED17.3 WXGA+G	M92XT	512M-DDR2 (64*16*4)	SO2GBII6	SO2GBII6	N500GB 5.4KS	N
ENLJ61-644G32Mn	NLED17.3 WXGA+G	M92XT	512M-DDR2 (64*16*4)	SO2GBII6	SO2GBII6	N320GB 5.4KS	N
ENLJ61-643G32Mn	NLED17.3 WXGA+G	M92XT	512M-DDR2 (64*16*4)	SO1GBII6	SO2GBII6	N320GB 5.4KS	N
ENLJ61-644G50Mn	NLED17.3 WXGA+G	M92XT	512M-DDR2 (64*16*4)	SO2GBII6	SO2GBII6	N500GB 5.4KS	N
ENLJ61-824G25Mn	NLED17.3 WXGA+G	M92XT	512M-DDR2 (64*16*4)	SO2GBII6	SO2GBII6	N250GB 5.4KS	N
ENLJ61-724G50Mn	NLED17.3 WXGA+G	M92XT	512M-DDR2 (64*16*4)	SO2GBII6	SO2GBII6	N500GB 5.4KS	N

Model	LCD	VGA Chip	VRAM 1	Memory 1	Memory 2	HDD 1 (GB)	HDD 2 (GB)
ENLJ61-724G50Mn	NLED17.3 WXGA+G	M92XT	512M-DDR2 (64*16*4)	SO2GBII6	SO2GBII6	N500GB 5.4KS	N
ENLJ61-644G50Mn	NLED17.3 WXGA+G	M96	1G-DDR2 (64*16*8)	SO2GBII6	SO2GBII6	N500GB 5.4KS	N
ENLJ61-644G32Mn	NLED17.3 WXGA+G	M96	1G-DDR2 (64*16*8)	SO2GBII6	SO2GBII6	N320GB 5.4KS	N
ENLJ61-644G32Mn	NLED17.3 WXGA+G	M96	1G-DDR2 (64*16*8)	SO2GBII6	SO2GBII6	N320GB 5.4KS	N
ENLJ61-644G25Mn	NLED17.3 WXGA+G	M96	1G-DDR2 (64*16*8)	SO2GBII6	SO2GBII6	N250GB 5.4KS	N
ENLJ61-743G100Mn	NLED17.3 WXGA+G	M96	1G-DDR2 (64*16*8)	SO2GBII6	SO1GBII6	N500GB 5.4KS	N500GB 5.4KS
ENLJ61-644G50Mn	NLED17.3 WXGA+G	UMA	N	SO2GBII6	SO2GBII6	N500GB 5.4KS	N
ENLJ61-643G25Mn	NLED17.3 WXGA+G	UMA	N	SO1GBII6	SO2GBII6	N250GB 5.4KS	N
ENLJ61-642G25Mn	NLED17.3 WXGA+G	UMA	N	SO1GBII6	SO1GBII6	N250GB 5.4KS	N
ENLJ61-643G25Mn	NLED17.3 WXGA+G	UMA	N	SO1GBII6	SO2GBII6	N250GB 5.4KS	N
ENLJ61-644G25Mn	NLED17.3 WXGA+G	UMA	N	SO2GBII6	SO2GBII6	N250GB 5.4KS	N
ENLJ61-644G25Mn	NLED17.3 WXGA+G	UMA	N	SO2GBII6	SO2GBII6	N250GB 5.4KS	N
ENLJ61-644G25Mn	NLED17.3 WXGA+G	UMA	N	SO2GBII6	SO2GBII6	N250GB 5.4KS	N
ENLJ61-644G25Mn	NLED17.3 WXGA+G	UMA	N	SO2GBII6	SO2GBII6	N250GB 5.4KS	N
ENLJ61-644G32Mn	NLED17.3 WXGA+G	UMA	N	SO2GBII6	SO2GBII6	N320GB 5.4KS	N
ENLJ61-644G32Mn	NLED17.3 WXGA+G	UMA	N	SO2GBII6	SO2GBII6	N320GB 5.4KS	N
ENLJ61-643G16Mi	NLED17.3 WXGA+G	UMA	N	SO1GBII6	SO2GBII6	N160GB 5.4KS	N
ENLJ61-644G32Mn	NLED17.3 WXGA+G	UMA	N	SO2GBII6	SO2GBII6	N320GB 5.4KS	N
ENLJ61-644G50Mn	NLED17.3 WXGA+G	UMA	N	SO2GBII6	SO2GBII6	N500GB 5.4KS	N

Model	ODD	Extra SW1	Card Reader	Wireless LAN	Wireless LAN1	BT
ENLJ61-644G50Mn	NSM8XS	NIS	5 in 1-built in	3rd WiFi 1x2 BGN	3rd WiFi 1x2 BGN	N
ENLJ61-644G32Mn	NSM8XS	NIS	5 in 1-built in	3rd WiFi 1x2 BGN	3rd WiFi 1x2 BGN	N
ENLJ61-643G32Mn	NSM8XS	NIS	5 in 1-built in	3rd WiFi 1x2 BGN	3rd WiFi 1x2 BGN	N
ENLJ61-644G50Mn	NSM8XS	NIS	5 in 1-built in	3rd WiFi 1x2 BGN	3rd WiFi 1x2 BGN	N
ENLJ61-824G25Mn	NSM8XS	Norton 2009	5 in 1-built in	3rd WiFi 1x2 BGN	3rd WiFi 1x2 BGN	BT 2.0
ENLJ61-724G50Mn	NSM8XS	NIS	5 in 1-built in	3rd WiFi 1x2 BGN	3rd WiFi 1x2 BGN	BT 2.0
ENLJ61-724G50Mn	NSM8XS	NIS	5 in 1-built in	3rd WiFi 1x2 BGN	3rd WiFi 1x2 BGN	N
ENLJ61-644G50Mn	NSM8XS	NIS	5 in 1-built in	3rd WiFi 1x2 BGN	3rd WiFi 1x2 BGN	N

Model	ODD	Extra SW1	Card Reader	Wireless LAN	Wireless LAN1	BT
ENLJ61-644G32Mn	NSM8XS	NIS	5 in 1-built in	3rd WiFi 1x2 BGN	3rd WiFi 1x2 BGN	N
ENLJ61-644G32Mn	NSM8XS	NIS	5 in 1-built in	3rd WiFi 1x2 BGN	3rd WiFi 1x2 BGN	N
ENLJ61-644G25Mn	NSM8XS	NIS	5 in 1-built in	3rd WiFi 1x2 BGN	3rd WiFi 1x2 BGN	N
ENLJ61-743G100Mn	NSM8XS	NIS	5 in 1-built in	3rd WiFi 1x2 BGN	3rd WiFi 1x2 BGN	BT 2.0
ENLJ61-644G50Mn	NSM8XS	NIS	5 in 1-built in	3rd WiFi 1x2 BGN	3rd WiFi 1x2 BGN	N
ENLJ61-643G25Mn	NSM8XS	NIS	5 in 1-built in	3rd WiFi 1x2 BGN	3rd WiFi 1x2 BGN	N
ENLJ61-642G25Mn	NSM8XS	NIS	5 in 1-built in	3rd WiFi 1x2 BGN	3rd WiFi 1x2 BGN	N
ENLJ61-643G25Mn	NSM8XS	NIS	5 in 1-built in	3rd WiFi 1x2 BGN	3rd WiFi 1x2 BGN	N
ENLJ61-644G25Mn	NSM8XS	NIS	5 in 1-built in	3rd WiFi 1x2 BGN	3rd WiFi 1x2 BGN	N
ENLJ61-644G25Mn	NSM8XS	NIS	5 in 1-built in	3rd WiFi 1x2 BGN	3rd WiFi 1x2 BGN	N
ENLJ61-644G32Mn	NSM8XS	NIS	5 in 1-built in	3rd WiFi 1x2 BGN	3rd WiFi 1x2 BGN	N
ENLJ61-644G32Mn	NSM8XS	NIS	5 in 1-built in	3rd WiFi 1x2 BGN	3rd WiFi 1x2 BGN	N
ENLJ61-643G16Mi	NSM8XS	NIS	5 in 1-built in	3rd WiFi BG	3rd WiFi BG	N
ENLJ61-644G32Mn	NSM8XS	NIS	5 in 1-built in	3rd WiFi 1x2 BGN	3rd WiFi 1x2 BGN	N
ENLJ61-644G50Mn	NSM8XS	NIS	5 in 1-built in	3rd WiFi 1x2 BGN	3rd WiFi 1x2 BGN	N

Test Compatible Components

This computer's compatibility is tested and verified by Acer's internal testing department. All of its system functions are tested under Windows® XP Home, Windows® XP Pro environment.

Refer to the following lists for components, adapter cards, and peripherals which have passed these tests. Regarding configuration, combination and test procedures, please refer to the Packard Bell EasyNote LJ61 Compatibility Test Report released by the Acer Mobile System Testing Department.

Microsoft® Windows® Vista Environment Test

BRAND	Type	Description
Adapter		
DELTA	90W	Adapter DELTA 90W 19V 1.7x5.5x11 Blue ADP-90SB BBGE LV4, for OBL (for flicker issue) LED LF
Audio Codec		
Realtek	ALC272X	Realtek Audio Codec ALC272X
Battery		
PANASONIC	6CELL2.2	Battery PANASONIC AS-2007B Li-Ion 3S2P PANASONIC 6 cell 4400mAh Main COMMON PSS
SAMSUNG	6CELL2.2	Battery SAMSUNG AS-2007B Li-Ion 3S2P SAMSUNG 6 cell 4400mAh Main COMMON SDI 2.2F
SANYO	6CELL2.2	Battery SANYO AS-2007B Li-Ion 3S2P SANYO 6 cell 4400mAh Main COMMON Normal Type
SIMPLO	6CELL2.2	Battery SIMPLO AS-2007B Li-Ion 3S2P PANASONIC 6 cell 4400mAh Main COMMON PSS
SONY	6CELL2.2	Battery SONY AS-2007B Li-Ion 3S2P SONY 6 cell 4400mAh Main COMMON Normal Type
PANASONIC	8CELL2.4	Battery PANASONIC AS-2007B Li-Ion 4S2P PANASONIC 8 cell 4800mAh Main COMMON
SANYO	8CELL2.4	Battery SANYO AS-2007B Li-Ion 4S2P SANYO 8 cell 4800mAh Main COMMON
SIMPLO	8CELL2.4	Battery SIMPLO AS-2007B Li-Ion 4S2P PANASONIC 8 cell 4800mAh Main COMMON PSS
SONY	8CELL2.4	Battery SONY AS-2007B Li-Ion 4S2P SONY 8 cell 4800mAh Main COMMON
Bluetooth		
Foxconn	BT 2.0	Foxconn Bluetooth FOX_BRM_2.0 F/W 300
Camera		
Chicony	0.3M DV	Chicony 0.3M DV Calla_2G
Suyin	0.3M DV	Suyin 0.3M DV Camellia_2G
Card Reader		
N/A	5 in 1-Build in	5 in 1-Build in MS, MS Pro, SD, SC, XD
CPU/Processor		
AMD	AAQL60	CPU AMD Athlon64X2 QL60 PGA 1.9G 1M 638 35W Griffin B1
AMD	AAQL62	CPU AMD Athlon64X2 QL62 PGA 2.0G 1M 638 35W Griffin B1
AMD	AAQL64	CPU AMD Athlon64X2 QL64 PGA 2.1G 638 35W Griffin B1
AMD	AAQL65	CPU AMD Athlon QL65 PGA 2.1G 1M 638 35W Griffin B1 4.0 GT/s-inactive
AMD	ATRM72	CPU AMD Turion RM72 PGA 2.1G 1M 638 35W Griffin B1
AMD	ATRM74	CPU AMD Turion RM74 PGA 2.2G 1M 638 35W Griffin B1
AMD	ATRM75	CPU AMD Turion RM75 PGA 2.2G 1M 638 35W Griffin B1 4.0 GT/s
AMD	ATUZM82	CPU AMD TurionX2 ZM82 PGA 2.2G 2M 638 35W Griffin B1
AMD	ATUZM84	CPU AMD TurionX2 ZM84 PGA 2.3G 2M 638 35W Griffin B1

BRAND	Type	Description
AMD	ATUZM85	CPU AMD Turion Ultra ZM85 PGA 2.3G 2M 638 35W Griffin B1
AMD	ATUZM86	CPU AMD TurionX2 ZM86 PGA 2.4G 2M 638 35W Griffin B1
AMD	ATUZM87	CPU AMD Turion Ultra ZM87 PGA 2.4G 2M 638 35W Griffin B1
AMD	SMPSI4025W	CPU AMD SempronM SI40 PGA 2.0G 512K 638 25W Griffin B1
AMD	SMPSI4225W	CPU AMD SempronM SI42 PGA 2.1G 512K 638 25W Griffin B1
HDD		
HGST	N160GB5.4KS	HDD HGST 2.5" 5400rpm 160GB HTS543216L9A300 Falcon-B SATA LF F/W:C40C
SEAGATE	N160GB5.4KS	HDD SEAGATE 2.5" 5400rpm 160GB ST9160310AS Crockett SATA LF F/W:0303
WD	N160GB5.4KS	HDD WD 2.5" 5400rpm 160GB WD1600BEVT-22ZCTO ML160 SATA LF F/W:11.01A11
HGST	N250GB5.4KS	HDD HGST 2.5" 5400rpm 250GB HTS545025B9A300 Panther B SATA LF F/W:C60F
TOSHIBA	N250GB5.4KS	HDD TOSHIBA 2.5" 5400rpm 250GB MK2555GSX Libra SATA LF F/W:FG001J
HGST	N320GB5.4KS	HDD HGST 2.5" 5400rpm 320GB HTS545032B9A300 Panther B SATA LF F/W: C60F
SEAGATE	N320GB5.4KS	HDD SEAGATE 2.5" 5400rpm 320GB ST9320320AS Crockett SATA LF F/W:0303
WD	N320GB5.4KS	HDD WD 2.5" 5400rpm 320GB WD3200BEVT-22ZCT0 ML160 SATA LF F/W:11.01A11
HGST	N500GB5.4KS	HDD HGST 2.5" 5400rpm 500GB HTS545050B9A300 Panther B SATA LF F/W:C60F
TOSHIBA	N500GB5.4KS	HDD TOSHIBA 2.5" 5400rpm 500GB MK5055GSX Libra SATA LF F/W:FG001J
WD	N500GB5.4KS	HDD WD 2.5" 5400rpm 500GB WD5000BEVT-22ZAT0 ML250 SATA LF F/W:01.01A01
2nd HDD		
HGST	N160GB5.4KS	HDD HGST 2.5" 5400rpm 160GB HTS543216L9A300 Falcon-B SATA LF F/W:C40C
TOSHIBA	N160GB5.4KS	HDD TOSHIBA 2.5" 5400rpm 160GB MK1655GSX Libra SATA LF F/W: FG011J
TOSHIBA	N250GB5.4KS	HDD TOSHIBA 2.5" 5400rpm 250GB MK2555GSX Libra SATA LF F/W:FG001J
SEAGATE	N320GB5.4KS	HDD SEAGATE 2.5" 5400rpm 320GB ST9320320AS Crockett SATA LF F/W:0303
WD	N320GB5.4KS	HDD WD 2.5" 5400rpm 320GB WD3200BEVT-22ZCT0 ML160 SATA LF F/W:11.01A11
TOSHIBA	N500GB5.4KS	HDD TOSHIBA 2.5" 5400rpm 500GB MK5055GSX Libra SATA LF F/W:FG001J
Keyboard		
Gateway	GP-7T Black	Keyboard GP-7T Black SJM80 Internal 17 Standard Black NONE Texture

BRAND	Type	Description
LAN		
Broadcom	BCM5784	Broadcom BCM5784
LCD		
AUO	NLED17.3WXGA+G	LED LCD AUO 17.3" WXGA+ Glare B173RW01-V0 LF 220nit 8ms 600:1
CMO	NLED17.3WXGA+G	LED LCD CMO 17.3" WXGA+ Glare N173O6-L02 LF 220nit 8ms 600:1
LPL	NLED17.3WXGA+G	LED LCD LPL 17.3" WXGA+ Glare LP173WD1-TLA1 LF 220nit 8ms 600:1
SAMSUNG	NLED17.3WXGA+G	LED LCD SAMSUNG 17.3" WXGA+ Glare LTN173KT01-A01 LF 220nit 8ms 600:1
Memory		
HYNIX	SO1GBII6	Memory HYNIX SO-DIMM DDRII 667 1GB HMP112S6EFR6C-Y5 LF 64*16 0.055um
HYNIX	SO1GBII6	Memory HYNIX SO-DIMM DDRII 667 1GB HYMP112S64CP6-Y5 LF
MICRON	SO1GBII6	Memory MICRON SO-DIMM DDRII 667 1GB MT8HTF12864HDY-667G1 LF 64*16 0.065um
SAMSUNG	SO1GBII6	Memory SAMSUNG SO-DIMM DDRII 667 1GB M470T2864EH3-CE6 LF 64*16 0.055um
MICRON	SO1GBII8	Memory MICRON SO-DIMM DDRII 800 1GB MT8HTF12864HDY-800G1 LF 64*16 0.065um
NANYA	SO1GBII8	Memory NANYA SO-DIMM DDRII 800 1GB NT1GT64UH8D0FN-AD LF 64*16 0.07um
SAMSUNG	SO1GBII8	Memory SAMSUNG SO-DIMM DDRII 800 1GB M470T2864EH3-CF7 LF 64*16 0.055um
ELPIDA	SO2GBII6	Memory ELPIDA SO-DIMM DDRII 667 2GB EBE21UE8AESA-6E-F LF 128*8 0.065um
HYNIX	SO2GBII6	Memory HYNIX SO-DIMM DDRII 667 2GB HMP125S6EFR8C-Y5 LF 128*8 0.055um
HYNIX	SO2GBII6	Memory HYNIX SO-DIMM DDRII 667 2GB HYMP125S64CP8-Y5 LF
MICRON	SO2GBII6	Memory MICRON SO-DIMM DDRII 667 2GB MT16HTF25664HY-667G1 LF 128*8 0.065um
SAMSUNG	SO2GBII6	Memory SAMSUNG SO-DIMM DDRII 667 2GB M470T5663EH3-CE6 LF 128*8 0.055um
MICRON	SO2GBII8	Memory MICRON SO-DIMM DDRII 800 2GB MT16HTF25664HY-800G1 LF 128*8 0.065um
NANYA	SO2GBII8	Memory NANYA SO-DIMM DDRII 800 2GB NT2GT64U8HD0BN-AD LF 128*8 0.07um
SAMSUNG	SO2GBII8	Memory SAMSUNG SO-DIMM DDRII 800 2GB M470T5663EH3-CF7 LF 128*8 0.055um
Modem		
Lite On	Lite+Con MC4Z 1.5_3.3V Aus	Lite-On Conexant -Unizion 1.5_3.3v AUS RD02-D330
Northbridge Chipset		
AMD	AMDRS780MN	AMD RS780MN w/ HDCP EEPROM

BRAND	Type	Description
ODD		
HLDS	NBDCB4XS	ODD HLDS BD COMBO 12.7mm Tray DL 4X CT10 LF W/O bezel SATA
PLDS	NBDCB4XS	ODD PLDS BD COMBO 12.7mm Tray DL 4X DS-4E1S LF W/O bezel SATA
HLDS	NSM8XS	ODD HLDS Super-Multi DRIVE 12.7mm Tray DL 8X GT20N LF W/O bezel SATA
PANASONIC	NSM8XS	ODD PANASONIC Super-Multi DRIVE 12.7mm Tray DL 8X UJ880A LF W/O bezel SATA
PLDS	NSM8XS	ODD PLDS Super-Multi DRIVE 12.7mm Tray DL 8X DS-8A3S LF W/O bezel SATA
SONY	NSM8XS	ODD SONY Super-Multi DRIVE 12.7mm Tray DL 8X AD-7580S LF W/O bezel SATA
Southbridge Chipset		
AMD	AMDSB700	AMD SB700
Software		
Norton	NIS	Antivirus application NIS
VGA Chipset		
AMD	M92XT	AMD M92XT 55nm 29mm*29mm M2 package
AMD	M96	AMD M96 55nm 29mm*29mm M2 package
N/A	UMA	UMA (AMD)
VRAM		
N/A	1G-DDR2(64*16*8)	1G-DDR2 64*16*8
WiFi Antenna		
WNC	PIFA	PIFA
WLAN		
Foxconn	3rd WiFi 1x2 BGN	Foxconn Wireless LAN Atheros AR5B91 1x2 BGN
Foxconn	3rd WiFi BG	Foxconn FOX_ATH_XB63 Foxconn Atheros XB63 minicard b/g

Online Support Information

This section describes online technical support services available to help you repair your Acer Systems.

If you are a distributor, dealer, ASP or TPM, please refer your technical queries to your local Acer branch office. Acer Branch Offices and Regional Business Units may access our website. However some information sources will require a user i.d. and password. These can be obtained directly from Acer CSD Taiwan.

Acer's Website offers you convenient and valuable support resources whenever you need them.

In the Technical Information section you can download information on all of Acer's Notebook, Desktop and Server models including:

- Service guides for all models
- User's manuals
- Training materials
- Bios updates
- Software utilities
- Spare parts lists
- TABs (Technical Announcement Bulletin)

For these purposes, we have included an Acrobat File to facilitate the problem-free downloading of our technical material.

Also contained on this website are:

- Detailed information on Acer's International Traveler's Warranty (ITW)
- Returned material authorization procedures
- An overview of all the support services we offer, accompanied by a list of telephone, fax and email contacts for all your technical queries.

We are always looking for ways to optimize and improve our services, so if you have any suggestions or comments, please do not hesitate to communicate these to us.

A

- AFLASH Utility 35
- Antennas
 - Removing 98

B

- Battery Pack
 - Removing 46
 - Replacing 131
- BIOS
 - vendor 17
 - Version 17
- BIOS Utility 27–35
 - Boot 33
 - Exit 34
 - Navigating 27
 - Onboard Device Configuration 31
 - Power 33
 - Save and Exit 34
 - Security 30
 - System Security 34
- Board Layout
 - Top View 155

C

- Camera Module
 - Removing 92
 - Replacing 105
- Common Problems 134
- CPU
 - Removing 89
 - Replacing 108
- CPU Fan
 - Removing 87
 - Replacing 109

D

- DIMM Modules
 - Removing 51
 - Replacing 128
- Display 4

E

- EasyTouch Failure 148

- External Module Disassembly
 - Flowchart 45

F

- Features 1
- Flash Utility 35
- FPC Cable
 - Removing 95
 - Replacing 103
- FRU (Field Replaceable Unit) List 161

H

- Hard Disk Drive Modules
 - Replacing 127
- HDD1
 - Removing 54
 - Replacing 127
- HDD2
 - Removing 56
 - Replacing 127
- HDTV Switch Failure 149
- Hot Keys 13

I

- Indicators 11
- Intermittent Problems 150
- Internal Microphone Failure 140
- Internal Speaker Failure 138

J

- Jumper and Connector Locations 155

K

- Keyboard
 - Removing 63
 - Replacing 123
- Keyboard Failure 137

L

- LCD Bezel
 - Removing 91
 - Replacing 106

- LCD Brackets
 - Removing 95
 - Replacing 103
- LCD Failure 137
- LCD Module
 - Removing 65
 - Replacing 120
- LCD Module Disassembly
 - Flowchart 90
- LCD Module Reassembly Procedure 100
- LCD Panel
 - Removing 93
 - Replacing 103
- LED Board
 - Removing 76
 - Replacing 115
- Lower Covers
 - Removing 48
 - Replacing 129

M

- Main Module Reassembly Procedure 108
- Main Unit Disassembly
 - Flowchart 58
- Mainboard
 - Removing 84
 - Replacing 111
- Media Board
 - Removing 62
 - Replacing 124
- Media Board FFC
 - Removing 75
 - Replacing 115
- Memory Check 134
- MIC Board
 - Replacing 100
- Microphone Module
 - Removing 97
- Model Definition 176
- Modem Board
 - Removing 80
 - Replacing 113
- Modem Cable
 - Removing 85
 - Replacing 110
- Modem Failure 145

N

- No Display Issue 135

O

- ODD Failure 142
- ODD Module
 - Removing 49
 - Replacing 129
- Online Support Information 187

P

- Panel 5
 - Bottom 8
 - left 5
- PC Card 11
- Power Board
 - Removing 94
 - Replacing 100
- Power On Failure 134
- Primary HDD
 - Removing 54
 - Replacing 127

R

- RJ-11 Jack
 - Removing 85
 - Replacing 110
- RTC Battery
 - Removing 79

S

- SD Dummy Card
 - Removing 47
 - Replacing 131
- Secondary HDD
 - Removing 56
 - Replacing 127
- Speaker Module
 - Removing 77
 - Replacing 114
- Switch Cover
 - Removing 59
 - Replacing 125
- System
 - Block Diagram 4

T

Test Compatible Components 181

Thermal Grease 108

Thermal Module

Removing 88

Replacing 108

Thermal Unit Failure 148

TouchPad Bracket

Removing 74

Replacing 116

TouchPad Failure 138

Troubleshooting

Built-in KB Failure 137

EasyTouch Buttons 148

HDTV Switch 149

Internal Microphone 140

Internal Speakers 138

LCD Failure 137

Modem 145

No Display 135

ODD 142

Other Failures 149

Power On 134

Thermal Unit 148

TouchPad 138

WLAN 146

U

Undetermined Problems 150

Upper Cover

Removing 70

Replacing 116

USB Board

Removing 82

Replacing 112

utility

BIOS 27–35

W

Windows 2000 Environment Test 182

Wireless Function Failure 146

WLAN Module

Removing 52

Replacing 128

Free Manuals Download Website

<http://myh66.com>

<http://usermanuals.us>

<http://www.somanuals.com>

<http://www.4manuals.cc>

<http://www.manual-lib.com>

<http://www.404manual.com>

<http://www.luxmanual.com>

<http://aubethermostatmanual.com>

Golf course search by state

<http://golfingnear.com>

Email search by domain

<http://emailbydomain.com>

Auto manuals search

<http://auto.somanuals.com>

TV manuals search

<http://tv.somanuals.com>