

OLYMPUS[®]

DIGITAL CAMERA

SP-800UZ

Instruction Manual

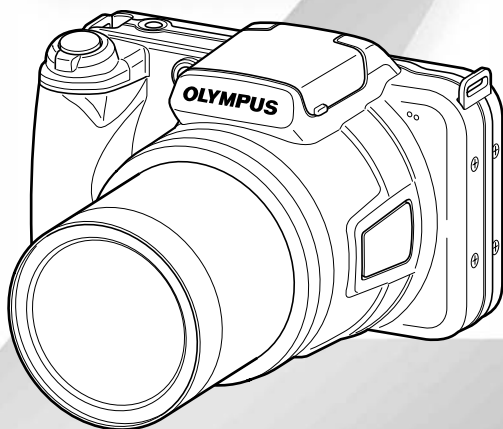

- Thank you for purchasing an Olympus digital camera. Before you start to use your new camera, please read these instructions carefully to enjoy optimum performance and a longer service life. Keep this manual in a safe place for future reference.
- The application software and instruction manual PDF file are stored on the internal memory of the camera.
- We recommend that you take test shots to get accustomed to your camera before taking important photographs.
- In the interest of continually improving products, Olympus reserves the right to update or modify information contained in this manual.

Step 1

Checking the contents of the box



Digital camera



Lens cap and lens cap strap



Lithium Ion Battery (LI-50B)



Camera strap



USB cable



AV cable



or

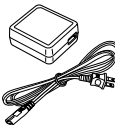

USB-AC adapter (F-2AC)

Other accessories not shown: Warranty card
Contents may vary depending on purchase location.

Step 2

Preparing the Camera

"Preparing the Camera" (p. 10)

Step 3

Shooting and Playing Back Images

"Shooting, Playback, and Erasing" (p. 15)

Step 4

How to Use the Camera

"Camera Settings" (p. 3)

Step 5

Printing

"Direct printing (PictBridge)" (p. 48)

"Print Reservations (DPOF)" (p. 51)

Contents

➤ Names of Parts	6	➤ Menus for Playback, Editing, and Printing Functions	35
➤ Preparing the Camera	10	➤ Menus for Other Camera Settings	41
➤ Shooting, Playback, and Erasing	15	➤ Printing	48
➤ Using Shooting Modes	21	➤ Usage Tips	53
➤ Using Shooting Functions	26	➤ Appendix	58
➤ Menus for Shooting Functions... ..	30		

Camera Settings

Using the Direct Buttons

Frequently used functions can be accessed using the direct buttons.

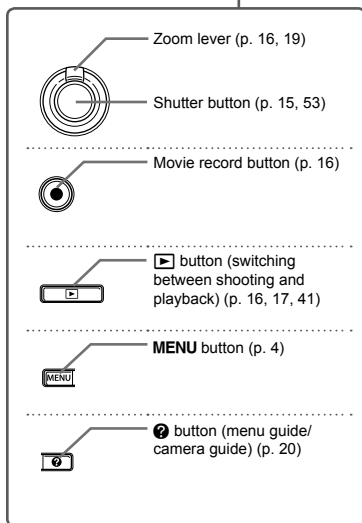
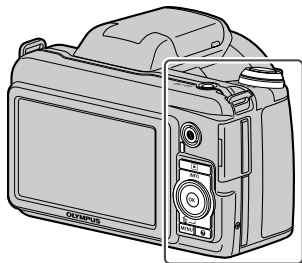

Operation guide

The symbols Δ ∇ \triangleleft \triangleright displayed for image selections and settings indicate that the wheel controller is to be used by pressing, not turning, the wheel controller sections shown below.



Wheel controller

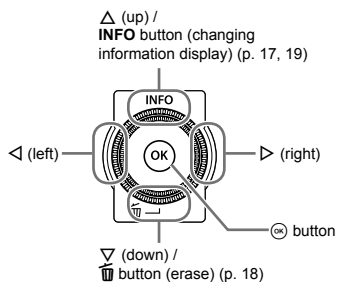

Operation guides displayed at the bottom of the screen indicate that the MENU button, Ⓜ button, or zoom lever be used.

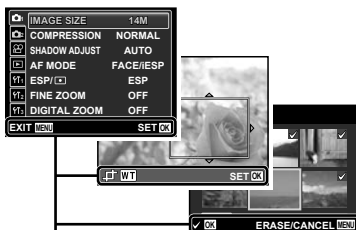

Operation guide

Using the Menu

Use the menu to change camera settings such as the shooting mode.

Press the **MENU** button to display the function menu. The function menu can be used to set frequently used shooting and playback functions such as shooting mode.

Shooting

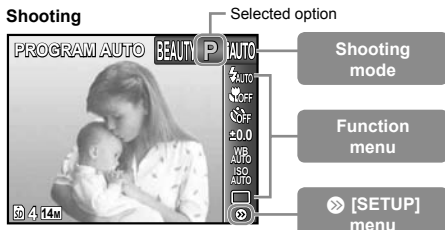

To select the shooting mode

Use \triangleleft to select the shooting mode and press the \odot button.

To select the function menu

Use \triangle ∇ to select a menu and use \triangleleft to select a menu option. Press the \odot button to set the function menu.

Playback

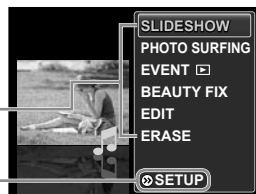

Use \triangle ∇ to select a menu and press the \odot button.

In the [SETUP] menu, various camera functions can be set, including shooting and playback functions not displayed in the function menu, and other settings such as date, time and screen display.

1 Select [SETUP] and then press the \odot button.

- The [SETUP] menu is displayed.

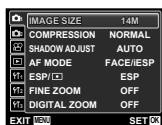

2 Press \triangleleft to select the page tabs. Use \triangle ∇ to select the desired page tab and press \triangleright .

Page tab

Submenu 1



3 Use \triangle ∇ to select the desired submenu 1 and then press the \odot button.

Submenu 2

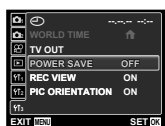

4 Use \triangle ∇ to select the desired submenu 2 and then press the \odot button.

- Once a setting is selected, the display returns to the previous screen.

⚠ There may be additional operations. "Menu Settings" (p. 30 to 47)

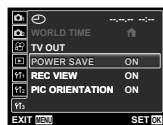

5 Press the MENU button to complete the setting.

- ⚠ Some functions cannot be used in some shooting modes. In such cases, the following message is displayed after setting.

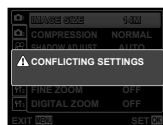

Menu Index

Menus for Shooting Functions

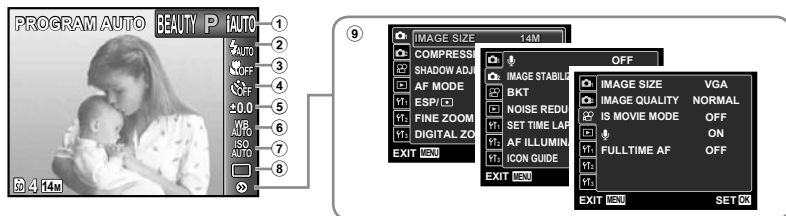

- | | | |
|---|---|---|
| <p>① Shooting mode
 P (PROGRAM AUTO)..... p. 15
 iAUTO (iAUTO)..... p. 21
 SCN (SCENE MODE) p. 21
 MAGIC (MAGIC FILTER)..... p. 23
 ∞ (PANORAMA) p. 23
 BEAUTY (BEAUTY)..... p. 25</p> <p>② Flash p. 26</p> <p>③ Macro p. 26</p> <p>④ Self-timer p. 27</p> <p>⑤ Exposure compensation..... p. 27</p> <p>⑥ White balance..... p. 28</p> <p>⑦ ISO p. 28</p> | <p>⑧ Drive p. 29</p> <p>⑨ ⊞ (SETUP)
 IMAGE SIZE
 (Still images)..... p. 30
 IMAGE SIZE (Movies) p. 30
 COMPRESSION
 (Still images)..... p. 30
 IMAGE QUALITY
 (Movies)..... p. 30
 SHADOW ADJUST p. 31
 AF MODE p. 31
 ESP/□ p. 32
 FINE ZOOM p. 32</p> | <p>DIGITAL ZOOM p. 32
 (Still images)..... p. 33
 (Movies)..... p. 33
 IMAGE STABILIZER
 (Still images)/
 IS MOVIE MODE
 (Movies)..... p. 33
 BKT..... p. 33
 NOISE REDUCT. p. 34
 SET TIME LAPSE p. 34
 FULLTIME AF p. 34
 AF ILLUMINAT. p. 34
 ICON GUIDE p. 34</p> |
|---|---|---|

Menus for Playback, Editing, and Printing Functions

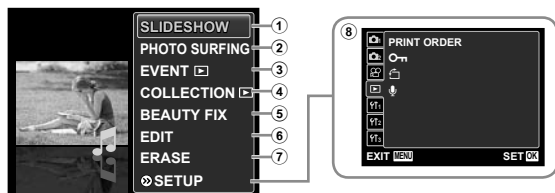

- | | | |
|--|---|--|
| <p>① SLIDESHOW p. 35</p> <p>② PHOTO SURFING..... p. 35</p> <p>③ EVENT ▶ p. 36</p> <p>④ COLLECTION ▶ p. 36</p> <p>⑤ BEAUTY FIX..... p. 37</p> | <p>⑥ EDIT p. 38</p> <p>⑦ ERASE p. 39</p> <p>⑧ ⊞ (SETUP)
 PRINT ORDER..... p. 40
 On (Protect) p. 40</p> | <p>⌂ (Rotate)..... p. 40
 🔊 (Add sound to still images)
 p. 40</p> |
|--|---|--|

Menus for Other Camera Settings

- | | | |
|---|---|--|
| <p>① Y1 (Settings 1)
 INTERNAL/SD p. 41
 MEMORY FORMAT/
 FORMAT..... p. 41
 DATA REPAIR p. 41
 📄→📄 COPY p. 41
 🗣 (Language) p. 41
 RESET..... p. 42
 USB CONNECTION p. 42</p> <p>② Y2 (Settings 2)
 ▶ POWER ON p. 42
 SAVE SETTINGS p. 42</p> | <p>Y3 (Settings 3)
 📅 (Date/time)..... p. 44
 WORLD TIME..... p. 45
 TV OUT p. 45
 POWER SAVE..... p. 47
 REC VIEW p. 47
 PIC ORIENTATION p. 47</p> | <p>PW ON SETUP p. 42
 SOUND SETTINGS p. 43
 FILE NAME p. 43
 PIXEL MAPPING p. 44
 🖥 (Monitor) p. 44</p> |
|---|---|--|



Names of Parts

Camera unit

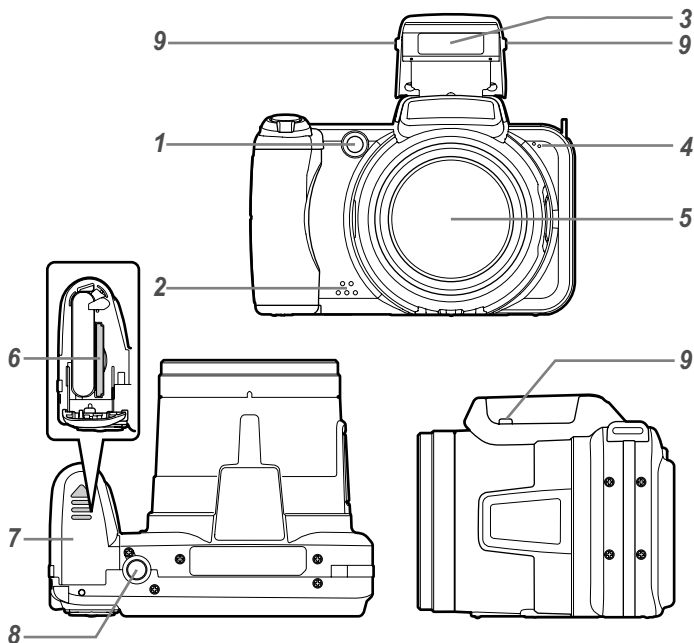

- | | | | | | |
|---|--|-----------|---|-----------------------------------|-------|
| 1 | Self-timer lamp/
AF illuminator | p. 27, 34 | 6 | Card slot..... | p. 14 |
| 2 | Speaker | | 7 | Battery/card compartment cover... | p. 10 |
| 3 | Flash | p. 26 | 8 | Tripod socket | |
| 4 | Microphone | p. 33, 40 | 9 | Flash knob (Flash flip-up)..... | p. 26 |
| 5 | Lens | p. 58 | | | |

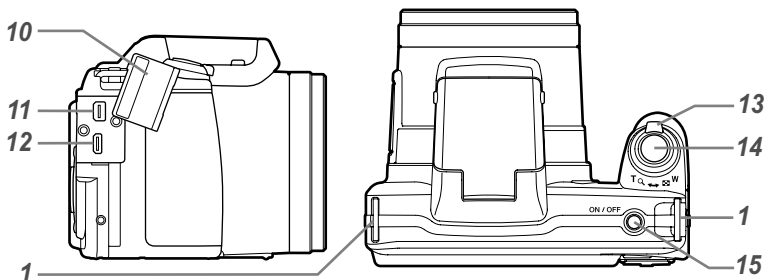
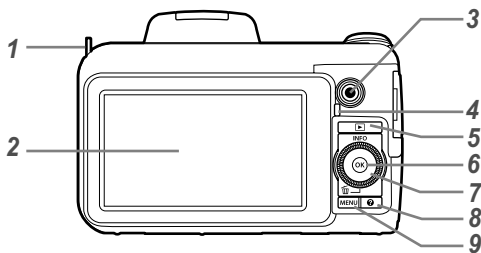

- | | |
|--|--|
| <p>1 Strap eyelet p. 10</p> <p>2 Monitor p. 8, 15, 44, 53</p> <p>3 Movie record button p. 16</p> <p>4 Indicator lamp</p> <p>5 button (switching between shooting and playback) p. 16, 17, 42</p> <p>6 button (OK) p. 3</p> <p>7 Wheel controller p. 3</p> <p style="padding-left: 20px;">INFO button (changing information display) p. 17, 19</p> <p style="padding-left: 20px;"> button (erase) p. 18</p> | <p>8 button (camera guide/menu guide) p. 20</p> <p>9 MENU button p. 3, 4</p> <p>10 Connector cover p. 11, 12, 46, 48</p> <p>11 Multi-connector p. 11, 12, 46, 48</p> <p>12 HDMI micro connector p. 46</p> <p>13 Zoom lever p. 16, 19</p> <p>14 Shutter button p. 15, 53</p> <p>15 ON/OFF button p. 13, 15</p> |
|--|--|

Shooting mode display

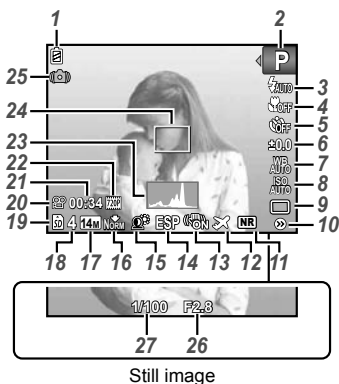

- | | |
|--|--|
| 1 Battery check p. 12, 54 | 15 Shadow Adjustment Technology
..... p. 31 |
| 2 Shooting mode p. 15, 21 | 16 Compression (still images)..... p. 30, 61 |
| 3 Flash p. 26 | 17 Image size (still images)..... p. 30, 61 |
| 4 Macro/super macro p. 26 | 18 Number of storable still pictures
(still images)..... p. 15 |
| 5 Self-timer p. 27 | 19 Current memory p. 60 |
| 6 Exposure compensation p. 27 | 20 Movie recording icon p. 16 |
| 7 White balance p. 28 | 21 Remaining recording time
(movies) p. 16 |
| 8 ISO p. 28 | 22 Image size (movies)..... p. 30 |
| 9 Drive p. 29 | 23 Histogram p. 17 |
| 10 [SETUP] menu p. 4, 5 | 24 AF target mark p. 15 |
| 11 Noise reduction p. 34 | 25 Camera shake warning |
| 12 World time p. 45 | 26 Aperture value..... p. 15 |
| 13 Image stabilization (still images)/
Digital image stabilization (movies)
..... p. 33 | 27 Shutter speed p. 15 |
| 14 Metering p. 32 | |

Playback mode display

• Standard display

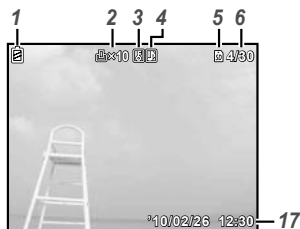

Still image



Movie

• Advanced display

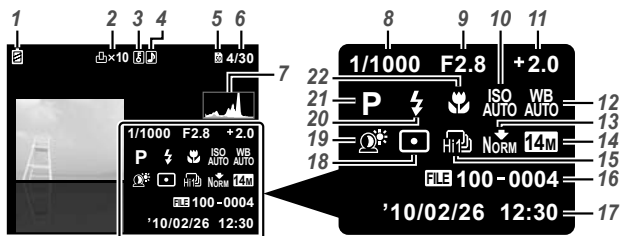

- | | |
|--|---|
| 1 Battery check p. 12, 54 | 11 Exposure compensation..... p. 27 |
| 2 Print reservation/
number of prints p. 51, 50 | 12 White balance p. 28 |
| 3 Protect..... p. 40 | 13 Compression (still images)..... p. 30, 61
Image quality (movies) p. 30, 61 |
| 4 Adding sound p. 33, 40 | 14 Image size p. 30, 61 |
| 5 Current memory p. 60 | 15 Drive p. 29 |
| 6 Number of frame/total number of
images (still images) p. 17
Elapsed time/total recording time
(movies) p. 18 | 16 File number |
| 7 Histogram p. 17 | 17 Date and time p. 13 |
| 8 Shutter speed p. 15 | 18 Metering p. 32 |
| 9 Aperture value p. 15 | 19 Shadow Adjustment Technology
..... p. 31 |
| 10 ISO p. 28 | 20 Flash p. 26 |
| | 21 Shooting mode p. 15, 21 |
| | 22 Macro p. 26 |

Preparing the Camera

Attaching the camera strap and lens cap

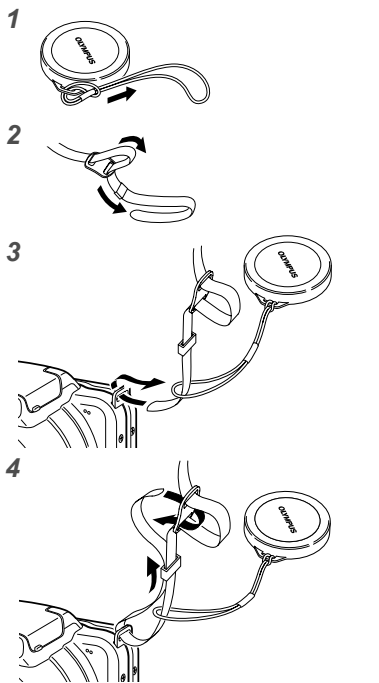

- Attach the strap to the other eyelet in the same manner.

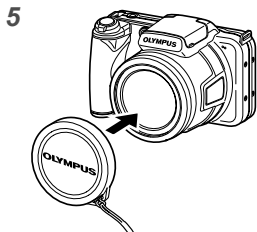

- ! Pull the strap tight so that it does not come loose.

Inserting the battery

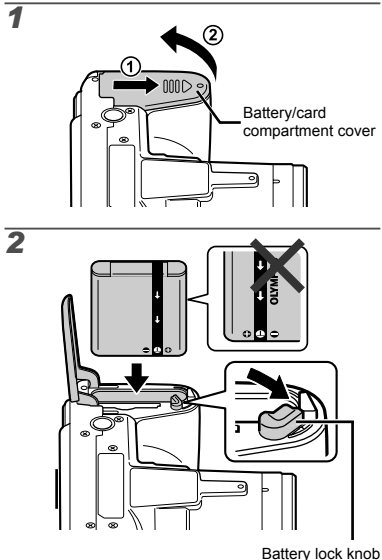

- ! Align \oplus to the battery lock knob side and insert as shown in the figure. If you insert the battery reversely, the camera will not turn on even if the **ON/OFF** button is pressed. Damage to the battery exterior (scratches, etc.) may produce heat or an explosion.
- ! Insert the battery while sliding the battery lock knob in the direction of the arrow.
- ! Slide the battery lock knob in the direction of the arrow to unlock, and then remove the battery.
- ! Turn off the camera before opening the battery/card compartment cover.
- ! When using the camera, be sure to close the battery/card compartment cover.

Battery charge and camera setup

Connect the camera to the computer to charge the battery and setup the camera.

System requirements

Windows XP (SP2 or later)/
Windows Vista/Windows 7

When using another system other than the above or no computer, see “Charging the battery with the included USB-AC adapter.” (p. 12)

1 Connect the camera to the computer.

Open the connector cover in the direction of the arrow.

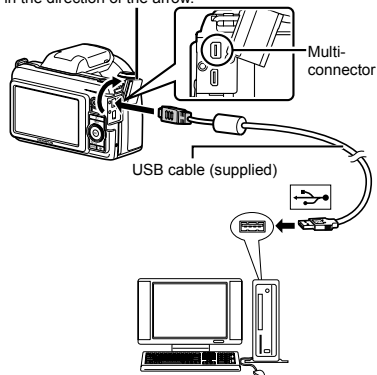

Charging the battery

When the camera is connected to the computer, the battery in the camera will be charged.

- When charging, the indicator lamp light. When charging is complete, the indicator lamp will turn off.
- ❗ If the indicator lamp does not light, the camera may be incorrectly connected, or the battery, camera, computer, or USB cable may not be functioning correctly.

Camera setup

Set the camera date and time, time zone and display language automatically; install the camera instruction manual and PC software (ib).

- ❗ Do not insert SD/SDHC memory cards before the camera setup.
- ❗ Do not format the internal memory until the camera setup is complete. Doing so will erase the camera instruction manual and the PC software (ib) data that are stored on the internal memory.
- ❗ Check that your computer meets the following system requirements:
Windows XP (SP2 or later)/
Windows Vista/Windows 7
- ❗ Refer to the PC software (ib) help guide for details on how to use the PC software (ib).

2 Select and execute “OLYMPUS Camera Initialization”, which is displayed on the computer screen when the camera is recognized by the computer.

- ❗ If nothing is displayed on the camera screen even after connecting the camera to the computer, the battery may be exhausted. Leave the camera connected to the computer until the battery has charged, then disconnect and reconnect the camera.
- ❗ Even if a computer has USB ports, proper operation is not guaranteed in the following cases.
 - Computers with USB ports installed using an expansion card, etc.
 - Computers without a factory-installed OS and home-built computers
- ❗ Double-click the icon for the camera drive (Removable Disk), and then execute CameralInitialSetup.exe to start the camera setup.

3 Follow the instructions on the computer screen and setup the camera.

Charging the battery with the included USB-AC adapter

- ❗ The included USB-AC adapter (F-2AC) (hereafter referred as AC adapter) has been designed to be used for charging and playback. Make sure that shooting is not being used while the AC adapter is connected to the camera.

Example: AC adapter with an AC cable

1

Open the connector cover in the direction of the arrow.

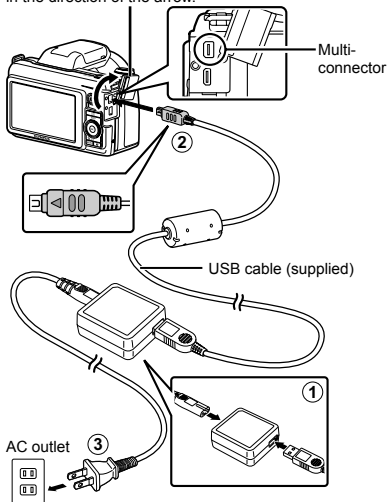

2



- ❗ The battery is not fully charged at shipment. Before use, be sure to charge the battery until the indicator lamp turns off (up to 3.5).
- ❗ If the indicator lamp does not light, the AC adapter is not connected to the camera correctly, or the battery, camera, or AC adapter may be broken.
- ❗ For details on the battery and the AC adapter, see "Battery, USB-AC adapter (included), Charger (sold separately)" (p. 58).
- ❗ Battery can be charged by connecting the camera to the computer. However, when charging with the system other than Windows XP (SP2 or later)/Windows Vista/Windows 7, charging takes much time.

When to charge the batteries

Charge the battery when the error message shown below appears.

Flashes in red



Monitor top left



Error message

When not using a computer

See the next section under "Setting the date, time and time zone."

When using a computer with system other than Windows XP (SP2 or later)/Windows Vista/Windows 7

The Instruction Manual PDF file can be saved on a computer with the following procedure.

- Connect the camera to the computer and copy the instruction manual PDF file for your language in the "Manual" folder in the internal memory of the camera.

Setting the date, time and time zone

The date and time set here are saved to image file names, date prints, and other data.

1 Press the ON/OFF button to turn on the camera.

- The date and time setting screen is displayed when the date and time are not set.

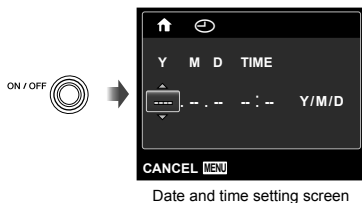

2 Use Δ ∇ to select the year for [Y].

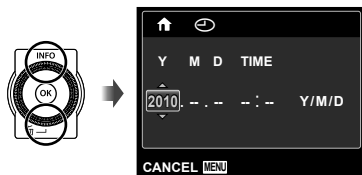

3 Press \triangleright to save the setting for [Y].



4 As in Steps 2 and 3, use Δ ∇ \triangleleft \triangleright and the OK button to set [M] (month), [D] (day), [TIME] (hours and minutes), and [Y/M/D] (date order).

- For a more accurate setting, press the OK button when the time signal hits 00 seconds.
- To change the date and time, adjust the setting from the menu. [Date/time] (p. 44)

5 Use \triangleleft \triangleright to select the [Time zone] time zone and then press the OK button.

- Use Δ ∇ to turn daylight saving time ([SUMMER]) on or off.



- The menu can be used to change the selected time zone. [WORLD TIME] (p. 45)

Changing the display language

The language for the menu and error messages displayed on the monitor is adjustable.

1 Display the [SETUP] menu.

! "Using the Menu" (p. 4)

2 Use Δ ∇ to select the Υ 1 (Settings 1) tab and then press \triangleright .

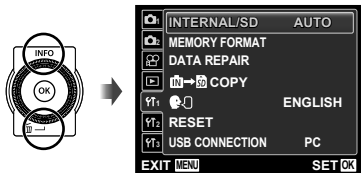

3 Use Δ ∇ to select [Υ 1] and press the \odot button.

4 Use Δ ∇ \triangleleft \triangleright to select your language and press the \odot button.

5 Press the MENU button.

Inserting the SD/SDHC memory card (sold separately)

! Always use SD/SDHC memory cards with this camera. Do not insert other types of memory card. "Using an SD/SDHC memory card" (p. 59)

! Although the camera can store images in internal memory, SD/SDHC memory cards (sold separately) can be also used to store pictures.

1

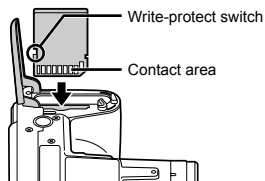

! Insert the card straight until it clicks into place.

! Do not touch the contact area directly.

2

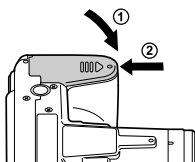

! "Number of storable pictures (still images)/ Remaining recording time (movies) in the internal memory and SD/SDHC memory cards" (p. 61)

To remove the SD/SDHC memory card

1

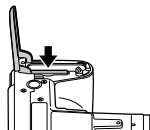

2

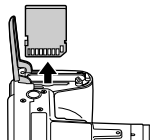

! Press the card in until it clicks and comes out slightly, then remove the card.

Shooting, Playback, and Erasing

Shooting with the optimum aperture value and shutter speed (P mode)

In this mode, automatic shooting settings are activated while also allowing changes to a wide range of other shooting menu functions, such as exposure compensation, white balance, etc. as needed.

1 Remove the lens cap.

2 Press the ON/OFF button to turn on the camera.

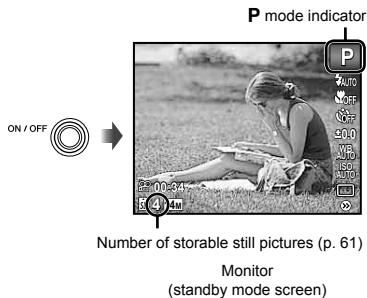

- ! If **P** mode is not displayed, press the **MENU** button to display the function menu screen and then set the shooting mode to **P**. "Using the Menu" (p. 4)

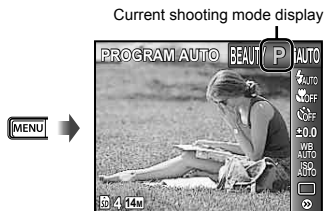

- ! Press the **ON/OFF** button again to turn off the camera.

3 Hold the camera and compose the shot.

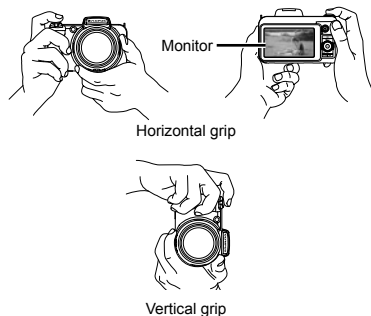

- ! When holding the camera, take care not to cover the flash with your fingers, etc.

4 Press the shutter button halfway down to focus on the subject.

- When the camera focuses on the subject, the exposure is locked (shutter speed and aperture value are displayed), and the AF target mark changes to green.
- The camera was unable to focus if the AF target mark flashes red. Try focusing again.

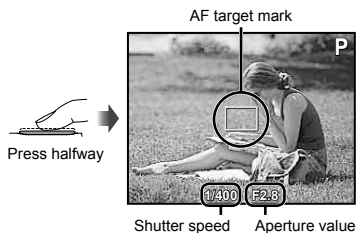

- ! "Focusing" (p. 55)

- 5** To take the picture, gently press the shutter button all the way down while being careful not to shake the camera.



Image review screen

To view images during shooting

Pressing the button enables playback of images. To return to shooting, either press the button or press the shutter button halfway down.

Shooting movies

- 1** Press the movie record button to start recording.

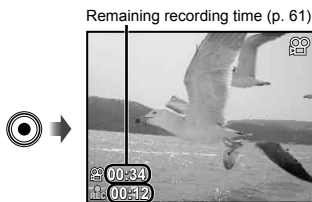

Recording time
Lights up red when recording

- ⚠ The effects of the set shooting mode can be used when shooting movies (when **MAGIC** mode, mode or **BEAUTY** mode is set, shooting is performed with the **P** mode setting).
- ⚠ Sound will also be recorded.
- ⚠ During sound recording, only the digital zoom can be used. To record a movie with optical zoom, set (movies) (p. 33) to [OFF].

- 2** Press the movie record button again to stop recording.

Using the zoom

Turning the zoom lever adjusts the shooting range.

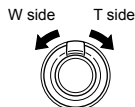

- ⚠ Optical zoom: 30x, Digital zoom: 5x

To take larger images without reducing image quality

[FINE ZOOM] (p. 32)

To take larger images

[DIGITAL ZOOM] (p. 32)

- ⚠ The zoom bar appearance identifies the status of the fine zoom/digital zoom.

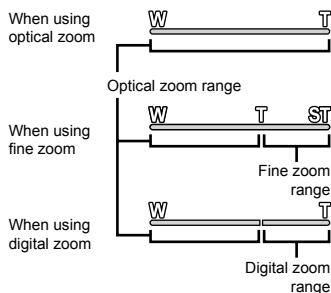

Changing the shooting information display

The display of the screen information can be changed to best match the situation, for example, the need for a clear view of the screen or for making a precise composition by using the grid display.

1 Press Δ (INFO).

- The displayed shooting information changes in the order shown below each time the button is pressed. "Shooting mode display" (p. 8)

Normal



No information



Detailed



Reading a histogram

If the peak fills too much of the frame, the image will appear mostly white.

If the peak fills too much of the frame, the image will appear mostly black.

The green section shows luminance distribution within the screen's center.



Viewing images

1 Press the \blacktriangleright button.

Number of frames/
Total number of images



Playback image

2 Turn the wheel controller to select an image.

- It can be performed by pressing \triangleleft \triangleright .

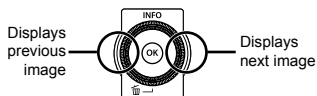

- ⚠ Keep turning the wheel controller to fast forward or reverse. It can be performed by holding \triangleleft \triangleright .
- ⚠ The display size of the images can be changed. "Index view, close-up view, and event index" (p. 19)

To play sound recordings

To play sound recorded with an image, select the image and press the OK button. A M icon appears on images with which sound has been recorded.

- ⚠ M (still images) (p. 33)



During audio playback

To play back movies

Select a movie, and press the **OK** button.



Movie

Operations during movie playback



Elapsed time/
Total recording
time

During playback

Pausing and restarting playback	Press the OK button to pause playback. During pause, fast forward or reverse, press the OK button to restart playback.
Fast forward	Press ▶ to fast forward. Press ▶ again to increase the fast forward speed.
Rewind	Press ◀ to rewind. The speed at which the recording rewinds increases each time ◀ is pressed.
Adjusting the volume	Turn the wheel controller or use ▲▼ to adjust the volume.

Operations while playback is paused



During pause

Cueing	Use ▲ to display the first frame and press ▼ to display the last frame.
Advancing and rewinding one frame at a time^{*1}	Turn the wheel controller to advance or rewind by one frame at a time. Keep turning the wheel controller for continuous advance or rewind.
Resuming playback	Press the OK button to resume playback.

To operate with **◀▶**

^{*1} Press **▶** or **◀** to advance or rewind one frame at a time. Hold **▶** or **◀** pressed for continuous advance or rewind.

To stop movie playback

Press the **MENU** button.

Erasing images during playback (Single image erase)

- 1 Display the image you want to erase and press **▼** (**⏏**).



- 2 Press **▲▼** to select **[ERASE]**, and press the **OK** button.

! **[ALL ERASE]** (p. 39) and **[SEL. IMAGE]** (p. 39) can be used to erase multiple images at the same time.

Index view, close-up view, and event index

Index view enables quick selection of a desired image. Close-up view (up to 10x magnification) allows checking of image details. In event index¹, images are grouped by the shooting dates and representative images for an event can be displayed.

¹ Pictures with different dates can be grouped into the same event using the PC software (ib).

1 Turn the zoom lever.



W side T side



To select an image in index view

Use $\Delta \nabla \triangleleft \triangleright$ to select an image, and press the INFO button to display the selected image in single-image view.

To scroll an image in close-up view

Use $\Delta \nabla \triangleleft \triangleright$ to move the viewing area.

To select an image in event index

Use $\triangleleft \triangleright$ to select the representative image and press the INFO button. The images in the selected event are played back.

Changing the image information display

Shooting information settings displayed on the screen can be changed.

1 Press Δ (INFO).

- The displayed image information changes in the order shown below each time the button is pressed.

Normal



No information



Detailed



 "Reading a histogram" (p. 17)

Playing back panorama images

Panorama images that were combined together using [AUTO] or [MANUAL] can be scrolled for viewing.

- ! "Creating panoramic images (mode)" (p. 23)

1 Select a panorama image during playback.

- ! "Viewing images" (p. 17)



2 Press the OK button.



Current viewing area

To control panorama image playback

Zoom in/Zoom out: Press the OK button to pause playback. Then turn the zoom lever to enlarge/shrink the image.

Playback direction: Press the OK button to pause playback. Then press Δ ∇ \triangleleft \triangleright to scroll the image in the direction of the pressed button.

Pause: Press the OK button.

Restart scrolling: Press the OK button.

Stop playback: Press the MENU button.

Using the menu guide

If the ? button is pressed while settings are being adjusted in the playback function or [SETUP] menus, a description of the selected option is displayed.

- ! "Using the Menu" (p. 4)

Using the camera guide

Use the camera guide to look up camera operations.

1 Press the ? button in the standby mode screen or the playback screen.

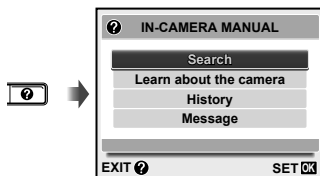

Submenu 2	Application
Search	Functions or operating methods can be searched from a term or shooting objective.
Learn about the camera	Information is shown about recommended functions and basic operating methods for the camera.
History	Searches can be performed from the search history.
Message	Messages from the camera can be viewed.

2 Use Δ ∇ to select the desired item and press the OK button to set.

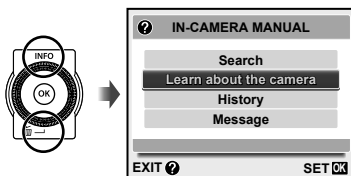

- Follow the on-screen instructions to search the desired contents.

Using Shooting Modes

To change the shooting mode

- ! The shooting mode (**P**, **IAUTO**, **SCN**, **MAGIC**, **BEAUTY**) can be changed with using the function menu. "Using the Menu" (p. 4)

Shooting with automatic settings (IAUTO mode)

The camera will automatically select the optimal shooting mode for the scene. This is a fully automatic mode that allows you to take a picture suited to the scene by simply pressing the shutter button. In **IAUTO** mode, settings in the shooting menu can be selected, but the changed setting is not reflected in the actual shot.

1 Set the shooting mode to IAUTO.

The icon changes depending on the scene that the camera automatically selects.



- ! In some cases, the camera may not select the desired shooting mode.
- ! When the camera cannot identify the optimal mode, **P** mode will be selected.

Using the best mode for the shooting scene (SCN mode)

1 Set the shooting mode to SCN.



2 Press ▽ to go to the submenu.



3 Use ◀▶ to select the mode and then press the OK button to set.



Icon indicating the scene mode that is set

- ❗ In **SCN** modes, the optimum shooting settings are pre-programmed for specific shooting scenes. For this reason, settings may not be changed in some modes.

Option	Application
📷 PORTRAIT/ 🏞️ LANDSCAPE/ 🌃 NIGHT SCENE ¹⁾ / 🌃 NIGHT+PORTRAIT ¹⁾ / 🏃 SPORT/ 🏠 INDOOR/ 🕯️ CANDLE ¹⁾ / 📷 SELF PORTRAIT/ 🌅 SUNSET ¹⁾ / 🎆 FIREWORKS ¹⁾ / 📷 MULTI FIREWORKS/ 📷 MULTIPLE EXPOSURE/ 🍴 CUISINE/ 📄 DOCUMENTS/ 🏖️ BEACH & SNOW/ 🐦 BIRD WATCHING/ 📷 SOFT BACKGROUND SHOT/ 🐕 PET	The camera takes a picture using the optimum settings for the scene conditions.

- ¹⁾ When the subject is dark, noise reduction is automatically activated. This approximately doubles the shooting time during which no other pictures can be taken.

Making an overlay image with fireworks

([📷] MULTI FIREWORKS] mode)

- Use <D> to select [📷] MULTI FIREWORKS], and press the (OK) button to set.
- Press the shutter button to take the first frame.
 - The exposure is locked at the first frame. The saved image is displayed as the background.
- ❗ To retake the first shot, press the (OK) button, and then press the shutter button again.
- Adjust the position of the fireworks that will be taken in the second frame over the first frame used as the background, and then press the shutter button.
 - The overlay image is saved as a separate image from the first and second frames.
- ❗ To retake the second shot, press the shutter button again.

Making an overlay image ([📷] MULTIPLE EXPOSURE] mode)

The method of shooting is the same as in [📷] MULTI FIREWORKS] mode. While shooting settings cannot be changed in [📷] MULTI FIREWORKS], it is possible to do so in [📷] MULTIPLE EXPOSURE].

Taking pictures with blurred backgrounds ([📷] SOFT BACKGROUND SHOT] mode)

- Use Δ ▽ to select [📷] SOFT BACKGROUND SHOT], and press the (OK) button to set.
- Use <D> to select a frame (6 different types are available/AUTO), and then press the (OK) button.
 - AUTO recognizes the subject (people, flowers, etc) automatically and blurs the background for shooting.
- Shoot the subject within the frame.
 - The frame can be moved by pressing Δ ▽ <D>.

To take pictures of a moving subject like a pet ([📷] PET] mode)

- Use <D> to select [📷] PET], and press the (OK) button to set.
- Hold the camera to align the AF target mark on the subject and press the (OK) button.
 - When the camera recognizes the subject, the AF target mark automatically tracks the subject movement to focus on it continuously. "To focus on a moving subject continuously (AF Tracking)" (p. 31).

Shooting with special effects (MAGIC mode)

To add expression to your photo, select the desired special effect.

1 Set the shooting mode to MAGIC.



2 Press ∇ to go to the submenu.

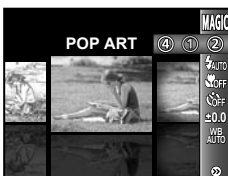

3 Use \triangleleft and \triangleright to select the desired effect and then press the \odot button to set.



Icon indicating **MAGIC** mode that is set

Shooting mode	Option
MAGIC FILTER	① POP ART
	② PIN HOLE
	③ FISH EYE
	④ DRAWING

- In **MAGIC** mode, the optimum shooting settings are pre-programmed for each scene effect. For this reason, some settings cannot be changed in some modes.

Creating panoramic images (M mode)

1 Set the shooting mode to M.



2 Press ∇ to go to the submenu.

3 Use \triangleleft and \triangleright to select the desired mode and then press the \odot button to set.

Submenu 1	Application
AUTO	Three frames are taken and combined by the camera. The user only composes the shots so that the target marks and pointers overlap, and the camera automatically releases the shutter.
MANUAL	Three frames are taken and combined by the camera. The user composes the shots using the guide frame and manually releases the shutter.
PC	The frames that were taken are combined into a panorama image using the PC software (ib).

- For details on installing the PC software (ib), see "Battery charge and camera setup" (p. 11).
- When set to [AUTO] or [MANUAL], [IMAGE SIZE] (p. 30) is fixed to [2M].
- The focus, exposure (p. 27), zoom position (p. 16), and white balance (p. 28) are locked at the first frame.
- The flash (p. 26) is fixed to \odot (FLASH OFF) mode.

Taking pictures with [AUTO]

- 1 Press the shutter button to take the first frame.
- 2 Move the camera slightly in the direction of the second frame.

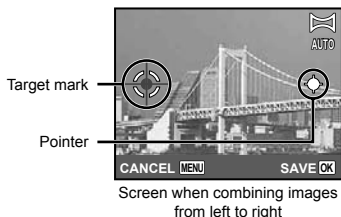

- 3 Move the camera slowly while keeping it straight, and stop the camera where the pointer and target mark overlap.

- The camera releases the shutter automatically.



- ! To combine only two pictures, press the  button before taking a third frame.
- 4 Repeat Step 3 to take a third frame.
 - After the third frame is taken, the camera automatically processes the frames and the combined panorama image is displayed.
- ! To exit the panorama function without saving an image, press the **MENU** button.
- ! If the shutter does not automatically release, try [MANUAL] or [PC].

Taking pictures with [MANUAL]

- 1 Use  to specify at which edge the next picture is to be connected.

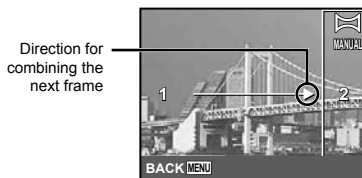

- 2 Press the shutter button to take the first frame.

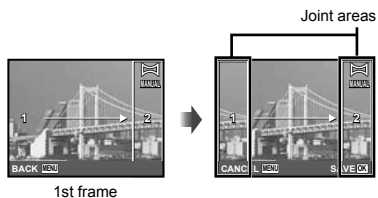

- 3 Compose the next shot so that joint area 1 overlaps joint area 2.

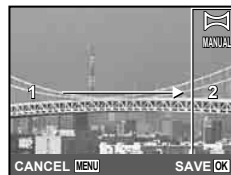

Composition of the 2nd frame

- 4 Press the shutter button to take the next shot.
- ! To combine only two pictures, press the  button before taking the third frame.
- 5 Repeat Steps 3 and 4 to take a third frame.
 - After the third frame is taken, the camera automatically processes the frames and the combined panorama image is displayed.
- ! To exit the panorama function without saving an image, press the **MENU** button.

Taking pictures with [PC]

- 1 Use Δ ∇ \langle \triangleright to select the direction that the frames are combined.
- 2 Press the shutter button to take the first frame, and then compose the second shot.

Before first shot

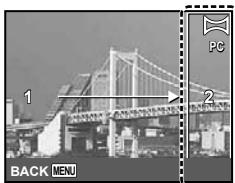

After first shot



- After the first shot, the area shown in white reappears on the side of the display opposite the pan direction. Frame subsequent photographs so that they overlap with the image in the monitor.
- 3 Repeat Step 2 until the number of desired frames is taken, and then press the \odot button or **MENU** button when finished.
- ! Panorama shooting is possible for up to 10 frames.
 - ! Refer to the PC software (ib) help guide for details on how to make panorama images.

Smoothing out skin tone and texture (BEAUTY mode)

The camera identifies a person's face and gives the skin a smooth, translucent look for taking the picture.

1 Set the shooting mode to BEAUTY.



2 Point the camera toward the subject. Check the frame appearing around the face detected by the camera, and then press the shutter button to take the picture.

- The unedited image and edited image are both saved.
 - If the image cannot be retouched, only the unedited image is saved.
- ! The frame may not appear or may take some time to appear for some subjects. In addition, this function may have no visible effect on some subjects.
 - ! The [IMAGE SIZE] of the retouched image is limited to [5M] or lower.

Using Shooting Functions

! "Using the Menu" (p. 4)

Using the flash

The flash functions can be selected to best match the shooting conditions.

- 1 Lift the flash knob to flip up the built-in flash.

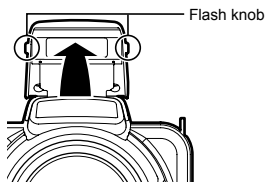

! The flash settings cannot be adjusted with the flash closed.

To turn off the flash

Press the flash down back into the camera. This sets to (FLASH OFF) mode.

- 2 Select the flash option in the shooting function menu.

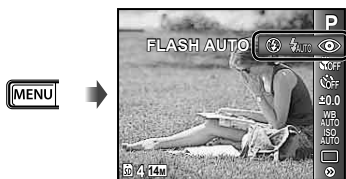

- 3 Use to select the setting option, and press the button to set.

Option	Description
FLASH AUTO	The flash fires automatically in low-light or backlight conditions.
REDEYE	Pre-flashes are emitted to reduce the occurrence of red eye in your photos.
FILL IN	The flash fires regardless of the available light.
RED-EYE + FILL-IN	After the pre-flashes that reduce the red eye, the flash fires regardless of the available light.
SLOW	The flash fires at a slow shutter speed immediately after the shutter is opened (first curtain sync). Both the subject in the foreground and the night scene in the background are captured.
FLASH OFF	The flash does not fire.

Shooting closeups (Macro shooting)

This function enables the camera to focus and shoot subjects at close distances.

- 1 Select the macro option in the shooting function menu.

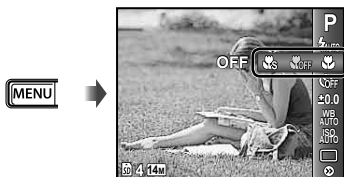

- 2** Use $\leftarrow \rightarrow$ to select the setting option, and press the \odot button to set.

Option	Description
OFF	Macro mode is deactivated.
MACRO	This enables shooting as close as 10 cm/3.9 in. ¹⁾ (180 cm/70.8 in. ²⁾ to the subject.
SUPER MACRO ³⁾	This enables shooting as close as 1 cm/0.4 in. to the subject.

¹⁾ When the zoom is at the widest (W) position.

²⁾ When the zoom is at the most telephoto (T) position.

³⁾ The zoom is automatically fixed.

-  The flash (p. 26) and zoom (p. 16) cannot be set when [M] SUPER MACRO is selected.



Using the self-timer

After the shutter button is pressed all the way down, the picture is taken after a short delay.

- 1** Select the self-timer option in the shooting function menu.



- 2** Use $\leftarrow \rightarrow$ to select the setting option, and press the \odot button to set.

Option	Description
 OFF	The self-timer is deactivated.
 12 SEC	The self-timer lamp turns on for approx. 10 seconds, then blinks for approx. 2 seconds, and then the picture is taken.
 2 SEC	The self-timer lamp blinks for approx. 2 seconds, then the picture is taken.

-  Self-timer shooting is automatically canceled after one shot.

To cancel the self-timer after it starts

Press the MENU button.

Adjusting the brightness (Exposure compensation)

The standard brightness (appropriate exposure) set by the camera based on the shooting mode (except for iAUTO) can be adjusted brighter or darker to obtain a desired shot.

- 1** Select the exposure compensation option in the shooting function menu.

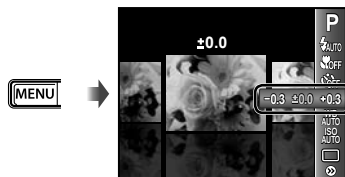

- 2** Use $\leftarrow \rightarrow$ to select the desired brightness, and press the \odot button.

Adjusting to a natural color scheme (White balance)

For more natural coloring, choose a white balance option suited to the scene.

1 Select the white balance option in the shooting function menu.

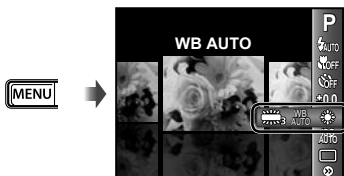

2 Use <Left><Right> to select the setting option, and press the OK button to set.

Option	Description
WB AUTO	The camera automatically adjusts the white balance according to the shooting scene.
	For shooting outdoors under a clear sky.
	For shooting outdoors under a cloudy sky.
	For shooting under tungsten lighting.
	For shooting under daylight fluorescent lighting (household lighting, etc.)
	For shooting under neutral fluorescent lighting (desk lamps, etc.)
	For shooting under white fluorescent lighting (offices, etc.)

Selecting the ISO sensitivity

- ! Abbreviation for the International Organization for Standardization. ISO standards specify the sensitivity for digital cameras and film, thus codes such as "ISO 100" are used to represent sensitivity.
- ! In the ISO setting, although smaller values result in less sensitivity, sharp images can be taken under fully lit conditions. Larger values result in higher sensitivity, and images can be taken at fast shutter speeds even under low light conditions. However, high sensitivity introduces noise into the resulting picture, which may give it a grainy appearance.

1 Select the ISO setting option in the shooting function menu.



2 Use <Left><Right> to select the setting option, and press the OK button to set.

Option	Description
ISO AUTO	The camera automatically adjusts the sensitivity according to the shooting scene.
HIGH ISO AUTO	The camera uses a higher sensitivity compared to [ISO AUTO] to minimize blur caused by a moving subject or by camera shake.
Value	The ISO sensitivity is fixed to the selected value.

Sequential shooting (Drive)

Pictures are taken sequentially while the shutter button is held down.

1 Select the drive option in the shooting function menu.

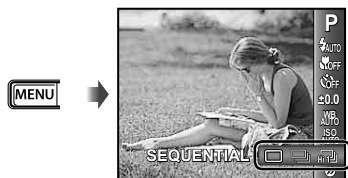

Option	Description
	One frame is shot each time the shutter button is pressed.
	Take sequential shots using the focus, brightness (exposure) and white balance set in the first frame.
	The camera takes sequential shots at a faster speed than in
	The camera takes sequential shots at approximately 10.2 frames/sec.
	The camera takes sequential shots at approximately 15.2 frames/sec.
	Sequential shooting while adjusting the focus for each image.
BKT	Sequential shooting that automatically changes the exposure for each frame while using the focus and white balance that were locked at the first frame (Bracket shooting). "BKT" (p. 33)
TIMELAPSE	The camera takes sequential shots automatically for the number of pictures and interval specified. "SET TIME LAPSE" (p. 34)

¹ The shooting speed varies depending on the settings for "image quality" (p. 30).

- ⚠ When set to , the flash (p.26) cannot be set to [REDEYE]. In addition, when set to , , or the flash is fixed to [FLASH OFF].
- ⚠ [IMAGE SIZE] is limited to [5M] or lower when set to or , and to [2M] or lower when set to . The ISO sensitivity is fixed at [ISO AUTO] in both cases.
- ⚠ Setting of recording sound when shooting still images (🔊) is disabled when taking sequential shots.

Timelapse shooting

Once the shutter button is pressed, the first shot will be taken, and subsequently all other shots will be taken automatically. The camera automatically enters sleep mode after the first frame has been saved. Sleep mode is exited around 7 seconds before the next shot. Once the preset number of frames is taken, the camera automatically turns off.

- ⚠ Use of charged batteries or an AC adapter is recommended when taking frames over an extended period of time.
- ⚠ If any of the following operations are performed while the camera is in sleep mode, the camera cancels timelapse mode and returns to normal shooting: opening of the battery/card compartment cover, connecting the camera to a computer, pressing the shutter button or wheel controller.
- ⚠ If the internal memory or card or the battery power runs out during timelapse mode, a warning is displayed, [TIMELAPSE] mode is canceled and the camera automatically turns off.



Menus for Shooting Functions

 The default settings of the function are highlighted in .

Selecting the image quality for still images [IMAGE SIZE/COMPRESSION]

 (Shooting menu 1) ► IMAGE SIZE/COMPRESSION

Available shooting modes: **P** **AUTO** **SCN** **MAGIC**  **BEAUTY**

Submenu 1	Submenu 2	Application
IMAGE SIZE	14M (4288 × 3216) 	Suitable for printing pictures over A3 (11×17 in.).
	8M (3264×2448)	Suitable for printing pictures up to A3 (11×17 in.).
	5M (2560×1920)	Suitable for printing pictures at A4 (8.5×11 in.).
	3M (2048×1536)	Suitable for printing pictures up to A4 size (8.5×11 in.).
	2M (1600×1200)	Suitable for printing pictures at A5 (5×7 in.).
	1M (1280×960)	Suitable for printing pictures at postcard size.
	VGA (640×480)	Suitable for viewing pictures on a TV or using pictures on emails and web sites.
	16:9  (4288×2416)	Suitable for playing pictures on a widescreen TV and for printing on A3 or 11×17 in.
	16:9  (1920×1080)	Suitable for playing pictures on a widescreen TV and for printing on A5 or 5×7 in.
COMPRESSION	FINE	Shooting at high quality.
	NORMAL	Shooting at normal quality.

 "Number of storable pictures (still images)/Remaining recording time (movies) in the internal memory and SD/SDHC memory cards" (p. 61)

Selecting the image quality for movies [IMAGE SIZE/IMAGE QUALITY]

 (Movie menu) ► IMAGE SIZE/IMAGE QUALITY

Available shooting modes: **P** **AUTO** **SCN** **MAGIC**  **BEAUTY**

Submenu 1	Submenu 2	Application
IMAGE SIZE	720P	Select the image quality based on the image size and frame rate.
	VGA (640×480)	
	QVGA (320×240)	
IMAGE QUALITY	FINE/NORMAL 	Select [FINE] to shoot with higher image quality.

 When [IMAGE SIZE] is set to [QVGA], [IMAGE QUALITY] is fixed to [FINE].

 "Number of storable pictures (still images)/Remaining recording time (movies) in the internal memory and SD/SDHC memory cards" (p. 61)

Brightening the subject against backlight [SHADOW ADJUST]

 (Shooting menu 1) ► SHADOW ADJUST

Available shooting modes: **P** IAUTO **SCN** **MAGIC**
 **BEAUTY**

Submenu 2	Application
AUTO	The shadow adjustment effect is applied when shooting against backlight.
OFF	The effect is not applied.
ON	Shoot with automatic adjustment to brighten an area that has become darker.

 When set to [ON], [ESP/□] (p. 32) is automatically fixed to [ESP].

Selecting the focusing area [AF MODE]

 (Shooting menu 1) ► AF MODE



Available shooting modes: **P** IAUTO **SCN** **MAGIC**
 **BEAUTY**

Submenu 2	Application
FACE/ESP ¹	The camera focuses automatically. (If a face is detected, it is shown by a white frame ¹ ; when the shutter button is pressed halfway and the camera focuses, the frame turns to green ² . If no face is detected, the camera chooses a subject in the frame and focuses automatically.)
SPOT	The camera focuses on the subject located within the AF target mark.
AF TRACKING	The camera tracks the subject movement automatically to focus on it continuously.
AREA	The AF target mark position is moved to focus the camera on the subject located at a position other than the center.









¹ For some subjects, the frame may not appear or may take some time to appear.

² If the frame blinks in red, the camera cannot focus. Try refocusing on the subject.

To focus on a moving subject continuously (AF Tracking)

- Hold the camera to align the AF target mark on the subject and press the  button.
- When the camera recognizes the subject, the AF target mark automatically tracks the subject movement to focus on it continuously.
- To cancel the tracking, press the  button.
- Depending on the subjects or the shooting conditions, the camera may be unable to lock the focus or fail to track the subject movement.
- When the camera fails to track the subject movement, the AF target mark changes to red.
- When set to [ON], [ESP/□] (p. 32) is automatically fixed to [ESP].

To move and lock the AF target mark [AREA]

Use    to move the AF target mark () on the screen. To lock the AF target mark, press and hold the  button until the mark changes to . To unlock the AF target mark, press and hold the  button until the mark changes to .

Selecting the method for measuring the brightness [ESP/□]

(Shooting menu 1) ► ESP/□

Available shooting modes: **P** iAUTO **SCN** MAGIC
BEAUTY

Submenu 2	Application
ESP	Shoots to obtain a balanced brightness over the entire screen (Meters the brightness at the center and surrounding areas of the screen separately).
□ (spot)	Shoots the subject at the center during backlighting (Meters the brightness at the center of the screen).
□ (center weighted)	Shoots without being affected by the surrounding brightness. (Meters a wide range based on the center section of the screen.)

- ! When set to [ESP], the center may appear dark when shooting against strong backlighting.
- ! [□(spot)] can be selected when [SHADOW ADJUST] is set to [OFF], or when [AF MODE] is set to [SPOT].

Shooting at higher magnifications than optical zoom without reducing the image quality [FINE ZOOM]

(Shooting menu 1) ► FINE ZOOM

Available shooting modes: **P** iAUTO **SCN** MAGIC
BEAUTY

Submenu 2	Application
OFF	Optical zoom is used to zoom in for shooting.
ON	Optical zoom and image cropping are combined to zoom in for shooting. (Approx. 201x (max.))

- ! This function will not reduce the image quality since it does not convert the data with fewer pixels into the data with larger pixels.
- ! When set to [ON], [IMAGE SIZE] is limited to **[8M]** or lower.
- ! The setting is not available when [DIGITAL ZOOM] is set to [ON].
- ! [FINE ZOOM] is not available when **[SUPER MACRO]** (p. 26) is selected.

Shooting at higher magnifications than optical zoom [DIGITAL ZOOM]

(Shooting menu 1) ► DIGITAL ZOOM

Available shooting modes: **P** iAUTO **SCN** MAGIC
BEAUTY

Submenu 2	Application
OFF	Only optical zoom is used to zoom in for shooting.
ON	Optical zoom and digital zoom are combined to zoom in for shooting. (Approx. 150x (max.))

- ! The setting is not available when [FINE ZOOM] is set to [ON].
- ! [DIGITAL ZOOM] is not available when **[SUPER MACRO]** (p. 26) is selected.

Recording sound when shooting still images [0]

2 (Shooting menu 2) ►

Available shooting modes: **P** iAUTO **SCN** **MAGIC**
BEAUTY

Submenu 2	Application
OFF	No sound is recorded.
ON	The camera automatically starts recording sound for approx. 4 seconds after a picture is taken. This is useful for recording notes or comments about the picture.

- ! When recording, aim the microphone (p. 6) at the source of the sound you want to record.
- ! Setting is disabled when taking sequential shots.

Recording sound when shooting movies [0]

(Movie menu) ►

Available shooting modes: **P** iAUTO **SCN** **MAGIC**
BEAUTY

Submenu 2	Application
OFF	No sound is recorded.
ON	Sound is recorded.

- ! When set to [ON], only the digital zoom can be used during movie recording. To record the movie with the optical zoom, set (movies) to [OFF].

Reducing the blur caused by the camera shake when shooting [IMAGE STABILIZER] (still images)/ [IS MOVIE MODE] (movies)

2 (Shooting menu 2) ►

IMAGE STABILIZER (still images)/

(Movie menu) ►

IS MOVIE MODE (movies)

Available shooting modes: **P** iAUTO **SCN** **MAGIC**
BEAUTY

Submenu 2	Application
OFF	The image stabilizer is deactivated. This is recommended for shooting when the camera is fixed in place on a tripod or other stable surface.
ON	The image stabilizer is activated.

- ! The camera's default settings are [IMAGE STABILIZER] (still images) to [ON] and [IS MOVIE MODE] (movies) to [OFF].
- ! There may be a noise coming from inside the camera when the shutter button is pressed with [IMAGE STABILIZER] (still images) set to [ON].
- ! Images may not be stabilized if camera shake is too severe.
- ! When the shutter speed is extremely slow, such as when taking pictures at night, [IMAGE STABILIZER] (still images) may not be as effective.
- ! When shooting while the [IS MOVIE MODE] (movies) is set to [ON], the image will be enlarged somewhat before saving.

Specifying the exposure compensation and number of pictures [BKT]

2 (Shooting menu 2) ► **BKT**

Available shooting modes: **P** iAUTO **SCN** **MAGIC**
BEAUTY

Submenu 2	Application
EXPOSURE COMP.	$\pm 0.3/\pm 0.7/\pm 1.0$ Set the exposure difference and the number of shots.
PICTURES	x3/x5



- ① Use Δ ∇ to select [EXPOSURE COMP.] ($\pm 0.3/\pm 0.7/\pm 1.0$), and press the \triangleright .
- ② Use Δ ∇ to select [PICTURES] (x3/x5), and press the \odot button.

Reducing noise during long exposures [NOISE REDUCT.]

 (Shooting menu 2) ► NOISE REDUCT.

Available shooting modes: **P** iAUTO **SCN** MAGIC
 BEAUTY

Submenu 2	Application
OFF	The camera takes pictures at a fast shutter speed. No noise reduction is used.
ON	The camera takes pictures at a slow shutter speed. Noise reduction is activated when the shutter speed is slower than 1/2 second.

-  When set to [ON], the time for saving data is approx. twice as long as usual. During this wait time, no pictures can be taken.
-  This function may not work effectively for some subjects and shooting conditions.

Specifying the shooting interval and number of pictures [SET TIME LAPSE]

 (Shooting menu 2) ► SET TIME LAPSE

Available shooting modes: **P** iAUTO **SCN** MAGIC
 BEAUTY

Submenu 2		Application
INTERVAL	1MIN to 99MIN	Set the shooting interval and the number of shots.
PICTURES	2 to 99	

- ① Use Δ ∇ to select [INTERVAL] (1 to 99 MIN), and press the \triangleright .
- ② Use Δ ∇ to select [PICTURES] (2 to 99), and press the \odot button.

Shooting pictures while keeping the subject in focus [FULLTIME AF]

 (Movie menu) ► FULLTIME AF

Available shooting modes: **P** iAUTO **SCN** MAGIC
 BEAUTY

Submenu 2	Application
OFF	Pressing the shutter button halfway down brings the subject into focus and locks the focus.
ON	Fulltime AF keeps the subject in focus, without having to press the shutter button down halfway. This reduces focusing time.

Using the AF illuminator to focus on a shadowy subject [AF ILLUMINAT.]

 (Shooting menu 2) ► AF ILLUMINAT.

Available shooting modes: **P** iAUTO **SCN** MAGIC
 BEAUTY

Submenu 2	Application
OFF	The AF illuminator is not used.
ON	When the shutter button is pressed halfway down, the AF illuminator turns on to aid focusing.

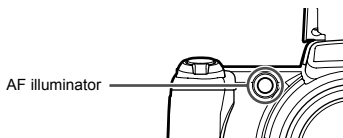

Displaying icon guides [ICON GUIDE]

 (Shooting menu 2) ► ICON GUIDE

Available shooting modes: **P** iAUTO **SCN** MAGIC
 BEAUTY

Submenu 2	Application
OFF	No icon guide is displayed.
ON	The explanation of the selected icon will be displayed when a shooting mode or shooting function menu icon is selected (position the cursor on the icon for a while to display the explanation).

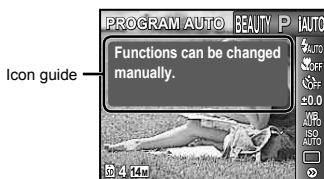

Menus for Playback, Editing, and Printing Functions

- ❗ The menu descriptions shall begin with the playback function menu. The default settings of the function are highlighted in .
- ❗ Data must have been created with the PC software (ib) before using some function.
- ❗ For details on installing the PC software (ib), see "Battery charge and camera setup" (p. 11).
- ❗ Refer to the PC software (ib) help guide for details on how to use the PC software (ib).

Playing back pictures automatically [SLIDESHOW]

SLIDESHOW

Submenu 1	Submenu 2	Application
SLIDE	ALL/EVENT/ COLLECTION	Selects the content to be included in the slideshow.
BGM	OFF/ Cosmic/ Breeze/ Mellow/ Dreamy/ Urban	Selects the background music options.
TYPE	STANDARD/ FADE/ ZOOM	Selects the type of transition effect used between slides.
START	—	Starts the slideshow.

Single-frame advance/rewind:

During a slideshow, press \triangleright to skip ahead one frame or press \triangleleft to go back one frame.

Searching for images and playing back the related images [PHOTO SURFING]

PHOTO SURFING

In [PHOTO SURFING], images can be searched and related images can be played back by selecting the related items.

To start [PHOTO SURFING]

Press the \odot button to start [PHOTO SURFING].
When a related item of the image displayed is selected with \triangle ∇ , images related to the item are displayed in the lower part of the monitor. Use \triangleleft \triangleright to display an image.
To select the related items undisplayed, press the \odot button when selecting an item.
To stop [PHOTO SURFING], press the **MENU** button, or select [BACK] and press the \odot button.

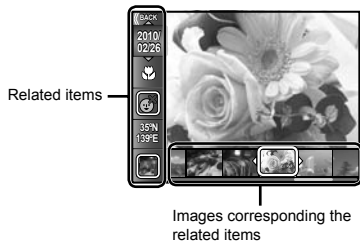

Viewing images by event [EVENT ▶]

EVENT ▶

In [EVENT ▶], images in an event are played back. (Images with the same shooting date are grouped into the same event.)

To start [EVENT ▶]

Press the **Ⓜ** button to start [EVENT ▶]. (The event, including the image for which single-image view was being performed when the playback function menu was selected, is played back.)

Use **<▶** to advance or rewind by one frame.

To stop [EVENT ▶], press the **MENU** button.



Playing back images by Collection created with the PC software (ib) [COLLECTION ▶]

COLLECTION ▶

In [COLLECTION ▶], the collection is played back that has been created with the PC software (ib) and imported back from a computer.

To start [COLLECTION ▶]

Press the **Ⓜ** button, and then use **△▽<▶** to select the desired collection. Press the **Ⓜ** button again to start playback of the selected collection. Use **<▶** to advance or rewind by one frame.

To stop [COLLECTION ▶], press the **MENU** button.

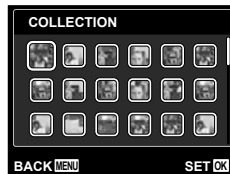

Using a PC software (ib) and importing data back to the camera

- ❗ The following functions can be performed when data created with the PC software (ib) is imported back to the camera.
- ❗ Refer to the PC software (ib) help guide for details on how to use the PC software (ib).

[PHOTO SURFING]

Information of persons or shooting locations and new Collections can be added in the related items.

[EVENT

Images can be played back by event created with the PC software (ib).

Event index (p. 19)

The representative images for an event created with the PC software (ib) can be displayed.

Retouching the skin and eyes [BEAUTY FIX]

BEAUTY FIX

- ❗ Depending on the picture, the editing may not be effective.

Submenu 1	Submenu 2	Application
ALL	—	[CLEAR SKIN], [SPARKLE EYE] and [DRAMATIC EYE] are applied together.
CLEAR SKIN	SOFT/AVG/ HARD	Makes skin look smooth and translucent. Select the correction effect from 3 levels.
SPARKLE EYE	—	Enhances the contrast of the eyes.
DRAMATIC EYE	—	Enlarges the subject's eyes.

- ① Use Δ ∇ to select a correction item, and press the \odot button.
- ② Use \triangleleft \triangleright to select an image for retouching, and press the \odot button.
 - The retouched image is saved as a separate image.

When [CLEAR SKIN] is selected

Use Δ ∇ to select the retouching level, and press the \odot button.



Changing the image size []

EDIT ► []

Submenu 2	Application
VGA 640 × 480	This saves a high-resolution image as a separate image with a smaller size for use in e-mail attachments and other applications.
QVGA 320 × 240	

- 1 Use <|> to select an image.
- 2 Use Δ ▽ to select an image size and press the (OK) button.
 - The resized image is saved as a separate image.

Cropping image []

EDIT ► []

- 1 Use <|> to select an image, and press the (OK) button.
- 2 Use the zoom lever to select the size of the cropping frame, and use Δ ▽ <|> to move the frame.

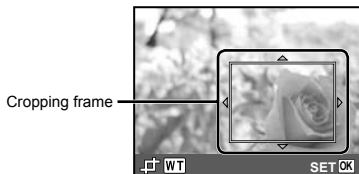

- 3 Press the (OK) button after you have selected the area to trim.
 - The edited image is saved as a separate image.

Changing the color tone of image [COLOR EDIT]

EDIT ► COLOR EDIT

Submenu 2	Application
BLACK & WHITE	This changes the image to black and white.
SEPIA	This changes the image to a sepia tone.
HIGH SATURATION	This increases the color saturation of the image.
LOW SATURATION	This slightly increases the color saturation of the image.



- 1 Use <|> to select an image, and press the (OK) button.
- 2 Use <|> to select the desired color, and press the (OK) button.
 - The image with the selected color is saved as a separate image.

Adding a calendar to an image [CALENDAR]

EDIT ► CALENDAR

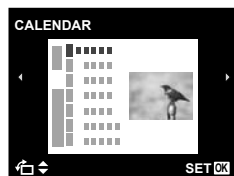

- ① Use \triangleleft \triangleright to select an image, and press the \odot button.
- ② Use \triangleleft \triangleright to select a calendar. Use \triangle ∇ to select the image orientation, and then press the \odot button.
- ③ Use \triangle ∇ to select the Year of the calendar, and press \triangleright .
- ④ Use \triangle ∇ to select the Month of the calendar, and press the \odot button.
 - The edited image is saved as a separate image.

Brightening areas that are dark due to backlight or other reasons [SHADOW ADJ]

EDIT ► SHADOW ADJ

- ① Use \triangleleft \triangleright to select an image, and press the \odot button.
 - The edited image is saved as a separate image.
- ⓘ Depending on the picture, the editing may not be effective.
- ⓘ The retouching process may lower the image resolution.

Retouching red eyes in flash shooting [REDEYE FIX]

EDIT ► REDEYE FIX

- ① Use \triangleleft \triangleright to select an image, and press the \odot button.
 - The edited image is saved as a separate image.
- ⓘ Depending on the picture, the editing may not be effective.
- ⓘ The retouching process may lower the image resolution.

Erasing images [ERASE]

ERASE

Submenu 1	Application
ALL ERASE	All images in the internal memory or card will be erased.
SEL. IMAGE	Images are individually selected and erased.
ERASE/ERASE EVENT ¹⁾	Deletes the image displayed.
CANCEL	Cancels deletion of the image.

¹⁾ If ∇ is pressed when an event is played back, all images in the event are erased.

- ⓘ When erasing pictures in the internal memory, do not insert the card into the camera. Or set [INTERNAL/SD] to [IN]. "Selecting a storage device [INTERNAL/SD]" (p. 41)
- ⓘ Before erasing pictures from a memory card, insert the card into the camera and select [AUTO] for [INTERNAL/SD]. "Selecting a storage device [INTERNAL/SD]" (p. 41)
- ⓘ Protected images cannot be erased.

To individually select and erase images [SEL. IMAGE]

- ① Use \triangle ∇ to select [SEL. IMAGE], and press the \odot button.
- ② Use \triangleleft \triangleright to select the image to be erased, and press the \odot button to add a \checkmark mark to the image.
 - Turn the zoom lever to the W end to display an index view. Images can be quickly selected using the \triangle ∇ \triangleleft \triangleright buttons. Turn to the T end to return to the single frame display.

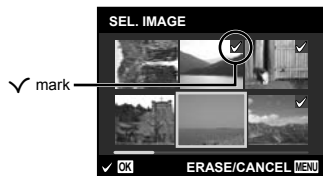

- ③ Repeat Step ② to select the images to be erased, and then press the **MENU** button to erase the selected images.
- ④ Use \triangle ∇ to select [YES], and press the \odot button.
 - The images with a \checkmark mark are erased.

To erase all images [ALL ERASE]

- ① Use Δ ∇ to select [ALL ERASE], and press the OK button.
- ② Use Δ ∇ to select [YES], and press the OK button.

Saving print settings to the image data [PRINT ORDER]

▶ (Playback menu) ▶ PRINT ORDER

- ! "Print Reservations (DPOF)" (p. 51)
- ! Print reservation can be set only for still images that are recorded to the card. Set [INTERNAL/SD] to [AUTO].

Protecting images [O-π]

▶ (Playback menu) ▶ O-π

- ! Protected images cannot be erased by [ERASE] (p. 18, 39), [ALL ERASE] (p. 39), [SEL. IMAGE] (p. 39) or [ERASE EVENT] (p. 39), but all images are erased by [MEMORY FORMAT]/[FORMAT] (p. 41).

- ① Use \triangleleft \triangleright to select an image.
- ② Press the OK button.
 - Press the OK button again to cancel the settings.
- ③ If necessary, repeat Steps ① and ② to protect other images, and press the **MENU** button.

Rotating images [↻]

▶ (Playback menu) ▶ ↻

- ① Use \triangleleft \triangleright to select an image.
 - ② Press the OK button to rotate the image.
 - ③ If necessary, repeat Steps ① and ② to make settings for other images, and press the **MENU** button.
- ! The new picture orientations will be saved even after the power is turned off.

Adding sound to still images [🗣️]

▶ (Playback menu) ▶ 🗣️

- ① Use \triangleleft \triangleright to select an image.
- ② Aim the microphone toward the sound source.

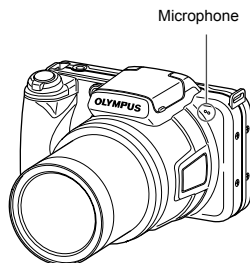

- ③ Press the OK button.
 - Recording starts.
 - The camera adds (records) sound for approx. 4 seconds while playing back the image.

Menus for Other Camera Settings

 The default settings of the function are highlighted in .

Selecting a storage device [INTERNAL/SD]



Y1 (Settings 1) ► INTERNAL/SD

Submenu 2	Application
AUTO	If a card is inserted, the card is automatically selected. If no card is inserted, internal memory is used.
IN ^{*1}	Internal memory is selected.

^{*1} Internal memory is used even if a card is inserted.

Erasing data completely [MEMORY FORMAT]/[FORMAT]

Y1 (Settings 1) ► MEMORY FORMAT/
FORMAT



-  Before formatting, check that no important data is left in the internal memory or card.
-  If the internal memory is formatted, the camera instruction manual and the PC software (ib) data that are stored on the internal memory are erased. If necessary, store the backup before formatting.
-  Cards must be formatted with this camera before first use or after being used with other cameras or computers.

Submenu 2	Application
YES ^{*1}	Completely erases the image data in the internal memory or card (including protected images).
NO	Cancels formatting.

^{*1} If [AUTO] is selected for [INTERNAL/SD] and a card is inserted, the card will be formatted. If no card is inserted, internal memory will be formatted. If [IN] is selected for [INTERNAL/SD], internal memory will be formatted whether a card is inserted or not.

Restoring data in the camera [DATA REPAIR]



Y1 (Settings 1) ► DATA REPAIR

-  Playback will become available by performing [DATA REPAIR] when images never appear on the monitor after  button is pressed. However, data such as collections and other groups created with the PC software (ib) is deleted from the database in the camera. Import the data back into the camera from a computer to playback the data created with the PC software (ib).

Copying images in the internal memory to the card [] COPY]

Y1 (Settings 1) ►  COPY

To copy images in the internal memory to the card

Use   to select an image, and press the  button.

Changing the display language []

Y1 (Settings 1) ► 

-  "Changing the display language" (p. 14)

Submenu 2	Application
Languages	The language for the menus and error messages displayed on the monitor is selected.

Restoring the shooting functions to the default settings [RESET]

Y1 (Settings 1) ► RESET

Submenu 2	Application
YES	Restores the following menu functions to the default settings. <ul style="list-style-type: none">• Flash (p. 26)• Macro (p. 26)• Self-timer (p. 27)• Exposure compensation (p. 27)• White balance (p. 28)• ISO (p. 28)• Drive (p. 29)• Menu functions in [CAMERA], [CAMERA], [CAMERA] (p. 30 to 34)
NO	The current settings will not be changed.

Selecting a method for connecting the camera to other devices [USB CONNECTION]

Y1 (Settings 1) ► USB CONNECTION

Submenu 2	Application
AUTO	When the camera is connected to another device, the settings selection screen is displayed.
STORAGE	Select when connecting the camera to a computer via a storage device.
PC	Select when connecting a camera and computer.
PRINT	Select when connecting to a PictBridge-compatible printer.

System requirements

- Windows : Windows 2000 Professional/
XP Home Edition/
XP Professional/Vista/
Windows 7
- Macintosh : Mac OS X v10.3 or later

! Even if a computer has USB ports, proper operation is not guaranteed in the following cases:

- Computers with USB ports installed using an expansion card, etc.
- Computers without a factory-installed OS and home-built computers

Turning on the camera with the [CAMERA] button [POWER ON]

Y2 (Settings 2) ► [CAMERA] POWER ON

Submenu 2	Application
YES	Pressing the [CAMERA] button turns on the camera and starts the camera in the playback mode.
NO	The camera is not turned on. To turn on the camera, press the ON/OFF button.

Saving the mode when the camera is turned off [SAVE SETTINGS]

Y2 (Settings 2) ► SAVE SETTINGS

Submenu 2	Application
YES	The shooting mode is saved when the camera is turned off and is reactivated the next time the camera is turned on.
NO	The shooting mode is set to P mode when the camera is turned on.

Choosing the opening screen display [PW ON SETUP]

Y2 (Settings 2) ► PW ON SETUP

Submenu 2	Application
OFF	No opening screen is displayed.
ON	The opening screen is displayed when the camera is turned on.

Selecting the camera sound and its volume [SOUND SETTINGS]

Y (Settings 2) ► SOUND SETTINGS

Submenu 2	Submenu 3	Submenu 4	Application
SILENT MODE ^{1,2}	OFF/ON	—	Select [ON] to disable camera sounds (operation sounds, shutter sound, and warning sounds) and mute sound during playback.
BEEP	SOUND TYPE	1/2/3	Selects the operating sound and volume of the camera buttons (except the shutter button).
	VOLUME	OFF (No Sound)/ LOW/HIGH	
SHUTTER SOUND	SOUND TYPE	1/2/3	Selects the type and volume of the shutter sound.
	VOLUME	OFF (No Sound)/ LOW/HIGH	
■))	OFF (No Sound)/ LOW/HIGH	—	Selects the warning sound volume.
▢ VOLUME	OFF (No Sound) or 5 levels of volume	—	Selects the image playback volume.

¹ Even when [SILENT MODE] is [ON], Δ ∇ can be used to adjust volume during playback.

² Even when [SILENT MODE] is [ON], sound is played when images are displayed on a television.

Resetting the file names of pictures [FILE NAME]

Y (Settings 2) ► FILE NAME

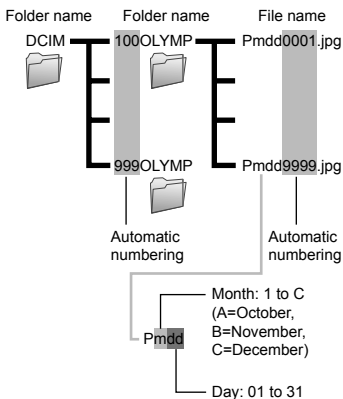

Submenu 2	Application
RESET	This resets the sequential number for the folder name and file name whenever a new card is inserted. ¹ This is useful when grouping images on separate cards.
AUTO	Even when a new card is inserted, this continues the numbering for the folder name and file name from the previous card. This is useful for managing all image folder names and files names with sequential numbers.

¹ The number for the folder name is reset to 100, and the one for the file name is reset to 0001.

Adjusting the CCD and the image processing function [PIXEL MAPPING]

Y2 (Settings 2) ► PIXEL MAPPING

- ! This function has already been adjusted at factory shipping, and no adjustment is needed right after purchase. Approximately once a year is recommended.
- ! For best results, wait at least one minute after taking or viewing pictures before performing pixel mapping. If the camera is turned off during pixel mapping, be sure to perform it again.

To adjust the CCD and the image processing function

Press the OK button when [START] (Submenu 2) is displayed.

- The camera checks and adjusts the CCD and the image processing function at the same time.

Adjusting the brightness of the monitor [MONITOR]

Y2 (Settings 2) ► MONITOR

To adjust the monitor brightness

- 1 Use Δ ∇ to adjust the brightness while viewing the screen, and then press the OK button.



Setting the date and time [DATE]

Y3 (Settings 3) ► DATE

- ! "Setting the date, time and time zone" (p. 13)



To select the date display order

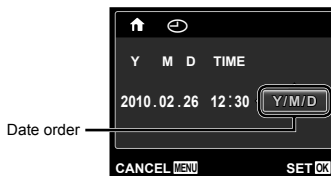







- 1 Press \triangleright after setting Minute, and use Δ ∇ to select the date display order.







Choosing home and alternate time zones [WORLD TIME]

 (Settings 3) ► WORLD TIME

 You will not be able to select a time zone using [WORLD TIME] if the camera clock has not first been set using .

Submenu 2	Submenu 3	Application
HOME/ALTERNATE		The time in the home time zone (the time zone selected for  in submenu 2).
		The time in the travel destination time zone (the time zone selected for  in submenu 2).
 ^{*1}	—	Select the home time zone ( .
 ^{*1, 2}	—	Select the travel destination time zone ( .

^{*1} In areas where daylight saving time is in effect, use   to turn daylight saving time ((SUMMER)) on.

^{*2} When you select a time zone, the camera automatically calculates the time difference between the selected zone and the home time zone () to display the time in the travel destination time zone (.

Playing back images on a TV [TV OUT]

 (Settings 3) ► TV OUT

 The TV video signal system varies depending on the countries and regions. Before viewing camera images on your TV, select the video output according to your TV's video signal type.

Submenu 2	Submenu 3	Application
VIDEO OUT	NTSC	Connecting the camera to a TV in North America, Taiwan, Korea, Japan, and so on.
	PAL	Connecting the camera to a TV in European countries, China, and so on.
HDMI OUT	480p,576p/720p/1080i	Set the playback format.
HDMI CONTROL	OFF	Operate with the camera.
	ON	Operate with the TV remote control.

 The factory default settings differ according to the region where the camera is sold.

To play back camera images on a TV

● Connection via AV cable

- ① Use the camera to select the same video signal system as the one of connected TV ((NTSC)/(PAL)).
- ② Connect the TV and camera.

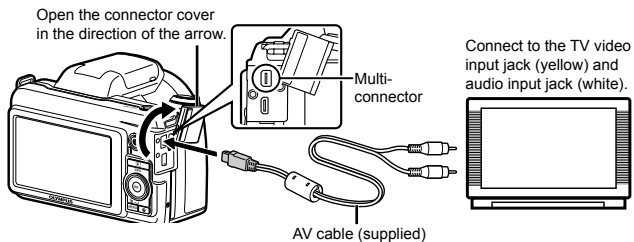

● Connection via HDMI cable

- ① On the camera, select the digital signal format that will be connected ([480p,576p]/[720p]/[1080i]).
 - ② Connect the TV and camera.
- ⚠ When set to [1080i], "1080i" format takes priority for HDMI output. However, if this setting does not match the input setting of the TV, the signal format is changed first to "720p" and then to "480p,576p". For details on changing the input setting of the TV, refer to the TV's instruction manual.
 - ⚠ When the camera is connected to the computer or the like by the USB cable, do not connect the HDMI cable to the camera.

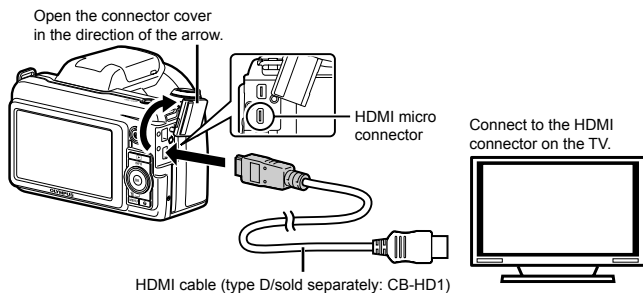

- ③ Turn on the TV, and change "INPUT" to "VIDEO (an input jack connected to the camera)."
 - ④ Turn on the camera, and use <Left><Right> to select the image for playback.
- ⚠ For details on changing the input source of the TV, refer to the TV's instruction manual.
 - ⚠ Use an HDMI cable that matches the HDMI micro connector on the camera and the HDMI connector on the TV.
 - ⚠ When the camera and TV are connected by both an AV cable and an HDMI cable, the HDMI cable will take priority.
 - ⚠ Depending on the TV's settings, the displayed images and information may become cropped.

To operate images with the TV remote control

- ① Set [HDMI CONTROL] to [ON], and turn off the camera.
 - ② Connect the camera and TV with an HDMI cable. "Connection via HDMI cable" (p. 46)
 - ③ First turn on the TV, and then turn on the camera.
 - Operate by following the operation guide that is displayed on the TV.
- ! With some TVs, operations cannot be performed with the TV remote control even though the operation guide is displayed on the screen.
- ! If operations cannot be performed with the TV remote control, set [HDMI CONTROL] to [OFF] and operate using the camera.

Saving battery power between shots [POWER SAVE]

Y (Settings 3) ► POWER SAVE

Submenu 2	Application
OFF	Cancels [POWER SAVE].
ON	When the camera is not being used for approx. 10 seconds, the monitor automatically turns off to save battery power.

To resume standby mode

Press any button.

Viewing the image immediately after shooting [REC VIEW]

Y (Settings 3) ► REC VIEW

Submenu 2	Application
OFF	The image being recorded is not displayed. This allows the user to prepare for the next shot while following the subject in the monitor after shooting.
ON	The image being recorded is displayed. This allows the user to make a brief check of the image that was just taken.

- ! Even when set to [ON], you can resume shooting while the image is being displayed.

Automatically rotating images shot with the camera in a vertical position during playback [PIC ORIENTATION]

Y (Settings 3) ► PIC ORIENTATION

- ! During shooting, the [] (p. 40) setting on the playback menu is set automatically.
- ! This function may not work properly if the camera is facing up or down during shooting.

Submenu 2	Application
OFF	Information about the vertical/horizontal orientation of the camera during shooting is not recorded with images. Images shot with the camera in a vertical position are not rotated during playback.
ON	Information about the vertical/horizontal orientation of the camera during shooting is recorded with images. Images are automatically rotated during playback.

Printing

Direct printing (PictBridge¹)

By connecting the camera to a PictBridge-compatible printer, you can print images directly without using a computer.

To find out if your printer supports PictBridge, refer to the printer's instruction manual.

¹ PictBridge is a standard for connecting digital cameras and printers of different makers and printing out pictures directly.

- ! The printing modes, paper sizes, and other parameters that can be set with the camera vary depending on the printer that is used. For details, refer to the printer's instruction manual.
- ! For details on the available paper types, loading paper, and installing ink cassettes, refer to the printer's instruction manual.

Printing images at the printer's standard settings [EASY PRINT]

- ! In the [SETUP] menu, set [USB CONNECTION] to [PRINT]. "Using the Menu" (p. 4)

1 Display the image to be printed on the monitor.

- ! "Viewing images" (p. 17)

2 Turn on the printer, and then connect the printer and camera.

Open the connector cover in the direction of the arrow.

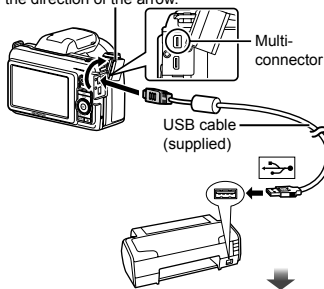

3 Press \blacktriangleright to start printing.

4 To print another image, use \triangleleft \triangleright to select an image, and press the OK button.

To exit printing

After a selected image is displayed on the screen, disconnect the USB cable from the camera and printer.



Changing the printer's settings for printing [CUSTOM PRINT]

- Follow Steps 1 and 2 for [EASY PRINT] (p. 48).
- Press the **OK** button.
- Use **△▽** to select the print mode, and press the **OK** button.

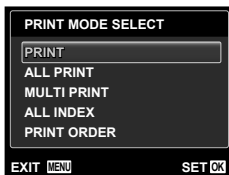

Submenu 2	Application
PRINT	This prints the image selected in Step 6.
ALL PRINT	This prints all images stored in the internal memory or card.
MULTI PRINT	This prints one image in a multiple layout format.
ALL INDEX	This prints an index of all images stored in the internal memory or card.
PRINT ORDER ¹	This prints images based on the print reservation data on the card.

¹ [PRINT ORDER] is available only when print reservations have been made. "Print Reservations (DPOF)" (p. 51)

- Use **△▽** to select [SIZE] (Submenu 3), and press **▷**.

! If the [PRINTPAPER] screen is not displayed, the [SIZE], [BORDERLESS], and [PICS/SHEET] are set to the printer's standard.

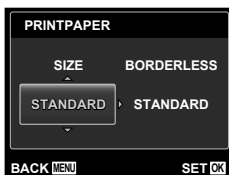

- Use **△▽** to select the [BORDERLESS] or [PICS/SHEET] settings, and press the **OK** button.

Submenu 4 (BORDERLESS or PICS/SHEET)	Application
OFF/ON ¹	The image is printed with a border around it ([OFF]). The image is printed to fill the entire paper ([ON]).
(The number of images per sheet varies depending on the printer.)	The number of images per sheet ([PICS/SHEET]) is selectable only when [MULTI PRINT] is selected in Step 3.

¹ The available settings for [BORDERLESS] vary depending on the printer.

! If [STANDARD] is selected in Steps 4 and 5, the image is printed at the printer's standard settings.



- Use **◀▶** to select an image.

- Press **△** to make a print reservation for the current image. Press **▽** to make the detailed printer settings for the current image.

To make the detailed printer settings

- Use **△▽◀▶** to select the setting, and press the **OK** button.



Submenu 5	Submenu 6	Application
	0 to 10	This selects the number of prints.
DATE	WITH/ WITHOUT	Selecting [WITH] prints the images with the date. Selecting [WITHOUT] prints the images without the date.
FILE NAME	WITH/ WITHOUT	Selecting [WITH] prints the file name on the image. Selecting [WITHOUT] does not print any file name on the image.
	(Proceeds to the setting screen.)	This selects a portion of the image for printing.

To crop an image

- Use the zoom lever to select the size of the cropping frame, use Δ ∇ \triangleleft \triangleright to move the frame, and then press the button.



- Use Δ ∇ to select [OK], and press the button.



- If necessary, repeat Steps 6 and 7 to select the image to be printed, make the detailed settings, and set [SINGLEPRINT].

9 Press the button.

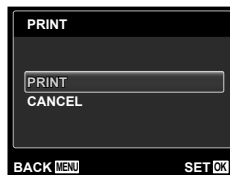

10 Use Δ ∇ to select [PRINT], and press the button.

- Printing starts.
- When [OPTION SET] is selected in [ALL PRINT] mode, [PRINT INFO] screen is displayed.
- When printing is finished, the [PRINT MODE SELECT] screen is displayed.

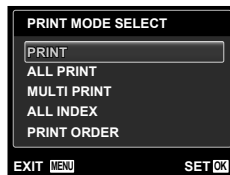

To cancel printing

- Press the **MENU** button while [DO NOT REMOVE USB CABLE] is displayed.
- Select [CANCEL] using Δ ∇ and then press the button.

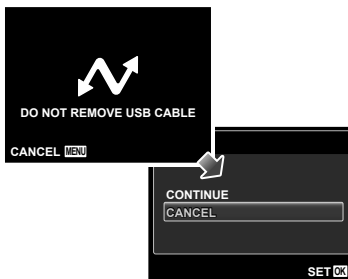

11 Press the MENU button.

12 When the message [REMOVE USB CABLE] is displayed, disconnect the USB cable from the camera and printer.

Print Reservations (DPOF¹)

In print reservations, the number of prints and date imprint option are saved in the image on the card. This enables easy printing at a printer or print shop supporting DPOF by using only the print reservations on the card without a computer or a camera.

¹ DPOF is a standard for storing automatic printout information from digital cameras.

- ! Print reservations can be set only for the images stored on the card. Insert a card with recorded images before making print reservations.
- ! DPOF reservations set by another DPOF device cannot be changed by this camera. Make changes using the original device. Making new DPOF reservations with this camera will erase the reservations made by the other device.
- ! DPOF print reservations can be made for up to 999 images per card.

Single-frame print reservations []

1 Display the [SETUP] menu.

! "Using the Menu" (p. 4)

2 From the playback menu [], select [PRINT ORDER] and then press the [OK] button.

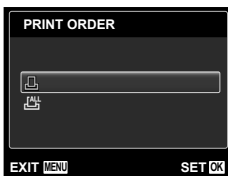

3 Use Δ ∇ to select [], and press the [OK] button.



4 Use \triangleleft \triangleright to select the image for print reservation. Use Δ ∇ to select the quantity. Press the [OK] button.



5 Use Δ ∇ to select the [] (date print) screen option, and press the [OK] button.

Submenu 2	Application
NO	This prints the image only.
DATE	This prints the image with the shooting date.
TIME	This prints the image with the shooting time.



6 Use Δ ∇ to select [SET], and press the [OK] button.

Reserving one print each of all images on the card [ALL]

- 1** Follow Steps 1 and 2 in [] (p. 51).
- 2** Use $\Delta \nabla$ to select [ALL], and press the OK button.
- 3** Follow Steps 5 and 6 in [].

Resetting all print reservation data

- 1** Follow Steps 1 and 2 in [] (p. 51).
- 2** Select either [] or [ALL], and press the OK button.

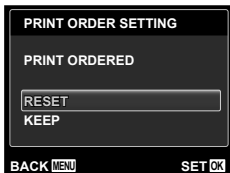

- 3** Use $\Delta \nabla$ to select [RESET], and press the OK button.

Resetting the print reservation data for selected images

- 1** Follow Steps 1 and 2 in [] (p. 51).
- 2** Use $\Delta \nabla$ to select [], and press the OK button.
- 3** Use $\Delta \nabla$ to select [KEEP] and press the OK button.
- 4** Use $\langle \triangleright \rangle$ to select the image with the print reservation you want to cancel. Use $\Delta \nabla$ to set the print quantity to "0".
- 5** If necessary, repeat Step 4, and then press the OK button when finished.
- 6** Use $\Delta \nabla$ to select the [] (date print) screen option, and press the OK button.
 - The settings are applied to the remaining images with the print reservation data.
- 7** Use $\Delta \nabla$ to select [SET], and press the OK button.

Usage Tips

If the camera does not work as intended, or if an error message is displayed on the screen, and you are unsure of what to do, refer to the information below to fix the problem(s).

Troubleshooting

Battery

“The camera does not work even when batteries are installed”.

- Insert recharged batteries in the correct direction. “Inserting the battery” (p. 10)
- Battery performance may have been reduced temporarily due to low temperature. Take the batteries out of the camera, and warm them by putting them in your pocket for a while.



Card/Internal memory

“An error message is displayed”.

“Error message” (p. 54)

Shutter button

“No picture is taken when the shutter button is pressed”.

- Cancel sleep mode.
To save battery power, the camera automatically goes into sleep mode and the monitor turns off if there is no operation for 3 minutes when the camera is turned on. No picture is taken even if the shutter button is fully pressed in this mode. Operate the zoom lever or other buttons to restore the camera from sleep mode before taking a picture. If the camera is left for another 12 minutes, it automatically turns off. Press the **ON/OFF** button to turn the camera on.
- Press the  button to switch to the shooting mode.
- Wait until  (flash charge) stops blinking before taking pictures.
- With prolonged camera use, the internal temperature may increase, resulting in automatic shutdown. If this occurs, remove the battery from the camera and wait until the camera has sufficiently cooled. The camera's external temperature may also increase during use, however this is normal and does not indicate malfunction.

Monitor

“Difficult to see”.

- Condensation¹ may have occurred. Turn off the power, and wait for the camera body to become acclimated to the surrounding temperature and dry out before taking pictures.
¹ Dew drops can form in the camera when it is suddenly taken from a cold location into a warm, humid room.

“Vertical lines appear on the screen”.

- This condition may occur when the camera is pointed at an extremely bright subject under a clear sky and so on. The lines do not appear, however, in the final image.

“The light is caught in the picture”.

- Shooting with flash in dark situations results in an image with many flash reflections on dust in the air.

Date and time function

“Date and time settings return to the default setting”.

- If the batteries are removed and left out of the camera for about 3 days², the date and time settings return to the default setting, and must be reset.

² The time until the date and time settings return to the default setting varies depending on how long the batteries have been loaded.

“Setting the date, time and time zone” (p. 13)











Miscellaneous



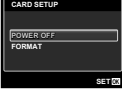
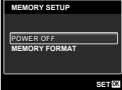

“The camera makes a noise when taking pictures”.

- The camera may activate the lens and make a noise even if no operation is performed. This is because the camera automatically performs actions of auto focus as far as it is ready to shoot.

Error message

- ! When one of the messages below is displayed on the monitor, check the corrective action.

Error message	Corrective action
 CARD ERROR	Card problem Insert a new card.
 WRITE PROTECT	Card problem The card write-protect switch is set to the "LOCK" side. Release the switch.
 MEMORY FULL	Internal memory problem <ul style="list-style-type: none"> • Insert a card. • Erase unwanted images.¹
 CARD FULL	Card problem <ul style="list-style-type: none"> • Replace the card. • Erase unwanted images.¹
	Card problem Use $\Delta \nabla$ to select [FORMAT], and press the \odot button. Next, use $\Delta \nabla$ to select [YES], and press the \odot button. ²
	Internal memory problem Use $\Delta \nabla$ to select [MEMORY FORMAT], and press the \odot button. Next, use $\Delta \nabla$ to select [YES], and press the \odot button. ²
 NO PICTURE	Internal memory/Card problem Take pictures before viewing them.
 PICTURE ERROR	Problem with selected image Use photo retouch software, etc. to view the image on a computer. If the image still cannot be viewed, the image file is corrupted.
 THE IMAGE CANNOT BE EDITED	Problem with selected image Use photo retouch software, etc. to edit the image on a computer.
 BATTERY EMPTY	Battery problem Charge the battery.
 NO CONNECTION	Connection problem Connect the camera and computer or printer correctly.
 NO PAPER	Printer problem Load paper into the printer.

Error message	Corrective action
 NO INK	Printer problem Refill the ink in the printer.
 JAMMED	Printer problem Remove the jammed paper.
SETTINGS CHANGED³	Printer problem Return to the status where the printer can be used.
 PRINT ERROR	Printer problem Turn off the camera and printer, check the printer for any problems, and then turn the power on again.
 CANNOT PRINT⁴	Problem with selected image Use a computer to print.

¹ Before erasing important images, download them to a computer.

² All data will be erased.

³ This is displayed, for instance, when the printer's paper tray has been removed. Do not operate the printer while making the print settings on the camera.

⁴ This camera may be unable to print images taken by other cameras.

Shooting tips

When you are unsure of how to take a picture that you envision, refer to the information below.

Focusing

“Focusing on the subject”

- **Taking a picture of a subject not in the center of the screen**

After focusing on an object at the same distance as the subject, compose the shot, and take the picture.

Pressing the shutter button halfway (p. 15)

- **Set [AF MODE] (p. 31) to [FACE/IESP]**
- **Taking a picture in [AF TRACKING] mode (p. 31)**

The camera tracks the subject movement automatically to focus on it continuously.

- **Taking a picture of a shadowy subject**

Using the AF illuminator makes focusing easier. [AF ILLUMINAT.] (p. 34)

- **Taking a picture of subjects where autofocus is difficult**

In the following cases, after focusing on an object (by pressing the shutter button halfway down) with high contrast at the same distance as the subject, compose the shot, and take the picture.

Subjects with low contrast



When extremely bright objects appear in the center of the screen

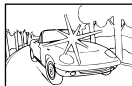

Object with no vertical lines¹

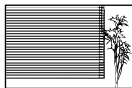

¹ It is also effective to compose the shot by holding the camera vertically to focus, and then returning to the horizontal position to take the picture.

When objects are at different distances



Fast-moving object

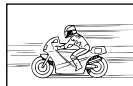

The subject is not in the center of the frame



Camera shake





“Taking pictures without camera shake”

- **Taking pictures using [IMAGE STABILIZER] (p. 33)**

When a picture is taken of a shadowy subject, the CCD¹ shifts to correct for camera shake even if the ISO speed is not increased. This function is also effective when taking pictures at a high zoom magnification.

¹ A device that takes light received through the lens and converts it into electric signals.

- **Shooting movies using [IS MOVIE MODE] (p. 33)**
 - **Select  (SPORT) in the scene mode (p. 21)**
- The  (SPORT) mode uses a fast shutter speed and can reduce the blur incurred by a moving subject.
- **Taking pictures at a high ISO sensitivity**

If a high ISO sensitivity is selected, pictures can be taken at a high shutter speed even at locations where a flash cannot be used.

“Selecting the ISO sensitivity” (p. 28)

Exposure (brightness)



“Taking pictures with the right brightness”

- **Taking pictures of a subject against a backlight**

Faces or backgrounds are bright even when shot against backlight.

[SHADOW ADJUST] (p. 31)

- **Taking pictures using [FACE/IESP] (p. 31)**

Appropriate exposure is obtained for a face against backlight, and the face is brightened.

- **Taking pictures using [] for [ESP/] (p. 32)**

Brightness is matched with a subject in the center of the screen and the image is not affected by background light.

- **Taking pictures using [FILL IN] (p. 26) flash**

A subject against backlight is brightened.

- **Taking pictures of a white beach or snow scene**

Set the mode to [] BEACH & SNOW (p. 21)

- **Taking pictures using exposure compensation (p. 27)**

Adjust the brightness while viewing the screen for taking the picture. Normally, taking pictures of white subjects (such as snow) results in images that are darker than the actual subject. Use the exposure compensation to adjust in the positive (+) direction to express whites as they appear. When taking pictures of black subjects, on the other hand, it is effective to adjust in the negative (-) direction.

Color hue



“Taking pictures with colors at the same shade as they appear”

- **Taking pictures by selecting white balance (p. 28)**

Best results in most environments can normally be obtained with the [WB AUTO] setting, but for some subjects, you should try experimenting with different settings. (This is especially true for sunshade under a clear sky, mixed natural and artificial light settings, and so on.)

- **Taking pictures using [FILL IN] (p. 26) flash**

Use of the flash is also effective for shooting under fluorescent and other artificial lighting.

Image quality



“Taking sharper pictures”

- **Taking pictures with the optical zoom**

Avoid using digital zoom (p. 32) to take pictures.

- **Taking pictures at a low ISO sensitivity**

If the picture is taken with a high ISO sensitivity, noise (small colored spots and color unevenness that were not in the original image) can occur, and the image can appear grainy.

“Selecting the ISO sensitivity” (p. 28)

Panorama



“Taking pictures so that the frames are stitched smoothly”

- **A tip for panoramic shooting**

Taking pictures by pivoting with the camera at the center prevents shifting of the image. When taking pictures of close objects in particular, pivoting with the lens end at the center produces favorable results.

[PANORAMA] (p. 23)

Batteries



“Making batteries last longer”

- **Avoid any of the following operations when not actually taking pictures because they deplete the battery power**

- Repeatedly pressing the shutter button halfway.

- Repeatedly using the zoom.

- **Set [POWER SAVE] (p. 47) to [ON]**

Playback/Editing tips

Playback



“Playing images in the internal memory and card”

- Remove the card and display the images in internal memory
 - “Inserting the SD/SDHC memory card (sold separately)” (p. 14)
- Selecting a storage device
[INTERNAL/SD] (p. 41)

“Viewing images with high picture quality on a high-definition TV”

- Connect the camera to the TV using an HDMI cable (sold separately)
 - “To play back camera images on a TV” (p. 46)

Editing



“Erasing the sound recorded to a still image”

- Record over the sound with silence when playing back the image
“Adding sound to still images [🔊]” (p. 40)

Appendix

Camera care

Exterior

- Wipe gently with a soft cloth. If the camera is very dirty, soak the cloth in mild soapy water and wring well. Wipe the camera with the damp cloth and then dry it with a dry cloth. If you have used the camera at the beach, use a cloth soaked in clean water and wrung well.

Monitor

- Wipe gently with a soft cloth.

Lens

- Blow dust off the lens with a commercial blower, then wipe gently with a lens cleaner.

Battery/USB-AC adapter

- Wipe gently with a soft, dry cloth.
 - ⚠ Do not use strong solvents such as benzene or alcohol, or chemically treated cloth.
 - ⚠ Mold may form on the lens surface if the lens is left dirty.

Storage

- When storing the camera for extended periods, remove the battery, AC adapter and card, and keep in a cool, dry place that is well ventilated.
- Periodically insert the battery and test the camera functions.
 - ⚠ Avoid leaving the camera in places where chemical products are handled since this may result in corrosion.

Battery, USB-AC adapter (included), Charger (sold separately)

- This camera uses one Olympus lithium ion battery (LI-50B). No other type of batteries can be used.
 - ⚠ **Caution:**
There is a risk of explosion if the battery is replaced with the incorrect battery type. Dispose of the used battery following the instructions. (p. 64)
- Power consumption by the camera varies depending on which functions are used.
- During the conditions described below, power is consumed continuously and the battery becomes exhausted quickly.
 - The zoom is used repeatedly.
 - The shutter button is pressed halfway repeatedly in shooting mode, activating the auto focus.
 - A picture is displayed on the monitor for an extended period of time.
 - The camera is connected to a printer.
- Using an exhausted battery may cause the camera to turn off without displaying the battery level warning.
- The rechargeable battery is not fully charged at the time of purchase. Before using the camera, charge it by connecting it to a computer, or charge it using the included USB-AC adapter (F-2AC), a separately sold AC adapter (F-1AC/D-7AC) or charger (LI-50C).
- When the included USB-AC adapter (F-2AC) is used, charging usually takes approximately 3.5 hours (varies on usage).
- The included USB-AC adapter (F-2AC) has been designed to be used for charging and playback. Make sure that shooting is not being used while the USB-AC adapter is connected to the camera.

- The included USB-AC adapter (F-2AC) is designed to be used only with this camera. Other cameras cannot be charged with this USB-AC adapter.
- Do not connect the included USB-AC adapter (F-2AC) to equipment other than this camera.
- For plug-in type USB-AC adapter: The included USB-AC adapter (F-2AC) is intended to be correctly orientated in a vertical or floor mount position.

Charging the battery by connecting the camera to a computer

The battery can be charged by connecting the camera to a computer.

Using a separately sold AC adapter

An AC adapter (D-7AC/sold separately) is useful for time-consuming tasks such as when running a slideshow for a long period of time. To use a separately sold AC adapter for this camera, the multi-adapter (CB-MA1, CB-MA3/sold separately) is required. Do not use any other AC adapter with this camera.

Using a separately sold charger

A charger (LI-50C:sold separately) can be used to charge the battery. In this case, remove the battery from the camera and set the battery to the charger.

Using your charger and USB-AC adapter abroad

- The charger and USB-AC adapter can be used in most home electrical sources within the range of 100 V to 240 V AC (50/60Hz) around the world. However, depending on the country or area you are in, the AC wall outlet may be shaped differently and the charger and USB-AC adapter may require a plug adapter to match the wall outlet. For details, ask at your local electrical shop or travel agent.
- Do not use travel voltage converters as they could damage your charger and USB-AC adapter.

Using an SD/SDHC memory card

A card (and internal memory) also corresponds to the film that records images in a film camera. Otherwise, the recorded images (data) can be erased, and retouching is also available with the use of a computer. Cards can be removed from the camera and exchanged, but this is not possible with the internal memory. Use of larger capacity cards enables you to take more pictures.

SD/SDHC memory card write-protect switch

The SD/SDHC memory card body has a write-protect switch. If you set the switch to the "LOCK" side, you will not be able to write to the card, delete data or format. Return the switch to enable writing.



Cards compatible with this camera

SD/SDHC memory cards (for more information, visit the Olympus website)



Using a new card

Cards must be formatted with this camera before first use or after being used with other cameras or computers.

[MEMORY FORMAT]/[FORMAT] (p. 41)

Checking the image saving location

The memory indicator shows whether the internal memory or card is being used during shooting and playback.

Current memory indicator

: Internal memory is being used

: Card is being used

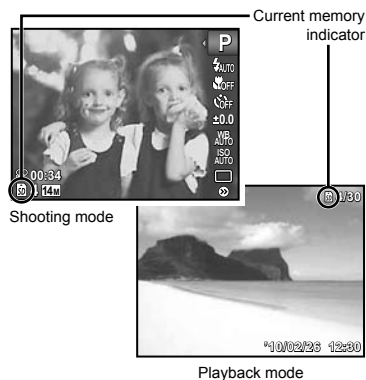

Readout/recording process of the card

During shooting, the current memory indicator is displayed in red while the camera is writing data. Never open the battery/card compartment cover or unplug the USB cable. This can not only damage the image data but also render the internal memory or card unusable.



- ⚠ Even if [MEMORY FORMAT]/[FORMAT], [ERASE], [SEL. IMAGE], [ALL ERASE] or [ERASE EVENT] is performed, the data in the card is not completely erased. When disposing of the card, damage the card to prevent the disclosure of personal data.

Number of storable pictures (still images)/Remaining recording time (movies) in the internal memory and SD/SDHC memory cards

- ! The figures in the following tables are quoted only as a rough guideline. The actual number of storable pictures or remaining recording times will differ according to the shooting conditions and memory cards used.
- ! The figures in the table below are the number of the storable pictures when using the internal memory formatted. "Erasing data completely [MEMORY FORMAT]/[FORMAT]" (p.41)

Still pictures

IMAGE SIZE	COMPRES- SION	Number of storable still pictures			
		Internal memory		SD/SDHC memory card (1 GB)	
		With sound	Without sound	With sound	Without sound
14M 4288×3216	FINE	264	265	140	141
	NORM	514	518	275	277
8M 3264×2448	FINE	449	452	239	241
	NORM	864	877	462	469
5M 2560×1920	FINE	713	722	380	385
	NORM	1,426	1,463	766	786
3M 2048×1536	FINE	1,118	1,141	605	617
	NORM	2,113	2,194	1,164	1,211
2M 1600×1200	FINE	1,783	1,840	961	992
	NORM	3,170	3,356	1,781	1,892
1M 1280×960	FINE	2,594	2,717	1,441	1,514
	NORM	4,755	5,188	2,633	2,883
VGA 640×480	FINE	7,133	8,152	4,325	5,046
	NORM	11,413	14,267	6,729	8,651
16:9L 4288×2416	FINE	350	352	186	187
	NORM	679	687	362	367
16:9S 1920×1080	FINE	1,630	1,678	890	917
	NORM	3,003	3,170	1,682	1,781

Movies



IMAGE SIZE	IMAGE QUALITY	Remaining recording time			
		Internal memory		SD/SDHC memory card (1 GB)	
		With sound	Without sound	With sound	Without sound
720P 1280×720	FINE	19 min. 54 sec.	20 min. 13 sec.	10 min. 32 sec.	10 min. 42 sec.
	NORM	39 min. 9 sec.	40 min. 25 sec.	20 min. 44 sec.	21 min. 24 sec.
	FINE	39 min. 9 sec.	40 min. 25 sec.	20 min. 44 sec.	21 min. 24 sec.
VGA 640×480	NORM	1 h 15 min. 52 sec.	1 h 20 min. 44 sec.	40 min. 10 sec.	42 min. 45 sec.
	FINE	1 h 15 min. 52 sec.	1 h 20 min. 44 sec.	40 min. 10 sec.	42 min. 45 sec.

- ! The maximum file size of a single movie is 4 GB, regardless of the capacity of the card.

Increasing the number of pictures that can be taken

Either erase unwanted images, or connect the camera to a computer or other device to save the images, and then erase the images in the internal memory or card. [ERASE] (p. 18, 39), [ALL ERASE] (p. 39), [SEL. IMAGE] (p. 39), [ERASE EVENT] (p. 39), [MEMORY FORMAT]/[FORMAT] (p. 41)

SAFETY PRECAUTIONS

	CAUTION RISK OF ELECTRIC SHOCK DO NOT OPEN	
CAUTION: TO REDUCE THE RISK OF ELECTRICAL SHOCK, DO NOT REMOVE COVER (OR BACK). NO USER-SERVICEABLE PARTS INSIDE. REFER SERVICING TO QUALIFIED OLYMPUS SERVICE PERSONNEL.		



An exclamation mark enclosed in a triangle alerts you to important operating and maintenance instructions in the documentation provided with the product.



DANGER

If the product is used without observing the information given under this symbol, serious injury or death may result.



WARNING

If the product is used without observing the information given under this symbol, injury or death may result.



CAUTION

If the product is used without observing the information given under this symbol, minor personal injury, damage to the equipment, or loss of valuable data may result.

WARNING!

TO AVOID THE RISK OF FIRE OR ELECTRICAL SHOCK, NEVER DISASSEMBLE, EXPOSE THIS PRODUCT TO WATER OR OPERATE IN A HIGH HUMIDITY ENVIRONMENT.

General Precautions

Read All Instructions — Before you use the product, read all operating instructions. Save all manuals and documentation for future reference.

Cleaning — Always unplug this product from the wall outlet before cleaning. Use only a damp cloth for cleaning. Never use any type of liquid or aerosol cleaner, or any type of organic solvent to clean this product.

Attachments — For your safety, and to avoid damaging the product, use only accessories recommended by Olympus.

Water and Moisture — For precautions on products with weatherproof designs, read the weatherproofing sections.

Location — To avoid damage to the product, mount the product securely on a stable tripod, stand, or bracket.

Power Source — Connect this product only to the power source described on the product label.

Lightning — If a lightning storm occurs while using an AC adapter, remove it from the wall outlet immediately.

Foreign Objects — To avoid personal injury, never insert a metal object into the product.

Heat — Never use or store this product near any heat source such as a radiator, heat register, stove, or any type of equipment or appliance that generates heat, including stereo amplifiers.

Handling the Camera



WARNING

- Do not use the camera near flammable or explosive gases.
- Do not use the flash and LED on people (infants, small children, etc.) at close range.
 - You must be at least 1 m (3 ft.) away from the faces of your subjects. Firing the flash too close to the subject's eyes could cause a momentary loss of vision.
- Keep young children and infants away from the camera.
 - Always use and store the camera out of the reach of young children and infants to prevent the following dangerous situations which could cause serious injury:
 - Becoming entangled in the camera strap, causing strangulation.
 - Accidentally swallowing the battery, cards or other small parts.
 - Accidentally firing the flash into their own eyes or those of another child.
 - Accidentally being injured by the moving parts of the camera.
- Do not look at the sun or strong lights with the camera.
- Do not use or store the camera in dusty or humid places.
- Do not cover the flash with a hand while firing.
- Use SD/SDHC memory cards only. Never use other types of cards.

If you accidentally insert another type of card into the camera, contact an authorized distributor or service center. Do not try to remove the card by force.



CAUTION

- Stop using the camera immediately if you notice any unusual odors, noise, or smoke around it.
 - Never remove the batteries with bare hands, which may cause a fire or burn your hands.
- Never hold or operate the camera with wet hands.
- Do not leave the camera in places where it may be subject to extremely high temperatures.
 - Doing so may cause parts to deteriorate and, in some circumstances, cause the camera to catch fire. Do not use the charger or AC adapter if it is covered (such as a blanket). This could cause overheating, resulting in fire.

- **Handle the camera with care to avoid getting a low-temperature burn.**
 - When the camera contains metal parts, overheating can result in a low-temperature burn. Pay attention to the following:
 - When used for a long period, the camera will get hot. If you hold on to the camera in this state, a low-temperature burn may be caused.
 - In places subject to extremely cold temperatures, the temperature of the camera's body may be lower than the environmental temperature. If possible, wear gloves when handling the camera in cold temperatures.
- **Be careful with the strap.**
 - Be careful with the strap when you carry the camera. It could easily catch on stray objects and cause serious damage.

Battery Handling Precautions

Follow these important guidelines to prevent batteries from leaking, overheating, burning, exploding, or causing electrical shocks or burns.

DANGER

- The camera uses a lithium ion battery specified by Olympus. Charge the battery with the specified AC adapter or charger. Do not use any other AC adapters or chargers.
- Never heat or incinerate batteries.
- Take precautions when carrying or storing batteries to prevent them from coming into contact with any metal objects such as jewelry, pins, fasteners, etc.
- Never store batteries where they will be exposed to direct sunlight, or subjected to high temperatures in a hot vehicle, near a heat source, etc.
- To prevent causing battery leaks or damaging their terminals, carefully follow all instructions regarding the use of batteries. Never attempt to disassemble a battery or modify it in any way, solder, etc.
- If battery fluid gets into your eyes, flush your eyes immediately with clear, cold running water and seek medical attention immediately.
- Always store batteries out of the reach of small children. If a child accidentally swallows a battery, seek medical attention immediately.

WARNING

- Keep batteries dry at all times.
- To prevent batteries from leaking, overheating, or causing a fire or explosion, use only batteries recommended for use with this product.
- Insert the battery carefully as described in the operating instructions.
- If rechargeable batteries have not been recharged within the specified time, stop charging them and do not use them.

CAUTION

- Before loading, always inspect the battery carefully for leaks, discoloration, warping, or any other abnormality.
- The battery may become hot during prolonged use. To avoid minor burns, do not remove it immediately after using the camera.
- Always unload the battery from the camera before storing the camera for a long period.

Caution for Usage Environment

- To protect the high-precision technology contained in this product, never leave the camera in the places listed below, no matter if in use or storage:
 - Places where temperatures and/or humidity are high or go through extreme changes. Direct sunlight, beaches, locked cars, or near other heat sources (stove, radiator, etc.) or humidifiers.
 - In sandy or dusty environments.
 - Near flammable items or explosives.
 - In wet places, such as bathrooms or in the rain. When using products with weatherproof designs, read their manuals as well.
 - In places prone to strong vibrations.
- Never drop the camera or subject it to severe shocks or vibrations.
- When mounted on a tripod, adjust the position of the camera with the tripod head. Do not twist the camera.
- Do not touch electric contacts on cameras.
- Do not leave the camera pointed directly at the sun. This may cause lens or shutter curtain damage, color failure, ghosting on the CCD, or may possibly cause fires.
- Do not push or pull severely on the lens.
- Before storing the camera for a long period, remove the batteries. Select a cool, dry location for storage to prevent condensation or mold from forming inside the camera. After storage, test the camera by turning it on and pressing the shutter button to make sure that it is operating normally.
- Always observe the operating environment restrictions described in the camera's manual.

Battery Handling Precautions

- This camera uses a lithium ion battery specified by Olympus. Do not use any other type of battery.
- If the battery's terminals get wet or greasy, camera contact failure may result. Wipe the battery well with a dry cloth before use.
- Always charge a battery when using it for the first time, or if it has not been used for a long period.
- When operating the camera with battery power at low temperatures, try to keep the camera and spare battery as warm as possible. A battery that has run down at low temperatures may be restored after it is warmed at room temperature.
- The number of pictures you can take may vary depending on the shooting conditions or battery.
- Before going on a long trip, and especially before traveling abroad, purchase extra batteries. A recommended battery may be difficult to obtain while traveling.
- Please recycle batteries to help save our planet's resources. When you throw away dead batteries, be sure to cover their terminals and always observe local laws and regulations.

LCD Monitor

- Do not push the monitor forcibly; otherwise the image may become vague, resulting in a playback mode failure or damage to the monitor.
- A strip of light may appear on the top/bottom of the monitor, but this is not a malfunction.
- When a subject is viewed diagonally in the camera, the edges may appear zigzagged on the monitor. This is not a malfunction; it will be less noticeable in playback mode.
- In places subject to low temperatures, the LCD monitor may take a long time to turn on or its color may change temporarily. When using the camera in extremely cold places, it is a good idea to occasionally place it in a warm place. An LCD monitor exhibiting poor performance due to low temperatures will recover in normal temperatures.
- The LCD used for the monitor is made with high-precision technology. However, black spots or bright spots of light may appear constantly on the LCD Monitor. Due to its characteristics or the angle at which you are viewing the monitor, the spot may not be uniform in color and brightness. This is not a malfunction.

Legal and Other Notices

- Olympus makes no representations or warranties regarding any damages, or benefit expected by using this unit lawfully, or any request from a third person, which are caused by the inappropriate use of this product.
- Olympus makes no representations or warranties regarding any damages or any benefit expected by using this unit lawfully which are caused by erasing picture data.

Disclaimer of Warranty

- Olympus makes no representations or warranties, either expressed or implied, by or concerning any content of these written materials or software, and in no event shall be liable for any implied warranty of merchantability or fitness for any particular purpose or for any consequential, incidental or indirect damages (including but not limited to damages for loss of business profits, business interruption and loss of business information) arising from the use or inability to use these written materials or software or equipment. Some countries do not allow the exclusion or limitation of liability for consequential or incidental damages or of the implied warranty, so the above limitations may not apply to you.
- Olympus reserves all rights to this manual.

Warning

Unauthorized photographing or use of copyrighted material may violate applicable copyright laws. Olympus assumes no responsibility for unauthorized photographing, use or other acts that infringe upon the rights of copyright owners.

Copyright Notice

All rights reserved. No part of these written materials or this software may be reproduced or used in any form or by any means, electronic or mechanical, including photocopying and recording or the use of any type of information storage and retrieval system, without the prior written permission of Olympus. No liability is assumed with respect to the use of the information contained in these written materials or software, or for damages resulting from the use of the information contained therein. Olympus reserves the right to alter the features and contents of this publication or software without obligation or advance notice.

FCC Notice

- Radio and Television Interference
- Changes or modifications not expressly approved by the manufacturer may void the user's authority to operate this equipment. This equipment has been tested and found to comply with the limits for a Class B digital device, pursuant to Part 15 of the FCC Rules. These limits are designed to provide reasonable protection against harmful interference in a residential installation.
- This equipment generates, uses, and can radiate radio frequency energy and, if not installed and used in accordance with the instructions, may cause harmful interference to radio communications.
- However, there is no guarantee that interference will not occur in a particular installation. If this equipment does cause harmful interference to radio or television reception, which can be determined by turning the equipment off and on, the user is encouraged to try to correct the interference by one or more of the following measures:
 - Adjust or relocate the receiving antenna.
 - Increase the distance between the camera and receiver.
 - Connect the equipment to an outlet on a circuit different from that to which the receiver is connected.
 - Consult your dealer or an experienced radio/TV technician for help. Only the OLYMPUS-supplied USB cable should be used to connect the camera to USB enabled personal computers (PC).

Any unauthorized changes or modifications to this equipment would void the user's authority to operate it.

Use Only Dedicated Rechargeable Battery, Battery Charger and AC adapter

We strongly recommend that you use only the genuine Olympus dedicated rechargeable battery, battery charger and AC adapter with this camera. Using a non-genuine rechargeable battery, battery charger and/or AC adapter may result in fire or personal injury due to leakage, heating, ignition or damage to the battery. Olympus does not assume any liability for accidents or damage that may result from the use of a battery, battery charger and/or AC adapter that are not genuine Olympus accessories.

For customers in North and South America

For customers in USA

Declaration of Conformity

Model Number : SP-800UZ

Trade Name : OLYMPUS

Responsible Party :
OLYMPUS IMAGING AMERICA, INC.

Address : 3500 Corporate
Parkway, P.O. Box
610, Center Valley, PA
18034-0610, U.S.A.

Telephone Number : 484-896-5000

Tested To Comply With FCC Standards
FOR HOME OR OFFICE USE

This device complies with Part 15 of the FCC rules.

Operation is subject to the following two conditions:

- (1) This device may not cause harmful interference.
- (2) This device must accept any interference received, including interference that may cause undesired operation.

For customers in Canada

This Class B digital apparatus meets all requirements of the Canadian Interference-Causing Equipment Regulations.

OLYMPUS WORLDWIDE LIMITED WARRANTY - IMAGING PRODUCTS

Olympus warrants that the enclosed Olympus® imaging product(s) and related Olympus® accessories (individually a "Product" and collectively the "Products") will be free from defects in materials and workmanship under normal use and service for a period of one (1) year from the date of purchase.

If any Product proves to be defective within the one-year warranty period, the customer must return the defective Product to any of Olympus Service Centers, following the procedure set forth below (See "WHAT TO DO WHEN SERVICE IS NEEDED").

Olympus, at its sole discretion, will repair, replace, or adjust the defective Product, provided that Olympus investigation and factory inspection disclose that (a) such defect developed under normal and proper use and (b) the Product is covered under this limited warranty.

Repair, replacement, or adjustment of defective Products shall be Olympus's sole obligation and the customer's sole remedy hereunder.

The customer is liable and shall pay for shipment of the Products to the Olympus Service Center. Olympus shall not be obligated to perform

preventive maintenance, installation, deinstallation, or maintenance.

Olympus reserves the right to (i) use reconditioned, refurbished, and/or serviceable used parts (that meet Olympus's quality assurance standards) for warranty or any other repairs and (ii) make any internal or external design and/or feature changes on or to its products without any liability to incorporate such changes on or to the Products.

WHAT IS NOT COVERED BY THIS LIMITED WARRANTY

Excluded from this limited warranty and not warranted by Olympus in any fashion, either express, implied, or by statute, are:

- (a) products and accessories not manufactured by Olympus and/or not bearing the "OLYMPUS" brand label (the warranty coverage for products and accessories of other manufacturers, which may be distributed by Olympus, is the responsibility of the manufacturers of such products and accessories in accordance with the terms and duration of such manufacturers' warranties);
- (b) any Product which has been disassembled, repaired, tampered with, altered, changed, or modified by persons other than Olympus's own authorized service personnel unless repair by others is made with the written consent of Olympus;
- (c) defects or damage to the Products resulting from wear, tear, misuse, abuse, negligence, sand, liquids, impact, improper storage, nonperformance of scheduled operator and maintenance items, battery leakage, use of non-"OLYMPUS" brand accessories, consumables, or supplies, or use of the Products in combination with non-compatible devices;
- (d) software programs;
- (e) supplies and consumables (including but not limited to lamps, ink, paper, film, prints, negatives, cables and batteries); and/or
- (f) Products which do not contain a validly placed and recorded Olympus serial number, unless they are a model on which Olympus does not place and record serial numbers.

EXCEPT FOR THE LIMITED WARRANTY SET FORTH ABOVE, OLYMPUS MAKES NO AND DISCLAIMS ALL OTHER REPRESENTATIONS, GUARANTIES, CONDITIONS, AND WARRANTIES CONCERNING THE PRODUCTS, WHETHER DIRECT OR INDIRECT, EXPRESS OR IMPLIED, OR ARISING UNDER ANY STATUTE, ORDINANCE, COMMERCIAL USAGE OR OTHERWISE, INCLUDING BUT NOT LIMITED TO ANY WARRANTY OR REPRESENTATION AS TO THE SUITABILITY, DURABILITY, DESIGN, OPERATION, OR

CONDITION OF THE PRODUCTS (OR ANY PART THEREOF) OR THE MERCHANTABILITY OF THE PRODUCTS OR THEIR FITNESS FOR A PARTICULAR PURPOSE, OR RELATING TO THE INFRINGEMENT OF ANY PATENT, COPYRIGHT, OR OTHER PROPRIETARY RIGHT USED OR INCLUDED THEREIN.

IF ANY IMPLIED WARRANTIES APPLY AS A MATTER OF LAW, THEY ARE LIMITED IN DURATION TO THE LENGTH OF THIS LIMITED WARRANTY.

SOME STATES MAY NOT RECOGNIZE A DISCLAIMER OR LIMITATION OF WARRANTIES AND/OR LIMITATION OF LIABILITY SO THE ABOVE DISCLAIMERS AND EXCLUSIONS MAY NOT APPLY.

THE CUSTOMER MAY ALSO HAVE DIFFERENT AND/OR ADDITIONAL RIGHTS AND REMEDIES THAT VARY FROM STATE TO STATE.

THE CUSTOMER ACKNOWLEDGES AND AGREES THAT OLYMPUS SHALL NOT BE RESPONSIBLE FOR ANY DAMAGES THAT THE CUSTOMER MAY INCUR FROM DELAYED SHIPMENT, PRODUCT FAILURE, PRODUCT DESIGN, SELECTION, OR PRODUCTION, IMAGE OR DATA LOSS OR IMPAIRMENT OR FROM ANY OTHER CAUSE, WHETHER LIABILITY IS ASSERTED IN CONTRACT, TORT (INCLUDING NEGLIGENCE AND STRICT PRODUCT LIABILITY) OR OTHERWISE. IN NO EVENT SHALL OLYMPUS BE LIABLE FOR ANY INDIRECT, INCIDENTAL, CONSEQUENTIAL OR SPECIAL DAMAGES OF ANY KIND (INCLUDING WITHOUT LIMITATION LOSS OF PROFITS OR LOSS OF USE), WHETHER OR NOT OLYMPUS SHALL BE OR SHOULD BE AWARE OF THE POSSIBILITY OF SUCH POTENTIAL LOSS OR DAMAGE.

Representations and warranties made by any person, including but not limited to dealers, representatives, salespersons, or agents of Olympus, which are inconsistent or in conflict with or in addition to the terms of this limited warranty, shall not be binding upon Olympus unless reduced to writing and approved by an expressly authorized officer of Olympus. This limited warranty is the complete and exclusive statement of warranty which Olympus agrees to provide with respect to the Products and it shall supersede all prior and contemporaneous oral or written agreements, understandings, proposals, and communications pertaining to the subject matter hereof. This limited warranty is exclusively for the benefit of the original customer and cannot be transferred or assigned.

WHAT TO DO WHEN SERVICE IS NEEDED

The customer must transfer any image or other data saved on a Product to another image or data storage medium and/or remove any film from the Product prior to sending the Product to Olympus for service.

IN NO EVENT SHALL OLYMPUS BE RESPONSIBLE FOR SAVING, KEEPING OR MAINTAINING ANY IMAGE OR DATA SAVED ON A PRODUCT RECEIVED BY IT FOR SERVICE, OR ON ANY FILM CONTAINED WITHIN A PRODUCT RECEIVED BY IT FOR SERVICE, NOR SHALL OLYMPUS BE RESPONSIBLE FOR ANY DAMAGES IN THE EVENT ANY IMAGE OR DATA IS LOST OR IMPAIRED WHILE SERVICE IS BEING PERFORMED (INCLUDING, WITHOUT LIMITATION, DIRECT, INDIRECT, INCIDENTAL, CONSEQUENTIAL OR SPECIAL DAMAGES, LOSS OF PROFITS OR LOSS OF USE), WHETHER OR NOT OLYMPUS SHALL BE OR SHOULD BE AWARE OF THE POSSIBILITY OF SUCH POTENTIAL LOSS OR IMPAIRMENT.

Package the Product carefully using ample padding material to prevent damage in transit and either deliver it to the Authorized Olympus Dealer that sold you the Product or ship it postage prepaid and insured to any of our Olympus Service Centers.

When returning Products for service, your package should include the following:

- 1 Sales receipt showing date and place of purchase.
- 2 Copy of this limited warranty **bearing the Product serial number corresponding to the serial number on the Product** (unless it is a model on which Olympus does not place and record serial numbers).
- 3 A detailed description of the problem.
- 4 Sample prints, negatives, digital prints (or files on disk) if available and related to the problem.

When service is completed, the Product will be returned to you postage prepaid.

WHERE TO SEND PRODUCT FOR SERVICE

See "WORLDWIDE WARRANTY" for the nearest service center.

INTERNATIONAL WARRANTY SERVICE

International warranty service is available under this warranty.

For customers in Europe



"CE" mark indicates that this product complies with the European requirements for safety, health, environment and customer protection. "CE" mark cameras are intended for sales in Europe.



This symbol [crossed-out wheeled bin WEEE Annex IV] indicates separate collection of waste electrical and electronic equipment in the EU countries.

Please do not throw the equipment into the domestic refuse.

Please use the return and collection systems available in your country for the disposal of this product.



This symbol [crossed-out wheeled bin Directive 2006/66/EC Annex II] indicates separate collection of waste batteries in the EU countries. Please do not throw the batteries into the domestic refuse. Please use the return and collection systems available in your country for the disposal of the waste batteries.

Provisions of warranty

- 1 If this product proves to be defective, although it has been used properly (in accordance with the written Handling Care and Operating instructions supplied with it), during the applicable national warranty period and has been purchased from an authorized Olympus distributor within the business area of Olympus Europa Holding GmbH as stipulated on the website: <http://www.olympus.com> this product will be repaired, or at Olympus's option replaced, free of charge. To claim under this warranty the customer must take the product before the end of the applicable national warranty period to the dealer where the product was purchased or any other Olympus service station within the business area of Olympus Europa Holding GmbH as stipulated on the website: <http://www.olympus.com>. During the one year period of the World Wide Guarantee the customer may turn the product in at any Olympus service station. Please notice that not in all countries such Olympus service station exists.
- 2 The customer shall transport the product to the dealer or Olympus authorized service station at his own risk and shall be responsible for any costs incurred in transporting the product.

Provisions of Guarantee

- 1 "OLYMPUS IMAGING CORP., Shinjuku Monolith, 2-3-1 Nishi-Shinjuku, Shinjuku-ku, Tokyo 163-0914, Japan grants a one year World Wide Guarantee. This worldwide Guarantee must be presented at an Olympus authorized repair service station before any repair can be made under conditions of this Guarantee. This Guarantee is valid only if the Guarantee Certificate and proof of purchase are presented at the Olympus repair service station. Please note that this Guarantee is in addition to and does not

affect the customer's legal warranty rights under the applicable national legislation governing the sale of consumer goods mentioned above.

- 2 This Guarantee does not cover the following and the customer will be required to pay repair charge, even for defects occurring within the Guarantee period referred to above.
 - a. Any defect that occurs due to mishandling (such as an operation performed that is not mentioned in the Handling Care or other sections of the instructions, etc.)
 - b. Any defect that occurs due to repair, modification, cleaning, etc. performed by anyone other than Olympus or an Olympus authorized service station.
 - c. Any defect or damage that occurs due to transport, a fall, shock, etc. after purchase of the product.
 - d. Any defect or damage that occurs due to fire, earthquake, flood damage, thunderbolt, other natural disasters, environmental pollution and irregular voltage sources.
 - e. Any defect that occurs due to careless or improper storage (such as keeping the product under conditions of high temperature and humidity, near insect repellents such as naphthalene or harmful drugs, etc.), improper maintenance, etc.
 - f. Any defect that occurs due to exhausted batteries, etc.
 - g. Any defect that occurs due to sand, mud, etc. entering the inside of the product casing.
 - h. When the Guarantee Certificate is not returned with the product.
 - i. When any alterations whatsoever are made to the Guarantee Certificate regarding the year, month and date of purchase, the customer's name, the dealer's name, and the serial number.
 - j. When proof of purchase is not presented with this Guarantee Certificate.
- 3 This Guarantee applies to the product only; the Guarantee does not apply to any other accessory equipment, such as the case, strap, lens cap and batteries.
- 4 Olympus's sole liability under this Guarantee shall be limited to repairing or replacing the product. Any liability under the Guarantee for indirect or consequential loss or damage of any kind incurred or suffered by the customer due to a defect of the product, and in particular any loss or damage caused to any lenses, films, other equipment or accessories used with the product or for any loss resulting from a delay in repair or loss of data, is excluded. Compelling regulations by law remain unaffected by this.

Notes regarding Guarantee maintenance

- 1 This Guarantee will only be valid if the Guarantee Certificate is duly completed by Olympus or an authorized dealer or other documents contain sufficient proof. Therefore, please make sure that your name, the name of the dealer, the serial number and the year, month and date of purchase are all completed or the original invoice or the sales receipt (indicating the dealer's name, the date of purchase and product type) is attached to this Guarantee Certificate. Olympus reserves the right to refuse free-of-charge service if neither Guarantee Certificate is completed nor the above document is attached or if the information contained in it is incomplete or illegible.
- 2 Since this Guarantee Certificate will not be re-issued, keep it in a safe place.
- * Please refer to the list on the web site: <http://www.olympus.com> for the authorized international Olympus service network.

For customers in Asia

Provisions of warranty

- 1 If this product proves to be defective, although it has been used properly (in accordance with the written Handling Care and Operating instructions supplied with it), during a period of up to one year from the date of purchase this product will be repaired, or at Olympus's option replaced, free of charge. To claim under warranty the customer must take the product and this Warranty certificate before the end of the one year warranty period to the dealer where the product was purchased or any Olympus authorized service station listed in the instructions and request the necessary repairs.
- 2 The customer shall transport the product to the dealer or Olympus authorized service station at his own risk and shall be responsible for any costs incurred in transporting the product.
- 3 This warranty does not cover the following and the customer will be required to pay repair charge, even for defects occurring within the one year period referred to above.
 - a. Any defect that occurs due to mishandling (such as an operation performed that is not mentioned in the Handling Care or other sections of the instructions, etc.)
 - b. Any defect that occurs due to repair, modification, cleaning, etc. performed by anyone other than Olympus or an Olympus authorized service station.
 - c. Any defect or damage that occurs due to transport, a fall, shock, etc. after purchase of the product.
 - d. Any defect or damage that occurs due to fire, earthquake, flood damage, thunderbolt, other natural disasters, environmental pollution and irregular voltage sources.

- e. Any defect that occurs due to careless or improper storage (such as keeping the product under conditions of high temperature and humidity, near insect repellents such as naphthalene or harmful drugs, etc.), improper maintenance, etc.
 - f. Any defect that occurs due to exhausted batteries, etc.
 - g. Any defect that occurs due to sand, mud, etc. entering the inside of the product casing.
 - h. When this Warranty Certificate is not returned with the product.
 - i. When any alterations whatsoever are made to the Warranty Certificate regarding the year, month and date of purchase, the customer's name, the dealer's name, and the serial number.
 - j. When proof of purchase is not presented with this Warranty Certificate.
- 4 This Warranty applies to the product only; the Warranty does not apply to any other accessory equipment, such as the case, strap, lens cap and batteries.
 - 5 Olympus' sole liability under this warranty shall be limited to repairing or replacing the product and any liability for indirect or consequential loss or damage of any kind incurred or suffered by the customer due to a defect in the product, and in particular any loss or damage caused to any film or lenses or other equipment or accessories used with the product or for any loss resulting from delay in repair, is excluded.

Notes;

- 1 This Warranty is in addition to and does not affect the customer's statutory right.
- 2 If you have any queries regarding this Warranty, call any of the Olympus authorized service stations listed in the instructions.

Notes regarding warranty maintenance

- 1 This Warranty will only be valid if the Warranty Certificate is duly completed by Olympus or the dealer. Make sure that your name, the name of the dealer, the serial number and the year, month and date of purchase are all completed.
- 2 Since this Warranty Certificate will not be re-issued, keep it in a safe place.
- 3 Any request for repair by a customer in same country where the product was purchased shall be subject to the terms of the warranty issued by the Olympus distributor in that country. Where the local Olympus distributor does not issue a separate warranty or where the customer is not in the country where the product was purchased the terms of this worldwide warranty shall apply.
- 4 Where applicable, this Warranty is valid worldwide. The Olympus authorized service stations listed in this Warranty will gladly honor it.
- * Please refer to the appended list for the authorized international Olympus service network.

Disclaimer of Warranty

Olympus makes no representations or warranties, either expressed or implied, by or concerning any content if these written materials or software, and in no event shall be liable for any implied warranty of merchantability or fitness for any particular purpose or for any consequential, incidental or indirect damages (including but not limited to damages for loss of business profits, business interruption and loss of business information) arising from the use of inability to use these written materials or software. Some states do not allow the exclusion or limitation of liability for consequential or incidental damages, so the above limitations may not apply to you.

Trademarks

- IBM is a registered trademark of International Business Machines Corporation.
- Microsoft and Windows are registered trademarks of Microsoft Corporation.
- Macintosh is a trademark of Apple Inc.
- The SDHC logo is a trademark.
- All other company and product names are registered trademarks and/or trademarks of their respective owners.
- The standards for camera file systems referred to in this manual are the "Design rule for Camera File system/DCF" standards stipulated by the Japan Electronics and Information Technology Industries Association (JEITA).

THIS PRODUCT IS LICENSED UNDER THE AVC PATENT PORTFOLIO LICENSE FOR THE PERSONAL AND NONCOMMERCIAL USE OF A CONSUMER TO (i) ENCODE VIDEO IN COMPLIANCE WITH THE AVC STANDARD ("AVC VIDEO") AND/OR (ii) DECODE AVC VIDEO THAT WAS ENCODED BY A CONSUMER ENGAGED IN A PERSONAL AND NON-COMMERCIAL ACTIVITY AND/OR WAS OBTAINED FROM A VIDEO PROVIDER LICENSED TO PROVIDE AVC VIDEO. NO LICENSE IS GRANTED OR SHALL BE IMPLIED FOR ANY OTHER USE. ADDITIONAL INFORMATION MAY BE OBTAINED FROM MPEG LA, L.L.C. SEE [HTTP://WWW.MPEGLA.COM](http://www.mpegla.com)

SPECIFICATIONS

Camera

Product type	: Digital camera (for shooting and displaying)
Recording system	
Still pictures	: Digital recording, JPEG (in accordance with Design rule for Camera File system (DCF))
Applicable standards	: Exif 2.2, Digital Print Order Format (DPOF), PRINT Image Matching III, PictBridge
Sound with still pictures	: Wave format
Movie	: MPEG-4AVC/H.264
Memory	: Internal memory SD memory card SDHC memory card
No. of effective pixels	: 14,000,000 pixels
Image pickup device	: 1/2.33" CCD (primary color filter)
Lens	: Olympus lens 4.9 to 147 mm, f2.8 to 5.6 (equivalent to 28 to 840 mm on a 35 mm camera)
Photometric system	: Digital ESP metering, spot metering system
Shutter speed	: 1/2 to 1/2000 sec.
Shooting range	: 0.1 m (0.3 ft.) to ∞ (W) 1.8 m (5.9 ft.) to ∞ (T) (normal/macro mode) 0.01 m (0.03 ft.) to ∞ (super macro mode)
Monitor	: 3.0" TFT color LCD display, 230,000 dots
Connector	: Multi-connector (DC-IN jack, USB connector, A/V OUT jack) / HDMI micro connector (type D)
Automatic calendar system	: 2000 up to 2099
Operating environment	
Temperature	: 0 °C to 40 °C (32 °F to 104 °F) (operation)/ -20 °C to 60 °C (-4 °F to 140 °F) (storage)
Humidity	: 30 % to 90 % (operation)/10 % to 90 % (storage)
Power supply	: One Olympus lithium ion battery (LI-50B) or separately sold AC adapter
Dimensions	: 107.3 mm (W) × 73.4 mm (H) × 84.7 mm (D) (4.2 × 2.9 × 3.3 in.) (excluding protrusions)
Weight	: 418 g (14.7 oz) (Including battery and card)

Lithium ion battery (LI-50B)

Product type	: Lithium ion rechargeable battery
Model No.	: LI-50BA/LI-50BB
Standard voltage	: DC 3.7 V
Standard capacity	: 925 mAh
Battery life	: Approx. 300 full charges (varies on usage)
Operating environment	
Temperature	: 0 °C to 40 °C (32 °F to 104 °F) (charging)/ -10 °C to 60 °C (14 °F to 140 °F) (operation)/ -10 °C to 35 °C (14 °F to 95 °F) (storage)
Dimensions	: 34.4 mm (W) × 40.0 mm (H) × 7.0 mm (D) (1.4 × 1.6 × 0.3 in.)
Weight	: Approx. 20 g (0.7 oz)

USB-AC adapter (F-2AC)

Model No.	: F-2AC-1A/F-2AC-2A/F-2AC-1B/F-2AC-2B
Power requirements	: AC 100 to 240 V (50/60 Hz)
Output	: DC 5 V, 500 mA
Operating environment	
Temperature	: 0 °C to 40 °C (32 °F to 104 °F) (operation)/ -20 °C to 60 °C (-4 °F to 140 °F) (storage)
Dimensions	: 50.0 mm (W) × 54.0 mm (H) × 22.0 mm (D) (2.0 × 2.1 × 0.9 in.)
Weight	: Approx. 46.0 g (1.6 oz) (F-2AC-1A)/Approx. 42.0 g (1.5 oz) (F-2AC-2A)/ Approx. 44.0 g (1.6 oz) (F-2AC-1B)/Approx. 40.0 g (1.4 oz) (F-2AC-2B)

Design and specifications subject to change without notice.

HDMI, the HDMI Logo and High-Definition Multimedia Interface are trademarks or registered trademarks of HDMI Licensing LLC.

HDMI™
HIGH-DEFINITION MULTIMEDIA INTERFACE

OLYMPUS®

<http://www.olympus.com/>

OLYMPUS IMAGING CORP.

Shinjuku Monolith, 3-1 Nishi-Shinjuku 2-chome, Shinjuku-ku, Tokyo, Japan

OLYMPUS IMAGING AMERICA INC.

3500 Corporate Parkway, P.O. Box 610, Center Valley, PA 18034-0610, U.S.A. Tel. 484-896-5000

Technical Support (USA)

24/7 online automated help: <http://www.olympusamerica.com/support>

Phone customer support: Tel. 1-888-553-4448 (Toll-free)

Our phone customer support is available from 8 am to 10 pm

(Monday to Friday) ET

<http://olympusamerica.com/contactus>

Olympus software updates can be obtained at: <http://www.olympusamerica.com/digital>

OLYMPUS EUROPA HOLDING GMBH

Premises: Wendenstrasse 14-18, 20097 Hamburg, Germany

Tel: +49 40-23 77 3-0 / Fax: +49 40-23 07 61

Goods delivery: Bredowstrasse 20, 22113 Hamburg, Germany

Letters: Postfach 10 49 08, 20034 Hamburg, Germany

European Technical Customer Support:

Please visit our homepage <http://www.olympus-europa.com>

or call our TOLL FREE NUMBER* : **00800 - 67 10 83 00**

for Austria, Belgium, Denmark, Finland, France, Germany, Italy, Luxemburg, Netherlands,
Norway, Portugal, Spain, Sweden, Switzerland, United Kingdom

* Please note some (mobile) phone services providers do not permit access or request an
additional prefix to +800 numbers.

For all European Countries not listed and in case that you can't get connected

to the above mentioned number, please make use of the following

CHARGED NUMBERS: **+49 180 5 - 67 10 83** or **+49 40 - 237 73 4899**

Our Technical Customer Support is available from 9 am to 6 pm MET (Monday to Friday)

OLYMPUS IMAGING CHINA CO.,LTD.

Customer Support: 400-650-0303

Homepage: <http://www.olympus.com.cn>

Customer Service Center:

A8F, Ping An International Financial Center, No. 1-3, Xinyuan South Road, Chaoyang District, Beijing

Tel: +86-10-85180009 Fax: +86-10-65693356 Zip: 100022

A,32F Shanghai Industrial Investment Building 18 Cao Xi Road(N),Xuhui District, Shanghai

Tel: +86-21-60823500 Fax: +86-21-60823100 Zip: 200030

Rm.1605-1608, Guangzhou International Electronic tower, No403, Huan Shi East Road, Guang Zhou

Tel: +86-20-61227111 Fax: +86-20-61227120 Zip: 510095

Rm. 2408, 24F ZhengXi International Tower, No16, Segment 3, Hong Xing Road, Jinjiang District, Chengdu

Tel: +86-28-86669700 Fax: +86-28-86662225 Zip: 610016

OLYMPUS HONG KONG AND CHINA LIMITED

L43, Office Tower, Langham Place, 8 Argyle Street, Mongkok, Kowloon, Hong Kong.

Tel: (852) 2481-7812 Fax: (852) 2730-7976

Free Manuals Download Website

<http://myh66.com>

<http://usermanuals.us>

<http://www.somanuals.com>

<http://www.4manuals.cc>

<http://www.manual-lib.com>

<http://www.404manual.com>

<http://www.luxmanual.com>

<http://aubethermostatmanual.com>

Golf course search by state

<http://golfingnear.com>

Email search by domain

<http://emailbydomain.com>

Auto manuals search

<http://auto.somanuals.com>

TV manuals search

<http://tv.somanuals.com>