

K9N2 SLI Platinum Series

MS-7374 (v1.X) Mainboard

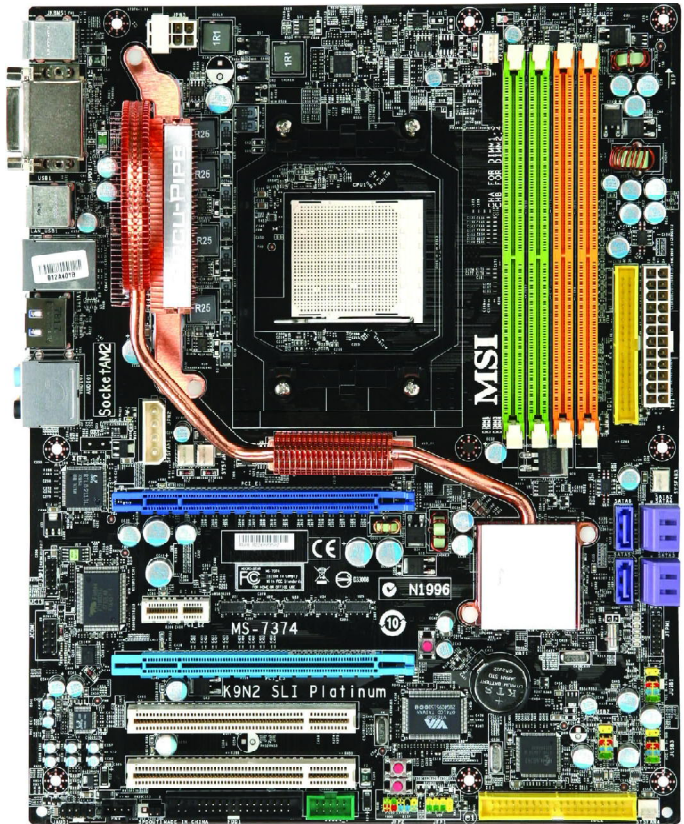

G52-73741X1

Copyright Notice

The material in this document is the intellectual property of **MICRO-STAR INTERNATIONAL**. We take every care in the preparation of this document, but no guarantee is given as to the correctness of its contents. Our products are under continual improvement and we reserve the right to make changes without notice.

Trademarks

All trademarks are the properties of their respective owners.

NVIDIA, the NVIDIA logo, DualNet, and nForce are registered trademarks or trademarks of NVIDIA Corporation in the United States and/or other countries.

AMD, Athlon™, Athlon™ XP, Thoroughbred™, and Duron™ are registered trademarks of AMD Corporation.

Intel® and Pentium® are registered trademarks of Intel Corporation.

PS/2 and OS®/2 are registered trademarks of International Business Machines Corporation.

Windows® 95/98/2000/NT/XP are registered trademarks of Microsoft Corporation.

Netware® is a registered trademark of Novell, Inc.

Award® is a registered trademark of Phoenix Technologies Ltd.

AMI® is a registered trademark of American Megatrends Inc.

Revision History

Revision	Revision History	Date
V1.0	First release for PCB 1.X	April 2008

Technical Support

If a problem arises with your system and no solution can be obtained from the user's manual, please contact your place of purchase or local distributor. Alternatively, please try the following help resources for further guidance.

- 🔍 Visit the MSI website for FAQ, technical guide, BIOS updates, driver updates, and other information: <http://global.msi.com.tw/index.php?func=faqIndex>
- 🔍 Contact our technical staff at: <http://support.msi.com.tw/>

Safety Instructions

1. Always read the safety instructions carefully.
2. Keep this User's Manual for future reference.
3. Keep this equipment away from humidity.
4. Lay this equipment on a reliable flat surface before setting it up.
5. The openings on the enclosure are for air convection hence protects the equipment from overheating. **DO NOT COVER THE OPENINGS.**
6. Make sure the voltage of the power source and adjust properly 110/220V before connecting the equipment to the power inlet.
7. Place the power cord such a way that people can not step on it. Do not place anything over the power cord.
8. Always Unplug the Power Cord before inserting any add-on card or module.
9. All cautions and warnings on the equipment should be noted.
10. Never pour any liquid into the opening that could damage or cause electrical shock.
11. If any of the following situations arises, get the equipment checked by a service personnel:
 - † The power cord or plug is damaged.
 - † Liquid has penetrated into the equipment.
 - † The equipment has been exposed to moisture.
 - † The equipment has not work well or you can not get it work according to User's Manual.
 - † The equipment has dropped and damaged.
 - † The equipment has obvious sign of breakage.
12. **DO NOT LEAVE THIS EQUIPMENT IN AN ENVIRONMENT UNCONDITIONED, STORAGE TEMPERATURE ABOVE 60°C (140°F), IT MAY DAMAGE THE EQUIPMENT.**



CAUTION: Danger of explosion if battery is incorrectly replaced. Replace only with the same or equivalent type recommended by the manufacturer.



警告使用者:
這是甲類的資訊產品，在居住的環境中使用時，可能會造成無線電干擾，在這種情況下，使用者會被要求採取某些適當的對策。



廢電池請回收

For better environmental protection, waste batteries should be collected separately for recycling or special disposal.

FCC-B Radio Frequency Interference Statement

This equipment has been tested and found to comply with the limits for a Class B digital device, pursuant to Part



15 of the FCC Rules. These limits are designed to provide reasonable protection against harmful interference in a residential installation. This equipment generates, uses and can radiate radio frequency energy and, if not installed and used in accordance with the instructions, may cause harmful interference to radio communications. However, there is no guarantee that interference will not occur in a particular installation. If this equipment does cause harmful interference to radio or television reception, which can be determined by turning the equipment off and on, the user is encouraged to try to correct the interference by one or more of the measures listed below.

- † Reorient or relocate the receiving antenna.
- † Increase the separation between the equipment and receiver.
- † Connect the equipment into an outlet on a circuit different from that to which the receiver is connected.
- † Consult the dealer or an experienced radio/television technician for help.

Notice 1

The changes or modifications not expressly approved by the party responsible for compliance could void the user's authority to operate the equipment.

Notice 2

Shielded interface cables and A.C. power cord, if any, must be used in order to comply with the emission limits.

VOIR LANOTICE D'INSTALLATIONAVANT DE RACCORDER AU RESEAU.



This device complies with Part 15 of the FCC Rules. Operation is subject to the following two conditions:

- (1) this device may not cause harmful interference, and*
- (2) this device must accept any interference received, including interference that may cause undesired operation.*

WEEE (Waste Electrical and Electronic Equipment) Statement



ENGLISH

To protect the global environment and as an environmentalist, MSI must remind you that...

Under the European Union ("EU") Directive on Waste Electrical and Electronic Equipment, Directive 2002/96/EC, which takes effect on August 13, 2005, products of "electrical and electronic equipment" cannot be discarded as municipal waste anymore and manufacturers of covered electronic equipment will be obligated to take back such products at the end of their useful life. MSI will comply with the product take back requirements at the end of life of MSI-branded products that are sold into the EU. You can return these products to local collection points.

DEUTSCH

Hinweis von MSI zur Erhaltung und Schutz unserer Umwelt

Gemäß der Richtlinie 2002/96/EG über Elektro- und Elektronik-Altgeräte dürfen Elektro- und Elektronik-Altgeräte nicht mehr als kommunale Abfälle entsorgt werden. MSI hat europaweit verschiedene Sammel- und Recyclingunternehmen beauftragt, die in die Europäische Union in Verkehr gebrachten Produkte, am Ende seines Lebenszyklus zurückzunehmen. Bitte entsorgen Sie dieses Produkt zum gegebenen Zeitpunkt ausschließlich an einer lokalen Altgerätesammelstelle in Ihrer Nähe.

FRANÇAIS

En tant qu'écologiste et afin de protéger l'environnement, MSI tient à rappeler ceci...

Au sujet de la directive européenne (EU) relative aux déchets des équipements électriques et électroniques, directive 2002/96/EC, prenant effet le 13 août 2005, que les produits électriques et électroniques ne peuvent être déposés dans les décharges ou tout simplement mis à la poubelle. Les fabricants de ces équipements seront obligés de récupérer certains produits en fin de vie. MSI prendra en compte cette exigence relative au retour des produits en fin de vie au sein de la communauté européenne. Par conséquent vous pouvez retourner localement ces matériels dans les points de collecte.

РУССКИЙ

Компания MSI предпринимает активные действия по защите окружающей среды, поэтому напоминаем вам, что...

В соответствии с директивой Европейского Союза (ЕС) по предотвращению загрязнения окружающей среды использованным электрическим и электронным оборудованием (директива WEEE 2002/96/EC), вступающей в силу 13 августа 2005 года, изделия, относящиеся к электрическому и электронному оборудованию, не могут рассматриваться как бытовой мусор, поэтому производители вышеперечисленного электронного оборудования обязаны принимать его для переработки по окончании срока службы. MSI обязуется соблюдать требования по приему продукции, проданной под маркой MSI на территории ЕС, в переработку по окончании срока службы. Вы можете вернуть эти изделия в специализированные пункты приема.

ESPAÑOL

MSI como empresa comprometida con la protección del medio ambiente, recomienda:

Bajo la directiva 2002/96/EC de la Unión Europea en materia de desechos y/o equipos electrónicos, con fecha de rigor desde el 13 de agosto de 2005, los productos clasificados como "eléctricos y equipos electrónicos" no pueden ser depositados en los contenedores habituales de su municipio, los fabricantes de equipos electrónicos, están obligados a hacerse cargo de dichos productos al término de su período de vida. MSI estará comprometido con los términos de recogida de sus productos vendidos en la Unión Europea al final de su período de vida. Usted debe depositar estos productos en el punto limpio establecido por el ayuntamiento de su localidad o entregar a una empresa autorizada para la recogida de estos residuos.

NEDERLANDS

Om het milieu te beschermen, wil MSI u eraan herinneren dat...

De richtlijn van de Europese Unie (EU) met betrekking tot Vervuiling van Electriche en Electronische producten (2002/96/EC), die op 13 Augustus 2005 in zal gaan kunnen niet meer beschouwd worden als vervuiling.

Fabrikanten van dit soort producten worden verplicht om producten retour te nemen aan het eind van hun levenscyclus. MSI zal overeenkomstig de richtlijn handelen voor de producten die de merknaam MSI dragen en verkocht zijn in de EU. Deze goederen kunnen geretourneerd worden op lokale inzamelingspunten.

SRPSKI

Da bi zaštitili prirodnu sredinu, i kao preduzeće koje vodi računa o okolini i prirodnoj sredini, MSI mora da vas podesti da...

Po Direktivi Evropske unije ("EU") o odbačenju elektronskoj i električnoj opremi, Direktiva 2002/96/EC, koja stupa na snagu od 13. Avgusta 2005, proizvodi koji spadaju pod "elektronsku i električnu opremu" ne mogu više biti odbačeni kao običan otpad i proizvođači ove opreme biće prinudeni da uzmu natrag ove proizvode na kraju njihovog uobičajenog veka trajanja. MSI će poštovati zahtev o preuzimanju ovakvih proizvoda kojima je istekao vek trajanja, koji imaju MSI oznaku i koji su prodati u EU. Ove proizvode možete vratiti na lokalnim mestima za prikupljanje.

POLSKI

Aby chronić nasze środowisko naturalne oraz jako firma dbająca o ekologię, MSI przypomina, że...

Zgodnie z Dyrektywą Unii Europejskiej ("UE") dotyczącą odpadów produktów elektrycznych i elektronicznych (Dyrektywa 2002/96/EC), która wchodzi w życie 13 sierpnia 2005, tzw. "produkty oraz wyposażenie elektryczne i elektroniczne" nie mogą być traktowane jako śmieć komunalne, tak więc producenci tych produktów będą zobowiązani do odbierania ich w momencie gdy produkt jest wycofywany z użycia. MSI wypełni wymagania UE, przyjmując produkty (sprzedawane na terenie Unii Europejskiej) wycofywane z użycia. Produkty MSI będzie można zwracać w wyznaczonych punktach zbiorczych.

TÜRKÇE

Çevreci özelliğiyle bilinen MSI dünyada çevreyi korumak için hatırlatır:

Avrupa Birliği (AB) Kararnamesi Elektrik ve Elektronik Malzeme Atığı, 2002/96/EC Kararnamesi altında 13 Ağustos 2005 tarihinden itibaren geçerli olmak üzere, elektrikli ve elektronik malzemeler diğer atıklar gibi çöpe atılmayacak ve bu elektronik cihazların üreticileri, cihazların kullanım süreleri bittikten sonra ürünleri geri toplamakla yükümlü olacaktır, Avrupa Birliği'ne satılan MSI markalı ürünlerin kullanım süreleri bittiğinde MSI ürünlerin geri alınması isteği ile işbirliği içerisinde olacaktır. Ürünlerinizi yerel toplama noktalarına bırakabilirsiniz.

ČESKY

Záleží nám na ochraně životního prostředí - společnost MSI upozorňuje...

Podle směrnice Evropské unie ("EU") o likvidaci elektrických a elektronických výrobků 2002/96/EC platné od 13. srpna 2005 je zakázáno likvidovat "elektrické a elektronické výrobky" v běžném komunálním odpadu a výrobci elektronických výrobků, na které se tato směrnice vztahuje, budou povinni odebrat takové výrobky zpět po skončení jejich životnosti. Společnost MSI splní požadavky na odebrání výrobků značky MSI, prodávaných v zemích EU, po skončení jejich životnosti. Tyto výrobky můžete odevzdat v místních sběrnách.

MAGYAR

Annak érdekében, hogy környezetünket megvédjük, illetve környezetvédőként fellépve az MSI emlékezteti Önt, hogy ...

Az Európai Unió („EU”) 2005. augusztus 13-án hatályba lépő, az elektromos és elektronikus berendezések hulladékairól szóló 2002/96/EK irányelve szerint az elektromos és elektronikus berendezések többé nem kezelhetők lakossági hulladékként, és az ilyen elektronikus berendezések gyártói kötelesek válnak az ilyen termékek visszavételére azok hasznos élettartama végén. Az MSI betartja a termékvisszavétellel kapcsolatos követelményeket az MSI márkánév alatt az EU-n belül értékesített termékek esetében, azok élettartamának végén. Az ilyen termékeket a legközelebbi gyűjtőhelyre viheti.

ITALIANO

Per proteggere l'ambiente, MSI, da sempre amica della natura, ti ricorda che....

In base alla Direttiva dell'Unione Europea (EU) sullo Smaltimento dei Materiali Elettrici ed Elettronici, Direttiva 2002/96/EC in vigore dal 13 Agosto 2005, prodotti appartenenti alla categoria dei Materiali Elettrici ed Elettronici non possono più essere eliminati come rifiuti municipali: i produttori di detti materiali saranno obbligati a ritirare ogni prodotto alla fine del suo ciclo di vita. MSI si adegnerà a tale Direttiva ritirando tutti i prodotti marchiati MSI che sono stati venduti all'interno dell'Unione Europea alla fine del loro ciclo di vita. È possibile portare i prodotti nel più vicino punto di raccolta.

CONTENTS

Copyright Notice	ii
Trademarks	ii
Revision History	ii
Technical Support	ii
Safety Instructions	iii
FCC-B Radio Frequency Interference Statement	iv
WEEE (Waste Electrical and Electronic Equipment) Statement	v
Chapter 1. Getting Started	1-1
Mainboard Specifications	1-2
Mainboard Layout	1-4
Packing Checklist	1-5
Chapter 2. Hardware Setup	2-1
Quick Components Guide	2-2
CPU (Central Processing Unit)	2-3
Memory	2-6
Power Supply	2-8
Back Panel	2-10
Connectors	2-12
Button	2-19
Slots	2-20
LED Status Indicators	2-25
Chapter 3 BIOS Setup	3-1
Entering Setup	3-2
The Main Menu	3-4
Standard CMOS Features	3-6
Advanced BIOS Features	3-8
Integrated Peripherals	3-11
Power Management Setup	3-13
H/W Monitor	3-16
BIOS Setting Password	3-17
Cell Menu	3-18
USERSETTINGS	3-23
Load Fail-Safe/ Optimized Defaults	3-24
Appendix A Realtek ALC888 Audio	A-1
Installing the Realtek HD Audio Driver	A-2

Software Configuration	A-4
Hardware Setup	A-19
Appendix B NVIDIA RAID	B-1
Introduction	B-2
RAID Configuraiton	B-3
Installing Driver	B-7
NVIDIA RAID Utility Installation	B-8
Using the NVMediaShield Software	B-11
Appendix C JMicron RAID Introduction	C-1
Introduction	C-2
JMicron RAID BIOS Utility	C-3
Installing Driver	C-11
JMicron RAID Configurer	C-13
Appendix D Dual Core Center	D-1
Activating Dual Core Center	D-2
Main	D-3
DOT(Dyanmic OverClocking)	D-5
Clock	D-6
Voltage	D-7
FAN Speed	D-8
Temperature	D-9
User Profile	D-10

Chapter 1

Getting Started

Thank you for choosing the K9N2 SLI Platinum Series (MS-7374 v1.X) ATX mainboard. The K9N2 SLI Platinum Series mainboards are based on **NVIDIA® nForce750a SLI** single chipset for optimal system efficiency. Designed to fit the advanced **AMD®** Phenom/Athlon/Sempron series in Socket AM2/ AM2+, the K9N2 SLI Platinum Series deliver a high performance and professional desktop platform solution.

Mainboard Specifications

Processor Support

- AMD® Phenom/ Athlon/ Sempron series processors in AM2/ AM2+ package
- Supports 4 pin CPU Fan Pin-Header with Fan Speed Control
(For the latest information about CPU, please visit <http://global.msi.com.tw/index.php?func=cpuform>)

Supported FSB

- AM2 CPU supports Hyper Transport 1.0
- AM2+ CPU supports Hyper Transport 3.0

Chipset

- NVIDIA® nForce 750a SLI (MCP 72P) chipset

Memory Support

- DDR2 1066 (for AM2+ CPU only)/ 800/ 667 DRAM (240pin/ 1.8V)
 - 4 DDR2 DIMMs (8GB Max)
- (For more information on compatible components, please visit <http://global.msi.com.tw/index.php?func=testreport>)

LAN

- Supports 10/100/1000 Fast Ethernet by Realtek 8211BL

1394 (optional)

- Transfer rate is up to 400Mbps
- Controlled by VIA VT6308P (optional)

Audio

- Chip integrated by Realtek® ALC888
- Flexible 8-channel audio with jack sensing
- Compliant with Azalia 1.0 spec

IDE

- 2 IDE ports (one by nForce 750a SLI, one by JMB363)
- Supports Ultra DMA 66/100/133 mode
- Supports PIO, Bus Master operation mode

SATA

- 6 SATAII ports by nForce 750a SLI
- 2 ESATA (External-SATA) ports (back panel) by JMB363
- Supports storage and data transfers at up to 3 Gb/s

RAID

- SATA1-6 support RAID 0/ 1/ 0+1/ 5 or JBOD mode
- 2 ESATA (External-SATA) ports support RAID 0/ 1 mode

Floppy

- 1 floppy port
- Supports 1 FDD with 360KB, 720KB, 1.2MB, 1.44MB and 2.88MB

Connectors

● Back panel

- 1 PS/2 mouse port
- 1 PS/2 keyboard port
- 1 1394 port (optional)
- 1 Optical SPDIF-out jack
- 1 DVI-D port
- 1 LAN jack
- 4 USB 2.0 ports
- 2 ESATA ports
- 6 flexible audio jacks

● On-Board Pinheaders

- 3 USB 2.0 pinheaders
- 1 1394 pinheader (optional)
- 1 Front Panel Audio pinheader
- 1 CD-in pinheader
- 1 Serial port pinheader
- 1 TPM Module pinheader (optional)
- 1 SPDIF-out pinheader
- 1 Chassis Intrusion pinheader

TPM (optional)

- Supports TPM

Slots

- 2 PCI Express x16 slots compatible with PCIE 2.0 specification, supports SLI mode
 - a. the **mazarine** PCIE x16 (PCI_E1) slot supports up to PCIE 2.0 x16 speed
 - b. the **blue** PCIE x16 (PCI_E3) slot is a special design that supports up to PCIE 2.0 x8 speed
 - c. if you intend to use **both** PCIE x16 slots, please use them with **graphics cards** in **SLI** mode and these two PCIE x16 lanes will auto arrange from x16/ x0 to x8/ x8
- 1 PCI Express x 1 slot
- 2 PCI slots

Form Factor

- ATX (30.5cm X 24.4 cm)

Mounting

- 9 mounting holes

Mainboard Layout

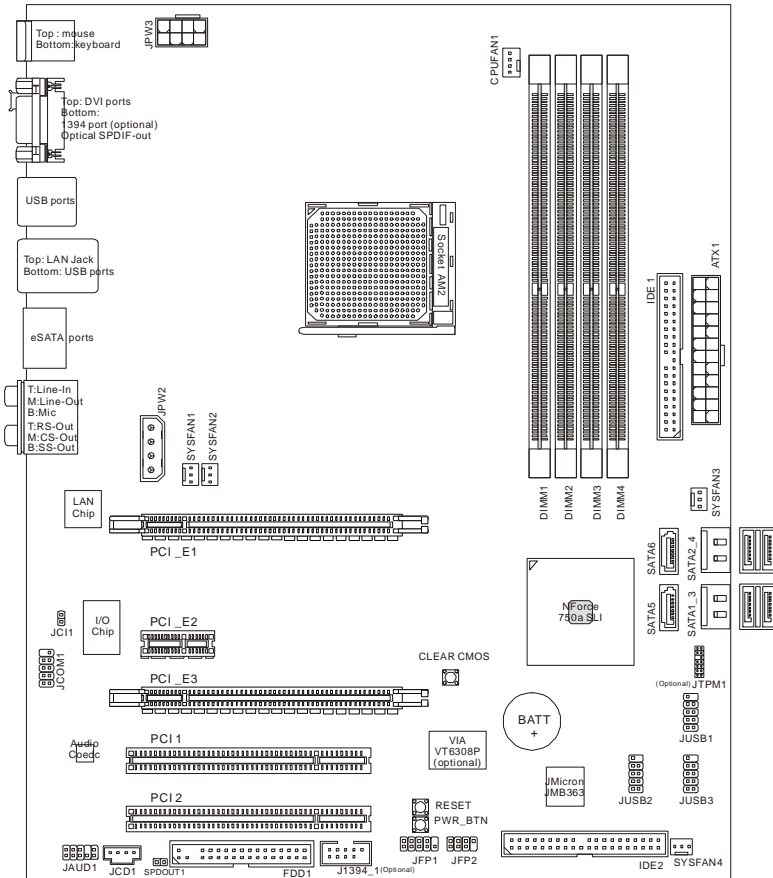

K9N2 SLI Platinum Series (MS-7374 v1.X) ATX Mainboard

Packing Checklist



MSI motherboard

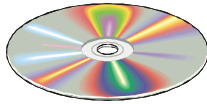

MSI Driver/Utility CD



SLI Video Link Card



Power Cable



SATA Cable



IDE Cable



Floppy Cable



external SATA Cable
(Optional)



1394 Bracket (Optional)



User's Guide



Back IO Shield

* The pictures are for reference only and may vary from the packing contents of the product you purchased.

Chapter 2

Hardware Setup

This chapter provides you with the information about hardware setup procedures. While doing the installation, be careful in holding the components and follow the installation procedures. For some components, if you install in the wrong orientation, the components will not work properly.

Use a grounded wrist strap before handling computer components. Static electricity may damage the components.

Quick Components Guide

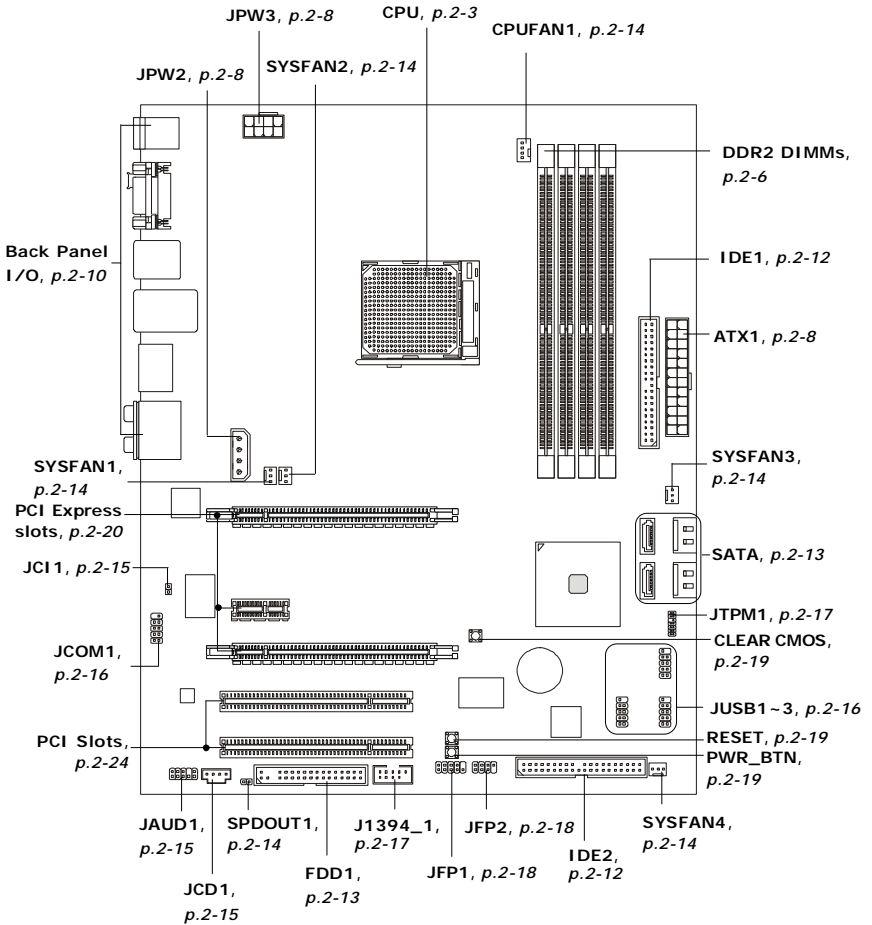

CPU (Central Processing Unit)

The mainboard supports AMD® Phenom/ Athlon/ Sempron processors in Socket AM2/ AM2+. The Socket AM2/ AM2+ offer a easy CPU installation. When you are installing the CPU, **make sure the CPU has a heat sink and a cooling fan attached on the top to prevent overheating.** If you do not have the heat sink and cooling fan, contact your dealer to purchase and install them before turning on the computer.

For the latest information about CPU, please visit <http://global.msi.com.tw/index.php?func=cpuform>



Important

Overheating

Overheating will seriously damage the CPU and system. Always make sure the cooling fan can work properly to protect the CPU from overheating. Make sure that you apply an even layer of thermal paste (or thermal tape) between the CPU and the heatsink to enhance heat dissipation.

Replacing the CPU

While replacing the CPU, always turn off the ATX power supply or unplug the power supply's power cord from the grounded outlet first to ensure the safety of CPU.

Overclocking

*This mainboard is designed to support overclocking. However, please make sure your components are able to tolerate such abnormal setting, while doing overclocking. Any attempt to operate beyond product specifications is not recommended. **We do not guarantee the damages or risks caused by inadequate operation or beyond product specifications.***

CPU Installation Procedures for Socket AM2/ AM2+

1. Please turn off the power and unplug the power cord before installing the CPU.
2. Pull the lever sideways away from the socket. Make sure to raise the lever up to a 90-degree angle.
3. Look for the gold arrow on the CPU. The gold arrow should point as shown in the picture. The CPU can only fit in the correct orientation. Lower the CPU down onto the socket.
4. If the CPU is correctly installed, the pins should be completely embedded into the socket and can not be seen. Please note that any violation of the correct installation procedures may cause permanent damages to your mainboard.
5. Press the CPU down firmly into the socket and close the lever. As the CPU is likely to move while the lever is being closed, always close the lever with your fingers pressing tightly on top of the CPU to make sure the CPU is properly and completely embedded into the socket.

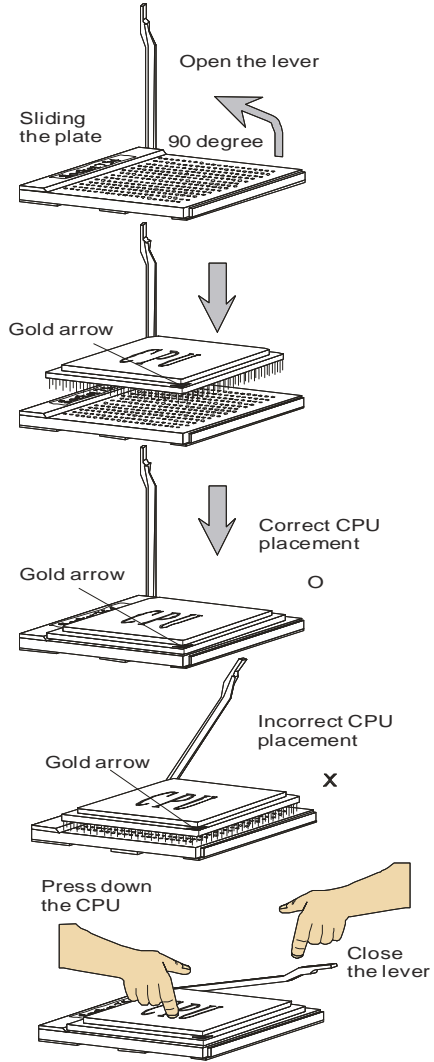

Installing CPU Cooler Set

When you are installing the CPU, **make sure the CPU has a heat sink and a cooling fan attached on the top to prevent overheating.** If you do not have the heat sink and cooling fan, contact your dealer to purchase and install them before turning on the computer.



Important

1. Read the CPU status in BIOS (Chapter 3).
2. Mainboard photos shown in this section are for demonstration of the CPU/ cooler installation only. The appearance of your mainboard may vary depending on the model you purchase.

1. Position the cooling set onto the retention mechanism.

Hook one end of the clip to hook first.

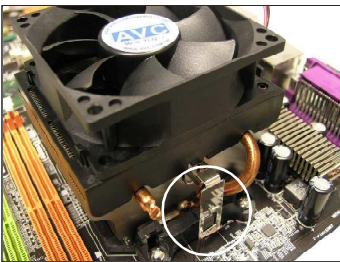

3. Fasten down the lever.

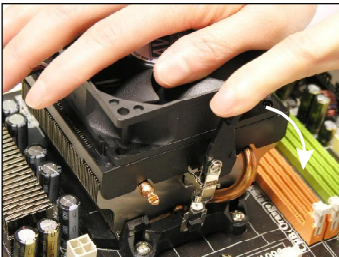

2. Then press down the other end of the clip to fasten the cooling set on the top of the retention mechanism. Locate the Fix Lever and lift it up.

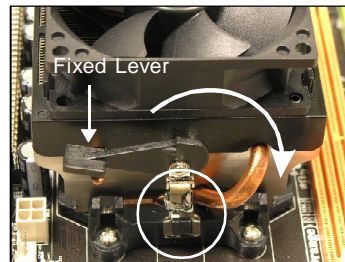

4. Attach the CPU fan cable to the CPU fan connector on the mainboard.

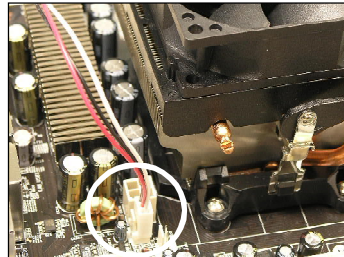

Memory

These DIMM slots are used for installing memory modules.

For more information on compatible components, please visit <http://global.msi.com.tw/index.php?func=testreport>

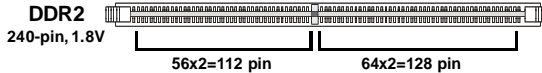

Dual-Channel Memory Population Rules

In Dual-Channel mode, the memory modules can transmit and receive data with two data bus lines simultaneously. Enabling Dual-Channel mode can enhance the system performance. The following illustrations explain the population rules for Dual-Channel mode.

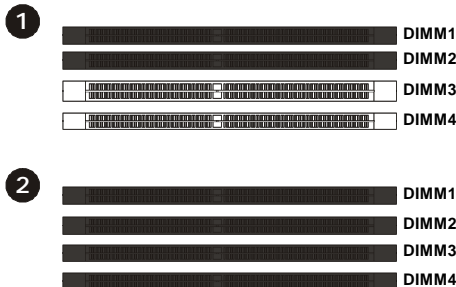

Important

- DDR2 memory modules are not interchangeable with DDR and the DDR2 standard is not backwards compatible. You should always install DDR2 memory modules in the DDR2 DIMM slots.
- In Dual-Channel mode, make sure that you install memory modules of **the same type and density** in different channel DIMM slots.
- To enable successful system boot-up, always insert the memory modules into the **DIMM1 first**.
- Due to the chipset resource deployment, the system density will only be detected up to 7+GB (not full 8GB) when each DIMM is installed with a 2GB memory module.

Installing Memory Modules

1. The memory module has only one notch on the center and will only fit in the right orientation.
2. Insert the memory module vertically into the DIMM slot. Then push it in until the golden finger on the memory module is deeply inserted in the DIMM slot. The plastic clip at each side of the DIMM slot will automatically close when the memory module is properly seated.



Important

You can barely see the golden finger if the module is properly inserted in the DIMM slot.

3. Manually check if the memory module has been locked in place by the DIMM slot clips at the sides.

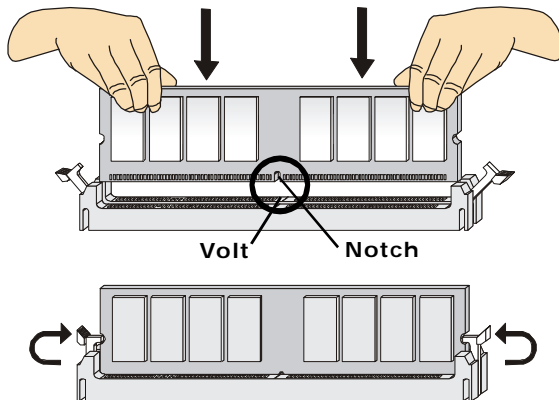

Power Supply

ATX 24-Pin Power Connector: ATX1

This connector allows you to connect an ATX 24-pin power supply. To connect the ATX 24-pin power supply, make sure the plug of the power supply is inserted in the proper orientation and the pins are aligned. Then push down the power supply firmly into the connector.

You may use the 20-pin ATX power supply as you like. If you'd like to use the 20-pin ATX power supply, please plug your power supply along with pin 1 & pin 13 (refer to the image at the right hand). There is also a foolproof design on pin 11, 12, 23 & 24 to avoid wrong installation.



Pin Definition

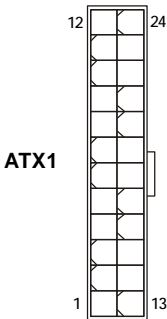

PIN	SIGNAL	PIN	SIGNAL
1	+3.3V	13	+3.3V
2	+3.3V	14	-12V
3	GND	15	GND
4	+5V	16	PS-ON#
5	GND	17	GND
6	+5V	18	GND
7	GND	19	GND
8	PWR OK	20	Res
9	5VSB	21	+5V
10	+12V	22	+5V
11	+12V	23	+5V
12	+3.3V	24	GND

ATX 8-pin/ 4-pin Power Connector: JPW3/ JPW2

This JPW3 power connector is used to provide power to the CPU. This JPW2 power connector is used to provide power to stable the operation of graphics card.

Pin Definition

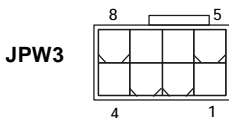

PIN	SIGNAL	PIN	SIGNAL
1	GND	5	+12V
2	GND	6	+12V
3	GND	7	+12V
4	GND	8	+12V

Pin Definition



PIN	SIGNAL
1	5V
2	GND
3	GND
4	12V



Important

1. Make sure that all the connectors are connected to proper ATX power supplies to ensure stable operation of the mainboard.
2. Power supply of 450 watts (and above) is highly recommended for system stability.
3. We recommend you to use the minimum 450 watts power supply to support the needs of SLI technology in the system.

Important Notification about Power Issue

NForce chipset is very sensitive to ESD (Electrostatic Discharge), therefore this issue mostly happens while the users intensively swap memory modules under S5 (power-off) states, and the power code is plugged while installing modules. Due to several pins are very sensitive to ESD, so this kind of memory-replacement actions might cause system chipset unable to boot. Please follow the following solution to avoid this situation.

Unplug the AC power cable (shown in figure 1) or unplug all power connectors on the mainboard (shown in figure 2) before the 1st installation or during system upgrade procedure.

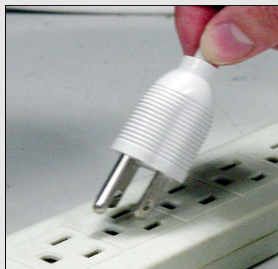

Figure 1:
Unplug the AC power cable

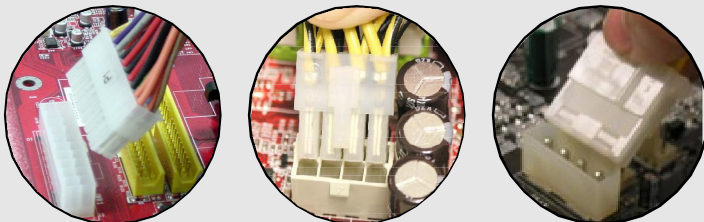
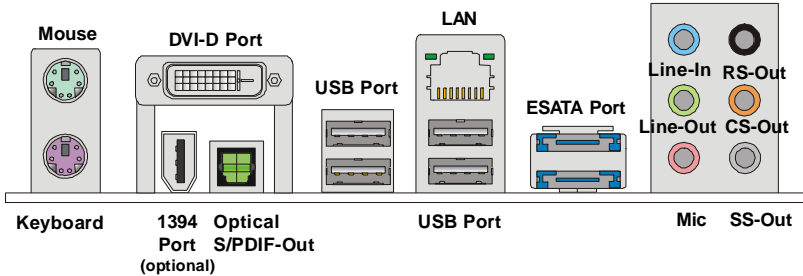

Figure 2: Unplug all the power connectors

Back Panel



► Mouse/Keyboard

The standard PS/2[®] mouse/keyboard DIN connector is for a PS/2[®] mouse/keyboard.

► DVI-D Port

The DVI-D (Digital Visual Interface-Digital) connector allows you to connect a LCD monitor. It provides a high-speed digital interconnection between the computer and its display device. To connect an LCD monitor, simply plug your monitor cable into the DVI-D connector, and make sure that the other end of the cable is properly connected to your monitor (refer to your monitor manual for more information.)

► 1394 Port (optional)

The IEEE1394 port on the back panel provides connection to IEEE1394 devices.

► Optical S/PDIF-Out

This SPDIF (Sony & Philips Digital Interconnect Format) connector is provided for digital audio transmission to external speakers through an optical fiber cable.

► USB Port

The USB (Universal Serial Bus) port is for attaching USB devices such as keyboard, mouse, or other USB-compatible devices.

► LAN

The standard RJ-45 LAN jack is for connection to the Local Area Network (LAN). You can connect a network cable to it.

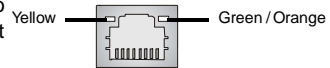

LED	Color	LED State	condition
Left	Orange	Off	LAN link is not established.
		On (steady state)	LAN link is established.
		On (brighter & pulsing)	The computer is communicating with another computer on the LAN.
Right	Green	Off	10 Mbit/sec data rate is selected.
		On	100 Mbit/sec data rate is selected.
	Orange	On	1000 Mbit/sec data rate is selected.

► ESATA Port

This ESATA (External Serial ATA) port is used to connect the external SATA device. You can also use the optional external SATA cable to connect SATA device and ESATA port.

► Audio Ports

These audio connectors are used for audio devices. It is easy to differentiate between audio effects according to the color of audio jacks.

- **Line-In (Blue)** - Line In is used for external CD player, tape-player or other audio devices.
- **Line-Out (Green)** - Line Out, is a connector for speakers or headphones.
- **Mic (Pink)** - Mic, is a connector for microphones.
- **RS-Out (Black)** - Rear-Surround Out in 4/ 5.1/ 7.1 channel mode.
- **CS-Out (Orange)** - Center/ Subwoofer Out in 5.1/ 7.1 channel mode.
- **SS-Out (Gray)** - Side-Surround Out 7.1 channel mode.

Connectors

IDE Connector: IDE1 / IDE2

This connector supports IDE hard disk drives, optical disk drives and other IDE devices.

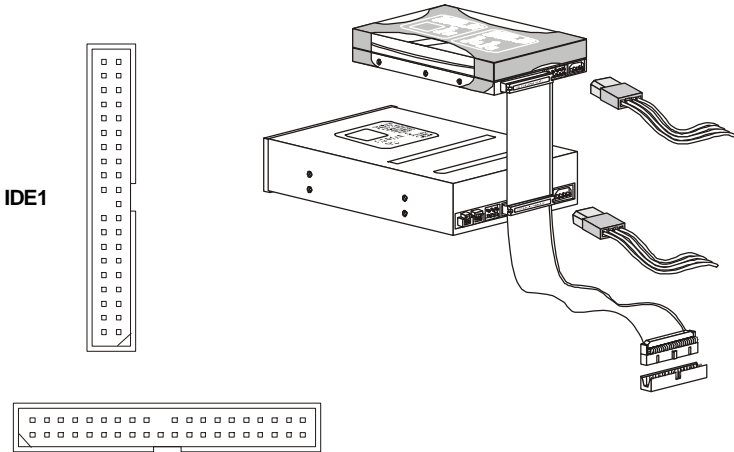

IDE1 (Primary IDE Connector)

The first hard drive should always be connected to IDE1. IDE1 can connect a Master and a Slave drive.

IDE2 (Secondary IDE Connector)

IDE2 can also connect a Master and a Slave drive.



Important

If you install two IDE devices on the same cable, you must configure the drives separately to master / slave mode by setting jumpers. Refer to IDE device's documentation supplied by the vendors for jumper setting instructions.

Floppy Disk Drive Connector: FDD1

This connector supports 360KB, 720KB, 1.2MB, 1.44MB or 2.88MB floppy disk drive.

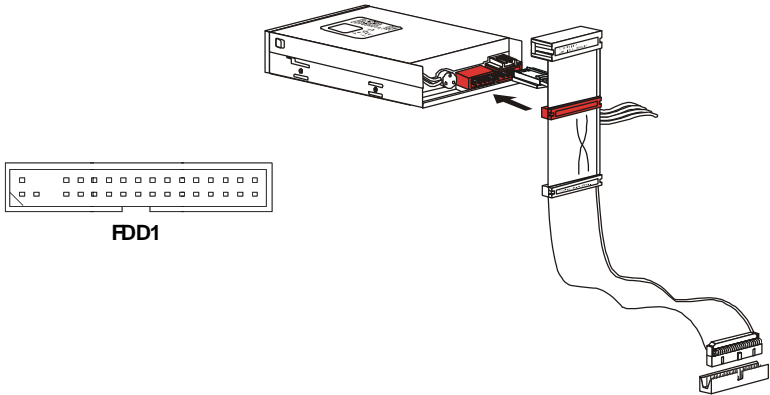

Serial ATA Connector: SATA1~6

This connector is a high-speed Serial ATA interface port. Each connector can connect to one Serial ATA device.

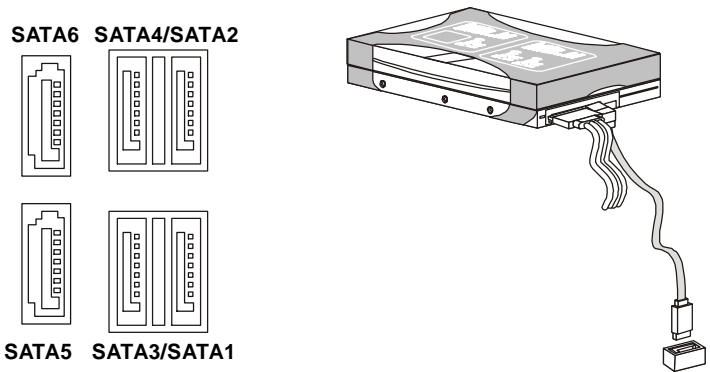

Important

1. Please do not fold the Serial ATA cable into 90-degree angle. Otherwise, data loss may occur during transmission.
2. SATA5 & SATA 6 support AHCI mode and RAID mode only.

Fan Power Connectors: CPUFAN1, SYSFAN1/ 2/ 3/ 4

The fan power connectors support system cooling fan with +12V. When connecting the wire to the connectors, always note that the red wire is the positive and should be connected to the +12V; the black wire is Ground and should be connected to GND. If the mainboard has a System Hardware Monitor chipset on-board, you must use a specially designed fan with speed sensor to take advantage of the CPU fan control.

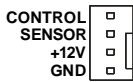

CPUFAN1

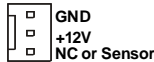

SYSFAN1/2/3



SYSFAN4



Important

1. Please refer to the recommended CPU fans at processor's official website or consult the vendors for proper CPU cooling fan.
2. CPUFAN1 supports fan control. You can install **Dual Core Center** utility that will automatically control the CPU fan speed according to the actual CPU temperature.
3. Fan/heatsink with 3 or 4 pins are both available for CPUFAN1.

SPDIF-Out Connector: SPDOUT1 (optional, for HDMI graphics card only)

This connector is used to connect S/PDIF (Sony & Philips Digital Interconnect Format) interface for digital audio transmission **to the HDMI graphics card**.



SPDOUT1

Front Panel Audio Connector: JAUD1

This connector allows you to connect the front panel audio and is compliant with Intel® Front Panel I/O Connectivity Design Guide.



JAUD1

HD Audio Pin Definition

PIN	SIGNAL	DESCRIPTION
1	MIC_L	Microphone - Left channel
2	GND	Ground
3	MIC_R	Microphone - Right channel
4	NC	
5	LINE out_R	Analog Port - Right channel
6	MIC_JD	Jack detection return from front panel microphone JACK1
7	Front_JD	Jack detection sense line from the High Definition Audio CODEC jack detection resistor network
8	NC	No control
9	LINE out_L	Analog Port - Left channel
10	LINEout_JD	Jack detection return from front panel JACK2

Chassis Intrusion Connector: JCI1

This connector connects to the chassis intrusion switch cable. If the chassis is opened, the chassis intrusion mechanism will be activated. The system will record this status and show a warning message on the screen. To clear the warning, you must enter the BIOS utility and clear the record.



JCI1

CD-In Connector: JCD1

This connector is provided for external audio input.

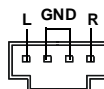

JCD1

Front USB Connector: JUSB1/ JUSB2/ JUSB3

This connector, compliant with Intel® I/O Connectivity Design Guide, is ideal for connecting high-speed USB interface peripherals such as **USB HDD, digital cameras, MP3 players, printers, modems and the like.**



JUSB1 / 2 / 3

Pin Definition

PIN	SIGNAL	PIN	SIGNAL
1	VCC	2	VCC
3	USB0-	4	USB1-
5	USB0+	6	USB1+
7	GND	8	GND
9	Key (no pin)	10	NC

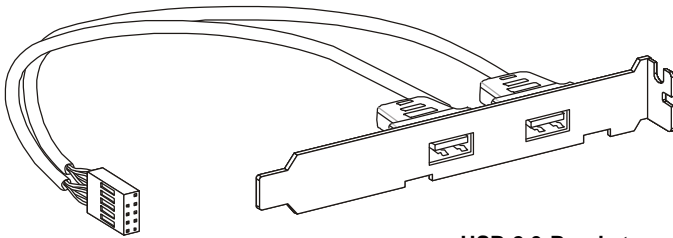

USB 2.0 Bracket
(optional)



Important

Note that the pins of VCC and GND must be connected correctly to avoid possible damage.

Serial Port Connector: JCOM1

This connector is a 16550A high speed communication port that sends/receives 16 bytes FIFOs. You can attach a serial device.

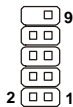

JCOM1

Pin Definition

PIN	SIGNAL	DESCRIPTION
1	DCD	Data Carry Detect
2	SIN	Serial In or Receive Data
3	SOUT	Serial Out or Transmit Data
4	DTR	Data Terminal Ready
5	GND	Ground
6	DSR	Data Set Ready
7	RTS	Request To Send
8	CTS	Clear To Send
9	RI	Ring Indicate

IEEE1394 Connector: J1394_1 (optional)

This connector allows you to connect the IEEE1394 device via an optional IEEE1394 bracket.

Pin Definition

PIN	SIGNAL	PIN	SIGNAL
1	TPA+	2	TPA-
3	Ground	4	Ground
5	TPB+	6	TPB-
7	Cablepower	8	Cablepower
9	Key (no pin)	10	Ground



J1394_1

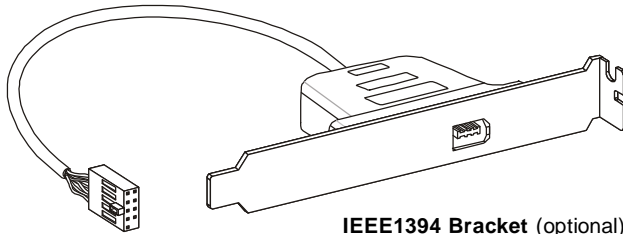

IEEE1394 Bracket (optional)

TPM Module Connector: JTPM1 (optional)

This connector connects to a TPM (Trusted Platform Module) module (optional). Please refer to the TPM security platform manual for more details and usages.

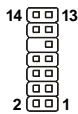

JTPM1

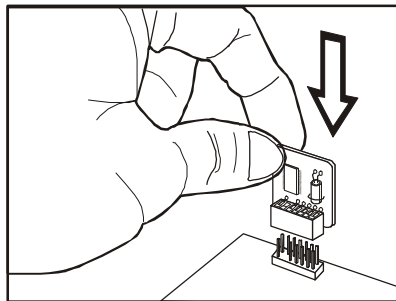

Pin	Signal	Description	Pin	Signal	Description
1	LCLK	LPC clock	2	3V_STB	3V standby power
3	LRST#	LPC reset	4	VCC3	3.3V power
5	LAD0	LPC address & data pin0	6	SIRQ	Serial IRQ
7	LAD1	LPC address & data pin1	8	VCC5	5V power
9	LAD2	LPC address & data pin2	10	KEY	No pin
11	LAD3	LPC address & data pin3	12	GND	Ground
13	LFRAME#	LPC Frame	14	GND	Ground

Front Panel Connectors: JFP1, JFP2

These connectors are for electrical connection to the front panel switches and LEDs. The JFP1 is compliant with Intel® Front Panel I/O Connectivity Design Guide.

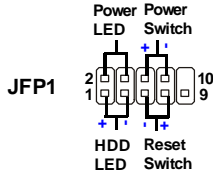

JFP1 Pin Definition

PIN	SIGNAL	DESCRIPTION
1	HD_LED +	Hard disk LED pull-up
2	FPPWR/SLP	MSG LED pull-up
3	HD_LED -	Hard disk active LED
4	FPPWR/SLP	MSG LED pull-up
5	RST_SW -	Reset Switch low reference pull-down to GND
6	PWR_SW +	Power Switch high reference pull-up
7	RST_SW +	Reset Switch high reference pull-up
8	PWR_SW-	Power Switch low reference pull-down to GND
9	RSVD_DNU	Reserved. Do not use.

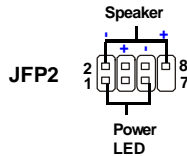

JFP2 Pin Definition

PIN	SIGNAL	DESCRIPTION
1	GND	Ground
2	SPK-	Speaker-
3	SLED	Suspend LED
4	BUZ+	Buzzer+
5	PLED	Power LED
6	BUZ-	Buzzer-
7	NC	No connection
8	SPK+	Speaker+

Button

This mainboard provides the following buttons for you to set the computer's function. This section will explain how to change your mainboard's function through the use of buttons.

Clear CMOS Button: CLEAR CMOS

There is a CMOS RAM on board that has a power supply from external battery to keep the system configuration data. With the CMOS RAM, the system can automatically boot OS every time it is turned on. If you want to clear the system configuration, use the button to clear data. Press the button to clear the data.



CLEAR CMOS



Important

Make sure that you power off the system before clearing CMOS data.

Reset Button: RESET

This reset button is used to reset the system. Press the button to reset the system.



RESET

Power Button: PWR_BTN

This power button is used to turn-on or turn-off the system. Press the button to turn-on or turn-off the system.



PWR_BTN

Slots

PCI (Peripheral Component Interconnect) Express Slots

The PCI Express slot supports the PCI Express interface expansion card.

The PCI Express 2.0 x 16 supports up to 8.0 GB/s transfer rate.

The PCI Express 2.0 x 8 supports up to 4.0 GB/s transfer rate.

The PCI Express x 1 supports up to 250 MB/s transfer rate.

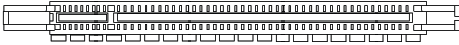

**Mazarine PCI Express x16 Slot supports up to
PCI Express 2.0x 16 speed (PCI_E1)**

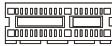

PCI Express x 1 Slot (PCI_E2)

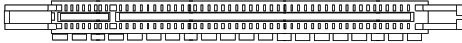

**Blue PCI Express x 16 Slot supports up to
PCI Express 2.0 x 8 speed (PCI_E3)**



Important

When adding or removing expansion cards, make sure that you unplug the power supply first. Meanwhile, read the documentation for the expansion card to configure any necessary hardware or software settings for the expansion card, such as jumpers, switches or BIOS configuration.

NV SLI Technology

NVIDIA SLI (Scalable Link Interface) technology allows two GPUs to run in tandem within a system to achieve up to twice the performance of a single graphics card. To utilize this technology, the two GPU cards must be connected by an *SLI Video Link card*.



SLI Video Link Card

If you intend to use the SLI mode for better graphics performance, please refer to the following instructions.

1. Install two graphics cards on PCI Express x16 slots. With two cards installed, an SLI Video Link Card is required to connect the golden fingers on the top of these two graphics cards (refer to the picture below). Please note that although you have installed two graphics cards, only the video outputs on the first card will work. Hence, you only need to connect a monitor to the first PCI Express card.

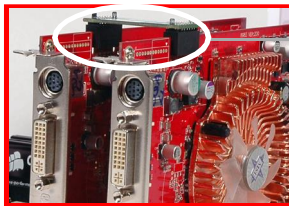

SLI Video Link Card



Important

1. The photos shown in this section are for demonstration only. The appearance of your mainboard may vary depending on the model you purchase.
2. If you intend to install **TWO** x16 graphics cards, make sure that these two graphics cards are of the same brand and specifications.
3. Make sure that you connect an adequate power supply to the JPW2 connector (or to the power connector on the graphics card) to ensure stable operation of the graphics card.
4. If you intend to install only **ONE** graphics card, make sure that the graphics card is installed on the **mazarine** PCIe x16 (PCI_E1) slot.

- After the hardware installation is completed, restart the system and install the NV SLI driver/utility. A configuration panel will be provided for SLI control. Select the **Enable SLI technology (recommended)** item to enable the SLI function for the onboard graphics cards (concerning the details of SLI settings, please refer to your graphics card manual) .

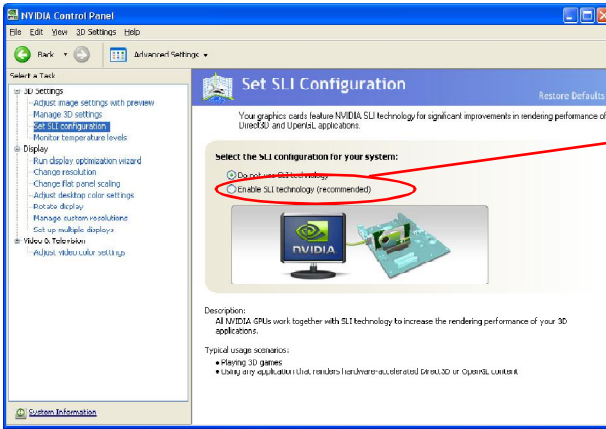

Select "Enable SLI technology (recommended)"

- Restart your system and a pop-up message will show in the system tray confirming the **SLI has been enabled**.



Important

If you want to remove one graphics card and quit the SLI function, make sure the "SLI" function is disabled.

NVIDIA Hybrid SLI Technology

Hybrid SLI technology, based on NVIDIA's industry-leading SLI technology, delivers multi-GPU benefits when an NVIDIA mainboard GPU is combined with an NVIDIA discrete GPU.

Enabling Hybrid SLI Technology

Power off the system and install the NVIDIA SLI graphic card that supports Hybrid SLI technology. After then, power on the system and install the "NVIDIA hSLI Driver" which supports **Windows Vista** only. Restart the system and wait for the Hybrid Icon to show in the system tray. The hybrid icon indicates that the system is in Performance mode and that GeForce Boost is enabled. The chipset will share the rendering load with the graphic card and boost the performance of the graphic card.



Click on the Hybrid Icon in the System tray can select the Hybrid mode. The Hybrid modes are listed below.

Hybrid-Performance Mode - The hybrid mode where the discrete GPU (dGPU) and mainboard GPU (mGPU) are simultaneously active and working collaboratively to provide higher performance (GeForce Boost)

Hybrid-Power Mode - The hybrid mode where the dGPU completely shut off and mGPU renders and drives the display (HybridPower).



Important

1. Please note that although you have installed the graphics card in the PCI Express slot, only the onboard video outputs (which be embedded in back panel of mainboard) will work. Hence, you only need to connect a monitor to the onboard video output.
2. Be sure to set **[Internal]** in "**Primary Graphic's Adapter**" of Advanced BIOS Features in BIOS.
3. We suggest that you have to select **256MB or higher** for "**VGA Share Memory Size**" in BIOS.

PCI (Peripheral Component Interconnect) Slots

The PCI slots support LAN cards, SCSI cards, USB cards, and other add-on cards that comply with PCI specifications. At 32 bits and 33 MHz, it yields a throughput rate of 133 MBps.

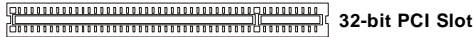

PCI Interrupt Request Routing

The IRQ, acronym of interrupt request line and pronounced I-R-Q, are hardware lines over which devices can send interrupt signals to the microprocessor. The PCI IRQ pins are typically connected to the PCI bus pins as follows:

	Order 1	Order 2	Order 3	Order 4
PCI Slot 1	INTW#	INT X#	INT Y#	INT Z#
PCI Slot 2	INT X#	INT Y#	INT Z#	INTW#



Important

When adding or removing expansion cards, make sure that you unplug the power supply first. Meanwhile, read the documentation for the expansion card to configure any necessary hardware or software settings for the expansion card, such as jumpers, switches or BIOS configuration.

LED Status Indicators

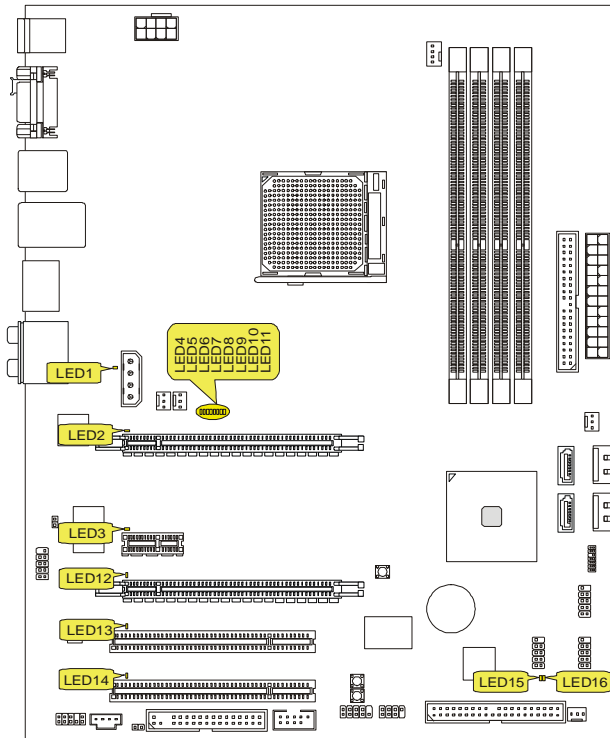

Name	Status
LED1	Lights when the 12V power conn. is not connected.
LED2	Lights when PCI_E1 slot is functional.
LED3	Lights when PCI_E2 slot is functional.
LED12	Lights when PCI_E3 slot is functional.
LED13	Lights when PCI1 slot is functional.
LED14	Lights when PCI2 slot is functional.
LED15	Lights when system is power-on.
LED16	Lights when system is on standby mode.

LED 4, 5, 6, 7, 8, 9, 10, 11

These four LEDs allow users to identify system problems through 16 various combinations of LED signals.

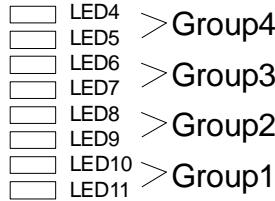

Red Green

LED Signal	Description	LED Signal	Description
Group4 Group3 Group2 Group1	System Power ON The D-LED will hang here if the processor is damaged or not installed properly.	<input type="checkbox"/> Group4 Group3 Group2 Group1	Initializing Video Interface This will start detecting CPU clock, checking type of video onboard. Then, detect and initialize the video adapter.
Group4 Group3 Group2 <input type="checkbox"/> Group1	Early Chipset Initialization	<input type="checkbox"/> Group4 Group3 Group2 <input type="checkbox"/> Group1	BIOS Sign On This will start showing information about logo, processor brand name, etc...
Group4 Group3 <input type="checkbox"/> Group2 Group1	Memory Detection Test Testing onboard memory size. The D-LED will hang if the memory module is damaged or not installed properly.	<input type="checkbox"/> Group4 Group3 Group2 Group1	Testing Base and Extended Memory Testing base memory from 240K to 640K and extended memory above 1MB using various patterns.
Group4 Group3 <input type="checkbox"/> Group2 <input type="checkbox"/> Group1	Decompressing BIOS image to RAM for fast booting.	<input type="checkbox"/> Group4 Group3 <input type="checkbox"/> Group2 <input type="checkbox"/> Group1	Assign Resources to all ISA.
Group4 <input type="checkbox"/> Group3 Group2 Group1	Initializing Keyboard Controller.	<input type="checkbox"/> Group4 Group3 Group2 Group1	Initializing Hard Drive Controller This will initialize IDE drive and controller.
Group4 <input type="checkbox"/> Group3 Group2 <input type="checkbox"/> Group1	Testing VGA BIOS This will start writing VGA sign-on message to the screen.	<input type="checkbox"/> Group4 <input type="checkbox"/> Group3 Group2 <input type="checkbox"/> Group1	Initializing Floppy Drive Controller This will initialize Floppy Drive and controller.
Group4 <input type="checkbox"/> Group3 <input type="checkbox"/> Group2 Group1	Processor Initialization This will show information regarding the processor (like brand name, system bus, etc...)	<input type="checkbox"/> Group4 <input type="checkbox"/> Group3 <input type="checkbox"/> Group2 Group1	Boot Attempt This will set low stack and boot via INT 19h.
Group4 <input type="checkbox"/> Group3 <input type="checkbox"/> Group2 <input type="checkbox"/> Group1	Testing RTC (Real Time Clock)	<input type="checkbox"/> Group4 <input type="checkbox"/> Group3 <input type="checkbox"/> Group2 <input type="checkbox"/> Group1	Operating System Booting

Chapter 3

BIOS Setup

This chapter provides information on the BIOS Setup program and allows you to configure the system for optimum use.

You may need to run the Setup program when:

- ≈ An error message appears on the screen during the system booting up, and requests you to run SETUP.
- ≈ You want to change the default settings for customized features.

Entering Setup

Power on the computer and the system will start POST (Power On Self Test) process. When the message below appears on the screen, press key to enter Setup.

Press DEL to enter SETUP

If the message disappears before you respond and you still wish to enter Setup, restart the system by turning it OFF and On or pressing the RESET button. You may also restart the system by simultaneously pressing <Ctrl>, <Alt>, and <Delete> keys.



Important

1. The items under each BIOS category described in this chapter are under continuous update for better system performance. Therefore, the description may be slightly different from the latest BIOS and should be held for reference only.
2. Upon boot-up, the 1st line appearing after the memory count is the BIOS version. It is usually in the format:

A7374NMS V1.0 021308 where:

1st digit refers to BIOS maker as A = AMI, W = AWARD, and P = PHOENIX.

2nd - 5th digit refers to the model number.

6th digit refers to the chipset as I = Intel, N = nVidia, and V = VIA.

7th - 8th digit refers to the customer as MS = all standard customers.

V1.0 refers to the BIOS version.

021308 refers to the date this BIOS was released.

Control Keys

<↑>	Move to the previous item
<↓>	Move to the next item
<←>	Move to the item in the left hand
<→>	Move to the item in the right hand
<Enter>	Select the item
<Esc>	Jumps to the Exit menu or returns to the main menu from a submenu
<+/PU>	Increase the numeric value or make changes
<-/PD>	Decrease the numeric value or make changes
<F1>	General Help
<F6>	Load Optimized Defaults
<F7>	Load Fail-Safe Defaults
<F10>	Save all the CMOS changes and exit

Getting Help

After entering the Setup menu, the first menu you will see is the Main Menu.

Main Menu

The main menu lists the setup functions you can make changes to. You can use the arrow keys (↑↓) to select the item. The on-line description of the highlighted setup function is displayed at the bottom of the screen.

Sub-Menu

If you find a right pointer symbol (as shown in the right view) appears to the left of certain fields that means a sub-menu can be launched from this field. A sub-menu contains additional options for a field parameter. You can use arrow keys (↑↓) to highlight the field and press <Enter> to call up the sub-menu. Then you can use the control keys to enter values and move from field to field within a sub-menu. If you want to return to the main menu, just press the <Esc >.

▶ IDE Primary Master
▶ IDE Primary Slave

General Help <F1>

The BIOS setup program provides a General Help screen. You can call up this screen from any menu by simply pressing <F1>. The Help screen lists the appropriate keys to use and the possible selections for the highlighted item. Press <Esc> to exit the Help screen.

The Main Menu



► Standard CMOS Features

Use this menu for basic system configurations, such as time, date etc.

► Advanced BIOS Features

Use this menu to setup the items of AMI® special enhanced features.

► Integrated Peripherals

Use this menu to specify your settings for integrated peripherals.

► Power Management Setup

Use this menu to specify your settings for power management.

► H/W Monitor

This entry shows your PC health status.

► BIOS Setting Password

Use this menu to set the password for BIOS.

► Cell Menu

Use this menu to specify your settings for frequency/voltage control and overlocking.

► USER SETTINGS

Use this menu to save or load settings.

► Load Fail-Safe Defaults

Use this menu to load the default values set by the BIOS vendor for stable system performance.

► Load Optimized Defaults

Use this menu to load the default values set by the mainboard manufacturer specifically for optimal performance of the mainboard.

► Save & Exit Setup

Save changes to CMOS and exit setup.

► Exit Without Saving

Abandon all changes and exit setup.

Standard CMOS Features

The items in Standard CMOS Features Menu includes some basic setup items. Use the arrow keys to highlight the item and then use the <PgUp> or <PgDn> keys to select the value you want in each item.

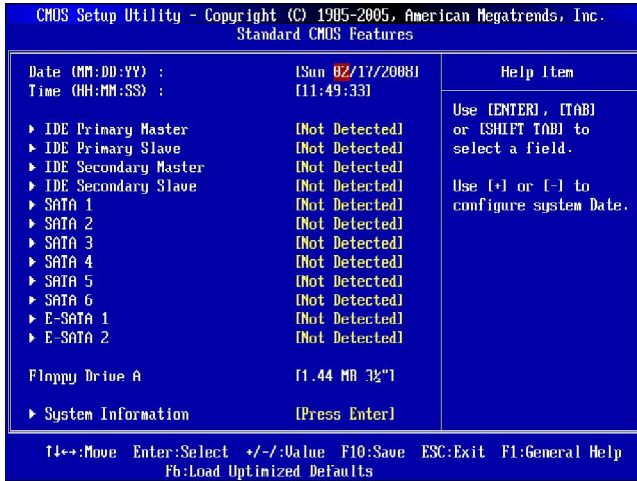

▶ Date (MM:DD:YY)

This allows you to set the system to the date that you want (usually the current date). The format is <day><month> <date> <year>.

- day** Day of the week, from Sun to Sat, determined by BIOS. Read-only.
- month** The month from Jan. to Dec.
- date** The date from 1 to 31 can be keyed by numeric function keys.
- year** The year can be adjusted by users.

▶ Time (HH:MM:SS)

This allows you to set the system time that you want (usually the current time). The time format is <hour> <minute> <second>.

▶ IDE Primary/Secondary Master/ Slave & SATA 1-6 & E-SATA1/2

Press <Enter> to enter the sub-menu, and the following screen appears.

▶ Device/ Vender/ Size

It will showing the device information that you connected to the IDE / SATA / E-SATA connectors .

► **LBA/Large Mode**

This allows you to enable or disable the LBA Mode. Setting to Auto enables LBA mode if the device supports it and the devices is not already formatted with LBA mode disabled.

► **DMA Mode**

Select DMA Mode.

► **Hard Disk S.M.A.R.T.**

This allows you to activate the S.M.A.R.T. (Self-Monitoring Analysis & Reporting Technology) capability for the hard disks. S.M.A.R.T. is a utility that monitors your disk status to predict hard disk failure. This gives you an opportunity to move data from a hard disk that is going to fail to a safe place before the hard disk becomes offline.



Important

IDE Primary/Secondary Master/Slave, SATA1~6 & E-SATA1/2 are appearing when you connect the HD devices to the IDE/ SATA/ E-SATA connector on the mainboard.

► **Floppy Drive A**

This item allows you to set the type of floppy drives installed. Available options: [None], [360K, 5.25 in.], [1.2M, 5.25 in.], [720K, 3.5 in.], [1.44M, 3.5 in.], [2.88M, 3.5 in.].

► **System Information**

Press <Enter> to enter the sub-menu, and the following screen appears.

CMOS Setup Utility - Copyright (C) 1995-2005, American Megatrends, Inc.	
System Information	
** System Information **	Help Item
AMD Athlon(TM) 64 X2 Dual Core Processor 4200+	
CPU ID 0FD2h	
CPU Frequency 2211MHz	
BIOS Version 01.0B7 01222008	
Physical Memory 1024MB	
Cache Size 1024KB	

This sub-menu shows the CPU information, BIOS version and memory status of your system (read only).

Advanced BIOS Features

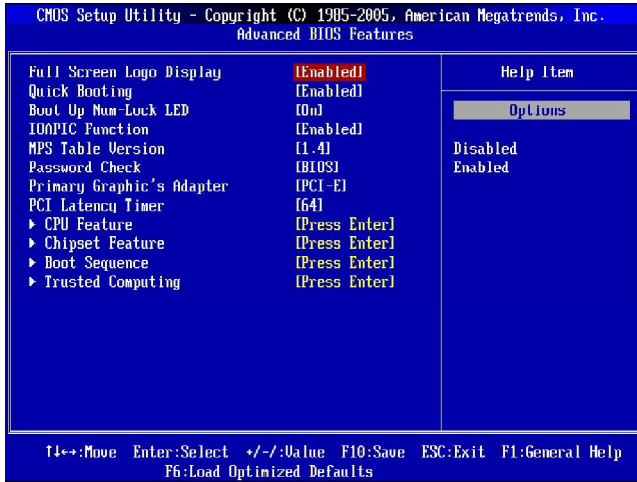

▶ Full Screen Logo Display

This item enables you to show the company logo on the bootup screen. Settings are:

- [Enabled] Shows a still image (logo) on the full screen at boot.
- [Disabled] Shows the POST messages at boot.

▶ Quick Booting

Setting the item to [Enabled] allows the system to boot within 10 seconds since it will skip some check items.

▶ Boot Up Num-Lock LED

This setting is to set the Num Lock status when the system is powered on. Setting to [On] will turn on the Num Lock key when the system is powered on. Setting to [Off] will allow users to use the arrow keys on the numeric keypad.

▶ IOAPIC Function

This field is used to enable or disable the APIC (Advanced Programmable Interrupt Controller). Due to compliance with PC2001 design guide, the system is able to run in APIC mode. Enabling APIC mode will expand available IRQ resources for the system.

▶ MPS Table Version

This field allows you to select which MPS (Multi-Processor Specification) version to be used for the operating system. You need to select the MPS version supported by your operating system. To find out which version to use, consult the vendor of your operating system.

► **Password Check**

After you set the password in BIOS Setting Password menu, this item will appear. Selecting [setup] will request the password when enter the BIOS setup menu. Selecting [always] will request the password when enter both the operating system and the BIOS setup menu.

► **Primary Graphic's Adapter**

This setting specifies which graphic card is your primary graphics adapter.

► **PCI Latency Timer**

This item controls how long each PCI device can hold the bus before another takes over. When set to higher values, every PCI device can conduct transactions for a longer time and thus improve the effective PCI bandwidth. For better PCI performance, you should set the item to higher values.

► **CPU Feature**

Press <Enter> to enter the sub-menu and the following screen appears:



► **SVM Support (for AM2+ CPU only)**

This item is used to enable or disable the AMD SVM (Secure Virtual Machine) mode.

► **Chipset Feature**

Press <Enter> to enter the sub-menu and the following screen appears:



► **HPET**

The HPET (High Precision Event Timers) is a component that is part of the chipset. You can to enable it, and will provide you with the means to get to it via the various ACPI methods.

► **On-Chip VGA**

This item is used to enable or disable the on-chip VGA.

► **VGA Share Memory Size**

The system shares memory to the on-chip VGA. This setting controls the exact memory size shared to the on-chip VGA.

MS-7374 Mainboard

► Boot Sequence

Press <Enter> to enter the sub-menu and the following screen appears:

CMOS Setup Utility - Copyright (C) 1985-2005, American Megatrends, Inc.		
Boot Sequence		
		Help Item
1st Boot Device	[1st: FLUPPY DR1]	
2nd Boot Device	[HDD:PM-UDC UD4]	
3rd Boot Device	[SATA:3S-3T3160]	
Boot From Other Device	[Yes]	Specifies the boot sequence from the available devices.

► 1st/ 2nd/ 3rd Boot Device

The items allow you to set the first/ second/ third boot device where BIOS attempts to load the disk operating system.

► Boot From Other Device

Setting the option to [Yes] allows the system to try to boot from other device. If the system fails to boot from the 1st/ 2nd/ 3rd boot device.

► Trusted Computing

Press <Enter> to enter the sub-menu and the following screen appears

CMOS Setup Utility - Copyright (C) 1985-2005, American Megatrends, Inc.		
Trusted Computing		
Trusted Computing		Help Item
TCG/TPM Support	[Yes]	Enable/Disable TPM TCG (TPM 1.1/1.2) supp in BIOS
Execute TPM Command	[Don't change]	
Clearing the TPM	[Press Enter]	
TPM Enable/Disable Status	[Enabled]	
TPM Owner Status	[UnOwned]	

► TCG/TPM SUPPORT

This field is used to enable or disable TPM (Trusted Platform Module).

► Execute TPM Command

Setting the option to [Enable] enable the system to execute TPM Command.

► Clearing the TPM

Press Enter to clear the TPM status.

► TPM Enable/Disable status, TPM Owner Status

These items show the status of TPM (read only).

Integrated Peripherals

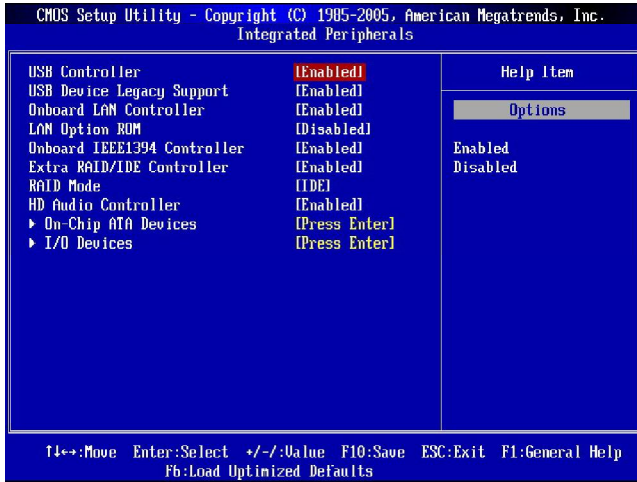

▶ USB Controller

This setting allows you to enable/disable the onboard USB controller.

▶ USB Device Legacy Support

Select [Enabled] if you need to use a USB-interfaced device in the operating system.

▶ Onboard LAN Controller

This item is used to enable/disable the onboard LAN controller.

▶ LAN Option ROM

This item is used to decide whether to invoke the Boot ROM of the LAN controller.

▶ Onboard IEEE1394 Controller

This item allows you to enable/disable the onboard IEEE1394 controller.

▶ Extra RAID/IDE Controller (for JMicron RAID)

This item allows you to enable/disable the extra RAID/IDE JMB363 controller (IDE2, E-SATA1 and E-SATA2).

▶ RAID Mode

This item allows you to select the RAID function for extra RAID/IDE controller. Select [RAID] will enable RAID.

▶ HD Audio Controller

This item allows you to enable/disable the onboard HD audio controller.

► **On-Chip ATA Devices**

Press <Enter> to enter the sub-menu and the following screen appears:



The screenshot shows the BIOS 'On-Chip ATA Devices' menu. The title bar reads 'CMOS Setup Utility - Copyright (C) 1995-2005, American Megatrends, Inc. On-Chip ATA Devices'. The main area is a table with four rows and two columns. The first three rows list the controller settings, and the fourth row is a help item.

CMOS Setup Utility - Copyright (C) 1995-2005, American Megatrends, Inc.	
On-Chip ATA Devices	
On-Chip IDE Controller	[Enabled]
PCI IDE BusMaster	[Disabled]
On-Chip SATA Controller	[Enabled]
RAID mode	[IDE]
	Help Item
	DISABLED: disables the integrated IDE Controller.

► **On-Chip IDE Controller**

This item allows you to enable/ disable the IDE controller.

► **PCI IDE BusMaster**

This item allows you to enable/ disable BIOS to used PCI busmastering for reading/ writing to IDE drives.

► **On-Chip SATA Controller**

This item allows you to enable/ disable the SATA controller.

► **RAID mode**

Setting this option to [RAID] activates the following fields, and use the following fields to enable RAID for SATA hard disks.

► **SATA 1/2/3/4/5/6**

These items are used to enable RAID for SATA 1/2/3/4/5/6.

► **I/O Devices**

Press <Enter> to enter the sub-menu and the following screen appears:



The screenshot shows the BIOS 'I/O Devices' menu. The title bar reads 'CMOS Setup Utility - Copyright (C) 1995-2005, American Megatrends, Inc. I/O Devices'. The main area is a table with one row and two columns.

CMOS Setup Utility - Copyright (C) 1995-2005, American Megatrends, Inc.	
I/O Devices	
COM Port 1	[3F8/IRQ4]
	Help Item

► **COM Port 1**

Select an address and corresponding interrupt for the first serial port.

Power Management Setup



Important

S3-related functions described in this section are available only when your BIOS supports S3 sleep mode.

▶ ACPI Function

This item is to activate the ACPI (Advanced Configuration and Power Management Interface) Function. If your operating system is ACPI-aware, such as Windows 2000/XP, select [Enabled].

▶ ACPI Standby State

This item specifies the power saving modes for ACPI function. If your operating system supports ACPI, such as Windows 2000/XP, you can choose to enter the Standby mode in S1(POS) or S3(STR) fashion through the setting of this field. Settings are:

- [S1] The S1 sleep mode is a low power state. In this state, no system context is lost (CPU or chipset) and hardware maintains all system context.
- [S3] The S3 sleep mode is a lower power state where the information of system configuration and open applications/files is saved to main memory that remains powered while most other hardware components turn off to save energy. The information stored in memory will be used to restore the system when a "wake up" event occurs.

► **Re-call VGA BIOS From S3**

When **ACPI Standby State** is set to [S3], users can select the options in this field. Selecting [Yes] allows BIOS to call VGABIOS to initialize the VGA card when system wakes up (resumes) from S3 sleep state. The system resume time is shortened when you disable the function, but system will need an VGA driver to initialize the VGA card. Therefore, if the VGA driver of the card does not support the initialization feature, the display may work abnormally or not function after resuming from S3.

► **Power Button Function**

This feature sets the function of the power button. Settings are:

- [Power On/Off] The power button functions as normal power on/ off button.
- [Suspend] When you press the power button, the computer enters the suspend/sleep mode, but if the button is pressed for more than four seconds, the computer is turned off.

► **Restore On AC Power Loss**

This item specifies whether your system will reboot after a power failure or interrupt occurs. Settings are:

- [Off] Always leaves the computer in the power off state.
- [On] Always leaves the computer in the power on state.
- [Last State] Restores the system to the status before power failure or interrupt occurred.

► **Wake Up Event Setup**

Press <Enter> and the following sub-menu appears.



► **Wake Up Event By**

Setting to [BIOS] activates the following fields, and use the following fields to set the wake up events. Setting to [OS], the wake up events will be defined by OS.

► **Resume From S3 By USB Device**

The item allows the activity of the USB device to wake up the system from S3 (Suspend to RAM) sleep state.

► **Resume From S3 By PS/2 Keyboard**

This setting determines whether the system will be awakened from what power saving modes when input signal of the PS/2 keyboard is detected.

▶ **Resume From S3 By PS/2 Mouse**

This setting determines whether the system will be awakened from what power saving modes when input signal of the PS/2 mouse is detected.

▶ **Resume By PCI Device (PME#)**

When set to [Enabled], the feature allows your system to be awakened from the power saving modes through any event on PME (Power Management Event).

▶ **Resume By PCI-E Device**

When set to [Enabled], the feature allows your system to be awakened from the power saving modes through any event on PCI Express device.

▶ **Resume By Onboard Lan**

When set to [Enabled], the feature allows your system to be awakened from the power saving modes through any event on LAN device.

▶ **Resume By RTC Alarm**

The field is used to enable or disable the feature of booting up the system on a scheduled time/date.

H/W Monitor

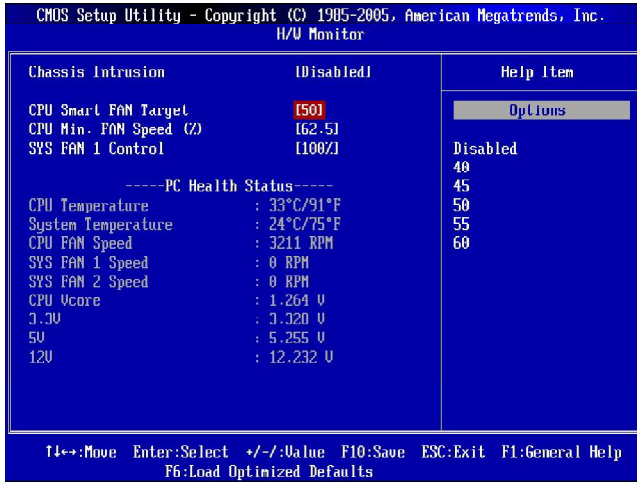

► Chassis Intrusion

The field enables or disables the feature of recording the chassis intrusion status and issuing a warning message if the chassis is once opened. To clear the warning message, set the field to [Reset]. The setting of the field will automatically return to [Enabled] later.

► CPU Smart FAN Target

The mainboard provides the Smart Fan function which can control the CPU fan speed automatically depending on the current temperature to keep it with in a specific range. You can select a fan target value here. If the current CPU fan temperature reaches to the target value, the smart fan function will be activated. It provides several sections to speed up for cooling down automatically.

► CPU Min. FAN Speed (%)

When you set a FAN target in “CPU Smart FAN Target”, this item will appear. This item allows you to select how percentage of minimum speed limit for the CPU fan.

► SYS FAN1 Control

This item is used to specify the percentage of SYSFAN1 speed.

---- PC Health Status ----

► CPU/ System Temperature, CPU FAN/ SYS FAN1/ SYS FAN2 Speed, CPU Vcore, 3.3V, 5V, 12V

These items display the current status of all of the monitored hardware devices/ components such as CPU voltage, temperatures and all fans' speeds.

BIOS Setting Password

When you select this function, a message as below will appear on the screen:



Type the password, up to six characters in length, and press <Enter>. The password typed now will replace any previously set password from CMOS memory. You will be prompted to confirm the password. Retype the password and press <Enter>. You may also press <Esc> to abort the selection and not enter a password.

To clear a set password, just press <Enter> when you are prompted to enter the password. A message will show up confirming the password will be disabled. Once the password is disabled, the system will boot and you can enter Setup without entering any password.

When a password has been set, you will be prompted to enter it every time you try to enter Setup. This prevents an unauthorized person from changing any part of your system configuration.

Cell Menu

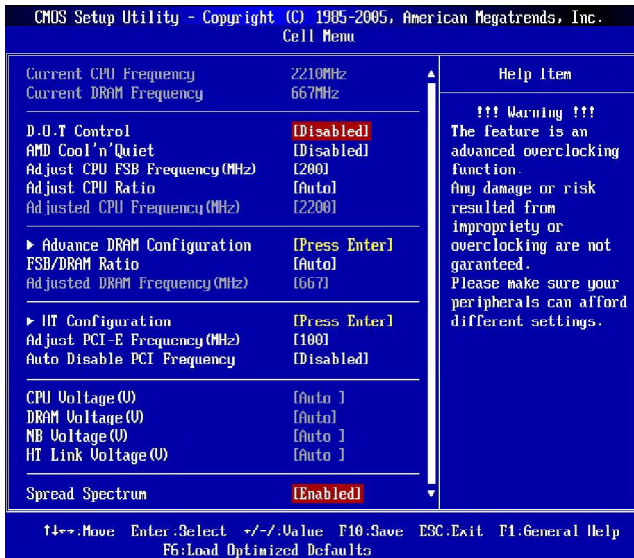

Important

Change these settings only if you are familiar with the chipset.

▶ Current CPU/ DRAM Frequency

These items show the current clocks of CPU and Memory speed. Read-only.

▶ D.O.T Control

D.O.T. (Dynamic Overclocking Technology) is the automatic overclocking function, included in the MSI™'s newly developed CoreCell™ Technology. It is designed to detect the load balance of CPU while running programs, and to adjust the best CPU frequency automatically. When the motherboard detects CPU is running programs, it will speed up CPU automatically to make the program run smoothly and faster. When the CPU is temporarily suspending or staying in the low load balance, it will restore the default settings instead. Usually the Dynamic Overclocking Technology will be powered only when users' PC need to run huge amount of data like 3D games or the video process, and the CPU frequency need to be boosted up to enhance the overall performance. Settings are:

[Disabled]	Disable Dynamic Overclocking.
[Private]	1st level of overclocking, increasing the frequency by 1%.
[Sergeant]	2nd level of overclocking, increasing the frequency by 3%.
[Captain]	3rd level of overclocking, increasing the frequency by 5%.
[Colonel]	4th level of overclocking, increasing the frequency by 7%.
[General]	5th level of overclocking, increasing the frequency by 10%.
[Commander]	6th level of overclocking, increasing the frequency by 15%.



Important

Even though the Dynamic Overclocking Technology is more stable than manual overclocking, basically, it is still risky. We suggest user to make sure that your CPU can afford to overclocking regularly first. If you find the PC appears to be unstable or reboot incidentally, it's better to disable the Dynamic Overclocking or to lower the level of overclocking options. By the way, if you need to conduct overclocking manually, you also need to disable the Dynamic OverClocking first.

► AMD Cool'n'Quiet

The Cool'n' Quiet technology can effectively and dynamically lower CPU speed and power consumption.



Important

To ensure that Cool'n'Quiet function is activated and will be working properly, it is required to double confirm that:

1. Run BIOS Setup, and select **Cell Menu**. Under **Cell Menu**, find **AMD Cool'n'Quiet**, and set this item to "Enable."
2. Enter Windows, and select [Start]-> [Settings]->[Control Pannel]->[Power Options]. Enter **Power Options Properties** tag, and select **Minimal Power Management** under **Power schemes**.

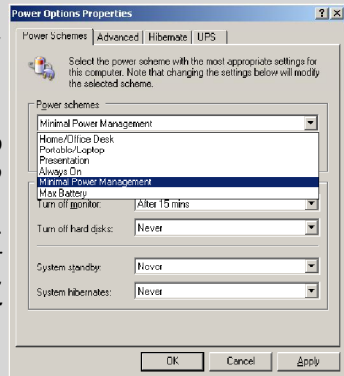

► **Adjust CPU FSB Frequency (MHz)**

This item allows you to select the CPU Front Side Bus clock frequency (in MHz).

► **Adjust CPU Ratio**

This item is used to adjust CPU clock multiplier (ratio). It is available only when the processor supports this function.

► **Adjusted CPU Frequency (MHz)**

This item shows the adjusted CPU frequency. Read only.

► **Advance DRAM Configuration**

Press <Enter> to enter the sub-menu and the following screen appears.

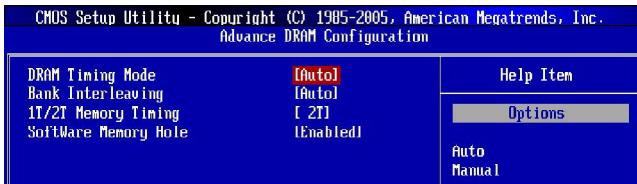

► **DRAM Timing Mode**

Selects whether DRAM timing is controlled by the SPD (Serial Presence Detect) EEPROM on the DRAM module. Setting to [Auto] enables DRAM timings and the following related items to be determined by BIOS based on the configurations on the SPD. Selecting [Manual] allows users to configure the DRAM timings and the following related items manually.

► **Bank Interleaving**

This field selects 2-bank or 4-bank interleave for the installed SDRAM. Disable the function if 16MB SDRAM is installed.

► **1T/2T Memory Timing**

When the **Memory Timings** is set to [Manual], the field is adjustable. This field controls the SDRAM command rate. Selecting [1T] makes SDRAM signal controller to run at 1T (T=clock cycles) rate. Selecting [2T] makes SDRAM signal controller run at 2T rate.

► **SoftWare Memory Hole**

In order to improve performance, certain space in memory can be reserved for ISA peripherals. This memory must be mapped into the memory space below 16MB. When this area is reserved, it cannot be cached.

► **FSB/DRAM Ratio**

This setting controls the ratio of CPU FSB Clock & DRAM Frequency to enable the CPU FSB & DRAM to run at different frequency combinations (non-synchronous overclocking). Please note that the setting options vary according to the CPU FSB Clock preset.

► **Adjusted DRAM Frequency (MHz)**

This item shows the adjusted DRAM frequency. Read only.

► **HT Configuration**

Press <Enter> to enter the sub-menu and the following screen appears.

CMOS Setup Utility - Copyright (C) 1985-2005, American Megatrends, Inc.	
HT Configuration	
Hyper Transport Configuration	Help Item
SB to AM2 FreqAuto	[Disabled]
SB to AM2 Freq	[1000 MHz]
SB to AM2 Link	[16 ↓ 16 ↑]
	SB to AM2 frequency selection by CPU capability

► **SB to AM2 FreqAuto**

Selecting [Disabled] allows users to configure the frequency (from SB to CPU) and the following related items manually.

► **SB to AM2 Freq**

This field selects the frequency from SB to CPU.

► **SB to AM2 Link**

This field selects the bandwidth from SB to CPU.

► **Adjust PCI-E Frequency (MHz)**

This field allows you to select the PCI Express frequency (in MHz).

► **Auto Disabled PCI Frequency**

When set to [Enabled], the system will remove (turn off) clocks from empty PCI slots to minimize the electromagnetic interference (EMI).

► **CPU Voltage (V)**

This item allows you to increase the CPU voltage.

► **DRAM Voltage (V)**

Adjusting the voltage can increase the memory speed.

► **NB Voltage (V)**

Adjust the North Bridge chipset voltage.

► **HT Link Voltage (V)**

Adjust the Hyper-Transport link voltage.

► **Spread Spectrum**

This setting is used to enable or disable the Spread Spectrum feature. When overclocking, always set it to [Disabled].



Important

1. *If you do not have any EMI problem, leave the setting at [Disabled] for optimal system stability and performance. But if you are plagued by EMI, select the value of Spread Spectrum for EMI reduction.*
2. *The greater the Spread Spectrum value is, the greater the EMI is reduced, and the system will become less stable. For the most suitable Spread Spectrum value, please consult your local EMI regulation.*
3. *Remember to disable Spread Spectrum if you are overclocking because even a slight jitter can introduce a temporary boost in clock speed which may just cause your overclocked processor to lock up.*

USER SETTINGS

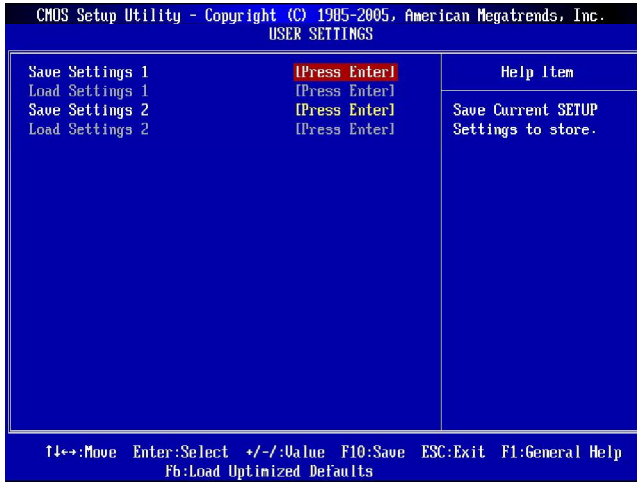

► Save Settings 1/2

Select this item and press “Enter” to save any changes you have made to your current settings.

► Load Settings 1/2

Select this item and press “Enter” to load settings from the store.

Load Fail-Safe/ Optimized Defaults

The two options on the main menu allow users to restore all of the BIOS settings to the default Fail-Safe or Optimized values. The Optimized Defaults are the default values set by the mainboard manufacturer specifically for optimal performance of the mainboard. The Fail-Safe Defaults are the default values set by the BIOS vendor for stable system performance.

When you select Load Fail-Safe Defaults, a message as below appears:



Selecting **Ok** and pressing **Enter** loads the BIOS default values for the most stable, minimal system performance.

When you select Load Optimized Defaults, a message as below appears:

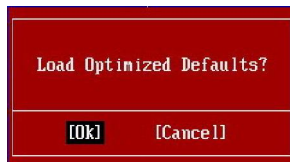

Selecting **Ok** and pressing **Enter** loads the default factory settings for optimal system performance.

Appendix A

Realtek ALC888 Audio

The Realtek ALC888 provides 10-channel DAC that simultaneously supports 7.1 sound playback and 2 channels of independent stereo sound output (multiple streaming) through the Front-Out-Left and Front-Out-Right channels.

Installing the Realtek HD Audio Driver

You need to install the HD audio driver for Realtek ALC888 codec to function properly before you can get access to 2-, 4-, 6-, 8- channel or 7.1+2 channel audio operations. Follow the procedures described below to install the drivers for different operating systems.

Installation for Windows 2000/ XP/ Vista

For Windows® 2000, you must install Windows® 2000 Service Pack4 or later before installing the driver. For Windows® XP, you must install Windows® XP Service Pack1 or later before installing the driver.

The following illustrations are based on Windows® XP environment and could look slightly different if you install the drivers in different operating systems.

1. Insert the application CD into the CD-ROM drive. The setup screen will automatically appear.
2. Click **Realtek HD Audio Driver**.

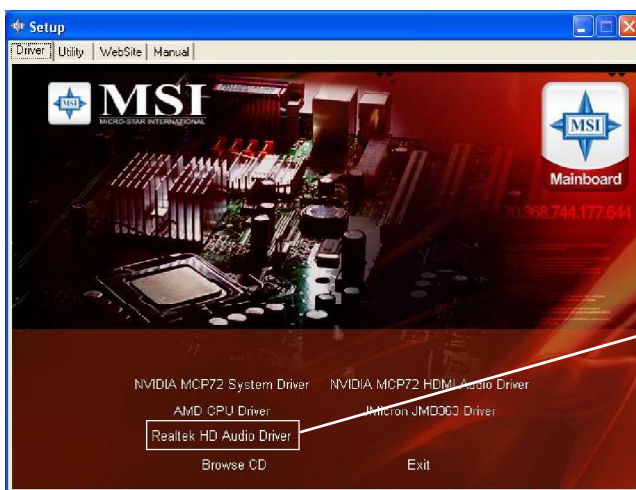

Click here



Important

*The **HD Audio Configuration** software utility is under continuous update to enhance audio applications. Hence, the program screens shown here in this section may be slightly different from the latest software utility and shall be held for reference only.*

3. Click **Next** to install the Realtek High Definition Audio Driver.

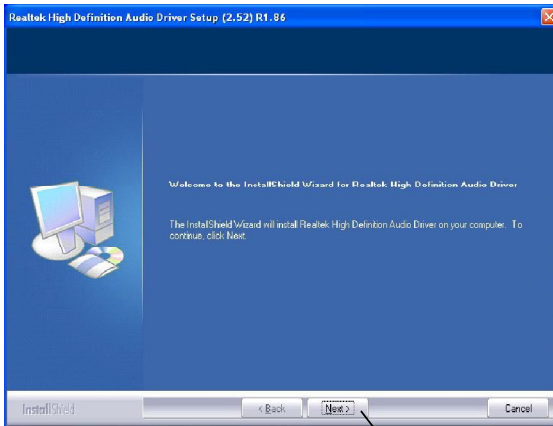

Click here

4. Click **Finish** to restart the system.

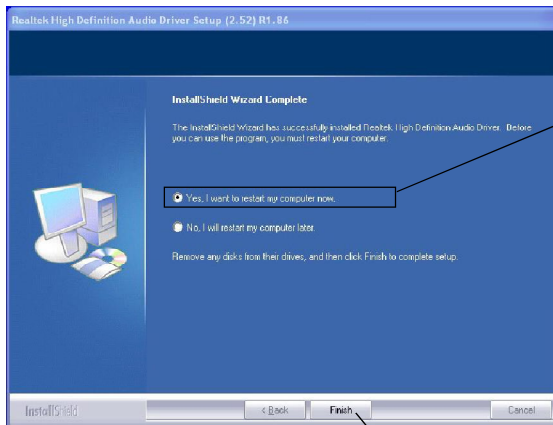

Select this option

Click here

Software Configuration

After installing the audio driver, you are able to use the 2-, 4-, 6- or 8- channel audio feature now. Click the audio icon  from the system tray at the lower-right corner of the screen to activate the **HD Audio Configuration**. It is also available to enable the **HD Audio Configuration** by clicking the **Realtek HD Audio Manager** from the **Control Panel**.



Double click

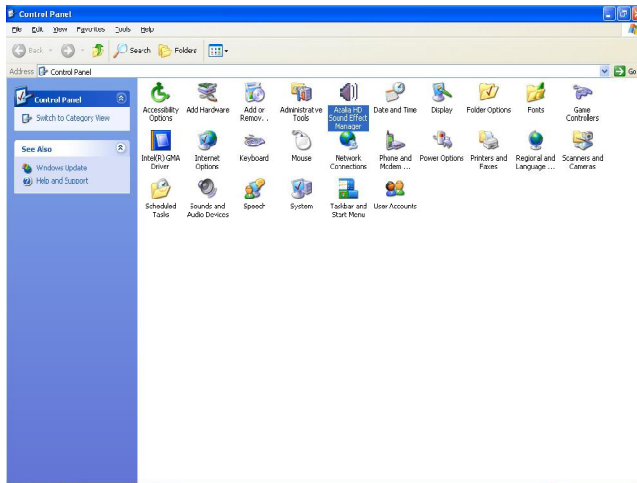

Sound Effect

Here you can select a sound effect you like from the **Environment** list.

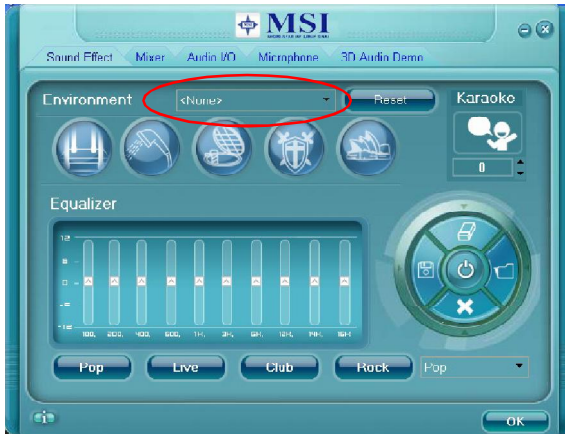

Environment Simulation

You will be able to enjoy different sound experience by pulling down the arrow, several kinds of sound effect will be shown for selection. Realtek HD Audio Sound Manager also provides five popular settings “Stone Corridor”, “Bathroom”, “Sewer pipe”, “Arena” and “Audio Corridor” for quick enjoyment.

You may choose the provided sound effects, and the equalizer will adjust automatically. If you like, you may also load an equalizer setting or make an new equalizer setting to save as an new one by using the **“Load EQ Setting”** and **“Save Preset”** button, click **“Reset EQ Setting”** button to use the default value, or click **“Delete EQ Setting”** button to remove a preset EQ setting.

There are also other pre-set equalizer models for you to choose by clicking **“Others”** under the **Equalizer** part.

Equalizer Selection

Equalizer frees users from default settings; users may create their own preferred settings by utilizing this tool.

10 bands of equalizer, ranging from 100Hz to 16KHz.

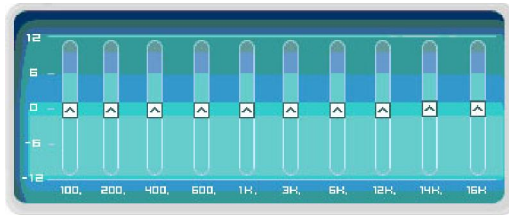

Save

The settings are saved permanently for future use

Reset

10 bands of equalizer would go back to the default setting

Enable / Disable

To disable, you can temporarily stop the sound effect without losing the settings

Load

Whenever you would like to use preload settings, simply click this, the whole list will be shown for your selection.

Delete

To delete the pre-saved settings which are created from previous steps.



Frequently Used Equalizer Setting

Realtek recognizes the needs that you might have. By leveraging our long experience at audio field, Realtek HD Audio Sound Manager provides you certain optimized equalizer settings that are frequently used for your quick enjoyment.

[How to Use It]

Other than the buttons “Pop” “Live” “Club” & “Rock” shown on the page, to pull down the arrow in “Others”, you will find more optimized settings available to you.

Karaoke Mode

Karaoke mode brings Karaoke fun back home. Simply using the music you usually play, Karaoke mode can help you eliminate the vocal of the song or adjust the key to accommodate your range.

- 1.Vocal Cancellation: Single click on “Voice Cancellation”, the vocal of the song would be eliminated, while the background music is still in place, and you can be that singer!
- 2.Key Adjustment: Using “Up / Down Arrow” to find a key which better fits your vocal range.

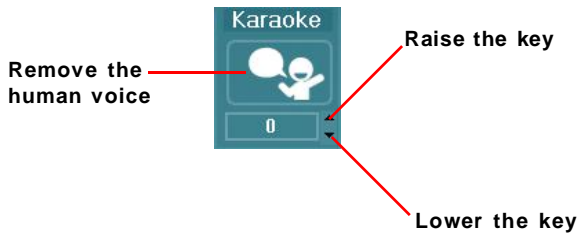

Mixer

In the **Mixer** part, you may adjust the volumes of the rear and front panels individually.

1. Adjust Volume

You can adjust the volume of the speakers that you plugged in front or rear panel by select the **Realtek HD Audio rear output** or **Realtek HD Audio front output** items.



Important

Before set up, please make sure the playback devices are well plugged in the jacks on the rear or front panel. The **Realtek HD Audio front output** item will appear after you plugging the speakers into the jacks on the front panel.

2. Multi-Stream Function

ALC888 supports an outstanding feature called Multi-Stream, which means you may play different audio sources simultaneously and let them output respectively from the indicated rear panel or front panel. This feature is very helpful when 2 people are using the same computer together for different purposes.

Click the  button and the Mixer **ToolBox** menu will appear. Then check the **Enable playback multi-streaming** and click **OK** to save the setup.



Important

If you use **AC97 front panel**, the device have to be plugged into the jacks on the panel before enable the multi-stream function.

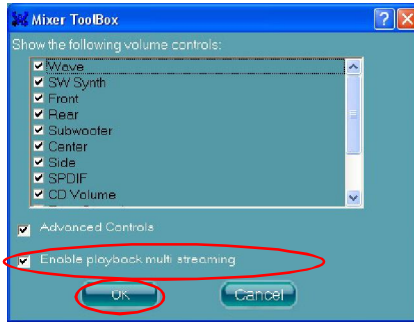

When you are playing the first audio source (for example: use Windows Media Player to play DVD/VCD), the output will be played from the rear panel, which is the default setting.

Then you **must** to select the **Realtek HD Audio front output** from the scroll list **first**, and use a different program to play the second audio source (for example: use Winamp to play MP3 files). You will find that the second audio source (MP3 music) will come out from the Line-Out audio jack of Front Panel.



3. Playback control

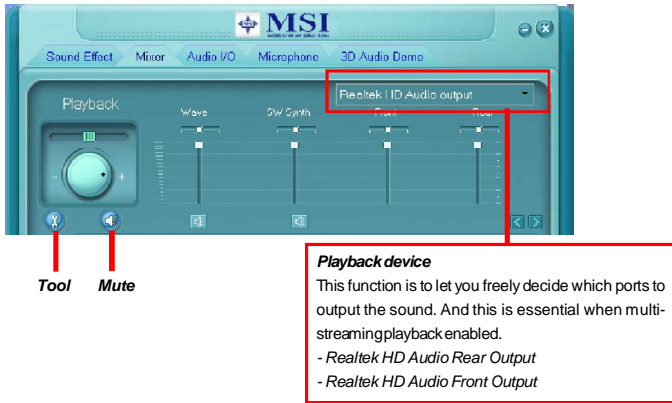

Mute

You may choose to mute single or multiple volume controls or to completely mute sound output.

Tool

- Show the following volume controls

This is to let you freely decide which volume control items to be displayed.

- Advanced controls
- Enable playback multi-streaming

With this function, you will be able to have an audio chat with your friends via headphone (stream 1 from front panel) while still have music (stream 2 from back panel) in play. At any given period, you can have maximum 2 streams operating simultaneously.

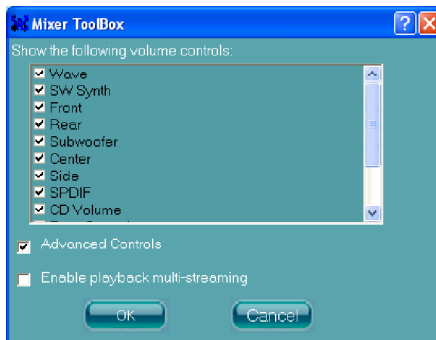

4. Recording control

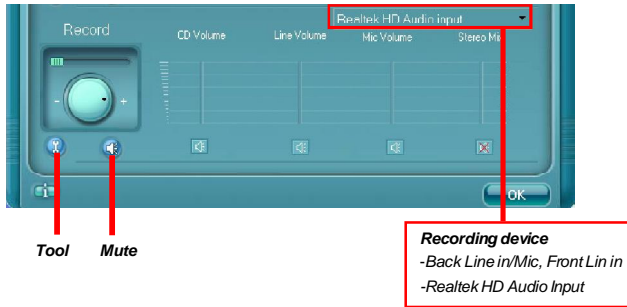

Mute

You may choose to mute single or multiple volume controls or to completely mute sound input.

Tool

- Show the following volume controls

This is to let you freely decide which volume control items to be displayed.

- Enable recording multi-streaming



Important

ALC888 allows you to record the CD, Line, Mic and Stereo Mix channels simultaneously, frees you from mixing efforts. At any given period, you may choose 1 of the following 4 channels to record.

Audio I/O

In this tab, you can easily configure your multi-channel audio function and speakers. You can choose a desired multi-channel operation here.

- a. **Headphone** for the common headphone
- b. **2CH Speaker** for Stereo-Speaker Output
- c. **4CH Speaker** for 4-Speaker Output
- d. **6CH Speaker** for 5.1-Speaker Output
- e. **8CH Speaker** for 7.1-Speaker Output



Speaker Configuration:

1. Plug the speakers in the corresponding jack.
2. Dialogue "connected device" will pop up for your selection. Please select the device you have plugged in.
 - If the device is being plugged into the correct jack, you will be able to find the icon beside the jack changed to the one that is same as your device.
 - If not correct, Realtek HD Audio Manager will guide you to plug the device into the correct jack.

Connector Settings

Click  to access connector settings.



Disable front panel jack detection (option)

Find no function on front panel jacks? Please check if front jacks on your system are so-called AC'97 jacks. If so, please check this item to disable front panel jack detection.

Mute rear panel output when front headphone plugged in.

Enable auto popup dialogue, when device has been plugged in

Once this item checked, the dialog "Connected device" would automatically pop up when device plugged in.

S/PDIF

Short for Sony/Philips Digital Interface, a standard audio file transfer format. S/PDIF allows the transfer of digital audio signals from one device to another without having to be converted first to an analog format. Maintaining the viability of a digital signal prevents the quality of the signal from degrading when it is converted to analog.

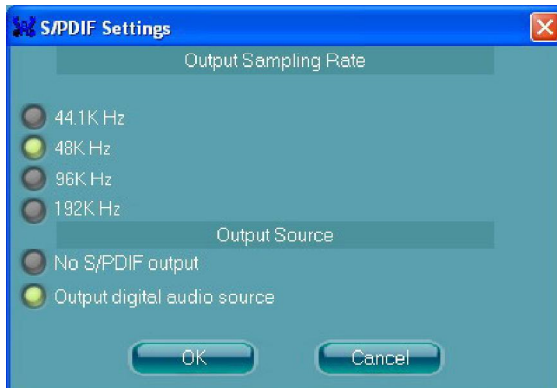

Output Sampling Rate

- 44.1KHz: This is recommend while playing CD.
- 48KHz: This is recommended while playing DVD or Dolby.
- 96KHz: This is recommended while playing DVD-Audio.
- 192KHz: This is recommended while playing High quality Audio.

Output Source

Output digital audio source: The digital audio format (such as .wav, .mp3,.midi etc) will come out through S/PDIF-Out.

Test Speakers

You can select the speaker by clicking it to test its functionality. The one you select will light up and make testing sound. If any speaker fails to make sound, then check whether the cable is inserted firmly to the connector or replace the bad speakers with good ones. Or you may click the **auto test**  button to test the sounds of each speaker automatically.

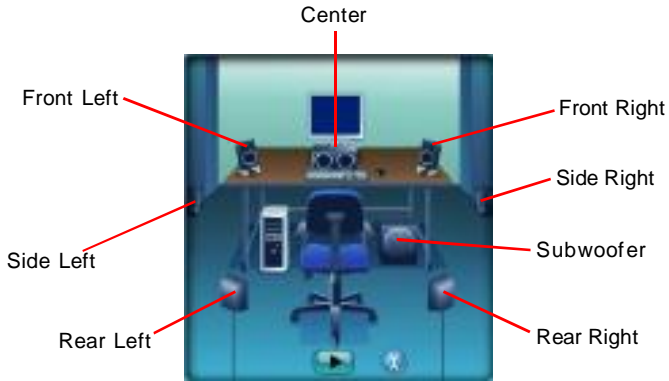

Microphone

In this tab you may set the function of the microphone. Select the **Noise Suppression** to remove the possible noise during recording, or select **Acoustic Echo Cancellation** to cancel the acoustic echo during recording.

Acoustic Echo Cancellation prevents playback sound from being recorded by microphone together with your sound. For example, you might have chance to use VOIP function through Internet with your friends. The voice of your friend will come out from speakers (playback). However, the voice of your friend might also be recorded into your microphone then go back to your friend through Internet. In that case, your friend will hear his/her own voice again. With AEC(Acoustic Echo Cancellation) enabled at your side, your friend can enjoy the benefit with less echo.



3D Audio Demo

In this tab you may adjust your 3D positional audio before playing 3D audio applications like gaming. You may also select different environment to choose the most suitable environment you like.



Information

In this tab it provides some information about this HD Audio Configuration utility, including Audio Driver Version, DirectX Version, Audio Controller & Audio Codec. You may also select the language of this utility by choosing from the **Language** list.

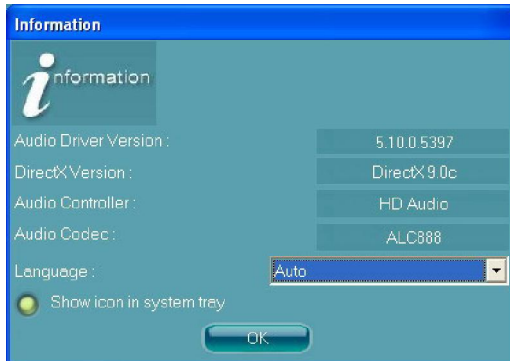

Also there is a selection **Show icon in system tray**. Switch it on and an icon  will show in the system tray. Right-click on the icon and the **Audio Accessories** dialogue box will appear which provides several multimedia features for you to take advantage of.



Hardware Setup

Connecting the Speakers

When you have set the Multi-Channel Audio Function mode properly in the software utility, connect your speakers to the correct phone jacks in accordance with the setting in software utility.

n 2-Channel Mode for Stereo-Speaker Output

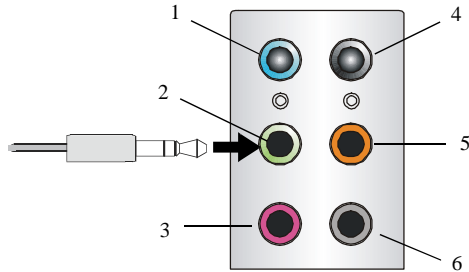

- 1 Line In
- 2 Line Out (*Front channels*)
- 3 MC
- 4 No function
- 5 No function
- 6 No function

n 4-Channel Mode for 4-Speaker Output

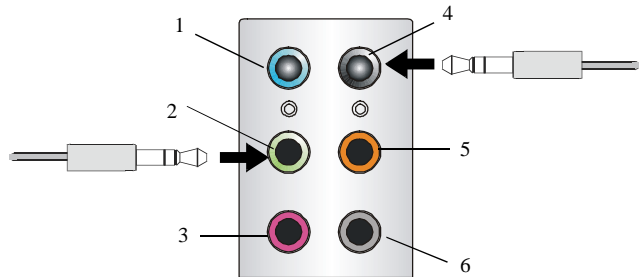

- 1 Line In
- 2 Line Out (*Front channels*)
- 3 MIC
- 4 Line Out (*Rear channels*)
- 5 No function
- 6 No function

n 6-Channel Mode for 6-Speaker Output

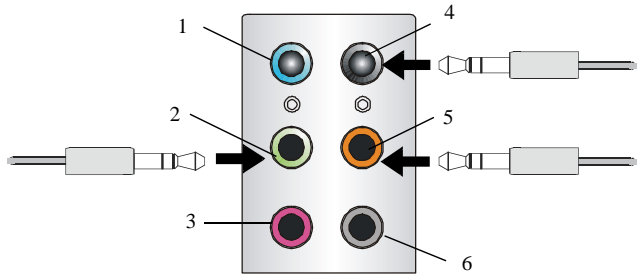

- 1 Line In
- 2 Line Out (*Front channels*)
- 3 MIC
- 4 Line Out (*Rear channels*)
- 5 Line Out (*Center and Subwoofer channel*)
- 6 No function

n 8-Channel Mode for 8-Speaker Output

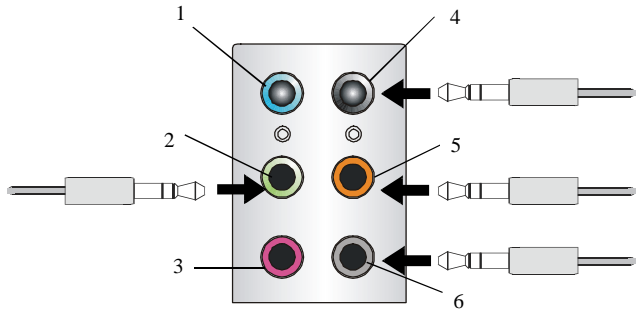

- 1 Line In
- 2 Line Out (Front channels)
- 3 MIC
- 4 Line Out (Rear channels)
- 5 Line Out (Center and Subwoofer channel)
- 6 Line Out (Side channels)



Important

To enable 7.1 channel audio-out function on Vista operating system, you have to install the Realtek Audio Driver. Or, the mainboard will support 5.1 channel audio-out only.

Appendix B

NVIDIA RAID

NVIDIA brings Redundant Array of Independent Disks (RAID) technology—which is used by the world's leading businesses—to the common PC desktop. This technology uses multiple drives to either increase total disk space or to offer data protection. For all levels, RAID techniques optimize storage solutions by using multiple disks grouped together and treating them as a single storage resource.

Introduction

System Requirement

Operating System Support

NVRAID supports the following operating systems:

Windows XP, Windows Vista

RAID Arrays

NVRAID supports the following types of RAID arrays described in this section:

RAID 0: RAID 0 defines a disk striping scheme that improves the disk read and write times for many applications.

RAID 1: RAID 1 defines techniques for mirroring data.

RAID 0+1: RAID 0+1 combines the techniques used in RAID 0 and RAID 1 arrays.

RAID 5: RAID 5 defines techniques for parity data.

Spanning (JBOD): JBOD provides a method for combining drives of different sizes into one large disk

Summary of RAID Configurations

Array	Uses	Advantages	Drawbacks	# Hard Disks	Fault Tolerance
RAID 0	Non-critical data requiring high performance.	High data throughput.	No fault tolerance.	multiple	None
RAID 1	Small databases or any other small capacity environment requiring fault tolerance.	100% data redundancy.	Requires 2 drives for the storage space of 1 drive.	2	Yes
RAID 0+1	Critical data requiring high performance.	Optimized for both 100% data redundancy and performance. Allows spare disks.	Requires 2 drives for the storage space of 1 drive—the same as RAID level 1.	4+	Yes
RAID 5	Critical data and reasonable level of performance.	Fault tolerance and better utilization of disk space.	Decreased write performance due to parity calculations. Requires at least three drives.	3+	Yes
JBOD	Combining odd size drives into one big drive	Combines and uses the capacity of odd size drives.	Decreases performance because of the difficulty in using drives concurrently or to optimize drives for different uses.	Multiple	No

RAID Configuration

Basic Configuration Instructions

The following are the basic steps for configuring NVRAID:

Non-Bootable RAID Array

1. Choose the hard disks that are to be RAID enabled in the system BIOS. (Refer the bios section for details.)
2. Specify the RAID level, either Mirroring (RAID 1), Striping (RAID 0), Striping and Mirroring (RAID 0+1), RAID 5 or JBOD and create the desired RAID array.
3. Enter the Windows OS, run the Windows nForce Setup application and install the RAID software. (Check B-8 for details.)
4. Initialize the NVRAID Array Disks.

Bootable RAID Array

1. Choose the hard disks that are to be RAID enabled in the system BIOS. (Refer the bios section for details.)
2. Specify the RAID level, either Mirroring (RAID 1), Striping (RAID 0), Striping and Mirroring (RAID 0+1), RAID 5 or JBOD and create the desired RAID array.
3. Boot from the Windows CD, use the floppy disk that has the RAID driver to copy and install the nForce RAID software. (Check p.B-7 for details.)
4. Initialize the NVRAID Array Disks.

Setting Up the NVRAID BIOS

Be sure to enable the **RAID** function in **SATA Channel** of **Integrated Peripherals** in BIOS before configuring the NVRAID BIOS. After that press **F10** to save the configuration and exit. The PC will reboot right away. Then enter the RAID BIOS Setup by pressing **F10** when prompted, and follow the procedures described below to set up the NVRAID BIOS.

NVRAID BIOS setup lets you choose the RAID array type and which hard drives you want to make part of the array.

Entering the RAID BIOS Setup

1. After rebooting your PC, wait until you see the RAID software prompting you to press **F10**. The RAID prompt appears as part of the system POST and boot process prior to loading the OS.
2. Press **F10**, and the NVIDIA RAID Utility --- **Define a New Array** window will appear.
The default **RAID Mode** is set to **Mirroring** and **Striping Block** is set to **Optimal**.

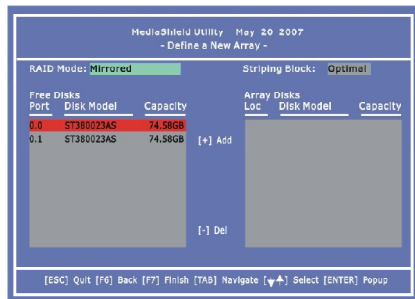

Understanding the “Define a New Array” Window

Use the Define a New Array window to

- Select the RAID Mode
- Set up the Striping Block
- Specify which disks to use for the RAID Array

The SATA ports are called channels and they are associated with adapters. The first digit in the Location field defines the adapter that the port is associated with. The 2nd digit defines the channel.

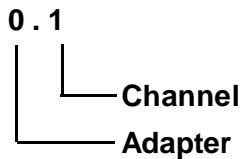

In the example above, 0.1 means the hard drive is attached to Adapter 0, Channel 1. The following is a list of all possible combinations:

Serial ATA

0.0	Adapter 0, Channel 0 (SATA1)
0.1	Adapter 0, Channel 1 (SATA2)
0.2	Adapter 0, Channel 3 (SATA3)
0.3	Adapter 0, Channel 4 (SATA4)



Important

There is no such thing as Slave drive in Serial ATA. All drives are considered to be Master since there is a one to one connection between the drive and the controller.

Using the Define a New Array Window

If necessary, press the tab key to move from field to field until the appropriate field is highlighted.

• Selecting the RAID Mode

By default, this is set to [Mirroring]. To change to a different RAID mode, press the down arrow key until the mode that you want appears in the RAID Mode box—either [Mirroring], [Striping], [RAID5], [Spanning], or [Stripe Mirroring].

• Selecting the Striping Block Size

Striping Block size is given in kilobytes, and affects how data is arranged on the disk. It is recommended to leave this value at the default [Optimal], which is 32KB, but the values can be between [4 KB] and [128 KB].

• Assigning the Disks

The disks that you enabled from the RAID Config BIOS setup page appear in the **Free Disks** block. These are the drives that are available for use as RAID array disks.

To designate a free disk to be used as a RAID array disk,

1. Tab to the **Free Disks** section. The first disk in the list is selected.
2. Move it from the Free Disks block to the Array Disks block by pressing the right arrow key (-->). The first disk in the list is moved, and the next disk in the list is selected and ready to be moved.
3. Continue pressing the right-arrow key (-->) until all the disks that you want to use as RAID array disks appear in the **Array Disks** block.

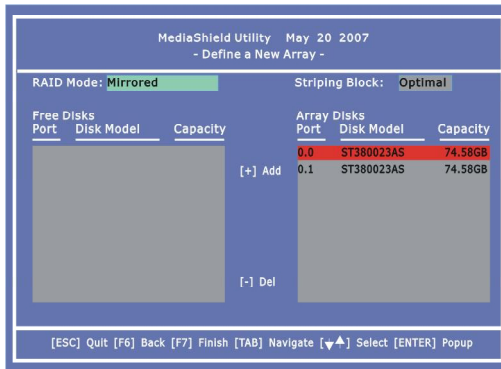

It shows that two disks have been assigned as RAID1 array disks in the figure above.

Completing the RAID BIOS Setup

1. After assigning your RAID array disks, press **F7**. The Clear disk data prompt appears.

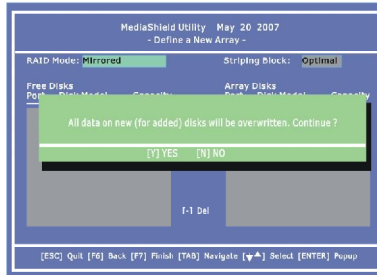

2. Press **Y** if you want to wipe out all the data from the RAID array, otherwise press **N**. You must choose **Yes** if the drives were previously used as RAID drives. The **Array List** window appears, where you can review the RAID arrays that you have set up.

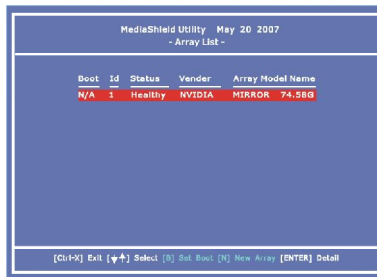

3. Use the arrow keys to select the array that you want to set up, then press **Enter**. The **Array Detail** window appears.

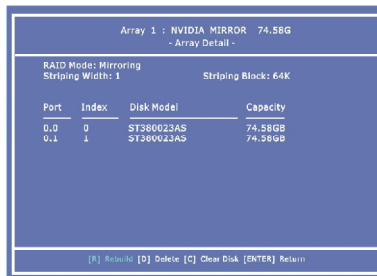

4. If you want to mark this disk as empty and wipe out all its contents then press **C**.
5. At the prompt, press **Y** to wipe out all the data, otherwise press **N**.
6. Press **Enter** again to go back to the previous window and then press **Ctrl+X** to exit the RAID setup. Now that the RAID setup has been configured from the RAID BIOS, the next step is to configure and load NVRAID drivers under Windows, as explained in "Installing the NVIDIA MediaShield Software Under Windows" on B-8.

Installing Driver

Install Driver in Windows Vista / XP

† New Windows Vista/ XP Installation

For Windows XP:

1. When you start installing Windows XP, you may encounter a message stating, "Setup could not determine the type of one or more mass storage devices installed in your system". If this is the case, then you are already in the right place and are ready to supply the driver. If this is not the case, then press F6 when prompted at the beginning of Windows setup.
2. Press the "S" key to select "Specify Additional Device".
3. You should be prompted to insert a floppy disk containing the NVIDIA RAID driver into the A: drive, and then press ENTER.



Important

Please follow the instruction below to make an "**NVIDIA RAID Driver**" for yourself.

- a. Insert the MSI CD into the CD-ROM drive.
 - b. Click the "Browse CD" on the Setup screen.
 - c. Copy all the contents in the `\\nVidia\System\MCP72\IDE\WinXP\lsataraid\Floppy` to a formatted floppy disk.
`\\ChipSet\nVidia\Vista32 (for 32 bits) or Visat64(for 64 bits)\MCP72\IDE\WinVista (for 32 bits) or WinVista64 (for 64 bits)\lsataraid` to a medium (floppy disk/ CD/DVD or USB).
 - d. The driver diskette for **NVIDIA RAID Controller** is done.
4. You should be shown a list of available NVRAID Adapters.
 5. Select the "NVIDIA RAID Driver" and press ENTER.
 6. Press "S" again at the Specify Devices screen, then press ENTER.
 7. Select "NVIDIA NForce Storage Controller" and then press ENTER.
 8. Press **Enter** to continue with Windows XP Installation. Be sure to leave the floppy disk inserted in the floppy drive until the blue screen portion of Windows XP installation is completed, then take out the floppy.
 9. Follow the instructions on how to install Windows XP. After Windows XP is completely installed, it is recommended that you install the RAID management tool.

For Windows Vista:

During the operating system installation, after selecting the location to install Windows Vista, please click on the "Load Driver" button to load RAID driver. Please refer the **Important** notice above to make a RAID Driver medium. And then, follow the instructions to complete the whole installation.

Notice: Each time you add a new hard drive to a RAID array, the RAID driver will have to be installed under Windows once for that hard drive. After that, the driver will not have to be installed.

NVIDIA RAID Utility Installation

Installing the NVIDIA MediaShield Software Under Windows (for Non-bootable RAID Array)

The existing Windows Serial ATA driver must be upgraded to use the NVIDIA Serial ATA driver.

This section describes how to run the setup application and install the RAID software which will upgrade the Windows SATA driver and install the RAID software.

1. Start the NVIDIA nForce Drivers installation program to open the NVIDIA Windows nForce Drivers page.

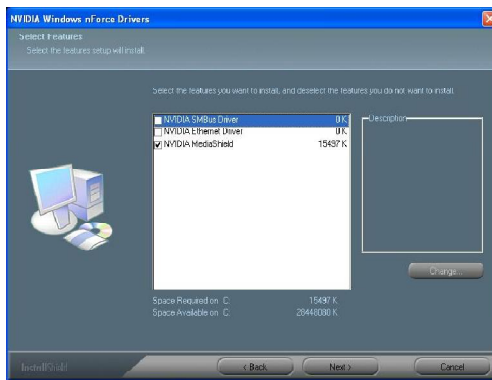

2. Select the NVIDIA MediaShield.
3. Click **Next** and then follow the instructions.
4. After the installation is completed, be sure to reboot the PC.
5. After the reboot, initialize the newly created array.

Initializing and Using the Disk Array

The RAID array is now ready to be initialized under Windows.

1. Launch Computer Management by clicking “Start” --> “Settings” --> “Control Panel” then open the “Administrative Tools” folder and double click on “Computer Management”.
2. Click “Disk Management” (under the “Storage” section). The Initialize and Convert Disk Wizards appears.



3. Click **Next**. The Select Disks to Initialize window appears. The disks listed depend on how many arrays you have configured.

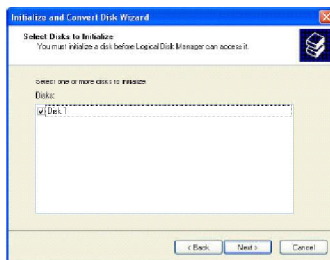

4. Click **Next**. The Select Disks to Convert window appears.

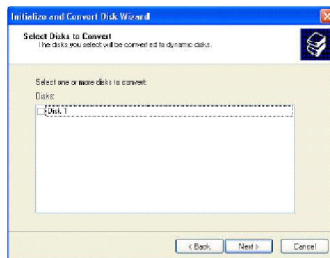

5. Check the disk in the list if you want to make the array a dynamic disk, then click **Next**. The Completing the Initialize and Convert Disk Wizard window appears.

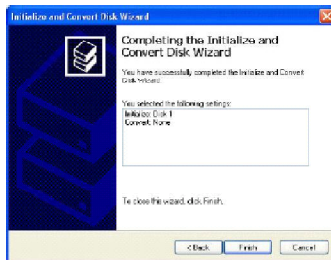

6. Click **Finish**. The "Computer Management" window appears.

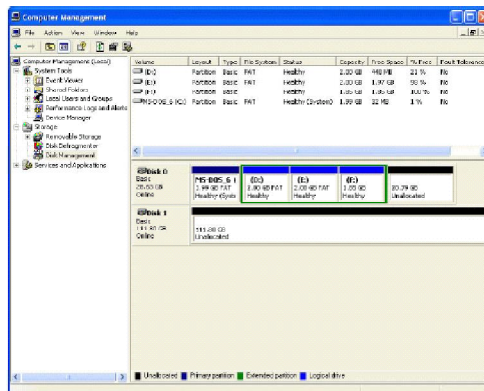

The actual disks listed will depend on your system, and the unallocated partition is the total combined storage of two hard disks. You must format the unallocated disk space in order to use it.

7. Format the unallocated disk space. Right click "Unallocated space", select "New Partition..." and follow the wizard. After the drive has been formatted, it is ready for use.

Using the NVMediaShield Software

Accessing the Storage Page

To access the NVIDIA Control Panel Storage page:

1. Click Start-> Programs-> NVIDIA Corporation-> NVIDIA Control Panel-> Storage.

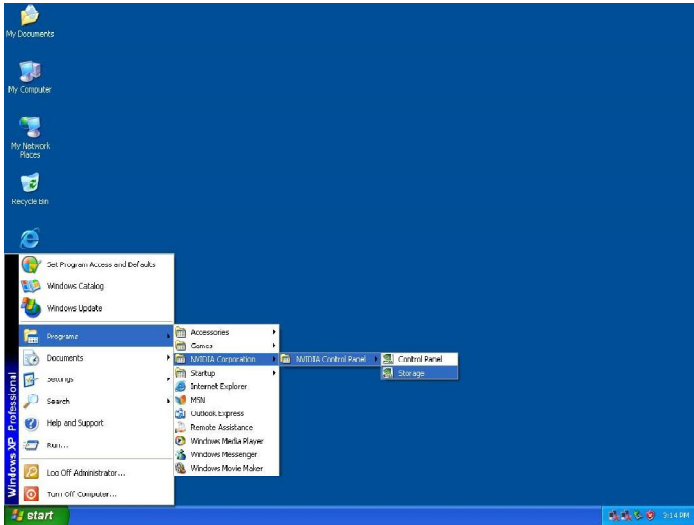

2. The NVIDIA Control Panel - **Storage** page appears.

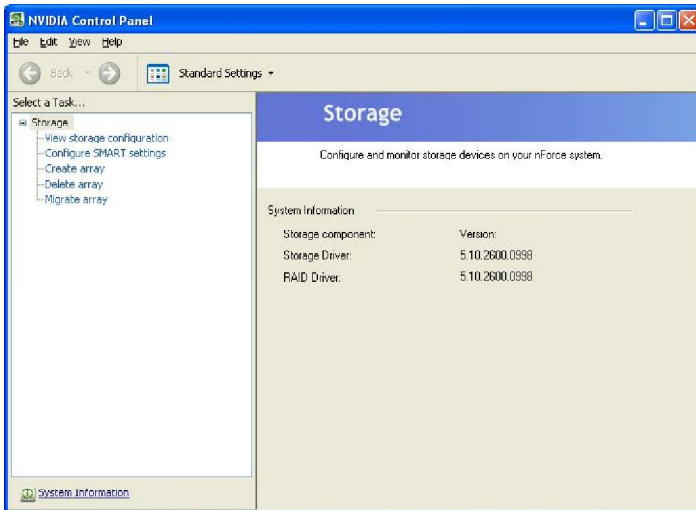

Using the Storage Page

From the Storage page, you can accomplish the following tasks:

- **Create an Array**
- **Delete an Array**
- **Rebuild an Array**
- **Synchronize an Array**
- **Designate a Spare Disk**
- **Remove a Spare**
- **Migrate an Array**
- **View Storage Information**

Create an Array

This option is available only if there are free disks that are RAID-enabled.

Click **Create array** to start the Create Array Wizard and then follow the instructions. You can press **F1** to access the online help that walks you through the Wizard with step-by-step instructions.

Delete an Array

This option is available only if RAID arrays have been created.

Click **Delete array** to start the Delete Array Wizard and then follow instructions.

You can press **F1** to access the online help that walks you through the Wizard with step-by-step instructions.

Rebuild an Array

About Rebuilding

Rebuilding is the process of restoring data to a hard drive from other drives in the array. For example, if you have a three disk RAID 5 array and one of the drives fails, you will need to replace the failed drive with a new one, and rebuild the array to re-generate the lost data on the newly added drive.

Rebuilding applies only to fault-tolerant arrays such as RAID 1, RAID 0+1, or RAID 5 Arrays.

Instructions

Click **Rebuild array** to start the Rebuild Create Array Wizard and then follow the instructions.

You can press **F1** to access the online help that walks you through the Wizard with step-by-step instructions.

The rebuilding process takes some time to complete, and occurs in the background so as not to affect the performance of the system.

Synchronize an Array

Synchronizing an array will force a rebuild of redundancy or parity. The operation applies to any fault-tolerant array such as RAID 1, 0+1 and RAID 5.

Click **Synchronize array** to start the Synchronize Array Wizard and then follow instructions.

You can press **F1** to access the online help that walks you through the Wizard with step-by-step instructions.

Designate a Spare Disk

About Spare Disks

You can designate a hard drive to be used as a spare drive for a RAID 1, RAID 0+1 or RAID 5 array². The spare drive can take over for a failed disk. MediaShield RAID supports two types of spare drives:

Free Disk

A free disk is a disk that is not part of any RAID array, but can be used by any available RAID 1, RAID 0+1, or RAID 5 array that requires another disk when one of its disks crashes or becomes unusable. The process is automatic and requires no user interaction.

Example: A system may have four hard disks where one disk is used to boot the OS, two hard drives are set up in a mirrored array, and a fourth hard disk is set up as a free disk. If one of the mirrored array drives fails, the free disk will be assigned automatically to the mirrored array to replace the failed disk.

Dedicated Disk

A dedicated free disk is a disk that is assigned to a RAID 1, RAID 0+1, or RAID 5 array. The dedicated disk is used by that array only when needed - for example, during a system crash where a RAID mirrored drive is broken. The dedicated disk can be used only by the array that it is assigned to and not by any other array, unlike a free disk which can be used by any available RAID 1, RAID 0+1, or RAID 5 array.

To mark a disk as dedicated (reserve it for use by a specific array), you must have at least one free disk and you must also have at least two RAID 1, RAID 0+1, or RAID 5 arrays created.

Requirements for Designating a Spare Disk

The Designate Spare option on the Storage page appears only if all the following conditions are met.

- There must be at least two fault tolerant arrays already created.
- There must be at least one free disk with capacity equal to or greater than the smallest disk in the given fault tolerant array.
For example, if a mirror array is created with disk capacities of 40 GB and 80 GB, there should be at least one free disk available of capacity equal to or greater than 40GB to be used as a spare disk for that array.

Instructions

Click **Designate spare** to start the Designate Spare Wizard and then follow instructions.

You can press **F1** to access the online help that walks you through the Wizard with step-by-step instructions.

Remove a Spare

The Remove spare option appears only if you have a RAID array with a spare disk allocated to it.

Click **Remove spare** to start the Remove Spare Wizard and then follow the instructions.

You can press **F1** to access the online help that walks you through the Wizard with step-by-step instructions.

Migrate an Array

In a traditional RAID environment, when a user wants to change the current state of a disk or a current array to a new RAID configuration, the process of reconfiguring the new array involves multiple steps. The user must back up the data, delete the array, re-boot the PC, and then reconfigure the new array.

MediaShield RAID allows the end user to change the current state of the disk or array to another with a one-step process called "Migrating". This section describes the NVIDIA Migrating process and explains how to use Migrating to convert from one RAID array type to another.

General Migrating Requirements

- The new array capacity must be equal to or greater than the previous array.
For example, it is possible to migrate from a RAID 1 array to a RAID 0 array as long as the RAID 0 array is the same size as (or larger than) the RAID 1 array.
- The number of disks in the new array cannot be less than the number of disks in the original array.
- You cannot migrate
 - To or from a JBOD (Spanning) array
 - From RAID 1 to RAID 1
 - From RAID 0+1 to RAID 1
 - From RAID 5 to 1

Migrating to an Array Larger Than 2 TB

Your disks must be partitioned using the GUID partition table (GPT) if you plan to migrate to an array with greater than 2 TB storage.

If your original array is not a GPT disk and you expand your array's capacity using the migration feature to over 2 TB, you will not be able to access the additional storage above 2 TB in the new array. To use the additional storage in this situation, back up your data, repartition the array using GPT, then restore your data to the new volume.



Important

Be sure to make the volume dynamic if you plan to have more than four partitions.

Specific Migrating Requirements

The following table lists the disk requirements for a new RAID array for various migrating combinations.

From	To	New Array Disk Requirements
RAID 0	RAID 0	$m > n$ Number of disks in the new array must be greater than the original array.
	RAID 1	$m = 2, n = 1$ RAID 1 array must include two disks, converted from a one disk RAID 0 array.
	RAID 0+1	$m \geq 2 \times n$ Number of RAID 0+1 disks must be equal to or greater than twice the number of RAID 0 disks.
	RAID 5	$m \geq n+1$
RAID 1	RAID 0	No additional restrictions.
	RAID 1	** Not a valid combination **
	RAID 0+1	No additional restrictions.
	RAID 5	$m \geq 3$
RAID 0+1	RAID 0	$m \geq n/2$ Number of RAID 0 disks must be equal to or greater than half the number of RAID 0+1 disks.
	RAID 1	** Not a valid combination **
	RAID 0+1	** Not a valid combination **
	RAID 5	$m \geq (n/2 + 1)$
RAID 5	RAID 0	$m \geq n - 1$
	RAID 1	** Not a valid combination **
	RAID 0+1	$m \geq 2 \times (n - 1)$; where m is an even number of disks.
	RAID 5	$m \geq n$

Instructions

Click **Migrate array** to start the Migrate Array Wizard and then follow instructions. You can press **F1** to access the online help that walks you through the Wizard with step-by-step instructions.

View Storage Information

- You can use the Storage page to view the following storage information about the hard drives in your system:
 - Which RAID arrays are set up
 - The process state of each array
 - Which drives are configured for each RAID array in your system
 - Which drives are designated as free disks
 - Information about each drive, such as size and model
- You can also launch various Wizards-such as the Create Array Wizard, Delete Array, and Migrate Array Wizard-from the list of links in the Related tasks section of the side menu.

Instructions

Click **View Storage Configuration** to open the associated page.

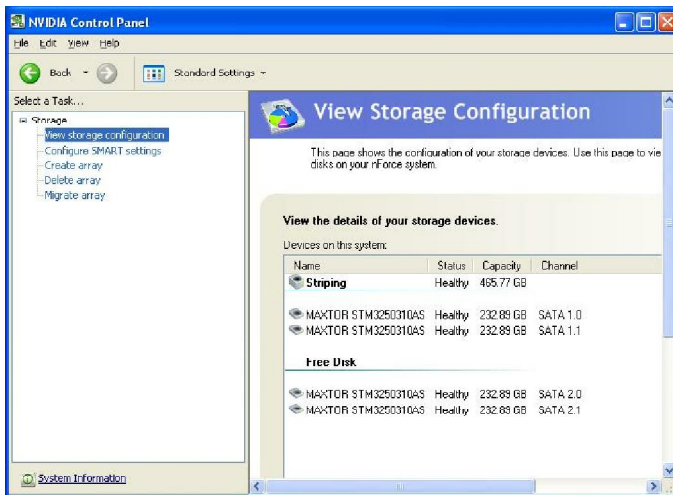

The View Storage Configuration page provides the following information:

- Name:** Indicates the RAID array type and drive model information
- Status:** Indicates the process state of the array.
For example, "Healthy", "Rebuilding", "Initializing", "Synchronizing", or "Upgrading"
- Capacity:** Indicates the size of each hard drive.
For example, "250 GB"
- Channel:** Indicates the adapter and channel (SATA port) information for each hard drive.
For example, "1.0." means the hard drive is attached to Adapter 1, Channel 0.

Appendix C

JMicron RAID Introduction

This appendix will assist users in configuring and enabling RAID functionality on platforms
The JMicron RAID solution supports RAID level 0 (striping), RAID level 1 (mirroring), RAID level 10 (striping and mirroring) and JBOD (Concatenate).

Introduction

JMicron JMB363 offers RAID level 0 (Striping), RAID level 1 (Mirroring and Duplexing), RAID level 10 (A Stripe of Mirrors) and JBOD (Concatenate).

RAID 0 breaks the data into blocks which are written to separate hard drives. Spreading the hard drive I/O load across independent channels greatly improves I/O performance. RAID 1 provides data redundancy by mirroring data between the hard drives and provides enhanced read performance. RAID 10 Not one of the original RAID levels, multiple RAID 1 mirrors are created, and a RAID 0 stripe is created over these. JBOD provides a method for combining drives of different sizes into one large disk.



Important

The least number of hard drives for RAID 0, RAID 1 or JBOD mode is 2.

The least number of hard drives for RAID 10 mode is 4.

All the information/ volumes/ pictures listed in your system might differ from the illustrations in this appendix. And this mainboard supports RAID 0/ RAID 1 or JBOD mode only.

JMicron RAID BIOS Utility

Be sure to set **RAID** mode for the **JMicron 36x ATA Controller** in BIOS before configuring the JMicron BIOS utility. After that, save the configuration and exit. During boot up (POST), press CTRL+J to enter the JMicron BIOS RAID utility.

The RAID Utility menu screen will be displayed. A brief description of each section is presented below.

```

JMicron Technology Corp.      PCIE-to SATA/IDE RAID Controller BIOS
[ Main Menu ]                [ Hard Disk Drive List ]

Create RAID Disk Drive
Delete RAID Disk Drive
Revert HDD to Non-RAID
Solve Mirror Conflict
Rebuild Mirror Drive
Save And Exit Setup
Exit Without Saving

HDD0: ST3120013AS           120 GB RAID Inside
HDD1: ST3120013AS           120 GB RAID Inside

Model Name      Capacity Type/Status

[ RAID Disk Drive List ]

Model Name      RAID Level      Capacity Status  Members(HDD#)
HDD0: JRAID     0-Stripe          240 GB Normal   01

[=>TAB]-Switch Window [F1]-Select ITEM [ENTER]-action [ESC]-Exit
  
```

Main Menu

- Create RAID Disk Drive - Create a new legacy RAID set.
- Delete RAID Disk Drive - Delete a legacy RAID set.
- Revert HDD to Non-RAID - Revert an existed-RAID HDD to non-RAID.
- Solve Mirror Conflict - Solve a mirror conflict.
- Rebuild Mirror Drive - Rebuild data, when RAID 1 or RAID 10 data mirroring is lost.
- Save And Exit Setup - Save all settings and exit the BIOS utility.
- Exit Without Saving - Exit the BIOS utility without any saving.

Hard Disk Driver List

The menu shows the model number and capacities of the drives physically attached to the SATA/IDE & PATA ports.

RAID Disk Driver List

The menu shows the current configuration of RAID set.

Creating RAID set

1. Select "Create RAID Disk Drive". Then press <Enter>.

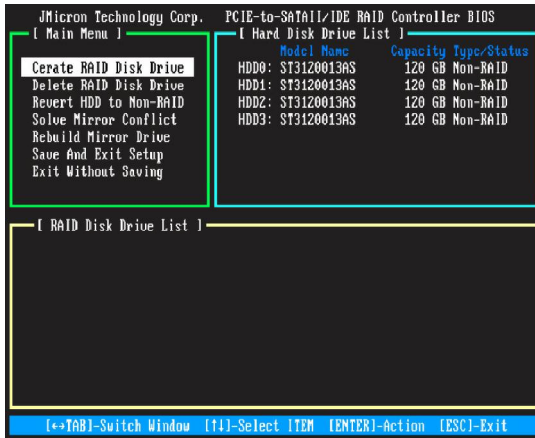

2. Then in the **Name** field, specify a RAID set name and then press the <Enter> to go to the next field.

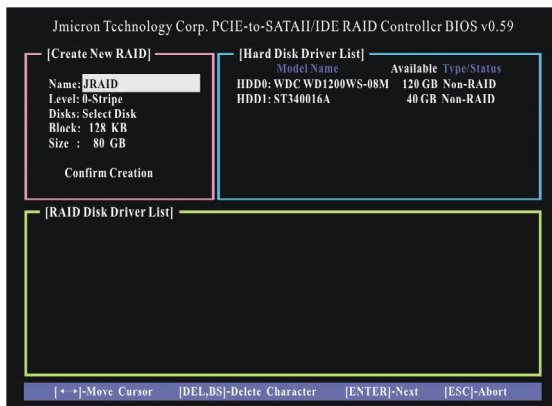

3. Choose a 0-Striped, a 1-Mirror, or a JBOD-Concatenate combination set and then press <Enter> to go to the next step.

4. In the **Hard Disk Disk List** menu, use <Space> key to select the disks you want to create for the RAID set, then click <Enter> key to finish selection.

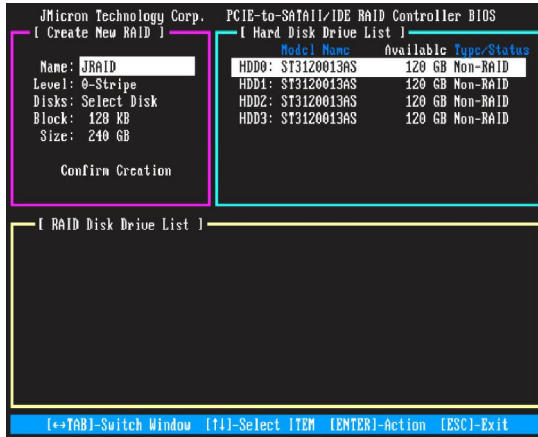

5. Then select the block value (stripe value) for the RAID array by using the "upper arrow" or "down arrow" keys to scroll through the available values, and pressing the <Enter> key to select and advance to the next field. The available values range from 4KB to 128 KB. The default and typical value for RAID 0 is 128KB. (This field only available for RAID 0 mode.)

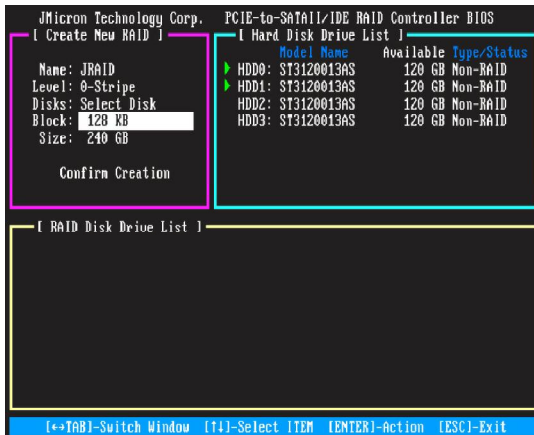

MS-7374 Mainboard

- Then select the capacity of the RAID set in the **Size** field. The default value is the maximum capacity of the selected disks. Then press <Enter> to the Confirm Creation field.
- The Creation field will display a message to ask you to confirm the creation. Then press <Y> key to proceed with the RAID set creation.

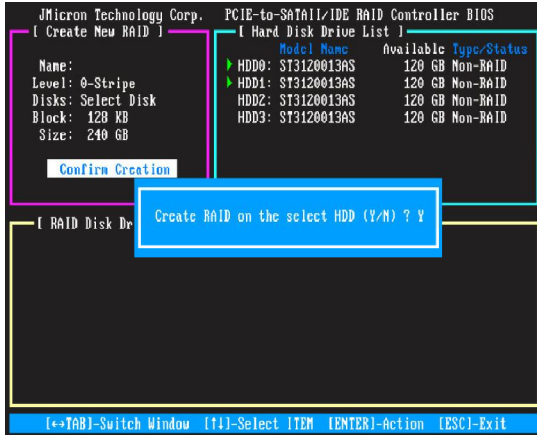

- Then the following screen appears to indicate that the creation is finished.

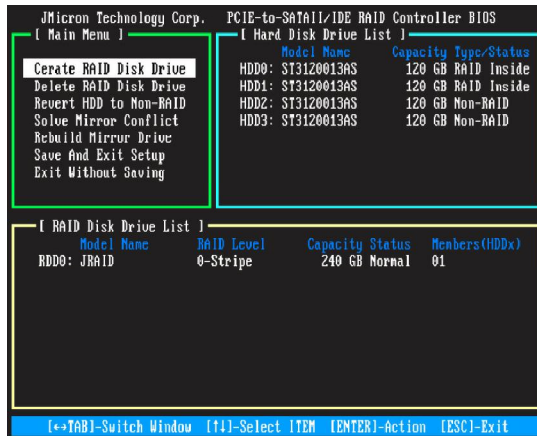

- Go to the Save And Exit Setup field and press <Enter>, a message will display to ask you to confirm the setup. Then press <Y> key to save the setting and exit the BIOS utility.

Deleting RAID set

1. Select "Delete RAID Disk Drive". Then press <Enter>.

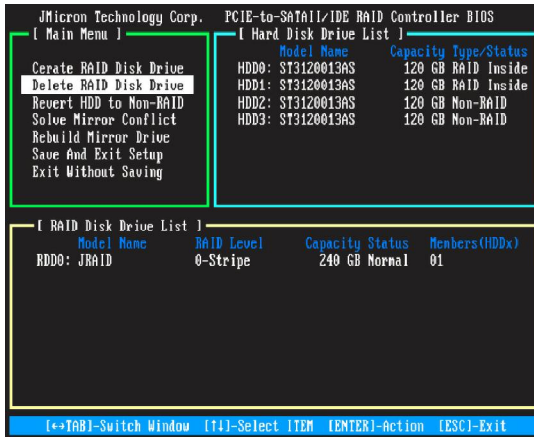

2. In the RAID Disk Driver List menu, use <Space> key to select the RAID set you want to delete. Then press key.
3. Press "Y" to accept the deletion when a deletion message is appeared.

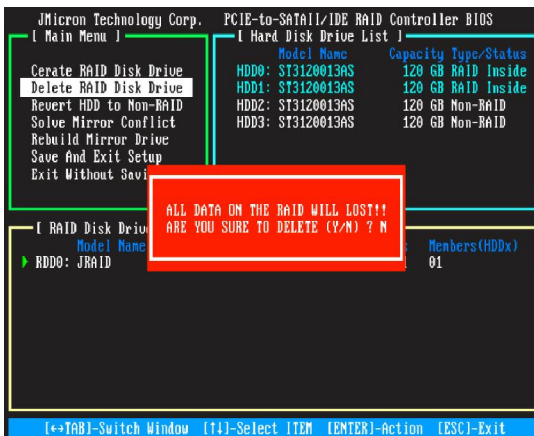

Revert HDD to non-RAID

Select **Revert HDD to non-RAID** and press <Enter>. In the Hard Disk Drive List menu use <Space> key to select the disks you want to revert then click <Enter> key. The following screen appears, press <Y> key to remove any RAID structures from the drives.

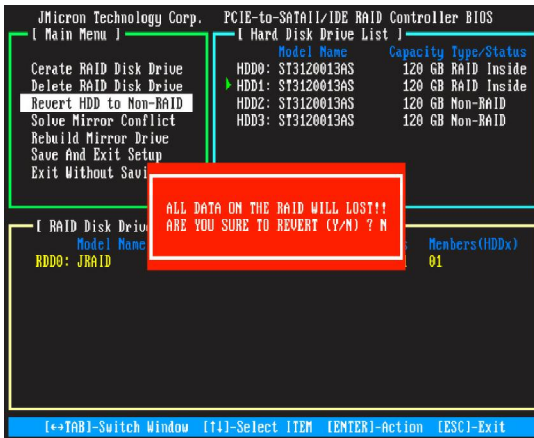

Important

1. You will lose all data on the RAID drives and any internal RAID structures when you perform this operation.
2. Possible reasons to 'Revert HDD to non-RAID' could include issues such as incompatible RAID configurations or a failed volume or failed disk.

Solving a Mirror Conflict

A Mirror conflict occurs when both disks in a RAID 1 (Mirror) configuration are unplugged from the system in turn, then plugged in again. Since both disks contain exactly the same data, the system will be unable to determine which of the two is the source drive. This option allows you to set the source drive and rebuild the Mirror drive according to the contents of the source drive.

To solving a Mirror conflict:

Select **Solving a Mirror Conflict** and press <Enter>. In the Hard Disk Driver List menu use <Space> key to select the disks you want to set as source drive. Using the <TAB>, move to the RAID Disk Drive List menu and highlight the RAID set that you want to rebuild. Press to begin rebuilding the Mirror configuration.

A status bar at the bottom of the screen shows the progress of the rebuilding.

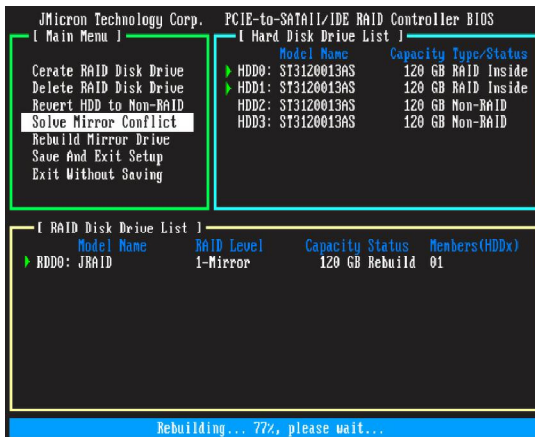

Rebuilding a Mirror drive

When one of the disk in a RAID 1 (Mirror) configuration is unplugged from the system, then plugged in again, a dialogue box appears to ask you to rebuild the Mirror drive. Press <Y> to confirm; otherwise, press <N>.

This option allows you to rebuild the Mirror drive later and synchronize the data between two hard disks.

To rebuild a Mirror drive:

Select **Rebuild Mirror Drive** and press <Enter>. Using the <TAB>, move to the RAID Disk Drive List menu and highlight the RAID set that you want to rebuild. Press to begin rebuilding the Mirror configuration.

A status bar at the bottom of the screen shows the progress of the rebuilding.

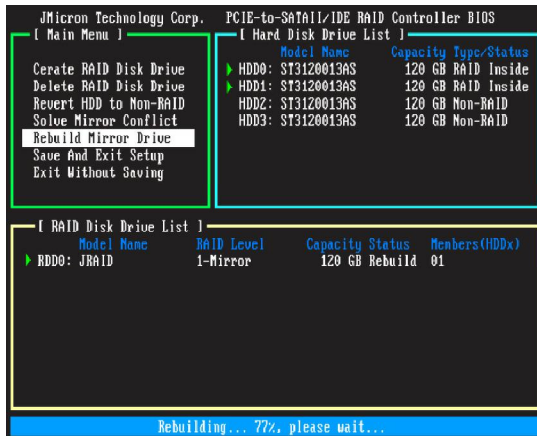

Installing Driver

Install Driver in Windows Vista / XP

† New Windows Vista / XP Installation

For Windows XP:.

1. When you start installing Windows XP and older operating systems, you may encounter a message stating, "Setup could not determine the type of one or more mass storage devices installed in your system". If this is the case, then you are already in the right place and are ready to supply the driver. If this is not the case, then press F6 when prompted at the beginning of Windows setup.
2. Press the "S" key to select "Specify Additional Device".
3. You should be prompted to insert a floppy disk containing the JMicon RAID driver into the A: drive.



Important

Please follow the instruction below to make an "**JMicon RAID Driver**" for yourself.

1. Insert the MSI CD into the CD-ROM drive.
2. Click the "Browse CD" on the Setup screen.
3. Copy all the contents in the
for XP: `\\nVidia\IDE\JMicon\JMB363\Floppy32` (for 32-bit OS) or **Floppy64** (for 64-bit OS) to a formatted floppy disk.
for Vista: `\\IDE\JMicon\Floppy32` (for 32-bit OS) or **Floppy64** (for 64-bit OS) to a medium (floppy disk/ CD/DVD or USB).
4. The driver diskette for **JMicon RAID Controller** is done.
4. When prompted, insert the floppy disk you created in step 3 and press Enter.
5. You should be shown a list of available SCSI Adapters.
6. Select the appropriate JMicon RAID controller and press ENTER.
7. The next screen should confirm that you have selected the JMicon RAID controller. Press ENTER again to continue.
8. You have successfully installed the JMicon RAID driver, and Windows setup should continue.
9. Leave the disk in the floppy drive until the system reboots itself. Windows setup will need to copy the files from the floppy again after the RAID volume is formatted, and Windows setup starts copying files.

For Windows Vista:

After selecting the location to install Windows Vista, please click on the "Load Driver" button to install the RAID driver. Please refer the **Important** notice above to make a RAID Driver medium. And then, follow the instructions to complete the RAID drive installation and the Windows Vista installation.

† **Existing Windows Vista/XP Driver Installation**

1. Insert the MSI CD into the CD-ROM drive.
2. The CD will auto-run and the setup screen will appear.
3. Under the Driver tab, click on ***JMicron JMB363 Drivers***.
4. The drivers will be automatically installed.

† **Confirming Windows Vista/XP Driver Installation**

1. From Windows Vista/XP, open the **Control Panel** from **My Computer** followed by the System icon.
2. Choose the **Hardware** tab, then click the **Device Manager** tab.
3. Click the "+" in front of the **SCSI and RAID Controllers** hardware type. The driver ***JMicron JMB36X Controller*** should appear.

JMicron RAID Configurer

There is an application called JM RAID Tool which helps you perform the following tasks of JMicron RAID.

- **Viewing RAID Array Configurations**
View an array configuration (mirrored, striped)
- **Creating RAID Arrays**
- **Deleting a RAID Array**
- **Rebuilding RAID Arrays**
- **Solving Mirror Conflict**

View RAID Array Configurations

Left-click the “Show Disks” button and the information of all hard disks will display on the right side of the window.



Left-click the name of the disk array and the information of all hard disks of the selected disk array will display on the right side of the window. The information of the disk array will also display on the lower-left part of the window.



Create RAID

JMRaidTool supports the creation of RAID 0, 1, 0+1 and JBOD.

1. Left-click the “Create Raid” button.
2. A CREATE RAID WIZARD dialogue will display on the screen, following the description of every step to complete the creation.



Create RAID from Existing Disk

You can combine the Existing Disk (Source disk may content OS and Data) with other HD (must be larger than source Disk) to be RAID. The data on Source Disk will be reserved. After RAID is built, system will need to reboot.

1. Left-Click the “Create RAID from Existing Disk” icon on the toolbar.
2. A “CREATING RAID FROM EXISTING DISK” wizard dialogue will display on the screen, following the description of every step to complete the creation.

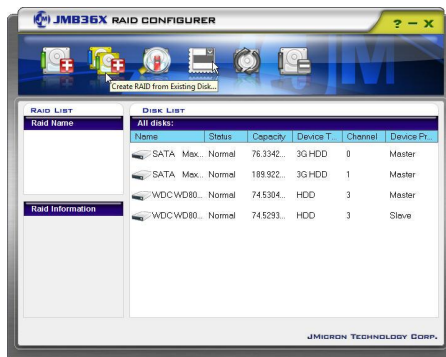

Remove RAID

There are two ways you can choose to remove RAID.

Way 1

1. Right-click the name of the disk array you want to delete and the "Remove" menu will appear. Select the "Remove Raid" of the pop-up menu.

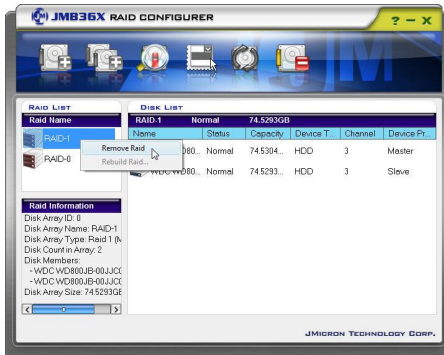

2. A warning message appears to remind you that the data will be lost. Press the "Yes" button if you really want to delete the disk array.

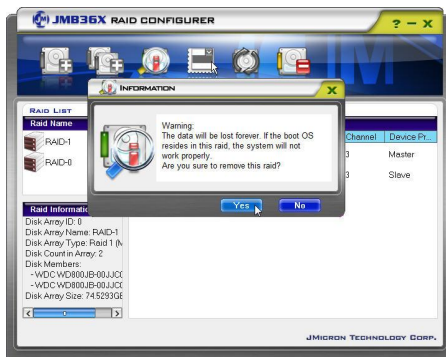

Way2

1. Left-Click the “Remove Raid” icon on the toolbar.
2. A “REMOVE RAID” wizard dialogue will display on the screen, following the description of every step to complete the deletion.

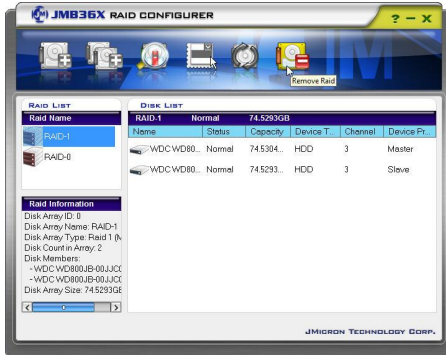

Rebuild RAID

RAID 1, 0+1 can be rebuilt while RAID 0, JBOD cannot be rebuilt. There are two ways you can choose to rebuild RAID.

Way 1

1. Right-click the name of the disk array you want to rebuild and the “Rebuild” menu will appear.

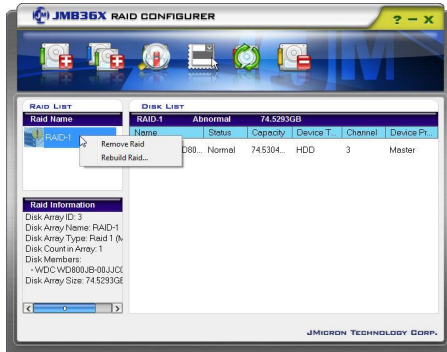

2. Select "Rebuild Raid".
3. A "REBUILD RAID WIZARD" dialogue will display on the screen, following the description of every step to complete the rebuilding.

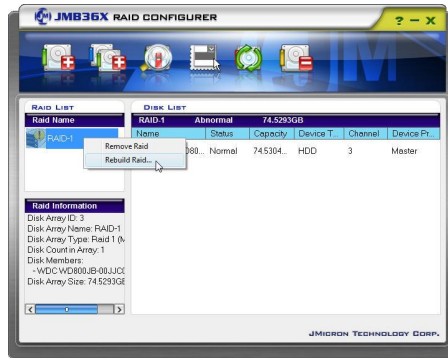

Way 2

1. If the disk array needs to rebuild then the rebuild button will be enabling on the toolbar.

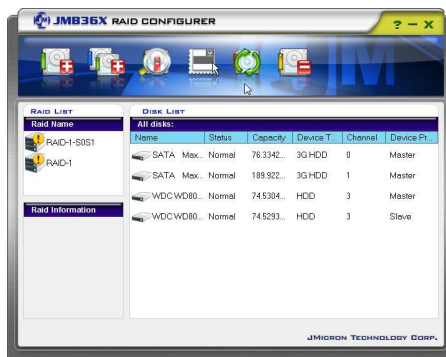

MS-7374 Mainboard

2. Left-Click the “Rebuild Raid” button on the toolbar.
3. A “REBUILD RAID WIZARD” dialogue will display on the screen, following the description of every step to complete the rebuilding.



Solve Mirror Conflict

If the conflict occurs, it will show the “REBUILDING RAID WIZARD” dialogue to ask you if you want to rebuild RAID, following the description of every step to rebuild the RAID.

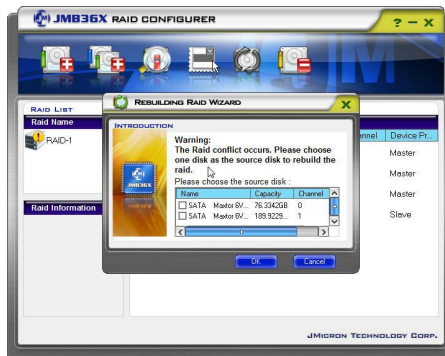

Appendix D

Dual Core Center

Dual CoreCenter, the most useful and powerful utility that MSI has spent much research and efforts to develop, helps users to monitor or configure the hardware status of MSI Mainboard & MSI Graphics card in windows, such as CPU/GPU clock, voltage, fan speed and temperature.

Before you install the Dual CoreCenter, please make sure the system has meet the following requirements:

1. Intel Pentium4 / Celeron, AMD Athlon XP/ Sempron or compatible CPU with PCI Express slot.
2. 256MB system memory.
3. CD-ROM drive for software installation.
4. Operation system: Windows XP.
5. DotNet Frame Work 2.0

Activating Dual Core Center

Once you have your Dual Core Center installed (locate the setup source file in the setup CD accompanying with your mainboard, path: **Utility --> MSI Utility --> Dual Core Center**), it will have an icon  in the system tray, a short cut icon on the desktop, and a short cut path in your "Start-up" menu. You may double-click on each icon to enable Dual Core Center.



short-cut icon in the system tray

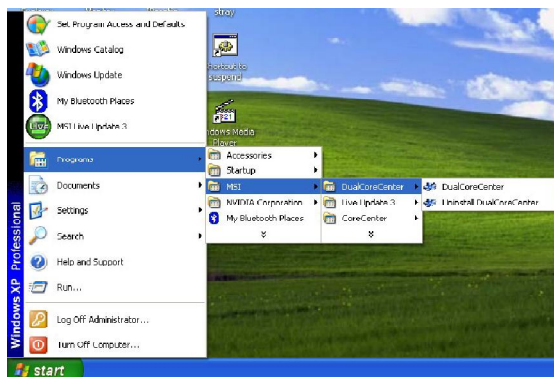

short-cut path in the start-up menu
(path: Start->Programs->MSI->DualCoreCenter->DualCoreCenter)

Main

Before using this utility, we have to remind you: only when installing the MSI V044 (V044 has to install with the version 8.26 or newer driver)/ V046 or V060 graphics card can activate the full function of this utility. If you install a graphics card of other brand, only hardware status of the MSI mainboard would be available.



Introduction:

Click each button appearing above to enter sub-menu to make further configuration or to execute the function.

MB

Click MB button to read current CPU temperature, FSB and CPU clock of mainboard will show below.

VGA

Click VGA button to read current GPU temperature, GPU clock and memory clock of graphics card will show below.

DOT

Click DOT button to enable or disable the Dynamic Overclocking Technology.

AV/ Game/ Office/ Silence/ Cool

MSI provides five common settings for different environments. The settings had been set to optimal values to reach better performance in each environment. Click the button you need.



Important

Before clicking the AV/ Game/ Office/ Silence or Cool button, select Smooth mode or Sharp mode to decide whether you want the system to reach the optimal values smoothly or quickly.

Sharp mode



Smooth mode

Clock



In this sub-menu, you can adjust and monitor the clocks of MB and graphics card.

Voltage



In this sub-menu, you can adjust and monitor the voltages of MB and graphics card.

FAN Speed



In this sub-menu, you can adjust and monitor the fan speeds of MB and graphics card.

Temperature



In this sub-menu, you can monitor the temperatures of MB and graphics card.

User Profile

In this sub-menu, you can set the values of clock, voltage and fan speed by your need and save them in a profile. You can save 3 profiles for further use.





Important

Click on the icon  , the clock, voltage, fan, and temperature buttons will appear beside the icon.



DOT (Dynamic OverClocking)

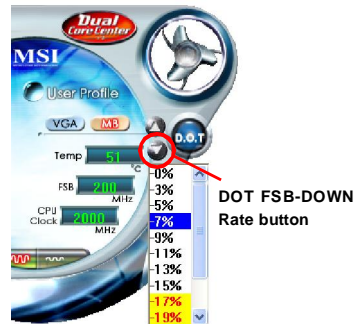
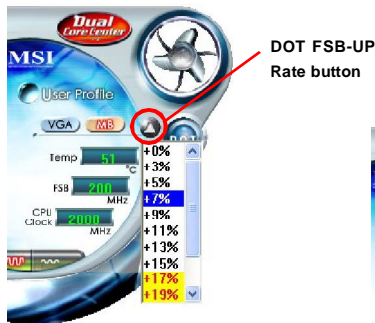

Dynamic Overclocking Technology is an automatic overclocking function, included in the MSI™'s newly developed Dual CoreCenter Technology. It is designed to detect the loading of CPU/ GPU while running programs, and to over-clock automatically. When the motherboard detects that the loading of CPU is exceed the default threshold for a time, it will speed up the CPU and fan automatically to make the system run smoother and faster. When the graphics card detects that the loading of GPU is exceed the default threshold for a time, it will speed up the GPU, memory, fan and voltage automatically to make the system run smoother and faster. When the CPU/ GPU is temporarily suspending or staying in low loading balance, it will restore the default settings instead. Usually the Dynamic Overclocking Technology will be powered only when users' PC runs huge amount of data, like 3D games or video process, and the motherboard/ graphicd card need to be boosted up to enhance the overall performance. There will be several selections when you click the DOT rate button (include increase rate  and decrease  rate buttons), to select the DOT level, then you have to click the DOT button  to apply the DOT function.



Important

Even though the Dynamic Overclocking Technology is more stable than manual overclocking, basically, it is still risky. We suggest user to overclock regularly first. If you find the PC appears to be unstable or reboot incidentally, it's better to lower the level of overclocking options. By the way, if you need to conduct overclocking manually, please do not to apply the DOT function.

Clock

In the **Clock** sub-menu, you can see clock status (including FSB/ CPU clock of mainboard and GPU/ memory clock of graphics card) of your system. And you can select desired value for overclocking. There will be several items for you to select for overclocking after you click  button. You can click the plus sign button  to increase the clock, or click the minus sign button  to decrease the clock. And finally, click the Apply button to apply the values adjusted. If you do not want to apply the adjustments, click the Cancel button to cancel. Or click the Default button to restore the default values.

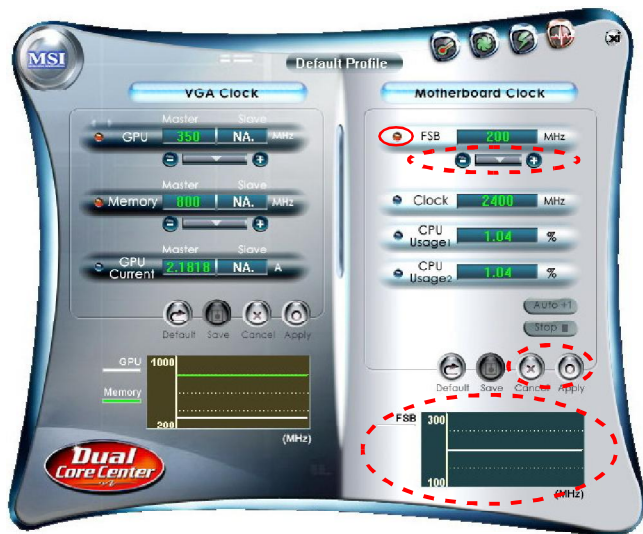



On the underside, it shows the graphs of the clocks. Only the curves of the item which the button is lit up with red color will be shown.



Important

*In the user profile, clicking the **Save** button can save the changes to it. In the default profile, the Save button is not available.*

Voltage

In the **Voltage** sub-menu, you can see voltage status (including Vcore, memory, GPU voltage... etc.) of your system, and you can select desired value for overclocking. It will show several items to select for overclocking after you click the  button. You can click the plus sign button  to increase the voltage, or click the minus sign button  to decrease. And finally, click the Apply button to apply the adjustments. If you do not want to apply the adjustments, click the Cancel button to cancel. Or click the Default button to restore the default values.

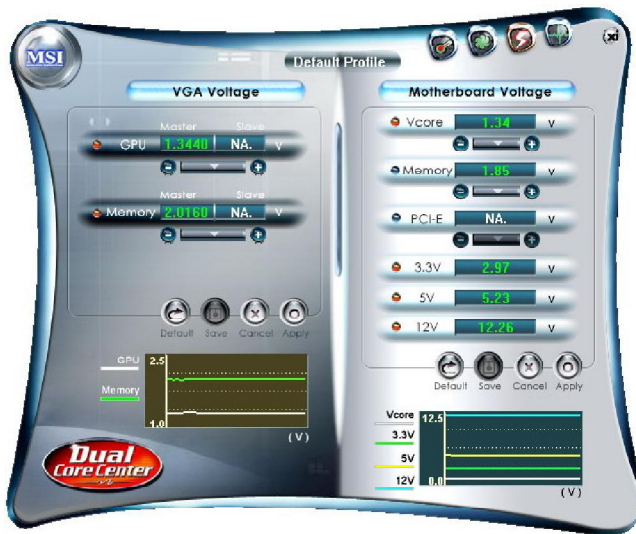



On the underside, it shows the graphs of the voltages. Only the curves of the item which the button is lit up with red color will be shown.



Important

*In the user profile, clicking the **Save** button can save the changes to it. In the default profile, the Save button is not available.*

FAN Speed

In the **FAN Speed** sub-menu, you can read fan status of your system. Select higher speed for better cooling effect. There are several sections for you to change the fan speed to a section after clicking  button. Click the plus sign button  to increase the fan speed to a section, or click the minus sign button  to decrease. Or click the Default button to restore the default values.

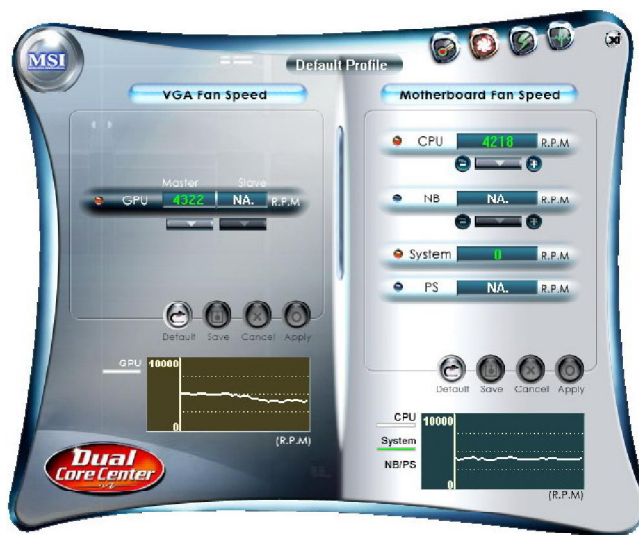

On the underside, it shows the graphs of the fan speed. Only the curves of the item which the button is lit up with red color will be shown.



Important

1. When you set the fan speed manually, please make sure to disabled the "CPU Smart FAN Target" item in the BIOS.
2. In the user profile, clicking the **Save** button can save the changes to it. In the default profile, the Save button is not available.

Temperature

In the **Temperature** sub-menu, you can see temperature status of your system.

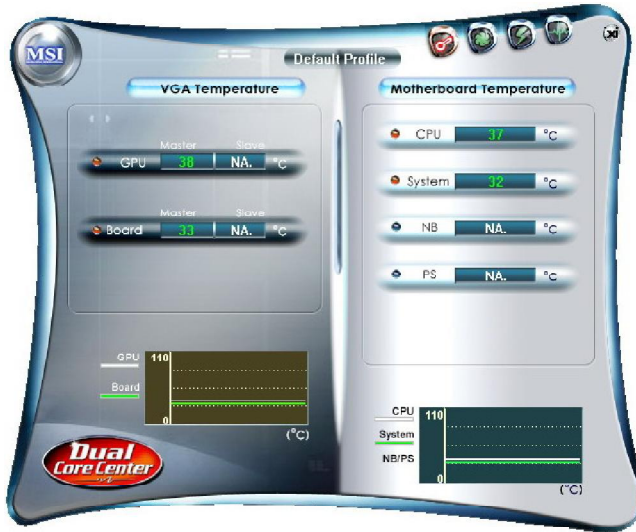



On the underside, it shows the graphs of the temperatures. Only the curves of the item which the button is lit with red color will be shown.

User Profile

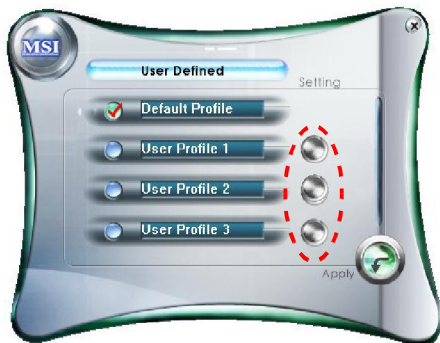
In the **User Profile** sub-menu, click the setting button that besides the user profile bar, and the next screen will appear.



Here you can define the clock/ fan speed/ voltage by your need, click the  button to choose a value quickly, or click the plus  / minus sign  button to increase/ decrease the value.



Use the draw bar to set the max system temperature. When the system temperature exceeds the threshold you defined, the system will pop up a warning message and shut down the system.

Use the draw bar to set the minimal fan speed. When the fan speed is lower than the threshold you defined, the system will pop up a warning message.



After setting all values you need, you can change the user profile name in the box then click the save button  to save all changes in a profile.

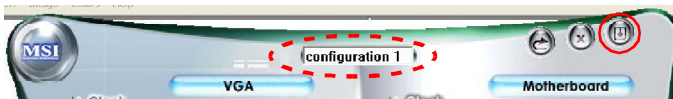

Finally, you can choose the user profile by click the button in the left side and click the Apply button to load the user profile.

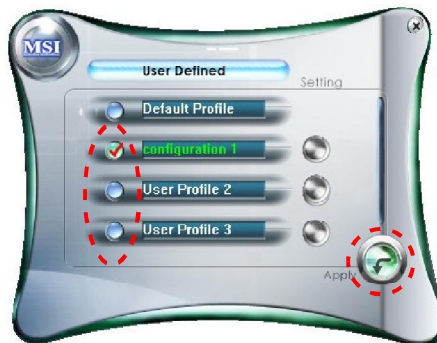

Free Manuals Download Website

<http://myh66.com>

<http://usermanuals.us>

<http://www.somanuals.com>

<http://www.4manuals.cc>

<http://www.manual-lib.com>

<http://www.404manual.com>

<http://www.luxmanual.com>

<http://aubethermostatmanual.com>

Golf course search by state

<http://golfingnear.com>

Email search by domain

<http://emailbydomain.com>

Auto manuals search

<http://auto.somanuals.com>

TV manuals search

<http://tv.somanuals.com>