

NuIPC
cPCI-6760DK/P5
6U CompactPCI Highly Integrated Single Slot
Dual Bridge Low Power Pentium-III CPU Module
User's Guide



Recycled Paper

© Copyright 2001 ADLINK Technology Inc.

All Rights Reserved.

Manual Rev. 1.00: September 9, 2002

Part No. 50-15008-100

The information in this document is subject to change without prior notice in order to improve reliability, design and function and does not represent a commitment on the part of the manufacturer.

In no event will the manufacturer be liable for direct, indirect, special, incidental, or consequential damages arising out of the use or inability to use the product or documentation, even if advised of the possibility of such damages.

This document contains proprietary information protected by copyright. All rights are reserved. No part of this manual may be reproduced by any mechanical, electronic, or other means in any form without prior written permission of the manufacturer.

Trademarks

NuIPC is a registered trademark of ADLINK Technology Inc.

Other product names mentioned herein are used for identification purposes only and may be trademarks and/or registered trademarks of their respective companies.

Getting service from ADLINK

- Customer Satisfaction is the most important priority for ADLINK Tech Inc. If you need any help or service, please contact us.

ADLINK Technology Inc.			
Web Site	http://www.adlinktech.com		
Sales & Service	Service@adlinktech.com		
Technical Support	NuDAQ + USBDAQ	nudaq@adlinktech.com	
	Automation	automation@adlinktech.com	
	NuIPC	nuipc@adlinktech.com	
	NuPRO / EBC	nupro@adlinktech.com	
TEL	+886-2-82265877	FAX	+886-2-82265717
Address	9F, No. 166, Jian Yi Road, Chungho City, Taipei, 235 Taiwan.		

- Please email or FAX us of your detailed information for a prompt, satisfactory and constant service.

Detailed Company Information			
Company/Organization			
Contact Person			
E-mail Address			
Address			
Country			
TEL		FAX	
Web Site			
Questions			
Product Model			
Environment to Use	OS: Computer Brand: M/B: CPU: Chipset: BIOS: Video Card: Network Interface Card: Other:		
Detail Description			
Suggestions to ADLINK			

Table of Contents

List of Tables	iii
Chapter 1 Introduction.....	1
1.1 Checklist.....	1
1.2 Description	3
1.3 Features	4
1.4 Specifications	4
1.4.1 Specifications of the cPCI-6760DK/P5.....	4
1.4.2 Peripheral Connectivity for cPCI-6760DK/P5	9
1.5 Functional Block Diagram	10
1.6 Mechanical outline drawing.....	11
1.6.1 Outline drawing for cPCI-6760DK/P5 CPU board.....	11
Chapter 2 Jumpers and Connectors	12
2.1 Jumpers, Connectors and LED Indicators on the cPCI-6760DK/P5	16
2.1.1 JP1 on cPCI-6760DK/P5	17
2.1.2 Keyboard and Mouse Combo Connector (CN4) on the cPCI-6760DK/P5	17
2.1.3 Ethernet Connectors (CN6, 7).....	18
2.1.4 Serial Port COM1 Connector (CN1).....	18
2.1.5 VGA Connector (CN3).....	18
2.1.6 USB (Port A) Connector (CN5).....	18
2.1.7 Secondary IDE Connectors (44-pin, CN2).....	19
2.1.8 Primary IDE Interface (40-pin, CN11).....	20
2.1.9 Parallel Port Connector on DB-6760J3 (CN9).....	21
2.1.10 FDD Interface (34-pin, CN10).....	21
2.1.11 Ping header P3 Pin Assignments	22
2.1.11 CompactPCI J1 Pin Assignments.....	23
2.1.12 CompactPCI J2 Pin Assignments.....	24
2.1.13 CompactPCI J4 Pin Assignments.....	25
2.1.14 CompactPCI J5 Pin Assignments.....	26
2.1.15 LAN Port Indicators (Integrated in LAN1 (CN6) and LAN2 (CN7)).....	27
2.1.16 IDE Activity LED Indication.....	28
2.1.17 Power LED Indication	28
2.1.18 WDT LED Indication	28

Chapter 3 Getting Started.....	29
3.1 CPU Installation.....	30
3.2 Memory Installation	30
3.3 CF Installation	31
3.3.1 <i>DB-6760CF Outline, Jumper and Connectors</i>	<i>32</i>
3.3.2 <i>DB-6760CF Installation for cPCI-6760DK/P5 and CF card notice</i>	<i>33</i>
3.3.3 <i>Removing the DB-6760CF from the cPCI-6760DK/P5</i>	<i>33</i>
3.4 HDD Installation	34
3.4.1 <i>HDD/FFD Installation for cPCI-6760DK/P5</i>	<i>34</i>
3.4.2 <i>Removing HDD/FFD from cPCI-6760DK/P5.....</i>	<i>35</i>
3.5 Device Connection for OS Installation.....	35
3.5.1 <i>Using the cPCI-6760DK/P5 with ADLINK's cBP-6108 and 6515 series backplane.....</i>	<i>35</i>
3.5.2 <i>Using the cPCI-6760DK/P5 on other backplanes.....</i>	<i>35</i>
3.6 Notice for Rear I/O Connection	36
3.6.1 <i>The I/O implementation is only supported by rear I/O board ...</i>	<i>36</i>
3.6.2 <i>The I/O implementation is supported by both rear I/O and front I/O</i>	<i>36</i>
3.6.3 <i>LAN1, LAN2 Front and Rear I/O Connecting Selection</i>	<i>37</i>
Chapter 4 Driver Installation	38
4.1 VGA Drivers Installation	39
4.1.1 <i>Driver Installation on Windows 2000</i>	<i>39</i>
4.1.2 <i>Driver Installation on Windows 98</i>	<i>40</i>
4.1.3 <i>Driver Installation on Windows NT.....</i>	<i>41</i>
4.2 LAN Drivers Installation.....	42
4.2.1 <i>Software and Drivers Support.....</i>	<i>42</i>
4.2.2 <i>Driver Installation on Windows 2000</i>	<i>42</i>
4.2.3 <i>Driver Installation on Windows 98</i>	<i>43</i>
4.2.4 <i>Driver Installation on Windows NT.....</i>	<i>44</i>
Chapter 5 Watchdog and Utilities.....	45
5.1 Watchdog Timer Configuration	45
5.1.1 <i>WDT Programming.....</i>	<i>46</i>
5.1.2 <i>How to Test the WDT?</i>	<i>46</i>
5.2 Hardware Doctor Utility.....	47
5.3 Intel Preboot Execution Environment (PXE).....	48
5.4 Intel Adapter Teaming	49
Warranty Policy	50

List of Tables

Table 1:	cPCI-6760DK/P5 functional table	3
Table 2:	Peripheral Connectivity for cPCI-6760DK.....	9
Table 3:	JP1 Clear CMOS content.....	17
Table 4:	Keyboard/Mouse Combo Connector (CN4) on cPCI-6760DK/P5 front board	17
Table 5:	Ethernet Connector LAN1 (CN6) and LAN2 (CN7) on cPCI-6760DK/P5 front board	18
Table 6:	Serial Port COM1 (CN1) on cPCI-6760DK/P5 front board.....	18
Table 7:	VGA Connector (CN3) on cPCI-6760DK/P5 front board	18
Table 8:	USB Connector (CN5) on cPCI-6760DK/P5 front board.....	18
Table 9:	Primary IDE channel (CN11) on DB-6760J3	20
Table 10:	Parallel Ports LPT1 (CN9) on DB-6760J3	21
Table 11:	FDD Interface (CN3) on DB-6760J3	21
Table 12:	Ping header P3 pin assignments on cPCI-6760DK and DB-6760J3.....	22
Table 13:	CompactPCI J1 pin assignments.....	23
Table 14:	CompactPCI J2 Pin Assignments.....	24
Table 15:	CompactPCI J4 pin assignments.....	25
Table 16:	CompactPCI J5 pin assignments.....	26
Table 17:	Amber LED indication in LAN port	27
Table 18:	Green LED indication in LAN port.....	27
Table 19:	IDE Activity LED indication	28
Table 20:	Power LED indication	28
Table 21:	WDT LED indication	28
Table 22:	JP1 DB-6760CF Master/Slave Setting.....	32
Table 23:	LAN1 Connecting Selection.....	37
Table 24:	LAN2 Connecting Selection.....	37

1

Introduction

This manual is designed to give you information on the cPCI-6760DK/P5 single board computer module. The topics covered in this chapter are as follows:

- Checklist
- Descriptions
- Features
- Specifications
- Functional block diagram
- Mechanical outline drawing

1.1 Checklist

The default version of cPCI-6760DK/P5 includes pre-installed 64MB RAM and CF card socket. However, the CPU module may be equipped with different capacity of RAM or HDD by request. Please check your configurations with your dealer and check that your package is complete and contains the items below. If you discover damaged or missing items, please contact with your dealer.

- The cPCI-6760DK/P5 SBC (May be equipped with different capacity of RAM or HDD. Those items may vary according to the different configuration request. The CPU is pre-soldered and the CPU heatsink is pre-mounted.)
- One 2.5" ATA HDD accessory pack (P/N: 58-00023-000) including special designed 44-wire connection cable and screw kit. (This accessory pack will not be available if 2.5" ATA HDD is pre-mounted by request.)

- One DB-6760CF removable CompactFlash socket adaptor (which is pre-mounted on the CPU module for the standard configuration delivery. The DB-6760CF may not be included if customer request pre-configuring 2.5" ATA HDD or by OEM project request.)
- Y cable for PS/2 keyboard and mouse connection. (P/N: 30-01016-000)
- This User's Manual
- ADLINK CD

Note: The delivery package of the cPCI-6760DK/P5 OEM version (non-standard configuration, functionality, customized logo, modified faceplate or package) may vary according to the different customization request.

1.2 Description

ADLINK's cPCI-6760DK/P5 is a powerful and flexible CompactPCI host slot processor board based on the Intel BGA2 Mobile (or Low Voltage) Pentium III processor. This board is specially designed to add total system functional density to ADLINK's 6U CompactPCI platform for CTI and Telecom applications. It is also suitable for clustering high-availability, high-density and high-reliability embedded applications where performance and a rich feature set are mandatory.

The CPU module uses the well-proven Intel 440BX chipset, which supports a processor front side bus (FSB) running at 100MHz and PC-100 SDRAM up to 512MB, making the cPCI-6760DK/P5 performs outstand from its peers. Moreover, the Embedded Intel Architecture guarantees long life availability. The highly integrated design makes the cPCI-6760DK/P5 fully functional within only single slot space. User can access RS-232, AGP-VGA, LPT, USB, Keyboard, Mouse and Dual Ethernet ports on the front panel.

cPCI-6760DK/P5 functional Table

Model	cPCI-6760DK/P5
Processor	Intel BGA2 Pentium-III 500MHz
Processor FSB	100 MHz
Chipset	Intel 440BX
Memory Size	Up to 512MB, Pre-installed 64MB
Memory Type	PC-100 SDRAM in 144-pin SO-DIMM
Graphic	SMI SM721
Video Memory	Build-in SM721 4MB VRAM
Serial Port	1
Parallel Port	1
USB	1
Ethernet Port	2 Ports (Intel 82559)
EIDE	2 UDMA-33 channels*
FDD I/F	Yes
Flash Storage	Removable CompactFlash Socket
cPCI Slots Support	14 slots, all bus mastering

Table 1: cPCI-6760DK/P5 functional table

1.3 Features

- PICMG 2.0 CompactPCI Specification R.3.0 Compliant
- PICMG 2.7 CompactPCI Dual System Bus specification R1.0 compliant
- Standard 6U form factor, 1-slot (4TE/HP) width
- Pre-mounted low voltage BGA2 Pentium-III 500MHz CPU with 100MHz FSB
- Pre-installed 64MB 144-pin SO-DIMM PC-100 RAM, support up to 512MB
- Build-in housing for 2.5" low profile HDD
- Supports up to 1 USB ports, 1 serial port, 1 parallel port, 1 floppy interface
- Supports 14 bus-master PCI devices on CompactPCI bus peripheral slots
- On-board high performance AGP 2x VGA display output by SMI SM721 controller
- Supports up to dual 10/100Mb Ethernet ports
- Supports Intel pre-boot execution environment (PXE) for boot from LAN
- Pre-installed CompactFlash type-II socket via removable daughter board
- Supports remote console on Serial ports

1.4 Specifications

1.4.1 Specifications of the cPCI-6760DK/P5

General CompactPCI Features

- PCI Rev.2.1 compliant
- PICMG 2.0 CompactPCI Specification R.3.0 Compliant
- PICMG 2.7 CompactPCI Dual System Bus specification R1.0 compliant

Form Factor

- Standard 6U CompactPCI (board size: 233.35mm x 160mm)
- 1-slot (4 TE/HP, 20.32mm) width, incl. housing of 2.5" HDD

CPU/Cache

- Intel BGA2 Low Voltage Pentium III with 256KB on-die L2 cache @ 500MHz speed & 100MHz FSB

4 · Introduction

Chipset

- Intel 440BX AGPset
- Intel 82443BX and 82371EB(PIIX4E)

BIOS: Award PnP BIOS

- BIOS write protection, provide anti-virus capability
- On-board Ethernet disable selectable
- DMI BIOS Support: Desktop Management Interface (DMI) allows users to download system hardware-level information such as CPU type, CPU speed, internal/external frequencies and memory size.
- Supports Intel pre-boot execution environment (PXE) for boot from LAN
- Remote Console: setup console redirection to serial ports (terminal mode) with CMOS setup access

Note: Due to the BIOS segment limitation, enable the remote console function may occupy the same memory space for other ROM-mapping add-on or boot-up devices such like Pre-boot Agent of Ethernet Boot ROM, SCSI Boot ROM or add-on EIDE Boot ROM. It is recommended to enable only one ROM-mapping add-on or boot-up device when enable the remote console function.

Host Memory

- Two 144-pin SO-DIMM sockets, Max. 512MB PC-100 un-buffered SDRAM
- Pre-installed 64MB PC-100 SD-RAM on SO-DIMM socket

IDE Ports

- Bus Master IDE controller supports two EIDE interfaces by DB-6760J3 (40-pin) and onboard 44 pin IDE connector for up to four IDE devices, including HDD and ATAPI CD-ROM drives. 44-pin secondary EIDE connector supports on-board 2.5" notebook size HDD or Flash2000™ flash disk.
- One CompactFlash type-II socket on removable daughter board for front CPU module.

Note: CompactFlash daughter board (DB-6760CF) occupies the same space of 2.5" ATA HDD. cPCI-6760DK/P5 supports on-module one 2.5" ATA HDD or one CompactFlash socket, but not both.

On Board Super I/O

- Winbond W83977EF
- Supports high-speed bi-directional SPP/EPP/ECP parallel ports (DB-25 connector) on front panel with ESD protection to 4KV and downstream device protection to 30V.
- One floppy interface by daughter board (DB-6760J3), support two floppy drives (360KB, 720KB, 1.2MB, 1.44MB, 2.88MB.) 34-pin floppy connector is available on DB-6760J3.
- One 16C550 UARTs compatible RS-232 COM1 port with ESD protection to 2KV on front CPU module.

USB Interface

- Supports one USB ports.
- USB Specification Rev. 1.1. compliant
- Individual over-current protection

Watch-dog Timer

- Programmable I/O port 3F0h and 3F1h to configure watchdog timer, programmable timer 1~255 seconds or 1~255 minutes
- Bundled easy-programming library for DOS, Windows 95, 98, NT

Hardware Monitoring

- Winbond W83782D, monitoring CPU temperature, CPU fan, system temperature and DC Voltages

On-board VGA Display

- AGP 2x VGA controller SMI Lynx3DM SM721, with build-in 4M VRAM
- High performance, 128-bit, single clock cycle 2D drawing engine
- High performance, power managed 3D acceleration engine
- AGP 2x, ACPI, VESA DPMS and VESA DDC 2b compliant
- Supports up to 1280x1024 VGA display resolution with 24-bit true color, non-interlaced
- Supports up to 1600x1200 VGA display resolution with 16-bit high color at 60Hz refresh rate under WindowsNT^(note)
- RAMDAC Latch-up protection
- Driver supporting: Windows95/98/ME/NT/2000, Linux, OS/2

Note: The 1600x1200 VGA display resolution is a non-standard configuration. It needs special modified BIOS with drivers, which can ONLY be supported under Windows NT operating system. The BIOS may cause incompatible issues with other OS. The standard BIOS can support resolutions up to 1280x1024 under all operating systems listed above.

On-board Ethernet supporting

- Two Ethernet ports featuring by two Intel 82559 Ethernet controller.
- IEEE 802.3 10Base-T and 100Base-TX compatible
- IEEE 802.3u Auto-negotiation support
- IEEE 802.3x 100Base-TX flow control support
- Full duplex support at both 10 and 100 Mbps operation
- Supports Intel pre-boot execution environment (PXE) for boot from LAN
- Supports Intel adapter teaming functions including Fault Tolerance, Adaptive Load Balancing (ALB), Fast Ethernet Channel (FEC) and Link Aggregation.

OS Compatibility

- MS-DOS 6.2+, Windows 95/98/ME, Windows NT 4.0, Windows 2000, Windows XP, Red Hat Linux 7.2 and VxWorks

Flash Disk Supporting

- Pre-installed CompactFlash type-II socket by removable transition daughter board.
- On-board housing for Flash2000™ 2.5" flash disk on front CPU module

PCI Bus Bridge

- Dual TI PCI2050 transparent PCI to PCI bridge
- Supports up to 14 PCI bus mastering devices on CompactPCI bus peripheral slots

Front Panel LEDs and switch

- Power status (green)
- IDE activity indicator (red)
- Ethernet (integrated with RJ-45): 10/100Mb (amber), link and activity (green)
- Watchdog timer status indicator (amber)
- Flush tact switch for system reset

Environment

- Operating temperature: 0 to 60°C ^(Note)
- Storage temperature: -20 to 80°C
- Humidity: 5% to 95% non-condensed
- Shock: 15G peak-to-peak, 11ms duration, non-operation
- Vibration:
 - ✓ Non-operation: 1.88Grms, 5-500Hz, each axis
 - ✓ Operation: 0.5Grms, 5-500Hz, each axis, with 2.5" HDD

Note: 1. System forced cooling airflow with minimum 5 CFM is required for cPCI-6760DK/P5

2. Due to environmental limitation differences from one component to another; please refer to the component specification when users wishes to mount a HDD on to the cPCI-6760DK. The operating temperature was tested with the HDD cabling outside the testing chamber, and with a Low Voltage Pentium-III 500MHz CPU.

3. The vibration limitation of operation is caused by the 2.5" ATA HDD. If users wish to deploy the cPCI-6760DK/P5 into a high vibrating environment, we suggest users to adopt Flash2000 Flash Disk (FFD series) or CompactFlash Card to replace the 2.5" ATA HDD.

Safety Certificate and Test

- CE, FCC Class B
- HALT (temperature and vibration stress)

Power Consumption

Configurations	+5V	+3.3V	+12V	-12V
Low Power Pentium III 500MHz, 256MB with cPCI-R6760D	2.75A	3.5A	157mA	0mA

Note: The above values are the measured power consumption for SBC with CPU and RAM only; the CPU is running at 100% loading with HCT, Kpower and burn-in test programs under Windows 2000 Professional. The powers for all the other peripheral devices such as add-on cards, HDD, or CD-ROM are not included.

1.4.2 Peripheral Connectivity for cPCI-6760DK/P5

Peripheral Connectivity for cPCI-6760DK/P5

I/O	Front (cPCI-6760DK/P5)	
	Faceplate	Board
Serial Port (COM1)	Y (DB-9)	---
Parallel Port (via DB-6760J3)	Y (DB-25)	---
PS/2 Keyboard and Mouse	Y (PS/2)	---
Floppy (via DB-6760J3)	---	Y (34-pin)
Ultra DMA 33 Primary EIDE (Via DB-6760J3)	---	Y (40-pin)
Ultra DMA 33 Secondary EIDE	---	Y (44-pin)
USB A	Y	---
10/100Mb Ethernet Port 1	Y (RJ-45)	---
10/100Mb Ethernet Port 2	Y (RJ-45)	---
VGA	Y (DB-15)	---
LEDs	Y	---
Reset button	Y	---
CompactFlash (via daughter board)	---	Y (CF-II)

Table 2: Peripheral Connectivity for cPCI-6760DK

1.5 Functional Block Diagram

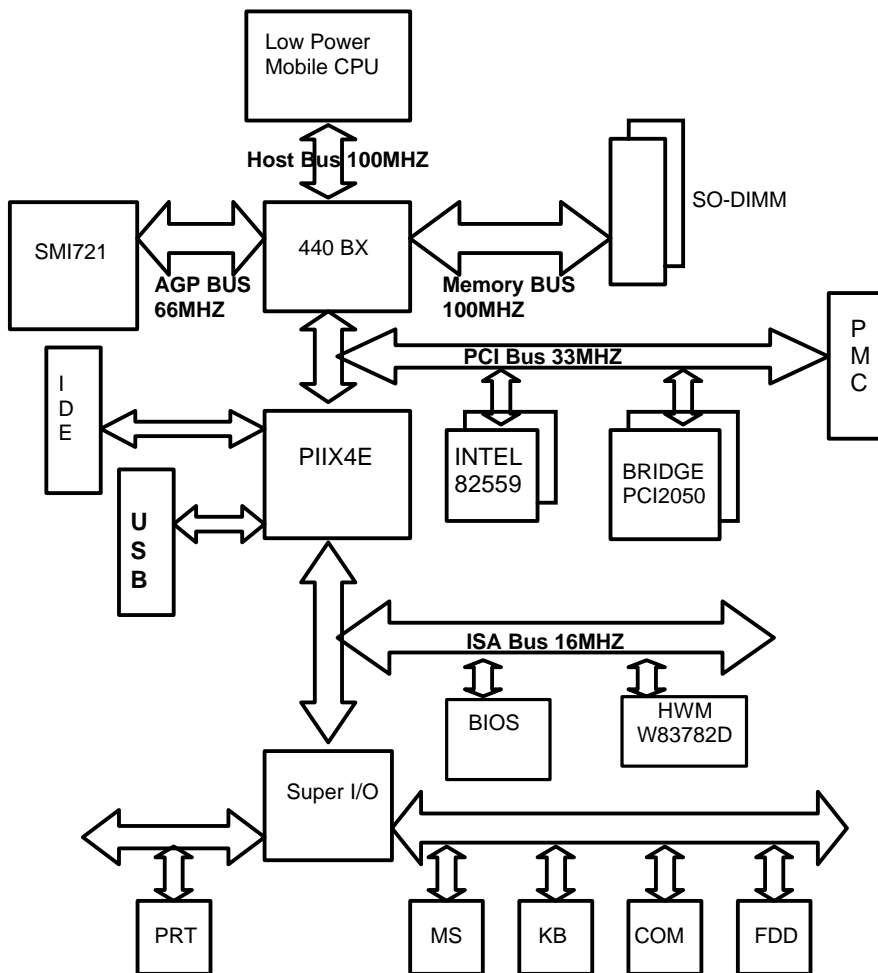

1.6 Mechanical outline drawing

1.6.1 Outline drawing for cPCI-6760DK/P5 CPU board

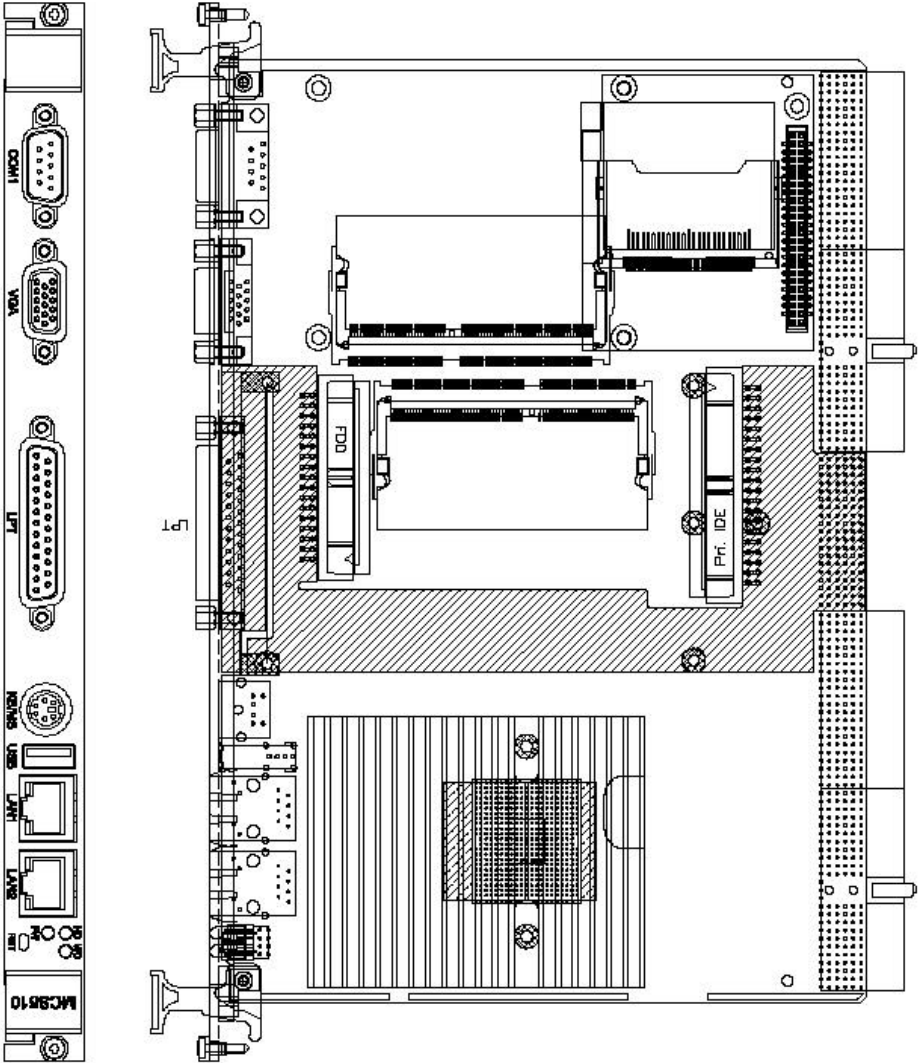

2

Jumpers and Connectors

This chapter provides information on how to use the jumpers and connectors on the cPCI-6760DK/P5 in order to set up a workable system. We also describe the meaning of each LED indicator. The topics covered are:

- Jumpers, Connectors and LED indicators on the cPCI-6760DK/P5

- Jumpers and connectors map of cPCI-6760DK/P5 series front board.
TOP View

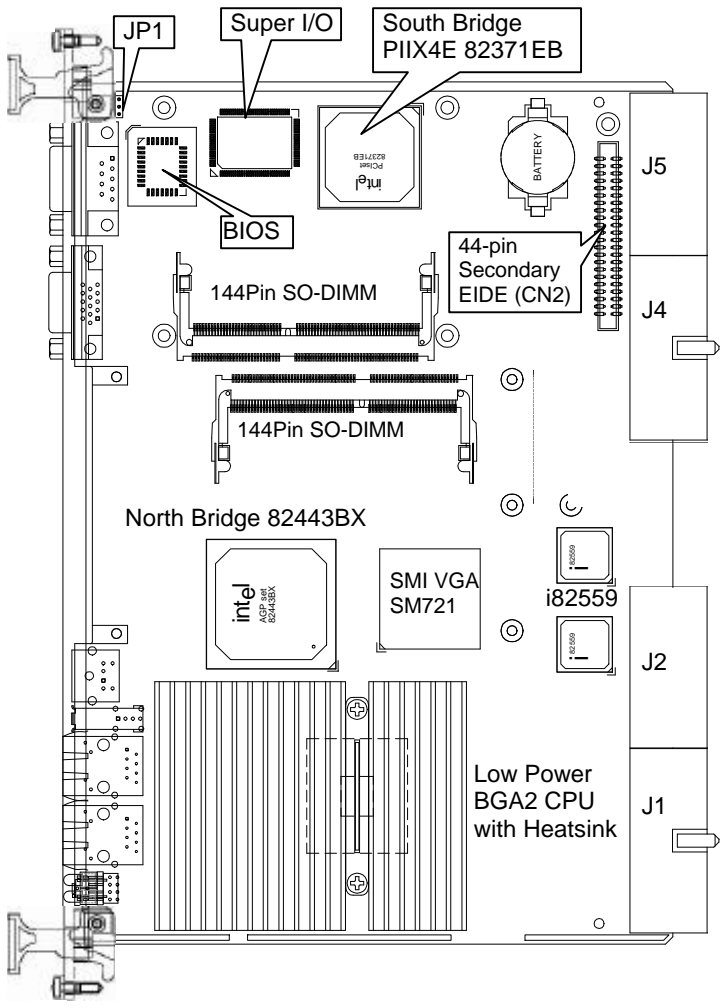

- Connectors map of cPCI-6760DK/P5 's daughter board (DB-6760J3).
TOP View

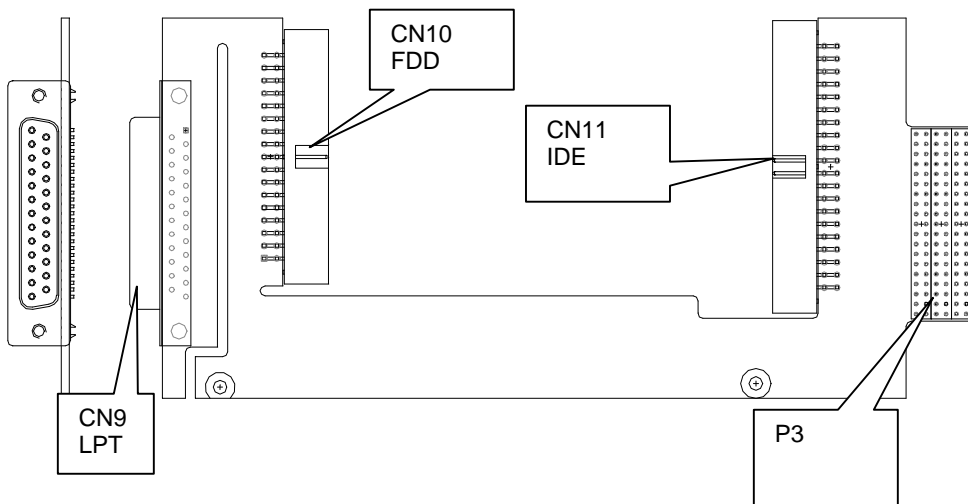

- Jumpers and connectors map of cPCI-6760DK/P5 series front board.
Bottom and Front Panel View

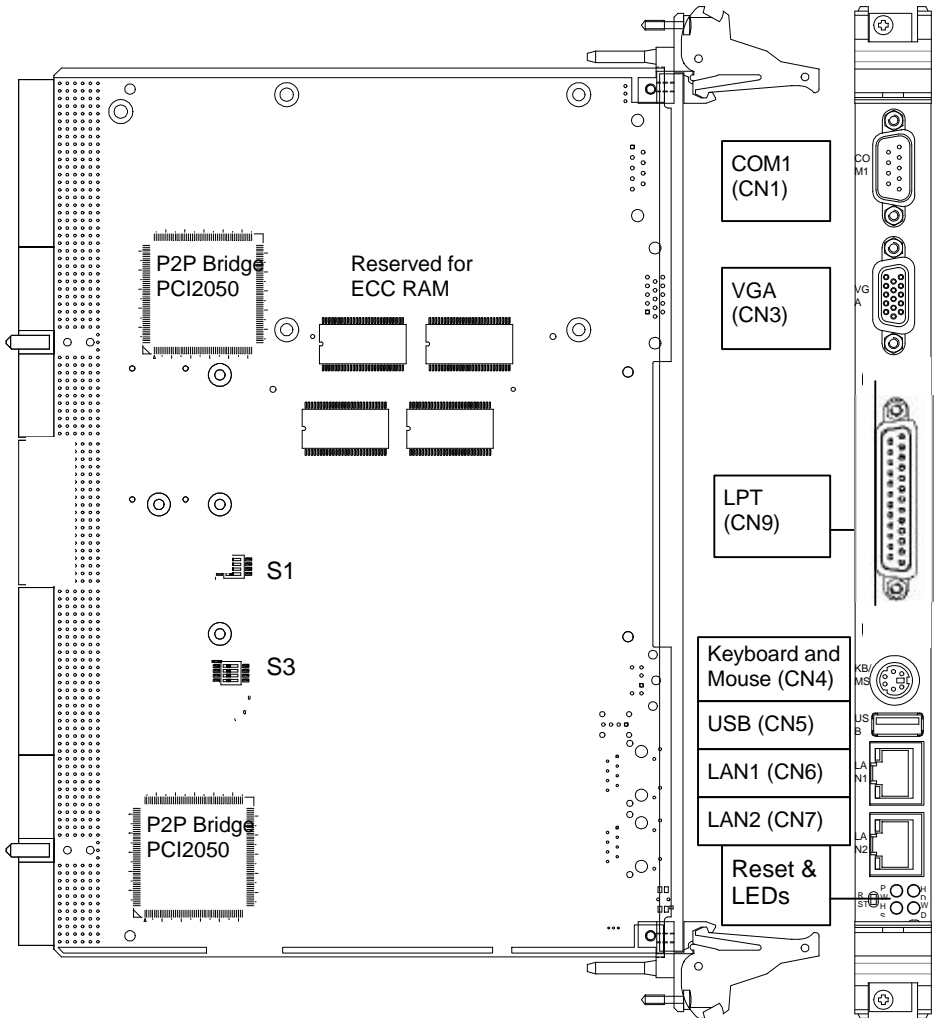

2.1 Jumpers, Connectors and LED Indicators on the cPCI-6760DK/P5

The jumpers on the cPCI-6760DK/P5 CPU board allow you to configure your CPU module according to the needs of your applications. If you have doubts about the best jumper configuration for your needs, contact your dealer or sales representative.

The connectors on the cPCI-6760DK/P5 CPU board allows you to connect devices such as keyboard, mouse, VGA, COM port, Ethernet etc.

The LED indicators on the cPCI-6760DK/P5 front board show you the information regarding to your system's status.

The following information lists the jumpers, connectors and LEDs on the cPCI-6760DK/P5 CPU board and their respective functions.

Jumpers Setting Information for cPCI-6760DK/P5 Front Board

2.1.1	<i>JP1 on cPCI-6760DK/P5</i>	17
-------	------------------------------------	----

Connector Pin Assignments Information for cPCI-6760DK/P5

2.1.2	<i>Keyboard and Mouse Combo Connector (CN4) on cPCI-6760DK/P5</i>	17
2.1.3	<i>Ethernet Connectors (CN6, 7)</i>	18
2.1.4	<i>Serial Port COM1 Connector (CN1)</i>	18
2.1.5	<i>VGA Connector (CN3)</i>	18
2.1.6	<i>USB (Port A) Connector (CN5)</i>	18
2.1.7	<i>Secondary IDE Connectors (44-pin, CN2)</i>	19
2.1.8	<i>Primary IDE Interface (40-pin, CN11)</i>	20
2.1.9	<i>Parallel Port Connector on DB-6760J3 (CN9)</i>	21
2.1.10	<i>FDD Interface (34-pin, CN10)</i>	21
2.1.11	<i>Ping header P3 Pin Assignments</i>	22
2.1.11	<i>compactPCI J1 Pin Assignments</i>	23
2.1.12	<i>compactPCI J2 Pin Assignments</i>	24
2.1.13	<i>compactPCI J4 Pin Assignments</i>	25
2.1.14	<i>compactPCI J5 Pin Assignments</i>	26

LED and Switch Setting Information for cPCI-6760DK/P5 Front Board

2.1.15	<i>LAN Port Indicators (Integrated in LAN1 (CN6) and LAN2 (CN7))</i>	27
2.1.16	<i>IDE Activity LED Indication</i>	28
2.1.17	<i>Power LED Indication</i>	28
2.1.18	<i>WDT LED Indication</i>	28

Note There are no jumper settings for front side bus (FSB) and CPU speed selection because the cPCI-6760DK/P5 is equipped with a pre-soldered BGA2 CPU that is mounted during SMT manufacturing.

2.1.1 JP1 on cPCI-6760DK/P5

JP1	Setting	Function
	Pin 1-2 Short/Closed	Clear CMOS Content
	Pin 2-3 Short/Closed	Normal Operation (Default)

Table 3: JP1 Clear CMOS content

2.1.2 Keyboard and Mouse Combo Connector (CN4) on the cPCI-6760DK/P5

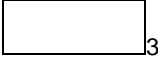
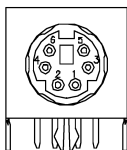

Pin #	Signal	Function
1	KBDATA	Keyboard Data
2	MSDATA	Mouse Data
3	GND	Ground
4	+5V	Power
5	KBCLK	Keyboard Clock
6	MSCLK	Mouse Clock

Table 4: Keyboard/Mouse Combo Connector (CN4) on cPCI-6760DK/P5 front board

Note: User can use a Y-cable for connecting PS/2 keyboard and mouse on this connector. User also can directly connect a PS/2 keyboard on this connector when mouse is not needed.

2.1.3 Ethernet Connectors (CN6, 7)

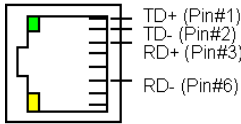

Pin #	Signal Name
1	TD+
2	TD-
3	RD+
6	RD-

Table 5: Ethernet Connector LAN1 (CN6) and LAN2 (CN7) on cPCI-6760DK/P5 front board

2.1.4 Serial Port COM1 Connector (CN1)

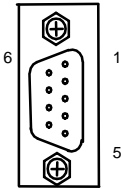

Pin #	Signal Name
1	DCD, Data carrier detect
2	RXD, Receive data
3	TXD, Transmit data
4	DTR, Data terminal ready
5	GND, ground
6	DSR, Data set ready
7	RTS, Request to send
8	CTS, Clear to send
9	RI, Ring indicator

Table 6: Serial Port COM1 (CN1) on cPCI-6760DK/P5 front board

2.1.5 VGA Connector (CN3)

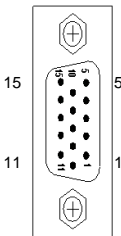

Signal Name	Pin	Pin	Signal Name
Red	1	2	Green
Blue	3	4	N.C.
GND	5	6	GND
GND	7	8	GND
+5V.	9	10	GND
N.C.	11	12	N.C.
HSYNC	13	14	VSYNC
NC	15		

Table 7: VGA Connector (CN3) on cPCI-6760DK/P5 front board

2.1.6 USB (Port A) Connector (CN5)

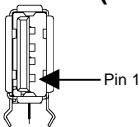

Pin #	Signal Name
1	Vcc
2	USB-
3	USB+
4	Ground

Table 8: USB Connector (CN5) on cPCI-6760DK/P5 front board

2.1.7 Secondary IDE Connectors (44-pin, CN2)

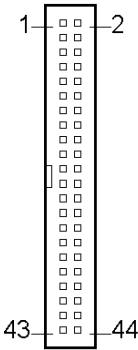

Signal	Pin #	Pin #	Signal
RESET-	1	2	Ground
DD7	3	4	DD8
DD6	5	6	DD9
DD5	7	8	DD10
DD4	9	10	DD11
DD3	11	12	DD12
DD2	13	14	DD13
DD1	15	16	DD14
DD0	17	18	DD15
Ground	19	20	(keypin)
DMARQ	21	22	Ground
DIOW-	23	24	Ground
DIOR-	25	26	Ground
IORDY	27	28	CSEL
DMACK-	29	30	Ground
INTRQ	31	32	reserved
DA1	33	34	PDIAG-
DA0	35	36	DA2
CS0-	37	38	CS1-
DASP-	39	40	Ground
+5V	41	42	+5V
Ground	43	44	TYPE-

2.1.8 Primary IDE Interface (40-pin, CN11)

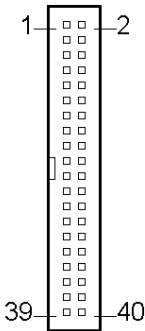

Signal	Pin #	Pin #	Signal
RESET-	1	2	Ground
DD7	3	4	DD8
DD6	5	6	DD9
DD5	7	8	DD10
DD4	9	10	DD11
DD3	11	12	DD12
DD2	13	14	DD13
DD1	15	16	DD14
DD0	17	18	DD15
Ground	19	20	NC
DMARQ	21	22	Ground
DIOW-	23	24	Ground
DIOR-	25	26	Ground
IORDY	27	28	CSEL
DMACK-	29	30	Ground
INTRQ	31	32	reserved
DA1	33	34	PDIAG-
DA0	35	36	DA2
CS0-	37	38	CS1-
DASP-	39	40	Ground

Table 9: Primary IDE channel (CN11) on DB-6760J3

2.1.9 Parallel Port Connector on DB-6760J3 (CN9)

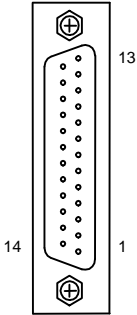

Signal Name	Pin #	Pin #	Signal Name
Line printer strobe	1	14	AutoFeed
PD0, parallel data 0	2	15	Error
PD1, parallel data 1	3	16	Initialize
PD2, parallel data 2	4	17	Select
PD3, parallel data 3	5	18	Ground
PD4, parallel data 4	6	19	Ground
PD5, parallel data 5	7	20	Ground
PD6, parallel data 6	8	21	Ground
PD7, parallel data 7	9	22	Ground
ACK, acknowledge	10	23	Ground
Busy	11	24	Ground
Paper empty	12	25	Ground
Select	13	N/A	N/A

Table 10: Parallel Ports LPT1 (CN9) on DB-6760J3

2.1.10 FDD Interface (34-pin, CN10)

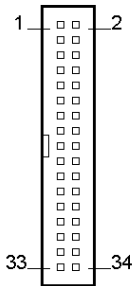

Signal	Pin #	Pin #	Signal
Ground	1	2	DRV DEN0
Ground	3	4	NC
NC	5	6	DRV DEN1
Ground	7	8	INDEX#
Ground	9	10	MTR0#
Ground	11	12	DS1#
Ground	13	14	DS0#
Ground	15	16	MTR1#
Ground	17	18	FDIR#
Ground	19	20	STEP#
Ground	21	22	WDATA#
Ground	23	24	WGATE#
Ground	25	26	TRACK0#
Ground	27	28	WPT#
Ground	29	30	RDATA#
Ground	31	32	HDSSEL#
Ground	33	34	DSKCHG#

Table 11: FDD Interface (CN3) on DB-6760J3

2.1.11 Ping header P3 Pin Assignments

Pin	Z	A	B	C	D	E	F
19	GND	PDRST#	PDCS16# ⁽¹⁾	PDIORDY	Reserved	PDIRQ14	GND
18	GND	PDACT#	Reserved	PDCS3#	PDCS1#	PPDIAG ⁽¹⁾	GND
17	GND	PDD15	PDD14	PDD13	PDD12	Reserved	GND
16	GND	PDD11	PDD10	PDD9	PDD8	PDDACK#	GND
15	GND	PDA0	PDA1	+5V	PDA2	PDDREQ	GND
14	GND	PDD7	PDD6	PDD5	PDD4	PDIOW#	GND
13	GND	PDD3	PDD2	PDD1	PDD0	PDIOR#	GND
12	GND	DS0#	DRV DEN1	MTR0#	INDEX#	WDATA#	GND
11	GND	DS1#	DSKCHG	MTR1#	DRV DEN0	RDATA#	GND
10	GND	WRT PRT#	HDSEL#	FDIR#	TRACK0#	STEP#	GND
9	GND	WGATE#	ERRORP#	AUTOFD	PBUSY	Reserved	GND
8	GND	PE	SLCTIN#	+5V ⁽⁴⁾	PSTROB#	Reserved	GND
7	GND	PPD7	PPD6	PPD5	PPD4	PINIT3	GND
6	GND	PPD3	PPD2	PPD1	PPD0	PACK#	GND
5	GND	Reserved	MSDATA ⁽¹⁾	PCBEEP ⁽¹⁾	KBDATA ⁽¹⁾	SLCT	GND
4	GND	Reserved	MSCLK ⁽¹⁾	+5V	KBCLK ⁽¹⁾	RXD1 ⁽¹⁾	GND
3	GND	CTS1# ⁽¹⁾	RTS1# ⁽¹⁾	DSR1# ⁽¹⁾	DCD1# ⁽¹⁾	TXD1 ⁽¹⁾	GND
2	GND	TDP1 ⁽¹⁾	TDN1 ⁽¹⁾	RI1# ⁽¹⁾	DTR1# ⁽¹⁾	TDN2 ⁽¹⁾	GND
1	GND	RDP2 ⁽¹⁾	RDN2 ⁽¹⁾	RDP1 ⁽¹⁾	RDN1 ⁽¹⁾	TDP2 ⁽¹⁾	GND
Pin	Z	A	B	C	D	E	F

Table 12: Ping header P3 pin assignments on cPCI-6760DK and DB-6760J3

Note:

- (1) These signals are used by the CPU board (J3) but not used in the DB-6760J3 (P3)

2.1.11 CompactPCI J1 Pin Assignments

Pin	Z	A	B	C	D	E	F
25	GND	+5V	REQ64# ⁽²⁾	ENUM# ⁽²⁾	+3.3V	+5V	GND
24	GND	S1AD[1]	+5V	V(I/O) ⁽¹⁾	S1AD[0]	ACK64#	GND
23	GND	+3.3V	S1AD[4]	S1AD[3]	+5V	S1AD[2]	GND
22	GND	S1AD[7]	GND	+3.3V	S1AD[6]	AD[5]	GND
21	GND	+3.3V	S1AD[9]	S1AD[8]	M66EN ⁽⁶⁾	S1C/BE[0]#	GND
20	GND	S1AD[12]	GND	V(I/O) ⁽¹⁾	S1AD[11]	S1AD[10]	GND
19	GND	+3.3V	S1AD[15]	S1AD[14]	GND	S1AD[13]	GND
18	GND	S1SERR#	GND	+3.3V	S1PAR	S1C/BE[1]#	GND
17	GND	+3.3V	IPMB_SCL ⁽¹⁾	IPMB_SDA ⁽¹⁾	GND	S1PERR#	GND
16	GND	S1DEVSEL#	GND	V(I/O) ⁽¹⁾	S1STOP#	S1LOCK#	GND
15	GND	+3.3V	S1FRAME#	S1IRDY#	BDSSEL ⁽⁷⁾	S1TRDY#	GND
12-14	Key						
11	GND	S1AD[18]	S1AD[17]	S1AD[16]	GND	S1C/BE[2]#	GND
10	GND	S1AD[21]	GND	+3.3V	S1AD[20]	S1AD[19]	GND
9	GND	S1C/BE[3]#	IDSEL ⁽⁸⁾	S1AD[23]	GND	S1AD[22]	GND
8	GND	S1AD[26]	GND	V(I/O) ⁽¹⁾	AD[25]	S1AD[24]	GND
7	GND	S1AD[30]	S1AD[29]	S1AD[28]	GND	S1AD[27]	GND
6	GND	REQ#	GND	+3.3V	S1CLK	S1AD[31]	GND
5	GND	Reserved ⁽¹⁾	Reserved ⁽¹⁾	S1PCIRST#	GND	S1GNT#	GND
4	GND	IPMB_PWR ⁽¹⁾	HEALTHY# ⁽¹⁾	V(I/O) ⁽¹⁾	INTP ⁽¹⁾	INTS	GND
3	GND	INTA#	INTB#	INTC#	+5V	INTD#	GND
2	GND	TCK ⁽²⁾	+5V	TMS ⁽²⁾	TDO ⁽¹⁾	TDI ⁽²⁾	GND
1	GND	+5V	-12V	TRST# ⁽²⁾	+12V	+5V	GND
Pin	Z	A	B	C	D	E	F

Table 13: CompactPCI J1 pin assignments

2.1.12 CompactPCI J2 Pin Assignments

Pin	Z	A	B	C	D	E	F
22	GND	GA4# ⁽¹⁾	GA3# ⁽¹⁾	GA2# ⁽¹⁾	GA1# ⁽¹⁾	GA0# ⁽¹⁾	GND
21	GND	S1CLK6	GND	Reserved	Reserved	Reserved	GND
20	GND	S1CLK5	GND	Reserved	GND	Reserved	GND
19	GND	GND	GND	Reserved	Reserved	Reserved	GND
18	GND	Reserved	Reserved	Reserved	GND	Reserved	GND
17	GND	Reserved	GND	PRST#	S1REQ6#	S1GNT6#	GND
16	GND	Reserved	Reserved	DEG# ⁽²⁾	GND	Reserved	GND
15	GND	Reserved	GND	FAL# ⁽²⁾	S1REQ5#	S1GNT5#	GND
14	GND	Reserved	Reserved	Reserved	GND	Reserved	GND
13	GND	Reserved	GND	V(I/O) ⁽¹⁾	Reserved	Reserved	GND
12	GND	Reserved	Reserved	Reserved ⁽¹⁾	GND	Reserved	GND
11	GND	Reserved	GND	V(I/O) ⁽¹⁾	Reserved	Reserved	GND
10	GND	Reserved	Reserved	Reserved	GND	Reserved	GND
9	GND	Reserved	GND	V(I/O) ⁽¹⁾	Reserved	Reserved	GND
8	GND	Reserved	Reserved	Reserved	GND	Reserved	GND
7	GND	Reserved	GND	V(I/O) ⁽¹⁾	Reserved	Reserved	GND
6	GND	Reserved	Reserved	Reserved	GND	Reserved	GND
5	GND	Reserved	Reserved	V(I/O) ⁽¹⁾	Reserved	Reserved	GND
4	GND	V(I/O) ⁽¹⁾	Reserved	Reserved	GND	Reserved	GND
3	GND	S1CLK4	GND	S1GNT3#	S1REQ#4	S1GNT4#	GND
2	GND	S1CLK2	S1CLK3	SYSEN# ⁽²⁾	S1GNT2#	S1REQ3#	GND
1	GND	S1CLK1	GND	S1REQ1#	S1GNT1#	S1REQ2#	GND
Pin	Z	A	B	C	D	E	F

Table 14: CompactPCI J2 Pin Assignments

2.1.13 CompactPCI J4 Pin Assignments

Pin	Z	A	B	C	D	E	F
25	GND	+5V ⁽⁴⁾	REQ64# ⁽²⁾	ENUM# ⁽²⁾	+3.3V ⁽⁴⁾	+5V ⁽⁴⁾	GND
24	GND	S2AD[1]	+5V ⁽⁴⁾	Reserved	S2AD[0]	ACK64#	GND
23	GND	+3.3V ⁽⁴⁾	S2AD[4]	S2AD[3]	+5V ⁽⁴⁾	S2AD[2]	GND
22	GND	S2AD[7]	GND	+3.3V ⁽⁴⁾	S2AD[6]	S2AD[5]	GND
21	GND	+3.3V ⁽⁴⁾	S2AD[9]	S2AD[8]	M66EN ⁽⁴⁾	S2C/BE[0]#	GND
20	GND	S2AD[12]	GND	Reserved	S2AD[11]	S2AD[10]	GND
19	GND	+3.3V ⁽⁴⁾	S2AD[15]	S2AD[14]	GND	S2AD[13]	GND
18	GND	S2SERR#	GND	+3.3V ⁽⁴⁾	S2PAR	S2C/BE[1]#	GND
17	GND	+3.3V ⁽⁴⁾	IPMB_SCL ⁽¹⁾	IPMB_SDA ⁽¹⁾	GND	S2PERR#	GND
16	GND	S2DEVSEL#	GND	Reserved	S2STOP#	S2LOCK#	GND
15	GND	+3.3V ⁽⁴⁾	S2FRAME#	S2IRDY#	GND	S2TRDY#	GND
12-14	KEY						
11	GND	S2AD[18]	S2AD[17]	S2AD[16]	GND	S2C/BE[2]#	GND
10	GND	S2AD[21]	GND	+3.3V ⁽⁴⁾	S2AD[20]	S2AD[19]	GND
9	GND	S2C/BE[3]#	GND	S2AD[23]	GND	S2AD[22]	GND
8	GND	S2AD[26]	GND	Reserved	AD[25]	AD[24]	GND
7	GND	S2AD[30]	S2AD[29]	S2AD[28]	GND	S2AD[27]	GND
6	GND	S2REQ0#	GND	+3.3V ⁽⁴⁾	S2CLK	S2AD[31]	GND
5	GND	Reserved	Reserved	S2PCIRST#	GND	S2GNT0#	GND
4	GND	IPMB_PWR ⁽¹⁾	HEALTHY# ⁽¹⁾	Reserved	INTP ⁽¹⁾	INTS	GND
3	GND	INTA#	INTB#	INTC#	+5V ⁽⁴⁾	INTD#	GND
2	GND	TCK ⁽²⁾	+5V ⁽⁴⁾	TMS ⁽²⁾	TDO ⁽¹⁾	TDI ⁽²⁾	GND
1	GND	+5V ⁽⁴⁾	Reserved	TRST# ⁽²⁾	Reserved	+5V ⁽⁴⁾	GND
Pin	Z	A	B	C	D	E	F

Table 15: CompactPCI J4 pin assignments

2.1.14 CompactPCI J5 Pin Assignments

Pin	Z	A	B	C	D	E	F
22	GND	Reserved	Reserved	Reserved	Reserved	Reserved	GND
21	GND	S2PCLK6	GND	LANLED2	Reserved	Reserved	GND
20	GND	S2PCLK5	GND	SDD7	GND	SIDERST#	GND
19	GND	GND	GND	SDD9	SDD6	SDD8	GND
18	GND	SDD4	SDD11	SDD10	GND	SDD5	GND
17	GND	SDD12	GND	Reserved	S2REQ6#	S2GNT6#	GND
16	GND	SDD3	SDD13	Reserved	GND	SDD2	GND
15	GND	SDD1	GND	Reserved	S2REQ5#	S2GNT5#	GND
14	GND	SDDREQ	SDD14	SDD0	GND	SDD15	GND
13	GND	SDIORDY	GND	Reserved	SDIOW#	SDIOR#	GND
12	GND	SPDIAG	SDCS16#	SDDACK#	GND	SDIRQ15	GND
11	GND	SDA0	GND	Reserved	SDA2	SDA1	GND
10	GND	GREEN	SDACT#	SDCS3#	GND	SDCS1#	GND
9	GND	HSYNC	GND	Reserved	RED	BLUE	GND
8	GND	DDCLK	DDDAT	SPDLED2	GND	VSYNC	GND
7	GND	OCJ1	GND	Reserved	LANLED1	SPDLED1	GND
6	GND	USBP1M	USBP1P	DTR2#	GND	RXD2	GND
5	GND	DCD2#	GND	Reserved	TXD2	RI2#	GND
4	GND	Reserved	CTS2#	RTS2#	GND	DSR2#	GND
3	GND	S2CLK4	GND	S2GNT3#	S2REQ4#	S2GNT4#	GND
2	GND	S2CLK2	S2CLK3	Reserved	S2GNT2#	S2REQ3#	GND
1	GND	S2CLK1	GND	S2REQ1#	S2GNT1#	S2REQ2#	GND
Pin	Z	A	B	C	D	E	F

Table 16: CompactPCI J5 pin assignments

Note:

- (1) These signals are not connected.
 - (2) These signals are pulled high on board.
 - (3) These signals are pulled low on board.
 - (4) These power pins are used for rear transition board used.
-

-
- (5) ENUM# is connected to a BIOS programmable circuitry then connected to IRQ 3 or IRQ 9 according to the hardware configuration. There is a BIOS setting to Enable/Disable this ENUM# function. The default BIOS setting is Disabled and the factory default hardware configuration is IRQ 9. To support PICMG 2.1 Hot Swap for peripheral boards, backplane should bus all peripheral slots ENUM# together to system slot. And customer should enable ENUM# function in cPCI-6760DK/P5 BIOS setting. (When R283 and R284 are installed with 0-ohm resistors, ENUM# is routed through IRQ9. If R283, R284 are removed and R281 and R282 are installed with 0-ohm resistors, ENUM# is routed through IRQ3.)
 - (6) M66EN is tied to ground. PCI bus just can run in 33MHz.
 - (7) In backplane, BSEL must tie to ground to enable "self-hot-swap" controller.
 - (8) IDSEL are tied to ground.
-

2.1.15 LAN Port Indicators (Integrated in LAN1 (CN6) and LAN2 (CN7))

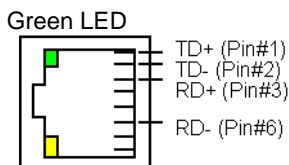

Amber LED

Amber LED 10/100Mbps Status	Description
OFF	10Mbps transfer rate
ON	100Mbps transfer rate

Table 17: Amber LED indication in LAN port

Green LED Link/Activity Status	Description
OFF	No link
ON	Connecting
Blinking	Active/Data transferring

Table 18: Green LED indication in LAN port

2.1.16 IDE Activity LED Indication

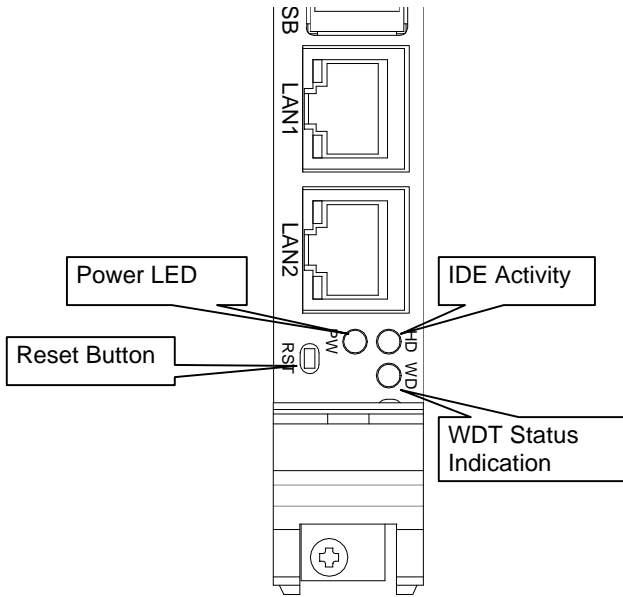

Red LED	Description
OFF	EIDE is not active
ON	Any one EIDE device is active

Table 19: IDE Activity LED indication

2.1.17 Power LED Indication

Green LED	Description
OFF	System is not power-on or power failed
ON	System is power-on

Table 20: Power LED indication

2.1.18 WDT LED Indication

Amber LED	Description
OFF	WDT is not enable
Blinking	WDT is enable

Table 21: WDT LED indication

3

Getting Started

This chapter provides information on how to install necessary components on the cPCI-6760DK/P5 in order to set up a workable system. The topics covered are:

- CPU Installation
- Memory Installation
- CF Installation
- HDD Installation
- Device Connection for OS Installation
- Notice for Rear I/O Connection

3.1 CPU Installation

The cPCI-6760DK/P5 CPU module supports an Intel BGA2 Low Power Pentium-III processor at 500MHz with a 100 MHz front side bus (FSB) frequency.

The CPU on the cPCI-6760DK/P5 series products is soldered on the PCB (printed circuit board) in the factory. Users do not need to install any CPU beforehand to get the system started. The heatsink is also pre-mounted in the factory. We do not suggest users try to remove the heatsink or CPU. It may cause an un-recoverable system error and the warranty will be void.

-
- Please do not try to replace the CPU in the field or remove the heatsink. It will cause board defects and the warranty will be void.
-

3.2 Memory Installation

The cPCI-6760DK/P5 CPU module supports two PC-100 144-pin SO-DIMM sockets for a maximum total memory of 512MB with optional ECC support. The memory type must be 3.3V SDRAM. The memory module can come in sizes of 32MB, 64MB, 128MB or 256MB PC-100 144-pin SO-DIMM. The 256MB SO-DIMM should be constructed of 16Mx8 SDRAM chips.

The cPCI-6760DK/P5 is delivered with pre-installed 64MB PC-100 144-pin SO-DIMM. ADLINK's factory also provides pre-mounting memory service of other memory size for volume orders of OEM project on request. Please contact your dealer or ADLINK's sales representatives.

-
- Note:** Ensure that the RAM modules are firmly seated in the SO-DIMM sockets and that it is not over the height limitation, otherwise the components maybe damaged when the SBC is inserted into the chassis.
-

3.3 CF Installation

The CompactFlash Card (or called CF storage card) is widely applied in digital consumer devices like PDA, Digital Camera and MP3 player. Because of the CF anti-shock, anti-vibration, better environment tolerance, low power consumption, small form factor and high reliability, it has been widely accepted in mission critical embedded applications.

With the cPCI-6760DK/P5, the CF card is very easy to use; the CF card socket is available on the DB-6760CF, which is a removable daughter board that can be attached to the cPCI-6760DK/P5 by directly connecting the daughter board to the on-board 44-pin IDE (CN2) connector. The DB-6760CF is designed in exchange with the 2.5" ATA HDD on the IDE interface. The DB-6760CF supports both type-I and type-II CompactFlash storage device such as CF cards or IBM MicroDrive.

If user purchases the OEM model, non-standard, customized or special configuration model, it may not come with the DB-6760CF in the package. Users can purchase the CF card adaptor (by the model name: DB-6760CF) as an optional kit to convert the IDE interface into a CF card socket. Since the CF card adaptor utilizes the same IDE interface and the same space that a 2.5" ATA HDD may occupy, users should remove then 2.5" ATA HDD (if any) first before installing the CF card adaptor. Please refer to the section of HDD installation for instructions on removing the 2.5" ATA HDD.

Note: To prevent the CF card from come loose during heavy vibrations, there is a screw designed and located on the upper side of CF card. (Please refer to the figure in section 3.3.1.). Remove the protection screw before inserting or extracting the CF card. After inserting or extracting the CF card, please mount and fix this protection screw.

3.3.1 DB-6760CF Outline, Jumper and Connectors

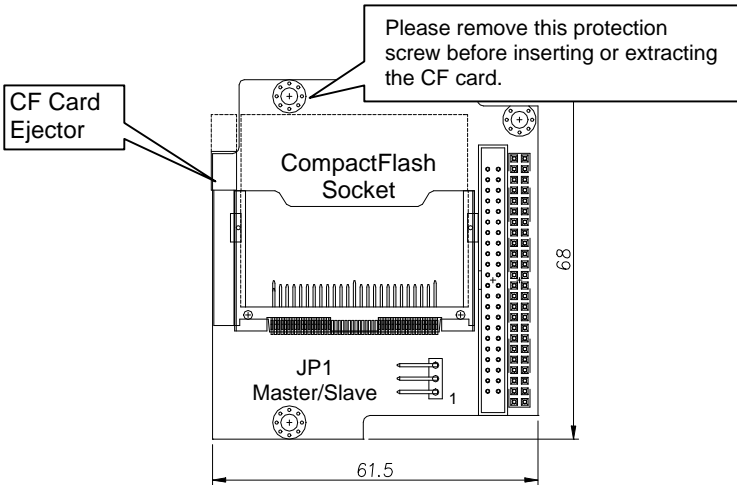



M/S Selection	JP1
Master (Default)	<p>3 2 1</p>  <p>Pin 2 & 3 Short</p>
Slave	<p>3 2 1</p>  <p>Jumper Open</p>

Table 22: JP1 DB-6760CF Master/Slave Setting

3.3.2 DB-6760CF Installation for cPCI-6760DK/P5 and CF card notice

- Mount the DB-6760CF on the cPCI-6760DK/P5's IDE connector (CN2). Please be aware that pin 1 on the DB-6760CF should be aligned with pin 1 of CN2 on the cPCI-6760DK/P5.
- Fix the DB-6760CF & cPCI-6760DK/P5 by screwing three hexagonal pillars between them. Leave the hole in front of the CF socket unscrewed.
- Set the CF card as master or slave upon application requirements.
- Insert a CF card into its socket, and then check to see if the CF card is probably seated
- Mount the third screw on the upper side of the CF card to prevent the CF card from coming loose during heavy vibration.

Note: The CF card on the CPU board utilize the Secondary EIDE interface (IDE2), which is also wired to the CompactPCI connector J5. Users need to pay attention to the master/slave setting to avoid conflicts between devices. The default jumper setting on the DB-6760CF is set to master.

3.3.3 Removing the DB-6760CF from the cPCI-6760DK/P5

- Remove the upper screw, which prevents the CF card from coming loose
- Remove the CF card by pushing the ejector level
- Remove all screws & hexagonal pillars on the DB-6760CF
- Remove the DB-6760CF carefully from the 44-pin IDE connector (CN2) of the cPCI-6760DK/P5

3.4 HDD Installation

With the cPCI-6760DK/P5, users can install one 2.5" ATA HDD or one flash drive (e.g. FLASH2000 flash disk, FFD). The factory default model is equipped with a DB-6760CF; the removable CF card is not included. If users wish to install a 2.5" ATA HDD for larger storage capacity or want to install a FFD, user can purchase off-the-shelf 2.5" ATA HDD or FFD from the market. However, we recommend only products, which are approved by ADLINK to ensure optimum system stability. Due to space limitation and ventilation concerns, the SBC is only allowed to use low profile (or called slim type) 2.5" ATA HDD or FFD with a thickness of no more than 9.5mm. Since the CF card adaptor (DB-6760CF) utilizes the same IDE interface and the same housing that a 2.5" ATA HDD uses, users should remove the CF card adaptor (if any) first before installing a 2.5" ATA HDD or FFD. Please refer to the section on "CF installation" for the instruction on removing the CF card adaptor.

3.4.1 HDD/FFD Installation for cPCI-6760DK/P5

- Find the HDD accessory pack inside your original package. (If user purchases the OEM model, non-standard, customized or special configuration model, it may not come with the HDD accessory pack. Please contact ADLINK dealers or sales representatives to purchase this accessory pack P/N: 58-00023-000.)
- Remove the DB-6760CF if it exist, please refer to the section "CF Installation"
- Check the master/slave setting of your 2.5" ATA HDD.
- Screw four copper hexagonal stand-offs on the bottom side of the 2.5" ATA HDD.
- Mount the HDD by using four M3 screws from the bottom side of the cPCI-6760DK/P5's.
- Connect the HDD and cPCI-6760DK/P5 (CN2) using the ribbon cable, which comes with the HDD accessory pack.
- Check pin1 of the IDE connector, ribbon cable and HDD are all matched.
- Reconfirm the ribbon cable, HDD and HDD supporting stand-off are all well fixed & connected.

Note: The 2.5" ATA HDD on the front board utilizes the Secondary EIDE interface (IDE2), which is also wired to the CompactPCI connector J5. Users need to pay attention to the master/slave setting to avoid conflicts between devices.

3.4.2 Removing HDD/FFD from cPCI-6760DK/P5

- Remove the four screws from the bottom side that mounts on the copper stand-offs.
- Remove the 44-pin ribbon cable from CN2 of the cPCI-6760DK/P5 and remove the cable from the HDD.
- Remove the copper stand-offs from the HDD.

3.5 Device Connection for OS Installation

This section describes how to get started with installation of an OS on to the cPCI-6760DK/P5 CPU module. The easiest way to install an OS is by connecting an ATAPI CD-ROM.

3.5.1 Using the cPCI-6760DK/P5 with ADLINK's cBP-6108 and 6515 series backplane

Since the cBP-6108 and 6515 series backplane have direct IDE connection from J3/P3 and J5/P5 on the rear I/O interface, and the pin assignments are compatible with that of the cPCI-6760DK/P5 series product. Users can easily connect a 40-pin ribbon cable into the IDE interface on the rear side of backplane. Then connect the other end of the cable into an ATAPI CD-ROM. Because the primary IDE interface is wired to J3 and then goes to be used by the DB-6760J3 daughter board, users can only connect an IDE cable on the secondary IDE interface on the backplane. If users have installed a 2.5" ATA HDD or CF card on the front board, it is recommend that the master/slave setting on CD-ROM be adjusted to prevent any conflicts.

3.5.2 Using the cPCI-6760DK/P5 on other backplanes

For backplanes, which are not compatible with the pin assignments of J5/P5 IDE interface of the cPCI-6760DK/P5, users can connect a 40-pin ribbon cable onto the **Secondary IDE interface** on the cPCI-R6760D or cPCI-R6760S rear board and then connect the other end of the ribbon cable onto the ATAPI CD-ROM. If users have installed a 2.5" ATA HDD or a CF card on the front board, it is recommended that the master/slave setting on the CD-ROM be adjusted to prevent any conflicts.

3.6 Notice for Rear I/O Connection

The cPCI-6760DK/P5 features fully integrated functionalities with AGP-VGA display, Ethernet ports, 2S1P, USB, UDMA-33 IDE and Ultra-160 SCSI. Some of these are implemented for rear I/O only, while some are implemented to support both front and rear I/O. This section describes the important notes about using the rear I/O connection.

3.6.1 The I/O implementation is only supported by rear I/O board

Several I/Os are only supported by the rear I/O including COM2, USB2, LAN3, LAN4 and SCSI. User could apply the cPCI-R6760S rear I/O board to obtain all the rear I/O mentioned above. If the cPCI-R6760D rear I/O board is applied then there is no LAN3, LAN4 or SCSI available. However, using the cPCI-R6760S will occupy 3 pairs of PCI bus mastering circuitry on the upper cPCI bus (the secondary cPCI bus).

-
- Please use the proper rear I/O transition module to enable the functions (I/O interfaces) on rear side. The board or system maybe damaged if the incorrect rear I/O transition module is used.
-

3.6.2 The I/O implementation is supported by both rear I/O and front I/O

Several I/Os were originally designed to support rear and front I/O's including keyboard, mouse, VGA display and Ethernet connections, but now since the cPCI-6760DK/P5 also uses the DB-6760J3, it re-directs some of the rear I/O signal to front board, therefore, there is no signal output available on the rear I/O for keyboard, mouse and Ethernet. Users may apply the cPCI-R6760D or cPCI-R6760S on the system, but only the VGA display is available on rear panel.

-
- Please use the proper rear I/O transition module to enable the functions (I/O interfaces) on rear side. The board or system maybe damaged, if the improper rear I/O transition module is used.
 - Please connect device either on the front or rear I/O for one I/O function only. DO NOT connect devices of the I/O function front and rear panel at the same time. It may cause damages to the I/O ports or the system module and the warranty will be void.
-

3.6.3 LAN1, LAN2 Front and Rear I/O Connecting Selection

There are two DIPswitches on the solder side of the cPCI-6760DK/P5. Those switches were originally designed to supports dual Ethernet connection both on the front and rear I/O's on the cPCI-6760D, however; with the cPCI-6760DK/P5, it uses the DB-6760J3 to re-direct the rear I/O signals on J3 to the front, therefore there is no LAN1 or LAN2 Ethernet available on rear I/O. Please keep these switches set as factory default to enable Ethernet functionalities on the cPCI-6760DK/P5.

S1, S2: LAN1 Connecting Selection

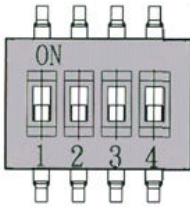

LAN 1 Connecting	Switch S1		Switch S2	
	Pin#	State	Pin#	State
Front I/O Enable	S1-1	ON	S2-1	OFF
	S1-2	ON	S2-2	OFF
	S1-3	ON	S2-3	OFF
	S1-4	ON	S2-4	OFF

Table 23: LAN1 Connecting Selection

S3, S4: LAN2 Connecting Selection

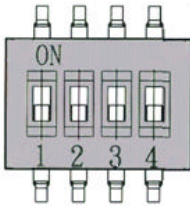

LAN 2 Connecting	Switch S3		Switch S4	
	Pin#	State	Pin#	State
Front I/O Enable	S3-1	ON	S4-1	OFF
	S3-2	ON	S4-2	OFF
	S3-3	ON	S4-3	OFF
	S3-4	ON	S4-4	OFF

Table 24: LAN2 Connecting Selection

- DO NOT set S1 and S2 to "ON" or S3 and S4 to "ON" at the same time. It may cause Ethernet malfunction or damage the board or devices.

4

Driver Installation

To install the drivers and utility for the cPCI-6760DK/P5, please refer the installation information in this Chapter. We provide basic information in this manual, however, for more detail installation information, such as non-Windows OS installation, please refer to the extensive explanation inside the ADLINK CD. We put the chip drivers in the following directories:

Chipset driver	\\CHIPDR\\Chipset\\440BX
VGA/AGP relative driver	\\CHIPDR\\VGA\\SM721
LAN relative driver	\\CHIPDR\\LAN\\100PDISK
Watchdog relative library	\\CHIPDR\\WDT
Hardware Doctor Utility	\\Utility\\HWDDoctor\\W8378X

In this users manual, the Bus-mastering IDE driver installation is not described because most of the Windows based OS will install those drivers automatically.

Since Windows NT is a non plug-and-play OS, some useful tips for installing Windows NT drivers are suggested:

1. Install the LAN driver before installing any service pack.
2. Install the VGA/AGP driver after installing the service pack. Please make sure your service pack does support AGP, service pack 6 or higher is recommend.
3. If Windows NT boots with a warning message, check the Event Viewer to view the source generating the warning message. If strange phenomena's occur and it can't be solved, re-install the Windows NT service pack, then install the drivers in a different sequence.

4.1 VGA Drivers Installation

This section describes the VGA driver installation for the onboard VGA controller **SM721**. The relative drivers are located in **X:\CHIPDRV\VGA\SM721** directory of the ADLINK CD: where X: is the location of the CD-ROM drive. The VGA drivers for Windows 98/95, Windows NT and Windows 2000 are also included.

4.1.1 Driver Installation on Windows 2000

Windows 2000 may install the standard VGA driver. We recommend you to manually installed the most updated driver, which is shipped with the ADLINK CD to guarantee compatibility. After installing Windows 2000, update to the new driver by following these procedures.

1. Boot Windows 2000, Click **Start**. Select **Settings** then double-click the **Control Panel**.
2. Double-click on the **System** icon, click **Hardware** tab, click **Device Manager** button.
3. Double-click either on the *Display Adapters* or *Other Devices* entry, Double-click *Video Controller* or *Silicon Motion Lynx3DM* entry.
4. Click on the **Driver** tab, then click **Update Driver...** button.
5. An Upgrade Device Driver Wizard windows will appear, click **NEXT>**.
6. Select *Display a list of ...* and click **NEXT**.
7. The next window will show a list of hardware types, select **Display Adapters**, then click **OK**.
8. This window will show a list of VGA model numbers.
9. Insert ADLINK CD and click **Have Disk**.
10. **Browse** the SM721 driver in the following path: **X:\CHIPDRV\VGA\SM721\WIN2K**, highlight **smisetup.inf**, click **OPEN**, then click **NEXT>**.
11. Highlight the model: **Silicon Motion Lynx3DM**, then click **NEXT>**.

12. Click the **NEXT>** button again; Windows 2000 may report a Digital Signature Not Found. Click **Yes** to continue.
13. Click **Finish** button, then click **CLOSE** button.

4.1.2 Driver Installation on Windows 98

Windows 98 may install the standard VGA driver. We recommend you to manually installed the most updated driver, which is shipped with the ADLINK CD to guarantee compatibility. After installing Windows 98, please update to the new driver by following these procedures.

1. Boot Windows 98, Click **Start**. Select **Settings** then double-click the **Control Panel**.
2. Double-click **System** icon, click on the **Device Manager** tab.
3. Double-click **Display Adapters** entry, select the **Standard PCI Graphics Adapter (VGA)** entry. Click the **Properties** button.
4. Click on the **Driver** button, then click **Update Driver...** button.
5. An Upgrade Device Driver Wizard window will appear, click **NEXT>**.
6. Select **Display a list of ...** and click **NEXT>**. The next window allows the user to specify a specific path. Insert the ADLINK CD and click **Have Disk**.
7. **Browse** the SM721 driver in the following path: **X:\CHIPDRV\VGA\SM721\WIN9XME**, highlight **smi.inf**, and click **OPEN**. Click **OK**.
8. Click the **NEXT>** button and a Wizard summary window will appear.
9. Click the **Finish** button, then restart the computer to activate the new driver.

4.1.3 Driver Installation on Windows NT

Windows NT may install the standard VGA driver. We recommend you to manually installed the most updated driver, which is shipped with the ADLINK CD to guarantee compatibility. After installing Windows NT, please update to the new driver by following these procedures.

1. From the **Control Panel**, double-click the **Display** icon.
2. Click the **Settings** tab, click **Display Type...**, click **Change...** button.
3. Insert ADLINK CD and click **Have Disk**.
4. **Browse** the SM721 driver in the following path: **X:\CHIPDRV\VGA\SM721\WINNT40**, highlight **smisetup.inf**, click **OPEN**. Click **OK**.
5. A windows will appear and will shows the Display is Silicon Motion Lynx Family, click **OK**, then click **Yes** to continue.
6. An Installing Driver window appears indicating a successful installation, click **OK** to continue.
7. Click **Close** button.
8. Click **Close** button, then restart the computer to activate the new driver.

Note: After installing the VGA/AGP drivers, and you find the driver does not work. This maybe due to not installing the NT service pack in advance. We suggest installing NT service pack 4 or higher to enable AGP capability.

4.2 LAN Drivers Installation

This chapter describes LAN driver installation for the onboard Ethernet controller **Intel 82559**. The relative drivers are under the following ADLINK CD directory: **X:\CHIPDRVLAN\100PDISK**, where X: is the location of the CD-ROM drive.

4.2.1 Software and Drivers Support

The 82559 drivers support the following OS or platforms:

- Windows 98, Windows 95, Windows 2000, Windows NT
- Novell Netware, DOS Setup for Novell NetWare DOS
- UNIX, OS2, Linux

All the above drivers are included in the ADLINK CD. In the following section, we will describe the driver installation for Windows 98, Windows 2000, and Windows NT. For driver installation of other OS's, please refer to the readme file inside the CD.

4.2.2 Driver Installation on Windows 2000

Windows 2000 may install the LAN driver. We recommend you to manually install the most updated LAN driver, which is shipped with the ADLINK CD to guarantee compatibility. After installing Windows 2000, please update to the new driver by following these procedures.

1. Boot Windows 2000, Click **Start**. Select **Settings** then double-click the **Control Panel**.
2. Double-click **System** icon, click **Hardware** tab, click **Device Manager** button.
3. Double-click Network Adapters entry, Double-click the Intel 8255x-based PCI Ethernet Adapter (10/100) entry.
4. Click **Driver** tab, then click **Update Driver...** button.
5. An Upgrade Device Driver Wizard window will appear, click **Next>**.
6. Select **Display a list of ...** and click **Next>**. The next window will show a list of hardware models.
7. Insert the CD and click **Have Disk**.
8. Browse the Intel 82559 driver in the following path: **X:\CHIPDRVLAN\100PDISK**, highlight **oemsetup.inf**, click **Open**, then click **OK**.

9. Highlight the model: **Intel 8255x- based PCI Ethernet Adapter (10/100)**, then click **NEXT>**. An Update Driver Warning window may pop up, click **Yes** to continue.
10. Click **NEXT>** button, then the Wizard summary window appears.
11. Click **Finish** button, then click **CLOSE** button.

4.2.3 Driver Installation on Windows 98

Windows 98 will install the LAN driver automatically. We recommend you to manually update to the new LAN driver, which comes with the ADLINK CD to guarantee compatibility. After installing Windows 98, please update the new drivers by the following procedures.

1. Boot Windows 98, Click **Start**. Select **Settings** then double-click the **Control Panel**.
2. Double-click on the **System** icon, click on the **Device Manager** tab.
3. Double-click on the **Network Adapters** entry,select the **Intel 8255x-based PCI Ethernet Adapter (10/100)** entry. Click the **Properties** button.
4. Click on the **Driver** button, then click **Update Driver...** button.
5. **Update Device Driver Wizard** starts, click **NEXT**.
6. Select **Display a list of ...** and click **NEXT**. The next window allows the user to specify a specific path. Insert the CD and click **Have Disk**.
7. Browse the Intel 82559 driver in the following path: **X:\CHIPDRVLAN\100PDISK**, highlight **net82557.inf**, click **OK**. The Update Wizard displays a message that it has found the driver. Click **OK** again to update the driver. Note: Windows 98 may ask you to insert the original Windows 98 CD to install the LAN protocols.
8. Click **NEXT** button, then the Wizard summary window appears.
9. Click **Finish** button, then restart the computer to activate the new driver.

4.2.4 Driver Installation on Windows NT

Before install the LAN driver on Windows NT, please copy the LAN driver in the CD to a floppy diskette. You have to put a new disk into drive A, then type the following batch command under the DOS environment to copy the relative NT drivers.

```
X:\CHIPDRV\LAN\100PDISK\Makedisk\Makedisk NT
```

where X is the CD-ROM drive.

Windows NT may ask to installs a LAN driver from its own library of drivers. We recommend you to manually update to the new LAN driver, which comes with the ADLINK CD to guarantee compatibility. After installing Windows 98, please update to the new driver by following these procedures.

1. From the **Control Panel**, double-click the **Netwrok** icon, a Network Configuration window pops up, click **Yes**.
2. In Network Setup Wizard, click **Next>**, click **Select From List...** button.
3. Insert LAN driver floppy diskette into A drive and click **Have Disk**.
4. In the dialog box of Insert Disk window, type in **A:**, Click **OK**.
5. A Select OEM Option window pops up, click **OK**, then click **Next>**.
6. Select necessary Network Protocols, click **Next>**.
7. Select necessary Network Services, click **Next>**.
8. Click **Next>** until Window NT Setup dialog box pop up. Type in **D:\V386** in the dialog box, then insert the original Windows NT CD, click **Continue**.
9. Then click **OK** until the setup is completed.
10. Reboot the computer.

Watchdog and Utilities

This chapter takes you through how to configure the watchdog timer and a brief introduction to the utilities that are available to the cPCI-3720

5.1 Watchdog Timer Configuration

The Watch Dog Timer (WDT) can monitor the system's status. Once you give a value to the WDT, the timer will begin to count down, moving the keyboard can restart the WDT. If the system is idle or hangs, it will reboot when the timer times out.

The function of the watchdog timer is to reset the system automatically. It contains a one-second (or one-minute) resolution down counter (in CRF2 of logical device 8 of super I/O chip) and two Watchdog control registers (CRF4 and CRF3 of logical device 8).

We provide WDT function calls for easy use under DOS, Windows 95/98/2000, and Windows NT, please refer to the information under **X:\CHIPDRV\WDT**.

5.1.1 WDT Programming

In order to simplify the programming code, we have provided a sub function for programmers to implement with their software. For DOS, Windows 95, 98 and Windows NT, the sub function format is as follows:

```
out_port (int IOport_number, int Counter_value)
```

```
IOport_number:0x3F0 -->W83977EF's configuration port.
```

```
0x2E -->W83627HF's configuration port.
```

```
Counter_value: 0 ~ 15300 (255 minutes)
```

(write a zero to disable the timer)

Under DOS, Windows 95 or 98

Make a project program called `wdt.cpp` under Turbo C/C++.

Under Windows NT

The library installation procedure:

- (1) run the setup program under NT environment.
- (2) reboot the system.

You can also write your own DLL by referring to the DOS sources we have provided.

5.1.2 How to Test the WDT?

Under DOS, Windows 95 or 98

Open a DOS command prompt and execute the following utility on the CD.

```
X:\CHIPDRV\WDT\test <n>
```

```
/* n = second value. This program can auto-detect which Super I/O chip you  
are using. */
```

Under Windows NT

Before you executing this program under NT, you must run the setup program under Windows NT in advance. Open a DOS command prompt window and execute the following command.

```
test977 <n>: n = second value. For W83977EF
```

5.2 Hardware Doctor Utility

This section introduces the Hardware Doctor Utility that comes with the CPU board in conjunction with the onboard hardware monitoring functions. The section describes the functions of the utility.

Hardware Doctor is a self-diagnostic system for PC and must be used with the Winbond W83781D/W83782D or W83627HF IC series products. It will protect the PC Hardware by monitoring several critical items including Power Supply Voltage, CPU Fan speed, and CPU & System temperature. These items are important to the operation of system; errors may result in permanent damage to the PC. If any item is out of its normal range, an obvious warning message will pop up and notify the user to take the appropriate action.

The Hardware Doctor utility supports Windows 98 and Windows NT. The software is stored on the ADLINK CD under the following directory:
X:\Utility\HWDoctor\W8378X\WIN98 and
X:\Utility\HWDoctor\W8378X\NT40.

To install the Hardware Doctor Utility execute the HWM-98.exe or HWM-NT.exe respectively under Windows 98 or Windows NT.

For a detail user's manual, please refer the HWDoctor.PDF under the **X:\Utility\HWDoctor\W8378X.**

5.3 Intel Preboot Execution Environment (PXE)

The cPCI-6760DK/P5 series supports Intel Preboot Execution Environment (PXE), which provides the capability of boot-up or executing an OS installation through the Ethernet ports. There should be a DHCP server in the network with one or more servers running PXE and MTFTP services. It could be a Windows NT or Windows 2000 server running DHCP, PXE and MTFTP service or a dedicated DHCP server with one or more additional server running PXE and MTFTP service. This section describes the major items required for building a network environment with PXE support.

1. Setup a DHCP server with PXE tag configuration.
2. Install the PXE and MTFTP services
3. Make boot image file on PXE server (that is the boot server).
4. Enable the PXE boot function on the client computer.

For more detailed information, please refer to [pdkrel30.pdf](#) under the directory ***X:\Utility*PXE_PDK**.

5.4 Intel Adapter Teaming

The cPCI-6760DK/P5 series support Intel Adapter Teaming which provides several options for increasing throughput and fault tolerance when running Windows 2000, Windows NT 4.0, or NetWare 4.1x or newer. There are four options that can be supported by the cPCI-6760DK/P5. The options are listed below:

1. **Adapter Fault Tolerance:** provides automatic redundancy for your Ethernet port (adapter). If the primary port (adapter) fails, the secondary takes over. You can create up to eight Fault Tolerance teams. Each team can have 2 - 8 ports (or adapters).
2. **Adaptive Load Balancing (ALB):** creates a team of two to eight Ethernet ports (or adapters) to increase transmission throughput. Also includes Fault Tolerance option. Works with most switches.
3. **Fast Ethernet Channel (FEC):** creates a team of two, four or eight ports (adapters) to increase transmission and reception throughput. Also includes Fault Tolerance option. Requires a switch with FEC capability. You can create up to four teams.
4. **Link Aggregation:** creates a team of two, four or eight ports (adapters) to increase transmission and reception throughput. Also includes Fault Tolerance option. Requires a switch with Link Aggregation capability. You can create up to four teams.

For more detailed information, please refer to **prosetp.hlp** under the directory **X:\CHIPDRV\LAN100PDISK**

Warranty Policy

Thank you for choosing ADLINK. To understand your rights and enjoy all the after-sales services we offer, please read the following carefully.

1. Before using ADLINK's products, please read the user manual and follow the instructions exactly. When sending in damaged products for repair, please attach an RMA application form.
2. All ADLINK products come with a two-year guarantee, free of repair charge.
 - The warranty period starts from the product's shipment date from ADLINK's factory
 - Peripherals and third-party products not manufactured by ADLINK will be covered by the original manufacturers' warranty
 - End users requiring maintenance services should contact their local dealers. Local warranty conditions will depend on the local dealers
3. Our repair service does not cover the two-years warranty if damage goods are cause by the following:
 - a. Damage caused by not following instructions on user menus.
 - b. Damage caused by carelessness on the users' part during product transportation.
 - c. Damage caused by fire, earthquakes, floods, lightening, pollution and incorrect usage of voltage transformers.
 - d. Damage caused by unsuitable storage environments with high temperatures, high humidity or volatile chemicals.
 - e. Damage caused by leakage of battery fluid when changing batteries.
 - f. Damages from improper repair by unauthorized technicians.
 - g. Products with altered and damaged serial numbers are not entitled to our service.
 - h. Other categories not protected under our guarantees.

4. Customers are responsible for the fees regarding transportation of damaged products to our company or to the sales office.
5. To ensure the speed and quality of product repair, please download an RMA application form from our company website www.adlinktech.com. Damaged products with RMA forms attached receive priority.

For further questions, please contact our FAE staff.

ADLINK: service@adlinktech.com

Test & Measurement Product Segment: NuDAQ@adlinktech.com

Automation Product Segment: Automation@adlinktech.com

Computer & Communication Product Segment: NuPRO@adlinktech.com;
NuIPC@adlinktech.com

Free Manuals Download Website

<http://myh66.com>

<http://usermanuals.us>

<http://www.somanuals.com>

<http://www.4manuals.cc>

<http://www.manual-lib.com>

<http://www.404manual.com>

<http://www.luxmanual.com>

<http://aubethermostatmanual.com>

Golf course search by state

<http://golfingnear.com>

Email search by domain

<http://emailbydomain.com>

Auto manuals search

<http://auto.somanuals.com>

TV manuals search

<http://tv.somanuals.com>