

User's Manual

DPA 2500/4000

40 BIT ENHANCED
STEREO POWER AMPLIFIER



www.altoproaudio.com

Version 1.0 September 2004

— English —

SAFETY RELATED SYMBOLS



This symbol, wherever used, alerts you to the presence of un-insulated and dangerous voltages within the product enclosure. These are voltages that may be sufficient to constitute the risk of electric shock or death.



This symbol, wherever used, alerts you to important operating and maintenance instructions. Please read.



Protective Ground Terminal



AC mains (Alternating Current)



Hazardous Live Terminal

ON: Denotes the product is turned on.

OFF: Denotes the product is turned off.

WARNING

Describes precautions that should be observed to prevent the possibility of death or injury to the user.

CAUTION

Describes precautions that should be observed to prevent damage to the product.

WARNING

• Power Supply

Ensure that the mains source voltage (AC outlet) matches the voltage rating of the product. Failure to do so could result in damage to the product and possibly the user.

Unplug the product before electrical storms occur and when unused for long periods of time to reduce the risk of electric shock or fire.

• External Connection

Always use proper ready-made insulated mains cabling (power cord). Failure to do so could result in shock/death or fire. If in doubt, seek advice from a registered electrician.

• Do Not Remove Any Covers

Within the product are areas where high voltages may present. To reduce the risk of electric shock do not remove any covers unless the AC mains power cord is removed.

Covers should be removed by qualified service personnel only.

No user serviceable parts inside.

• Fuse

To prevent fire and damage to the product, use only

the recommended fuse type as indicated in this manual. Do not short-circuit the fuse holder. Before replacing the fuse, make sure that the product is OFF and disconnected from the AC outlet.

• Protective Ground

Before turning the product ON, make sure that it is connected to Ground. This is to prevent the risk of electric shock.

Never cut internal or external Ground wires. Likewise, never remove Ground wiring from the Protective Ground Terminal.

• Operating Conditions

Always install in accordance with the manufacturer's instructions.

To avoid the risk of electric shock and damage, do not subject this product to any liquid/rain or moisture. Do not use this product when in close proximity to water.

Do not install this product near any direct heat source.

Do not block areas of ventilation. Failure to do so could result in fire.

Keep product away from naked flames.

IMPORTANT SAFETY INSTRUCTIONS

Read these instructions

Follow all instructions

Keep these instructions. Do not discard.

Heed all warnings.

Only use attachments/accessories specified by the manufacturer.

• Power Cord and Plug

Do not tamper with the power cord or plug. These are designed for your safety.

Do not remove Ground connections!

If the plug does not fit your AC outlet seek advice from a qualified electrician.

Protect the power cord and plug from any physical stress to avoid risk of electric shock.

Do not place heavy objects on the power cord. This could cause electric shock or fire.

• Cleaning

When required, either blow off dust from the product or use a dry cloth.

Do not use any solvents such as Benzol or Alcohol. For safety, keep product clean and free from dust.

• Servicing

Refer all servicing to qualified service personnel only.

Do not perform any servicing other than those instructions contained within the User's Manual.

PREFACE

Dear Customer:

Thanks for choosing ▲LTO DPA2500/4000 Stereo Power Amplifier which is the result of our ▲LTO AUDIO TEAM's endeavors.

For ▲LTO AUDIO TEAM, music and audio are much more than a job, they are a passion and an obsession!

We have been designing professional audio products for a long time in cooperation with many of the world's major brands.

The ▲LTO line represents unparalleled analogue and digital products made by musicians, for musicians. With our design centres in Italy, the Netherlands, and the United Kingdom we provide you with world-class designs, while our software development teams continue to develop an impressive range of audio specific algorithms.

By purchasing our ▲LTO products you become the most important member of our ▲LTO AUDIO TEAM. We would like to share with you our passion for what we design and we invite you to make suggestions, which will aid us in developing future products for you. We guarantee you our commitment to quality, continual research and development, and of course the best performance/price ratio.

Our ▲LTO DPA2500/4000 Stereo Power Amplifier is the result of many hours of listening and tests involving common people, area experts, musicians and technicians. The result of this effort is the sophisticated circuit design featuring high power and superb quality together with superior reliability and stability to provide the highest possible audio performance.

We would like to thank all the people that worked with us to make a vision real! Our designers and ▲LTO staff made the DPA2500/4000 Stereo Power Amplifier, a very reliable and high quality product ready for all your venues. And thanks to their passion for music and professional audio it has been possible for us to offer you, our most important team member, our continued support too.

Thank you very much.

▲LTO AUDIO TEAM

TABLE OF CONTENTS

1. INTRODUCTION	4
2. FEATURES	4
3. CONTROL ELEMENTS	4
3.1 The Front Panel	
3.2 The Rear Panel	
4. GETTING STARTED	6
4.1 Preset Selection	
4.2 Edit Menu	
4.3 Channel Selection	
4.4 Comm Selection:	
4.5 SIG/LIMITER LED	
5. REMOTE CONTROL	7
5.1 How to set the DPA's ID number	
5.2 Connection to the PC	
5.3 First Steps with the PC Editor	
5.4 Edit Mode (Password Protection)	
5.5 Help File	
5.6 Introduction to the PC Editor	
6. PARAMETER MENUS DESCRIPTION	11
7. WORKING WETH PRESETS	11
8. CONNECTIONS	12
9. APPLICATION	13
9.1 Stereo Mode	
9.2 Bridge Mode	
10. TECHNICAL SPECIFICATIONS	17
11. WARRANTY	18

1. INTRODUCTION

The ▲LTO DPA2 with advanced features it is also a versatile of the presets included. The amplifier delivers demanding conditions supplies and protection of fault, and the relay against open circuit. Thanks to the use of than its price.

2. FEATURE LIST

- Built in 40-bit digital
- Remote control through
- 1 factory preset and
- Delay lines up to 58
- Easy to operate from
- User-controllable clip
- Stereo (dual channel)
- Balanced XLR inputs
- Binding post and Ne
- Front panel LED indi
- Manufactured under

3. CONTROL ELEMENTS

3.1 Front Panel



1. Power Switch

Turn the unit power ON or OFF.

2. Clip LED

When the signal distortion reaches or surpasses 0.5%, the LED lights up. This means the output level of signal source is too high and it is time to reduce input level until clip LED turns off.

3. Output Limiter LED

While the unit is limiting the output signal, the LED lights up.

4. Operating and Protection LED

In normal operation, the LED is green, if the LED is red, it means the unit is in heat protection, no signal output at the time and over-heat inside the unit (the surface temperature of power transistor is over 100°C), the temperature must be lowered through better ventilation and decrease the signal level etc. After the temperature has dropped, the protection stops and meanwhile the LED turns off with the unit recover normal work.

5. Power LED

This LED lights up when the unit is powered.

6. Level Control for Channels 1&2

These two controls are used to adjust output level of channel 1 and channel 2 respectively.

7. UP/DOWN Key

This key is used to move inside the menus or to modify the parameter's value.

8. SELECT Key

This key is used to select the menu that you wish to edit.

9. ENTER Key

This key is used to edit or confirm the parameter's value.

3.2 Rear Panel

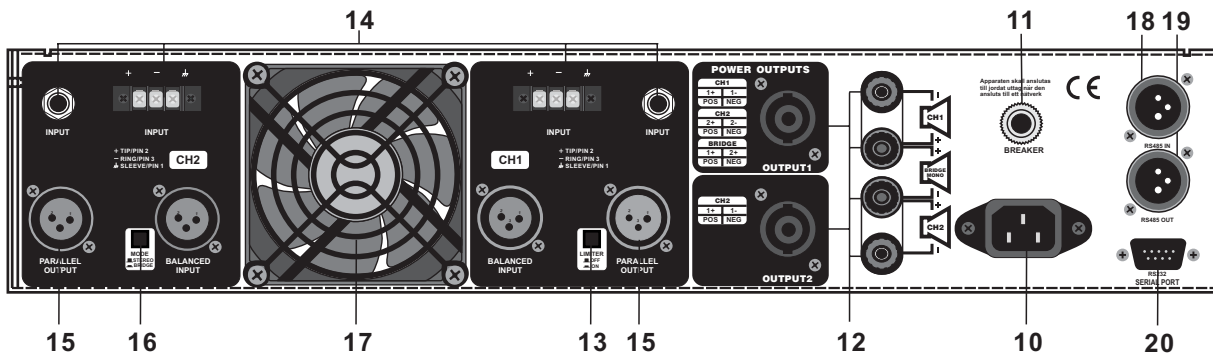

10. Power Source Socket

It is used to connect power cord after setting the proper voltage, connect one end of power cord with the unit and another end with mains.

11. Breaker

This switch functions as fuse for protecting the unit from damage. When the unit is overloaded or the temperature inside the unit is too high, this pushing button will spring up and break the power supply. The power supply will be recovered after pushing this switch down again.

12. Output Connector

These connectors have two kinds: Binding post and Speak-on connector. You can choose proper connectors according to practical need. For your safety, please be careful when do connecting work.

13. Limiter Switch

Set this switch at "ON" position, once the output level is above maximum output level, the limiter begins, thus keeping consistent output level for protecting apparatus. If the switch is set at "OFF", the limiter function doesn't work.

14. Balanced Input Connectors

These connectors connect the input signal of channel 1 and channel 2 separately.

15. Parallel Output Connectors

These two output connectors are paralleled inside with the two input connectors. It enables the unit to work under paralleled mode. Please also refer to wiring diagram for paralleled mode.

16. Mode Selector

Total two optional modes: Up for Stereo mode; Down for Bridge mode.

- Stereo Mode

In this mode, channel 1 and channel 2 operate independently (just as traditional stereo amplifier). The signal input into channel 1 can be output from channel 1 only, similarly, the signal input into channel 2 can be output from channel 2 only. You can also operate the paralleled mode via outside wiring, so, the signal input from channel 1 or 2 will be output from both channel 1 and 2 simultaneously. Details refer to the chapter 9.

- Bridge Mode

In this mode, the signal input into channel 1 will be output from the bridged end, on the other hand, the output level control of channel 2 should be turned down to smallest. Details refer to the chapter 9.

17. Fan

The fan can accelerate the flow of air to lower the temperature inside unit. The inside temperature determines the fan speed which controls the inside air flowing speed.

18. RS485 IN

The function of the RS485 IN is opposite to RS85 OUT. It allows incoming communication between a DPA2500 /4000 stereo amplifier and PC or another DPA2500/4000 stereo amplifier. The RS485 port is very suitable for remote control over long distances (Difficult with RS232 standard ports) and daisy-chaining several DPA2500 /4000 stereo amplifiers.

19. RS485 OUT

This is the standard serial communication interface. It allows outgoing communication between a DPA2500 /4000 stereo amplifier and PC or another DPA2500/4000 stereo amplifier. The RS485 port is very suitable for remote control over long distances (difficult with RS232 standard ports) and for daisy-chaining several DPA 2500/4000 stereo amplifiers.

20. RS232 Serial Communication Port

The RS232 port allows incoming and outgoing communication between the DPA2500/4000 stereo amplifier and PC via connecting the DPA2500/4000 stereo amplifier to a PC, all the processor functions are possible to be controlled remotely by ALTO editing software.

4. GETTING STARTED

Switching on the DPA2500/4000, after an initialization procedure, the last selected preset and settings will be loaded, the number of last preset will appear on the display:

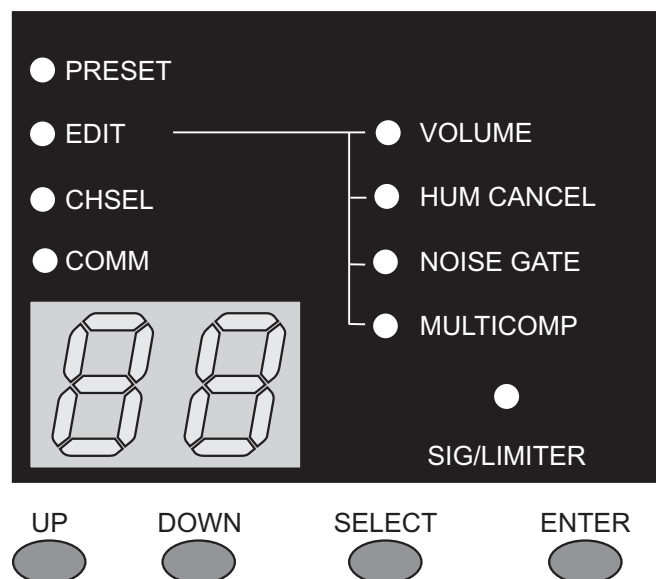

4.1 Preset Selection

There are total 33 presets available: (factory preset: 01, user preset 01.~32.)

- Select "PRESET" using SELECT key, the "PRESET" indicator lights up and the last selected preset will appear on the display.
- Use UP/DOWN keys to select a desired preset.
- Press ENTER key to load the preset.

4.2 EDIT Menu

This menu includes 4 items: VOLUME, HUM CANCEL, NOISE GATE, MULTICOMP.

- Volume Adjustment (-99~0dB)

- Select "EDIT" menu using SELECT key, both the "EDIT" and "VOLUME" indicators will light up, and the last selected volume level will be displayed.
- Press ENTER key till an additional "." appeared after the present volume value.
- Use UP/DOWN keys to adjust the level of output signal.

Note: this adjustment of volume level effects only on the selected channels.

- Hum Cancel (ON/OFF)

- Select "EDIT" using SELECT key.
- Then select "HUM CANCEL" using UP/DOWN keys, both the "HUM CANCEL" and "EDIT" indicators will light up.
- Press "ENTER" to set Hum Cancel function ON or OFF.

Note: the HUM CANCEL indicator will be lighting all the time if you set this function ON, and it effects only on the selected channels.

- Noise Gate (ON/OFF)

- Select "EDIT" using SELECT key.
- Then select "NOISE GATE" using UP/DOWN keys, both the "EDIT" and "NOISE GATE" indicators will light up.
- Press ENTER key to set Noise Gate ON or OFF.

Note: the NOISE GATE indicator will be lighting all the time if you set this function ON, and it effects only on the selected channels.

- Multicomp (ON/OFF)

- Select "EDIT" using SELECT key.
- Then select "MULTICOMP" using UP/DOWN keys, both the "EDIT" and "MULTICOMP" indicators will light up.
- Press "ENTER" to turn the Multiband compressor ON or OFF.

Note: this indicator will be lighting all the time if you set this function ON, and it effects only on the selected channels.

4.3 Channel Selection

There are total 3 options available (CH1, CH2, CH1+CH2), you can apply these effect settings on either or both selected channels.

- Select "CHSEL" using SELECT key, the "CHSEL" indicator lights up and the last selected channel will be displayed.
- Use UP or DOWN key to select either or both channels.
- Press ENTER key to confirm your selection.

4.4 Comm Selection:

It sets the ID number of the unit (1 in the default condition, 32 available).

- Select "COMM" using SELECT key, the "COMM" indicator lights up and the last selected ID number will be displayed.
- Use UP/DOWN keys to set the new ID number.
- Press ENTER key to confirm the new ID number.

4.5 SIG/LIMITER LED

The LED shows yellow when there is signal present.

The LED shows red when the signal is limited, it indicates that the signal is too strong and possibly distorted.

5. REMOTE CONTROL

To operate one or more DPA units that are connected to a PC, you need to download a Windows compatible MAXI EDITOR program from our website. To get a copy, please go to <http://www.altoproaudio.com/html/download.php>.

IMPORTANT!!!

In Remote Control mode, the panel controls of UP, DOWN, SELCTOR and ENTER will be disabled.

5.1 How to set the DPA's ID number

In order to be recognized from the MAXI EDITOR program, each DPA connected to the PC must have an ID number.

- Select the COMM menu with the SELECT button, the display will show the current ID number of the unit.
- Use the UP/DOWN keys to select the ID number.

IMPORTANT!!!

When several DPA are connected to a PC for the remote control, each of units must have an ID number different from all the others. If two or more units have the same ID number, they won't be recognized by the PC.

5.2 Connection to the PC

- Connect the First DPA to the PC's RS232 serial port, using a 9-pin female plug connected to the RS232 socket on the rear panel of unit.
- Connect RS485 IN of the Second DPA to the First DPA 's RS485 OUT socket, in this way, you can connect up to 32 DPA units for a same PC.

IMPORTANT!!!

If the first unit is placed at a distance to the PC that exceeds 5 meters, RS232 to RS485 converters must be used to reach it. And the first unit connected to the PC thru RS232 must be switched ON and working, otherwise none of the other units can be controlled by the PC.

Connection Diagram of Remote Control

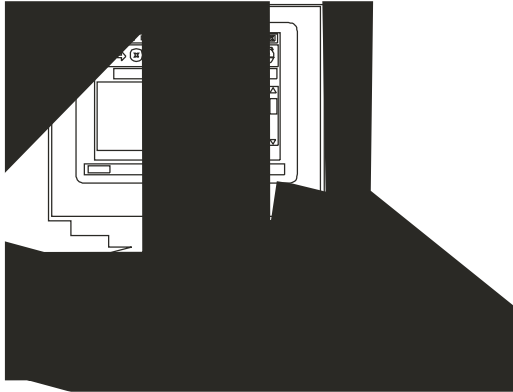

5.3 First Steps with the PC Editor

To avoid accidentally overwriting an existing PRESET, it is important that you follow the correct routine when initiating a session between the DPA unit and your computer.

- 1>. With the DPA unit powered up and connected to your PC's serial port as described, run the PC Editor program by selecting the MAXI EOITOR icon in the Windows PROGRAMS menu.

2>. The PC Editor should now load. A welcome screen will appear. This closes after 5 seconds (or click on it). Select NEW from the FILE menu. A window will open showing several different model names, because the same software is used for some of our pro audio models. Select DPA amp and click OK.

You will then be presented with 2 options NEW UNIT and NETWORK SCAN.

If your DPA unit has already been installed and set-up and you now wish to view and/or modify some parameters, do the following:

Select NETWORK SCAN. The program will scan your PC's serial ports. When Done, it will present a list of IDs. The ID number of the DPA unit is 1 (this cannot be changed). The ID list will show if the DPA unit (ID 1) is correctly connected or not. Pressing OK will prompt the system to retrieve (upload) all the parameters and all previously saved USER PRESETS from the DPA unit to your computer. A window will automatically open on your computer screen. You can now view the settings and edit them (depending on the Lock mode).

If your DPA unit has not been set-up yet, or if you want to replace the existing set-up, you can create a new named profile (NEW UNIT) within the PC Editor. Here's how:

Select NEW from the FILE menu, then DPA amp and click OK. Select NEW UNIT. In the window that appears, type a new name for the unit you are creating (this is optional). The GANGING (* more Information follows) option should generally be left at their default settings (unchecked).

Press OK and a window corresponding to the unit you have just named will open up with the factory default set-up configuration and the block diagram.

Choose ONLINE from the ACTIONS menu and the PC will scan the serial port to verify that the DPA unit is correctly connected. The NETWORK SCAN window should show the system status (UNIT CONNECTED or NOT CONNECTED). Pressing OK will cause all the parameters set in the PC Editor to be downloaded to the DPA unit. An ONLINE icon will appear to show that the DPA unit and PC are now ready to transfer control data in real-time.

* **Ganging:** The inputs and each pair of outputs be "ganged" (linked together) as stereo pairs, so that changes are simultaneously applied to both channels. This is achieved via the MODIFY UNIT option in the ACTIONS menu of the PC Editor. However, if you intend to use the channel delay function for speaker 'time alignment' then you should NOT gang the channels.

Every time a download is made to the DPA unit, the user presets in the internal memory (and any unsaved set-up you were working on) are overwritten. Selecting OFFLINE from the ACTIONS menu will cause the PC to be disconnected from the DPA unit. Be aware that immediately selecting ONLINE again will prompt the PC Editor to perform a new scan of the network and automatically download the settings from the PC to the DPA unit.

If you do not wish this to happen (i.e. if you do not wish to overwrite the current data in the DPA unit), then you must initiate a new session by closing the current window and then selecting NETWORK SCAN (File >New >DPA unit> Network Scan) so that the DPA unit uploads to the PC.

Every time an upload is made, all the USER PRESETS stored in the DPA unit are transferred to the corresponding numbered presets within the PC Editor.

5.4 Edit Mode (Password Protection)

DPA unit incorporates a password system and your installer may have set a password to ensure that vital settings are not altered. In this case you will NOT be able to alter any of the parameters via the PC Editor.

In the PC Editor, select FILE > OPTIONS and then the LOCK tab. This will present you with a menu:

Full Edit:

This is the DEFAULT mode. No password is set at the factory. From here you can lock the unit by clicking the Total Lock buttons. A text box will open, allowing you to enter a password of your own choice. Click OK. important that you remember this password.

Total Lock:

No editing is possible in this mode. To disable the lock, click within the empty Full Edit button. A text box will open, type the password that was used to set lock mode. press OK.

5.5 Help File

The HELP file accessible from within the PC Editor will be updated as necessary. Since software updates after the printing of this manual may affect the instructions provided here, please check the Help File for any later remarks.

5.6 Introduction to the PC Editor

When you launch the editor on your PC, you will see the opening screen following (later software versions may differ). Each of the numbered sections is explained in this page - just look for the number icons within the text.

Please note that a Windows compatible PC Editor is available for free download from our web site. (see page 7)

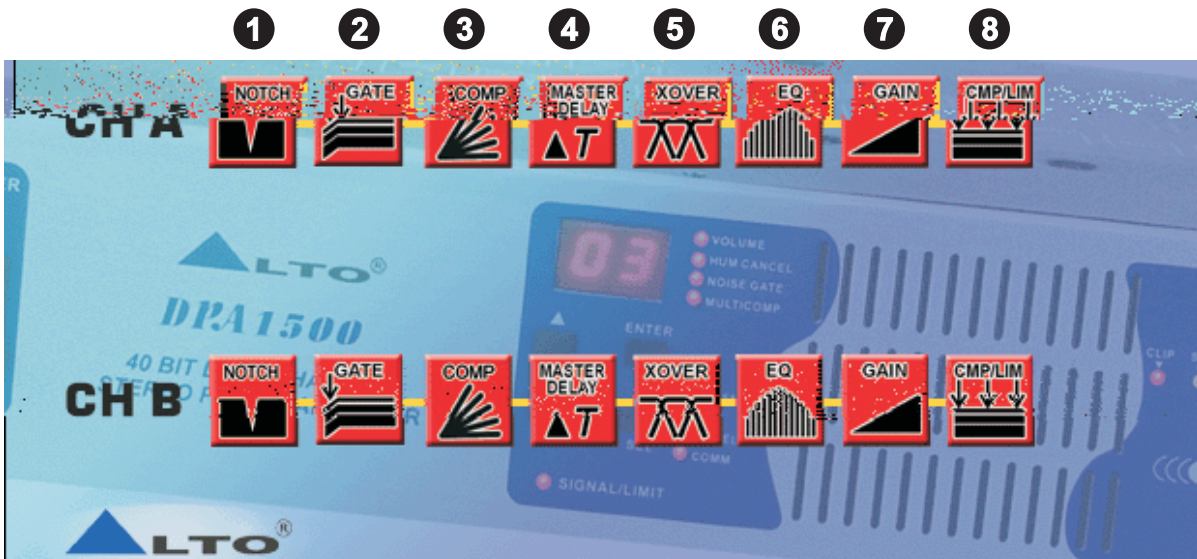

Click on one of the icons on the PC Editor, a window will appear showing one of several "pages" where you can set the parameters using virtual knobs and sliders or by typing the values. Here is a brief overview of the various functions that make up the PC Editor (community software). Each is explained in more detail in the next section.

1 NOTCH

You can turn on or off the dynamic notch filter and adjust its parameters.

2 NOISE GATE

You can set the DPA unit to cut the signal if it falls below a certain level. Most often used to cut the background noise between music tracks.

3 COMP

It's a multi-band compressor allowing you determine the amount of level gain (ie, increase in volume) above a threshold point that you set.

4 MASTER DELAY

Allows a delay to be applied in order to time align" each individual output channel.

5 CROSSOVER (XOVER)

The DPA unit is equipped with independent HIGH-PASS and LOW-PASS filters on each of the 2 output channels. For each filter there are 10 different filter type/slope options.

6 EQ

Each of the channel has a fully variable 10-band parametric equalizer.

7 GAIN

From here you can adjust the OUTPUT LEVEL, the MUTE, the PHASE etc.

8 CMP/LIM

Each output channel has its own independent COMPRESSOR/LIMITER. careful setting of this parameters will help to maintain a more consistent and pleasant listening level and extend the performance of your speakers.

6. PARAMETER MENUS DESCRIPTION

- **HUM CANCEL:** allows the modification of the dynamic NOTCH filter parameters. The graph included shows the filter response curve.
- **NOISE GATE:** allows the modification of the noise gate parameters. The graph included shows the filter curve.
- **MULTICOMP:** allows the modification of the multiband compressor parameters. The graphs below show the response curves of the two compressors.
- **DELAY:** allows to apply a delay to each amplifier's channel, with the possibility to set it in metric units (millimeters and meters) and time unit (microseconds and milliseconds). It's also possible to set the ambient temperature for the correct conversion of the distances in delay time.
- **CROSSOVER:** allows the modification of the HPF and LPF CROSSOVER filters, including FREQUENCY, TYPE (Linkwitz/Riley, Bessel and Butterworth), SLOPE (6, 12, 18, 24 or 48 db/oct.) and PHASE (related to the LPF frequency). The graph below shows the response curves of the selected channel.
- **EQ:** allows the modification of the EQ filters parameters. The graph below shows the response curves of the input. The 10 EQ filters can be edited not only typing the values in the parameter fields, but also in a graphic way. Each filter is identified by a different color: dragging the red box on the response curve, frequency and gain of the corresponding filter will be modified at the same time.
- **GAIN / COMP:** allows the OUTPUT LEVEL, the MUTE, the PHASE and the COMPRESSOR/LIMITER parameters to be set. In addition, in this page the output levels and the LIMITER action are displayed.
- **GLOBAL:** this windows shows the response curves of the system's outputs.

7. WORKING WITH PRESETS

At the lower edge of the PC Editor window is a series of commands for recalling and storing PRESETS.

To load a PRESET:

Click on *RECALL* and then on one of the numbered red (FACTORY) or green (USER) PRESET buttons. The selected PRESET will be loaded and its name displayed in the text box.

To save a PRESET:

Click on *STORE* and then on one of the grey or green buttons (USER PRESETS). The grey color means it is an empty PRESET. The green color means there is already a set-up stored at that position (which will be overwritten if you proceed). In the window that appears, type a new PRESET NAME, then press *OK*. The new setup is now saved as a PRESET, with its name displayed in the text box. But you still need to save to a file, as follows:

Save All Settings:

You must now save your settings (which may include several different PRESET set-ups) as a **Maxi Editor File** (*.mxe) on your computer. Go To *FILE*, and then *SAVE AS*. A window will open for you to select a destination folder for the file. You can keep the default filename or type one of your own.

When you have done this, take the offline (click on the icon) and then online again. This will force the PC Editor to do a network scan. Press *OK* and the full system settings, including your latest PRESET, will now be downloaded and stored in the unit's internal memory.

Remember that every time you download from your PC to the DPA unit, the USER PRESETS in the internal memory are replaced.

8. CONNECTIONS

The following diagrams show the schemes of the recommended cables and some connection examples referred to various system configurations.

Inputs A & B, RS485 IN

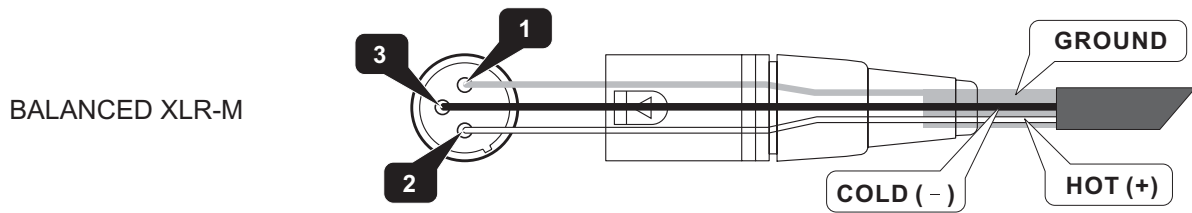

Inputs A & B

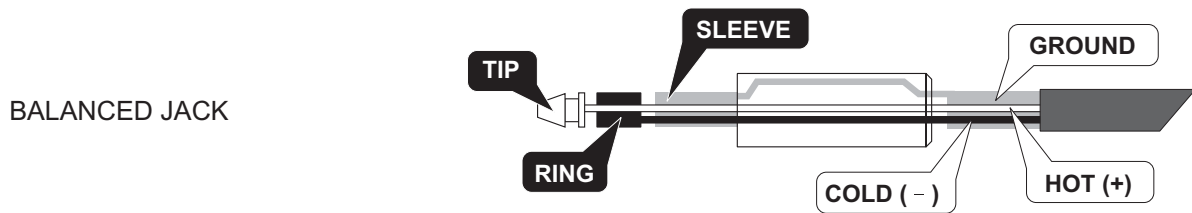

Parallel Output Connectors, RS485 OUT

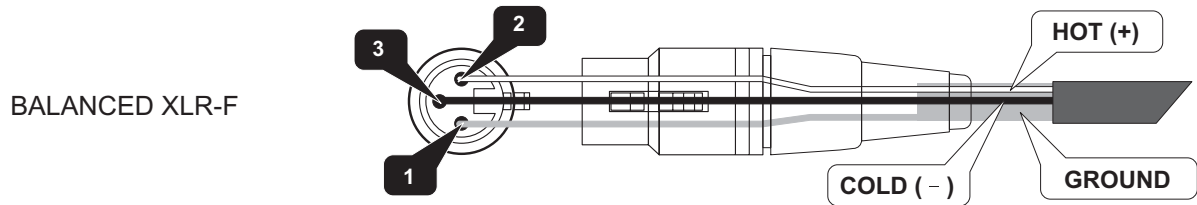

RS232

RS232 (9-Pin)

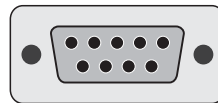

You can also operate the paralleled mode via outside wiring, so the signal input from channel 1 or 2 will be output from both channel 1 and channel 2 simultaneously. The volume of channel 1 or channel 2 can be controlled separately.

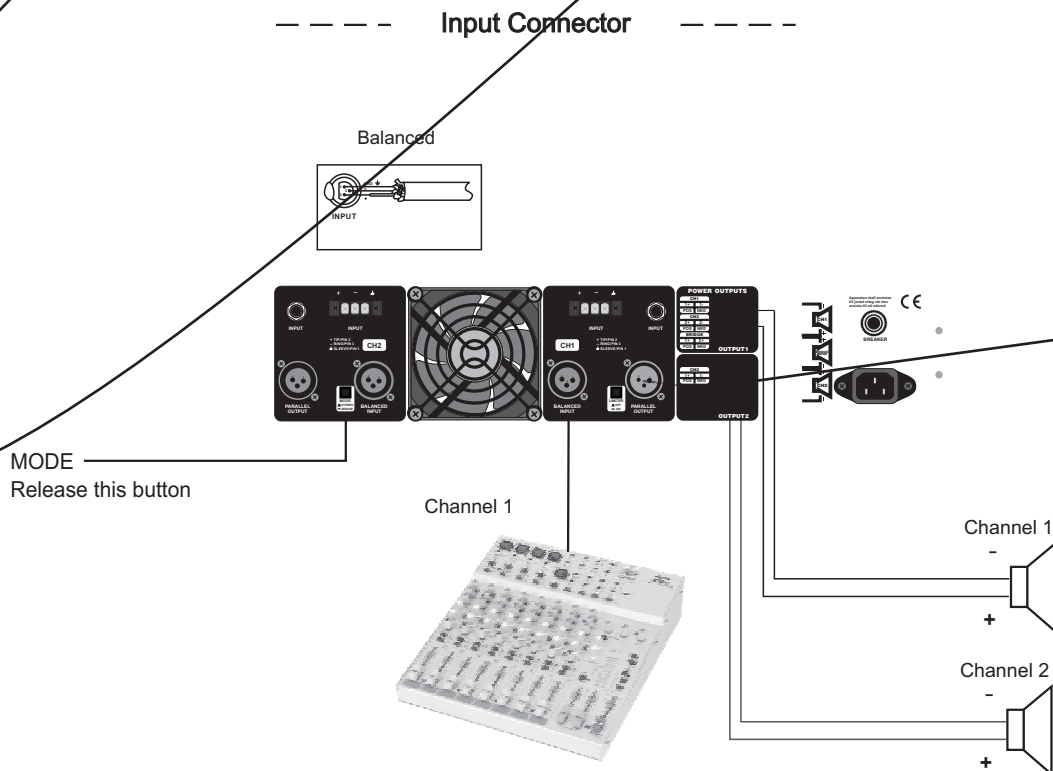
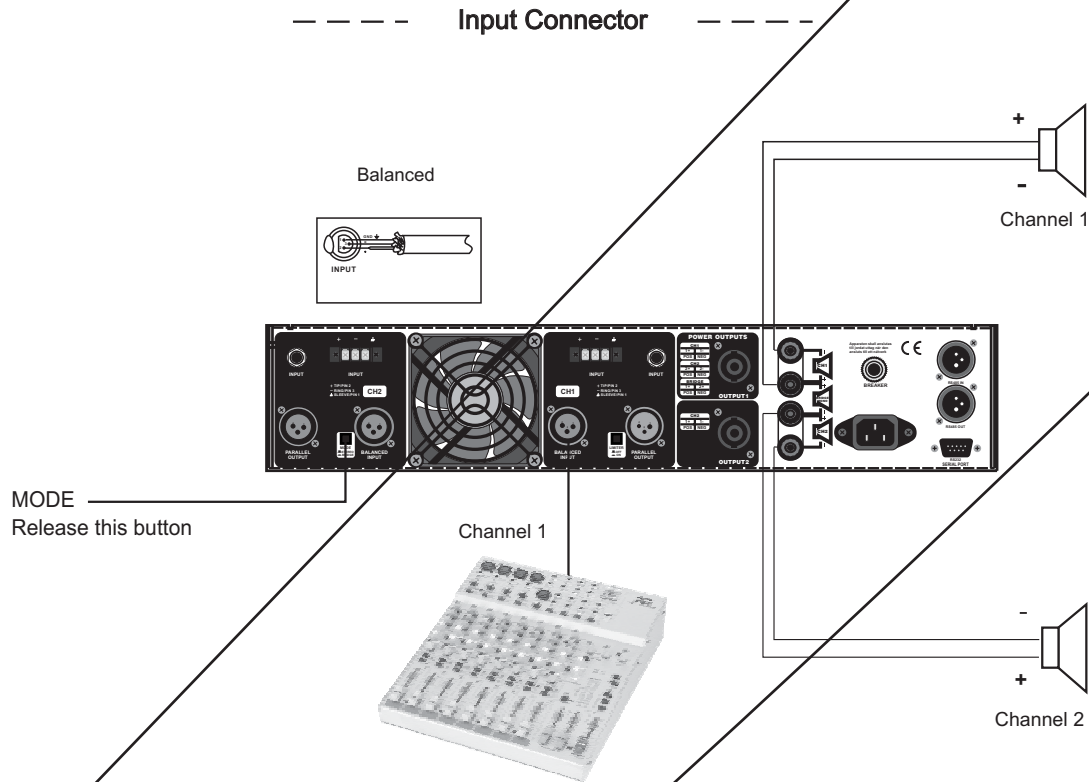

----- Input Connector -----

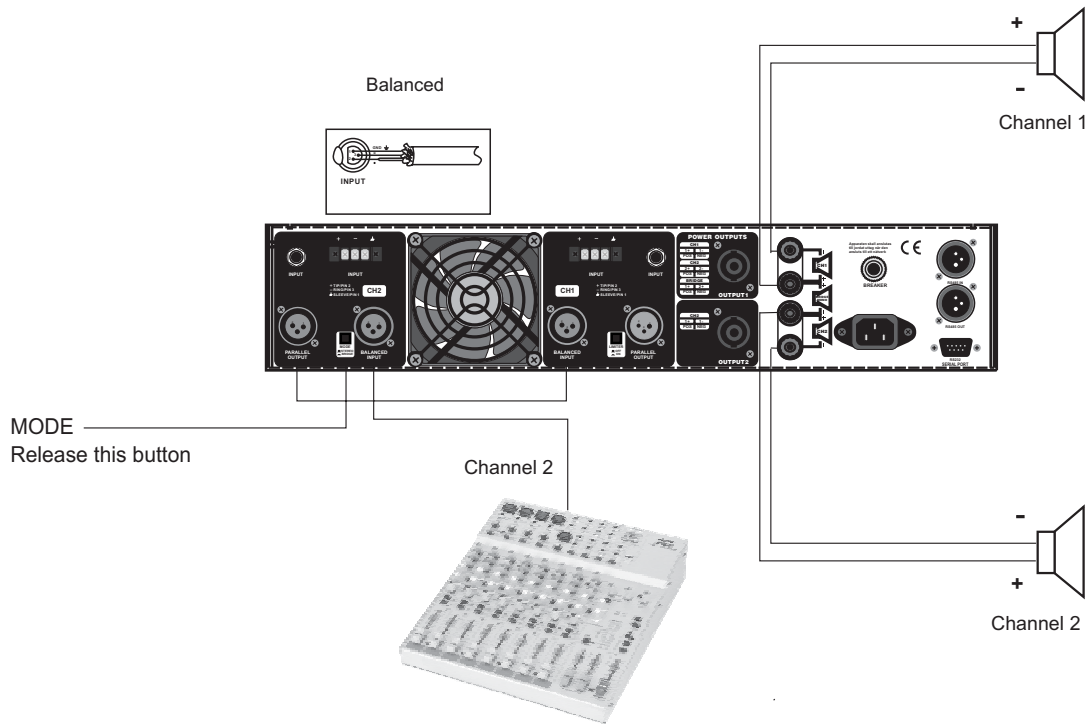

----- Input Connector -----

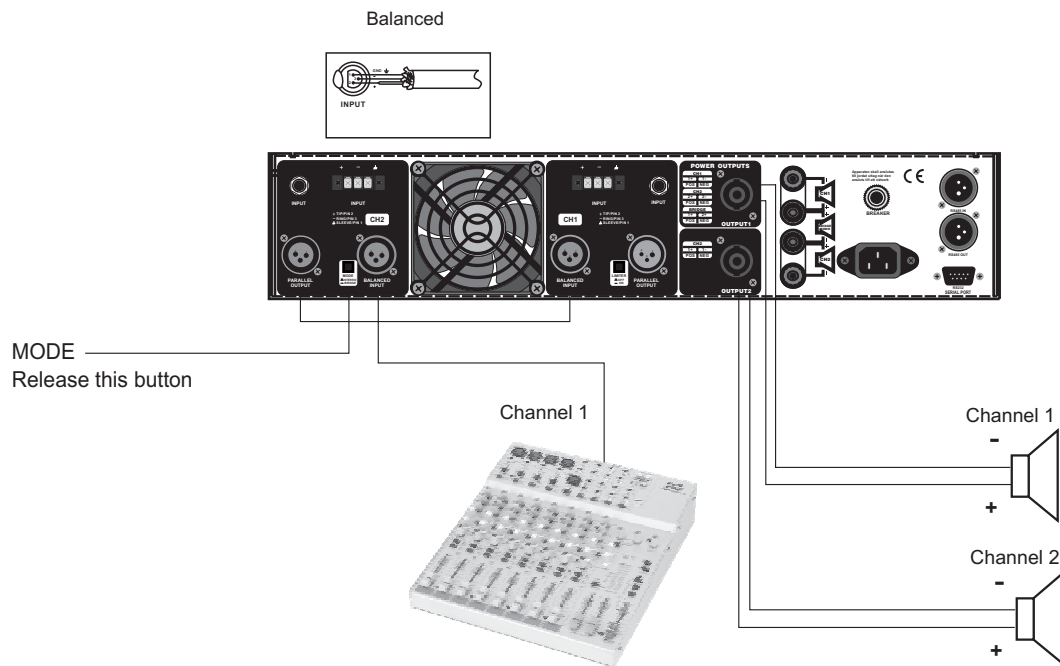

9.2 Bridge Mode

In this mode, the signal input into channel 1 will be output from the bridged end, on the other hand, the output level control of channel 2 should be turned down to smallest (turn the volume control at counterclockwise). Only the volume control of channel 1 is used to control the volume of whole system.

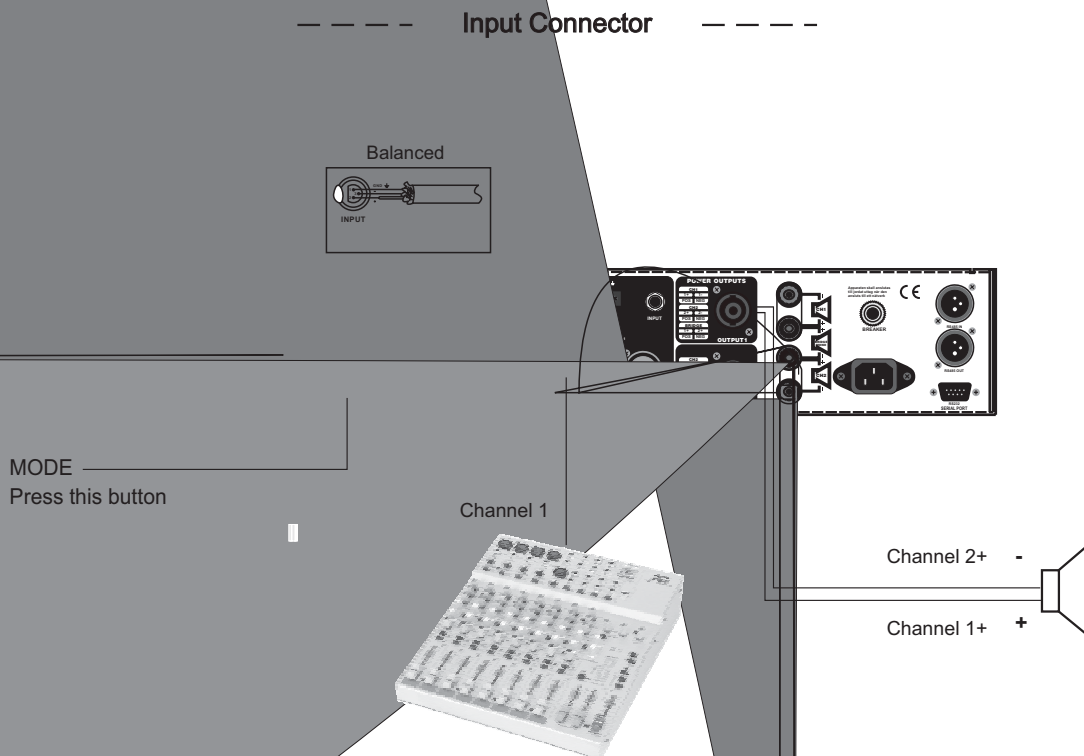
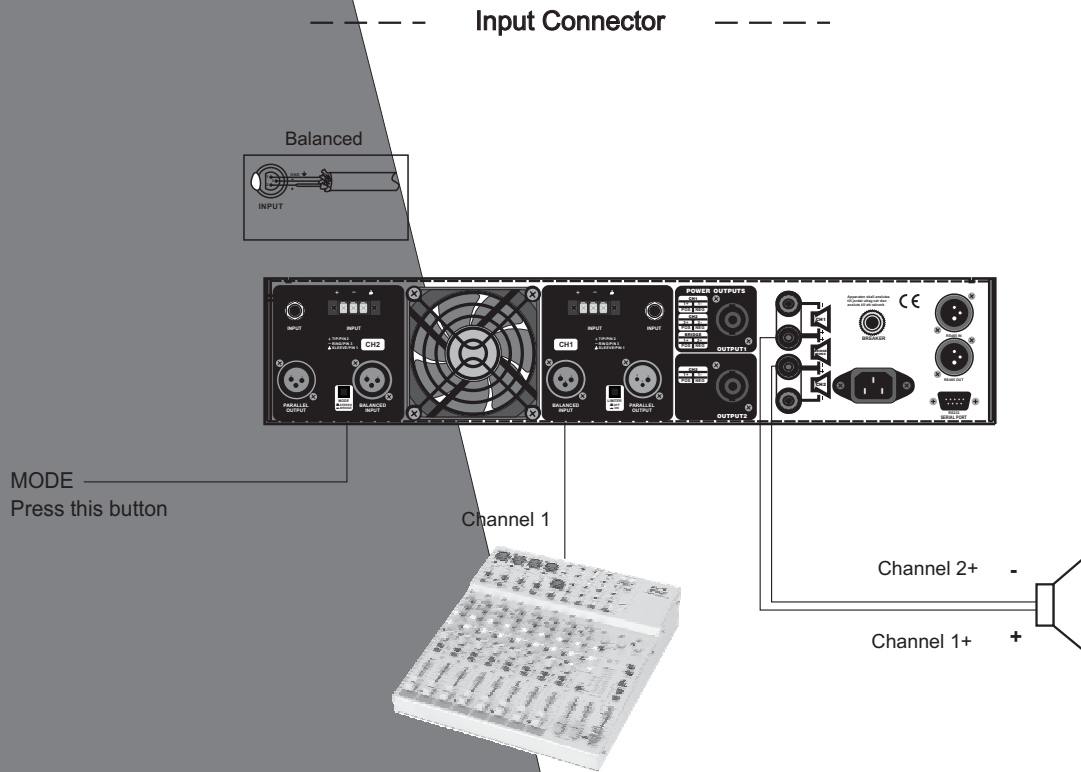

10. TECHNICAL SPECIFICATIONS

MODEL	DPA2500/4000 40 Bit DSP Enhanced Stereo Amplifier
20Hz 20KHz@0.1% THD, Stereo Mode	
8 ohms per channel(EIAJ)	460W / 625W
4 ohms per channel(EIAJ)	830W / 1000W
Bridge Mono Mode	
8 ohms, 1KHz, 0.1%THD	1400W / 2000W
Distortion (SMPTE-IM)	<0.05%
Frequency Response	20Hz-20KHz±1dB, -2dB points: 20Hz-20KHz
Damping Factor, 1 kHz and below	>300 at 8ohms
Signal to Noise,20Hz-20KHz	102dB
Voltage Gain	40x (32dB)
Input Sensitivity @ 4 ohms	1Vrms
Input Clipping	10Vrms (+22dB)
Input Impedance	10K ohms unbalanced, 20K ohms balanced 56 (36dB)
Controls	FRONT: AC SWITCH, CH1&2 GAIN KNOBS, DSP controls REAR: LIMITER, BRIDGE SELECTOR
Indicators (1 per channel)	Power-On: Blue LED Operation/protection: Dual Color(Green/Red LED) Limit: Red LED Clip: Red LED
Connectors, each channel	Input: Active balanced XLR Parallel Output : XLR Output: NEUTRIK Speakon and Binding posts
Cooling	Continuously variable-speed fan, rear-to-front air flow
Load Protection	On/off muting, DC-fault load grounding relay. Internal fault fuses.
Power Requirements	200-240(100-120) Vac 50~60Hz
Dimensions	19"(48.3cm) rack mounting, 3.5"(8.9cm) tall(2 rack spaces), 15.9"(40cm) deep (rack mounting to rear support ears)
Net Weight	18.1kg / 20.5kg

11. WARRANTY

1. WARRANTY REGISTRATION CARD

To obtain Warranty Service, the buyer should first fill out and return the enclosed Warranty Registration Card within 10 days of the Purchase Date.

All the information presented in this Warranty Registration Card gives the manufacturer a better understanding of the sales status, so as to purport a more effective and efficient after-sales warranty service.

Please fill out all the information carefully and genuinely, miswriting or absence of this card will void your warranty service.

2. RETURN NOTICE

2.1 In case of return for any warranty service, please make sure that the product is well packed in its original shipping carton, and it can protect your unit from any other extra damage.

2.2 Please provide a copy of your sales receipt or other proof of purchase with the returned machine, and give detail information about your return address and contact telephone number.

2.3 A brief description of the defect will be appreciated.

2.4 Please prepay all the costs involved in the return shipping, handling and insurance.

3. TERMS AND CONDITIONS

3.1 ▲LTO warrants that this product will be free from any defects in materials and/or workmanship for a period of 1 year from the purchase date if you have completed the Warranty Registration Card in time.

3.2 The warranty service is only available to the original consumer, who purchased this product directly from the retail dealer, and it can not be transferred.

3.3 During the warranty service, ▲LTO may repair or replace this product at its own option at no charge to you for parts or for labor in accordance with the right side of this limited warranty.

3.4 This warranty does not apply to the damages to this product that occurred as the following conditions:

- Instead of operating in accordance with the user's manual thoroughly, any abuse or misuse of this product.
- Normal tear and wear.
- The product has been altered or modified in any way.
- Damage which may have been caused either directly or indirectly by another product / force / etc.
- Abnormal service or repairing by anyone other than the qualified personnel or technician.

And in such cases, all the expenses will be charged to the buyer.

3.5 In no event shall ▲LTO be liable for any incidental or consequential damages. Some states do not allow the exclusion or limitation of incidental or consequential damages, so the above exclusion or limitation may not apply to you.

3.6 This warranty gives you the specific rights, and these rights are compatible with the state laws, you may also have other statutory rights that may vary from state to state.

SEKAKU ELECTRON INDUSTRY (H.K.) CO. LTD.

No.1, Lane 17, Sec. 2, Han Shi West Road, Taichung, 401 TAIWAN

<http://www.altoproaudio.com> Tel:886-4-22313737

email: alto@altoproaudio.com Fax:886-4-22346757

All rights reserved to ALTO. All features and content might be changed without prior notice. Any photocopy, translation, or reproduction of part of this manual without written permission is forbidden. Copyright © 2004 Sekaku Electron

Free Manuals Download Website

<http://myh66.com>

<http://usermanuals.us>

<http://www.somanuals.com>

<http://www.4manuals.cc>

<http://www.manual-lib.com>

<http://www.404manual.com>

<http://www.luxmanual.com>

<http://aubethermostatmanual.com>

Golf course search by state

<http://golfingnear.com>

Email search by domain

<http://emailbydomain.com>

Auto manuals search

<http://auto.somanuals.com>

TV manuals search

<http://tv.somanuals.com>