

MH240 Wireless IP Telephone

USER'S GUIDE

Model: IP3NA-8WV(USA) / IP3AT-8WV(Australia) / IP3PH-8WV(EU)

Before using your product, read this User's Guide thoroughly to ensure correct handling.

After reading the User's Guide, keep it in a place that is accessible for read reference.

A50-017158-001 Issue1.2, January 2009

LIABILITY DISCLAIMER

NEC Infrontia Corporation reserves the right to change the specifications, functions, or features, at any time, without notice.

NEC Infrontia Corporation has prepared this document for use by its employees and customers. The information contained herein is the property of NEC Infrontia Corporation and shall not be reproduced without prior written approval from NEC Infrontia Corporation. All brand names and product names on this document are trademarks or registered trademarks of their respective companies.

Copyright 2009

NEC Infrontia Corporation

User Safety Protocol

Important: Read this information before using your MH240 Phone.

Read the following instructions for the safe use of this product to prevent you and other people from possible injury, and possible damage to property. Improper handling may cause heat, explosion, and/or fire.

Danger

- Recharge the battery with the matching battery charger only (see battery label description).
- Use the battery only for this MH240 phone system. Do not use it with other electrical devices.
- To prevent the battery pack from overheating, exploding, or catching fire:
 - Do not throw the battery pack into fire.
 - Do not solder the battery pack directly.
 - Do not short the positive (+) and negative (-) terminal of the battery pack with metal.
 - Do not poke the battery or otherwise damage the battery.
- Do not disassemble or modify the battery pack. It has a safety circuit and if damaged may cause heat, explosion, and fire.
- The internal liquid of the battery pack has strong acid. If the battery liquid gets into your eye, rinse your eye well with water and consult with a doctor.
- Do not use, leave, or recharge the battery pack near fire or under the direct sunlight. High temperature may damage the internal safety circuit and may cause a recharge malfunction, overheating, exploding, or catching fire.

Warning

- Do not use the unit if you notice smoke, a strange smell or other unusual happenings. It may cause fire if continuously used. Turn off the power switch of the phone system immediately. For the recharger, disconnect the power plug immediately. Make sure that the smoke stops, and then contact the nearest NEC service office. Never attempt to repair the unit yourself.
- If unit is damaged, turn off the power of the phone system immediately. For the recharger, disconnect the power plug immediately. Contact the nearest NEC service office. If you keep using the unit, it may cause fire or electrical shock.
- If water gets into the unit, turn off the power of the phone system immediately. For the recharger, disconnect the power plug immediately. Contact with the nearest NEC service office. If you keep using the unit, it may cause fire or electrical shock.
- Do not insert flammable or metal objects into the unit. If a foreign object is accidentally placed into the unit, turn off the power of the phone system and disconnect the power adapter. Contact the nearest NEC service office. If you keep using the unit, it may cause fire or electrical shock. Keep out of reach from children.
- Do not attempt to disassemble or modify the unit. It may cause fire, electrical shock, or system malfunction. Modification by a user is prohibited by law.
- Do not open the unit. It may cause electrical shock or system malfunction. For test adjustments or repairs, contact the nearest NEC service office.
- Do not twist, put heavy objects on top of, or push the phone system. Such actions may cause damage, fire, or injuries.
- Do not place containers with water such as a vase, a plant pot, a cup, cosmetics, or chemicals on top of the unit. Splashing water over the unit may cause fire or electrical shock.
- Do not use the unit in a high humid area such as a bathroom or near a humidifier. It may cause fire, electrical shock, or system malfunction.
- Only use the specified power adapter, which is attached to the unit. Other adapters may cause fire or system malfunction.
- Do not damage or modify the power adapter cord. Kinking, pulling, twisting, bundling, heating or putting heavy objects on it may cause fire, electrical shock, or system malfunction. Contact the nearest NEC service office if you have a damaged adapter cord.
- Do not touch the power plug with a wet hand. It may cause electrical shock or system malfunction.
- Do not touch the unit or replace a battery with a wet hand. It may cause electrical shock or system malfunction.
- When you hear thunder outside during use of the phone system, immediately stop using it and move to a safe place.
- Do not use multiple plugs in a single outlet. It may cause fire or electrical shock.

- Follow the instruction below when you use a battery pack. They may cause heating, explosion, and fire;
 - Do not put the battery pack into a microwave oven or a pressure chamber.
 - Do not use other batteries with this battery pack.
- If the internal battery liquid gets onto your skin or clothes, immediately rinse it with clean water to prevent chemical damage to your skin and clothes.
- Do not use the phone or recharge the battery in a place where fire or explosion may occur.
 - This phone system does not have explosion protection. Do not use it where a flammable gas such as propane and gasoline are stored. Turn off the power of the phone immediately. Do not recharge the battery in such a place.
- Do not use near microwave ovens, medical equipment and industrial equipment.

This page is for your notes.

FCC Portion

This equipment has been tested and found to comply within the limits for a Class B digital device, pursuant to Part 15 of the FCC rules. These limits are designed to provide reasonable protection against harmful interference in a residential installation. This equipment generates, uses, and can radiate radio frequency energy and, if not installed and used in accordance with the instructions, may cause harmful interference to radio communications. However, there is no guarantee that interference will not occur in a particular installation. If this equipment does cause harmful interference to radio or television reception, which can be determined by turning the equipment off and on, the user is encouraged to try to correct the interference by one or more of the following measures:

- Reorient or relocate the receiving antenna.
- Increase the separation between the equipment and receiver.
- Connect the equipment into an outlet on a circuit different from that to which the receiver is connected.
- Consult the dealer or an experienced radio/TV technician for help.

This device complies with Part 15 of the FCC Rules. Operation is subject to the following two conditions: (1) This device may not cause harmful interference, and (2) This device must accept any interference received, including interference that may cause undesired operation.

Caution:

Any changes or modifications not expressly approved by the party responsible for product compliance could void the user's authority to operate the equipment.

To comply with FCC RF exposure compliance requirements, this device must not be co-located or operating in conjunction with any other antenna or transmitter.

Important Note:

This equipment complies with FCC radiation exposure limits.

<u>FCC Rule Parts</u>	<u>Frequency Range(MHz)</u>	<u>Output Watts</u>
15C	2412.0-2462.0	0.100

Power Output is Conducted. Body-worn operations are restricted to belt clips, holsters or similar accessories that have no metallic component in the assembly. End users must be informed of the body worn requirements for satisfying RF Exposure compliance. The highest reported SAR values are: Body-worn 0.15W/kg.

Industry Canada Portion

Canada Regulatory Compliance Statement

This Class B digital apparatus complies with Canadian ICES-003.
Cet appareil numérique de la classe B est conforme à la norme NMB-003 du Canada.

For Customers in Canada

This device complies with RSS 210 of Industry Canada (IC).
Operation is subject to the following two conditions:

- This device may not cause interference, and
- This device must accept any interference, including interference that may cause undesired operation of this device.

L'utilisation de ce dispositif est autorisée seulement aux conditions suivantes:

- il ne doit pas produire de brouillage et
- l'utilisateur du dispositif doit être prêt à accepter tout brouillage radioélectrique reçu, même si ce brouillage est susceptible de compromettre le fonctionnement du dispositif.

Exposure to radio frequency radiation

The installer of this radio equipment must ensure that the antenna is located or pointed such that it does not emit RF field in excess of Health Canada limits for the general population; consult Safety Code 6, obtainable from Health Canada's website at www.hc-sc.gc.ca/rpb.

European Union Information

Notice to the user

The handset described in this manual is intended to be used in combination with NEC Assured Mobility concept for Wireless Local Area Networks.

Country specific limitation

Italy

General authorization is required when this handset is used outside own premises.

For more information contact : www.comunicazioni.it

France

This handset should not be used in an outdoor environment.

Declaration of conformity

Hereby, “NEC Infrontia Corporation”, declares that this IP3PH-8WV (Commercial name: MH240) is in compliance with the essential requirements and other relevant provisions of Directive 1999/5/EC. For details, please access the following URL.

<http://www.nec-philips.com/doc>



European Union Information

Product disposal information

For countries in the European Union



The symbol depicted here has been affixed to your product in order to inform you that electrical and electronic products should not be disposed of as municipal waste. Electrical and electronic products including the cables, plugs and accessories should be disposed of separately in order to allow proper treatment, recovery and recycling. These products should be taken to a designated facility where the best available treatment, recovery and recycling techniques are available. Separate disposal has significant advantages: valuable materials can be re-used and it prevents the dispersion of unwanted substances into the municipal waste stream. This contributes to the protection of human health and the environment. Please be informed that a fine may be imposed for illegal disposal of electrical and electronic products via the general municipal waste stream.

In order to facilitate separate disposal and environmentally sound recycling arrangements have been made for local collection and recycling. In case your electrical and electronic products need to be disposed of please refer to your supplier or the contractual agreements that your company has made upon acquisition of these products.

At www.nec-philips.com/weee you can find information about separate disposal and environmentally sound recycling.

For countries outside the European Union

Disposal of electrical and electronic products in countries outside the European Union should be done in line with the local regulations. If no arrangement has been made with your supplier, please contact the local authorities for further information.

Battery information

Defect or exhausted batteries should never be disposed of as municipal waste. Return old batteries to the battery supplier, a licensed battery dealer or a designated collection facility. Do not incinerate batteries. This product uses Lithium-Ion batteries. Do not use any other type.

For battery replacement or removal instructions please refer to the related chapter in this manual.

TABLE OF CONTENTS

0.PRECAUTION

- SIGNAL WORDS..... 1
- SAFETY SYMBOLS..... 1
- IMPORTANT SAFETY INFORMATION 2

1.INTRODUCTION

- WHAT IS MH240? 5
- ABOUT THIS GUIDE 5
- KEYS AND PARTS 6
- ICONS 7
- STANDBY MODE 8
- MAIN MENU 8

2.GETTING STARTED

- HOW TO INSERT THE BATTERY 9
- HOW TO REPLACE THE BATTERY 9
- HOW TO CHARGE THE BATTERY 10

3.BASIC OPERATION

- TO POWER ON THE PHONE (STANDBY MODE) 13
- TO POWER OFF THE PHONE 13
- TO ANSWER A CALL 14
- TO MAKE A CALL 14
- TO PLACE A CALL ON HOLD 14
- TO TRANSFER A CALL 14
- TO REDIAL (LAST NUMBER REDIAL)..... 15
- TO USE MUTE MODE 15
- TO USE A HEADSET 16
- TO USE SOFT KEYS..... 16
- TO USE WHILE CHARGING 16

4.FEATURES

- TO USE CONFERENCE (3-WAY CALL)..... 17
- TO USE SPEAKERPHONE..... 17
- TO ADJUST CALL VOLUME 17
- TO USE COURTESY MODE..... 18
- TO USE KEY LOCK..... 18
- TO RECONNECT TO NETWORK..... 18

5. CALL HISTORY

- TO VIEW CALL HISTORY 19
- TO MAKE A CALL FROM CALL HISTORY 20
- TO ADD PHONE NUMBER TO DIRECTORY 20
- TO DELETE A CALL HISTORY 23
- TO DELETE ALL CALL HISTORIES 23

6. DIRECTORY

- TO VIEW DIRECTORY 25
- TO SEARCH DIRECTORY 25
- TO SETUP GROUP 28
- TO ADD A NEW ENTRY 29
- TO DELETE A RECORD 31
- TO DELETE ALL RECORDS 31
- TO MAKE A CALL FROM DIRECTORY 31
- TO EDIT AN ENTRY 32
- TO CONFIRM YOUR PHONE NUMBER 32

7. SPEED DIAL/PRESET DIAL

- TO USE SPEED DIAL 33
- TO ENABLE SPEED DIAL 33
- TO USE PRESET DIAL 34
- TO ENABLE PRESET DIAL 34
- TO ADD NEW ENTRY/EDIT 34

8. SETTING

- RING VOLUME 37
- RING TONE 37
- INCOMING POPUP 38
- ILLUMINATION 38
- PRIVATE CALL 39
- VIBRATION SETTING 39
- INCOMING MODE 40
- HEADSET 40
- OFFHOOK RING 41
- RTP ALARM 42
- HOLD MUSIC 42
- CALL VOLUME 43
- HANDOVER TONE 43
- TALK START VIBRATION SETTING 44
- LCD CONTRAST 44
- BACK LIGHT 45

- FONT SIZE 45
- LANGUAGE 46
- MY NAME 46
- DISPLAY PATTERN 47
- CHANGE PASSWORD 47
- KEY TOUCH TONE 48
- SPEAKER MONITOR 48
- DATE 49
- TIME 49
- TIME FORMAT 50
- DAYLIGHT SAVING 50
- NTP SETTING 51
- NTP SERVER 51
- TIME ZONE 52

9. INFORMATION

- TO DISPLAY STATUS 53
- TO DISPLAY WIRELESS STATUS 53
- TO DISPLAY IP ADDRESS 54
- TO DISPLAY SIP STATUS 54

10. PASSWORD LOCK

- TO USE MANUAL LOCK 55
- TO UNLOCK YOUR PHONE 55
- TO ENBLE MANUAL LOCK 55
- TO USE OUTSIDE LOCK 56
- TO USE POWER OFF LOCK 56

11. PREFIX DIAL

- TO USE PREFIX DIAL 57
- TO REGISTER PREFIX NO. 58

12. FAVORITES

- TO USE FAVORITES 59
- TO ENTRY A MENU TO FAVORITES 59
- TO DELETE A MENU FROM FAVORITES 59

13. MENU LIST

- MENU LIST 61
- CHARACTER CODE LIST 68

14.TROUBLE SHOOTING

- MESSAGE MEANINGS AND SUGGESTIONS 69
- TIPS AND SUGGESTIONS 70

15.SPECIFICATIONS

- TECHNICAL SPECIFICATIONS 71
- LED SPECIFICATIONS..... 72

16.LICENSE

0. PRECAUTION

 **To avoid serious injury or death, follow the safety information in this section.**

• SIGNAL WORDS



DANGER indicates a hazardous situation which, if not avoided, will result in death or serious injury.



WARNING indicates a hazardous situation which, if not avoided, could result in death or serious injury.



CAUTION, used with the safety alert symbol, indicates a hazardous situation which, if not avoided, could result in minor or moderate injury.



NOTICE is used to address practices not related to personal injury.

• SAFETY SYMBOLS



Hazard Alerting:

This type of safety symbol conveys information primary related to the nature of hazard.



Prohibition:

This type of safety symbol conveys actions that should not be taken.



Mandatory Action:

This type of safety symbol conveys actions that should be taken to avoid hazards.

• IMPORTANT SAFETY INFORMATION

⚠ DANGER



Observe these precautions when using a lithium-ion battery pack.

- Never charge the pack from other than the phone or the appropriate charger.
- The lithium-ion battery pack has a specified connector orientation. When inserting the pack into the phone, observe the correct connector orientation.
- Use a specified type of lithium-ion battery pack. Do not use the specified type of lithium-ion battery pack for any other device.
- Do not dispose of the lithium-ion battery pack in fires or heat it.
- Do not make direct soldering connections to the lithium-ion battery pack.
- Do not disassemble or tamper with the lithium-ion battery pack.
- Do not carry or store the lithium-ion battery pack together with metallic products, which could cause the pack to leak, heat or blast.



If the internal fluid in the lithium-ion battery pack should contact the eyes, it could threaten vision. Flush the eyes with plenty of fresh water immediately, without rubbing them, and obtain medical attention promptly.

⚠ WARNING



Do not remove the armor of the lithium-ion battery pack or scratch it, which could cause the pack to leak, heat or blast.



If the internal fluid in the lithium-ion battery pack should contact the skin or clothes, it could cause physical harm to the skin. Flush with plenty of fresh water immediately.



Do not soak the lithium-ion battery pack in water, seawater or moisten it, which could cause the pack to heat or rust.



Discontinue using the lithium-ion battery pack whenever any signs of abnormality, such as leaking, discoloration or deformation, are noticed.



Do not use the lithium-ion battery pack in bathrooms or shower rooms, which could cause the pack to short-circuit, resulting in fires or electrical shock hazards.



Do not use the lithium-ion battery pack in a place where it may be splashed or wetted with water, which could cause the pack to short-circuit, resulting in fires or electrical shock hazards.



Do not disassemble or tamper the products, which could result in fires or electrical shock hazards.



Do not allow water inside the lithium-ion battery pack or wet it with water, which could cause the pack to short-circuit, resulting in fires or electrical shock hazards.



Do not operate or make connections to the products, which could result in electrical shock hazards.



Do not put flower vases, plant pots, cups, cosmetics, containers filled with chemicals or water or small metallic objects near by the products, which could result in fires or electrical shock hazards if they spill or penetrate the interiors of the products.

▲ WARNING



Do not insert metallic objects or put metallic objects into the interiors of the products through openings, which could result in fires, electrical shock hazards or failures.



If it is necessary to use an AC adapter, use one of the specified type; otherwise, fires, electrical shock hazards or failures could result.

▲ CAUTION



Do not give violent shock to the lithium-ion battery pack or throw it.



Keep the lithium-ion battery pack out of reach of infants and children.



Do not leave the lithium-ion battery pack in the place exposed to direct sunlight or in a hot place. A heightened internal temperature could result in fires.



Do not place the products in a place where it could be splashed with heated oils or exposed to steam, such as near a cooking table, or in a dusty place, which could result in fires or electrical shock hazards.



Do not mount the products on a rickety table or in an inclined or unstable place, which could cause the products to tumble down out of balance or fall to cause physical injury.



Do not place the products in a place where it is liable to frequent vibration or impact, which could cause the products to fall or tumble down, resulting in physical injury.



Do not short-circuit the charging terminals.



Do not charge the phone seated in the cradle while the charging terminals are wet.



If foreign matter or water should penetrate the interior of the phone, disconnect AC adapter immediately and contact your dealer.

NOTICE

To use the products safely and properly, avoid installing it in these places:

- Places in which there is excessive dust or vibration.
- Places that are filled with vaporized chemicals or the products may be exposed to chemicals.
- Places close to radios, TV receivers or sources of intense magnetic fields.
- Places in which there are sources of high-frequency interference nearby, such as high-frequency sewing machines or electric welders.
- Distance the phone more than 50cm from Access Point.

This page is for your notes.

1. INTRODUCTION

• WHAT IS MH240?

MH240 is a wireless VoIP phone that complies with IEEE 802.11b/g specifications. MH240 has the following features:

- MH240 dedicated features are available such as Call History, Directory, Password Lock, Favorites, Speed Dial, Speaker monitor and Courtesy Mode.

• ABOUT THIS GUIDE

This guide explains operations, overview and specifications of MH240. But, some operations and display views may be different from actual operations and display views depending on your system. In this case, please contact your network administrator.

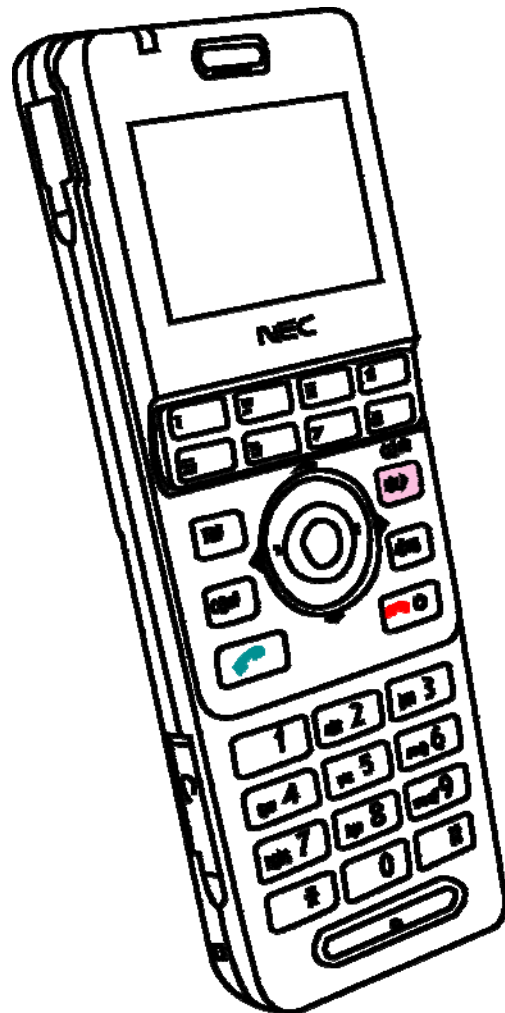

MH240

• KEYS AND PARTS

The phone has the following keys and parts.

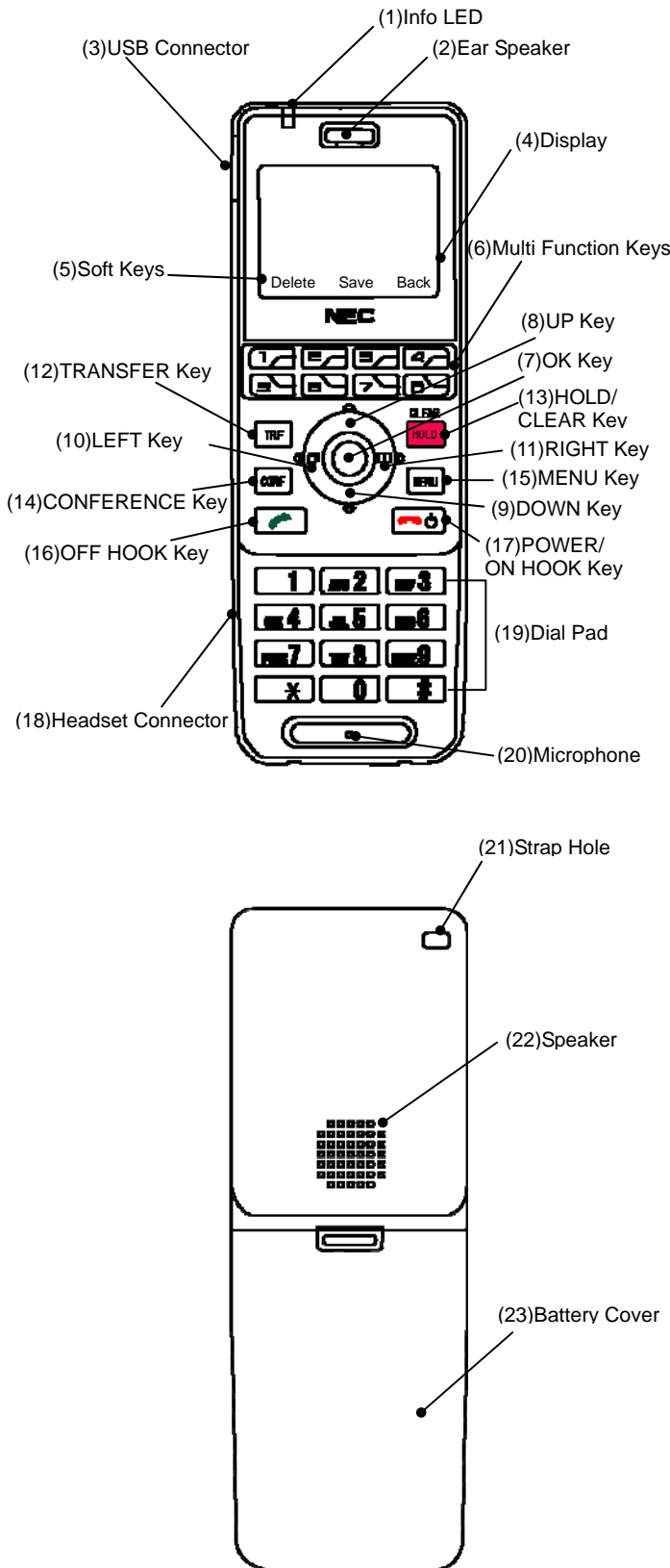

No.	PARTS	REMARK
(1)	Info LED	Display charging status and receiving a call
(2)	Ear Speaker	-
(3)	USB Connector	Charge the power via AC adapter
(4)	Display	Monochrome LCD, 120×90 pixels
(5)	Soft Keys	Display soft keys depend on the phone status
(6)	Multi Function Keys	Assign various function by System
(7)	OK Key <i>*Note</i>	Select Middle soft key
(8)	UP Key	Select a value from the list and move the cursor in edit mode
(9)	DOWN Key	
(10)	LEFT Key	
(11)	RIGHT Key	
(12)	TRANSFER Key <i>*Note</i>	Transfer the ongoing call or select Left soft key
(13)	HOLD/CLEAR Key <i>*Note</i>	Place the ongoing call in hold, return to the previous screen, delete input character/digit or select Right soft key
(14)	CONFERENCE Key <i>*Note</i>	Enter the conference mode (3-way call)
(15)	MENU Key <i>*Note</i>	Display Menu screen
(16)	OFF HOOK Key <i>*Note</i>	Make/answer a call
(17)	POWER/ON HOOK Key	Terminate an active call, power on/off the phone or exit a menu without making changes
(18)	Headset Connector	Connect headset had JEITA RC-5240 plug or conversion cable
(19)	Dial Pad <i>*Note</i>	Input dial number or characters
(20)	Microphone	-
(21)	Strap Hole	Attach hand strap
(22)	Speaker	Ring when receiving a call or listen to voice when speaker monitor
(23)	Battery Cover	-

** Note In case that key touch tone is enabled, you hear key touch tone twice when you press and hold the key for about 2 seconds.*

• ICONS

The phone has the following icons.

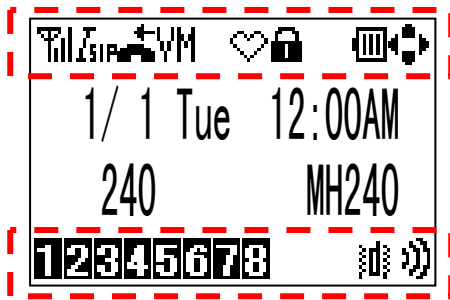

- Power icon (): indicates the battery charge level.

Icon	Battery Charge Level
	<i>Full</i> <i>Empty</i>
	<i>Charging</i>

- Antenna icon (): indicates the radio signal strength by your phone.

Icon	Radio Signal Strength
	<i>Strong</i> <i>Weak</i>
....	<i>Out of service area</i>

- Volume icon (): indicates the ring volume when Standby mode.

Icon	Ring Volume
	<i>Loud</i>
	<i>Medium</i>
	<i>Soft</i>
	<i>Increasing Ring</i>
	<i>Off</i>

- Volume icon (): indicates the call volume in the receiver.

Icon	Call Volume
	<i>Loud</i>
	<i>Medium</i>
	<i>Soft</i>

- Missed call icon (): indicates your missed call(s).
- VM icon (): indicates you have voice mail(s).
- Courtesy icon (): indicates your phone is in courtesy mode
- Lock icon (): indicates your phone is locked.
- I-SIP icon (): indicates NEC Enhanced SIP is enabled.
- Cursor icon (): indicates active direction keys (UP, DOWN, LEFT or RIGHT) depend on the phone status.
- Line icon (): indicates line key status.
- Vibration setting icon (): indicates your phone is vibration setting mode.

• STANDBY MODE

Your phone starts up in this mode after being powered on. Your phone displays the first screen similar to the following.

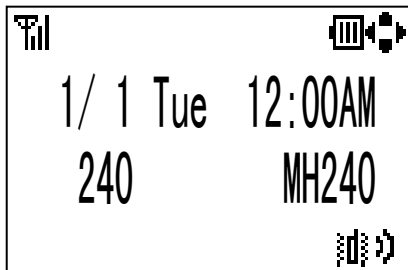

• MAIN MENU

Press the  key when your phone is in Standby mode. The following main menu will be displayed.

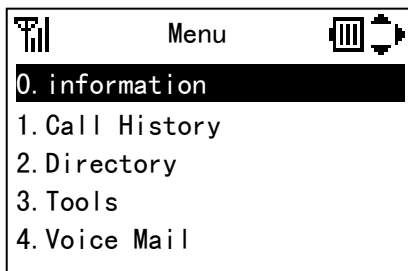

TIP

The menu list attached at the end of this guide shows all available items with the default value. See "13.MENU LIST" for more information.

2. GETTING STARTED

• HOW TO INSERT THE BATTERY

Insert the battery into the unit as follows.

- (1) Remove the battery cover from the phone.

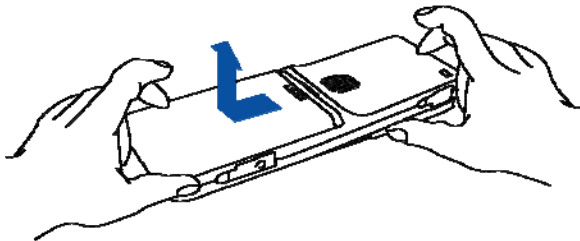

- (2) Place the battery into the unit so that the label faces toward you.

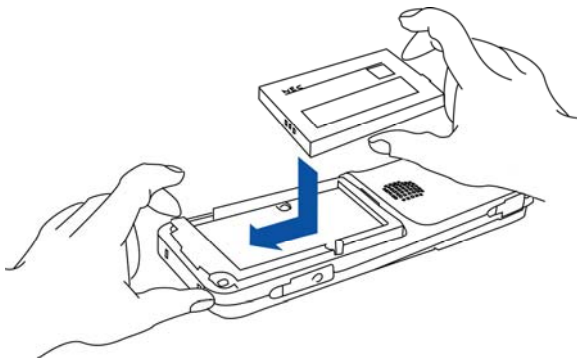

- (3) Attach the battery cover again.

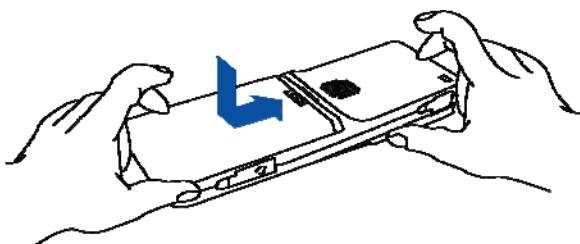

• HOW TO REPLACE THE BATTERY

Replace the battery of the phone as follows.

- (1) Power off the phone by pressing and holding the  key for 2 seconds or more.
- (2) Wait until the Info LED on the phone is off.
- (3) Remove the battery cover from the phone.
- (4) Remove the Battery.
- (5) Place the new battery into the unit so that the label faces toward you.
- (6) Attach the battery cover again.

TIP *The battery loaded in your phone has a useful life of about 2 years, though it is a parameter of on how your phone has been used. If the battery voltage diminishes quickly after the battery has been charged for a long time, replace with a new battery (optional). For more detail, ask your dealer.*



This product is powered by a lithium-ion battery.
Lithium-ion Battery: 3.7V 850mAh
The lithium-ion battery is a recyclable resource.

In recycling batteries that have been replaced or that have been unloaded from a used product, take notice of this precaution to avoid smoking and firing:

- Bring batteries to our repair counter with the contacts being taped to prevent shorts or enclosed individually in plastic bags.

<Our repair counter> For more details, visit the NEC Infrontia Environment Website.

<http://www.necinfrontia.co.jp/english/company/environment/index.htm>

• HOW TO CHARGE THE BATTERY

Be sure to charge the battery before using the phone for the first time. Use one of the following:

- Cradle
- AC Adapter (direct connection)

By using the Cradle:

The phone can be charged by using the cradle. You can also charge the battery by inserting the battery pack alone in the slot on the cradle. This is useful when you have a spare battery.

- (1) Insert the AC adapter plug (mini USB) into the USB connector in the back of the cradle.
- (2) Plug in the AC adapter into an appropriate AC outlet.
- (3) Place the phone and/or the spare battery pack as shown below. When placing a battery pack into the slot, insert it so that the label faces downward.

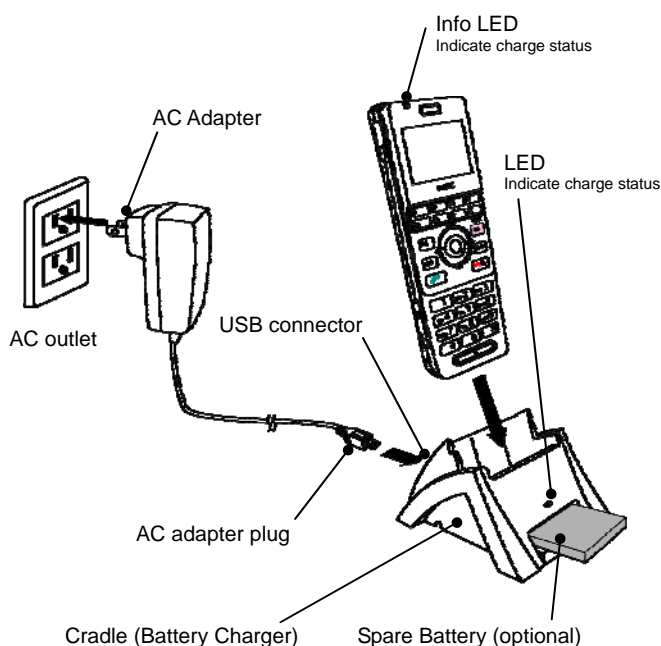

Note: Face the label of the battery pack downward when inserting the battery pack.

- (4) The LED on the cradle lights red, indicating the battery is being charged. When the phone battery is not being charged the Info LED turns off.
- (5) The LED on the cradle lights green when the spare battery is fully charged. After this, charging to the phone battery will start and the Info LED lights red.
- (6) The Info LED lights green when the phone battery is fully charged.

TIP An empty battery pack can be fully charged in about 4 hours.

TIP If any abnormality is found in the battery, the LED on the cradle lights off. In this case, please contact your network administrator.

TIP In the case you place the phone on the cradle and insert the spare battery in the slot at the same time, the spare battery will be charged first.

TIP Please insert the spare battery in the slot on the cradle or remove it as following figure.

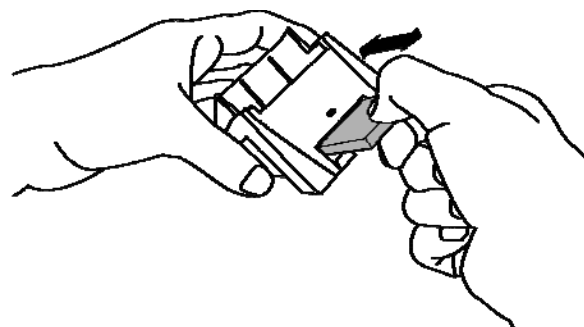

By using the AC Adapter:

To charge the phone using the AC adapter:

- (1) Insert the AC adapter into an appropriate AC outlet.
- (2) Insert the AC adapter plug (mini USB) into USB connector of the phone.

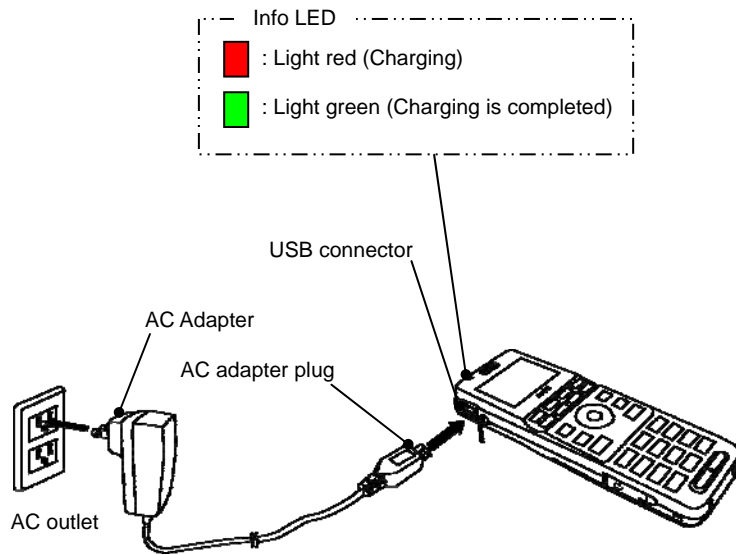

This page is for your notes.

3. BASIC OPERATION

• TO POWER ON THE PHONE (STANDBY MODE)

- Press and hold the  key for 2 seconds or more. The start screen appears and the Info LED flashes. After that your phone displays the following initial screen.

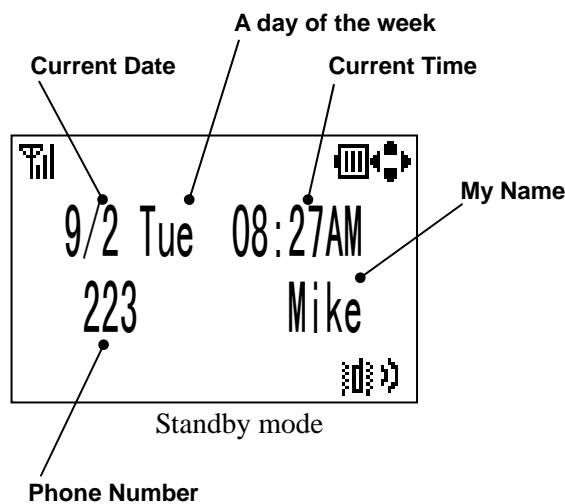

TIP *This initial screen is called Standby mode in this guide.*

- Make sure the Antenna icon () is displayed on your phone as follows.

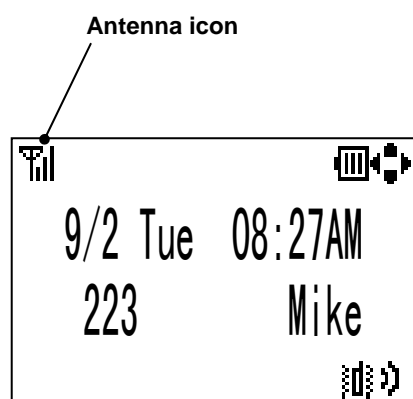

TIP *Antenna icon indicates you can use the phone. If Antenna icon indicates out of service area (...), please contact your network administrator.*



• TO POWER OFF THE PHONE

- Press and hold the  key for 2 seconds or more. "Power Off" is displayed and the Info LED flashes.

• TO ANSWER A CALL

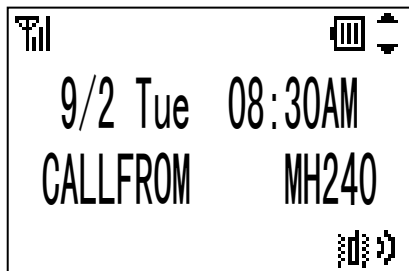
When receiving an incoming call, the display automatically changes to Incoming Call screen.





- To answer the call, press the  key.
- To stop the ring without answering the call, press the  key.

TIP When the calling party has been already registered in the Directory, the registered Name is displayed.

TIP When the calling party also uses MH240, My Name of MH240 is displayed.

• TO MAKE A CALL

To make a phone call, do either of the following:

- Enter the phone number and then press the  key. (*Preset Dialing*)
- Press the  key and then enter the phone number. (*Overlap Dialing*)

TIP By pressing CLEAR key, you can delete the last digit of the dialed number that is currently displayed on the phone when Preset Dialing is used.

• TO PLACE A CALL ON HOLD

During an active call, you can hold the call.

- Press the  key to hold the line. Your phone displays as follows.

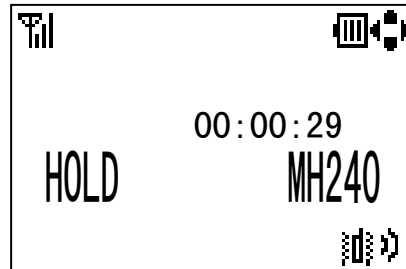

- Press the  key again to retrieve the line.

TIP During hold, Info LED blinks orange.



TIP This operation is different depending on your system. Please contact your network administrator.

• TO TRANSFER A CALL

During an active call, you can transfer the call to other phone.

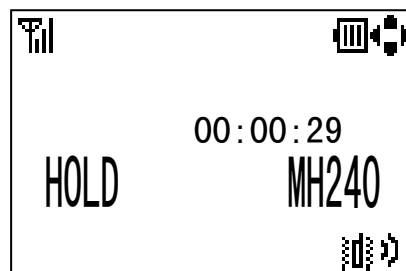
- Press the  key during the call. Your phone displays as follows.



- After hearing Second Dial Tone, enter the phone number to transfer the call.
- The called party answers the call, and then press the  key. (*Attended Transfer*)
or
- Press the  key before the called party answers. (*Unattended Transfer*)

• TO REDIAL (LAST NUMBER REDIAL)

You can make a call from the Outgoing Call History menu. A maximum of 50 calls can be automatically recorded.

Registered number:

- Press the  key while in Standby mode. Your phone displays Call History of Outgoing calls similar to the following.

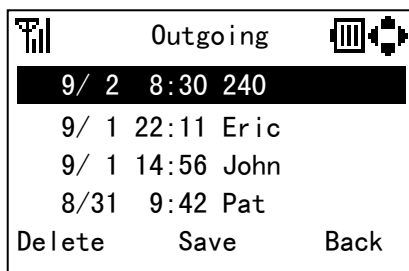

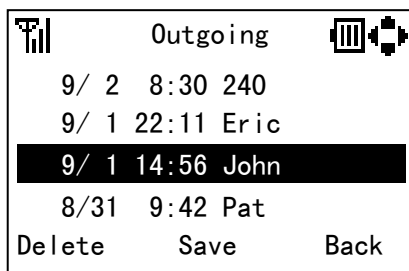

- Press the  key to select the desired party you want to redial.

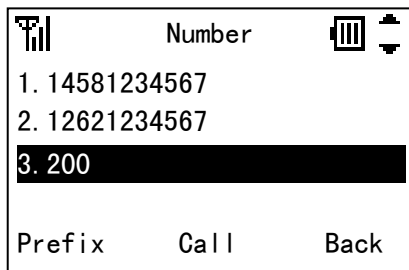

- Press the  key. Your phone displays the phone number list as followed if the selected party has been already registered in the Directory.





- Press the  key or “Call” soft key to redial the party after you select a phone number by pressing the  key.

Unregistered number:

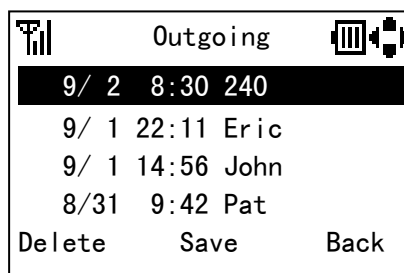
- Press the  key while in Standby mode. Your phone displays Call History of Outgoing calls similar to the following.



- Press the  key to select the desired party you want to redial.

- Press the  key. Your phone displays the phone number as followed.

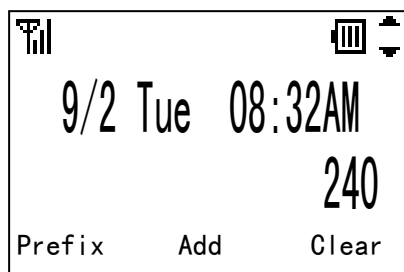



- Press the  key to redial the party.

• TO USE MUTE MODE

During an active call, you can use Mute mode. When entering Mute mode, your voice is not heard by the called party.

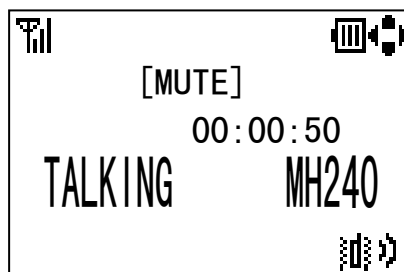

- Press the  key to enter Mute mode. Your phone displays as follows.



- Press the  key again to exit Mute mode.

• TO USE A HEADSET

When a headset is inserted to the Headset connector, your phone is in headset call mode.

- Connect a headset to the phone.
- When the phone receives a call, you can hear ringing from the headset or speaker (configurable). If vibration is set to enable, it is also available.
- Press the  key to answer the call.
- You can talk using the microphone and ear phone of the headset.
- Press the  key to end the call.

TIP *This phone has a JEAITA RC-5240 jack as a headset connector. If your headset has an ø2.5 plug, you can connect the headset to the phone by using a conversion cable.*

TIP *Receiver and microphone do not work when a conversion cable is connected.*

• TO USE WHILE CHARGING

You can operate MH240 while charging as following figure. But, the battery may become empty when you talk for long time.

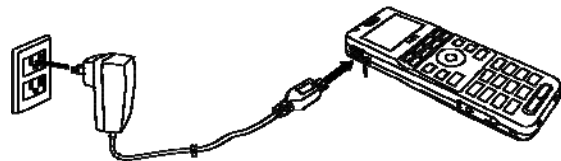

• TO USE SOFT KEYS

You will often use soft keys when you operate this phone. You can use soft keys as follows.

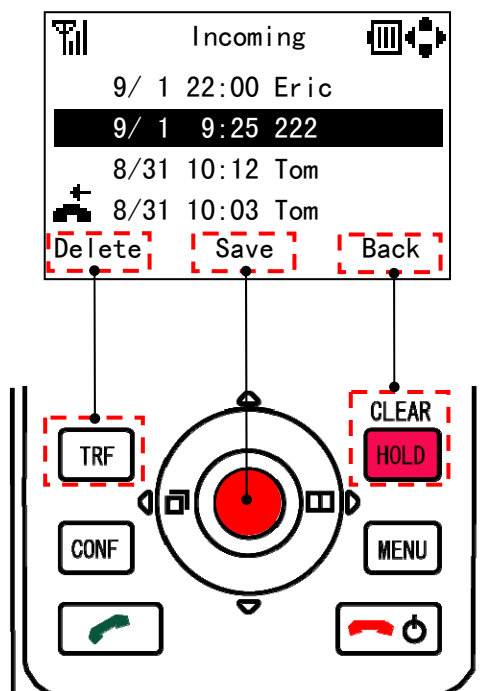

4. FEATURES

This section explains how to use the features on your phone.

• TO USE CONFERENCE (3-WAY CALL)

You can establish a Conference call (3-way call).

- During an active call, press the **CONF** key to hold the line.
- After hearing Second Dial Tone, enter the phone number that you want to join the call.
- When the called party answers the call, press the **CONF** key. Your phone displays as follows.

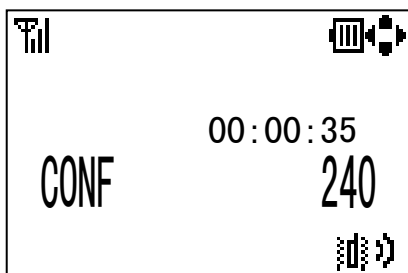

TIP This operation is different depending on your system. Please contact your network administrator.

• TO USE SPEAKERPHONE

During an active call, you can use Speakerphone. When entering Speakerphone mode, you can hear the called party's voice from the speaker of your phone.

- Press and hold the **Speakerphone** key for 2 seconds or more to enter Speakerphone mode.
- Press and hold the **Speakerphone** key again for 2 seconds or more to exit Speakerphone mode.

Note: To use Speakerphone, you need to enable this feature. See "8.SETTINGS" for more information.

• TO ADJUST CALL VOLUME

You can increase or decrease the receiver volume in Standby mode or during a call. The volume can be set in 3 steps (From Level 1 [Soft] to Level 3 [Loud]). The factory default value is Level 2 [Medium].

During a call:

Press the **Volume Up** key to select an appropriate volume and then press the "OK" soft key or wait timeout while talking with your phone.

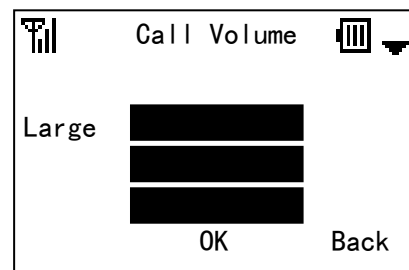

In Standby mode:

- Press the **MENU** key while in Standby mode. Your phone displays the main menu.
- Press the **Navigation** key to select "5.Setting" and then press the **OK** key.
- Press the **Volume Up** key to select "1.User Setting" and then press the **OK** key.
- Press the **Navigation** key to select "2.Talk" and then press the **OK** key.
- Press the **Navigation** key to select "3.Call Volume" and then press the **OK** key.
- Press the **Volume Up** key to select an appropriate volume and then press the "OK" soft key.



TIP You can reach the Call Volume menu by pressing the following keys.

To go to the Call Volume menu:



• TO USE COURTESY MODE

You can set your phone to Courtesy Mode. When your phone is placed in this mode, your phone displays the Courtesy icon (👉).



- Press and hold the  key for 1 second or more to enter Courtesy Mode.
- Press and hold the  key again for 1 second or more to exit Courtesy Mode.

COURTESY TONE/VIB.	ON	OFF
Key Touch Tone	OFF	
Ring	OFF	Depends on each setting.
Demo Sound	OFF	
Vibrator	ON	

TIP *When your phone enters Courtesy Mode, vibration setting works instead of speaker ringing.*

• TO USE KEY LOCK

You can set your phone to Key Lock Mode. When your phone is placed in this mode, you can not operate any key and your phone displays “Key Lock”.

- Press and hold the  key for 2 seconds or more to enter Key Lock Mode.
- Press and hold the  key again for 2 seconds or more to exit Key Lock Mode.

TIP *Even if your phone enters Handy Key Lock Mode, you can answer an incoming call.*



• TO RECONNECT TO NETWORK

You can reconnect to your network.

- Press and hold the  key for 3 seconds or more to reconnect.



5. CALL HISTORY

Your phone can record recent Call History in the following 3 lists up to 50 records for each list. You can open each list from the main menu or by pressing the associated key while in Standby mode.



- Outgoing Calls (Press the  key)
- Incoming Calls (Press the  key twice)

Outgoing Calls show a list of Dialed Numbers and Incoming Calls show that of Received Calls. You can make a call from the list and also add a Call History entry into the Directory as required.

• TO VIEW CALL HISTORY

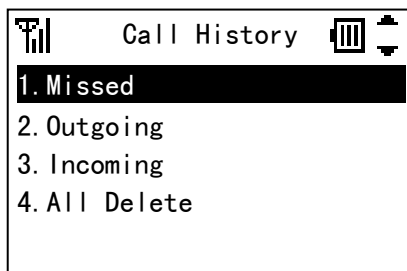
- Press the  key while in Standby mode. Your phone displays the main menu.
- Press the  key to select “1.Call History” and then press the  key. Your phone displays as follows.



- Press the  key to select a history you want to view on the list and then press the  key
- Your phone displays the following when you select “3.Incoming”.

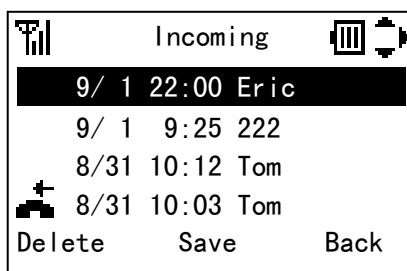

TIP You can find missed calls easily from the list of Incoming Calls by missed call icon ().

TIP Once you see a list of Missed Calls and close the screen, the records are cleared automatically. You can find those records from the list of Incoming Calls.

TIP You can reach each Call History by pressing the following keys.

To View Missed Calls:









To View Outgoing Calls:





To View Incoming Calls:



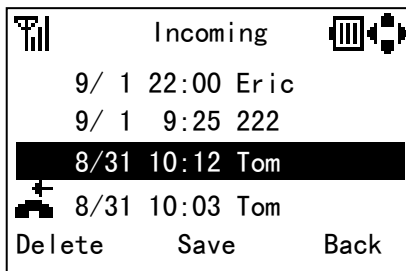

• TO MAKE A CALL FROM CALL HISTORY

- Press the  key while in Standby mode. Your phone displays the main menu.
- Press the  key to select “1.Call History” and then press the  key.
- Press the  key to select a history you want to view on the list and then press the  key.
- Press the  key to select a desired party you want to call.



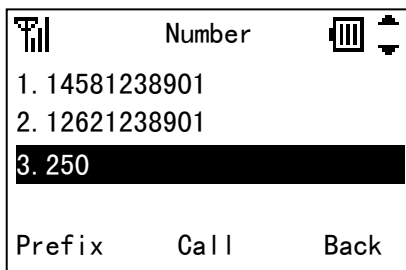





- Press the  key. Your phone displays the following phone number list if the selected party has been already registered in the Directory.



- Press the  key or the “Call” soft key to make the call after you select a phone number by pressing the  key.

• TO ADD PHONE NUMBER TO DIRECTORY

- Press the  key while in Standby mode. Your phone displays the main menu.
- Press the  key to select “1.Call History” and then press the  key.
- Press the  key to select a history you want to view on the list and then press the  key.
- Press the  key to select a phone number you want to add to Directory.

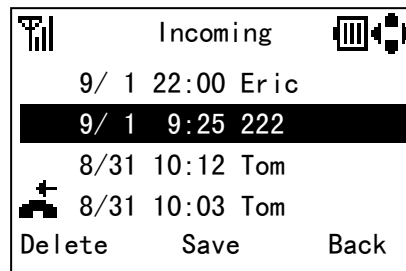

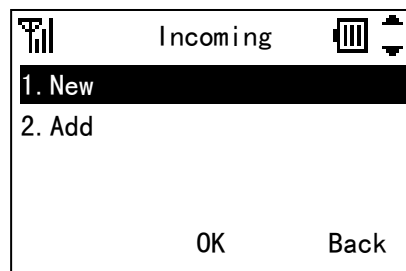

- Press the “Save” soft key.

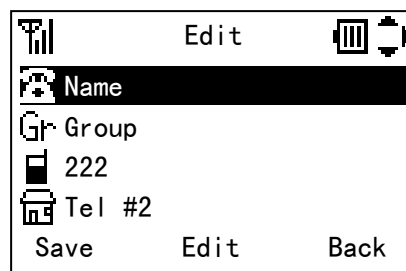

In case of a new number:

- Press the  key to select “1.New” and then press the “OK” soft key.



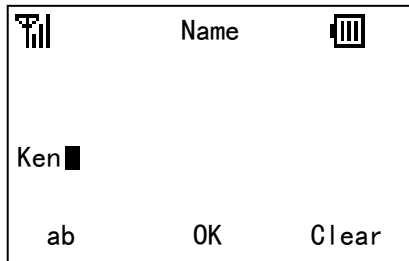

- Press the  key to select an item you want to edit and then press the “Edit” soft key as required. In this example, Name and Group will be edited.
- Edit the data in edit display.

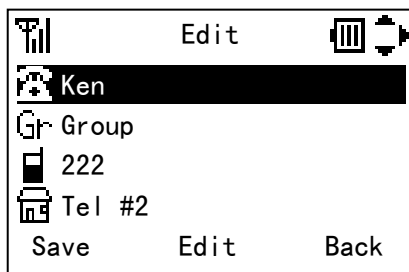

- Press the “OK” soft key and you will go back to the previous screen.



- Press the  key to select “Group” and then press the “Edit” soft key.
- Press the  key to select an appropriate group.

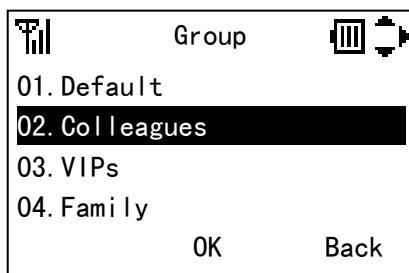

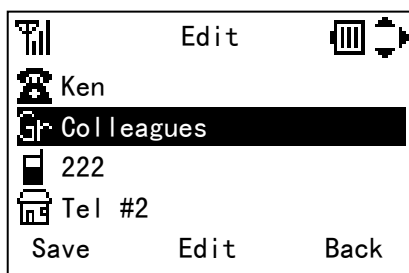

- Press the “OK” soft key and you will go back to the previous screen.





- Press the “Save” soft key to save the data to the Directory. The display returns to the previous screen.

TIP *Name information is required to save the data.*

Adding a phone number entry:

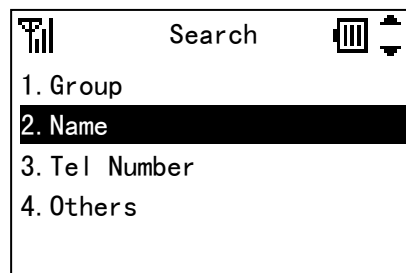
- Press the  key to select “2.Add” and then press the “OK” soft key.
- Press the  key to select a search way you want. (In this case, to search by Name.)



- Press the  key and then input the name you want to search.

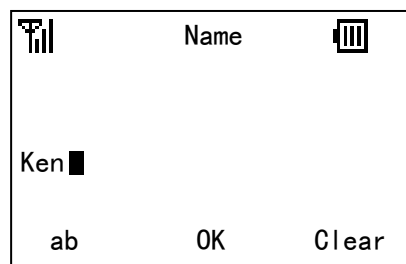

- Press the “OK” soft key to search.

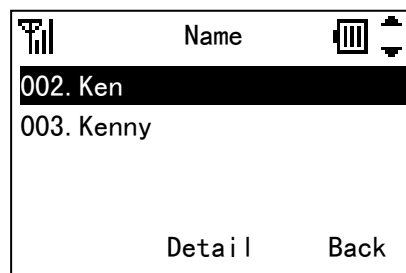

- Press the “Detail” soft key and then press the  key to select a phone number input area you want to add.

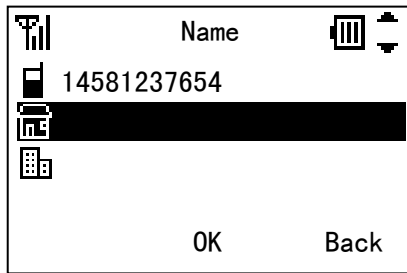

TIP *If you save to an already existing entry, it will be overwritten by the new phone number.*

- Press the “OK” soft key.

• TO DELETE A CALL HISTORY

- Press the **MENU** key while in Standby mode. Your phone displays the main menu.
- Press the **CALL HISTORY** key to select “1.Call History” and then press the **OK** key.
- Press the **UP** key to select a history you want to view on the list and then press the **OK** key.
- Press the **LEFT** key to select a phone number you want to delete and then press the “Delete” soft key.

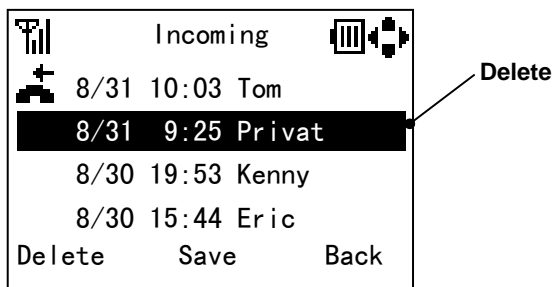

- Press the **DOWN** key to select “2.OK” and then press the “OK” soft key.

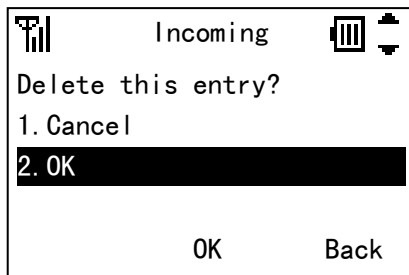

TIP You can press the **RIGHT** key to delete the entry instead of the above operation.

• TO DELETE ALL CALL HISTORIES

- Press the **MENU** key while in Standby mode. Your phone displays the main menu.
- Press the **CALL HISTORY** key to select “1.Call History” and then press the **OK** key.
- Press the **UP** key to select “4.All Delete” and then press the **OK** key.

- Press the **UP** key to select a history you want to delete and then press the “OK” soft key.

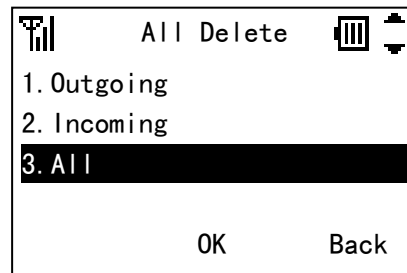

- Press the **DOWN** key to select “2.OK” and then press the “OK” soft key.

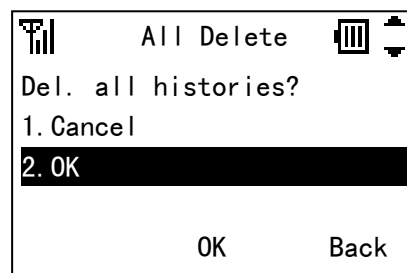

TIP If you delete all Incoming Call histories, Missed Call histories also are deleted.

TIP You can delete all call histories by pressing the following keys.

To Delete Outgoing Call Histories:



To Delete Incoming Call Histories:



To Delete All Call Histories:



This page is for your notes.

6. DIRECTORY

You can save, edit, delete and view up to 500 record entries.

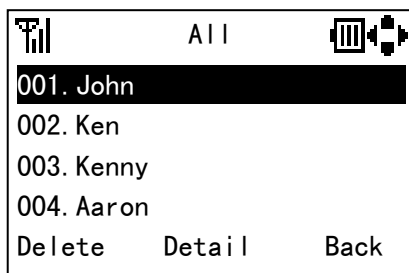

• TO VIEW DIRECTORY

- Press the  key while in Standby mode.
- Your phone displays as follows.









TIP By pressing the  key while displaying the Directory, you can scroll through a list.

All <> ABC <> DEF <> GHI <> JKL
<> MNO <> PQRS <> TUV <>
WXYZ <> Other <>

TIP Pressing the  to  key and holding it for about 1 second in Standby mode will start Alphabet Search.



• TO SEARCH DIRECTORY

- Press the  key while in Standby mode. Your phone displays the main menu.
- Press the  key to select “2.Directory” and then press the  key.
- Press the  key to select “1.Search” and then press the  key.

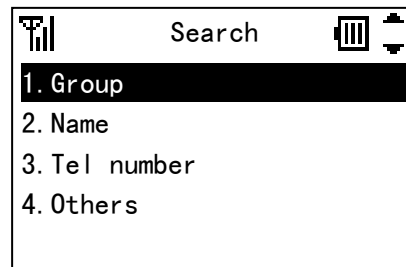
- Press the  key. Your phone displays the Search menu.



To Search by Group:

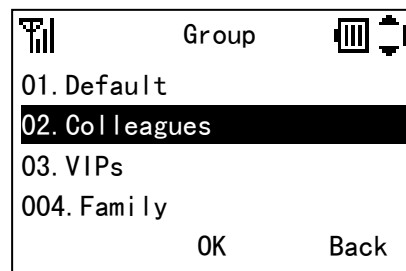

- Press the  key to select “1.Group” and then press the  key.
- Press the  key to select a Group you want to search and then press the “OK” soft key.

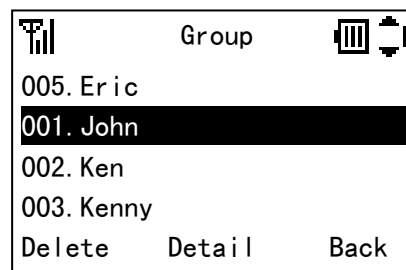

- Your phone displays searched records.



To Search by Name:

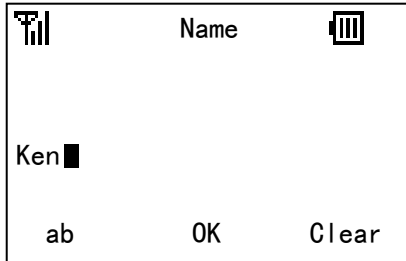

- Press the  key to select “2.Name” and then press the  key.
- Enter a name or letter you want to search and then press the “OK” soft key.

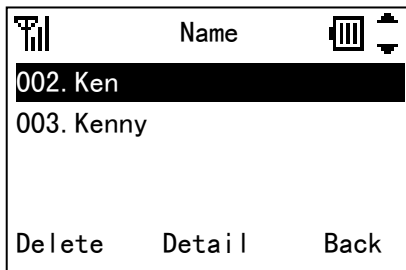

- Your phone displays searched records.



To Search by Tel number:



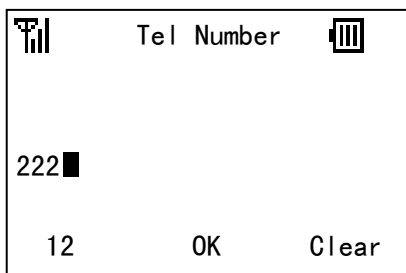

- Press the  key to select “3.Tel number” and then press the  key.
- Enter a phone number you want to search and then press the “OK” soft key.

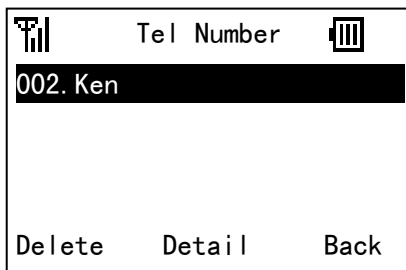

- Your phone displays searched record.



To Search by Memory ID:



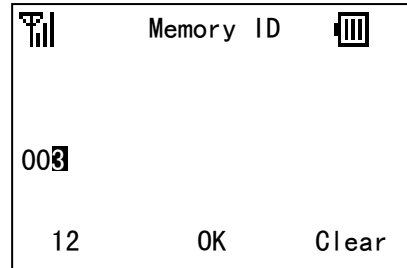

- Press the  key to select “4.Others” and then press the  key.
- Press the  key to select “1.Memory ID” and then press the  key.
- Enter a Memory ID (3 digits) you want to search and then press the “OK” soft key.

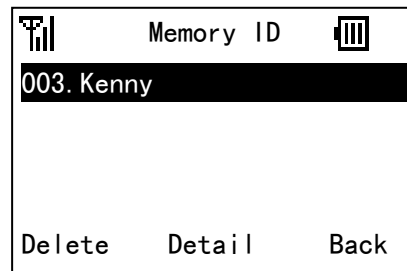

- Your phone displays searched records.



To Search by Alphabet:

- Press the  key to select “4.Others” and then press the  key.
- Press the  key to select “2.Alphabet” and then press the  key.
- Press the  key to select an Alphabet you want to search and then press the “OK” soft key.

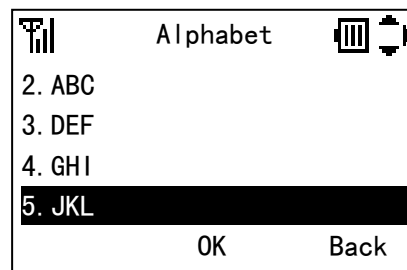

- Your phone displays searched records.

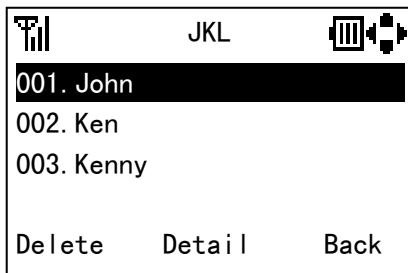

To Search by Company:

- Press the key to select "4.Others" and then press the key.
- Press the key to select "3.Company" and then press the key.
- Enter a Company name you want to search and then press the "OK" soft key.

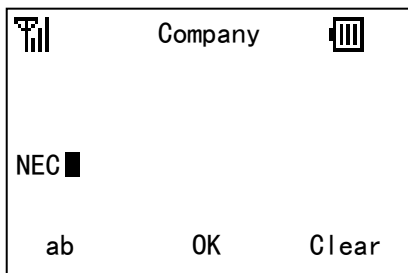

- Your phone displays searched records.

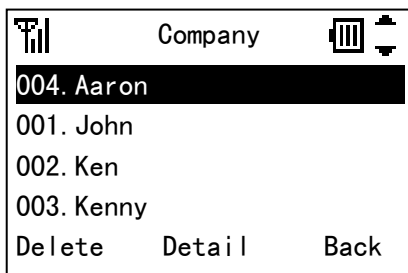

TIP You can reach each Search menu by pressing the following keys.

To go to the Group Search menu:

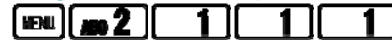

To go to the Name Search menu:



To go to the Tel Number Search menu:



To go to the Memory ID Search menu:







To go to the Alphabet Search menu:



To go to the Company Search menu:



• TO SETUP GROUP

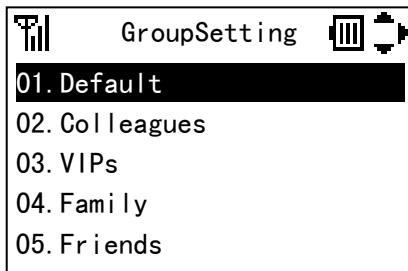

- Press the  key while in Standby mode. Your phone displays the main menu.
- Press the  key to select “2.Directory” and then press the  key.
- Press the  key to select “3.Group Setting” and then press the  key. Your phone displays the Group Setting menu.



TIP You can reach the Group Setting menu by pressing the following keys.

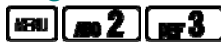

To go to the Group Setting menu:

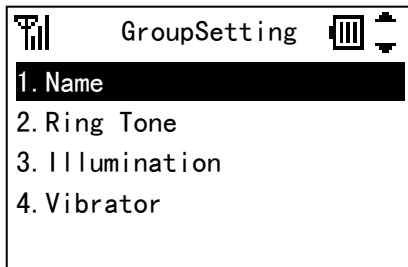

- Press the  key to select a Group you want to setup and then press the  key.



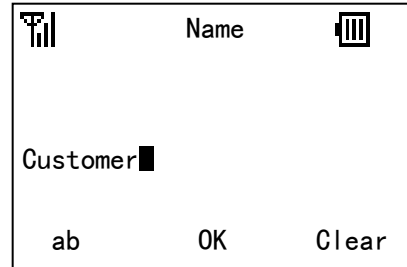

To Edit Group Name:

- Press the  key to select “1.Name” and then press the  key.
- Enter a Group Name you want and then press the “OK” soft key.



- The display returns to the previous screen.

To Setup Group Ring Tone:

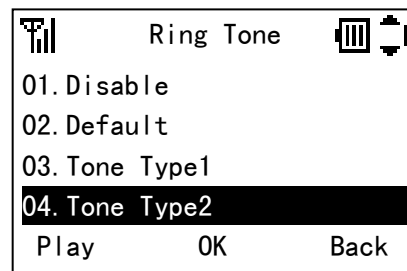

- Press the  key to select “2.Ring Tone” and then press the  key.
- Press the  key to select a Group Ring Tone you want and then press the “OK” soft key.



- The display returns to the previous screen.

TIP By pressing the “Play” or “Stop” soft key, you can hear the Ring Tone while you select a Group Ring Tone.

To Setup Group Illumination:

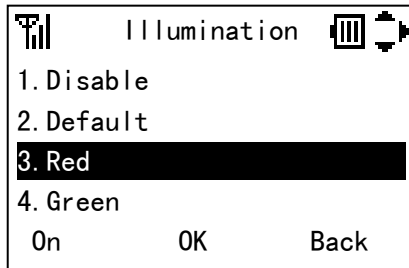

- Press the  key to select "3.Illumination" and then press the  key.
- Press the  key to select a Group Illumination you want and then press the "OK" soft key.



- The display returns to the previous screen.

TIP *By pressing the "On" or "Stop" soft key, you can view the Illumination while you select a Group Illumination.*

To Setup Group Vibration setting:



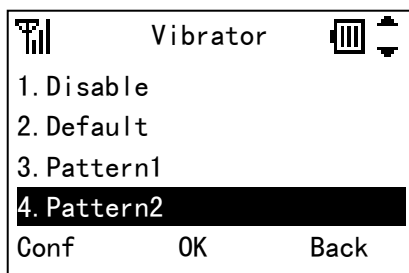

- Press the  key to select "4.Vibrator" and then press the  key.
- Press the  key to select the Group Vibration setting you want and then press the "OK" soft key.





- The display returns to the previous screen.

TIP *By pressing the "Conf" or "Stop" soft key, you can confirm the Vibration setting pattern while you select a Group Vibration setting.*

• TO ADD A NEW ENTRY

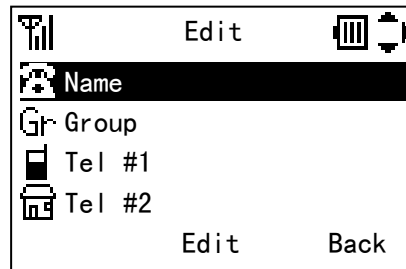
- Press the  key while in Standby mode. Your phone displays the main menu.
- Press the  key to select "2.Directory" and then press the  key.
- Press the  key to select "2.Edit" and then press the  key. Your phone displays the Edit menu.



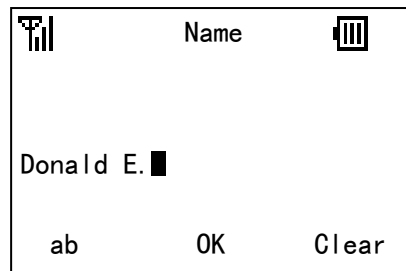

- Press the  key to select an Item you want to edit and then press the "Edit" soft key.
- Edit the selected item. In the following example, Name data is edited.

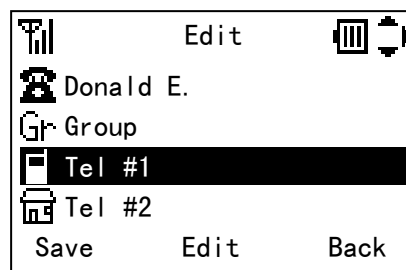

TIP *Name information is minimum requirement to save the data.*

- Press the "OK" soft key to write the data. The display returns to the previous screen.



- Press the  key to select an Item you want to edit and then press the “Edit” soft key.
- Edit the selected item. In the following example, Tel #1 data is edited.

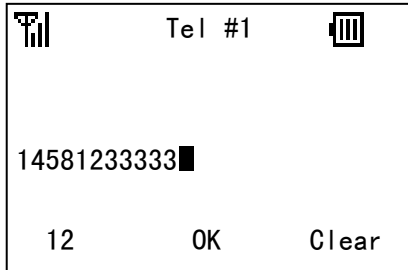

- Press the “OK” soft key to write the data. The display returns to the previous screen.

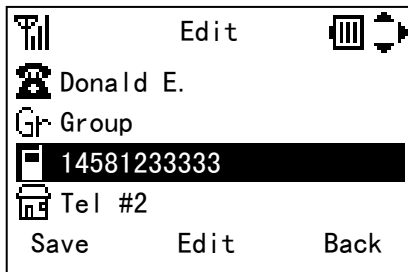

- Repeat these steps as required for the new entry.
- When all of the editing is completed, press the “Save” soft key.

TIP *You can reach the Directory Edit menu by pressing the following keys.*

To go to the Directory Edit menu:

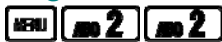

• TO DELETE A RECORD

You can delete a record from the Directory.

- Press the key while in Standby mode.
- Your phone displays as follows.

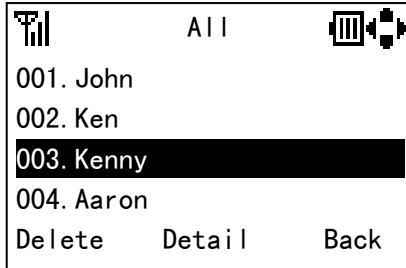

- Press the key to select a record you want to delete and then press the “Delete” soft key.
- Press the key to select the “OK” soft key.

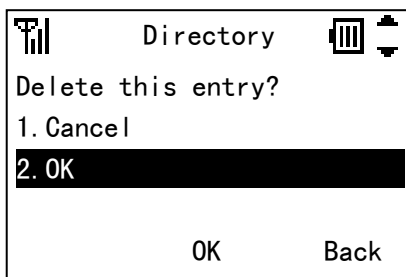

TIP You can press the key to delete instead of above operation.

• TO DELETE ALL RECORDS

- Press the key while in Standby mode. Your phone displays the main menu.
- Press the key to select “2.Directory” and then press the key.
- Press the key to select “5.All Delete” and then press the key.
- Press the key to select “2.OK” and then press the “OK” soft key.

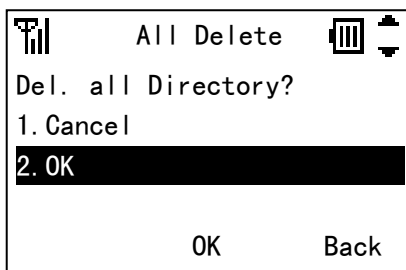

TIP You can delete all the records in the Directory by pressing the following keys.

To Delete All Directory:



• TO MAKE A CALL FROM DIRECTORY

- Press the key while in Standby mode.
- Your phone displays as follows.

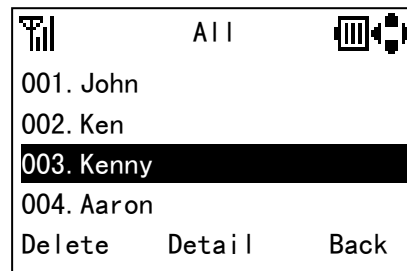

- Press the key to select a party you want to make a call to and then press the key. Your phone displays the phone number list as follows.

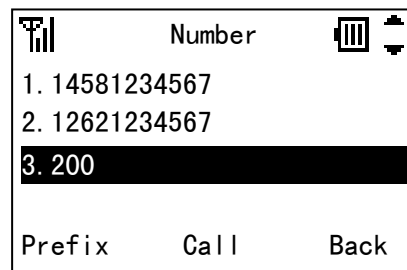



- Press the key or the “Call” soft key to make the call after you select a phone number by pressing the key.

• TO EDIT AN ENTRY

You can edit a registered Directory.

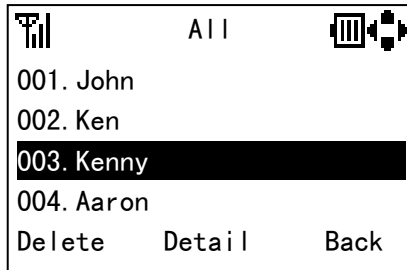
- Press the  key while in Standby mode.
- Your phone displays as follows.





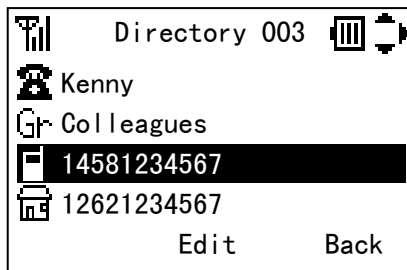

- Press the  key to select a record you want to edit and then press the “Detail” soft key.



- Press the  key to select an item you want to edit and then press the “Edit” soft key.
- When all of the editing is completed, press the “Save” soft key.

• TO CONFIRM YOUR PHONE NUMBER

- Press the  key while in Standby mode. Your phone displays the main menu.
- Press the  key to select “2.Directory” and then press the  key.
- Press the  key to select “4.Own Number” and then press the  key. Your phone displays as follows.

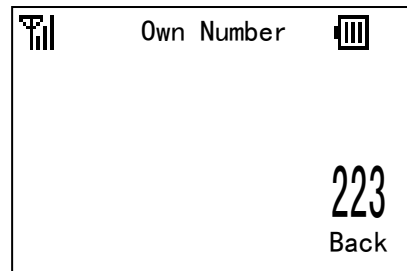

TIP You can confirm your phone number by pressing the following keys.

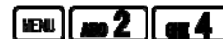

To Confirm Your Phone Number:



7. SPEED DIAL/PRESET DIAL







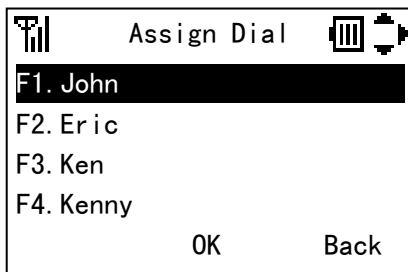

You can use Speed Dial assigned multi function keys (up to 8 entries) and Preset Dial assigned dial keys (up to 10 entries).

• TO USE SPEED DIAL

- In Standby mode, press a function key ( to ) to select one Speed Dial entry that has already registered in your phone. For example, press the  key to make a call to “F3.Ken” that is listed as the F3 entry.



• TO ENABLE SPEED DIAL

- Press the  key while in Standby mode. Your phone displays the main menu.
- Press the  key to select “5.Setting” and then press the  key.
- Press the  key to select “1.User Setting” and then press the  key.
- Press the  key to select “6.Keypad Mode” and then press the  key.
- Press the  key to select “2.Function Key” and then press the  key. Your phone displays the Function Key menu.

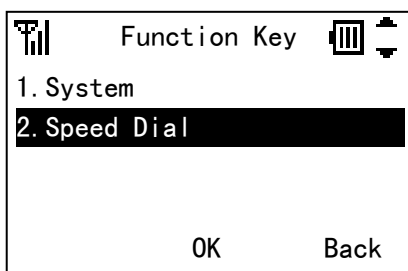

- Press the  key to select “2.Speed Dial” and then press the “OK” soft key.

TIP You can enable Function Keys as Speed Dial by pressing the following keys.

To Enable Speed Dial:



TIP When you enable Function Keys as Speed Dial, Function Keys will not work as system function keys.

• TO USE PRESET DIAL

- In Standby mode, press a dial pad (to) to select one of the Preset Dial entries that have already registered in your phone. For example, press the key and hold for about 1 second to make a call to “D3.Tom” that is listed as D3 entry.

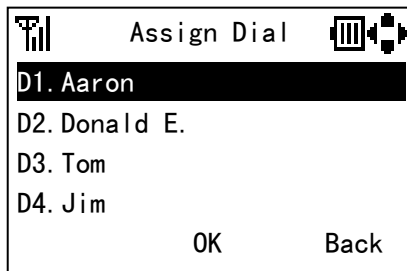

- Press the key to make the call.

TIP *In case that key touch tone is enabled, you hear error tone when you press unassigned dial key and hold for about 1 second.*

• TO ENABLE PRESET DIAL

- Press the key while in Standby mode. Your phone displays the main menu.
- Press the key to select “5.Setting” and then press the key.
- Press the key to select “1.User Setting” and then press the key.
- Press the key to select “6.Keypad Mode” and then press the key.
- Press the key to select “3.Dial Key” and then press the key. Your phone displays the Dial Key menu.

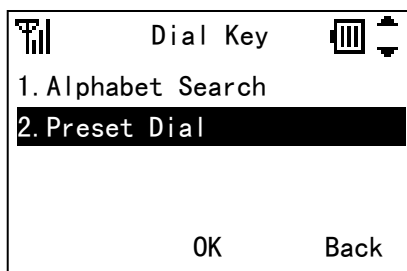

- Press the key to select “2.Preset Dial” and then press the “OK” soft key.

TIP *You can enable the Dial Keys as Preset Dials by pressing the following keys.*

To Enable Preset Dial:



TIP *When you set the Dial Keys as Preset Dial, Dial Keys will not work as Alphabet Search function keys.*

• TO ADD NEW ENTRY/EDIT

- Press the key while in Standby mode. Your phone displays the main menu.
- Press the key to select “5.Setting” and then press the key.
- Press the key to select “1.User Setting” and then press the key.
- Press the key to select “6.Keypad Mode” and then press the key.
- Press the key to select “4.Assign Dial” and then press the key. Your phone displays the Assign Dial menu.

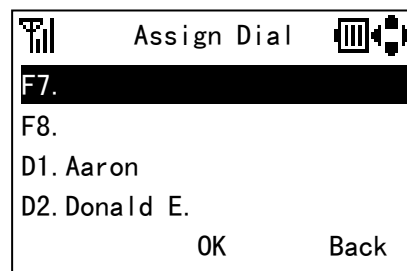

- Press the key to select a key you want to add/edit and then press the “OK” soft key.

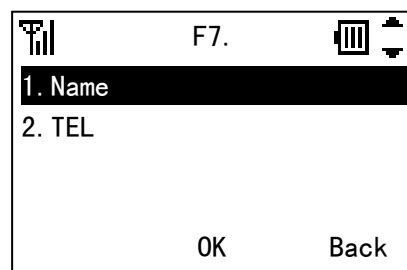

- Press the key to select an item you want to edit and then press the “OK” soft key.

- When all of the editing is completed, press the “Back” soft key.

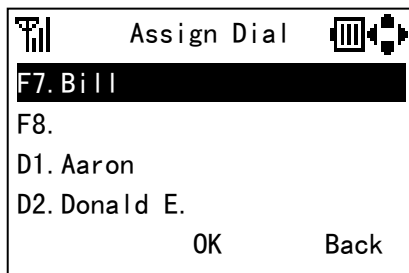

TIP You can reach the Assign Dial menu by pressing the following keys.

To go to the Assign Dial menu:

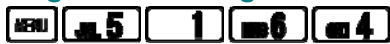

This page is for your notes.











8. SETTING

Various settings such as *Incoming Call, Talk, Display, Password, Password Lock, Keypad Mode and Date & Time* can be modified as required on your phone.

• RING VOLUME

Factory Default: Middle

You can adjust ring tone volume.

- Press the  key while in Standby mode. Your phone displays the main menu.
- Press the  key to select “5.Setting” and then press the  key.
- Press the  key to select “1.User Setting” and then press the  key.
- Press the  key to select “1.Incoming Call” and then press the  key.
- Press the  key to select “1.Ring Volume” and then press the  key.
- Ring Volume can be set in 5 levels (Off, Graduate, Small, Middle and Large).
- Press the  key to select an appropriate volume and then press the “OK” soft key.

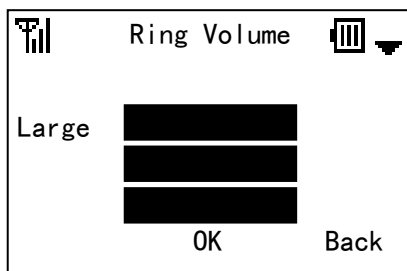

TIP You can reach the Ring Volume menu by pressing the following keys.











To go to the Ring Volume menu:





• RING TONE

Factory Default: Tone Type1 (All kind)

You can select ring tone on a call kind basis (External Ring, Internal Ring, IM and Non-notification).

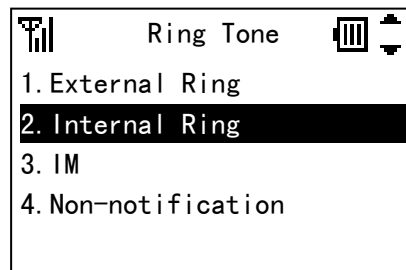
- Press the  key while in Standby mode. Your phone displays the main menu.
- Press the  key to select “5.Setting” and then press the  key.
- Press the  key to select “1.User Setting” and then press the  key.
- Press the  key to select “1.Incoming Call” and then press the  key.
- Press the  key to select “2.Ring Tone” and then press the  key.
- Press the  key to select a call kind you want to change a ring tone and then press the  key.



- Press the  key to select a ring tone you want and then press the “OK” key.

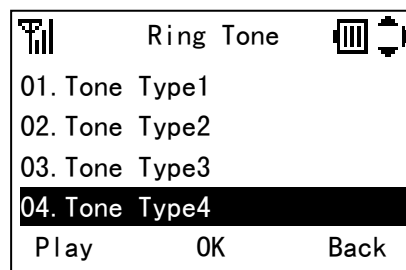

TIP By pressing the “Play” or “Stop” soft key, you can hear the Ring Tone while you select a Ring Tone.

TIP You can reach the Ring Tone menu by pressing the following keys.

To go to the Ring Tone menu:

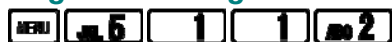

• INCOMING POPUP

Factory Default: Disable

Your phone can display a popup window while ringing.

- Press the key while in Standby mode. Your phone displays the main menu.
- Press the key to select “5.Setting” and then press the key.
- Press the key to select “1.User Setting” and then press the key.
- Press the key to select “1.Incoming Call” and then press the key.
- Press the key to select “3.Incoming Popup” and then press the key.
- Press the key to select “1.Disable” or “2.Enable” and then press the “OK” soft key.

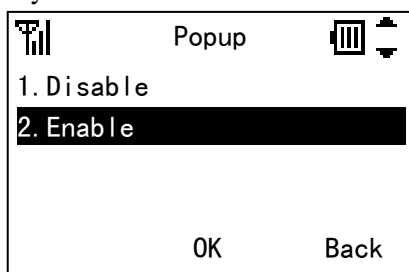

TIP When a caller is not registered in your Directory, your phone does not display a popup window even if this feature is enabled.

TIP When your phone displays I-SIP icon, this feature may not work depending on system setting. In this case, please contact your network administrator.

TIP You can reach the Incoming Popup menu by pressing the following keys.

To go to the Incoming Popup menu:

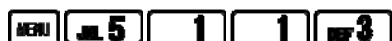

• ILLUMINATION

Factory Default: Green (All kind)

You can select an illumination color of the Info LED on a call kind basis (External Ring, Internal Ring, IM and Non-notification).

- Press the key while in Standby mode. Your phone displays the main menu.
- Press the key to select “5.Setting” and then press the key.
- Press the key to select “1.User Setting” and then press the key.
- Press the key to select “1.Incoming Call” and then press the key.
- Press the key to select “4.Illumination” and then press the key.
- Press the key to select a call kind you want to change an illumination and then press the key.

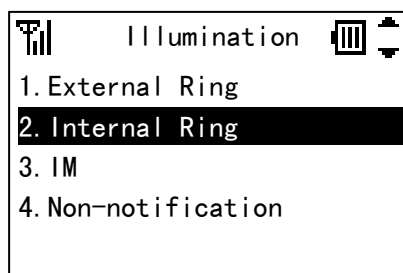

- Press the key to select an illumination you want and then press the “OK” key.

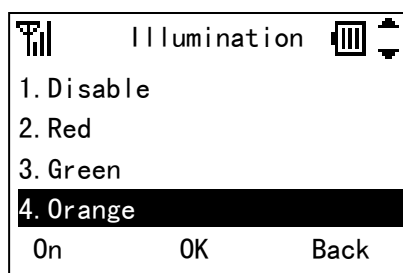

TIP By pressing the “On” or “Stop” soft key, you can view the Illumination while you select an Illumination.

TIP You can reach the Illumination menu by pressing the following keys.

To go to the Illumination menu:



• PRIVATE CALL

Factory Default: Allow Incoming

You can block incoming calls without Caller ID.

- Press the **MENU** key while in Standby mode. Your phone displays the main menu.
- Press the **5** key to select “5.Setting” and then press the **1** key.
- Press the **1** key to select “1.User Setting” and then press the **1** key.
- Press the **1** key to select “1.Incoming Call” and then press the **1** key.
- Press the **5** key to select “5.Private Call” and then press the **1** key.
- Press the **1** key to select “1.Allow Incoming” or “2.Block Incoming” and then press the “OK” soft key.

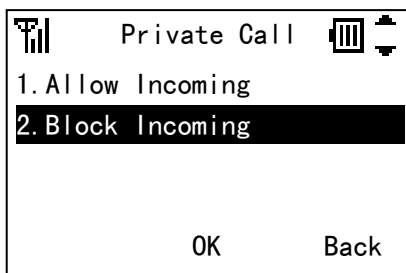

TIP

You can reach the Private Call menu by pressing the following keys.

To go to the Private Call menu:



• VIBRATION SETTING

Factory Default: Pattern1 (All kind)

You can select a vibration setting pattern on a call kind basis (External Ring, Internal Ring, IM and Non-notification).

- Press the **MENU** key while in Standby mode. Your phone displays the main menu.
- Press the **5** key to select “5.Setting” and then press the **1** key.
- Press the **1** key to select “1.User Setting” and then press the **1** key.
- Press the **1** key to select “1.Incoming Call” and then press the **1** key.
- Press the **6** key to select “6.Vibrator” and then press the **1** key.
- Press the **1** key to select a call kind you want to change the vibration setting for and then press the **1** key.

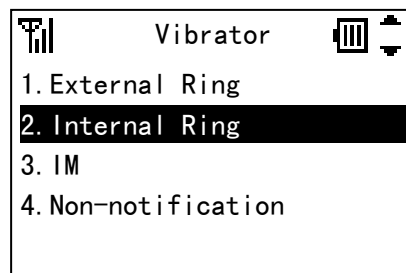

- Press the **1** key to select the vibration setting you want and then press the “OK” key.

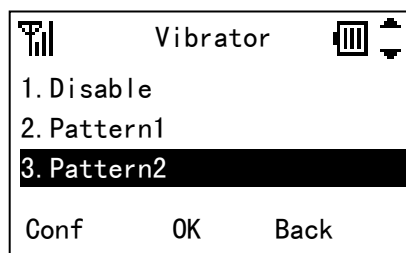

TIP

By pressing the “Conf” or “Stop” soft key, you can sample the Vibration setting while you select a Vibration setting.

TIP

You can reach the Vibration setting menu by pressing the following keys.











To go to the Vibrator menu:



• INCOMING MODE

Factory Default: Both

You can select an incoming mode of Ring and Vibration.

- Press the  key while in Standby mode. Your phone displays the main menu.
- Press the  key to select “5.Setting” and then press the  key.
- Press the  key to select “1.User Setting” and then press the  key.
- Press the  key to select “1.Incoming Call” and then press the  key.
- Press the  key to select “7.Incoming Mode” and then press the  key.
- Press the  key to select “1.Both”, “2.Ring → Vib” or “3.Vib → Ring” and then press the “OK” soft key.

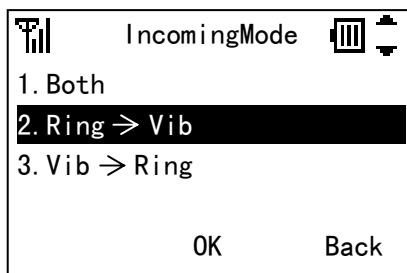

TIP You can reach Incoming Mode menu by pressing the following keys.









To go to the Incoming Mode menu:



• HEADSET



Factory Default: Headset (Ring Tone Sending), None (Auto response)

Your can modify a headset mode.

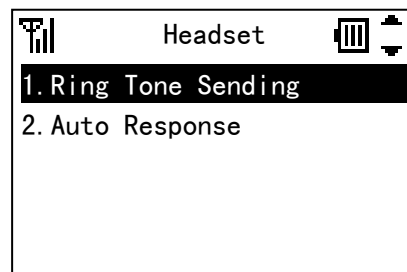
- Press the  key while in Standby mode. Your phone displays the main menu.
- Press the  key to select “5.Setting” and then press the  key.
- Press the  key to select “1.User Setting” and then press the  key.
- Press the  key to select “1.Incoming Call” and then press the  key.
- Press the  key to select “8.Headset” and then press the  key. Your phone displays as follows.



Ring Tone Sending:

- Press the  key to select “1.Ring Tone Sending” and then press the  key.
- Press the  key to select “1.Headset” or “2.Speaker” and then press the “OK” soft key.

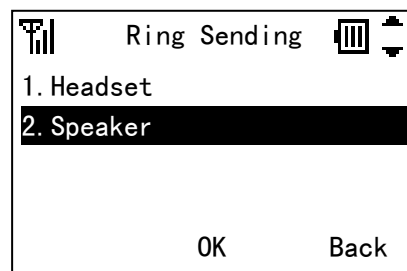



- The display returns to the previous screen.

TIP You can reach the Ring Tone Sending of Headset menu by pressing the following keys.

To go to the Ring Tone Sending menu:



Auto Response:

- Press the  key to select “2.Auto Response” and then press the  key.
- Press the  key to select an auto response times you want and then press the “OK” soft key.

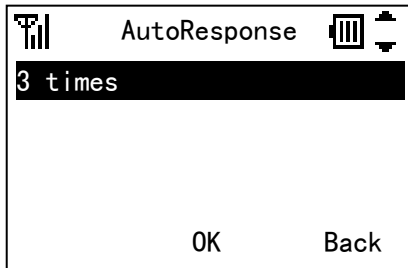

- The display returns to the previous screen.

TIP *You can reach the Auto Response of Headset menu by pressing the following keys.*











To go to the Auto Response menu:



• OFFHOOK RING

Factory Default: Enable

You can accept a second incoming call.

- Press the  key while in Standby mode. Your phone displays the main menu.
- Press the  key to select “5.Setting” and then press the  key.
- Press the  key to select “1.User Setting” and then press the  key.
- Press the  key to select “1.Incoming Call” and then press the  key.
- Press the  key to select “9.Offhook Ring” and then press the  key.
- Press the  key to select “1.Disable” or “2.Enable” and then press the “OK” soft key.

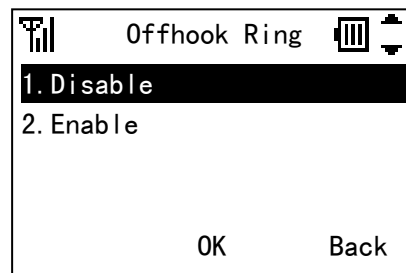

TIP *This feature does not work depending on your system.*

TIP *You can reach the Offhook Ring menu by pressing the following keys.*











To go to the Offhook Ring menu:



• RTP ALARM

Factory Default: Disable

Your phone can provide an alarm if RTP packet loss is suspected.

- Press the  key while in Standby mode. Your phone displays the main menu.
- Press the  key to select “5.Setting” and then press the  key.
- Press the  key to select “1.User Setting” and then press the  key.
- Press the  key to select “2.Talk” and then press the  key.
- Press the  key to select “1.RTP Alarm” and then press the  key.
- Press the  key to select “1.Disable” or “2.Enable” and then press the “OK” soft key.

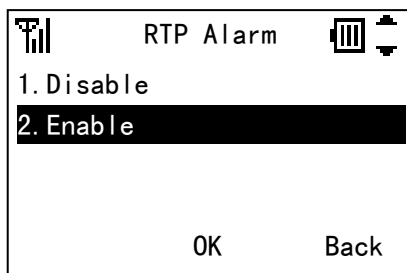

TIP

You can reach the RTP Alarm menu by pressing the following keys.











To go to the RTP Alarm menu:



• HOLD MUSIC

Factory Default: Tone Type12

You can select the music that is provided while your phone is in hold status.

- Press the  key while in Standby mode. Your phone displays the main menu.
- Press the  key to select “5.Setting” and then press the  key.
- Press the  key to select “1.User Setting” and then press the  key.
- Press the  key to select “2.Talk” and then press the  key.
- Press the  key to select “2.Hold Music” and then press the  key.
- Press the  key to select a music you want and then press the “OK” soft key.

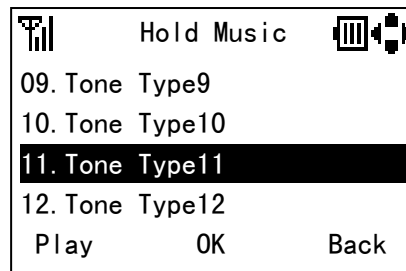

TIP

By pressing the “Play” or “Stop” soft key, you can hear the Music while you select Music.

TIP

You can reach the Hold Music menu by pressing the following keys.











To go to the Hold Music menu:



• CALL VOLUME

Factory Default: Middle

You can adjust receiver volume.

- Press the  key while in Standby mode. Your phone displays the main menu.
- Press the  key to select “5.Setting” and then press the  key.
- Press the  key to select “1.User Setting” and then press the  key.
- Press the  key to select “2.Talk” and then press the  key.
- Press the  key to select “3.Call Volume” and then press the  key.
- Call Volume can be set in 3 levels (Small, Middle and Large).
- Press the  key to select an appropriate volume and then press the “OK” soft key.

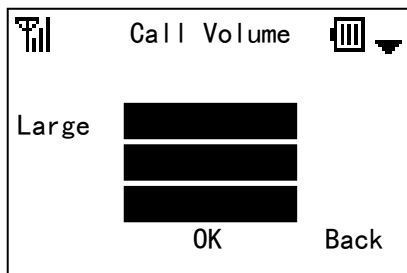

TIP You can reach the Call Volume menu by pressing the following keys.

To go to the Call Volume menu:













• HANDOVER TONE

Factory Default: Disable

Your phone can provide a warning tone when handover takes place.

TIP Handover is the process of transferring a wireless phone user from one Access Point to another.

- Press the  key while in Standby mode. Your phone displays the main menu.
- Press the  key to select “5.Setting” and then press the  key.
- Press the  key to select “1.User Setting” and then press the  key.
- Press the  key to select “2.Talk” and then press the  key.
- Press the  key to select “4.Handover Tone” and then press the  key.
- Press the  key to select “1.Disable” or “2.Enable” and then press the “OK” soft key.

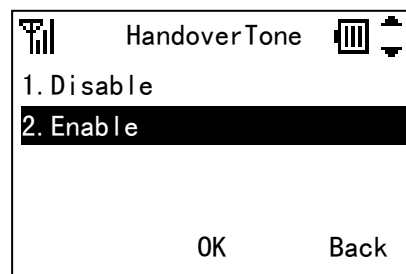

TIP You can reach the Handover Tone menu by pressing the following keys.

To go to the Handover Tone menu:



• TALK START VIBRATION SETTING

Factory Default: Disable

Vibrator can work as talk start notification when a called party answers your call.

- Press the **MENU** key while in Standby mode. Your phone displays the main menu.
- Press the **5** key to select “5.Setting” and then press the **OK** key.
- Press the **1** key to select “1.User Setting” and then press the **OK** key.
- Press the **2** key to select “2.Talk” and then press the **OK** key.
- Press the **5** key to select “5.Talk Start Vib” and then press the **OK** key.
- Press the **1** key to select “1.Disable” or “2.Enable” and then press the “OK” soft key.

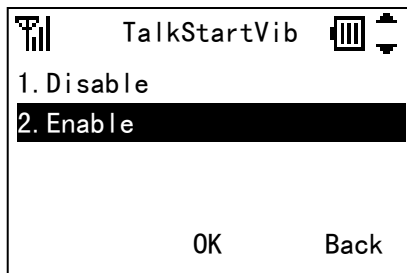

TIP You can reach the Talk Start Vib menu by pressing the following keys.

To go to the Talk Start Vib menu:



• LCD CONTRAST

Factory Default: 3

You can adjust LCD contrast.

- Press the **MENU** key while in Standby mode. Your phone displays the main menu.
- Press the **5** key to select “5.Setting” and then press the **OK** key.
- Press the **1** key to select “1.User Setting” and then press the **OK** key.
- Press the **3** key to select “3.Display” and then press the **OK** key.
- Press the **1** key to select “1.LCD Contrast” and then press the **OK** key.
- LCD Contrast can be set in 5 levels (1 to 5).
- Press the **4** key to select an appropriate contrast and then press the “OK” soft key.

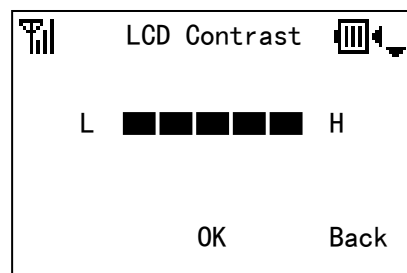

TIP You can reach the LCD Contrast menu by pressing the following keys.

To go to the LCD Contrast menu:



• BACK LIGHT

Factory Default: 5sec

You can adjust a timer until the LCD back light is off.

- Press the **MENU** key while in Standby mode. Your phone displays the main menu.
- Press the **5** key to select “5.Setting” and then press the **OK** key.
- Press the **1** key to select “1.User Setting” and then press the **OK** key.
- Press the **3** key to select “3.Display” and then press the **OK** key.
- Press the **2** key to select “2.Back Light” and then press the **OK** key.
- Back Light can be set 5 to 30 seconds.
- Edit an appropriate timer value and then press the “OK” soft key.

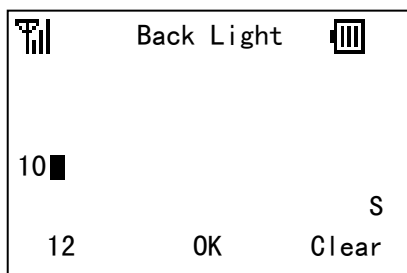

TIP You can reach the Back Light menu by pressing the following keys.

To go to the Back Light menu:



• FONT SIZE

Factory Default: Standard

You can select a font size.

- Press the **MENU** key while in Standby mode. Your phone displays the main menu.
- Press the **5** key to select “5.Setting” and then press the **OK** key.
- Press the **1** key to select “1.User Setting” and then press the **OK** key.
- Press the **3** key to select “3.Display” and then press the **OK** key.
- Press the **2** key to select “3.Font Size” and then press the **OK** key.
- Press the **1** key to select “1.Standard” or “2.Large” and then press the “OK” soft key.

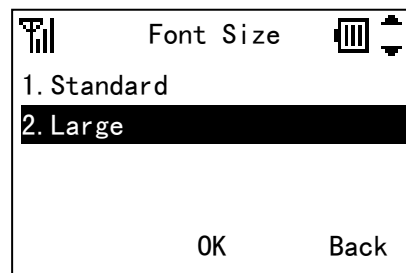

TIP Font size does not change in edit screen even if you set font size to large.

TIP You can reach the Font Size menu by pressing the following keys.











To go to the Font Size menu:



• LANGUAGE

Factory Default: English

The information on the LCD can be displayed in English or Japanese. You can select from the 7 languages by doing the following.

- Press the  key while in Standby mode. Your phone displays the main menu.
- Press the  key to select “5.Setting” and then press the  key.
- Press the  key to select “1.User Setting” and then press the  key.
- Press the  key to select “3.Display” and then press the  key.
- Press the  key to select “4.Language” and then press the  key.
- Press the  key to select language you want and then press the “OK” soft key.

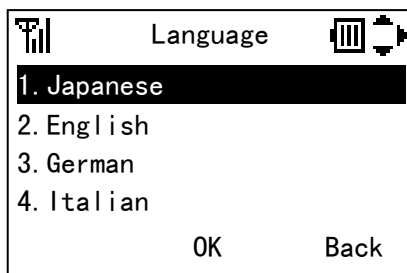

TIP

You can reach the Language menu by pressing the following keys.



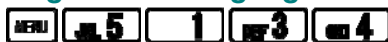





To go to the Language menu:



• MY NAME

Factory Default: MH240

Your phone can display specific strings (up to 10 characters) such as your name in Standby mode.

- Press the  key while in Standby mode. Your phone displays the main menu.
- Press the  key to select “5.Setting” and then press the  key.
- Press the  key to select “1.User Setting” and then press the  key.
- Press the  key to select “3.Display” and then press the  key.
- Press the  key to select “5.My Name” and then press the  key.
- Edit strings you want to display in Standby mode. Then press the “OK” soft key.

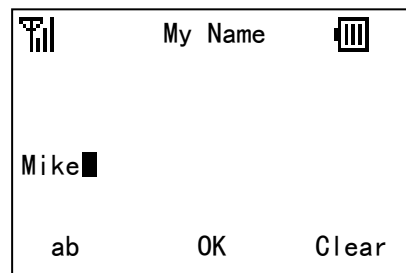

TIP

You can reach the My Name menu by pressing the following keys.











To go to the My Name menu:



• DISPLAY PATTERN

Factory Default: Normal

Your phone can display reversed LCD pattern.

- Press the  key while in Standby mode. Your phone displays the main menu.
- Press the  key to select “5.Setting” and then press the  key.
- Press the  key to select “1.User Setting” and then press the  key.
- Press the  key to select “3.Display” and then press the  key.
- Press the  key to select “6.Display Pattern” and then press the  key.
- Press the  key to select “1.Normal” or “2.Reversing” and then press the “OK” soft key.

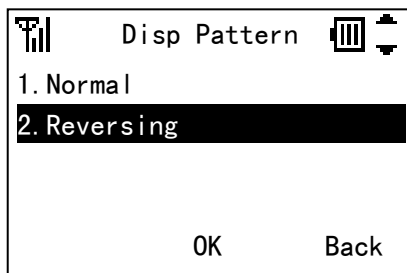

TIP You can reach the Display Pattern menu by pressing the following keys.

To go to the Display Pattern menu:









• CHANGE PASSWORD

Factory Default: -

You can change the password that is used for Password Lock.

TIP Please contact your network administrator to receive your password.

TIP Use 4 numeric characters for a password.

- Press the  key while in Standby mode. Your phone displays the main menu.
- Press the  key to select “5.Setting” and then press the  key.
- Press the  key to select “1.User Setting” and then press the  key.
- Press the  key to select “4.Change Password” and then press the  key.
- Enter your current password and then press the “OK” soft key.

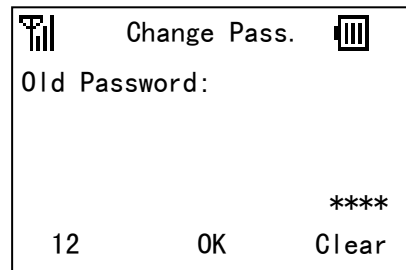

- Enter the new password you want and then press the “OK” soft key.

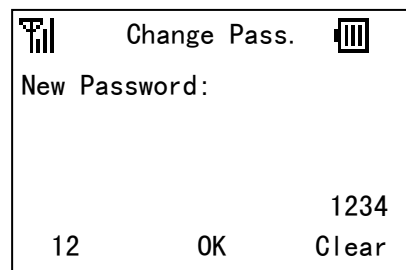

TIP You can reach the Change Password menu by pressing the following keys.











To go to the Change Password menu:



• KEY TOUCH TONE

Factory Default: Disable

You can unmute or mute a tone that is provided when you press any key on your phone.

- Press the  key while in Standby mode. Your phone displays the main menu.
- Press the  key to select “5.Setting” and then press the  key.
- Press the  key to select “1.User Setting” and then press the  key.
- Press the  key to select “6.Keypad Mode” and then press the  key.
- Press the  key to select “1.Key Touch Tone” and then press the  key.
- Press the  key to select “1.Disable” or “2.Enable” and then press the “OK” soft key.

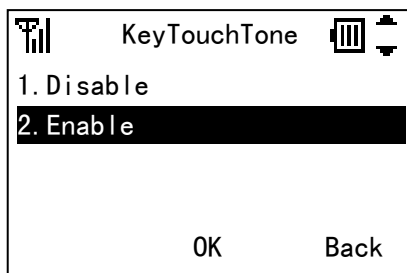

TIP

You can reach the Key Touch Tone menu by pressing the following keys.



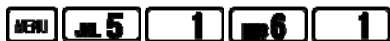







To go to the Key Touch Tone menu:



• SPEAKER MONITOR

Factory Default: Disable

You can use the Speaker monitor while talking as required. When entering Speaker monitor mode, you can hear the called party's voice from the speaker of your phone.

- Press the  key while in Standby mode. Your phone displays the main menu.
- Press the  key to select “5.Setting” and then press the  key.
- Press the  key to select “1.User Setting” and then press the  key.
- Press the  key to select “6.Keypad Mode” and then press the  key.
- Press the  key to select “5.Speaker monitor” and then press the  key.
- Press the  key to select “1.Disable” or “2.Enable” and then press the “OK” soft key.

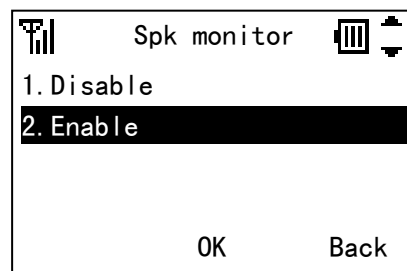

TIP

You can reach the Speaker monitor menu by pressing the following keys.











To go to the Speaker monitor menu:



• DATE

Factory Default: 2008/ 1/ 1 (YYYY/MM/DD)

You can adjust the date information of your phone as required.

- Press the  key while in Standby mode. Your phone displays the main menu.
- Press the  key to select “5.Setting” and then press the  key.
- Press the  key to select “1.User Setting” and then press the  key.
- Press the  key to select “7.Date & Time” and then press the  key.
- Press the  key to select “1.Date” and then press the  key.
- Press the  key to adjust Year, Month and Day and then press the “OK” soft key.

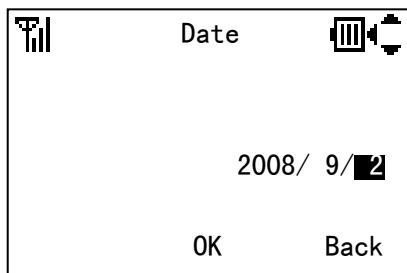

TIP You can set date from 2000/1/1 to 2030/12/31.

TIP You can reach the Date menu by pressing the following keys.











To go to the Date menu:



• TIME

Factory Default: 0: 0 (HH:MM)

You can adjust time information of your phone as required.

- Press the  key while in Standby mode. Your phone displays the main menu.
- Press the  key to select “5.Setting” and then press the  key.
- Press the  key to select “1.User Setting” and then press the  key.
- Press the  key to select “7.Date & Time” and then press the  key.
- Press the  key to select “2.Time” and then press the  key.
- Press the  key to adjust Hour and Minute and then press the “OK” soft key.

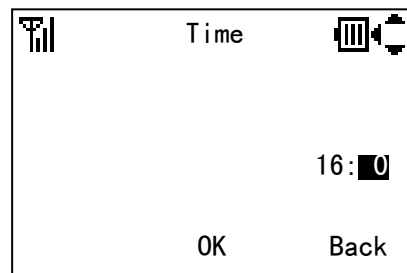

TIP You can reach the Time menu by pressing the following keys.











To go to the Time menu:



• TIME FORMAT

Factory Default: 12hour

You can select a time format (12hours, 12hours (AM0:00) and 24hours) as required.

- Press the  key while in Standby mode. Your phone displays the main menu.
- Press the  key to select “5.Setting” and then press the  key.
- Press the  key to select “1.User Setting” and then press the  key.
- Press the  key to select “7.Date & Time” and then press the  key.
- Press the  key to select “3.Time Format” and then press the  key.
- Press the  key to select “1.12hours”, “2.12hours(AM0:00)” or “3.24hours” and then press the “OK” soft key.

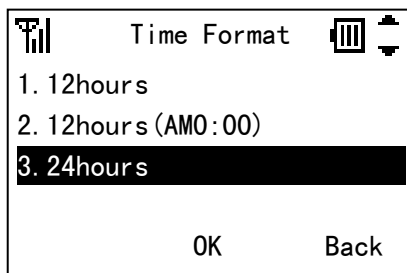

TIP

You can reach the Time Format menu by pressing the following keys.











To go to the Time Format menu:



• DAYLIGHT SAVING

Factory Default: Disable

You can use daylight saving as required.

- Press the  key while in Standby mode. Your phone displays the main menu.
- Press the  key to select “5.Setting” and then press the  key.
- Press the  key to select “1.User Setting” and then press the  key.
- Press the  key to select “7.Date & Time” and then press the  key.
- Press the  key to select “4.Daylight Saving” and then press the  key.
- Press the  key to select “1.Disable” or “2.Enable” and then press the “OK” soft key.

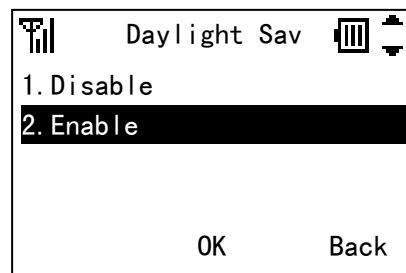

TIP

You should not set daylight saving to enable when your phone displays I-SIP icon.

TIP

You can reach the Daylight Saving menu by pressing the following keys.











To go to the Daylight Saving menu:



• NTP SETTING

Factory Default: Disable

You can use NTP server in your network as required.

- Press the  key while in Standby mode. Your phone displays the main menu.
- Press the  key to select “5.Setting” and then press the  key.
- Press the  key to select “1.User Setting” and then press the  key.
- Press the  key to select “7.Date & Time” and then press the  key.
- Press the  key to select “5.NTP Setting” and then press the  key.
- Press the  key to select “1.Disable” or “2.Enable” and then press the “OK” soft key.

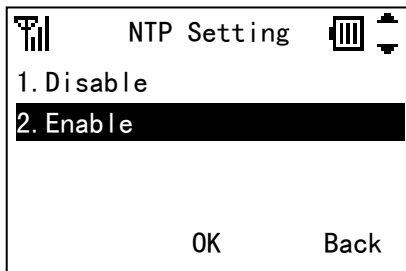

TIP Please confirm your network administrator whether you can use NTP Server.

TIP You can reach the NTP Setting menu by pressing the following keys.









To go to the NTP Setting menu:



• NTP SERVER

Factory Default: -

You can set a NTP server in your network as required.

- Press the  key while in Standby mode. Your phone displays the main menu.
- Press the  key to select “5.Setting” and then press the  key.
- Press the  key to select “1.User Setting” and then press the  key.
- Press the  key to select “7.Date & Time” and then press the  key.
- Press the  key to select “6.NTP Server” and then press the  key.
- Edit an appropriate NTP Server Address (IP or FQDN) and then press the “OK” soft key.

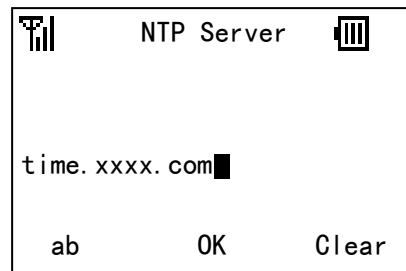

TIP Please contact your network administrator to retrieve your NTP Server Address.

TIP You can reach the NTP Server menu by pressing the following keys.











To go to the NTP Server menu:



• TIME ZONE

Factory Default: Depending on country

You can set time offset in the range -12:00 to +14:00, which specifies time offset between GMT and your area.

- Press the  key while in Standby mode. Your phone displays the main menu.
- Press the  key to select “5.Setting” and then press the  key.
- Press the  key to select “1.User Setting” and then press the  key.
- Press the  key to select “7.Date & Time” and then press the  key.
- Press the  key to select “7.Time Zone” and then press the  key.
- Press the  key to adjust an appropriate time offset and then press the “OK” soft key.

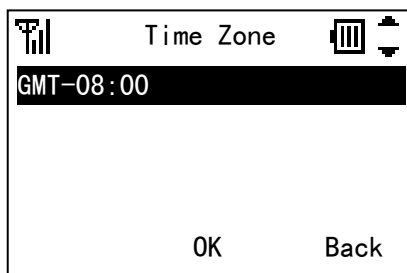

TIP You can reach the Time Zone menu by pressing the following keys.

To go to the Time Zone menu:



9. INFORMATION

You can confirm the information of your phone such as Phone Number, IP address and MAC address.

• TO DISPLAY STATUS

You can confirm the Status of your phone by:

- SIP Status
 - Wireless Status
- Press the **MENU** key while in Standby mode. Your phone displays the main menu.
 - Press the **0** key to select “0.Information” and then press the **1** key.
 - Press **1** key to select “1.Status” and then press the **1** key.

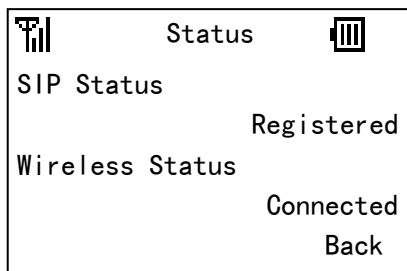

TIP You can view the Status by pressing the following keys.

To View the Status:

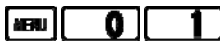

• TO DISPLAY WIRELESS STATUS

You can confirm the Wireless Status of your phone by:

- BSSID
 - ESSID
 - Channel
 - MAC address
 - Security
 - Rate
- Press the **MENU** key while in Standby mode. Your phone displays the main menu.
 - Press the **0** key to select “0.Information” and then press the **2** key.
 - Press the **2** key to select “2.Wireless” and then press the **2** key.

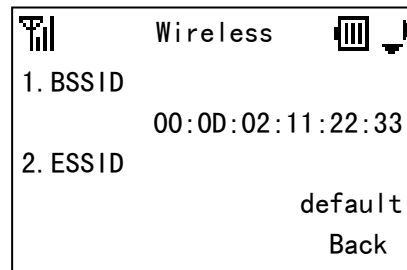





TIP You can view the Wireless Status by pressing the following keys.

To View the Wireless Status:



• TO DISPLAY IP ADDRESS

You can confirm the IP Address of your phone by:

- IP Address
 - Net Mask
 - Gateway
 - DNS Primary
 - DNS Secondary
- Press the  key while in Standby mode. Your phone displays the main menu.
 - Press the  key to select “0.Information” and then press the  key.
 - Press the  key to select “3.IP Address” and then press the  key.

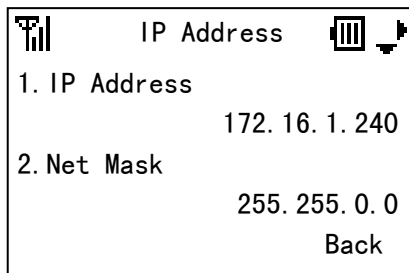



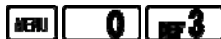

TIP You can view the IP Address by pressing the following keys.

To View the IP Address:



• TO DISPLAY SIP STATUS

You can confirm the SIP Status of your phone by:

- SIP Status
 - Phone No.
 - SIP Proxy
 - SIP Port
 - Registrar
 - Registrar Port
- Press the  key while in Standby mode. Your phone displays the main menu.
 - Press the  key to select “0.Information” and then press the  key.
 - Press the  key to select “4.SIP” and then press the  key.

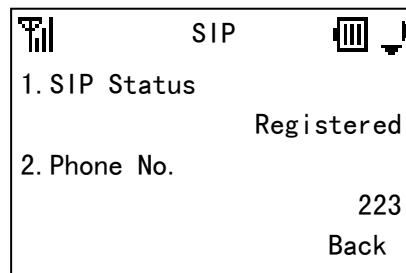

TIP You can view the SIP Status by pressing the following keys.

To View the SIP Status:

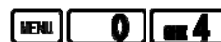

10. PASSWORD LOCK

You can lock your phone against unauthorized usage. This is also useful for guarding your phone against inadvertent button presses.

• TO USE MANUAL LOCK

- Press and hold the **HOLD** key for 2 seconds or more to lock your phone in Standby mode.
- Your phone is locked and displays a lock icon (🔒).

TIP *You can make an Emergency Call even if your phone is locked.*

• TO UNLOCK YOUR PHONE

- Press any key except  key and digit key and then input your password (4 digits).

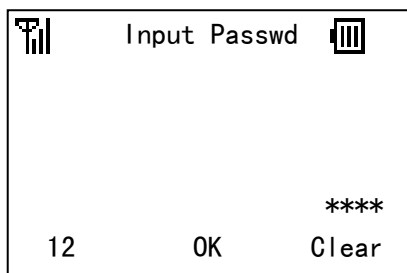











- Your phone is unlocked and a lock icon (🔒) disappears.

TIP *Please contact your network administrator to receive your password.*

• TO ENBLE MANUAL LOCK

Factory Default: Disable

- Press the  key while in Standby mode. Your phone displays the main menu.
- Press the  key to select “5.Setting” and then press the  key.
- Press the  key to select “1.User Setting” and then press the  key.
- Press the  key to select “5.Password Lock” and then press the  key.
- Press the  key to select “1.Manual lock” and then press the  key.
- Press the  key to select “2.Enable” and then press the “OK” soft key.

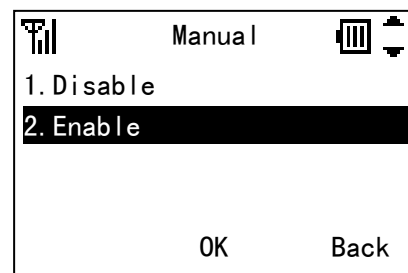

TIP *You can reach the Manual lock menu by pressing the following keys.*

To go to the Manual lock menu:



• TO USE OUTSIDE LOCK

Factory Default: 0sec (Disable)

When your phone is in out of service area, your phone is locked automatically expire timer you set.

- Press the **MENU** key while in Standby mode. Your phone displays the main menu.
- Press the **5** key to select “5.Setting” and then press the **OK** key.
- Press the **1** key to select “1.User Setting” and then press the **OK** key.
- Press the **5** key to select “5.Password Lock” and then press the **OK** key.
- Press the **2** key to select “2.Auto lock” and then press the **OK** key.
- Press the **1** key to select “1.Outside Lock” and then press the **OK** key.
- Edit an appropriate timer value (0:disable to 3600sec) and then press the “OK” soft key.

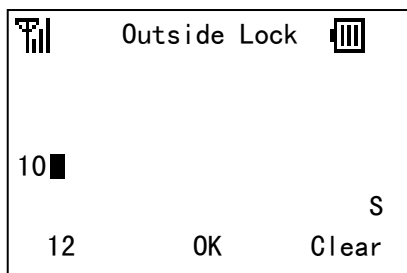

TIP You can reach the Outside Lock menu by pressing the following keys.

To go to the Outside Lock menu:



• TO USE POWER OFF LOCK

Factory Default: Disable

When your phone is turned on after power off, your phone is locked automatically.

- Press the **MENU** key while in Standby mode. Your phone displays the main menu.
- Press the **5** key to select “5.Setting” and then press the **OK** key.
- Press the **1** key to select “1.User Setting” and then press the **OK** key.
- Press the **5** key to select “5.Password Lock” and then press the **OK** key.
- Press the **2** key to select “2.Auto lock” and then press the **OK** key.
- Press the **2** key to select “2.Power Off Lock” and then press the **OK** key.
- Press the **2** key to select “2.Enable” and then press the “OK” soft key.

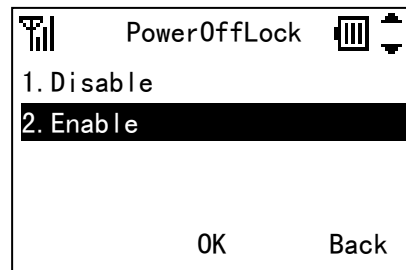

TIP You can reach the Power Off Lock menu by pressing the following keys.

To go to the Power Off Lock menu:



11. PREFIX DIAL

You can add Prefix Dial to phone number when you make a call.

• TO USE PREFIX DIAL

You can use Prefix Dial as follows.

To Make a Call by preset dialing:

- Enter the phone number and then press the “Prefix” soft key.

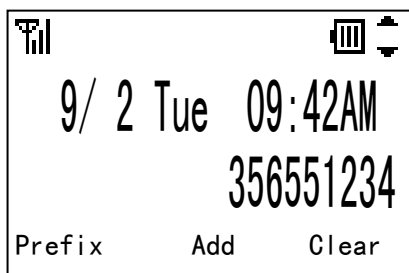

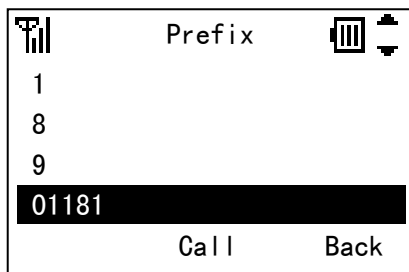

- Press the  key to select Prefix and then press the “Call” soft key.





TIP

You can not make a call when total digits of preset dial and prefix are more than 32.

To Make a Call from Call History:

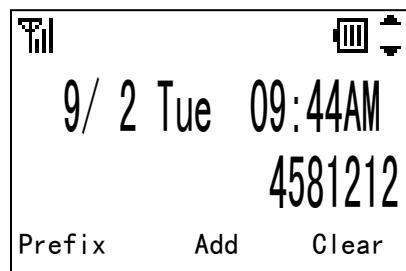
- Press the  key to view a call history you want and then press the  key to select a phone number you want.
- Press the  key and then press the “Prefix” soft key.



- Press the  key to select Prefix and then press the “Call” soft key.

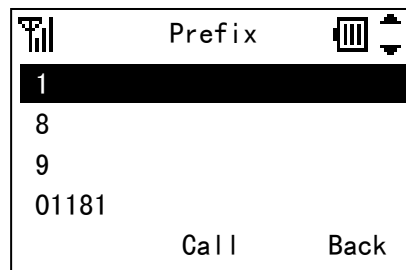

To Make a Call from Directory:

- Press the key to view Directory and then press the key to select a called party you want.
- Press the key and then press the key to select a phone number you want.

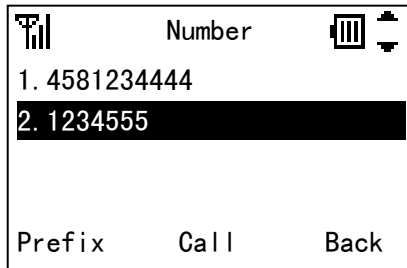

- Press the “Prefix” soft key.
- Press the key to select Prefix and then press the “Call” soft key.

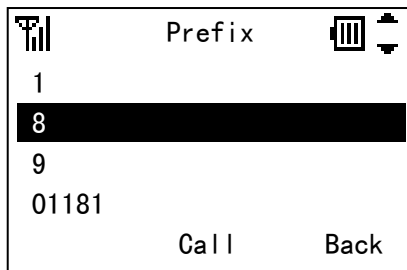

• TO REGISTER PREFIX NO.

Factory Default: -

- Press the key while in Standby mode. Your phone displays the main menu.
- Press the key to select “5.Setting” and then press the key.
- Press the key to select “1.User Setting” and then press the key.
- Press the key to select “2.Talk” and then press the key.
- Press the key to select “6.Reg. Prefix No.” and then press the key.
- Press the key to select a registered area and then press the key.

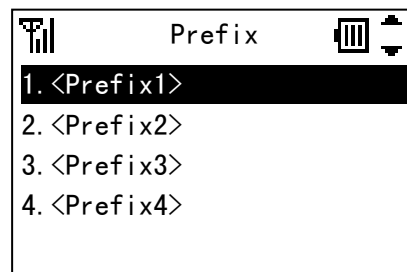

- Edit prefix number you want and then press the “OK” soft key.

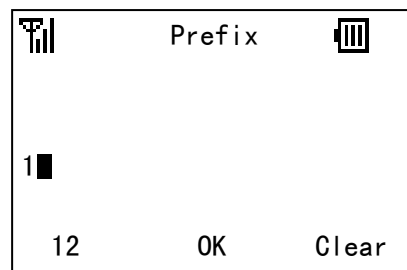

TIP You can reach Register Prefix No. menu by pressing the following keys.





To go to the Register Prefix No. menu:



12. FAVORITES

You can use favorites menu that you can customize.

• TO USE FAVORITES

- Press the  key while in Standby mode. Your phone displays the main menu.
- Press the  key to select “#.Favorites” and then press the  key.
- Press the  key to select a menu you want to use and then press the “OK” soft key.

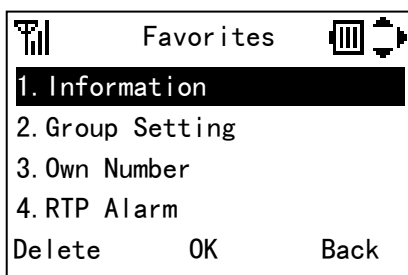





TIP You can reach the Favorites menu by pressing the following keys.



To go to the Favorites menu:





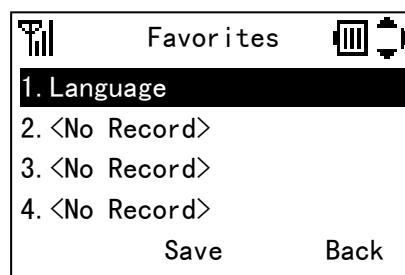

• TO ENTRY A MENU TO FAVORITES

- Press the  key while in Standby mode. Your phone displays the main menu.
- Press the  key to select “#.Favorites” and then press the  key.
- Press the  key to select an entry area and then press the “Save” soft key.



- Press the  key and the  key to select a menu you want to entry and then press the “Save” soft key.

• TO DELETE A MENU FROM FAVORITES

- Press the  key while in Standby mode. Your phone displays the main menu.
- Press the  key to select “#.Favorites” and then press the  key.
- Press the  key to select an entry area and then press the “Delete” soft key.

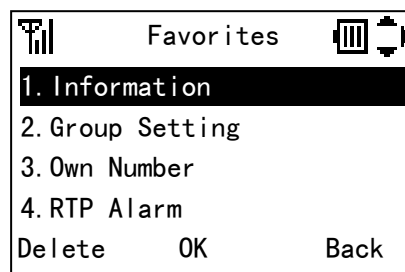

- Press the  key to select the “OK” soft key.

This page is for your notes.

13. MENU LIST

• MENU LIST

The following shows the menu list of MH240 with the default values and remarks as required.

Category	Menu	Default	Remarks
MENU	0.Information 1.Call History 2.Directory 3.Tools 4.Voice Mail 5.Setting #.Favorites		This is main menu of the phone.

Category	Menu	Default	Remarks
0.Information			
1.Status	SIP Status Not Registered / Registering / Registered Wireless Status Not Connected / Searching / Authenticating / Getting IP / Connecting / Connected		
2.Wireless	BSSID xx:xx:xx:xx:xx:xx ESSID Channel 1 to 11 MACAddress xx:xx:xx:xx:xx:xx Security OPEN / WEP / WPA-PSK / WPA2-PSK / WPA / WPA2 Rate 1 to 54 Mbps		
3.IP Address	IP Address xxx.xxx.xxx.xxx Net Mask xxx.xxx.xxx.xxx Gateway xxx.xxx.xxx.xxx DNS Primary xxx.xxx.xxx.xxx DNS Secondary xxx.xxx.xxx.xxx		
4.SIP	SIP Status Not Registered / Registering / Registered Phone No. SIP Proxy SIP Port xxxxx Registrar Registrar Port xxxxx		
1.Call History			
1.Missed	No Data (when no record)		Up to 50 entries
2.Outgoing	No Data (when no record)		Up to 50 entries
3.Incoming	No Data (when no record)		Up to 50 entries
4.All Delete	1.Outgoing 2.Incoming 3.All		
2.Directory			
1.Search			
1.Personal			
1.Group	01.Default to 20.Group20		
2.Name	(alphanumeric characters)		32bytes
3.Tel Number	(32 digits)		32bytes
4.Others			
1.Memory ID	001 to 500		
2.Alphabet	2.ABC 3.DEF 4.GHI 5.JKL 6.MNO 7.PQRS 8.TUV 9.WXYZ *.Other #.All		
3.Company	(alphanumeric characters)		32bytes

Category	Menu	Default	Remarks
2.Edit			
Name	(alphanumeric characters)	blank	32bytes
Group	01.Default to 20.Group20	01.Default	
Tel #1	(32 digits)	blank	32bytes
Tel #2	(32 digits)	blank	32bytes
Tel #3	(32 digits)	blank	32bytes
Company Name	(alphanumeric characters)	blank	32bytes
Ring Tone	01.Disable 02.Default 03.Tone Type1 04.Tone Type2 05.Tone Type3 06.Tone Type4 07.Tone Type5 08.Tone Type6 09.Tone Type7 10.Tone Type8 11.Tone Type9 12.Tone Type10 13.Tone Type11 14.Tone Type12 15.Tone Type13 16.Download1 17.Download2 18.Download3	02.Default	
Illumination	1.Disable 2.Default 3.Red 4.Green 5.Orange	2.Default	
Vibrator	1.Disable 2.Default 3.Pattern1 4.Pattern2	2.Default	
3.Group Setting			
01.Default 02.Colleagues 03.VIPs 04.Family 05.Friends 06.Group6 07.Group7 08.Group8 09.Group9 10.Group10 11.Group11 12.Group12 13.Group13 14.Group14 15.Group15 16.Group16 17.Group17 18.Group18 19.Group19 20.Group20	1.Name	(alphanumeric characters)	blank
	2.Ring Tone	01.Disable 02.Default 03.Tone Type1 04.Tone Type2 05.Tone Type3 06.Tone Type4 07.Tone Type5 08.Tone Type6 09.Tone Type7 10.Tone Type8 11.Tone Type9 12.Tone Type10 13.Tone Type11 14.Tone Type12 15.Tone Type13 16.Download1 17.Download2 18.Download3	02.Default
	3.Illumination	1.Disable 2.Default 3.Red 4.Green 5.Orange	2.Default
	4.Vibrator	1.Disable 2.Default 3.Pattern1 4.Pattern2	2.Default
4.Own Number		Own Number	
5.All Delete		(Delete all Directory)	

Category	Menu	Default	Remarks
3.Tools			
1.Sitte Survey			
1.AP Scan	(Chanel 1 to 11)	1	
2.Ping	(xxx.xxx.xxx.xxx)	blank	
4.Voice Mail			
5.Setting			
1.User Setting			
1.Incoming Call			
1.Ring Volume	Large Middle Small Gently Off	Middle	
2.Ring Tone			
1.External Ring 2.Internal Ring 3.IM 4.Non-notification	01.Tone Type1 02.Tone Type2 03.Tone Type3 04.Tone Type4 05.Tone Type5 06.Tone Type6 07.Tone Type7 08.Tone Type8 09.Tone Type9 10.Tone Type10 11.Tone Type11 12.Tone Type12 13.Tone Type13 14.Download1 15.Download2 16.Download3	01.Tone Type1	
3.Incoming Popup	1.Disable 2.Enable	1.Disable	
4.Illumination			
1.External Ring 2.Internal Ring 3.IM 4.Non-notification	1.Disable 2.Red 3.Green 4.Orange	3.Green	
5.Private Call	1.Allow Incoming 2.Block Incoming	1.Allow Incoming	
6.Vibrator			
1.External Ring 2.Internal Ring 3.IM 4.Non-notification	1.Disable 2.Pattern1 3.Pattern2	2.Pattern1	
7.Incoming Mode	1.Both 2.Ring-->Vib 3.Vib-->Ring	1.Both	
8.Headset			
1.Ring Tone Sending	1.Headset 2.Speaker	1.Headset	
2.Auto Response	None 1 time 2 times 3 times 4 times 5 times	None	
9.Offhook Ring	1.Disable 2.Enable	2.Enable	

Category	Menu	Default	Remarks
2.Talk			
1.RTP Alarm	1.Disable 2.Enable	1.Disable	
2.Hold Music	01.Tone Type1 02.Tone Type2 03.Tone Type3 04.Tone Type4 05.Tone Type5 06.Tone Type6 07.Tone Type7 08.Tone Type8 09.Tone Type9 10.Tone Type10 11.Tone Type11 12.Tone Type12 13.Tone Type13 14.Download1 15.Download2 16.Download3	12.Tone Type12	
3.Call Volume	Large Middle Small	Middle	
4.Handover Tone	1.Disable 2.Enable	1.Disable	
5.Talk Start Vib	1.Disable 2.Enable	1.Disable	
6.Reg. Prefix No.	1.<Prefix1> 2.<Prefix2> 3.<Prefix3> 4.<Prefix4>	blank	31bytes
3.Display			
1.LCD Contrast	(Level 1 to 5)	3	
2.Back Light	(5 to 30 sec)	5 sec	
3.Font Size	1.Standard 2.Large	1.Standard	
4.Language	1.Japanese 2.English 3.German 4.Italian 5.Dutch 6.Spanish 7.Norwegian	2.English	
5.My Name	(alphanumeric characters)	MH240	10bytes
6.Display Pattern	1.Normal 2.Reversing	1.Normal	
4.Change Password			
Old Password	(4 digits)	blank	4bytes
New Password	(4 digits)	blank	4bytes
5.Password Lock			
1.Manual Lock	1.Disable 2.Enable	1.Disable	
2.Auto Lock			
1.Outside Lock	(0 to 3600 sec)	0 (Disable)	
2.Power Off Lock	1.Disable 2.Enable	1.Disable	

Category	Menu	Default	Remarks
6. Keypad Mode			
1.Key Touch Tone	1.Disable 2.Enable	1.Disable	
2.Function Key	1.System 2.Speed Dial	2.Speed Dial	
3.Dial Key	1.Alphabet Search 2.Preset Dial	1.Alphabet Search	
4.Assign Dial			
F1.	1.Name	(alphanumeric characters)	blank
F2.	2.TEL	(32 digits)	blank
F3.			
F4.			
F5.			
F6.			
F7.			
F8.			
D1.			
D2.			
D3.			
D4.			
D5.			
D6.			
D7.			
D8.			
D9.			
D0.			
5.Speaker Monitor	1.Disable 2.Enable	1.Disable	
7.Date & Time			
1.Date	(YYYY/MM/DD)	2008/ 1/ 1	
2.Time	(HH:MM)	0: 0	
3.Time Format	1.12hour 2.12hour(AM0:00) 3.24hour	1.12hour	
4.Daylight Saving	1.Disable 2.Enable	1.Disable	
5.NTP Setting	1.Disable 2.Enable	1.Disable	
6.NTP Server	(xxx.xxx.xxx.xxx or FQDN)	blank	40bytes
7.Time Zone	GMT-12:00 / -11:00 / -10:00 / -09:30 / -09:00 / -08:00 / -07:00 / -06:00 / -05:00 / -04:00 / -03:30 / -03:00 / -02:00 / -01:00 / +00:00 / +01:00 / +02:00 / +03:00 / +03:30 / +04:00 / +04:30 / +05:00 / +05:30 / +05:45 / +06:00 / +06:30 / +07:00 / +08:00 / +08:45 / +09:00 / +09:30 / +10:00 / +10:30 / +11:00 / +11:30 / +12:00 / +12:45 / +13:00 / +14:00	Depending on country	

Category	Menu	Default	Remarks
2.Download			
1.Download Files	1.Directory 2.Call History 3.User Setting 4.Config 5.Certificate 6.Download1 7.Download2 8.Download3		
2.Download Address	(xxx.xxx.xxx.xxx or FQDN)	172.16.254.1	40bytes
3.FTP Settings			
1.User ID	(characters)	blank	40bytes
2.Password	(characters)	blank	40bytes
3.Folder	(characters)	mh240	40bytes
3.Maintenance			
1.Config (Need Config Password)			
Password	(4 digits)	blank	4bytes
1.Network Setting	1.Profile 2.Hand-off List 3.1st Connect		
2.SIP Setting			
1.NEC-SETUP 2.<SIP Prof2> 3.<SIP Prof3> 4.<SIP Prof4> 5.<SIP Prof5> 6.<SIP Prof6> 7.<SIP Prof7> 8.<SIP Prof8> 9.<SIP Prof9>	1.Profile Name 2.SIP Proxy 3.SIP Port 4.Registrar 5.Registrar Port 6.User ID 7.User Password 8.Phone No. 9.I-SIP Port 0.Advanced		
3.Config Password			
Old Password	(4 digits)	blank	4bytes
New Password	(4 digits)	blank	4bytes
2.Check			
1.Monitoring			
1.QoS			
1.QoS Monitor	LostPacket: Codec: Payload:		
2.Refresh Timer	(0 to 30 sec)	5 sec	
2.Ping	(xxx.xxx.xxx.xxx)	blank	
2.Information			
1.Status 2.Wireless 3.IP Address 4.SIP	Same as "0.Information"		
3.PC Port	1.Close 2.Open	1.Close	
4.USB Connect			
#.Favorites			
	1.Language 2.<No Record> 3.<No Record> 4.<No Record> 5.<No Record> 6.<No Record> 7.<No Record> 8.<No Record> 9.<No Record> 0.<No Record>		

• CHARACTER CODE LIST

The following shows character code list when your phone is in edit mode.

Character Code List

	1st	2nd	3rd	4th	5th	6th	7th	8th	9th	10th	11th	12th	13th
	?	!	*	#	”								
	A	B	C	a	b	c							
	D	E	F	d	e	f							
	G	H	I	g	h	i							
	J	K	L	j	k	l							
	M	N	O	m	n	o							
	P	Q	R	S	p	q	r	s					
	T	U	V	t	u	v							
	W	X	Y	Z	w	x	y	z					
	space												
	.	@	/	()	,	-	_	:	'	~	&	\

14. TROUBLE SHOOTING

• MESSAGE MEANINGS AND SUGGESTIONS





The following shows the meanings and suggestions of messages that may be displayed on your phone.

Message	Meaning & Suggestion
[Password] UnAuthorized!	The entered password is incorrect. Enter the correct password.
[Low Battery] Please charge it	Battery charge level is low. Charge the battery.
[Directory] No Input Name	You didn't edit the Name of Directory. Edit the Name.
[Directory] Directory is Full	The number of entries reached the maximum. To add new entries, delete some entries in advance.
[Handy Key Lock] Handy Key Lock Enabled	Displayed when your phone is locked.
[Handy Key Lock] Handy Key Lock Disabled	Displayed when your phone is unlocked.
[Password Lock] PASSWORD Lock Enabled	Displayed when your phone is locked with a password.
[Setting] X to Y is input	Entered value is out of range. Enter the value of X to Y.

• TIPS AND SUGGESTIONS

The following shows suggestions on how to resolve MH240 operation problems. Confirm the following before making a call:

- Is the power ON?
- Is the battery charged?
- Is the Antenna icon () displayed?

Symptom	Suggestion
Can not power on the phone...	<ul style="list-style-type: none"> - Press the  key and hold more than 2 seconds. - Insert the battery to your phone properly. - Charge the battery.
Can not operate keys on the phone...	<ul style="list-style-type: none"> - Unlock your phone if lock icon () is displayed. - Unlock your phone if “Handy Key Lock” is displayed.
Communication is lost, audio break-up occurs...	<ul style="list-style-type: none"> - Check the receiving signal strength. - Check the battery when  is indicated. - Distance your phone more than 50cm from Access Point.
Can not see Antenna Icon ()...	<ul style="list-style-type: none"> - When you are in area where sufficient signal can not be obtained, move to other area. - SIP server registration is incomplete. If this occurs, please contact your network administrator.
Can not sustain battery power...	<ul style="list-style-type: none"> - Insert the battery to your phone properly. - Place the battery on the proper position of your cradle. - Replace the battery.
Can not make or receive a call...	<ul style="list-style-type: none"> - Make sure that phone number of your phone. To change the phone number, please contact your network administrator.
The phone does not ring...	<ul style="list-style-type: none"> - When your phone is placed in courtesy mode, cancel it. Courtesy icon () appears when your phone is in this mode. - Check ring volume and adjust except “Off”.

15. SPECIFICATIONS

• TECHNICAL SPECIFICATIONS

The following shows the technical specifications of MH240.

Item	Specifications
Wireless Interface	IEEE802.11b/g
Codec	G.711u-Law, G.711A-Law, G.729A, G.729B, G.729AB Payload Size: 20 to 80 ms
Control Protocol	NEC Enhanced SIP, SIP (RFC3261) *Note ,
Authentication	IEEE802.1X (EAP-TLS, PEAP)
Encryption	WEP (64 bit / 128 bit), TKIP, AES
LCD	Monochrome LCD, 120 × 82 pixels
Main Feature	Call History, Directory, Speed Dial, Courtesy Mode
Ringer	Ring Tone : selectable from 16 kinds Ring Volume : selectable from 5 levels
Battery	Lithium Ion Battery, 3.7 V - 850 mAh
Battery Life	Talk Time : up to 3 hours Standby Time : up to 80 hours
AC Adapter	INPUT : AC 100 V to 240 V, 50/60 Hz, 0.25 A OUTPUT : DC 5 V, 1 A DC Plug : miniUSB (typeB) plug
Operation Temperature	0 to 40 °C (Under charging : 0 to 35 °C)
Operating Humidity	10 to 90 %
Dimension	135.0 × 48.0 × 17.8 mm
Weight	94.36 g
Certification and Compliance	<USA / Industry Canada> CSA60950-1 FCC Part 15 Class B RSS-210 HAC <Europe> Directive 1999/5/EC EN 60950-1 EN 300 328 EN 301 489-17 EN 50360 <Australia / New Zealand> AS/NZS 60950.1 AS/NZS 4268 AS/ACIF S004 AS/NZS CISPR 22 2006 PTC220 Radiocommunications (Electromagnetic Radiation-Human Exposure) Standard 2003 NZS 2772.1:1999

***Note** In case of using a SIP server except SIP servers recommended by NEC, a connection test is required.

• LED SPECIFICATIONS

The following shows the LED specifications of MH240 and Cradle.

Condition	LED Status
MH240	
Power ON Status *Note1	
1.Power OFF	Blink all color
2.Receiving a call *Note2	Blink Green (100ms ON – 100ms OFF)
3.Holding a call *Note2	Blink Orange (500ms ON – 500ms OFF)
4.You have a voice mail *Note2	Blink Orange (50ms ON – 2000ms OFF)
5.Charge Status	
Not charging	Light Off
Charging	Light Red
Charging is completed	Light Green
Any abnormality is found in the battery	Blink Red (500ms ON – 500ms OFF)
Power OFF Status *Note1	
1.Power ON	Blink all color
2.Charge Status	
Not charging	Light Off
Charging	Light Red
Charging an empty battery	Blink Orange (50ms ON – 950ms OFF)
Charging is completed	Light Green
Any abnormality is found in the battery	Blink Red (500ms ON – 500ms OFF)
Cradle	
1.Charge Status	
Charging	Light Red
Charging an empty battery	Light Orange
Charging is completed	Light Green
Any abnormality is found in the battery	Light Off

***Note1** LED status depends on the order in above table when MH240 is in more than 2 conditions.

***Note2** LED status depend on your system when MH240 displays I-SIP icon.

16.LICENSE

This product uses the software of GPL/LGPL, and we will inform that the customer has the right of obtaining the source code of that software, the modification, and the re-distribution.

Please contact the nearest NEC service office about the method of obtaining the source code.

GNU GENERAL PUBLIC LICENSE
Version 2, June 1991

Copyright (C) 1989, 1991 Free Software Foundation, Inc.
59 Temple Place, Suite 330, Boston, MA 02111-1307 USA
Everyone is permitted to copy and distribute verbatim copies
of this license document, but changing it is not allowed.

Preamble

The licenses for most software are designed to take away your freedom to share and change it. By contrast, the GNU General Public License is intended to guarantee your freedom to share and change free software--to make sure the software is free for all its users. This General Public License applies to most of the Free Software Foundation's software and to any other program whose authors commit to using it. (Some other Free Software Foundation software is covered by the GNU Library General Public License instead.) You can apply it to your programs, too.

When we speak of free software, we are referring to freedom, not price. Our General Public Licenses are designed to make sure that you have the freedom to distribute copies of free software (and charge for this service if you wish), that you receive source code or can get it if you want it, that you can change the software or use pieces of it in new free programs; and that you know you can do these things.

To protect your rights, we need to make restrictions that forbid anyone to deny you these rights or to ask you to surrender the rights. These restrictions translate to certain responsibilities for you if you distribute copies of the software, or if you modify it.

For example, if you distribute copies of such a program, whether gratis or for a fee, you must give the recipients all the rights that you have. You must make sure that they, too, receive or can get the source code. And you must show them these terms so they know their rights.

We protect your rights with two steps: (1) copyright the software, and (2) offer you this license which gives you legal permission to copy, distribute and/or modify the software.

Also, for each author's protection and ours, we want to make certain that everyone understands that there is no warranty for this free software. If the software is modified by someone else and passed on, we want its recipients to know that what they have is not the original, so that any problems introduced by others will not reflect on the original authors' reputations.

Finally, any free program is threatened constantly by software patents. We wish to avoid the danger that redistributors of a free program will individually obtain patent licenses, in effect making the program proprietary. To prevent this, we have made it clear that any patent must be licensed for everyone's free use or not licensed at all.

The precise terms and conditions for copying, distribution and modification follow.

GNU GENERAL PUBLIC LICENSE
TERMS AND CONDITIONS FOR COPYING, DISTRIBUTION AND MODIFICATION

0. This License applies to any program or other work which contains a notice placed by the copyright holder saying it may be distributed under the terms of this General Public License. The "Program", below, refers to any such program or work, and a "work based on the Program" means either the Program or any derivative work under copyright law: that is to say, a work containing the Program or a portion of it, either verbatim or with modifications and/or translated into another language. (Hereinafter, translation is included without limitation in the term "modification".) Each licensee is addressed as "you".

Activities other than copying, distribution and modification are not covered by this License; they are outside its scope. The act of running the Program is not restricted, and the output from the Program is covered only if its contents constitute a work based on the Program (independent of having been made by running the Program). Whether that is true depends on what the Program does.

1. You may copy and distribute verbatim copies of the Program's source code as you receive it, in any medium, provided that you conspicuously and appropriately publish on each copy an appropriate copyright notice and disclaimer of warranty; keep intact all the notices that refer to this License and to the absence of any warranty; and give any other recipients of the Program a copy of this License along with the Program.

You may charge a fee for the physical act of transferring a copy, and you may at your option offer warranty protection in exchange for a fee.

2. You may modify your copy or copies of the Program or any portion of it, thus forming a work based on the Program, and copy and distribute such modifications or work under the terms of Section 1 above, provided that you also meet all of these conditions:

- a) You must cause the modified files to carry prominent notices stating that you changed the files and the date of any change.
- b) You must cause any work that you distribute or publish, that in whole or in part contains or is derived from the Program or any part thereof, to be licensed as a whole at no charge to all third parties under the terms of this License.
- c) If the modified program normally reads commands interactively when run, you must cause it, when started running for such interactive use in the most ordinary way, to print or display an announcement including an appropriate copyright notice and a notice that there is no warranty (or else, saying that you provide a warranty) and that users may redistribute the program under these conditions, and telling the user how to view a copy of this License. (Exception: if the Program itself is interactive but does not normally print such an announcement, your work based on the Program is not required to print an announcement.)

These requirements apply to the modified work as a whole. If identifiable sections of that work are not derived from the Program, and can be reasonably considered independent and separate works in themselves, then this License, and its terms, do not apply to those sections when you distribute them as separate works. But when you distribute the same sections as part of a whole which is a work based on the Program, the distribution of the whole must be on the terms of this License, whose permissions for other licensees extend to the entire whole, and thus to each and every part regardless of who wrote it.

Thus, it is not the intent of this section to claim rights or contest your rights to work written entirely by you; rather, the intent is to exercise the right to control the distribution of derivative or collective works based on the Program.

In addition, mere aggregation of another work not based on the Program with the Program (or with a work based on the Program) on a volume of a storage or distribution medium does not bring the other work under the scope of this License.

3. You may copy and distribute the Program (or a work based on it, under Section 2) in object code or executable form under the terms of Sections 1 and 2 above provided that you also do one of the following:

- a) Accompany it with the complete corresponding machine-readable source code, which must be distributed under the terms of Sections 1 and 2 above on a medium customarily used for software interchange; or,
- b) Accompany it with a written offer, valid for at least three years, to give any third party, for a charge no more than your cost of physically performing source distribution, a complete machine-readable copy of the corresponding source code, to be distributed under the terms of Sections 1 and 2 above on a medium customarily used for software interchange; or,
- c) Accompany it with the information you received as to the offer to distribute corresponding source code. (This alternative is allowed only for noncommercial distribution and only if you received the program in object code or executable form with such an offer, in accord with Subsection b above.)

The source code for a work means the preferred form of the work for making modifications to it. For an executable work, complete source

code means all the source code for all modules it contains, plus any associated interface definition files, plus the scripts used to control compilation and installation of the executable. However, as a special exception, the source code distributed need not include anything that is normally distributed (in either source or binary form) with the major components (compiler, kernel, and so on) of the operating system on which the executable runs, unless that component itself accompanies the executable.

If distribution of executable or object code is made by offering access to copy from a designated place, then offering equivalent access to copy the source code from the same place counts as distribution of the source code, even though third parties are not compelled to copy the source along with the object code.

4. You may not copy, modify, sublicense, or distribute the Program except as expressly provided under this License. Any attempt otherwise to copy, modify, sublicense or distribute the Program is void, and will automatically terminate your rights under this License. However, parties who have received copies, or rights, from you under this License will not have their licenses terminated so long as such parties remain in full compliance.

5. You are not required to accept this License, since you have not signed it. However, nothing else grants you permission to modify or distribute the Program or its derivative works. These actions are prohibited by law if you do not accept this License. Therefore, by modifying or distributing the Program (or any work based on the Program), you indicate your acceptance of this License to do so, and all its terms and conditions for copying, distributing or modifying the Program or works based on it.

6. Each time you redistribute the Program (or any work based on the Program), the recipient automatically receives a license from the original licensor to copy, distribute or modify the Program subject to these terms and conditions. You may not impose any further restrictions on the recipients' exercise of the rights granted herein. You are not responsible for enforcing compliance by third parties to this License.

7. If, as a consequence of a court judgment or allegation of patent infringement or for any other reason (not limited to patent issues), conditions are imposed on you (whether by court order, agreement or otherwise) that contradict the conditions of this License, they do not excuse you from the conditions of this License. If you cannot distribute so as to satisfy simultaneously your obligations under this License and any other pertinent obligations, then as a consequence you may not distribute the Program at all. For example, if a patent license would not permit royalty-free redistribution of the Program by all those who receive copies directly or indirectly through you, then the only way you could satisfy both it and this License would be to refrain entirely from distribution of the Program.

If any portion of this section is held invalid or unenforceable under any particular circumstance, the balance of the section is intended to apply and the section as a whole is intended to apply in other circumstances.

It is not the purpose of this section to induce you to infringe any patents or other property right claims or to contest validity of any such claims; this section has the sole purpose of protecting the integrity of the free software distribution system, which is implemented by public license practices. Many people have made generous contributions to the wide range of software distributed through that system in reliance on consistent application of that system; it is up to the author/donor to decide if he or she is willing to distribute software through any other system and a licensee cannot impose that choice.

This section is intended to make thoroughly clear what is believed to be a consequence of the rest of this License.

8. If the distribution and/or use of the Program is restricted in certain countries either by patents or by copyrighted interfaces, the original copyright holder who places the Program under this License may add an explicit geographical distribution limitation excluding those countries, so that distribution is permitted only in or among countries not thus excluded. In such case, this License incorporates

the limitation as if written in the body of this License.

9. The Free Software Foundation may publish revised and/or new versions of the General Public License from time to time. Such new versions will be similar in spirit to the present version, but may differ in detail to address new problems or concerns.

Each version is given a distinguishing version number. If the Program specifies a version number of this License which applies to it and "any later version", you have the option of following the terms and conditions either of that version or of any later version published by the Free Software Foundation. If the Program does not specify a version number of this License, you may choose any version ever published by the Free Software Foundation.

10. If you wish to incorporate parts of the Program into other free programs whose distribution conditions are different, write to the author to ask for permission. For software which is copyrighted by the Free Software Foundation, write to the Free Software Foundation; we sometimes make exceptions for this. Our decision will be guided by the two goals of preserving the free status of all derivatives of our free software and of promoting the sharing and reuse of software generally.

NO WARRANTY

11. BECAUSE THE PROGRAM IS LICENSED FREE OF CHARGE, THERE IS NO WARRANTY FOR THE PROGRAM, TO THE EXTENT PERMITTED BY APPLICABLE LAW. EXCEPT WHEN OTHERWISE STATED IN WRITING THE COPYRIGHT HOLDERS AND/OR OTHER PARTIES PROVIDE THE PROGRAM "AS IS" WITHOUT WARRANTY OF ANY KIND, EITHER EXPRESSED OR IMPLIED, INCLUDING, BUT NOT LIMITED TO, THE IMPLIED WARRANTIES OF MERCHANTABILITY AND FITNESS FOR A PARTICULAR PURPOSE. THE ENTIRE RISK AS TO THE QUALITY AND PERFORMANCE OF THE PROGRAM IS WITH YOU. SHOULD THE PROGRAM PROVE DEFECTIVE, YOU ASSUME THE COST OF ALL NECESSARY SERVICING, REPAIR OR CORRECTION.

12. IN NO EVENT UNLESS REQUIRED BY APPLICABLE LAW OR AGREED TO IN WRITING WILL ANY COPYRIGHT HOLDER, OR ANY OTHER PARTY WHO MAY MODIFY AND/OR REDISTRIBUTE THE PROGRAM AS PERMITTED ABOVE, BE LIABLE TO YOU FOR DAMAGES, INCLUDING ANY GENERAL, SPECIAL, INCIDENTAL OR CONSEQUENTIAL DAMAGES ARISING OUT OF THE USE OR INABILITY TO USE THE PROGRAM (INCLUDING BUT NOT LIMITED TO LOSS OF DATA OR DATA BEING RENDERED INACCURATE OR LOSSES SUSTAINED BY YOU OR THIRD PARTIES OR A FAILURE OF THE PROGRAM TO OPERATE WITH ANY OTHER PROGRAMS), EVEN IF SUCH HOLDER OR OTHER PARTY HAS BEEN ADVISED OF THE POSSIBILITY OF SUCH DAMAGES.

END OF TERMS AND CONDITIONS

How to Apply These Terms to Your New Programs

If you develop a new program, and you want it to be of the greatest possible use to the public, the best way to achieve this is to make it free software which everyone can redistribute and change under these terms.

To do so, attach the following notices to the program. It is safest to attach them to the start of each source file to most effectively convey the exclusion of warranty; and each file should have at least the "copyright" line and a pointer to where the full notice is found.

<one line to give the program's name and a brief idea of what it does.>
Copyright (C) <year> <name of author>

This program is free software; you can redistribute it and/or modify it under the terms of the GNU General Public License as published by the Free Software Foundation; either version 2 of the License, or (at your option) any later version.

This program is distributed in the hope that it will be useful, but WITHOUT ANY WARRANTY; without even the implied warranty of MERCHANTABILITY or FITNESS FOR A PARTICULAR PURPOSE. See the GNU General Public License for more details.

You should have received a copy of the GNU General Public License along with this program; if not, write to the Free Software Foundation, Inc., 59 Temple Place, Suite 330, Boston, MA 02111-1307 USA

Also add information on how to contact you by electronic and paper mail.

If the program is interactive, make it output a short notice like this when it starts in an interactive mode:

```
Gnomovision version 69, Copyright (C) year name of author
Gnomovision comes with ABSOLUTELY NO WARRANTY; for details type `show w'.
This is free software, and you are welcome to redistribute it
under certain conditions; type `show c' for details.
```

The hypothetical commands `show w' and `show c' should show the appropriate parts of the General Public License. Of course, the commands you use may be called something other than `show w' and `show c'; they could even be mouse-clicks or menu items--whatever suits your program.

You should also get your employer (if you work as a programmer) or your school, if any, to sign a "copyright disclaimer" for the program, if necessary. Here is a sample; alter the names:

```
Yoyodyne, Inc., hereby disclaims all copyright interest in the program
`Gnomovision' (which makes passes at compilers) written by James Hacker.
```

```
<signature of Ty Coon>, 1 April 1989
Ty Coon, President of Vice
```

This General Public License does not permit incorporating your program into proprietary programs. If your program is a subroutine library, you may consider it more useful to permit linking proprietary applications with the library. If this is what you want to do, use the GNU Library General Public License instead of this License.

GNU LESSER GENERAL PUBLIC LICENSE
Version 2.1, February 1999

Copyright (C) 1991, 1999 Free Software Foundation, Inc.
59 Temple Place, Suite 330, Boston, MA 02111-1307 USA
Everyone is permitted to copy and distribute verbatim copies
of this license document, but changing it is not allowed.

[This is the first released version of the Lesser GPL. It also counts
as the successor of the GNU Library Public License, version 2, hence
the version number 2.1.]

Preamble

The licenses for most software are designed to take away your
freedom to share and change it. By contrast, the GNU General Public
Licenses are intended to guarantee your freedom to share and change
free software--to make sure the software is free for all its users.

This license, the Lesser General Public License, applies to some
specially designated software packages--typically libraries--of the
Free Software Foundation and other authors who decide to use it. You
can use it too, but we suggest you first think carefully about whether
this license or the ordinary General Public License is the better
strategy to use in any particular case, based on the explanations below.

When we speak of free software, we are referring to freedom of use,
not price. Our General Public Licenses are designed to make sure that
you have the freedom to distribute copies of free software (and charge
for this service if you wish); that you receive source code or can get
it if you want it; that you can change the software and use pieces of
it in new free programs; and that you are informed that you can do
these things.

To protect your rights, we need to make restrictions that forbid
distributors to deny you these rights or to ask you to surrender these
rights. These restrictions translate to certain responsibilities for
you if you distribute copies of the library or if you modify it.

For example, if you distribute copies of the library, whether gratis
or for a fee, you must give the recipients all the rights that we gave
you. You must make sure that they, too, receive or can get the source
code. If you link other code with the library, you must provide
complete object files to the recipients, so that they can relink them
with the library after making changes to the library and recompiling
it. And you must show them these terms so they know their rights.

We protect your rights with a two-step method: (1) we copyright the
library, and (2) we offer you this license, which gives you legal
permission to copy, distribute and/or modify the library.

To protect each distributor, we want to make it very clear that
there is no warranty for the free library. Also, if the library is
modified by someone else and passed on, the recipients should know
that what they have is not the original version, so that the original
author's reputation will not be affected by problems that might be
introduced by others.

Finally, software patents pose a constant threat to the existence of
any free program. We wish to make sure that a company cannot
effectively restrict the users of a free program by obtaining a
restrictive license from a patent holder. Therefore, we insist that
any patent license obtained for a version of the library must be
consistent with the full freedom of use specified in this license.

Most GNU software, including some libraries, is covered by the
ordinary GNU General Public License. This license, the GNU Lesser
General Public License, applies to certain designated libraries, and
is quite different from the ordinary General Public License. We use
this license for certain libraries in order to permit linking those
libraries into non-free programs.

When a program is linked with a library, whether statically or using
a shared library, the combination of the two is legally speaking a
combined work, a derivative of the original library. The ordinary
General Public License therefore permits such linking only if the
entire combination fits its criteria of freedom. The Lesser General
Public License permits more lax criteria for linking other code with

the library.

We call this license the "Lesser" General Public License because it does Less to protect the user's freedom than the ordinary General Public License. It also provides other free software developers Less of an advantage over competing non-free programs. These disadvantages are the reason we use the ordinary General Public License for many libraries. However, the Lesser license provides advantages in certain special circumstances.

For example, on rare occasions, there may be a special need to encourage the widest possible use of a certain library, so that it becomes a de-facto standard. To achieve this, non-free programs must be allowed to use the library. A more frequent case is that a free library does the same job as widely used non-free libraries. In this case, there is little to gain by limiting the free library to free software only, so we use the Lesser General Public License.

In other cases, permission to use a particular library in non-free programs enables a greater number of people to use a large body of free software. For example, permission to use the GNU C Library in non-free programs enables many more people to use the whole GNU operating system, as well as its variant, the GNU/Linux operating system.

Although the Lesser General Public License is Less protective of the users' freedom, it does ensure that the user of a program that is linked with the Library has the freedom and the wherewithal to run that program using a modified version of the Library.

The precise terms and conditions for copying, distribution and modification follow. Pay close attention to the difference between a "work based on the library" and a "work that uses the library". The former contains code derived from the library, whereas the latter must be combined with the library in order to run.

GNU LESSER GENERAL PUBLIC LICENSE TERMS AND CONDITIONS FOR COPYING, DISTRIBUTION AND MODIFICATION

0. This License Agreement applies to any software library or other program which contains a notice placed by the copyright holder or other authorized party saying it may be distributed under the terms of this Lesser General Public License (also called "this License"). Each licensee is addressed as "you".

A "library" means a collection of software functions and/or data prepared so as to be conveniently linked with application programs (which use some of those functions and data) to form executables.

The "Library", below, refers to any such software library or work which has been distributed under these terms. A "work based on the Library" means either the Library or any derivative work under copyright law: that is to say, a work containing the Library or a portion of it, either verbatim or with modifications and/or translated straightforwardly into another language. (Hereinafter, translation is included without limitation in the term "modification".)

"Source code" for a work means the preferred form of the work for making modifications to it. For a library, complete source code means all the source code for all modules it contains, plus any associated interface definition files, plus the scripts used to control compilation and installation of the library.

Activities other than copying, distribution and modification are not covered by this License; they are outside its scope. The act of running a program using the Library is not restricted, and output from such a program is covered only if its contents constitute a work based on the Library (independent of the use of the Library in a tool for writing it). Whether that is true depends on what the Library does and what the program that uses the Library does.

1. You may copy and distribute verbatim copies of the Library's complete source code as you receive it, in any medium, provided that you conspicuously and appropriately publish on each copy an appropriate copyright notice and disclaimer of warranty; keep intact all the notices that refer to this License and to the absence of any warranty; and distribute a copy of this License along with the Library.

You may charge a fee for the physical act of transferring a copy, and you may at your option offer warranty protection in exchange for a fee.

2. You may modify your copy or copies of the Library or any portion of it, thus forming a work based on the Library, and copy and distribute such modifications or work under the terms of Section 1 above, provided that you also meet all of these conditions:

- a) The modified work must itself be a software library.
- b) You must cause the files modified to carry prominent notices stating that you changed the files and the date of any change.
- c) You must cause the whole of the work to be licensed at no charge to all third parties under the terms of this License.
- d) If a facility in the modified Library refers to a function or a table of data to be supplied by an application program that uses the facility, other than as an argument passed when the facility is invoked, then you must make a good faith effort to ensure that, in the event an application does not supply such function or table, the facility still operates, and performs whatever part of its purpose remains meaningful.

(For example, a function in a library to compute square roots has a purpose that is entirely well-defined independent of the application. Therefore, Subsection 2d requires that any application-supplied function or table used by this function must be optional: if the application does not supply it, the square root function must still compute square roots.)

These requirements apply to the modified work as a whole. If identifiable sections of that work are not derived from the Library, and can be reasonably considered independent and separate works in themselves, then this License, and its terms, do not apply to those sections when you distribute them as separate works. But when you distribute the same sections as part of a whole which is a work based on the Library, the distribution of the whole must be on the terms of this License, whose permissions for other licensees extend to the entire whole, and thus to each and every part regardless of who wrote it.

Thus, it is not the intent of this section to claim rights or contest your rights to work written entirely by you; rather, the intent is to exercise the right to control the distribution of derivative or collective works based on the Library.

In addition, mere aggregation of another work not based on the Library with the Library (or with a work based on the Library) on a volume of a storage or distribution medium does not bring the other work under the scope of this License.

3. You may opt to apply the terms of the ordinary GNU General Public License instead of this License to a given copy of the Library. To do this, you must alter all the notices that refer to this License, so that they refer to the ordinary GNU General Public License, version 2, instead of to this License. (If a newer version than version 2 of the ordinary GNU General Public License has appeared, then you can specify that version instead if you wish.) Do not make any other change in these notices.

Once this change is made in a given copy, it is irreversible for that copy, so the ordinary GNU General Public License applies to all subsequent copies and derivative works made from that copy.

This option is useful when you wish to copy part of the code of the Library into a program that is not a library.

4. You may copy and distribute the Library (or a portion or derivative of it, under Section 2) in object code or executable form under the terms of Sections 1 and 2 above provided that you accompany it with the complete corresponding machine-readable source code, which must be distributed under the terms of Sections 1 and 2 above on a medium customarily used for software interchange.

If distribution of object code is made by offering access to copy

from a designated place, then offering equivalent access to copy the source code from the same place satisfies the requirement to distribute the source code, even though third parties are not compelled to copy the source along with the object code.

5. A program that contains no derivative of any portion of the Library, but is designed to work with the Library by being compiled or linked with it, is called a "work that uses the Library". Such a work, in isolation, is not a derivative work of the Library, and therefore falls outside the scope of this License.

However, linking a "work that uses the Library" with the Library creates an executable that is a derivative of the Library (because it contains portions of the Library), rather than a "work that uses the library". The executable is therefore covered by this License. Section 6 states terms for distribution of such executables.

When a "work that uses the Library" uses material from a header file that is part of the Library, the object code for the work may be a derivative work of the Library even though the source code is not. Whether this is true is especially significant if the work can be linked without the Library, or if the work is itself a library. The threshold for this to be true is not precisely defined by law.

If such an object file uses only numerical parameters, data structure layouts and accessors, and small macros and small inline functions (ten lines or less in length), then the use of the object file is unrestricted, regardless of whether it is legally a derivative work. (Executables containing this object code plus portions of the Library will still fall under Section 6.)

Otherwise, if the work is a derivative of the Library, you may distribute the object code for the work under the terms of Section 6. Any executables containing that work also fall under Section 6, whether or not they are linked directly with the Library itself.

6. As an exception to the Sections above, you may also combine or link a "work that uses the Library" with the Library to produce a work containing portions of the Library, and distribute that work under terms of your choice, provided that the terms permit modification of the work for the customer's own use and reverse engineering for debugging such modifications.

You must give prominent notice with each copy of the work that the Library is used in it and that the Library and its use are covered by this License. You must supply a copy of this License. If the work during execution displays copyright notices, you must include the copyright notice for the Library among them, as well as a reference directing the user to the copy of this License. Also, you must do one of these things:

a) Accompany the work with the complete corresponding machine-readable source code for the Library including whatever changes were used in the work (which must be distributed under Sections 1 and 2 above); and, if the work is an executable linked with the Library, with the complete machine-readable "work that uses the Library", as object code and/or source code, so that the user can modify the Library and then relink to produce a modified executable containing the modified Library. (It is understood that the user who changes the contents of definitions files in the Library will not necessarily be able to recompile the application to use the modified definitions.)

b) Use a suitable shared library mechanism for linking with the Library. A suitable mechanism is one that (1) uses at run time a copy of the library already present on the user's computer system, rather than copying library functions into the executable, and (2) will operate properly with a modified version of the library, if the user installs one, as long as the modified version is interface-compatible with the version that the work was made with.

c) Accompany the work with a written offer, valid for at least three years, to give the same user the materials specified in Subsection 6a, above, for a charge no more than the cost of performing this distribution.

d) If distribution of the work is made by offering access to copy from a designated place, offer equivalent access to copy the above

specified materials from the same place.

e) Verify that the user has already received a copy of these materials or that you have already sent this user a copy.

For an executable, the required form of the "work that uses the Library" must include any data and utility programs needed for reproducing the executable from it. However, as a special exception, the materials to be distributed need not include anything that is normally distributed (in either source or binary form) with the major components (compiler, kernel, and so on) of the operating system on which the executable runs, unless that component itself accompanies the executable.

It may happen that this requirement contradicts the license restrictions of other proprietary libraries that do not normally accompany the operating system. Such a contradiction means you cannot use both them and the Library together in an executable that you distribute.

7. You may place library facilities that are a work based on the Library side-by-side in a single library together with other library facilities not covered by this License, and distribute such a combined library, provided that the separate distribution of the work based on the Library and of the other library facilities is otherwise permitted, and provided that you do these two things:

a) Accompany the combined library with a copy of the same work based on the Library, uncombined with any other library facilities. This must be distributed under the terms of the Sections above.

b) Give prominent notice with the combined library of the fact that part of it is a work based on the Library, and explaining where to find the accompanying uncombined form of the same work.

8. You may not copy, modify, sublicense, link with, or distribute the Library except as expressly provided under this License. Any attempt otherwise to copy, modify, sublicense, link with, or distribute the Library is void, and will automatically terminate your rights under this License. However, parties who have received copies, or rights, from you under this License will not have their licenses terminated so long as such parties remain in full compliance.

9. You are not required to accept this License, since you have not signed it. However, nothing else grants you permission to modify or distribute the Library or its derivative works. These actions are prohibited by law if you do not accept this License. Therefore, by modifying or distributing the Library (or any work based on the Library), you indicate your acceptance of this License to do so, and all its terms and conditions for copying, distributing or modifying the Library or works based on it.

10. Each time you redistribute the Library (or any work based on the Library), the recipient automatically receives a license from the original licensor to copy, distribute, link with or modify the Library subject to these terms and conditions. You may not impose any further restrictions on the recipients' exercise of the rights granted herein. You are not responsible for enforcing compliance by third parties with this License.

11. If, as a consequence of a court judgment or allegation of patent infringement or for any other reason (not limited to patent issues), conditions are imposed on you (whether by court order, agreement or otherwise) that contradict the conditions of this License, they do not excuse you from the conditions of this License. If you cannot distribute so as to satisfy simultaneously your obligations under this License and any other pertinent obligations, then as a consequence you may not distribute the Library at all. For example, if a patent license would not permit royalty-free redistribution of the Library by all those who receive copies directly or indirectly through you, then the only way you could satisfy both it and this License would be to refrain entirely from distribution of the Library.

If any portion of this section is held invalid or unenforceable under any particular circumstance, the balance of the section is intended to apply, and the section as a whole is intended to apply in other circumstances.

It is not the purpose of this section to induce you to infringe any patents or other property right claims or to contest validity of any such claims; this section has the sole purpose of protecting the integrity of the free software distribution system which is implemented by public license practices. Many people have made generous contributions to the wide range of software distributed through that system in reliance on consistent application of that system; it is up to the author/donor to decide if he or she is willing to distribute software through any other system and a licensee cannot impose that choice.

This section is intended to make thoroughly clear what is believed to be a consequence of the rest of this License.

12. If the distribution and/or use of the Library is restricted in certain countries either by patents or by copyrighted interfaces, the original copyright holder who places the Library under this License may add an explicit geographical distribution limitation excluding those countries, so that distribution is permitted only in or among countries not thus excluded. In such case, this License incorporates the limitation as if written in the body of this License.

13. The Free Software Foundation may publish revised and/or new versions of the Lesser General Public License from time to time. Such new versions will be similar in spirit to the present version, but may differ in detail to address new problems or concerns.

Each version is given a distinguishing version number. If the Library specifies a version number of this License which applies to it and "any later version", you have the option of following the terms and conditions either of that version or of any later version published by the Free Software Foundation. If the Library does not specify a license version number, you may choose any version ever published by the Free Software Foundation.

14. If you wish to incorporate parts of the Library into other free programs whose distribution conditions are incompatible with these, write to the author to ask for permission. For software which is copyrighted by the Free Software Foundation, write to the Free Software Foundation; we sometimes make exceptions for this. Our decision will be guided by the two goals of preserving the free status of all derivatives of our free software and of promoting the sharing and reuse of software generally.

NO WARRANTY

15. BECAUSE THE LIBRARY IS LICENSED FREE OF CHARGE, THERE IS NO WARRANTY FOR THE LIBRARY, TO THE EXTENT PERMITTED BY APPLICABLE LAW. EXCEPT WHEN OTHERWISE STATED IN WRITING THE COPYRIGHT HOLDERS AND/OR OTHER PARTIES PROVIDE THE LIBRARY "AS IS" WITHOUT WARRANTY OF ANY KIND, EITHER EXPRESSED OR IMPLIED, INCLUDING, BUT NOT LIMITED TO, THE IMPLIED WARRANTIES OF MERCHANTABILITY AND FITNESS FOR A PARTICULAR PURPOSE. THE ENTIRE RISK AS TO THE QUALITY AND PERFORMANCE OF THE LIBRARY IS WITH YOU. SHOULD THE LIBRARY PROVE DEFECTIVE, YOU ASSUME THE COST OF ALL NECESSARY SERVICING, REPAIR OR CORRECTION.

16. IN NO EVENT UNLESS REQUIRED BY APPLICABLE LAW OR AGREED TO IN WRITING WILL ANY COPYRIGHT HOLDER, OR ANY OTHER PARTY WHO MAY MODIFY AND/OR REDISTRIBUTE THE LIBRARY AS PERMITTED ABOVE, BE LIABLE TO YOU FOR DAMAGES, INCLUDING ANY GENERAL, SPECIAL, INCIDENTAL OR CONSEQUENTIAL DAMAGES ARISING OUT OF THE USE OR INABILITY TO USE THE LIBRARY (INCLUDING BUT NOT LIMITED TO LOSS OF DATA OR DATA BEING RENDERED INACCURATE OR LOSSES SUSTAINED BY YOU OR THIRD PARTIES OR A FAILURE OF THE LIBRARY TO OPERATE WITH ANY OTHER SOFTWARE), EVEN IF SUCH HOLDER OR OTHER PARTY HAS BEEN ADVISED OF THE POSSIBILITY OF SUCH DAMAGES.

END OF TERMS AND CONDITIONS

How to Apply These Terms to Your New Libraries

If you develop a new library, and you want it to be of the greatest possible use to the public, we recommend making it free software that everyone can redistribute and change. You can do so by permitting redistribution under these terms (or, alternatively, under the terms of the ordinary General Public License).

To apply these terms, attach the following notices to the library. It is

safest to attach them to the start of each source file to most effectively convey the exclusion of warranty; and each file should have at least the "copyright" line and a pointer to where the full notice is found.

<one line to give the library's name and a brief idea of what it does.>
Copyright (C) <year> <name of author>

This library is free software; you can redistribute it and/or modify it under the terms of the GNU Lesser General Public License as published by the Free Software Foundation; either version 2.1 of the License, or (at your option) any later version.

This library is distributed in the hope that it will be useful, but WITHOUT ANY WARRANTY; without even the implied warranty of MERCHANTABILITY or FITNESS FOR A PARTICULAR PURPOSE. See the GNU Lesser General Public License for more details.

You should have received a copy of the GNU Lesser General Public License along with this library; if not, write to the Free Software Foundation, Inc., 59 Temple Place, Suite 330, Boston, MA 02111-1307 USA

Also add information on how to contact you by electronic and paper mail.

You should also get your employer (if you work as a programmer) or your school, if any, to sign a "copyright disclaimer" for the library, if necessary. Here is a sample; alter the names:

Yoyodyne, Inc., hereby disclaims all copyright interest in the library `Frob' (a library for tweaking knobs) written by James Random Hacker.

<signature of Ty Coon>, 1 April 1990
Ty Coon, President of Vice

That's all there is to it!

This page is for your notes.

Manufacture:

NEC Infrontia Corporation

2-3, Kandatsukasa-cho, Chiyoda-ku, Tokyo 101-8532, Japan

Free Manuals Download Website

<http://myh66.com>

<http://usermanuals.us>

<http://www.somanuals.com>

<http://www.4manuals.cc>

<http://www.manual-lib.com>

<http://www.404manual.com>

<http://www.luxmanual.com>

<http://aubethermostatmanual.com>

Golf course search by state

<http://golfingnear.com>

Email search by domain

<http://emailbydomain.com>

Auto manuals search

<http://auto.somanuals.com>

TV manuals search

<http://tv.somanuals.com>