

# CP-132U Series User's Manual

---

Industrial 2-Port RS-422/485 Serial Board for Universal PCI Bus

[www.moxa.com/product](http://www.moxa.com/product)

Seventh Edition, June 2005



## **Moxa Technologies Co., Ltd.**

Tel: +886-2-8919-1230

Fax: +886-2-8919-1231

Web: [www.moxa.com](http://www.moxa.com)

### **MOXA Technical Support**

Worldwide: [support@moxa.com.tw](mailto:support@moxa.com.tw)

The Americas: [support@moxa.com](mailto:support@moxa.com)

# CP-132U Series User's Manual

The software described in this manual is furnished under a license agreement and may be used only in accordance with the terms of that agreement.

## Copyright Notice

Copyright © 2005 Moxa Technologies Co., Ltd.  
All rights reserved.  
Reproduction without permission is prohibited.

## Trademarks

MOXA is a registered trademark of The Moxa Group.  
All other trademarks or registered marks in this manual belong to their respective manufacturers.

## Disclaimer

Information in this document is subject to change without notice and does not represent a commitment on the part of Moxa.

Moxa provides this document “as is,” without warranty of any kind, either expressed or implied, including, but not limited to, its particular purpose. Moxa reserves the right to make improvements and/or changes to this manual, or to the products and/or the programs described in this manual, at any time.

Information provided in this manual is intended to be accurate and reliable. However, Moxa Technologies assumes no responsibility for its use, or for any infringements on the rights of third parties that may result from its use.

This product might include unintentional technical or typographical errors. Changes are periodically made to the information herein to correct such errors, and these changes are incorporated into new editions of the publication.

## **MOXA Internet Services**

Customer satisfaction is our number one concern, and to ensure that customers receive the full benefit of our products, Moxa Internet Services has been set up to provide technical support, driver updates, product information, and user's manual updates.

The following services are provided:

E-mail for technical support

Address.....[support@moxa.com.tw](mailto:support@moxa.com.tw)

World Wide Web (WWW) site for product information

Address.....<http://www.moxa.com>

# Table of Contents

<b>Chapter 1 Introduction</b> .....	<b>1-1</b>
Overview .....	1-2
Features .....	1-4
Package Checklist.....	1-4
<b>Chapter 2 Hardware Installation</b> .....	<b>2-1</b>
CP-132UL Series Block Diagram .....	2-2
Installing the CP-132UL Series Board .....	2-6
<b>Chapter 3 Software Installation</b> .....	<b>3-1</b>
Windows 2003.....	3-1
Installing the Driver .....	3-2
How to Check the Installation.....	3-6
Windows 2000/XP.....	3-10
Installing the Driver .....	3-10
How to Check the Installation.....	3-18
Removing the Driver.....	3-22
Windows 95/98.....	3-24
Installing the Driver .....	3-25
Windows NT .....	3-35
Installing the Driver .....	3-36
Configuring the Board and Ports.....	3-40
DOS.....	3-45
Installing the Driver .....	3-45
Setting up the Driver .....	3-47
Legends .....	3-48
Loading the Driver .....	3-49
Unloading the Driver.....	3-50
Linux .....	3-50
<b>Chapter 4 Serial Programming Tools</b> .....	<b>4-1</b>
RS-485 Programming.....	4-4
ADDC™ (Automatic Data Direction Control) .....	4-4
<b>Chapter 5 Connection Cables and Cable Wiring</b> .....	<b>5-1</b>
RS-422/485 Pinouts and Cable Wiring.....	5-2
RS-422 Interface .....	5-2
RS-485 Interface .....	5-2
Pinouts.....	5-3
Cable Wiring .....	5-5
Impedance Matching and Termination Resistors.....	5-7
<b>Chapter 6 Troubleshooting</b> .....	<b>6-1</b>

	General Troubleshooting .....	6-1
	Windows NT .....	6-3
	Windows 95/98 .....	6-4
<b>Appendix A</b>	<b>Technical Reference.....</b>	<b>A-1</b>
	Specifications.....	A-1
	PCI.....	A-2
	Return Procedure .....	A-3



# 1

## Introduction

---

Welcome to the MOXA CP-132UL Series of industrial 2-port RS-422/485 serial boards for the PCI bus. Moxa's Universal PCI CP-132UL series meets the new slot standard for expansion boards, and works with both 3.3V and 5V PCI slots. The CP-132UL series offers 2 independent RS-422/485 serial ports for connecting data acquisition equipment and many other serial devices to a PC and compatible systems. It provides a reliable communication link (RS-422/485) over a long distance (up to 4000 ft), and is suitable for industrial environments.

The following topics are covered in this chapter:

- ❑ **Overview**
- ❑ **Features**
- ❑ **Package Checklist**

---

## Overview

### Industio—The Industrial Multiport Async Solution

Moxa *Industio* products are smart, multiport serial I/O solutions for industrial applications. The **CP-132U Series boards**, including **CP-132UL V2**, and **CP-132UL-I V2 (the previous version is CP-132U-I V1)**, are designed for a 32-bit PCI bus with the **Plug and Play** and **Universal PCI** feature. They offer 2 independent RS-422/RS-485 serial ports for connecting data acquisition equipment and many other serial devices to the PC and its compatible systems. Industio products provide a reliable communication link over a longer distance (up to 4000 ft), and are suitable for industrial environments. Connections with **point-to-point full-duplex** or **multidrop half-duplex** are available to meet user's various needs. Each port can control up to 32 devices in a multidrop environment.

### ADDC™ (Automatic Data Direction Control) for RS-485

To make it easier to manage 2-wire RS-485 half-duplex connections, ADDC™ (Automatic Data Direction Control) intelligence is built into each CP-132UL series board, eliminating the need for software interference. This means that Windows applications can manage RS-485 ports, without the need to write extra code for controlling the half-duplex protocol.

With their well-designed and fine-tuned device driver, CP-132UL series boards make full use of the 128 byte Tx/Rx FIFO and on-chip H/W and S/W flow control, so that they can transfer data without loss even at speeds as high as 921.6 Kbps, providing a reliable, high performance solution for serial multiport communications.

### Termination Resistors Ready for RS-422/485

Termination Resistors are already installed on the CP-132UL series boards, eliminating the headaches involved in determining the proper impedance for the resistors. For more details, refer to the "Connection Cable and Cable Wiring" chapter.

### Surge/Isolation Protection

To prevent boards from being damaged by lightning or high potential voltage, CP132UL Series boards have built-in surge protection. An optical isolation option (2000V), and surge protection option (max. ESD of 16 KV, max. EFT of 2 KV) are also available in this series. Both of these features provide protection when the boards are used in critical or harsh factory-type environments.



### PCI Solution

The board complies with PCI Spec. 2.1 and does not require either switches or jumpers. The hardware configuration for the IRQ and I/O address is automatically assigned by the PCI BIOS. This means that the board **MUST** be plugged into the computer first before installing the driver software. For more PCI information, refer to the **Technical Reference Appendix**.

### Universal PCI

The 32/64-bit PCI local bus specification specifies both 3.3V and 5V connector types for the PCI hardware. Moxa's universal PCI card allows the user to plug into both a 3.3V/5V and 32/64-bit slot.

### Operating System Support

The CP-132UL series is compatible with most major industrial platforms, including Windows 2000/XP/2003, Windows NT, Windows 95/98/Me, DOS, and Linux. **MOXA device drivers** are provided for smoother installation, configuration, and performance. In this manual, sections for MOXA **Windows 2003, Windows 2000/XP, Windows NT, Windows 95/98, DOS, Linux, and SCO** are included.

### MOXA Serial Comm Tools

For application development, MOXA provides an easy-to-use serial communication library called **PComm** that runs under Windows NT/2000/XP/2003 and Windows 95/98. You can use this library to develop your own applications using Microsoft C, Turbo C, Assembly, QuickBASIC, Turbo Pascal, Clipper, Visual Basic, Visual C++, Borland Delphi, etc. Utilities, such as Data Scope, Monitor, Terminal Emulator, Diagnostics, etc., are included for debugging or monitoring the communication status, terminal emulation, or even file transfer.

### Broad Applications

The board is suitable for many industrial applications, including the following:

- Multipoint data acquisition
- Factory automation
- Critical industrial control
- Remote serial device control

---

## Features

The CP-132UL Series includes the following products:

CP-132UL V2	2 RS-422/485 ports, Universal PCI interface with embedded Surge Protection (16 KV ESD)
CP-132UL-I V2	2 RS-422/485 ports, Universal PCI interface with embedded Surge Protection and Isolation Protection (16 KV ESD, 2 KV Isolation)

CP-132UL Series boards have the following outstanding features:

- Supports 2 independent RS-422 or RS-485 serial ports
- Compact board size (half-size)
- DIP Switch for RS-422/RS-485 selection
- DIP Switch for selecting 2-wire or 4-wire RS-485
- Jumper for Termination Resistor selection—eliminates impedance matching headaches
- Reliability—high speed MOXA UART (16550C compatible) Communication Controllers with on-chip hardware and software flow control to guarantee no data loss
- PComm—a powerful serial Comm utility.
- Embedded Surge Protection (16 KV ESD) for all signal lines (CP-132UL V2, CP-132UL-I V2)
- Supports 128 byte FIFO
- Supports drivers for most major industrial platforms—Windows 2000/XP/2003, Windows NT, Windows 95/98/ME, DOS, and Linux
- Supports low profile bracket size (CP-132 UL V2 and CP-132UL-I V2)
- Supports both 3.3V and 5V connector types

## Package Checklist

The following items are included in the CP-132UL Series package:

- CP-132U Series 2-port serial board
- MOXA software CD-ROM, which includes:
  - Drivers for MOXA Multiport Async Products
  - User's Manual (PDF)

# 2

## Hardware Installation

---

You will need to install both hardware and software for CP-132UL Series boards. The hardware installation procedure is given in this chapter, and the next chapter deals with software installation for various operating systems. The following topics are covered in this chapter:

- ❑ **CP-132UL Series Block Diagram**
- ❑ **Installing the CP-132UL Series Board**

## CP-132UL Series Block Diagram

CP-132UL Series boards' hardware configuration for IRQ number and I/O address is automatically assigned by the PCI BIOS. This means that the board **MUST** be plugged in first before installing the driver software.

CP-132UL-I V2 (120 x 64.5 mm)

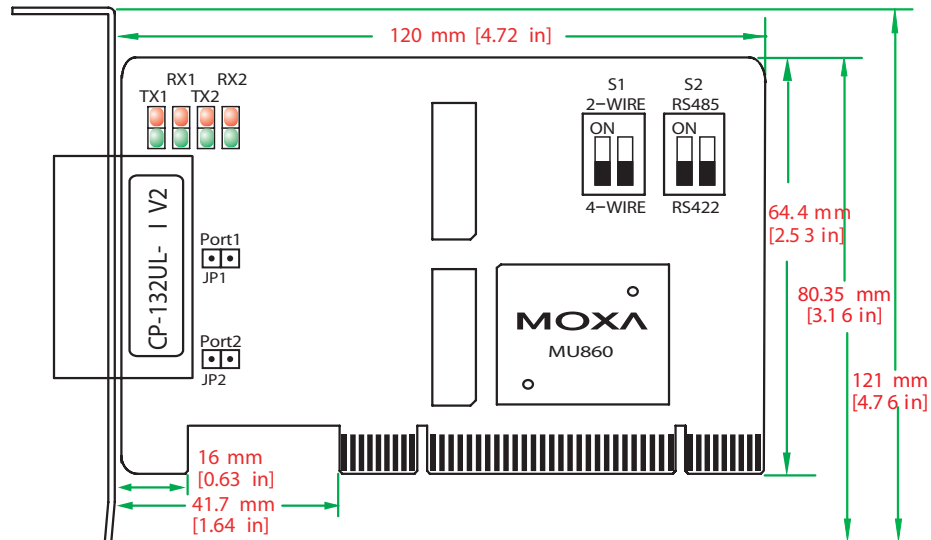

NOTE: Use JP1/2 to activate the Termination Resistors for ports 1/2.

**Open** Termination Resistor is NOT active

**Short** Termination Resistor is ACTIVE

## Hardware Installation

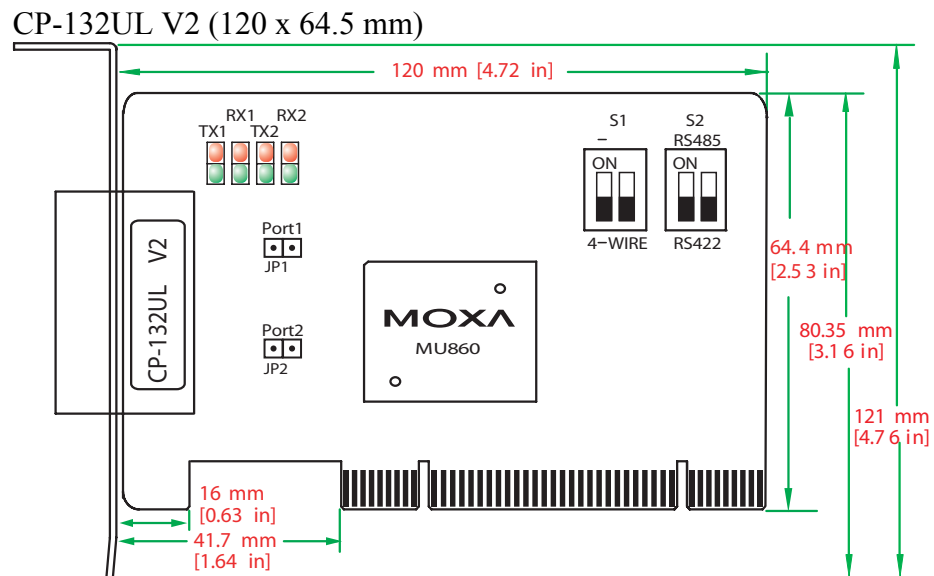
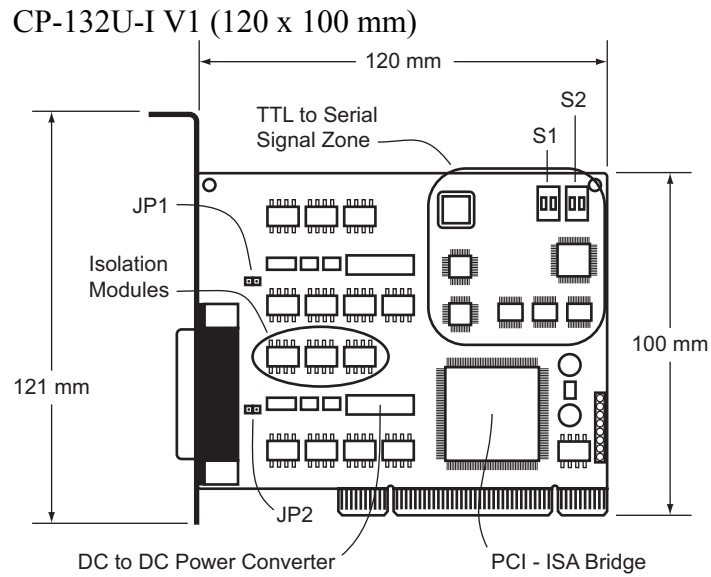

NOTE: Use JP1/2 to activate the Termination Resistors for ports 1/2.

- Open** Termination Resistor is NOT active
- Short** Termination Resistor is ACTIVE

---

### CP-132UL V1 (120 x 64.5 mm)

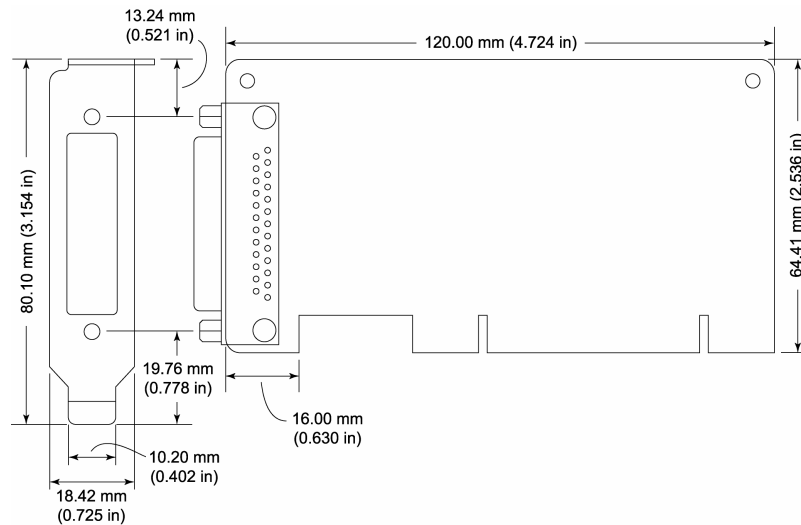

CP-132UL Series boards have four onboard DIP Switches, referred to below as S1-1, S1-2, S2-1, and S2-2, that allow the user to choose one of three serial interfaces—RS-422, RS-485 (2-wire), RS-485 (4-wire)—for each of the two ports. Note that S2-1 and S2-2 select between RS-422 and RS-485, and S1-1 and S1-2 select between 2-wire and 4-wire RS-485 (S1 is only active when S2 is set to ON).

The figures on the following page show you how to use the switches to select one of the three serial interfaces for each of the board's two ports.

## Hardware Installation

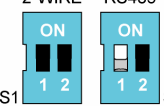
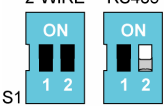
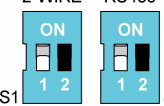
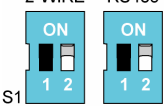
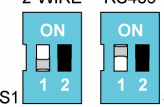
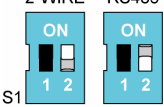
DIP Switch Settings	Port 1				Port 2			
	S1-1	S2-1			S1-2	S2-2		
RS-422	—	OFF	2-WIRE RS485  S1 1 2 S2 1 2 4-WIRE RS422	—	OFF	2-WIRE RS485  S1 1 2 S2 1 2 4-WIRE RS422		
RS-485 (2-wire)	ON	ON	2-WIRE RS485  S1 1 2 S2 1 2 4-WIRE RS422	ON	ON	2-WIRE RS485  S1 1 2 S2 1 2 4-WIRE RS422		
RS-485 (4-wire)	OFF	ON	2-WIRE RS485  S1 1 2 S2 1 2 4-WIRE RS422	OFF	ON	2-WIRE RS485  S1 1 2 S2 1 2 4-WIRE RS422		

---

## Installing the CP-132UL Series Board

**Step 1:** Power off the PC.



### **WARNING**

To avoid damaging your system and board, make sure your computer is turned off before installing any serial board.

**Step 2:** Remove the PC's cover.

**Step 3:** Remove the slot cover bracket if there is one.

**Step 4:** Plug the CP-132U Series control board firmly into a free 32-bit PCI slot or 64-bit PCI slot.

**Step 5:** Fasten the holding screw to fix the control board in place.

**Step 6:** Replace the system cover.

**Step 7:** Power on the PC. The BIOS will automatically set the IRQ and I/O address.

### **NOTE**

Moxa PCI and Universal PCI boards must be assigned unique IRQ and I/O addresses. Both addresses are assigned automatically by the PCI BIOS.

**Step 8:** Proceed with the software installation discussed in the next chapter, "Software Installation."



# 3

## Software Installation

---

In this chapter, the software driver installation, configuration, and driver update/removal procedures are described for various operating systems, including Windows NT, Windows 95/98, Windows 2000/XP/2003, DOS, FreeBSD, and Linux. Before proceeding with the software installation, complete the hardware installation, discussed in the previous chapter, “Hardware Installation.”

Refer to the next chapter, “Serial Programming Tools,” for information on developing your own serial programming applications.

Windows 2000/XP/2003, Windows NT, Windows 95/98, DOS, FreeBSD, and Linux drivers can be downloaded from the Moxa website.

### Windows 2003

This section includes information about how to install the driver for UPCI/PCI boards under Windows 2003. The drivers conform to the Win32 COMM API standard.

The Windows 2003 driver for MOXA’s multiport serial boards supports the following products:

- **Universal PCI Boards:** CP-168U, CP-104UL, CP-104JU, CP-134U, CP-134U-I, CP-132UL, CP-132UL-I V2(CP-132U-I V1)
- **PCI Boards:** C168H/PCI, C104H/PCI, C104HS/PCI, CP-114, CP-114I, CP-114S, CP-114IS, CP-132, CP-132I, CP-132S, CP-132IS
- **ISA Boards:** C168H, C168HS, C168P, C104H, C104HS, C104P, CI-104J, CI-104JS, CI-134, CI-134I, CI-134IS, CI-132, CI-132I, CI-132IS
- **cPCI Boards:** CT-114I

The following installation steps use CP-168U as an example.

---

## Installing the Driver

1. After installing the UPCI/PCI board and powering on your PC, Windows 2003 will auto detect and find the UPCI/PCI board you just added. The **Found New Hardware** window will open in the bottom right corner of the Windows desktop.



2. The **Welcome to the Found New Hardware Wizard** window will open automatically. **Select Install from a list or specific location (Advanced)**. Click on **Next** to continue.



3. Select **Search for the best driver in these locations**, check **Include this location in the search**, and then click on **Browse**. You should be able to locate the **\Software\Win2K-XP-2003** folder on the software CD. Click on **Next** to continue.

## Software Installation

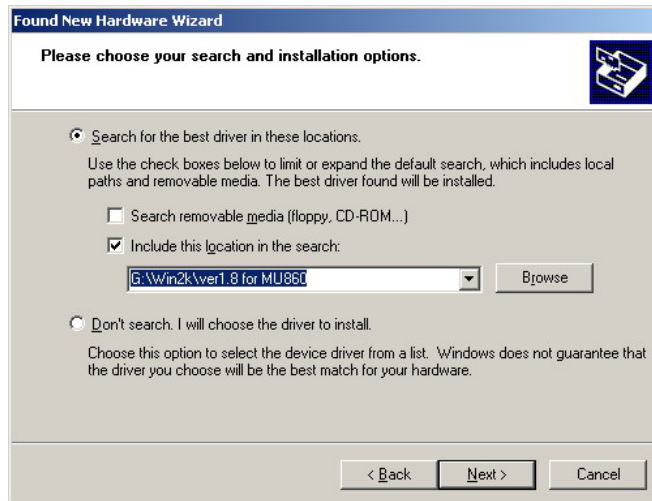

4. Wait while the installation wizard searches. The next window that opens cautions you that although this software hasn't passed Windows Logo testing, this driver has already been tested and been shown that it can support Windows OS. Click on **Continue Anyway** to proceed.



5. Wait while the driver software is installed. The next window shows the model number of the board, and indicates that Windows has completed the driver installation. Click on **Finish** to continue with the rest of the installation procedure.



6. The **Found New Hardware Wizard** window will open to help you install the driver for **MOXA Port 0**. Select **Install from a list or specific location (Advanced)**. Click on **Next** to continue.



7. Select **Search for the best driver in these locations**, check **Include this location in the search**, and then click on **Browse**. You should be able to locate the **\Software\Win2K-XP-2003** folder on the software CD. Click on **Next** to continue.

## Software Installation

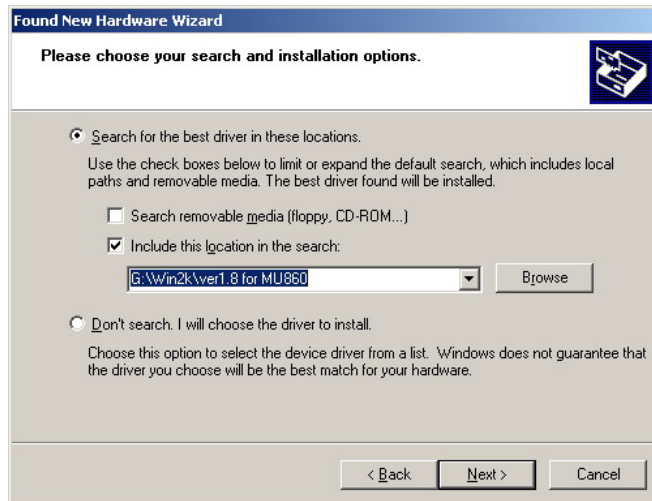

8. Wait while the installation wizard searches. The next window that opens cautions you that although this software hasn't passed Windows Logo testing, this driver has already been tested and been shown that it can support Windows OS. Click on **Continue Anyway** to proceed.

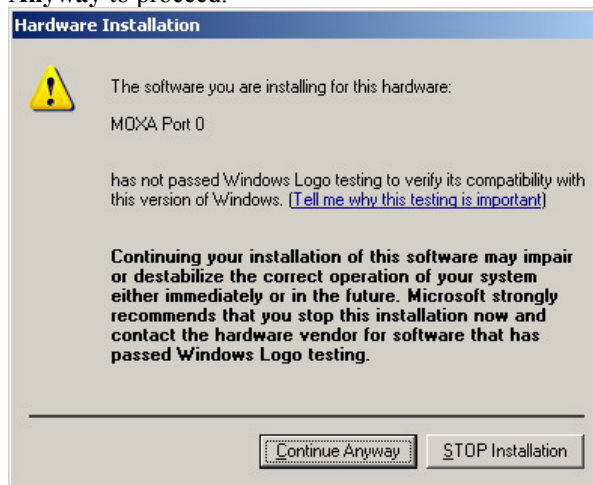

9. Wait while the port driver is being installed. Click on **Finish** to continue with the rest of the installation procedures.



10. Repeat steps 6 to 9, until the port driver installation for every port is completed.

## How to Check the Installation

There are three ways to check the installation of the CP-168U Series board.

### Using Device Manager

1. Use your mouse to position the cursor over your desktop's **My computer** icon, click the right mouse button, and then select **Properties**.
2. When the **System Properties** window opens, click on the **Hardware** tab, and then click on **Device Manager**.
3. When the **Device Manager** window opens, you will be able to see the model of **MOXA CP-168U Series** under **Multi-port serial adapters**, and **MOXA communication ports** under **Ports (COM & LPT)**.

## Software Installation

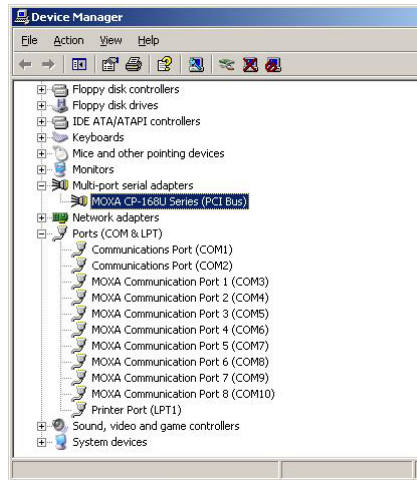

4. If there are any special marks, such as a question mark or an exclamation mark in front of the icons, the installation of the board or the ports was not successful. Examine the **Event Log** for details.

### Port Configuration

After the driver is installed, the MOXA CP-168U Installation dialog box will be displayed, and the system will map the ports automatically.

If one MOXA CP-168U board was installed previously, and another MOXA CP-168U board is added, the system will prompt you to take care of port configuration, which is discussed in this section.

1. Click on a specific port from the **CP-168U Series Installation** window, and then click on **[Port Setting]** to open the **Port X** dialog box.

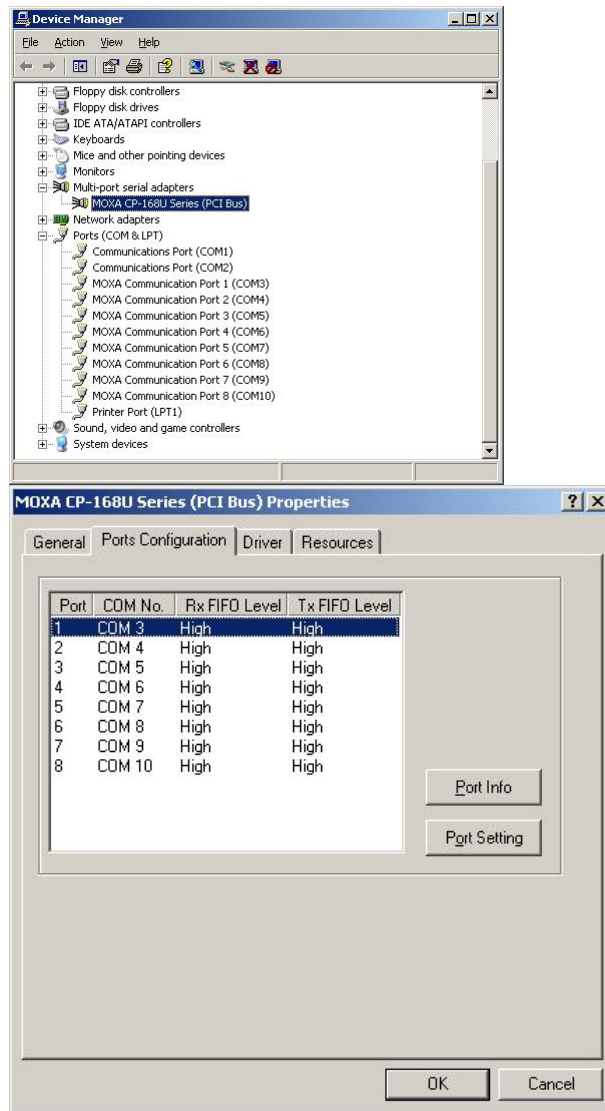

2. Select a COM number for the port from the **Port Number** pull-down list.
3. Check the **Auto Enumerating COM Number** check-box to have subsequent ports mapped to continuous COM numbers. For example, if COM 3 is assigned to Port 1, then COM 4 will be automatically assigned to Port 2.

### 3-8 CP-132U Series User's Manual



## Software Installation

4. Select an Rx FIFO Trigger from the Rx FIFO Level pull-down list. Rx FIFO trigger levels from High to Low are available, with the default set to High (120 bytes). Check **Set the change to all ports** check-box to apply the just defined Rx FIFO Trigger to all ports.
5. Select a Tx FIFO Size from the Tx FIFO Level pull-down list. Tx FIFO Levels from High to Low are available, with default value set to High (128 bytes). Check **Set the change to all ports** check-box to apply the just defined Tx FIFO Size to all ports.

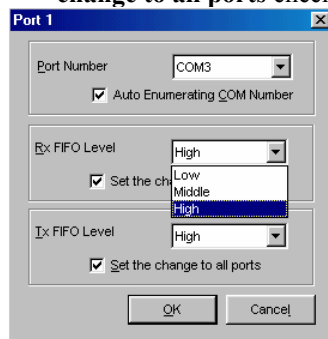

	CP-132UL V2/CP-132UL-I V2		CP-132UL/CP-132U-I	
	Tx FIFO	Rx FIFO	Tx FIFO	Rx FIFO
High	128	120	64	56
Middle	64	60	32	28
Low	1	1	1	1

Unit: Bytes

6. Click [OK] in the **Port X** dialog box to confirm the port settings, and then click [OK] in the **Property** dialog box to complete the port settings.

### Using PComm

The PComm Diagnostic program is a very useful tool for checking the status of MOXA's multiport boards. It provides internal and external testing of IRQ, TxD/RxD, UART, CTS/RTS, DTR/DSR, etc. This program can be used to make sure that MOXA's boards and ports are working properly.

To start this program, click on **Start → Programs → PComm Lite 2000 → PComm Diagnostic**.

NOTE: If you do not have the PComm software, you can download the free version of the software from Moxa's website at [www.moxa.com](http://www.moxa.com).

### Using Event Log

To use Event Log to check MOXA boards, click **Start → Settings → Control Panel →**

---

**Administrative Tools** → **Event Viewer** to enter the **Event Viewer** program. You can find the latest information relevant to MOXA's drivers under **System** category.

## Windows 2000/XP

Windows 2000/XP supports up to 256 serial ports, from COM1 to COM256. In order to utilize fully Windows 2000/XP's multi-process and multi-thread advanced features, pure 32-bit Windows 2000/XP device drivers were developed for MOXA multiport boards. The drivers conform to the Win32 COMM API standard.

The Windows 2000/XP driver for MOXA's multiport serial boards supports the following products:

- **Universal PCI Boards:** CP-168U, CP-104UL, CP-104JU, CP-134U, CP-134U-I, CP-132UL, CP-132UL-I V2(CP-132U-I V1)
- **PCI Boards:** C168H/PCI, C104H/PCI, C104HS/PCI, CP-114, CP-114I, CP-114S, CP-114IS, CP-132, CP-132I, CP-132S, CP-132IS
- **ISA Boards:** C168H, C168HS, C168P, C104H, C104HS, C104P, CI-104J, CI-104JS, CI-134, CI-134I, CI-134IS, CI-132, CI-132I, CI-132IS
- **cPCI Boards:** CT-114I

The following steps use CP-168U to illustrate the installation procedure.

### Installing the Driver

The following procedure shows how to install the CP-168U driver for the first time under Windows 2000 and Windows XP. First make sure the board or boards have already been plugged into the system's PCI or PCI-X slot(s).

## Software Installation

### Windows 2000

1. Windows 2000 can auto-detect new devices, and activate the Found New Hardware function to install a device driver for Plug and Play devices.



2. Click **Next** to continue.



3. Select **Search for a suitable driver...** and then click **Next** to continue.



### Windows XP

1. Windows XP can auto-detect new devices, and activate the Found New Hardware function to install a device driver for Plug and Play devices.



2. Select **Install from a list or specific location**. Click **Next** to continue.



4. Select **Specify a location** and then click **Next** to continue.

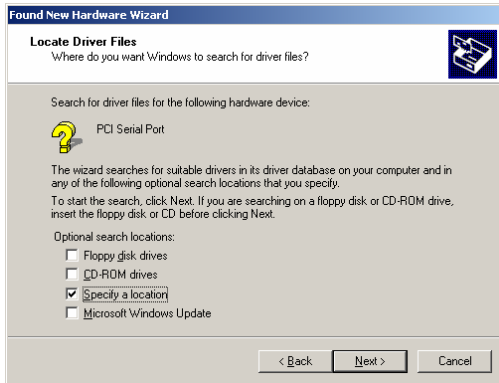

3. Checkmark **Include this location in the search**, click **Browse**, and then locate the **Software\Win2K-XP-2003** folder on the software CD. Click **Next** to continue.

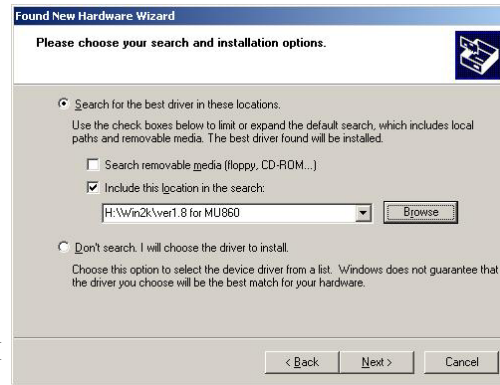

5. Insert the Moxa Driver CD into the CD-ROM drive, and then specify the location of the file as **Software\Win2K-XP-2003** as shown below (change the drive letter if needed). Click **OK** to continue.

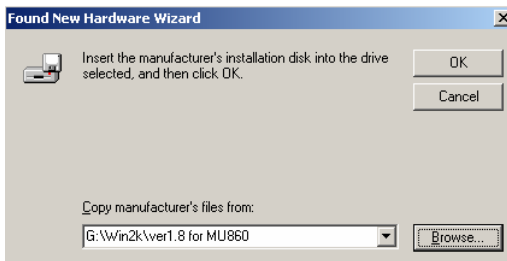

4. Wait while the driver software is installed.

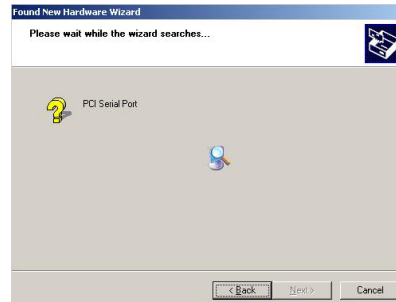

## Software Installation

- Click **Next** to copy the driver files to your system.

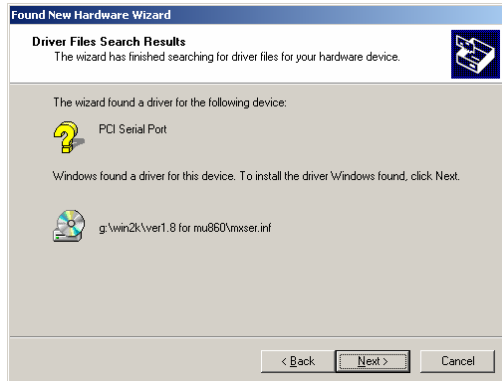

- Wait while the installation wizard searches. The next window that opens cautions you that although this software hasn't passed Windows Logo testing, this driver has already been tested and been shown that it can support Windows OS. Click **Continue Anyway** to proceed.

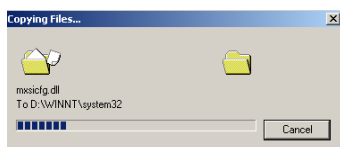
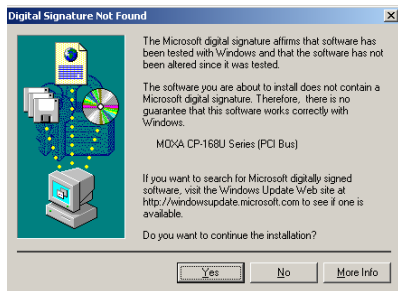

- Wait while the installation wizard searches. The next window that opens cautions you that although this software hasn't passed Windows Logo testing, this driver has already been tested and been shown that it can support Windows OS. Click **Continue Anyway** to proceed.

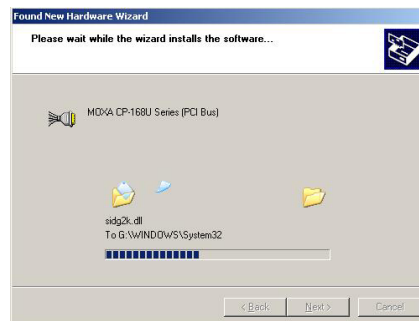

8. The next window shows the model number of the board, and indicates that Windows has completed the driver installation. Click **Finish** to continue with the rest of the installation procedure.

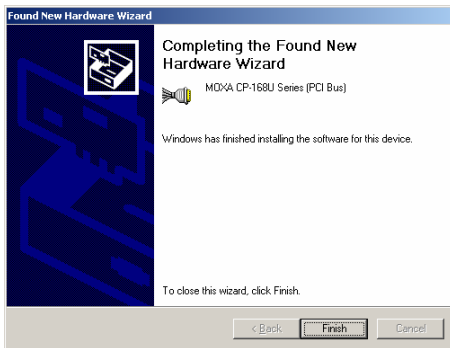

6. The next window shows the model number of the board, and indicates that Windows has completed the driver installation. Click **Finish** to continue with the rest of the installation procedure.

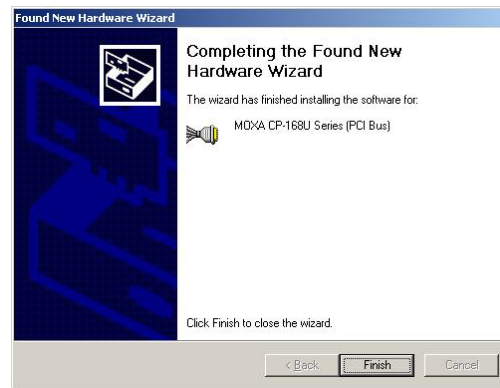

9. The next **Welcome to the Found New Hardware Wizard** window to open starts the port installation stage. Click on **Next** to continue.



7. The next **Welcome to the Found New Hardware Wizard** window that opens starts the port installation procedure. Select **Install the software from a specific location** and then click **Next** to continue.



## Software Installation

10. Select **Search for a suitable driver for my device [recommended]**, and then click **Next** to continue.



8. Input the location of the driver in the text input box, or use the **Browse** button to locate the appropriate folder.

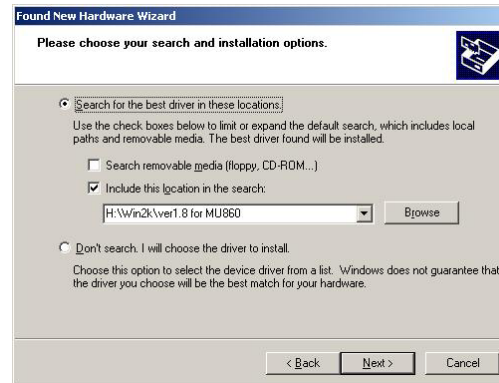

11. Select **Specify a location** and then click **Next** to continue.

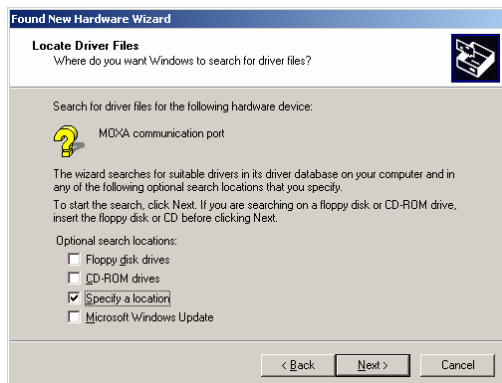

9. Wait while the installation wizard searches. The next window that opens cautions you that although this software hasn't passed Windows Logo testing, the driver has already been tested and been shown that it can support Windows OS. Click **Continue Anyway** to proceed.



12. Insert the Moxa Driver CD into the CD-ROM drive, and then specify the location of the file as **Software\Win2K-XP-2003** as shown below (change the drive letter, if needed). Click **OK** to continue.

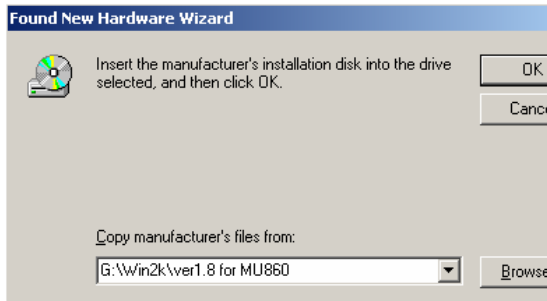

10. Wait while the installation wizard searches.

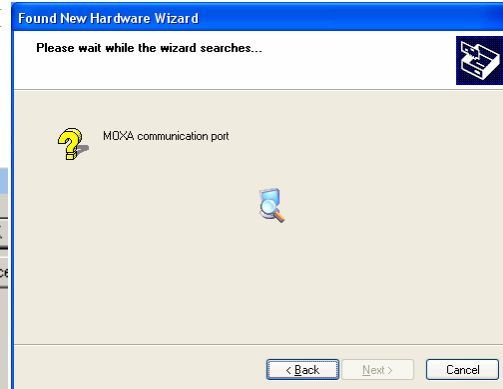

13. Click **Next** to continue with the installation.

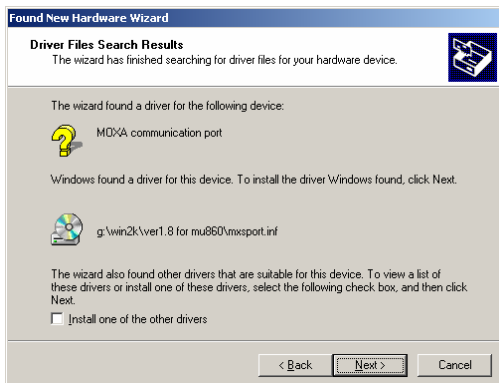

11. Wait while the wizard installs the software.

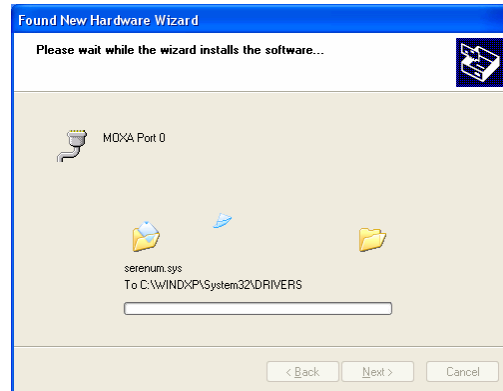



## Software Installation

14. After all files have been copied to the system, the **Completing the Found New Hardware Wizard** window will open to indicate that it has finished installing “Port 0.” Click **Finish** to install the board’s second port.



12. After all files have been copied to the system, the **Completing the Found New Hardware Wizard** window will open to indicate that it has finished installing “Port 0.” Click **Finish** to install the board’s second port.



15. Repeat the above procedure (Step 9 to Step 14) for the rest of the board’s ports. The last window to open completes installation of Port 7.

13. Repeat the above procedure (Step 7 to Step 12) for the rest of the board’s ports. The last window to open completes installation of Port 7.

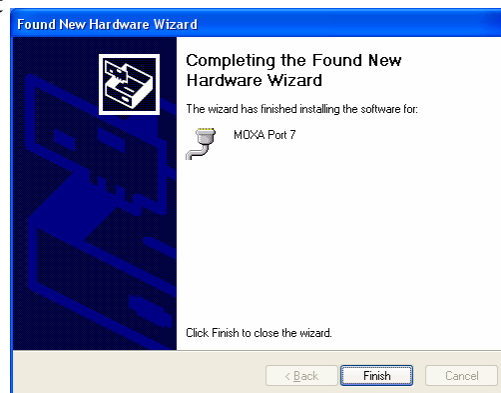

---

## How to Check the Installation

There are three ways to check the installation of the CP-168U Series board.

### Device Manager

1. You can check the installation of the board by selecting **Start → Settings → Control Panel → System**, to open the System Properties window. Select the **Hardware** tab, and then click on **Device Manager**.

#### Windows 2000

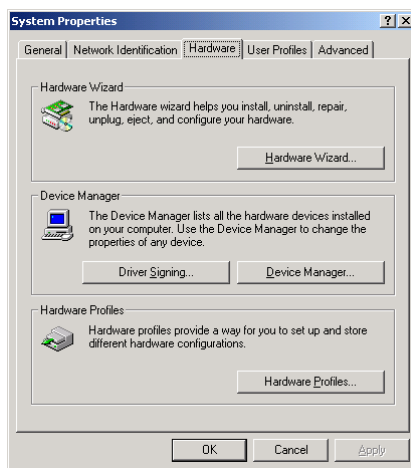

#### Windows XP

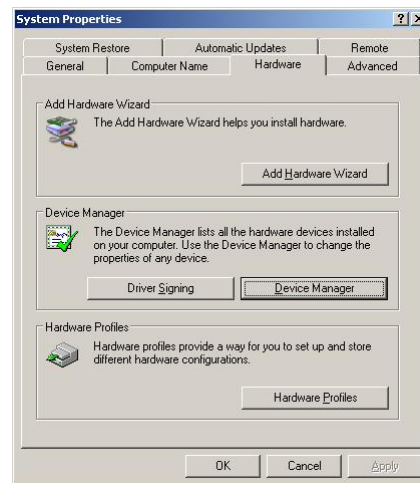

If the driver installation was successful, you will see the model number of the CP-168U board listed under **Multi-port serial adapters**.

You may also expand the **Ports (COM & LPT)** item to check the status of the COM ports. If you see a question mark on top of the icon, then the installation might have a problem. Check the Event Log to determine the reason for the problem.

## Software Installation

### Windows 2000

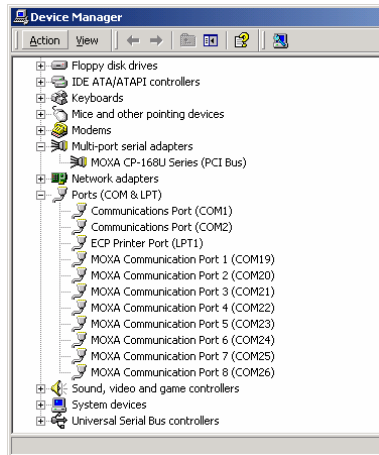

### Windows XP

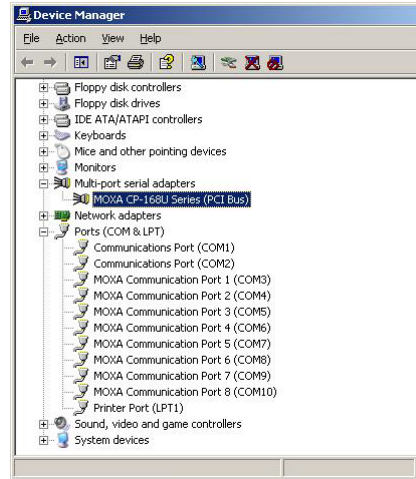

## Port Configuration

After the driver is installed, the MOXA CP-168U Installation dialog box will be displayed, and the system will map the ports automatically.

If one MOXA CP-168U board was installed previously, and another MOXA CP-168U board is added, the system will prompt you to take care of port configuration, which is discussed in this section.

1. Click on a specific port from the **CP-168U Series Installation** window, and then click [**Port Setting**] to open the **Port X** dialog box.

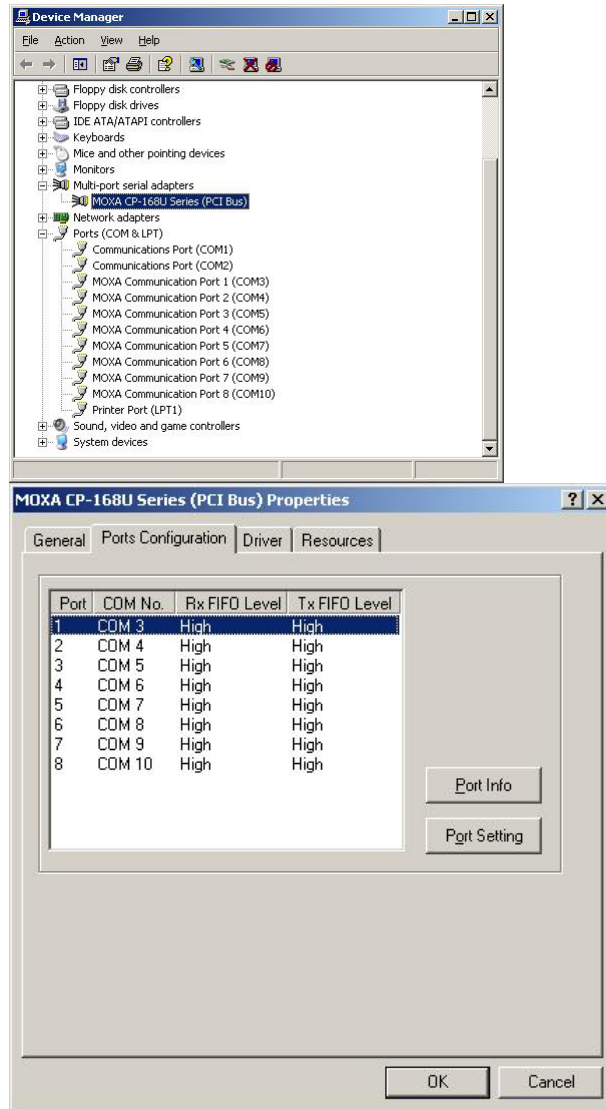

2. Select a COM number for the port from the **Port Number** pull-down list.
3. Check the **Auto Enumerating COM Number** check-box to have subsequent ports mapped to continuous COM numbers. For example, if COM 3 is assigned to Port 1, then COM 4 will be assigned automatically to Port 2.

### 3-20 CP-132U Series User's Manual

## Software Installation

4. Select an Rx FIFO Trigger from the Rx FIFO Level pull-down list. Rx FIFO trigger levels from High to Low are available, with the default value set to High (120 bytes). Check **Set the change to all ports** check-box to apply the just defined Rx FIFO Trigger to all ports.
  
5. Select a Tx FIFO Size from the Tx FIFO Level pull-down list. Tx FIFO Levels from High to Low are available, with the default value set to High (128 bytes). Check **Set the change to all ports** check-box to apply the just defined Tx FIFO Size to all ports.

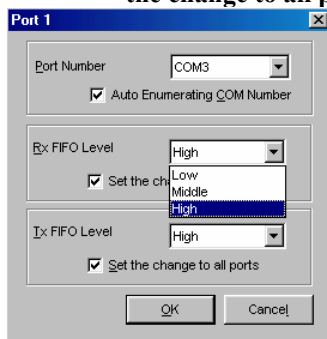

	CP-132UL V2/CP-132UL-I V2	CP-132UL/CP-132U-I		
	Tx FIFO	Rx FIFO	Tx FIFO	Rx FIFO
High	128	120	64	56
Middle	64	60	32	28
Low	1	1	1	1

Unit: Bytes

6. Click **OK** in the Port X dialog box to confirm the port settings, and then click **OK** in the Property dialog box to complete the port settings.

### MOXA PComm Utility

This utility, which comes with MOXA PComm Lite, provides a convenient way to diagnose Moxa board problems, and provides internal and external testing of IRQ, TxD/RxD, UART, CTS/RTS, DTR/DSR, etc. This program can verify the correct operation of both the H/W and S/W for all Moxa boards and ports.

### Event Log

To check the Event Log for MOXA boards, click **Start → Settings → Control Panel → Administrative Tools → Event Viewer**, to enter the Event Viewer program. The latest information relevant to the Moxa driver is under the system category.

---

## Removing the Driver

You can uninstall the board by first selecting **Start → Settings → Control Panel → System**.

### Windows 2000

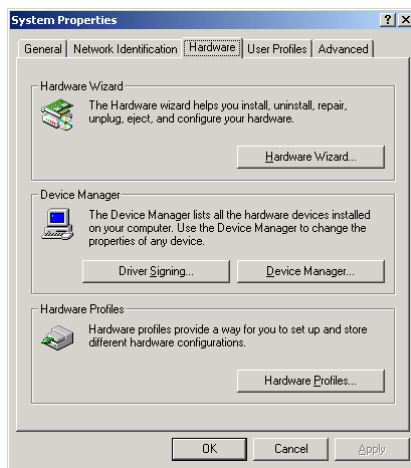

### Windows XP

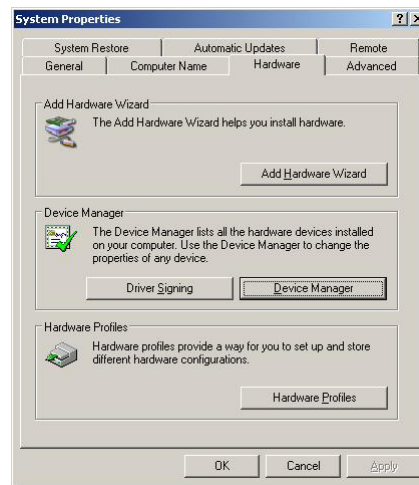

## Software Installation

Select the Hardware tab, and then click on Device Manager. Use the mouse to place the cursor over the CP-168U Series board under Multiport serial adapters, and then click the right mouse button. Select the **Uninstall...** option.

**Windows 2000**

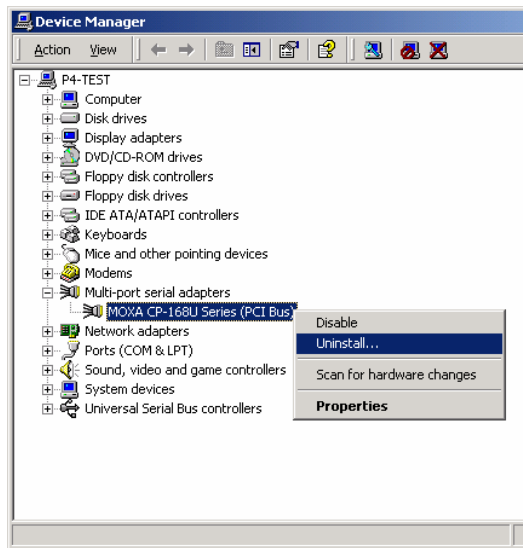

**Windows XP**

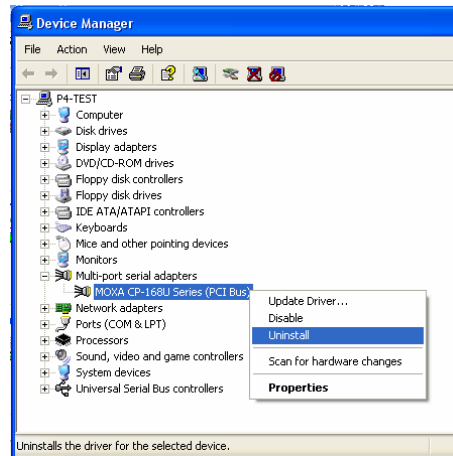

Click **OK** to proceed with the un-installation of the board.

**Windows 2000**



**Windows XP**

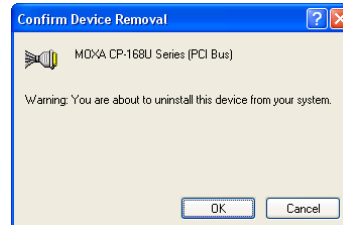

The **Device Manager** window will automatically refresh to show that the driver and ports for the CP-168U Series board have been removed.

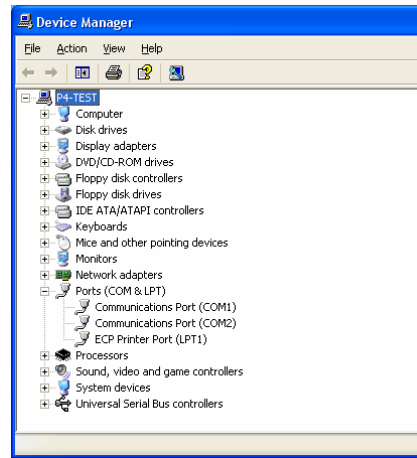
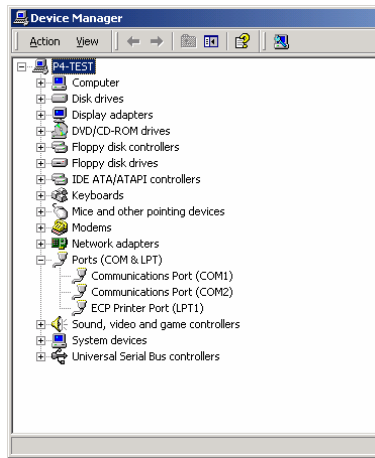

## Windows 95/98

The Windows 95/98 driver supports up to 128 serial ports, from COM1 to COM128. To utilize fully the advanced multi-process and multi-thread features of Windows 95/98, pure 32-bit Windows 95/98 virtual device port drivers (VxD) compliant with communication drivers (VCOMM) have been developed for the Smartio CP-168U and other MOXA multiport boards. The drivers conform to the Win32 COMM API standard.

The Windows 95/98 driver for MOXA's multiport serial boards supports the following products:

- **Universal PCI Boards:** CP-168U, CP-104UL, CP-104JU, CP-134U, CP-134U-I, CP-132UL, CP-132UL-I V2(CP-132U-I V1)
- **PCI Boards:** C168H/PCI, C104H/PCI, C104HS/PCI, CP-114, CP-114I, CP-114S, CP-114IS, CP-132, CP-132I, CP-132S, CP-132IS
- **ISA Boards:** C168H, C168HS, C168P, C104H, C104HS, C104P, CI-104J, CI-104JS, CI-134, CI-134I, CI-134IS, CI-132, CI-132I, CI-132IS
- **cPCI Boards:** CT-114I

The following steps use CP-168U to illustrate the installation procedure.



### Installing the Driver

Thanks to Windows 95/98's Plug and Play capability, you can easily plug the Smartio CP-168U board into an available PCI slot, and then get to work right away with very little installation effort. Windows 95/98 will automatically detect the presence of the new board, and prompt you to install the software driver. You simply need to have the driver CD on hand to complete the installation process.

A maximum of 4 Smartio CP-168U boards can be installed in one system, provided sufficient I/O address and IRQ number resources are available.

The following flow chart illustrates the driver installation stages of the Smartio CP-168U boards. Each stage will be discussed later in more detail.

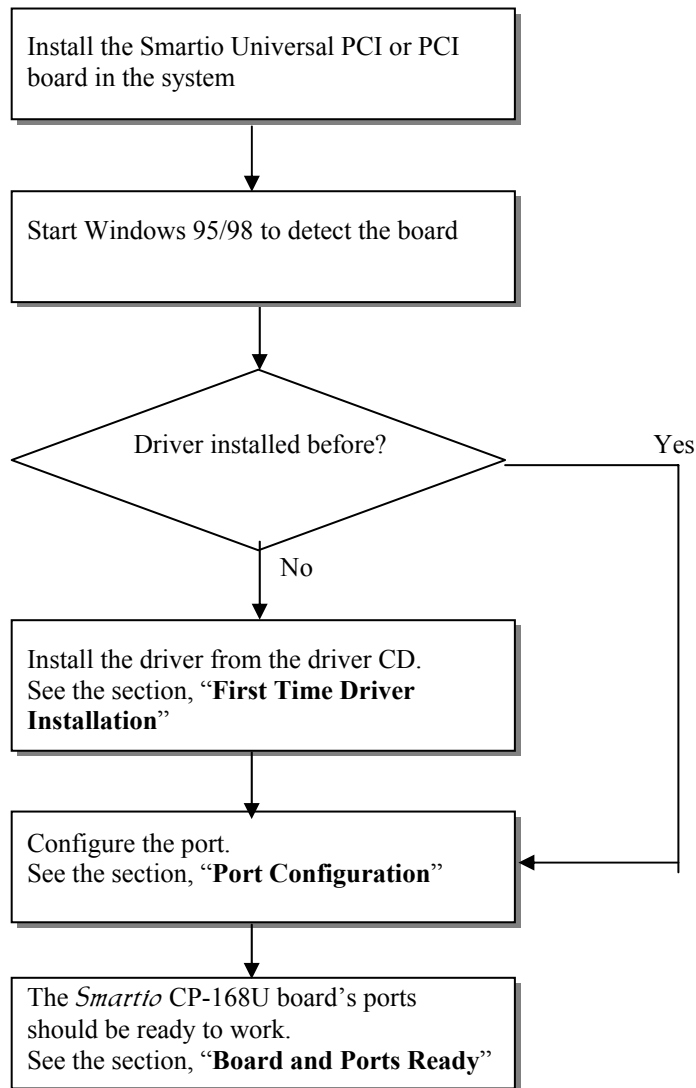

### First Time Driver Installation

This stage gives the steps for installing the Smartio CP-168U board driver for the first time. The installation of the Smartio CP-168U board for Windows 95 and Windows 98 are slightly different and will be described in two columns. Follow the steps in the left column for Windows 95 or the right column for Windows 98.

## Software Installation

If one MOXA CP-168U board was previously installed and another MOXA CP-168U board is plugged in, the system will prompt you to skip this stage, and take care of Port Configuration, which is discussed in the next section.

1. Upon detecting the first new *Smartio* CP-168U Series board, Windows 95/98 will automatically display a **New hardware found** message box, and then display the following dialog boxes. Click the **Next** button to proceed.

### Windows 95



2. Click [**Other Locations**].

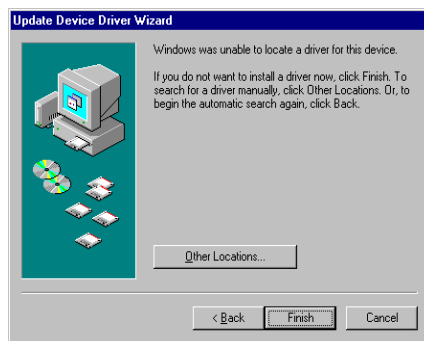

### Windows 98



2. Select [**Display a list...**] and then click [**Next**].



3. Type **\Software\Win9x\Windows** in the **Location** input box, and then click **[OK]** from the **Select Other Location** window. The system will start reading the files from the CD.

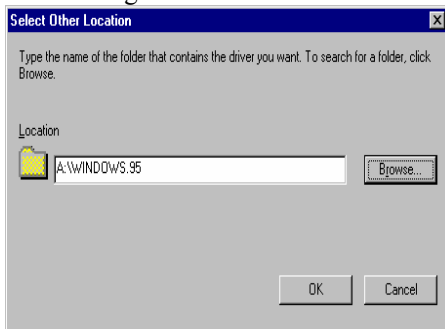

4. Click **[Finish]**.



3. Select **Other Devices** and then click **[Next]**.

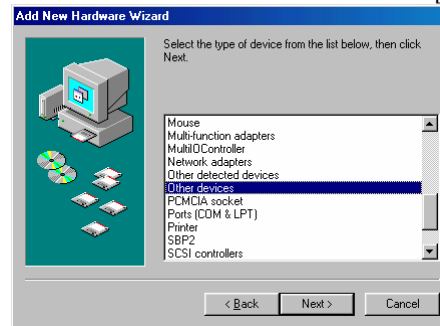

4. Click **[Have Disk]**.

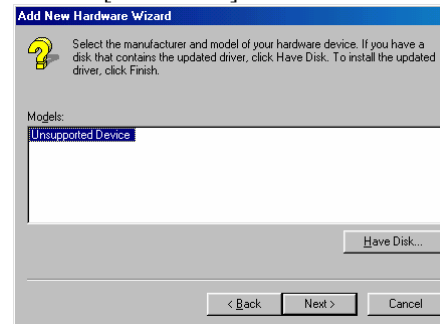

5. Type **\Software\Win9x\Windows** and click **[OK]**. The system will start reading the files from the CD.



## Software Installation

---

### Board and Port Ready

The final stage of the driver installation process is slightly different for Windows 95 and Windows 98. After this stage, driver installation is complete.

#### Windows 95

After port configuration, you can immediately use the COM ports of the *Smartio* CP-168U board without restarting Windows 95.

#### Windows 98

After port configuration, click [**Finish**]. The COM ports of the *Smartio* CP-168U board can be used without restarting Windows 98.



---

#### NOTE

If an error message similar to “CP-168U board(BusNo=x, DevNo=x, Port1=COMx) interrupt number is invalid!” pops up, refer to the “Troubleshooting” chapter for solutions.

---

If you want to add more boards after installing the driver, simply plug the additional *Smartio* CP-168U board into an empty PCI slot, and Windows 95/98 will automatically detect the new board. Skip to the **Port Configuration** to take care of port settings.

This completes the installation of the *Smartio* CP-168U board driver, including board and port configuration. However, if you need to make changes to the board and port configuration, refer to the next section, “Configuring Board and Port,” for configuration details.

Once the board and the driver are installed and the driver restarts successfully, you can start developing applications with the *PComm* library (see “Serial Programming Tools”) or the Microsoft Win32 API. You can also use applications such as Terminal Emulator (see “Serial Programming Tools”), a *PComm* utility, or HyperTerminal, to transmit/receive data, as well as Remote Access Service to provide dial-up networking capabilities.

---

## Configuring the Board and Ports

Follow the procedures given below to re-configure the COM number for the ports of installed boards and drivers under Windows 95/98.

In addition to following the procedures listed below, you may also click on **[Start] → [Programs] → [MOXA Utility] → [MOXA Smartio/Industio Configuration Panel] → [Property] → [Port Setting]**.

Since this is a Universal PCI or PCI board, once a new board is added, or an existing board is removed, the board's configuration will be automatically added or removed by the operating system when you restart the PC.

1. Open the **[Control Panel]**, click on the **[System]** icon, select the **[Device Manager]** tab, and then click on the plus sign to the left of **Moxa Smartio/Industio multiport board**.

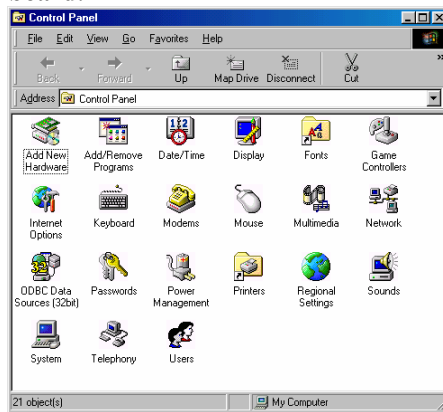

## Software Installation

2. Click on the desired CP-168U board, and then click on **[Properties]**.

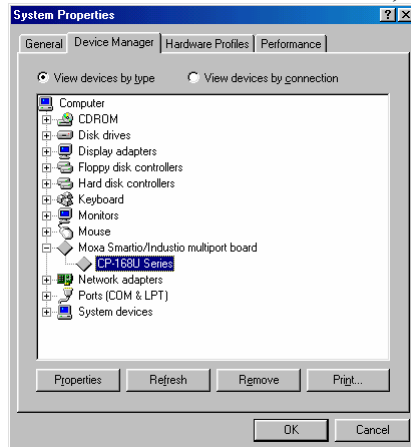

3. Select the **[Ports Configuration]** tab, click on the specific port, and then click on the **[Port Setting]** button.

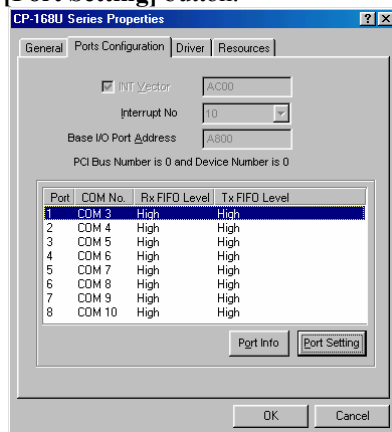

4. Check the **Auto Enumerating COM Name** check-box to assign continuous COM numbers for subsequent ports. For example, if COM3 is assigned to Port 1, then COM4 will be automatically assigned to Port 2.
5. Select an Rx FIFO Trigger from the Rx FIFO Level pull-down list. Rx FIFO trigger levels from High to Low are available, with the default set to High (120 bytes). Check the **Set the change to all ports** check-box to apply the just defined Rx FIFO Trigger to

all ports.

6. Select a Tx FIFO Size from the Tx FIFO Level pull-down list. Tx FIFO Levels from High to Low are available, with the default set to High (128 bytes). Check **Set the change to all ports** check-box to apply the just defined Tx FIFO Size to all ports.

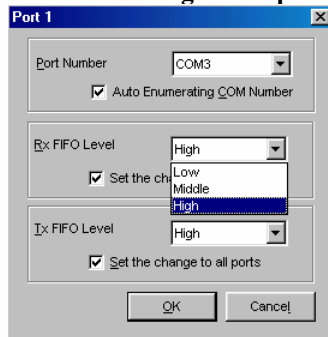

	CP-132UL V2/CP-132UL-I V2	CP-132UL/CP-132U-I		
	Tx FIFO	Rx FIFO	Tx FIFO	Rx FIFO
High	128	120	64	56
Middle	64	60	32	28
Low	1	1	1	1

Unit: Bytes

7. To complete the update, click [OK] in the **Port X** dialog box, click [OK] in the **CP-168U board Properties** dialog box, and then click [OK] on the **Device Manager** tab.
8. Restart the system to activate the latest configuration.

## Updating the Driver

This section explains how to update the Windows 95/98 driver.

1. Open [Control Panel], click on the [System] icon, and select the [Device Manager] tab.
2. Click on the **MOXA CP-168U board** and then click on [Properties].



## Software Installation

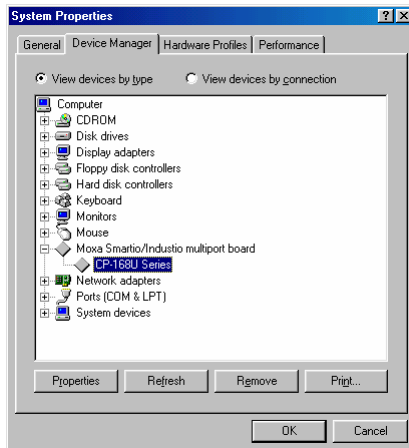

3. Select the **[Driver]** tab, and click on **[Update Driver...]**.

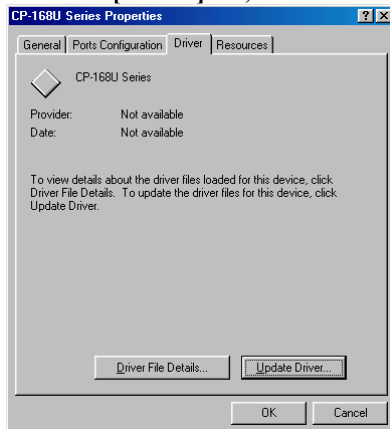

4. Click on **[Have Disk...]** and type the path of the new driver.

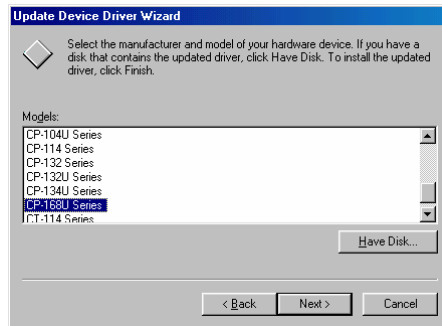

5. Insert the driver CD into the CD-ROM drive, and then click **[OK]** in the Install from Disk window.
6. The system will automatically prompt you to restart the system. Click **[Yes]** to restart the system, or **[No]** if you want to reboot the system later.

## Removing the Driver

This section explains how to remove the Smartio CP-168U board driver.

1. Open the **[Control Panel]**, double click the **[Add/Remove Programs]** icon, and then select the **[Install/Uninstall]** tab.
2. Click on the **MOXA Smartio/Industio Driver** option and then click on **[Add/Remove]** to start the driver removal process.

## Software Installation

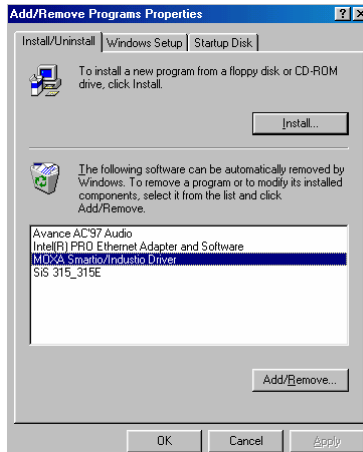

3. Click **[Yes]** in the following message box to confirm that you want to remove the driver.

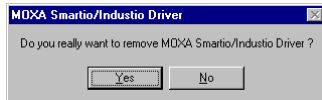

4. Click **[OK]** in the Add/Remove Programs Properties dialog box.



## Windows NT

Windows NT supports up to 256 serial ports, from COM1 to COM256. To utilize fully Windows NT's multi-process and multi-thread advanced features, pure 32-bit Windows NT device drivers were developed for the Smartio CP-168U board and other MOXA multiport boards. The drivers conform to the Win32 COMM API standard.

The Windows NT driver for MOXA's multiport serial boards supports the following products:

- 
- **Universal PCI Boards:** CP-168U, CP-104UL, CP-104JU, CP-134U, CP-134U-I, CP-132UL, CP-132UL-I V2(CP-132U-I V1)
  - **PCI Boards:** C168H/PCI, C104H/PCI, C104HS/PCI, CP-114, CP-114I, CP-114S, CP-114IS, CP-132, CP-132I, CP-132S, CP-132IS
  - **ISA Boards:** C168H, C168HS, C168P, C104H, C104HS, C104P, CI-104J, CI-104JS, CI-134, CI-134I, CI-134IS, CI-132, CI-132I, CI-132IS
  - **cPCI Boards:** CT-114I

The following steps use CP-168U to illustrate the installation procedure.

## Installing the Driver

### First Time Driver Installation

The following procedure shows how to install the Smartio CP-168U driver for the first time. First make sure the board or boards are already plugged into the system's PCI slot(s).

1. Log into NT as Administrator.
2. Copy the folder **Windows.nt** located under **\Software\WinNT** on the software CD, to your computer's hard disk (under the C: drive, for example).
3. Open the **[Control Panel]**, click the **[Network]** icon, and then select the **[Adapters]** tab.
4. Click the **[Add]** button, and then the **[Have Disk...]** button in the **[Select Network Adapter]** dialog box.
5. Specify the exact path of the driver diskette, C:\Windows.nt in the example shown here, and then click **[OK]** to proceed.

## Software Installation

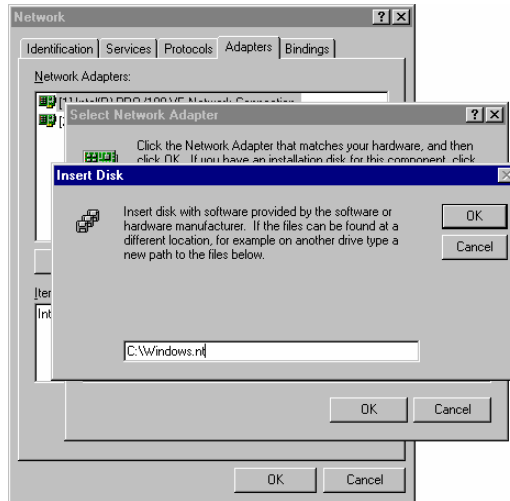

6. Select **MOXA Smartio/Industio Family multiport board** in the **Select OEM Option** dialog box, and then click **[OK]** to start installing the driver.

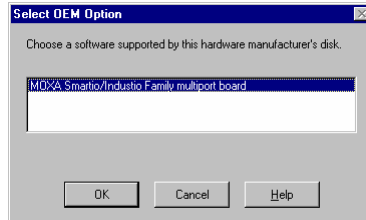

7. The **Moxa Smartio/Industio Configuration Panel** dialog box appears. Click the **[Add]** button to open the **Property** dialog box to change port settings and advanced FIFO configuration done automatically by the system.

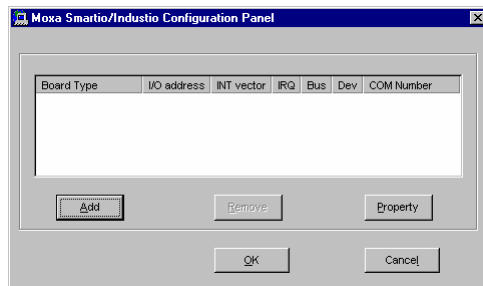

8. Select the just installed CP-168U board from the **Board Type** pull-down list, click on a specific port item, and then click on the **[Port Setting]** button to open the **Port X** window.

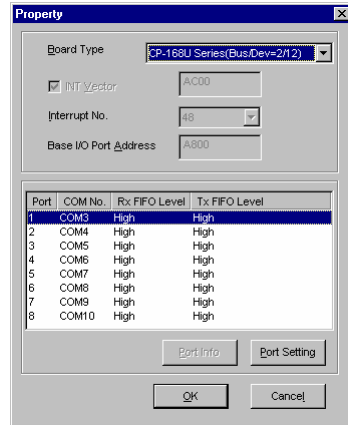

9. Select a COM number for the specific port from **Port Number** pull-down list.
10. Check the **Auto Enumerating COM Number** check-box to map subsequent ports to continuous COM numbers. For example, if COM3 is assigned to Port 1, then COM4 will be automatically assigned to Port 2.
11. Select an Rx FIFO Trigger from the Rx FIFO Level pull-down list. Rx FIFO trigger levels from High to Low are available, with the default set to High (120 bytes). Check **Set the change to all ports** check-box to apply the just defined Rx FIFO Trigger to all ports.
12. Select a Tx FIFO Size from the Tx FIFO Level pull-down list. Tx FIFO Levels from High to Low are available, with the default set to High (128 bytes). Check **Set the change to all ports** check-box to apply the just defined Tx FIFO Size to all ports.

## Software Installation

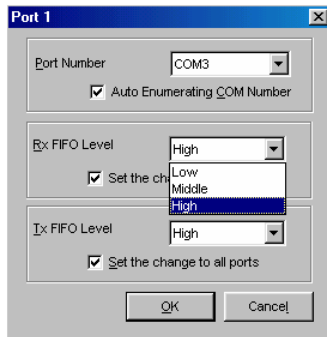

	CP-132UL V2/CP-132UL-I V2	CP-132UL/CP-132U-I		
	Tx FIFO	Rx FIFO	Tx FIFO	Rx FIFO
High	128	120	64	56
Middle	64	60	32	28
Low	1	1	1	1

Unit: Bytes

- Click **OK** in the Port X dialog box to confirm the port settings, and then click **OK** in the **Property** dialog box to complete the port settings and return to the **MOXA Smartio/Industio Configuration Panel** dialog box. The configured CP-168U board will now appear in the MOXA Smartio/Industio Configuration Panel dialog box, as shown below.

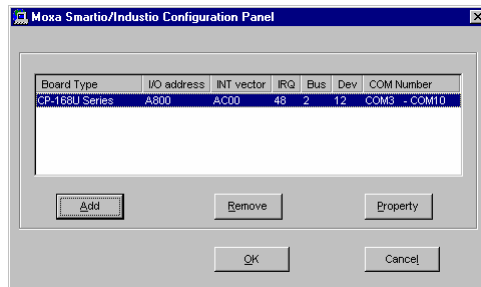

- Click **OK** in the **MOXA Smartio/Industio Configuration Panel** to return to the Network dialog box, and then click **OK** to exit the Network dialog box.
- Restart the PC.

**NOTE** The driver configuration will NOT take effect until you restart the PC.

---

---

NOTE Double check that all *Smartio* CP-168U board components—including the control board—are connected and fastened tightly to ensure that the system and driver can start up.

---

Once the system restarts, you may check the event log issued by the MOXA driver to see if the board's ports have been initialized successfully.

Enter the [Administrative] group, click the [Event Viewer] icon, and then select [Log] and [System] to check a message similar to “**MOXA CP-168U board, with first serial port COM3, has been enabled**” for each newly configured board.

---

NOTE **If an error message similar to “Cannot find any configured MOXA Smartio/Industio series board!” pops up, refer to the Troubleshooting chapter for possible solutions.**

---

Once the board and the driver are installed and the driver restarts successfully, you can begin to develop applications with the *PComm* library (see “**Serial Programming Tools**”) or the Microsoft Win32 API. You can also use applications such as Terminal Emulator (see “**Serial Programming Tools**”), a *PComm* utility, or HyperTerminal, to transmit/receive data, as well as Remote Access Service to provide dial-up networking capabilities.

## Configuring the Board and Ports

### Re-Configuring Port Settings

If the driver is already installed, and you only wish to re-configure the ports, refer to the following procedures. In addition to the procedures listed below, you may also click on [Start] → [Programs] → [MOXA Utility] → [MOXA Smartio/Industio Configuration Panel] → [Property], and then refer to the instructions in the previous section, “**First Time Driver Installation.**”

1. Open the [Control Panel], click on the [Network] icon, and select the [Adapters] tab.
2. Click on MOXA Smartio/Industio Family Adapter from the Network Adapters list to highlight it, and then click on [Properties] to open the **MOXA Smartio/Industio Configuration Panel** dialog box to change port settings and advanced FIFO configuration.



## Software Installation

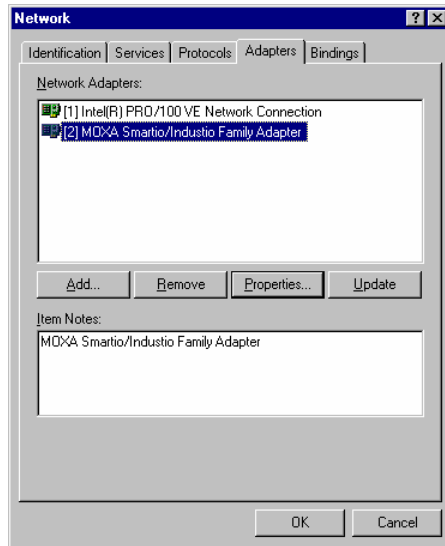

3. Click on **[Property]** from the **MOXA Smartio/Industio Configuration Panel** to open the Property window.

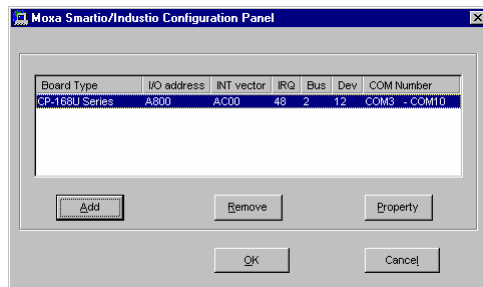

4. Next, refer to the instructions given in the previous section, “**First Time Driver Installation**” from the “**Windows NT**” section.

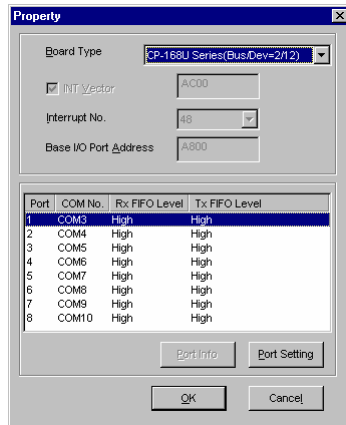

## Configuring Another CP-168U Board

In this section, we explain how to configure another MOXA CP-168U board that is already installed. Up to four CP-168U boards can be installed in one system under Windows NT, provided sufficient system resources are available.

In addition to the procedures listed below, you may also click on [Start] → [Program] → [MOXA Utility] → [MOXA Smartio/Industio Configuration Panel] → [Add], and then refer to the instructions from the previous section, “Installing the Driver.”

1. Open the [Control Panel], click on the [Network] icon, and select the [Adapters] tab.
2. Click on **MOXA Smartio/Industio Family Adapter** from the **Network Adapters** list.
3. Click the [Properties] button to open the Moxa Smartio/Industio Configuration Panel dialog box.

## Software Installation

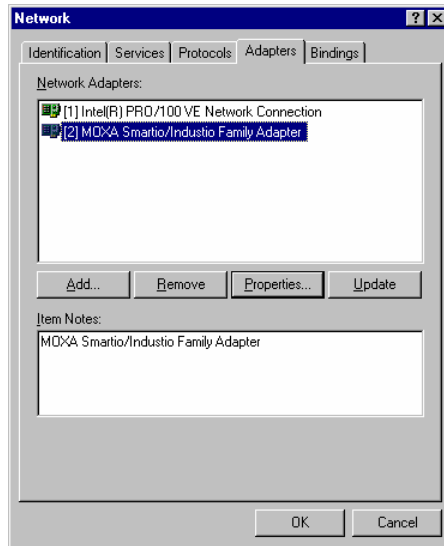

4. Next, refer to the instructions from the “**First Time Driver Installation**” subsection.

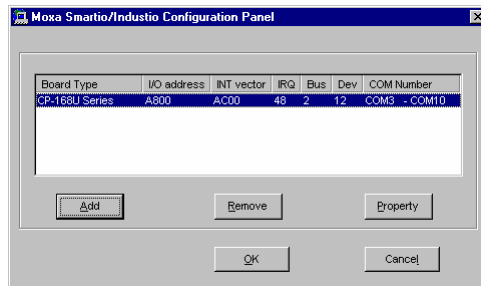

### Removing an Existing CP-168U Board Configuration

First shut down your PC, and then physically remove the CP-168U board from the PCI or PCI-X slot. The next time you start up the PC, the system will automatically remove the configuration. There is no need to click the Remove button in the Moxa Smartio/Industio Configuration Panel dialog box.

---

## Updating the Driver

Take the following steps to update the Smartio CP-168U board driver.

1. Open [Control Panel], click on the [Network] icon, and select the [Adapters] tab.
2. Click on MOXA Smartio/Industio Family Adapter from the Network Adapter list.
3. Click the [Remove] button in the Network dialog box.
4. Click the [Close] button in the Network dialog box.
5. Restart the system.
6. Refer to the instructions given in the “First Time Driver Installation” section to install the new driver.

## Removing the Driver

To remove the Smartio CP-168U board driver:

1. Open the [Control Panel], click on the [Network] icon, and select the [Adapters] tab.
2. Click on MOXA Smartio/Industio Family Adapter from the Network Adapters list.
3. Click the [Remove] button in the Network dialog box.

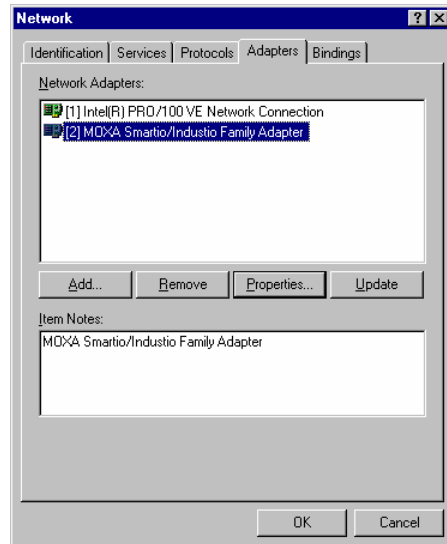

4. Click the **[Close]** button to exit the **Network** dialog box.
5. Restart the system to activate the new configuration.

## DOS

MOXA DOS API-232 is a software package that assists users in developing new programs, or debugging existing programs for serial communications. This section explains how to install the package, how to set up the driver, and how to load or unload the driver.

The DOS driver for MOXA's multiport serial boards supports the following products:

- **Universal PCI Boards:** CP-168U, CP-104UL, CP-104JU, CP-134U, CP-134U-I, CP-132UL, CP-132UL-I V2(CP-132U-I V1)
- **PCI Boards:** C168H/PCI, C104H/PCI, C104HS/PCI, CP-114, CP-114I, CP-114S, CP-114IS, CP-132, CP-132I, CP-132S, CP-132IS
- **ISA Boards:** C168H, C168HS, C168P, C104H, C104HS, C104P, CI-104J, CI-104JS, CI-134, CI-134I, CI-134IS, CI-132, CI-132I, CI-132IS
- **cPCI Boards:** CT-114I

The following Steps are use CP-134U to illustrate the installation procedure.

## Installing the Driver

1. Run the installation program, **DOSINST.EXE** under \Software\DOS on the software CD. Specify the target API-232 directory (e.g. **C:\MOXA**) where the software driver will be copied. Press **F2** to start the installation.



2. After the installation is complete, a message window will open to ask if you want to run the **SETUP.EXE** file. It is strongly recommended that you press **Y** to run this **SETUP.EXE** file.



### Setting up the Driver

The following steps use CP-134U to illustrate. This section does not cover all functions from the setup program that you might see during the configuration process. If necessary, press **F1** to refer to the on-line help instructions.

1. Run the **BIN\SETUP.EXE** file.
2. Press **Enter** to select the proper model name (CP-134U Series for this example).

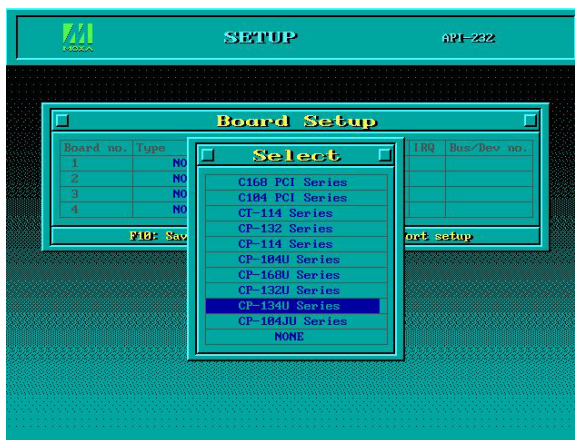

- Press **PgDn** to configure the port settings, including port number, flow control, etc. You may enter or modify the settings of each port at this stage. The values displayed first are the port's initial values that were set up when installing the driver.

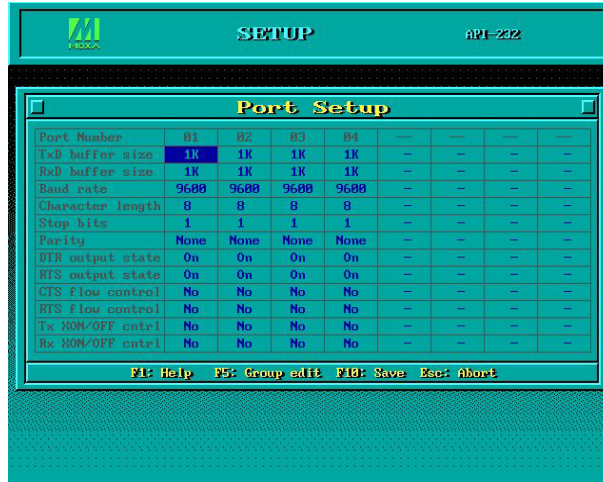

**NOTE** Up to this point, you have completed the configuration of CP-134U. You may skip this step and go directly to step 4 if you do not need to change settings or configure a board.

- Press **F10** to save the modifications and exit the SETUP program.

## Legends

In this section we explain the meaning of some of the fields and functions.

### Port number

This is the port ID of the port. Application software uses port number (ID) when referring to a port. Consequently, port numbers must be unique.

Port numbers can be set to any number between 0 and 255 (inclusive). However, you must ensure that each port is assigned a unique port number. If you are developing your own application software, then you may want to select port numbers that take into consideration



the structure of the program.

### TxD buffer size

The TxD buffer is the transmission (output) buffer allocated by the system for each port.

### RxD buffer size

The RxD buffer is the receiving (input) buffer allocated by the system for each port.

### F5 Group Edit

This is a convenient function that allows you to edit the configuration of several ports at one time as a group.

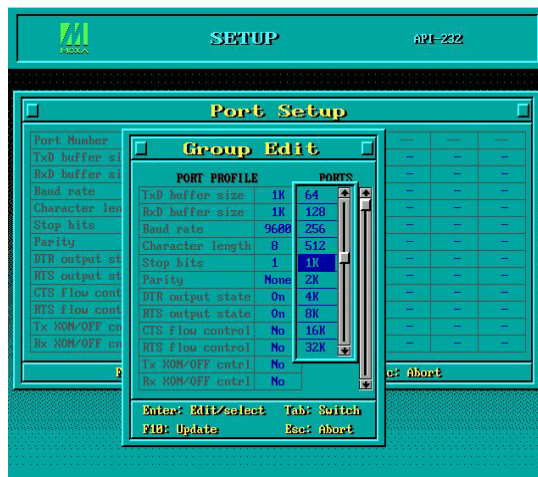

## Loading the Driver

After completing the setup procedure, run BIN\DP-DRV.EXE from the DOS prompt to load the driver. The driver will automatically detect the boards that have already been installed. If one or more board is detected, you will see a message similar the following:

```
Smartio/Industio Family DOS driver Version 1.5
Setup driver ...
CP-134U series (Bus= x ,Dev=y) : OK!
Device driver setup O.K.
```

This means that the CP-134U Series driver has been installed properly. At this point, you

---

can execute applications that support API-232 functions, or start developing applications using the API-232 library.

## Unloading the Driver

To unload (release) the driver from memory, type **DP-DRV/Q** at the DOS prompt.

## Linux

The Linux driver for MOXA's multiport serial boards supports the following products:

- **Universal PCI Boards:** CP-168U, CP-104UL, CP-104JU, CP-134U, CP-134U-I, CP-132UL, CP-132UL-I V2(CP-132U-I V1)
- **PCI Boards:** C168H/PCI, C104H/PCI, C104HS/PCI, CP-114, CP-114I, CP-114S, CP-114IS, CP-132, CP-132I, CP-132S, CP-132IS
- **ISA Boards:** C168H, C168HS, C168P, C104H, C104HS, C104P, CI-104J, CI-104JS, CI-134, CI-134I, CI-134IS, CI-132, CI-132I, CI-132IS
- **cPCI Boards:** CT-114I

The following steps use CP-168U to illustrate.

Follow the steps below to install the driver under Linux.

1. # mkdir moxa  
# cd moxa  
# tar xvzf mxser.tgz
2. #cd mxser  
#make clean; make install
3. # cd /moxa/mxser/driver  
# ./msmknod

## Software Installation

---

4. # modprobe mxser <- Universal PCI or PCI  
(If you install ISA Boards, use type command # insmod mxser ioaddr=0x???, 0x???, 0x???, 0x??? <- 1st ISA, 2nd ISA, 3rd ISA, 4th ISA)  
Using /lib/modules/2.4.20-8/kernel/drivers/char/mxser.o  
Warning: loading /lib/modules/2.4.20-8/kernel/drivers/char/mxser.o will taint the kernel: no license  
See <http://www.tux.org/lkml/#export-tainted> for information about tainted modules  
MOXA Smartio/Industio family driver version 1.7  
Tty devices major number = 30, callout devices major number = 35  
Found MOXA CP-168U series board (BusNo=2,DevNo=13)  
Module mxser loaded, with warnings
5. You can use Moxa diagnostic utility to verify driver status.  
# cd /moxa/mxser/utility/diag  
# ./msdiag  
== MOXA Smartio/Industio Family Multiport Board Status Utility(1.1) ==  
Tty Device Major Number= 30.  
Callout device Major Number= 35.  
Board 1 : CP-168U series (BusNo=2, DevNo=13)  
Port 1: 0xac00, max. baud rate = 230400 bps.  
Port 2: 0xac08, max. baud rate = 230400 bps.  
Port 3: 0xac10, max. baud rate = 230400 bps.  
Port 4: 0xac18, max. baud rate = 230400 bps.  
Port 5: 0xac20, max. baud rate = 230400 bps.  
Port 6: 0xac28, max. baud rate = 230400 bps.  
Port 7: 0xac30, max. baud rate = 230400 bps.  
Port 8: 0xac38, max. baud rate = 230400 bps.
6. You can use Moxa terminal utility to test tty port.  
# cd /moxa/mxser/utility/term  
# ./msterm



# 4

## Serial Programming Tools

---

Moxa supports an easy to use yet powerful serial programming library and communication troubleshooting utilities under Windows NT, Windows 95/98, and Windows 2000/XP/2003. You can save a lot of development time by using MOXA's Serial Programming Tools.

The following sections give details about the installation, the library, and the utilities for various platforms.

*PComm*, a professional serial comm tool for PCs, is a software package that runs under Windows NT/2000/XP/2003 and Windows 95/98. *PComm* provides:

- A powerful serial communication library for easy programming in the most popular programming languages. The serial communication library is useful for developing applications for data communications, remote access, data acquisition, and industrial control under Windows NT/2000/XP/2003 or Windows 95/98. It is a simpler solution compared to the more complex Windows Win32 COMM API.
- Useful utilities such as diagnostic, monitor, and terminal emulator.
- Illustrative sample programs.
- Comprehensive on-line documentation.

### ***PComm* Installation**

To install *PComm*, run \Setup.exe from the diskette. Note that the *PComm* diagnostic and monitor utilities are for MOXA boards only. MOXA Windows 95/98/NT/2000/XP device drivers, as well as MOXA boards are required. The drivers are installed separately, with details given in the "Software Installation" chapter.

After *PComm* is successfully installed, click on [Start], select [Program Files], and then *PComm* Lite group to select a list of utilities and documents.

---

## *PComm* Programming Library

The serial communication library helps you develop programs for serial communications for any COM port complying with the Microsoft Win32 API. It facilitates the implementation of multi-process and multi-thread serial communication programs, and consequently greatly reduces developing time.

For a complete library function description and sample programs for Visual C++, Visual Basic, and Delphi, check the help file and the sample programs in the *PComm* directory.

## Utilities

In this section, we give brief descriptions of each utility. For more information about these utilities, see the on-line help from the software diskette.

### Diagnostic (for MOXA boards only)

A convenient diagnostic program, ONLY for MOXA boards and ports, provides internal and external testing of IRQ, Tx/D/RxD, UART, CTS/RTS, DTR/DSR, DTR/DCD, etc. It allows the user to check the function of both software and hardware.

To run the Diagnostic program, click on [Start]→[Program]→[*PComm* Lite]→[Diagnostic]. A typical test report for the CP-168U Series board is shown below.

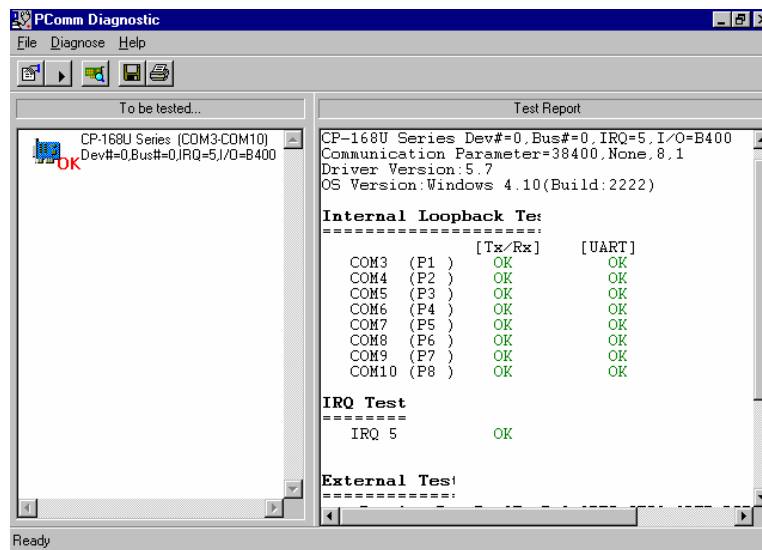

### Monitor (for MOXA boards under Windows NT/2000/XP/2003)

A useful port status monitoring program allows you to monitor data transmission of selected MOXA COM ports. It monitors data transmission/receiving throughput, and communication line status, with data updated and displayed on the screen at regular time intervals. Click on a specific port to see a graph of the current communication parameters and status of that port.

To run the Monitor program, click on [Start]→[Program]→[*Pcomm Lite*]→[Monitor].

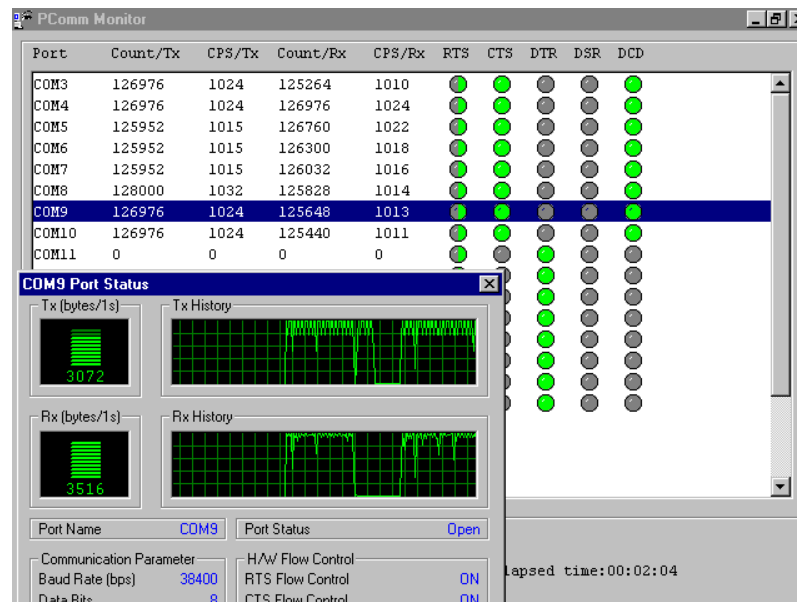

### Terminal Emulator

Terminal Emulator can be used to connect to various ports to see if data transmission is functioning correctly. Terminal Emulator features multi-windows, and supports VT100 and ANSI terminal types. You can transfer data interactively, send patterns periodically, and transfer files using ASCII, XMODEM, YMODEM, ZMODEM, and KERMIT protocols.

To run Terminal Emulator, click on [Start]→[Program]→[*Pcomm Lite*]→[Terminal Emulator].

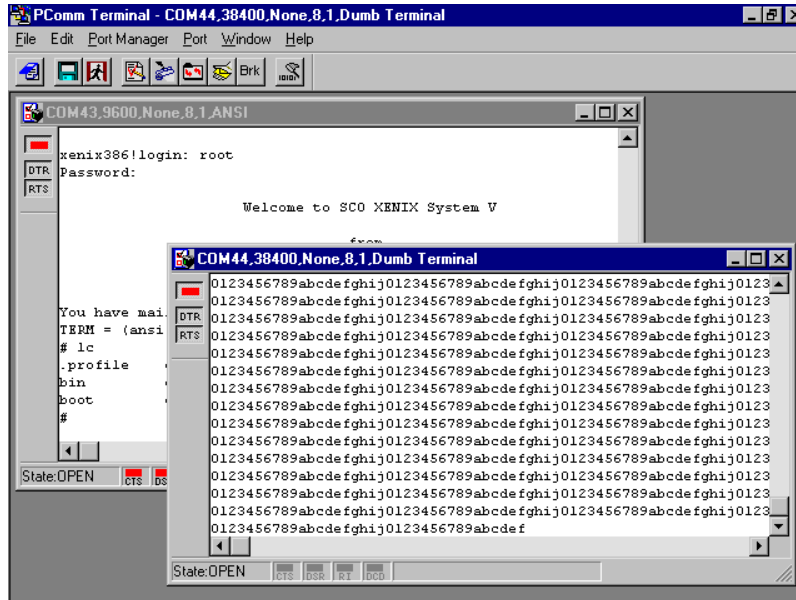

## RS-485 Programming

If you intend to use your CP-132UL Series board for RS-485 applications, you can refer to the RS-485 programming guide below, and also see the chapter, “Connection Cables and Cable Wiring,” for more details about RS-485 operation.

The CP-132UL Series supports only 2-wire half-duplex RS-485 communication. In this case, the data+/- pins are used for both data transmitting and receiving, depending on the mode selected. Moxa’s own ADDC™ (Automatic Data Direction Control) technology is used to switch between transmitting and receiving.

### ADDCTM (Automatic Data Direction Control)

ADDCTM is the best method for switching between transmission and receiving when using 2-wire RS-485.

When using ADDCTM, additional code is not required to switch between data transmitting and receiving, since the switching mechanism is managed automatically by the board’s built-in intelligent hardware mechanism. This means that RS-485 programming using ADDCTM mode is just as simple and straightforward as RS-232 or RS-422 programming.



# 5

## Connection Cables and Cable Wiring

---

In serial data communications, the term **DTE** stands for Data Terminal Equipment, such as a PC's COM1/2, serial printers, and terminals. The term **DCE** stands for Data Communication Equipment, such as modems.

---

## **RS-422/485 Pinouts and Cable Wiring**

### **RS-422 Interface**

The RS-422 standard uses a balanced voltage digital interface to allow 9600 bps communication over cables of up to 4000 feet in length. Ten receivers can be connected to any one driver for broadcasting systems.

### **RS-485 Interface**

The RS-485 standard is an enhanced version of the RS-422 balanced line standard. It allows multiple drivers and receivers to work on a multidrop network. A maximum of 32 drivers and 32 receivers can be set up on a multidrop network.

The CP-132UL Series supports both 2-wire half-duplex and 4-wire full-duplex RS-485 communications. In 2-wire RS-485, Data+/- pins are used for both data transmitting and receiving, depending on the RTS signal.

## Connection Cables and Cables Wiring

### Pinouts

RS-422/485 pinouts for CP-132UL Series

#### CP-132UL (RS-422/485)

		RS-422 and 4-wire RS-485	2-wire RS-485
Port 1	8	CTS-(A)	
	9	RxD-(A)	Data-(A)
	10	RTS-(A)	
	11	RTS+(B)	
	12	RxD+(B)	Data+(B)
	21	TxD-(A)	
	22	SGND	
	23	CTS+(B)	
Port 2	2	TxD-(A)	
	3	SGND	
	4	CTS+(B)	
	5	TxD+(B)	
	14	CTS-(A)	
	15	RxD-(A)	Data-(A)
	16	RTS-(A)	
	17	RTS+(B)	
18	RxD+(B)	Data+(B)	

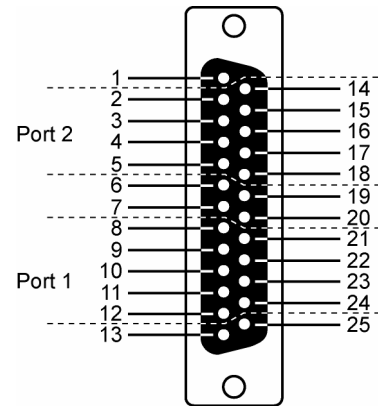

#### CBL-M25M9x2

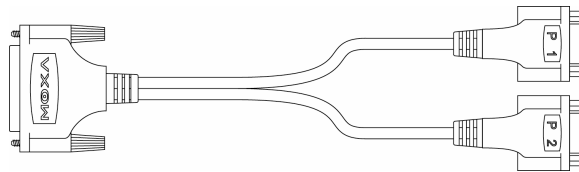

---

**RS-422 pinouts for CP-132UL Series**

**CP-132UL (RS-422)**

- 
- |   |         |
|---|---------|
| 1 | TxD-(A) |
| 2 | TxD+(B) |
| 3 | RxD+(B) |
| 4 | RxD-(A) |
| 5 | GND     |
| 6 | RTS-(A) |
| 7 | RTS+(B) |
| 8 | CTS+(B) |
| 9 | CTS-(A) |

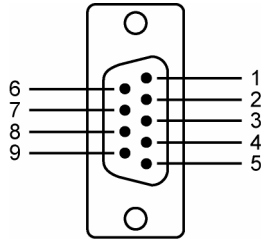

**2-wire RS-485 pinouts for CP-132UL:**

**CP-132UL (2-wire RS-485)**

- 
- |   |          |
|---|----------|
| 1 | ---      |
| 2 | ---      |
| 3 | Data+(B) |
| 4 | Data-(A) |
| 5 | GND      |
| 6 | ---      |
| 7 | ---      |
| 8 | ---      |
| 9 | ---      |

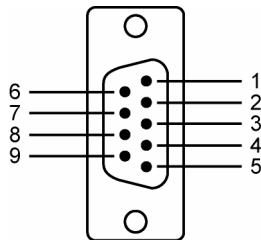

**4-wire RS-485 pinouts for CP-132UL Series**

**CP-132UL (4-wire RS-485)**

- 
- |   |         |
|---|---------|
| 1 | TxD-(A) |
| 2 | TxD+(B) |
| 3 | RxD+(B) |
| 4 | RxD-(A) |
| 5 | GND     |
| 6 | ---     |
| 7 | ---     |
| 8 | ---     |
| 9 | ---     |

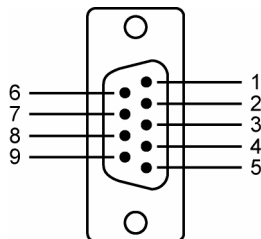

## Connection Cables and Cables Wiring

---

### Cable Wiring

#### RS-422 Point-to-point

CP-132UL		RS-422 Device
2	TxD+(B) ———	RxD+(B)
1	TxD-(A) ———	RxD-(A)
3	RxD+(B) ———	TxD+(B)
4	RxD-(A) ———	TxD-(A)
5	GND ———	GND

#### RS-422 Broadcasting

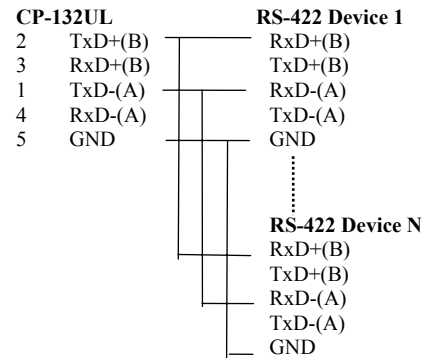

#### CP-132UL – RS-422 with Handshaking

CP-132UL		RS-422 Device
2	TxD+(B) ———	RxD+(B)
1	TxD-(A) ———	RxD-(A)
3	RxD+(B) ———	TxD+(B)
4	RxD-(A) ———	TxD-(A)
5	GND ———	GND
7	RTS+(B) ———	CTS+(B)
6	RTS-(A) ———	CTS-(A)
8	CTS+(B) ———	RTS+(B)
9	CTS-(A) ———	RTS-(A)

#### CP-132UL – 2-wire RS-485

CP-132UL		RS-422 Device
3	Data+(B) ———	Data+(B)
4	Data-(A) ———	Data-(A)
5	GND ———	GND

---

### Multidrop 2-wire RS-485 (half-duplex)

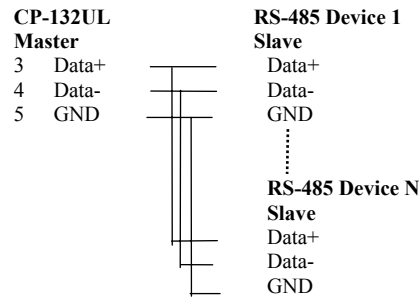

### Multidrop 4-wire RS-485 (full-duplex)

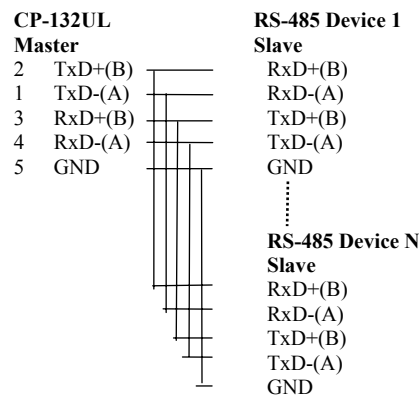

See the section “**RS-485 Programming**” in the “**Serial Programming Tools**” chapter for more details on RS-485 programming.

### Impedance Matching and Termination Resistors

When using RS-422/485 serial communications, an electrical signal that travels through two different resistance junctions in a transmission line will sometimes give rise to signal reflection due to the impedance mismatch. Signal reflection causes signal distortion, which in turn contributes to communication errors. The solution to this problem is to establish the same impedance at the ends of the transmission line, as in the line itself, by terminating the ends of the line with resistors.





# 6

## Troubleshooting

---

Common CP-132UL Series problems and possible solutions are listed below. If you still have problems after reading this chapter, contact your dealer or Moxa for help, or use the **Problem Report Form** at the end of this manual to report problems to your dealer.

### General Troubleshooting

1. **The MOXA PCI board cannot be detected by the MOXA driver while installing the driver.**

**Hardware causes and solutions:**

- a. The board is not installed in the computer. Please install it.
- b. The board is not properly plugged into the system. If this is the case, re-plug the board in a 32-bit PCI. It is also possible that a slot has malfunctioned. In this case, try other slots until you find one that works.
- c. The motherboard does not have an available IRQ for the CP-132UL Series board. In this case, enter the BIOS and make sure there is an available IRQ under PCI/PnP settings.

- 
2. **The MOXA board and driver are activated but cannot transfer (transmit/receive) data.**

**Hardware Causes and Solutions:**

- a. Make sure the cable wiring is connected correctly. Refer to the “**Connection Cable and Cable Wiring**” chapter for correct cable connections.
- b. The cable or the board are probably defective. Try other ports, cables, or boards to verify this, or use the *PCComm* Diagnostic utility to test the MOXA board’s and port conditions. If Diagnostic reports an error, replace the faulty components.

**Software Causes and Solutions:**

- a. CP-132UL Series boards will check the line status (CTS) before transmitting data if the RTS/CTS flow control feature is set to Enable in the configuration or application program. Refer to the Connection Cables and Cable Wiring chapter for proper wiring diagrams, and check the line status of the suspected port using the diagnostic LED indicators on the mini tester.
- b. The board controlling application might not be correctly written according to the corresponding API of the operating system. To check this problem, run another existing and known good application or use the utilities provided by Moxa (such as *Pcomm* Terminal emulator or HyperTerminal under Windows NT and Windows 95/98).

### Windows NT

This section is specifically for troubleshooting under Windows NT. For general problems and solutions, see the previous section, “General Troubleshooting.”

1. **After the system reboots, the error message “Another driver in the system, which did not report its resources, has already claimed the interrupt used by xxx.” appears in the Event Log.**

This indicates the MOXA board was found, but the IRQ is conflicting with another adapter. Please check the PCI BIOS IRQ settings first and then select an IRQ that is available.

2. **After the system reboots, the error message “Cannot find any configured MOXA Smartto/Industto Series board!” appears in the Event Log.**

Make sure the PCI board is seated firmly in the expansion slot.

3. **The COM number of the CP-132U Series conflicts with others.**

The COM numbers of different boards happen to be the same. Try changing the COM number mappings.

4. **Windows NT system panic (blue screen).**

The possible reason is an IRQ or memory conflict with other ISA Bus adapters, like LAN and SCSI boards, or the system BIOS. Refer to the corresponding problem in the previous section, “General Troubleshooting,” for possible solutions.

---

## Windows 95/98

This section is specifically for troubleshooting under Windows 95/98. For general problems and solutions, see the previous section, “General Troubleshooting.”

1. **The system fails to find the CP-132U Series board!**
  - The board(s) is(are) not plugged properly.
  - The slot the boards are plugged into is defective. Try another slot until you find one that works.
  - The board might be defective.
2. **After the system reboots, the error message “CP-132U Series (BusNo=x, DevNo=x, Port1=COMx) interrupt number is invalid!” appears.**

This indicates that the MOXA board was found, but the IRQ conflicts with another adapter. Make sure the MOXA board’s IRQ does not conflict with other adapters’ IRQ. Check the PCI BIOS IRQ settings and select an available IRQ for MOXA boards.

# A

## Technical Reference

### Specifications

Bus interface	32-bit PCI
Number of ports	2
Max. No. of boards	4
I/O address	Assigned by PCI BIOS
IRQ	Assigned by PCI BIOS
Comm. controller	MOXA UART (16C550C compatible)
Transmission speed	50 bps to 230.4 Kbps (CP-132UL, CP-132U-I) 50 bps to 921.6 Kbps (CP-132UL V2, CP-132UL-I V2)
Data bits	5, 6, 7, 8
Stop bits	1, 1.5, 2
Parity	none, even, odd, space, mark
Data signals	RS-422 TxD+(B)/-(A), RxD+(B)/-(A), RTS+(B)/-(A), CTS+(B)/-(A), GND 4-wire RS-485 TxD+(B)/-(A), RxD+(B)/-(A), GND 2-wire RS-485 Data+(B)/-(A), GND
Connectors	2 DB9 male ports
Optical isolation	Max. 2000V (CP-132U-I, CP-132UL-I V2)
Surge protection	ESD max. 16000V (CP-132UL, CP-132U-I, CP-132UL V2, CP-132UL-I V2)
Termination Resistor	120 $\Omega$
Operating temperature	0 – 55°C

---

Power requirement	CP-132UL	220 mA (+5V)
	CP-132UL V2	120 mA (+5V)
	CP-132U-I	578 mA (+5V)
	CP-132UL-I V2	490 mA (+5V)
Dimensions (W × D)	CP-132UL	120 × 64.5 mm
	CP-132UL V2	120 × 64.5 mm
	CP-132U-I	120 × 100 mm
	CP-132UL-I V2	120 × 64.5 mm

## PCI

The 32-bit CP-132UL Series board complies with PCI Specifications 2.1. The IRQ and I/O address hardware configuration is automatically assigned by the PCI BIOS. This means that you must **first plug in the board** before installing the driver software.

As opposed to ISA slots, different PCI slots in the same PC may have different bus numbers and device numbers with respect to the PCI specifications. The same PCI board will have different system configurations if switched to a different PCI slot; this is called **slot-sensitive** or **slot-dependent**. This may also apply to PCI slots in a PC with a different motherboard, which may use **different device number sets**. For example, some use 17, 18, 19, and 20 for identifying the respective PCI slots, but some use 11, 12, 13 and 14.

Due to **slot-dependency**, it is necessary to **re-configure the driver software** once the board is plugged into different PCI slots.

Up to 4 CP-132UL Series boards are allowed in one system. When installing more than one board, **please remember the order the boards are installed** to distinguish the installed boards from each other.

### Return Procedure

For product repair, exchange, or refund, the customer must:

- ◆ Provide evidence of original purchase.
- ◆ Obtain a Product Return Agreement (PRA) from the sales representative or dealer.
- ◆ Fill out the Problem Report Form (PRF). Include as much detail as possible for a shorter product repair time.
- ◆ Carefully pack the product in an anti-static package, and send it, pre-paid, to the dealer. The PRA should be visible on the outside of the package, and include a description of the problem, along with the return address and telephone number of a technical contact.

## Free Manuals Download Website

<http://myh66.com>

<http://usermanuals.us>

<http://www.somanuals.com>

<http://www.4manuals.cc>

<http://www.manual-lib.com>

<http://www.404manual.com>

<http://www.luxmanual.com>

<http://aubethermostatmanual.com>

Golf course search by state

<http://golfingnear.com>

Email search by domain

<http://emailbydomain.com>

Auto manuals search

<http://auto.somanuals.com>

TV manuals search

<http://tv.somanuals.com>