

MSI

MICRO-STAR INTERNATIONAL

MS-6534 Micro ATX Mainboard



Version 1.0
G52-MA00417

Manual Rev: 1.0
Release Date: August 2001



FCC-B Radio Frequency Interference Statement

This equipment has been tested and found to comply with the limits for a class B digital device, pursuant to part 15 of the FCC rules. These limits are designed to provide reasonable protection against harmful interference when the equipment is operated in a commercial environment. This equipment generates, uses and can radiate radio frequency energy and, if not installed and used in accordance with the instruction manual, may cause harmful interference to radio communications. Operation of this equipment in a residential area is likely to cause harmful interference, in which case the user will be required to correct the interference at his own expense.

Notice 1

The changes or modifications not expressly approved by the party responsible for compliance could void the user's authority to operate the equipment.

Notice 2

Shielded interface cables and A.C. power cord, if any, must be used in order to comply with the emission limits.

**VOIR LA NOTICE D'INSTALLATION AVANT DE RACCORDER
AU RESEAU.**



Edition

August 2001

Copyright Notice

The material in this document is the intellectual property of **MICRO-STAR INTERNATIONAL**. We take every care in the preparation of this document, but no guarantee is given as to the correctness of its contents. Our products are under continual improvement and we reserve the right to make changes without notice.

Trademarks

All trademarks used in this manual are the property of their respective owners.

Intel and Pentium are registered trademarks of Intel Corporation.

PS/2 and OS/2 are registered trademarks of IBM Corporation.

Windows 98/2000/ME and Windows NT are registered trademarks of Microsoft.

Netware is a registered trademark of Novell.

Award is a registered trademark of Award Software Inc.

AMI is a registered trademark of American Megatrends. Inc.

Revision History

Revision	Revision History	Date
1.0	First Release	August 2001

Safety Instructions

1. Always read the safety instructions carefully.
2. Keep this User's Manual for future reference.
3. Keep this equipment away from humidity.
4. Lay this equipment on a reliable flat surface before setting it up.
5. The openings on the enclosure are for air convection hence protects the equipment from overheating. **DO NOT COVER THE OPENINGS.**
6. Make sure the voltage of the power source and adjust properly 110/220V before connecting the equipment to the power inlet.
7. Place the power cord such a way that people can not step on it. Do not place anything over the power cord.
8. Always Unplug the Power Cord before inserting any add-on card or module.
9. All cautions and warnings on the equipment should be noted.
10. Never pour any liquid into the opening that could damage or cause electrical shock.
11. If any of the following situations arises, get the equipment checked by a service personnel:
 - The power cord or plug is damaged
 - Liquid has penetrated into the equipment
 - The equipment has been exposed to moisture
 - The equipment has not work well or you can not get it work according to User's Manual.
 - The equipment has dropped and damaged
 - If the equipment has obvious sign of breakage
12. **DO NOT LEAVE THIS EQUIPMENT IN AN ENVIRONMENT UNCONDITIONED, STORAGE TEMPERATURE ABOVE 60⁰ C (140⁰F), IT MAY DAMAGE THE EQUIPMENT.**



CAUTION: Danger of explosion if battery is incorrectly replaced. Replace only with the same or equivalent type recommended by the manufacturer.

Contents

Chapter 1. Introduction	1-1
Mainboard Specification	1-2
Mainboard Layout	1-4
Quick Components Guide	1-5
Key Features	1-6
Chapter 2. Hardware Setup	2-1
Central Processing Unit: CPU	2-2
Installing the CPU	2-2
Installing the CPU Fan	2-3
CPU Core Speed Derivation Procedure	2-4
Memory	2-5
Introduction to SDRAM	2-5
DIMM Modules Combination	2-6
Installing DIMM Modules	2-6
Power Supply	2-7
ATX 20-Pin Power Connector	2-7
ATX 12V Power Connector: JPW1	2-8
Back Panel	2-9
Mouse Connector	2-9
Keyboard Connector	2-10
USB Connectors	2-10
Parallel Port Connector	2-11
Serial Port Connectors: COM A & COM B	2-12
Joystick/Midi Connector	2-12
Audio Port Connectors	2-12
Connectors	2-13
Floppy Disk Drive Connector: FDD1	2-13
Hard Disk Connectors: IDE1 & IDE2	2-14
Case Connectors: F_P1 & F_P2	2-15

Power Saving Switch Connector: JGS1	2-19
Wake On LAN Connector: JWOL1	2-19
Wake On Ring Connector: JMDM1 (Optional)	2-20
IrDA Infrared Module Connectors: IR1 & IR2	2-21
Fan Power Connectors: C_FAN1/S_FAN1	2-22
CD-In/Aux Line-In/Modem-In Connector: CD_IN1/AUX_IN1/ MDM_IN1	2-23
USB Front Panel Connectors: USB1 & USB2	2-24
Front Panel Audio Connector: JAUDIO1	2-25
Jumpers	2-26
Clear CMOS Jumper: JBAT1	2-26
Slots	2-27
AGP (Accelerated Graphics Port) Slot	2-27
PCI Slots	2-27
CNR (Communication Network Riser) Slot	2-27
PCI Interrupt Request Routing	2-28
Chapter 3. AWARD® BIOS Setup	3-1
Entering Setup	3-2
Control Keys	3-2
Getting Help	3-3
The Main Menu	3-4
Standard CMOS Features	3-6
Advanced BIOS Features	3-9
Advanced Chipset Features	3-13
Integrated Peripherals	3-15
Power Management Setup	3-19
PnP/PCI Configurations	3-23
PC Health Status	3-25
Frequency/Voltage Control	3-26
Load Fail-Safe/Optimized Defaults	3-28

Set Supervisor/User Password	3-30
Save & Exit Setup	3-32
Exit Without Saving	3-33
Chapter 4. AMI® BIOS Setup	4-1
Entering Setup	4-2
Selecting the First Boot Device	4-2
Control Keys	4-3
Getting Help	4-4
The Main Menu	4-5
Standard CMOS Setup	4-7
BIOS Features Setup	4-9
Chipset Features Setup	4-12
Power Management Setup	4-14
PNP/PCI Configuration	4-18
Integrated Peripherals	4-20
Hardware Monitor Setup	4-24
Load Optimal/Fail Safe Defaults	4-26
Supervisor/User Password	4-28
IDE HDD AUTO Detection	4-30
Save & Exit Setup	4-31
Exit Without Saving	4-32
Appendix A. Using 4-/6-channel Audio Function	A-1
Installing C-Media Drivers	A-2
Hardware Configuration	A-2
Software Configuration	A-3
Glossary	I

Introduction

1

Thank you for purchasing the MS-6534 Micro-ATX motherboard. The mainboard, based on **Intel® Brookdale (82845) & 82801BA** chipsets, is a high-performance computer mainboard designed for Intel® Pentium® 4 processor in the 478 pin package that provides a high-end and professional desktop platform solution.

This chapter includes the following topics:

Mainboard Specification	1-2
Mainboard Layout	1-4
Quick Components Guide	1-5
Key Features	1-6

Chapter 1

Mainboard Specification

CPU

- Supports Socket478 for Intel® Pentium 4 (FC-PGA2) processor
- Supports 1.3GHz, 1.4GHz and up to 2.xGHz

Chipset

- Intel® Brookdale chipset
 - AGP 4x/2x universal slot
 - Supports 100MHz FSB
 - Supports 400MHz Intel NetBurst micro-architecture bus
- Intel® ICH2 chipset (360 BGA)
 - AC'97 Controller Integrated
 - 2 full IDE channels, up to ATA100
 - Low pin count interface for Winbond SIO

Main Memory

- Supports two 168-pin DIMM sockets
- Supports 32MB to 1GB memory using 512Mbit technology
- Max. memory size: 2GB

 **Note:** As 845 chipset does not properly support the PC100 memory, it is strongly recommended to **install PC133 DIMM modules for better system performance and stability**. We do not guarantee the system stability when installing PC 100 DIMM modules.

Slots

- One AGP (Accelerated Graphics Port) 2x/4x **1.5V** slot
- Three PCI 2.2 32-bit Master PCI Bus slots
- Supports 3.3v/5v PCI bus Interface
- One CNR slot

On-Board IDE

- An IDE controller on the ICH2 chipset provides IDE HDD/CD-ROM with PIO, Bus Master and Ultra DMA66/100 operation modes.
- Can connect up to four IDE devices.

On-Board Peripherals

- On-Board Peripherals include:

- 1 floppy port supports 1 FDD with 360K, 720K, 1.2M, 1.44M and 2.88Mbytes.
- 2 serial ports (COMA / COMB)
- 1 parallel port supports SPP/EPP/ECP mode
- 4 USB ports (Rear * 2 / Front * 2)
- PS/2 Keyboard/Mouse connector
- 1 Line-In/Line-Out/Mic-In/Game port

H/W Audio (Optional)

- C-mediaCMI8738-6CH-LX
- Supports 6 channel Audio
- AC97 2.1 compliant

S/W Audio

- 2-channel Audio Codec
- 4-channel Audio Codec (Optional)
- AC97 2.1 compliant

BIOS

- The mainboard BIOS provides “Plug & Play” BIOS which detects the peripheral devices and expansion cards of the board automatically.
- The mainboard provides a Desktop Management Interface (DMI) function which records your mainboard specifications.

Dimension

- Micro ATX Form Factor (24.4cm x 22.4cm)

Mounting

- 6 mounting holes

Chapter 1

Mainboard Layout

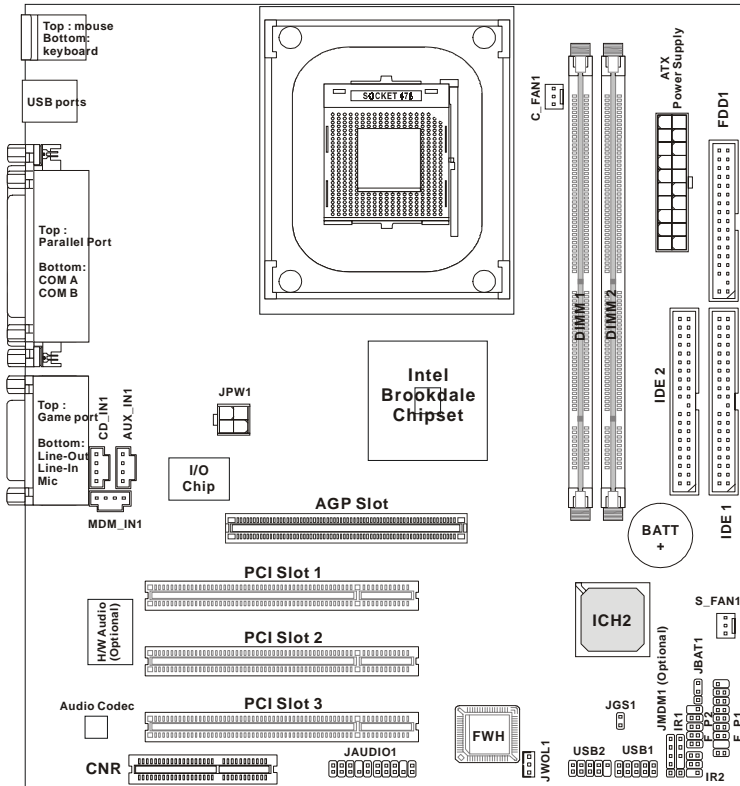

MS-6534 Micro-ATX Mainboard

Quick Components Guide

Component	Function	Reference
DIMM1~2	Installing DIMM modules	See p. 2-5~2-6
Socket 478	Installing CPU	See p. 2-2~2-4
C_FAN1	Connecting to CPU FAN	See p. 2-22
S_FAN1	Connecting to SYSTEM FAN	See p. 2-22
ATX Power Supply	Installing power supply	See p. 2-7
JPW1	Connecting to 12V ATX power supply	See p. 2-8
IDE1& IDE2	Connecting to IDE hard disk drives	See p. 2-14
FDD1	Connecting to floppy disk drive	See p. 2-13
USB1/2	Connecting to USB interfaces	See p. 2-24
PCI Slot 1~3	Installing PCI expansion cards	See p. 2-27
AGP Slot	Installing AGP cards	See p. 2-27
CNR Slot	Installing CNR cards	See p. 2-27
JMDM1 (Optional)	Connecting to modem module	See p. 2-20
JWOL1	Connecting to LAN module	See p. 2-19
JBAT1	Clearing CMOS data	See p. 2-26
F_P1/2	Connecting to case	See p. 2-15
JGS1	Connecting to power saving switch	See p. 2-19
IR1/2	Connecting to IR modules	See p. 2-21
JAUDIO1	Connecting to front audio connectors	See p. 2-25

Chapter 1

Key Features

- Micro-ATX Form Factor
- CPU: Socket 478 for Intel® Pentium® 4 Processors
- Memory: 2 SDRAM DIMMs
- Slot: 1 AGP slot, 1 CNR slot, 3 PCI slots
- I/O: 2 serial ports, 1 parallel port, 4 USB 1.1 ports, 1 floppy port, 2 IrDA connectors, 1 Audio/Game port
- PC2001 Compliant
- LAN Wake up Function
- Modem (External/Internal) Ring Wake up Function (**Internal** Ring Wake up feature is Optional)
- STR (Suspend to RAM)
- Suspend to Disk
- Audio: Chip integrated

Hardware Setup

2

This chapter provides you with the information about hardware setup procedures. While doing the installation, be careful in holding the components and follow the installation procedures. For some components, if you install in the wrong orientation, the components will not work properly.

Use a grounded wrist strap before handling computer components. Static electricity may damage the components.

This chapter contains the following topics:

Central Processing Unit (CPU)	2-2
Memory	2-5
Power Supply	2-7
Back Panel	2-9
Connectors	2-13
Jumpers	2-26
Slots	2-27

Chapter 2

Central Processing Unit: CPU

The mainboard supports Intel® Pentium® 4 processor. The mainboard uses a CPU socket called Socket 478 for easy CPU installation. Make sure that the CPU has a Heat Sink and a cooling fan attached to prevent overheating. If you do not find the Heat Sink and cooling fan, contact your dealer or purchase them before turning on the computer.

Installing the CPU

1. Pull the lever sideways away from the socket. Then, raise the lever up to a 90-degree angle.
2. Look for the dot/cut edge. The dot/cut edge should point towards the lever pivot. The CPU will only fit in the correct orientation.
3. Hold the CPU down firmly, and then close the lever to complete the installation.

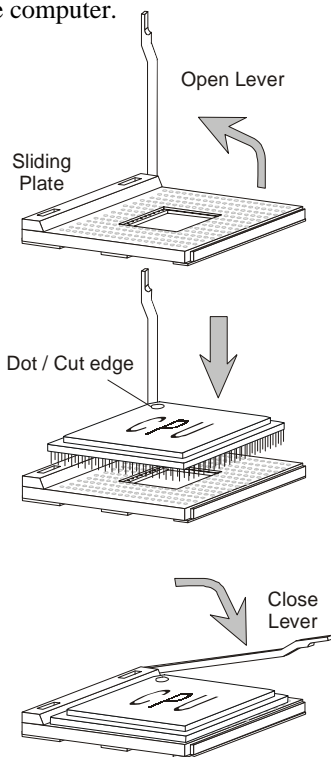

WARNING!

Overheating will seriously damage the CPU and system, always make sure the cooling fan can work properly to protect the CPU from overheating.

Installing the CPU Fan

As processor technology pushes to faster speeds and higher performance, thermal management becomes increasingly important. To dissipate heat, you need to attach the CPU cooling fan and heatsink on top of the CPU. Follow the instructions below to install the Heatsink/Fan:

1. Locate the CPU and its retention mechanism on the motherboard.
2. Position the heatsink onto the retention mechanism.

Retention Mechanism

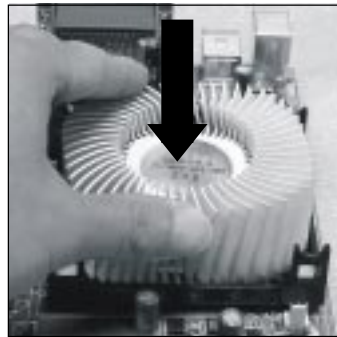
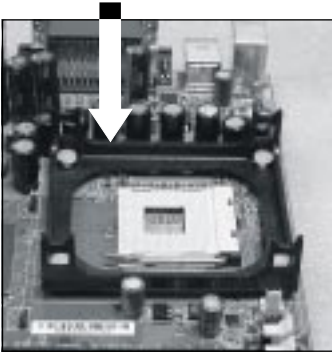

3. Mount the fan on top of the heatsink. Press down the fan until its four clips get locked in the holes of the retention mechanism.
4. Press the two levers down to fasten the fan. Each lever can be pressed down in only ONE direction.

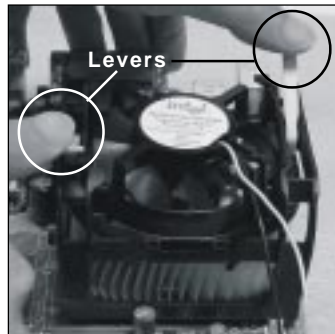
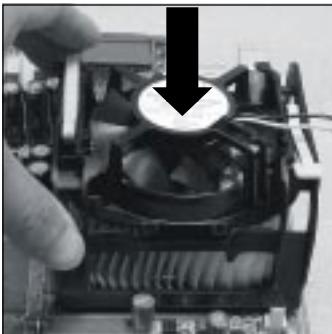

Chapter 2

5. Connect the fan power cable to the 3-pin fan power connector on the board.

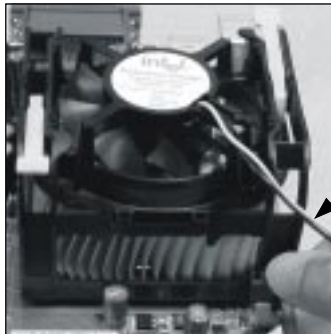

fan power cable

CPU Core Speed Derivation Procedure

If	CPU Clock	=	100MHz
	Core/Bus ratio	=	14
then	CPU core speed	=	Host Clock x Core/Bus ratio
		=	100MHz x 14
		=	1.4GHz



Overclocking

*This motherboard is designed to support overclocking. However, please make sure your components are able to tolerate such abnormal setting, while doing overclocking. Any attempt to operate beyond product specifications is not recommended. **We do not guarantee the damages or risks caused by inadequate operation or beyond product specifications.***

Memory

The mainboard provides 2 sockets for 168-pin SDRAM DIMM (Double In-Line Memory Module) modules and supports a maximum memory size of 2GB.

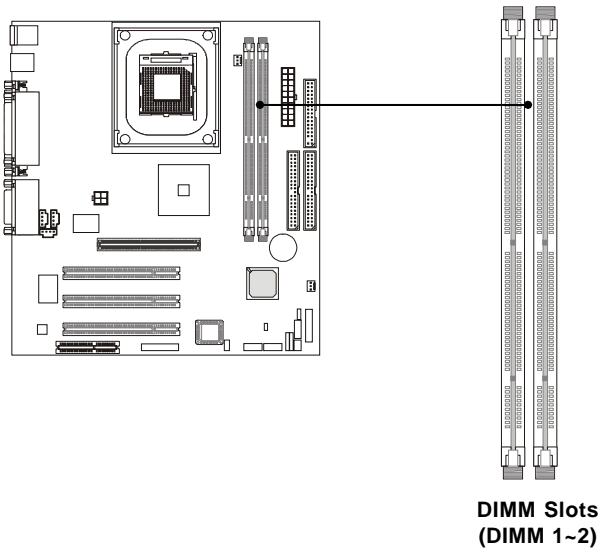

Introduction to SDRAM

Synchronous DRAM (SDRAM) is a type of dynamic RAM memory chip that has been widely used starting in the latter part of the 1990s. SDRAMs are based on standard dynamic RAM chips, but have sophisticated features that make them considerably faster. First, SDRAM chips are fast enough to be synchronized with the CPU's clock, which eliminates wait states. Second, the SDRAM chip is divided into two cell blocks, and data is interleaved between the two so that while a bit in one block is being accessed, the bit in the other is being prepared for access. This allows SDRAM to burst the second and subsequent, contiguous characters at a rate of 10ns, compared to 60ns for the first character.

SDRAM provides 800 MBps or 1 GBps data transfer depending on whether the bus is 100MHz or 133MHz.

Chapter 2

DIMM Modules Combination

You can install memory modules in any combination as follows:

S (Single Side): 32MB ~ 512MB
D (Double Side): 64MB ~ 1GB

DIMM 1	DIMM 2
S/D	--
--	S/D
S	D
D	S
S	S
D	D

 **Note:** As 845 chipset does not properly support the PC100 memory, it is strongly recommended to **install PC133 DIMM modules for better system performance and stability**. We do not guarantee the system stability when installing PC 100 DIMM modules.

Installing DIMM Modules

1. The DIMM slot has 2 Notch Keys "VOLT and DRAM", so the DIMM memory module can only fit in one direction.

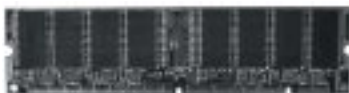

Front View



Rear View

2. Insert the DIMM memory module vertically into the DIMM slot. Then push it in.

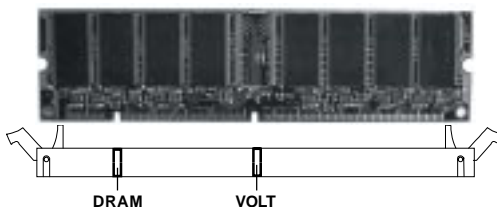

3. The plastic clip at each side of the DIMM slot will automatically close.

Power Supply

The mainboard supports ATX power supply for the power system. Before inserting the power supply connectors, always make sure that all components are installed properly to ensure that no damage will be caused.

ATX 20-Pin Power Connector

This connector allows you to connect to an ATX power supply. To connect to the ATX power supply, make sure the plug of the power supply is inserted in the proper orientation and the pins are aligned. Then push down the power supply firmly into the connector.

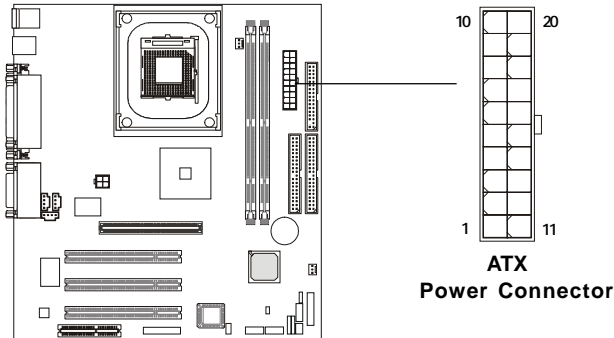

PIN	SIGNAL	PIN	SIGNAL
1	3.3V	11	3.3V
2	3.3V	12	-12V
3	GND	13	GND
4	5V	14	PS_ON
5	GND	15	GND
6	5V	16	GND
7	GND	17	GND
8	PW_OK	18	-5V
9	5V_SB	19	5V
10	12V	20	5V

Chapter 2

ATX 12V Power Connector: JPW1

Attaching the ATX power supply to the connector is helpful for offering sufficient voltage to Pentium 4 CPU.

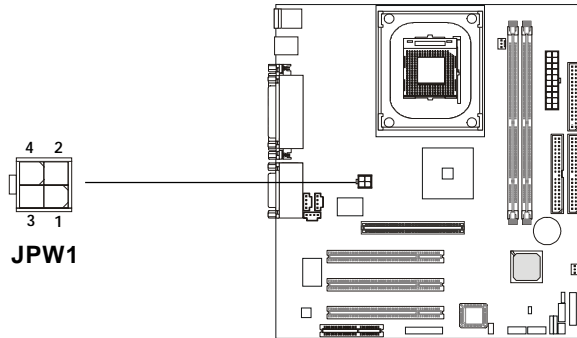

PIN	SIGNAL
1	GND
2	GND
3	12V
4	12V

Back Panel

The Back Panel provides the following connectors:

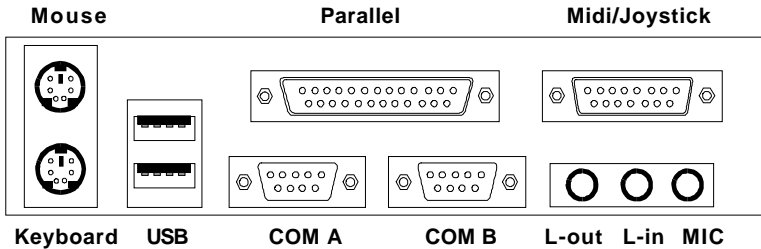

Mouse Connector

The mainboard provides a standard PS/2[®] mouse mini DIN connector for attaching a PS/2[®] mouse. You can plug a PS/2[®] mouse directly into this connector.

Pin Definition		
PIN	SIGNAL	DESCRIPTION
1	Mouse DATA	Mouse DATA
2	NC	No connection
3	GND	Ground
4	VCC	+5V
5	Mouse Clock	Mouse clock
6	NC	No connection

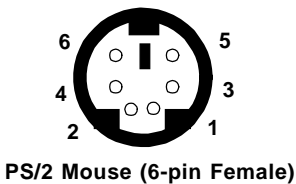

Chapter 2

Keyboard Connector

The mainboard provides a standard PS/2® keyboard mini DIN connector for attaching a PS/2® keyboard. You can plug a PS/2® keyboard directly into this connector.

Pin Definition

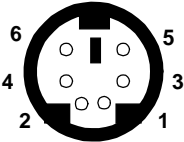

PS/2 Keyboard (6-pin Female)

PIN	SIGNAL	DESCRIPTION
1	Keyboard DATA	Keyboard DATA
2	NC	No connection
3	GND	Ground
4	VCC	+5V
5	Keyboard Clock	Keyboard clock
6	NC	No connection

USB Connectors

The mainboard provides a UHCI (Universal Host Controller Interface) Universal Serial Bus root for attaching USB devices such as keyboard, mouse or other USB-compatible devices. You can plug the USB device directly into this connector.

USB Port Description

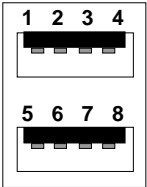

USB Ports

PIN	SIGNAL	DESCRIPTION
1	VCC	+5V
2	-Data 0	Negative Data Channel 0
3	+Data0	Positive Data Channel 0
4	GND	Ground
5	VCC	+5V
6	-Data 1	Negative Data Channel 1
7	+Data 1	Positive Data Channel 1
8	GND	Ground

Parallel Port Connector

The mainboard provides a 25-pin female centronic connector for LPT. A parallel port is a standard printer port that supports Enhanced Parallel Port (EPP) and Extended Capabilities Parallel Port (ECP) mode.

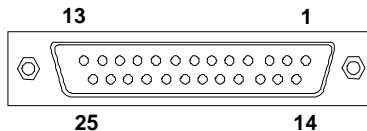

Pin Definition

PIN	SIGNAL	DESCRIPTION
1	STROBE	Strobe
2	DATA0	Data0
3	DATA1	Data1
4	DATA2	Data2
5	DATA3	Data3
6	DATA4	Data4
7	DATA5	Data5
8	DATA6	Data6
9	DATA7	Data7
10	ACK#	Acknowledge
11	BUSY	Busy
12	FE	Paper End
13	SELECT	Select
14	AUTO FEED#	Automatic Feed
15	ERR#	Error
16	INIT#	Initialize Printer
17	SLIN#	Select In
18	GND	Ground
19	GND	Ground
20	GND	Ground
21	GND	Ground
22	GND	Ground
23	GND	Ground
24	GND	Ground
25	GND	Ground

Chapter 2

Serial Port Connectors: COM A & COM B

The mainboard has two 9-pin male DIN connectors for serial port COM A and COM B. You can attach a serial mouse or other serial devices.

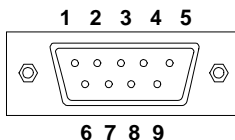

9-Pin Male DIN Connectors

Pin Definition

PIN	SIGNAL	DESCRIPTION
1	DCD	Data Carry Detect
2	SIN	Serial In or Receive Data
3	SOUT	Serial Out or Transmit Data
4	DTR	Data Terminal Ready)
5	GND	Ground
6	DSR	Data Set Ready
7	RTS	Request To Send
8	CTS	Clear To Send
9	RI	Ring Indicate

Joystick/Midi Connector

You can connect a joystick or game pad to this connector.

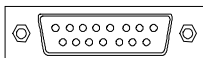

Audio Port Connectors

Line Out is to connect speakers or headphones. **Line In** is a connector for external CD player, Tape player or other audio devices. **Mic** is used to connect to a microphone.

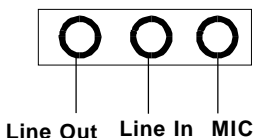

TIP

The mainboard provides **6-channel audio support** and can turn the rear audio connectors from 2-channel to 4-/6-channel audio. For more information, refer to Appendix A. Using 4-/6-channel Audio Function.

Connectors

The mainboard provides connectors to connect FDD, IDE HDD, case, modem, LAN, USB Ports, IR module and CPU/System FAN.

Floppy Disk Drive Connector: FDD1

The mainboard provides a standard floppy disk drive connector that supports 360KB, 720KB, 1.2MB, 1.44MB and 2.88MB floppy disk types.

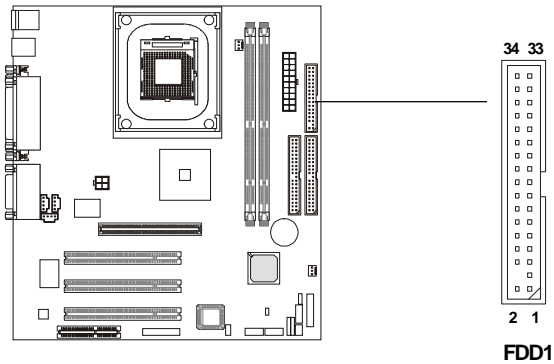

Chapter 2

Hard Disk Connectors: IDE1 & IDE2

The mainboard uses an IDE controller on the Intel® ICH2 chipset that provides PIO mode 0-4, Bus Master, and Ultra DMA 66/100 modes. It has two HDD connectors IDE1 (Primary) and IDE2 (Secondary). You can connect up to four hard disk drives, CD-ROM or 120MB Floppy to IDE1 and IDE2.

IDE1 (Primary IDE Connector)

- The first hard disk drive should always be connected to IDE1. You can connect a Master and a Slave drive to IDE1.

IDE2 (Secondary IDE Connector)

- You can connect a Master and a Slave drive to IDE2.

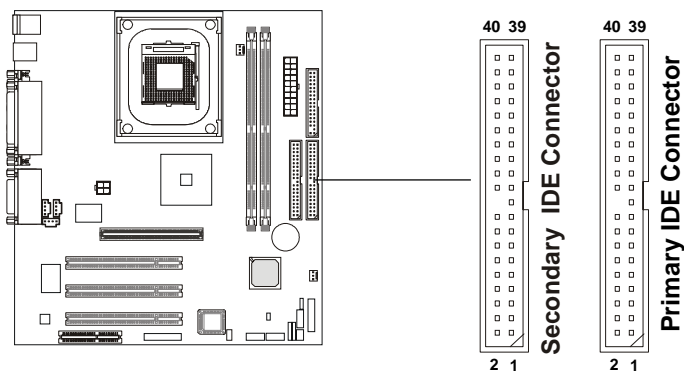

If you install two hard disks on cable, you must configure the second drive to Slave mode by setting its jumper. Refer to the hard disk documentation supplied by hard disk vendors for jumper setting instructions.

Case Connectors: F_P1 & F_P2

The case connector block F_P1 allows you to connect to the Power Switch, Reset Switch, Speaker, Power LED, Keylock and HDD LED on the case.

The other case connector block **F_P2 is compliant to Intel Front Panel I/O Connectivity Design Guide** and can connect to the the Power Switch, Reset Switch, Power LED and HDD LED on the case.

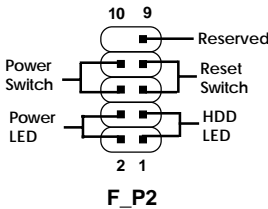
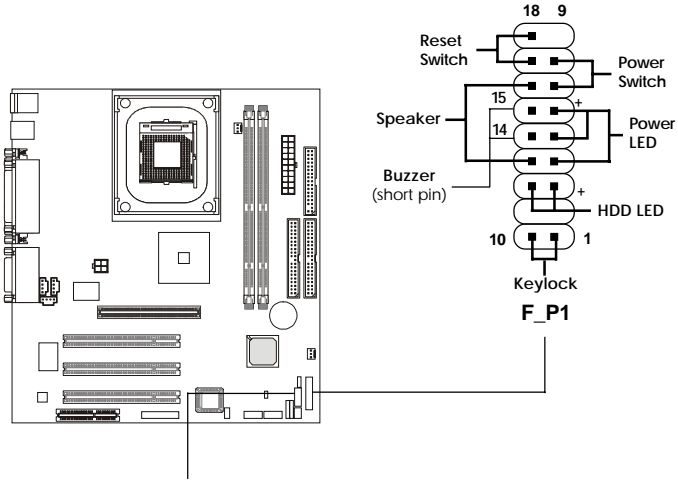

F_P2 Pin Definition

Pin	Description	Pin	Description
1	*HDD_LED+	2	PWR_LED G
3	HDD_LED-	4	PWR_LED Y
5	RESET-	6	PWR_SW+
7	RESET+	8	PWR_SW-
9	RSVD_DNU	10	NC

* Hard disk LED pullup (330 ohm) to +5V

F_P1 Pin Definition

Pin	Description	Pin	Description
1	Keylock	10	Keylock
2	NC	11	NC
3	HDD_LED+	12	HDD_LED-
4	GND	13	CASE_SPK
5	PWR_LED Y	14	CASE_SPK
6	PWR_LED G	15	CASE_SPK
7	PWR_SW+	16	CASE_SPK
8	PWR_SW-	17	RESET+
9	NC	18	RESET-

Chapter 2

Power Switch

Connect to a 2-pin push button switch.

Reset Switch

Reset switch is used to reboot the system rather than turning the power ON/OFF. Avoid rebooting while the HDD is working. You can connect the Reset switch from the system case to this pin.

Power LED (F_P1)

The Power LED is lit while the system power is on. There are three types of LEDs you can connect from the system case to the pin:

2-pin single color power LED: Connected to pin 5 & 6. The power LED is not able to change its color. You can only choose *Blinking* in the BIOS utility for the power LED to indicate the suspend/sleep mode.

LED Status	Description
Steady Green	The system is in the full-on mode.
Blinking	The system enters the suspend/sleep mode.

2-pin/3-pin dual color power LED: 2-pin LED is connected to pin 5 & 6. 3-pin LED is connected to pin 4, 5 & 6. The dual color power LED is able to change its color to indicate different system states. Therefore, you can select either *Blinking* or *Dual (color)* for the power LED to show the suspend/sleep mode.

- When you select *Blinking* in the BIOS utility:

LED Status	Description
Steady Green	The system is in the full-on mode.
Blinking	The system enters the suspend/sleep mode.

- When you select *Dual (color)* in the BIOS utility:

LED Status	Description
Steady Green	The system is in the full-on mode.
Steady Orange	The system enters the suspend/sleep mode.

Power LED (F_P2)

The Power LED is lit while the system power is on. There are two types of LEDs you can connect from the system case to the pin:

2-pin single color power LED: The power LED is not able to change its color. Therefore, you can only choose *Blinking* in the BIOS utility for the power LED to indicate the suspend/sleep mode.

LED Status	Description
Steady Green	The system is in the full-on mode.
Blinking	The system enters the suspend/sleep mode.

2-pin dual color power LED: The 2-pin power LED can change its color to indicate different system states. Therefore, you can select either *Blinking* or *Dual (color)* for the power LED to show the suspend/sleep mode.

- When you select *Blinking*:

LED Status	Description
Steady Green	The system is in the full-on mode.
Blinking	The system enters the suspend/sleep mode.

- When you select *Dual (color)*:

LED Status	Description
Steady Green	The system is in the full-on mode.
Steady Orange	The system enters the suspend/sleep mode.

Chapter 2

HDD LED

HDD LED shows the activity of a hard disk drive connected to the IDE1 or IDE2 connector. Avoid turning the power off while the HDD is working. You can connect the HDD LED from the system case to this pin.

Speaker (F_P1 only)

Speaker from the system case is connected to this pin.

If on-board Buzzer is available, then:

Short pin 14-15: On-board Buzzer Enabled.

Open pin 14-15: On-board Buzzer Disabled.

Keylock (F_P1 only)

Keylock allows you to disable the keyboard for security purpose. You can connect the keylock to this connector.

Power Saving Switch Connector: JGS1

Attach a power saving switch to this connector. Pressing the switch once will have the system enter the sleep/suspend state. Press any key to wake up the system.

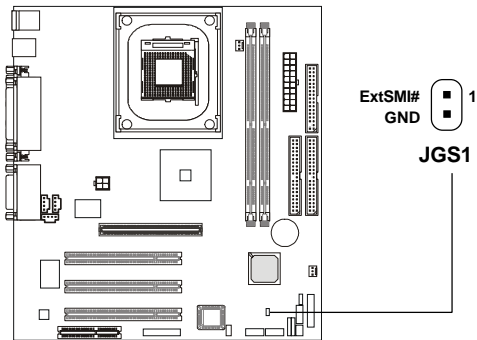

Wake On LAN Connector: JWOL1

This connector allows you to connect to a LAN card with Wake On LAN function. You can wake up the computer via remote control through a local area network.

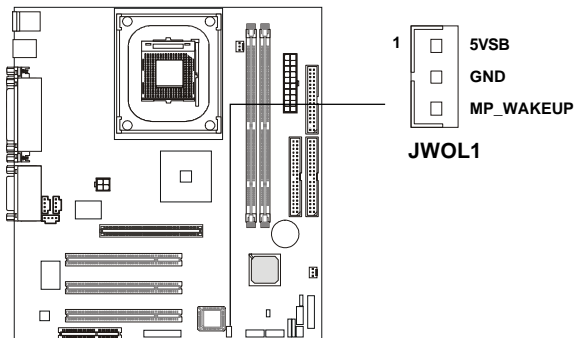

Chapter 2

Wake On Ring Connector: JMDM1 (Optional)

This connector allows you to connect to a modem card with Wake On Ring function. The connector will power up the system when a signal is received through the modem card.

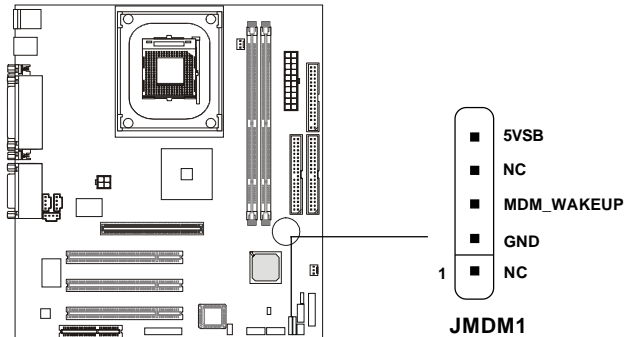

Note: Modem wake-up signal is active “low”.

IrDA Infrared Module Connectors: IR1 & IR2

These connectors allow you to connect to IrDA Infrared modules. You must configure the setting through the BIOS setup to use the IR function. The difference between IR1 & IR2 is that **IR2 is compliant to Intel Front Panel I/O Connectivity Design Guide.**

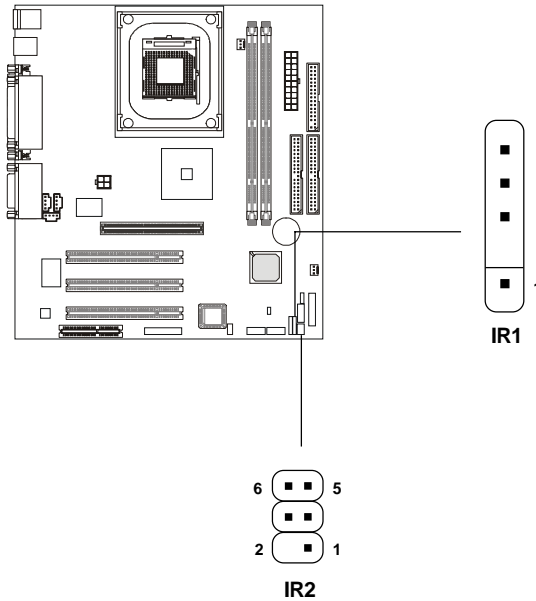

IR2 Pin Definition

Pin	Signal
1	Not assigned
2	NC
3	VCC
4	GND
5	IRTX
6	IRRX

IR1 Pin Definition

Pin	Signal
1	VCC
2	NC
3	IRRX
4	GND
5	IRTX

Chapter 2

Fan Power Connectors: C_FAN1/S_FAN1

The C_FAN1 (processor fan) and S_FAN1 (system fan) support system cooling fan with +12V. It supports three-pin head connector. When connecting the wire to the connectors, always take note that the red wire is the positive and should be connected to the +12V, the black wire is Ground and should be connected to GND. If the mainboard has a System Hardware Monitor chipset on-board, you must use a specially designed fan with speed sensor to take advantage of the CPU fan control.

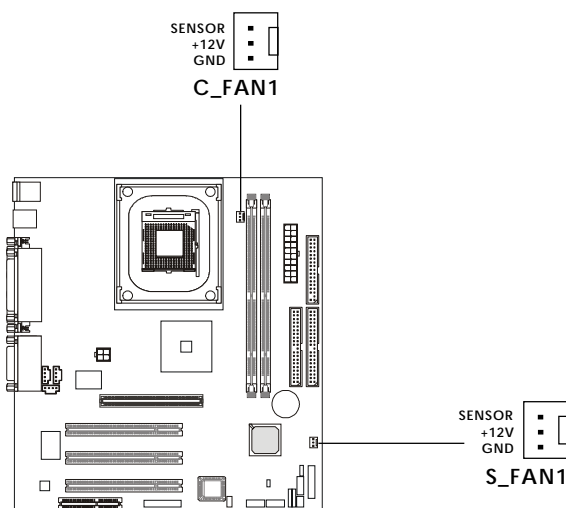

Note:

1. Always consult the vendor for proper CPU cooling fan.
2. CPU Fan supports the fan control. You can install the PC Alert utility that will automatically control the CPU Fan speed according to the actual CPU temperature.

CD-In/Aux Line-In/Modem-In Connector: CD_IN1/AUX_IN1/MDM_IN1

CD_IN1 connector is for CD-ROM audio connector.

AUX_IN1 connector is for DVD add-on card with Line-in connector.

MDM_IN1 connector is for modem with internal audio connector.

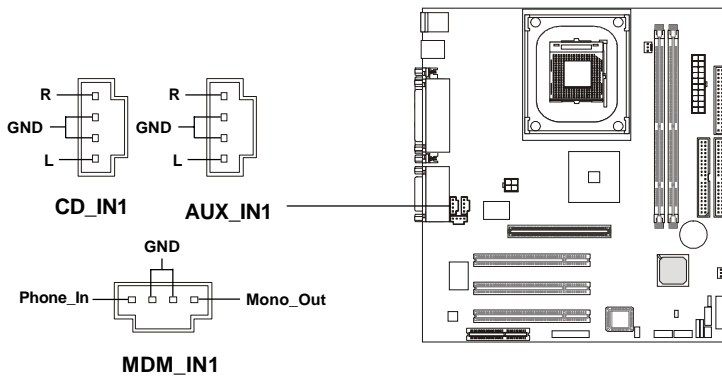

Note:

Mono_Out is connected to the Modem speaker-out connector.

Phone_In is connected to the Modem Microphone-In connector.

Chapter 2

USB Front Panel Connectors: USB1 & USB2

The mainboard provides two Front USB (Universal Serial Bus) pin headers that allow you to connect optional USB ports for front panel. Different from USB1, **USB2 is compliant to Intel Front Panel I/O Connectivity Design Guide.**

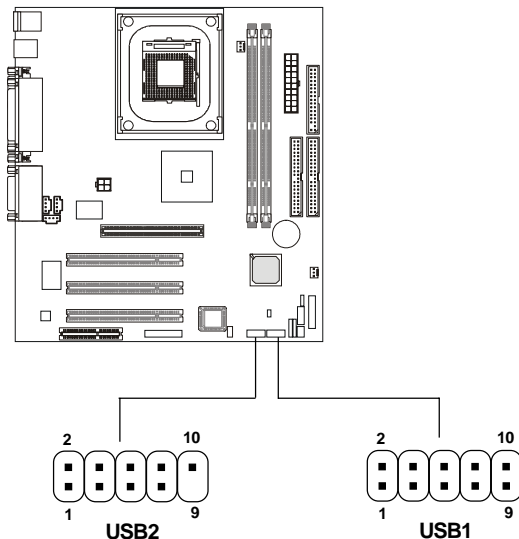

USB2 Pin Definition

Pin	Description	Pin	Description
1	VCC	2	VCC
3	USB3-	4	USB2-
5	USB3+	6	USB2+
7	GND	8	GND
9	NC	10	*USB_FP_OC0

*USB_FP_OC0 is Front Panel USB Overcurrent signal (Ports 2 & 3)

USB1 Pin Definition

Pin	Description	Pin	Description
1	VCC	2	GND
3	USB2-	4	GND
5	USB2+	6	USB3+
7	GND	8	USB3-
9	GND	10	VCC



Note:

You can use only **ONE** USB header to connect USB ports. Make sure you choose the appropriate one for your USB ports.

Front Panel Audio Connector: JAUDIO1

You can connect an optional audio connector to the Front Panel Audio Header. Pin number *1 to 10* of the audio pin header is **compliant to Intel Front Panel I/O Connectivity Design Guide**.

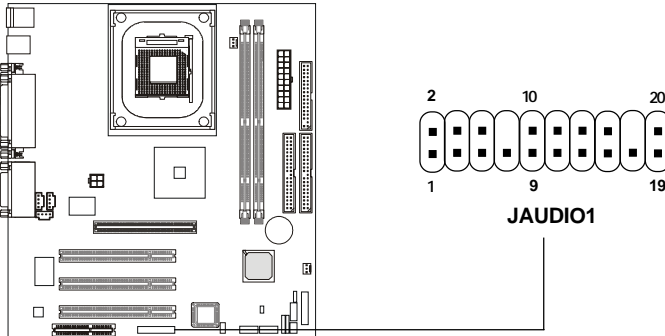

JAUDIO1 Pin Definition (1~10)

Pin	Signal	Description
1	AUD_MIC	Front Panel Microphone input signal
2	AUD_GND	Ground used by Analog Audio Circuits
3	AUD_MIC_BIAS	Microphone Power
4	AUD_VCC	Filtered +5V used by Analog Audio Circuits
5	AUD_FPOUT_R	Right Channel Audio signal to Front Panel
6	AUD_RET_R	Right Channel Audio signal Return from Front Panel
7	HP_ON	RSVD for future use to control Headphone Amplifier
8	NC	No Connection
9	AUD_FPOUT_L	Left Channel Audio signal to Front Panel
10	AUD_RET_L	Left Channel Audio signal Return from Front Panel

JAUDIO1 Pin Definition (11~20)

Pin	Signal	Description
11	AUD_MIC	Front Panel Microphone input signal
12	AUD_GND	Ground used by Analog Audio Circuits
13	AUD_FPOUT_R	Right Channel Audio signal to Front Panel
14	AUD_RET_R	Right Channel Audio signal Return from Front Panel
15	AUD_FPOUT_L	Left Channel Audio signal to Front Panel
16	AUD_RET_L	Left Channel Audio signal Return from Front Panel
17	AUD_GND	Ground used by Analog Audio Circuits
18	NC	No Connection
19	LINE-IN-R	Line in Right
20	LINE-IN-L	Line in Left

Chapter 2

Jumpers

The motherboard provides jumpers for you to set the computer's function. This section will explain how to change your motherboard's function through the use of jumpers.

Clear CMOS Jumper: JBAT1

There is a CMOS RAM on board that has a power supply from external battery to keep the data of system configuration. With the CMOS RAM, the system can automatically boot OS every time it is turned on. If you want to clear the system configuration, use the JBAT1 (Clear CMOS Jumper) to clear data. Follow the instructions below to clear the data:

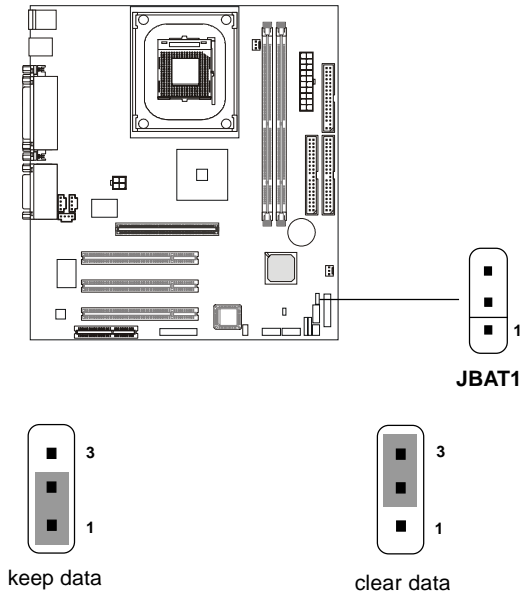

	<p><i>You can clear CMOS by shorting 2-3 pin while the system is off. Then return to 1-2 pin position. Avoid clearing the CMOS while the system is on; it will damage the mainboard.</i></p>
WARNING!	

Slots

The motherboard provides three 32-bit Master PCI Bus Slots, one AGP and one CNR slot.

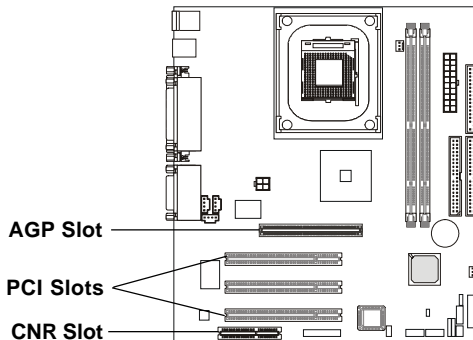

AGP (Accelerated Graphics Port) Slot

The AGP slot allows you to insert the AGP **1.5V** graphics card. AGP is an interface specification designed for the throughput demands of 3D graphics. It introduces a 66MHz, 32-bit channel for the graphics controller to directly access main memory and provides three levels of throughputs: 1x (266Mbps), 2x (533Mbps) and 4x (1.07Gbps).

PCI Slots

Three PCI slots allow you to insert the expansion cards to meet your needs. When adding or removing expansion cards, make sure that you unplug the power supply first. Meanwhile, read the documentation for the expansion card to make any necessary hardware or software settings for the expansion card, such as jumpers, switches or BIOS configuration.

CNR (Communication Network Riser) Slot

The CNR slot allows you to insert the CNR expansion cards. CNR is a specially designed network, audio, or modem riser card for ATX family motherboards. Its main processing is done through software and controlled by the motherboard's chipset.

Chapter 2

PCI Interrupt Request Routing

The IRQ, abbreviation of interrupt request line and pronounced I-R-Q, are hardware lines over which devices can send interrupt signals to the microprocessor. The “AGP/PCI/USB/AC’97 codec” IRQ pins are typically connected to the PCI bus INTA#-INTH# pins as follows:

	Order 1	Order 2	Order 3	Order 4
AGP	INT A#	INT B#		
PCI Slot 1	INT A#	INT B#	INT C#	INT D#
PCI Slot 2	INT B#	INT C#	INT D#	INT A#
PCI Slot 3	INT C#	INT D#	INT A#	INT B#
USB-1	INT D#			
USB-2	INT H#			
AC97	INT B#			

AGP & PCI Slot 1 shared.

PCI Slot 2 & AC97 shared.

PCI Slot 1~3: Bus Master

AWARD® BIOS Setup

3

If your motherboard comes with the AWARD® BIOS ROM, read this chapter for an overview of the Award® BIOS settings. AWARD® BIOS ROM provides a Setup utility for users to modify the basic system configuration. The information is stored in a battery-backed CMOS RAM so it retains the Setup information when the power is turned off.

The chapter contains the following topics:

Entering Setup	3-2
Control Keys	3-2
Getting Help	3-3
The Main Menu	3-4
Standard CMOS Features	3-6
Advanced BIOS Features	3-9
Advanced Chipset Features	3-13
Integrated Peripherals	3-15
Power Management Setup	3-19
PnP/PCI Configurations	3-23
PC Health Status	3-25
Frequency/Voltage Control	3-26
Load Fail-Safe/Optimized Defaults	3-28
Set Supervisor/User Password	3-30
Save & Exit Setup	3-32
Exit Without Saving	3-33

Chapter 3

Entering Setup

Power on the computer and the system will start POST (Power On Self Test) process. When the message below appears on the screen, press key to enter Setup.

Hit DEL if you want to run SETUP

If the message disappears before you respond and you still wish to enter Setup, restart the system by turning it OFF and On or pressing the RESET button. You may also restart the system by simultaneously pressing <Ctrl>, <Alt>, and <Delete> keys.

Control Keys

<↑>	Move to the previous item
<↓>	Move to the next item
<←>	Move to the item in the left hand
<→>	Move to the item in the right hand
<Enter>	Select the item
<Esc>	Jumps to the Exit menu or returns to the main menu from a submenu
<+/PU>	Increase the numeric value or make changes
<-/PD>	Decrease the numeric value or make changes
<F1>	General help, only for Status Page Setup Menu and Option Page Setup Menu
<F5>	Restore the previous CMOS value from CMOS, only for Option Page Setup Menu
<F6>	Load the default CMOS value from Fail-Safe default table, only for Option Page Setup Menu
<F7>	Load Optimized defaults, only for Option Page Setup Menu
<F10>	Save all the CMOS changes and exit

Getting Help

After entering the Setup utility, the first screen you see is the Main Menu.

Main Menu

The main menu displays the setup categories the BIOS supplies. You can use the up/down arrow keys (↑↓) to select the item. The on-line description for the selected setup category is displayed on the bottom of the screen.

Sub-Menu

If you find a right pointer symbol appears to the left of certain fields (as shown in the right view), that means a sub-menu containing additional options for the field can be launched from this field. To enter the sub-menu, highlight the field and press <Enter>. Then you can use control keys to move between and change the settings of the sub-menu. To return to the main menu, press <Esc>.

- ▶ IDE Primary Master
- ▶ IDE Primary Slave
- ▶ IDE Secondary Master
- ▶ IDE Secondary Slave

General Help <F1>

The BIOS setup program provides a General Help screen. You can call up this screen from any menu by simply pressing <F1>. The Help screen lists the appropriate keys to use and the possible selections for the highlighted item. Press <Esc> to exit the Help screen.

Chapter 3

The Main Menu

Once you enter AWARD® BIOS CMOS Setup Utility, the Main Menu will appear on the screen. The Main Menu displays twelve configurable functions and two exit choices. Use arrow keys to move among the items and press <Enter> to enter the sub-menu.

CMOS Setup Utility - Copyright(C) 1984-2001 Award Software	
▸ Standard CMOS Features	▸ Frequency/Voltage Control
▸ Advanced BIOS Features	Load Fail-Safe Defaults
▸ Advanced Chipset Features	Load Optimized Defaults
▸ Integrated Peripherals	Set Supervisor Password
▸ Power Management Setup	Set User Password
▸ PnP/PCI Configurations	Save & Exit Setup
▸ PC Health Status	Exit Without Saving
Esc : Quit F9 : Menu in BIOS ↑↓→← : Select Item	
F10 : Save & Exit Setup	
Time, Date, Hard Disk Type...	

Standard CMOS Features

Use this menu for basic system configurations, such as time, date etc.

Advanced BIOS Features

Use this menu to setup the items of Award® special enhanced features.

Advanced Chipset Features

Use this menu to change the values in the chipset registers and optimize your system's performance.

Integrated Peripherals

Use this menu to specify your settings for integrated peripherals.

Power Management Setup

Use this menu to specify your settings for power management.

PnP/PCI Configurations

This entry appears if your system supports PnP/PCI.

PC Health Status

This entry displays the current status of your PC.

Frequency/Voltage Control

Use this menu to specify your settings for frequency/voltage control.

Load Fail-Safe Defaults

Use this menu to load the BIOS default values for the minimal/stable performance of your PC.

Load Optimized Defaults

Use this menu to load the default factory settings for BIOS for optimal system performance.

Set Supervisor Password

Use this menu to set Supervisor Password.

Set User Password

Use this menu to set User Password.

Save & Exit Setup

Save changes to CMOS and exit setup.

Exit Without Saving

Abandon all changes and exit setup.

Chapter 3

Standard CMOS Features

The items inside Standard CMOS Features menu are divided into 13 categories. Each category includes none, one or more setup items. Use the arrow keys to highlight the item you want to modify and use the <PgUp> or <PgDn> keys to switch to the value you prefer.

CMOS Setup Utility - Copyright (C) 1984-2001 Award Software
Standard CMOS Features

Date (mm:dd:yy) Time (hh:mm:ss)	Wed, Aug 1 2001 00:00:00	Item Help
▶ IDE Primary Master ▶ IDE Primary Slave ▶ IDE Secondary Master ▶ IDE Secondary Slave		Menu Level ▶ Change the day, month, year and century
Drive A Drive B	[1.44M, 3.5 in.] [None]	
Video Halt On	[EGA/VGA] [All, But Keyboard]	
Base Memory Extended Memory Total Memory	640K 65472K 66112K	
↑↓←→:Move Enter:Select +/-/PU/PD:Value F10:Save ESC:Exit F1:General Help F5:Previous Values F6:Fail-Safe Defaults F7:Optimized Defaults		

Date

This allows you to set the system to the date that you want (usually the current date). The format is <day><month> <date> <year>.

- day** Day of the week, from Sun to Sat, determined by BIOS. Read-only.
- month** The month from Jan. through Dec.
- date** The date from 1 to 31 can be keyed by numeric function keys.
- year** The year can be adjusted by users.

Time

This allows you to set the system time that you want (usually the current time). The time format is <hour> <minute> <second>.

IDE Primary Master/Primary Slave/Secondary Master/Secondary Slave

Press PgUp/<+> or PgDn/<-> to select the hard disk drive type. The specification of hard disk drive will show up on the right hand according to your selection.

IDE Primary Master		Item Help
IDE HDD Auto-Detection	Press Enter	
IDE Primary Master Access Mode	[Auto] [Auto]	Menu Level ▶ ▶
Capacity	15021MB	To auto-detect the HDD's size, head...on this channel
Cylinder	291024	
Head	16	
Precomp	0	
Landing Zone	29103	
Sector	63	

- Access Mode The settings are Auto, CHS, LBA and Large.
- Capacity The formatted size of the storage device.
- Cylinder Number of cylinders.
- Head Number of heads.
- Precomp Write precompensation cylinder.
- Landing Zone Cylinder location of the landing zone.
- Sector Number of sectors.

Drive A/B

This item allows you to set the type of floppy drives installed. Available options are *None*, *360K, 5.25 in., 1.2M, 5.25 in., 720K, 3.5 in., 1.44M, 3.5 in., 2.88M, 3.5 in.*

Video

The item sets the type of video adapter used for the primary monitor of the system . Available options are *EGA/VGA* , *CGA 40*, *CGA 80* and *MONO*.

Chapter 3

Halt On

The item determines whether the system will stop if an error is detected at boot. Available options are:

<i>All Errors</i>	The system stops when any error is detected.
<i>No Errors</i>	The system doesn't stop for any detected error.
<i>All, But Keyboard</i>	The system doesn't stop for a keyboard error.
<i>All, But Diskette</i>	The system doesn't stop for a disk error.
<i>All, But Disk/Key</i>	The system doesn't stop for either a disk or a keyboard error.

Advanced BIOS Features

CMOS Setup Utility - Copyright (C) 1984-2001 Award Software
Advanced BIOS Features

Anti-Virus Protection	[Disabled]	Item Help
CPU L1 & L2 Cache	[Enabled]	
Quick Boot	[Disabled]	Menu Level ▶ Allows you to choose the VIRUS warning feature for IDE Hard Disk boot sector protection. If this function is enabled and someone attempt to write data into this area, BIOS will show a warning message on screen and alarm beep
1st Boot Device	[Floppy]	
2nd Boot Device	[HDD-0]	
3rd Boot Device	[CDROM]	
Boot Other Device	[Enabled]	
Swap Floppy	[Disabled]	
Seek Floppy	[Disabled]	
Boot Up Num-Lock LED	[On]	
Gate A20 Option	[Fast]	
Typematic Rate Setting	[Disabled]	
X Typematic Rate (Chars/Sec)	6	
X Typematic Delay (Msec)	250	
Security Option	[Setup]	
APIC Mode	[Enabled]	
MPS Version Control For OS	[1.1]	
Boot OS/2 for DRAM > 64MB	[No]	
Hard Disk S.M.A.R.T	[Disabled]	

- Next Page -

Full Screen LOGO Show	[Disabled]	Item Help
		Menu Level ▶
↑↓→←=:Move Enter:Select +/-/PU/PD:Value F10:Save ESC:Exit F1:General Help F5:Previous Values F6:Fail-Safe Defaults F7:Optimized Defaults		

Anti-Virus Protection

The item is to set the Virus Warning feature for IDE Hard Disk boot sector protection. If the function is enabled and any attempt to write data into this area is made, BIOS will display a warning message on screen and beep. Settings: *Disabled* and *Enabled*.

CPU L1 & L2 Cache

The item allows you to turn on or off CPU's L1 and L2 cache. Settings: *Enabled* and *Disabled*.

Chapter 3

Quick Boot

The option speeds up Power On Self Test (POST) after you power on the computer. When setting the item to *Enabled*, BIOS will shorten or skip some check items during POST. Settings: *Enabled* and *Disabled*.

1st/2nd/3rd Boot Device

The items allow you to set the sequence of boot devices where BIOS attempts to load the disk operating system. The settings are:

<i>Floppy</i>	The system will boot from floppy drive.
<i>LS120</i>	The system will boot from LS-120 drive.
<i>HDD-0</i>	The system will boot from the first HDD.
<i>SCSI</i>	The system will boot from the SCSI.
<i>CDROM</i>	The system will boot from the CD-ROM.
<i>HDD-1</i>	The system will boot from the second HDD.
<i>HDD-2</i>	The system will boot from the third HDD.
<i>HDD-3</i>	The system will boot from the fourth HDD.
<i>ZIP100</i>	The system will boot from ATAPI ZIP drive.
<i>LAN</i>	The system will boot from the Network drive.
<i>Disabled</i>	Disable this sequence.

Boot Other Device

Setting the option to *Enabled* allows the system to try to boot from other device if the system fails to boot from the 1st/2nd/3rd boot device.

SwapFloppy

Setting to *Enabled* will swap floppy drives A: and B:.

Seek Floppy

Setting to *Enabled* will make BIOS seek floppy drive A: before booting the system. Settings: *Disabled* and *Enabled*.

Boot Up Num-Lock LED

This item is to set the Num Lock status when the system is powered on. Setting to *On* will turn on the Num Lock key when the system is powered on. Setting to *Off* will allow end users to use the arrow keys on the numeric keypad. Settings: *On* and *Off*.

Gate A20 Option

This item is to set the Gate A20 status. A20 refers to the first 64KB of extended memory. When *Fast* is selected, the Gate A20 is controlled by Port92 or chipset specific method resulting in faster system performance. When *Normal* is selected, A20 is controlled by a keyboard controller or chipset hardware.

Typematic Rate Setting

This item is used to enable or disable the typematic rate setting including Typematic Rate & Typematic Delay.

Typematic Rate (Chars/Sec)

After **Typematic Rate Setting** is enabled, this item allows you to set the rate (characters/second) at which the keys are accelerated. Settings: *6, 8, 10, 12, 15, 20, 24* and *30*.

Typematic Delay (Msec)

This item allows you to select the delay between when the key was first pressed and when the acceleration begins. Settings: *250, 500, 750* and *1000*.

Security Option

This specifies the type of BIOS password protection that is implemented. Settings are described below:

Option	Description
<i>Setup</i>	The password prompt appears only when end users try to run Setup.
<i>System</i>	A password prompt appears every time when the computer is powered on or when end users try to run Setup.

APICMode

This field is used to enable or disable the APIC (Advanced Programmable Interrupt Controller). Due to compliance to PC2001 design guide, the system is able to run in APIC mode. Enabling APIC mode will expand available IRQs resources for the system. Settings: *Enabled* and *Disabled*.

Chapter 3

MPS Version Control For OS

This field allows you to select which MPS (Multi-Processor Specification) version to be used for the operating system. You need to select the MPS version supported by your operating system. To find out which version to use, consult the vendor of your operating system. Settings: *1.4* and *1.1*.

Boot OS/2 for DRAM > 64MB

This allows you to run the OS/2[®] operating system with more than 64MB DRAM. When you choose *No*, you cannot run the OS/2[®] operating system with more than 64MB DRAM. But it is possible if you choose *Yes*.

Hard Disk S.M.A.R.T.

This allows you to activate the S.M.A.R.T. (Self-Monitoring Analysis & Reporting Technology) capability for the hard disks. S.M.A.R.T is a utility that monitors your disk status to predict hard disk failure. This gives you an opportunity to move data from a hard disk that is going to fail to a safe place before the hard disk becomes offline. Settings: *Enabled* and *Disabled*.

Full Screen LOGO Show

This item enables you to show the company logo on the bootup screen.

Settings are:

<i>Disabled</i>	Shows the POST messages at boot.
<i>Enabled</i>	Shows a still image (logo) on the full screen at boot.

Advanced Chipset Features

CMOS Setup Utility - Copyright (C) 1984-2001 Award Software
Advanced Chipset Features

Configure DRAM Timing	[By SPD]	Item Help
CAS# Latency	[1.5]	
Precharge Delay	[7]	
RAS# to CAS# Delay	[3]	Menu Level ▸
RAS# Precharge	[3]	
DRAM Data Integrity Mode	[Non-ECC]	
Memory Hole At 15M-16M	[Disabled]	
Delayed Transaction	[Enabled]	
AGP Aperture Size (MB)	[64]	
↑↓→←:Move Enter:Select +/-/PU/PD:Value F10:Save ESC:Exit F1:General Help F5:Previous Values F6:Fail-Safe Defaults F7:Optimized Defaults		



Note: Change these settings only if you are familiar with the chipset.

Configure SDRAM Timing

Selects whether DRAM timing is controlled by the SPD (Serial Presence Detect) EEPROM on the DRAM module. Setting to *By SPD* enables CAS# Latency, RAS# Precharge, RAS# to CAS# Delay and RAS# Precharge automatically to be determined by BIOS based on the configurations on the SPD. Selecting *By Manual* allows users to configure these fields manually.

CAS# Latency

This controls the timing delay (in clock cycles) before SDRAM starts a read command after receiving it. Settings: 1.5, 2, 2.5 and 3 (clocks). 1.5 (clocks) increases the system performance the most while 3 (clocks) provides the most stable performance.

Precharge Delay

The field specifies the idle cycles before precharging an idle bank. Settings: 7, 6 and 5 (clocks).

Chapter 3

RAS# to CAS# Delay

This field allows you to set the number of cycles for a timing delay between the CAS and RAS strobe signals, used when DRAM is written to, read from or refreshed. Fast speed offers faster performance while slow speed offers more stable performance. Settings: 3 and 2 (clocks).

RAS# Precharge

This item controls the number of cycles for Row Address Strobe (RAS) to be allowed to precharge. If insufficient time is allowed for the RAS to accumulate its charge before DRAM refresh, refresh may be incomplete and DRAM may fail to retain data. This item applies only when synchronous DRAM is installed in the system. Available settings: 3 and 2 (clocks).

DRAM Data Integrity Mode

Select *ECC* (Error-Correcting Code) or *Non-ECC* according to the type of installed DRAM.

Memory Hole At 15M-16M

In order to improve performance, certain space in memory can be reserved for ISA peripherals. This memory must be mapped into the memory space below 16MB. When this area is reserved, it cannot be cached. Settings: *Enabled* and *Disabled*.

Delayed Transaction

The chipset has an embedded 32-bit posted write buffer to support delayed transactions cycles so that transactions to and from the ISA bus are buffered and PCI bus can perform other transactions while the ISA transaction is underway. Select *Enabled* to support compliance with PCI specification version 2.1. Settings: *Enabled* and *Disabled*.

AGP Aperture Size (MB)

The item is used to select the size of Accelerated Graphics Port (AGP) aperture. Aperture is a portion of PCI memory address range dedicated for graphics memory address space. Host cycles that hit the aperture range are forwarded to AGP without any translation. Settings: 4, 8, 16, 32, 64, 128 and 256.

Integrated Peripherals

CMOS Setup Utility - Copyright (C) 1984-2001 Award Software
Integrated Peripherals

On-Chip Primary	PCI IDE	[Enabled]	Item Help
On-Chip Secondary	PCI IDE	[Enabled]	Menu Level ▶
IDE Primary Master	PIO	[Auto]	
IDE Primary Slave	PIO	[Auto]	
IDE Secondary Master	PIO	[Auto]	
IDE Secondary Slave	PIO	[Auto]	
IDE Primary Master	UDMA	[Auto]	
IDE Primary Slave	UDMA	[Auto]	
IDE Secondary Master	UDMA	[Auto]	
IDE Secondary Slave	UDMA	[Auto]	
USB Controller		[Enabled]	
USB Mouse Support		[Disabled]	
USB Keyboard Support		[Disabled]	
Init Display First		[AGP]	
AC'97 Audio		[Auto]	
AC'97 Modem		[Auto]	
Onboard/CNR LAN selection		[Auto]	
IDE HDD Block Mode		[Enabled]	
Floppy Controller		[Enabled]	

- Next Page -

Serial Port A	[3F8/IRQ4]	Item Help
Serial Port B	[2F8/IRQ3]	Menu Level ▶
Serial Port B Mode	[Normal]	
RxD, TxD Active	[Hi, Lo]	
IR Transmission Delay	[Enabled]	
IR Duplex Mode	[Half]	
IR Pin Select	[IR-Rx2Tx2]	
Parallel Port	[378/IRQ7]	
Parallel Port Mode	[ECP]	
EPP Version	[1.7]	
ECP Mode Use DMA	[3]	
Onboard Game Port	[201]	
Onboard Midi Port	[330]	
Midi IRQ Select	[10]	
↑↓→←:Move Enter:Select +/-/PU/PD:Value F10:Save ESC:Exit F1:General Help F5:Previous Values F6:Fail-Safe Defaults F7:Optimized Defaults		

Chapter 3

On-Chip Primary/Secondary PCI IDE

The integrated peripheral controller contains an IDE interface with support for two IDE channels. Choose *Enabled* to activate each channel separately.

IDE Primary/Secondary Master/Slave PIO

The four items allow you to set a PIO (Programmed Input/Output) mode for each of the four IDE devices that the onboard IDE interface supports. Modes 0~4 provide increased performance. In *Auto* mode, BIOS automatically determines the best mode for each IDE device.

IDE Primary/Secondary Master/Slave UDMA

Ultra DMA implementation is possible only if your IDE device supports it and your operating environment contains a DMA driver. If both your hard drive and software support Ultra DMA 66/100, select *Auto* to enable BIOS support.

USB Controller

The item enables or disables the USB (Universal Serial Bus) Ports. Settings: *Enabled* and *Disabled*.

USB Mouse/Keyboard Support

Set to *Enabled* if your need to use an USB mouse/keyboard in the operating system that does not support or have any USB driver installed, such as DOS and SCO Unix.

Init Display First

This item specifies which VGA card is your primary graphics adapter. Settings: *PCI Slot* and *AGP*.

AC'97 Audio

Auto allows the mainboard to detect whether an audio device is used. If the device is detected, the onboard AC'97 (Audio Codec'97) controller will be enabled; if not, it is disabled. Disable the controller if you want to use other controller cards to connect an audio device. Settings: *Auto* and *Disabled*.

AC'97 Modem

Auto allows the mainboard to detect whether a modem is used. If a modem is used, the onboard MC'97 (Modem Codec'97) controller will be enabled; if

not, it is disabled. Disable the controller if you want to use other controller cards to connect to a modem. Settings: *Auto* and *Disabled*.

Onboard/CNR LAN selection

Use the item to enable or disable the onboard or external CNR LAN device. Settings: *Auto*, *Onboard* and *Ext. CNR*.

IDE HDD Block Mode

This allows your hard disk controller to use the fast block mode to transfer data to and from the hard disk drive. Block mode is also called block transfer, multiple commands or multiple sector read/write. *Enabled* enables IDE controller to use block mode; *Disabled* allows the controller to use standard mode.

Floppy Controller

The item is used to enable or disable the onboard Floppy controller. Select *Enabled* when you have installed a floppy disk drive and want to use it.

Serial Port A/B

The items specify the base I/O port address and IRQ for the onboard Serial Port A (COM A)/Serial Port B (COM B). Selecting *Auto* allows BIOS to automatically determine the correct base I/O port address. Settings: *Disabled*, *3F8/IRQ4*, *2F8/IRQ3*, *3E8/IRQ4*, *2E8/IRQ3* and *Auto*.

Serial Port B Mode

The field allows you to specify the operation mode for serial port "COM B". Settings are:

<i>IrDA</i> :	IrDA-compliant Serial Infrared Port
<i>ASKIR</i> :	Amplitude Shift Keyed Infrared Port
<i>Normal</i> :	RS-232C Serial Port

RxD, TxD Active

The item determines the active of RxD, TxD. Settings are "*Hi, Hi*", "*Hi, Lo*", "*Lo, Hi*" and "*Lo, Lo*".

IR Transmission Delay

The field enables or disables IR transmission delay function. Settings: *En-*

Chapter 3

abled and Disabled.

IR Duplex Mode

The field specifies a duplex value for the IR device connected to COM B. Full Duplex mode permits simultaneous two-direction transmission. Half Duplex mode permits transmission in one direction only at a time. Settings: *Half* and *Full*.

IR Pin Select

Consult your IR peripheral documentation to select the correct setting of TxD and RxD signals. Settings: *IR-Rx2Tx2* and *RxD2, TxD2*.

Parallel Port

This specifies the I/O port address and IRQ of the onboard parallel port. Settings: *378/IRQ7*, *278/IRQ5*, *3BC/IRQ7* and *Disabled*.

Parallel Port Mode

This item selects the operating mode for the parallel port: *SPP*, *EPP*, *ECP* or *ECP+EPP*.

EPP Version

The item selects the EPP version used by the parallel port if it is set to *EPP* or *ECP+EPP* mode. Settings: *1.7* and *1.9*.

ECP Mode Use DMA

The item specifies the DMA channel 1 or 3 for the parallel port when it is set to *ECP* or *ECP+EPP* mode.

Onboard Game/Midi Port Address

The items disable or assign the address of the onboard Game/Midi port.

Midi IRQ Select

The item specifies an IRQ for the Midi port.

Power Management Setup

CMOS Setup Utility - Copyright (C) 1984-2001 Award Software
Power Management Setup

IPCA Function	[Enabled]	Item Help
ACPI Standby State	[S1/POS]	
Power Management/APM	[User Define]	
MODEM Use IRQ	[3]	Menu Level ▶
Suspend Time Out	[Disabled]	
Power Button Function	[Power Off]	
Wake Up On PME	[Disabled]	
Wake Up On Ring	[Enabled]	
Wake Up On LAN	[Enabled]	
USB Wakeup From S3	[Disabled]	
CPU THRM-Throttling	[50.0%]	
Resume By RTC Alarm	[Disabled]	
x Date(of Month) Alarm	0	
x Time(hh:mm:ss) Alarm	0 : 0 : 0	
POWER ON Function	[BUTTON ONLY]	
KB Power ON Password	[Enter]	
Hot Key Power ON	[Ctrl-F1]	
Power Again	[Power Off]	
Sleep State LED	[Blinking]	

- Next Page -

** Reload Global Timer Events **		Item Help
Primary Master IDE	[Disabled]	
Primary Slave IDE	[Disabled]	
Secondary Master IDE	[Disabled]	Menu Level ▶
Secondary Slave IDE	[Disabled]	
FDC/LPT/COM Ports	[Disabled]	
↑↓→←:Move Enter:Select +/-/PU/PD:Value F10:Save ESC:Exit F1:General Help F5:Previous Values F6:Fail-Safe Defaults F7:Optimized Defaults		

IPCA Function

This item is to activate the ACPI (Advanced Configuration and Power Management Interface) Function. If your operating system is ACPI-aware, such as Windows 98SE/2000/ME, select *Enabled*. Settings: *Enabled* and *Disabled*.

ACPI Standby State

This item specifies the power saving modes for ACPI function. Options are:

Chapter 3

- S1/POS* The S1 sleep mode is a low power state. In this state, no system context (CPU or chipset) is lost and hardware maintains all system context.
- S3/STR* The S3 sleep mode is a power-down state in which power is supplied only to essential components such as main memory and wake-capable devices and all system context is saved to main memory. The information stored in memory will be used to restore the PC to the previous state when an “wake up” event occurs.

Power Management/APM

This item is used to select the degree (or type) of power saving and is related to the mode: Suspend Time Out. There are three options for power management:

- Min Saving* Minimum Power Management. Suspend Time Out = 1 Hour.
- Max Saving* Maximum Power Management. Suspend Time Out = 1 Min.
- User Define* Allows end users to configure each mode separately.

MODEMUseIRQ

Name the interrupt request (IRQ) line assigned to the modem (if any) on your system. Activity of the selected IRQ always awakens the system. Settings: 3, 4, 5, 7, 9, 10, 11 and NA.

Suspend Time Out

If system activity is not detected for the length of time specified in this field, all devices except CPU will be shut off. Settings are *Disabled, 1 Min, 2 Min, 4 Min, 8 Min, 12 Min, 20 Min, 30 Min, 40 Min* and *1 Hour*.

Power Button Function

This feature allows users to configure the power button function. Settings are:

- Power Off* The power button functions as a normal power-on/off button.
- Suspend* When you press the power button, the computer

enters the suspend/sleep mode, but if the button is pressed for more than four seconds, the computer is turned off.

Wake Up On PME/Ring/LAN, USB Wakeup From S3

These fields specify whether the system will be awakened from power saving modes when activity or input signal of the specified hardware peripheral or component is detected.



Note: To use the function of “Wake Up On Ring” and “Wake Up On LAN”, you need to install a modem/LAN card supporting power on function.

CPU THRM-Throttling

The item allows you to specify the percentage of CPU speed which it will slow down to when the CPU temperature reaches the predetermined over-heat limit. Settings range from 12.5% to 87.5% at 12.5% increment.

Resume By RTC Alarm

The field is used to enable or disable the feature of booting up the system on a scheduled time/date.

Date(of Month) Alarm

The field specifies the date for **Resume By RTC Alarm**. Settings: 0~31.

Time(hh:mm:ss) Alarm

The field specifies the time for **Resume by Alarm**. Format is <hour><minute><second>.

POWER ON Function

This controls which part and how the PS/2 mouse or keyboard can power on the system. Settings: *Password, Hot KEY, Mouse Left, Mouse Right, BUTTON ONLY* and *Keyboard 98*.

KB Power ON Password

If **POWER ON Function** is set to *Password*, then you can set a password in the field for the PS/2 keyboard to power on the system.

Chapter 3

Hot Key Power ON

If **POWER ON Function** is set to *Hot KEY*, you can assign a hot key combination in the field for the PS/2 keyboard to power on the system. Settings: *Ctrl-F1* through *Ctrl-F12*.

Power Again

This item specifies whether your system will reboot after a power failure or interrupt occurs. Available settings are:

<i>Power Off</i>	Leaves the computer in the power off state.
<i>Power On</i>	Reboots the computer.
<i>Last State</i>	Restores the system to the status before power failure or interrupt occurred.

Sleep State LED

This item sets how the system uses Power LED on the case to indicate the suspend state. Settings are:

<i>Dual</i>	The Power LED changes its color to indicate the suspend state.
<i>Blinking</i>	The Power LED blinks to indicate the suspend state.

** Reload Global Timer Events **

Primary/Secondary Master/Slave IDE, FDC/LPT/COM Ports

The global timer is the hardware timer that counts down to the power saving modes. If the monitoring of the listed hardware peripheral or component is enabled, they will awaken the system or reload the original count of global timer when they are accessed.

PnP/PCI Configurations

CMOS Setup Utility - Copyright(C) 1984-2001 Award Software
PnP/PCI Configurations

PNP OS Installed	[No]	Item Help
Reset Configuration Data	[Disabled]	
Resources Controlled By	[Auto(ESCD)]	Menu Level ▶ Select Yes if you are using a Plug and Play capable operating system Select No if you need to BIOS to configure non-boot devices
X IRQ Resources	Press Enter	
X DMA Resources	Press Enter	
PCI/VGA Palette Snoop	[Disabled]	
↑↓→←:Move Enter:Select +/-/PU/PD:Value F10:Save ESC:Exit F1:General Help F5:Previous Values F6:Fail-Safe Defaults F7:Optimized Defaults		

PNP OS Installed

When set to *YES*, BIOS will only initialize the PnP cards used for booting (VGA, IDE, SCSI). The rest of the cards will be initialized by the PnP operating system like Windows® 98. When set to *NO*, BIOS will initialize all the PnP cards. So, select *Yes* if the operating system is Plug & Play aware.

Reset Configuration Data

The ESCD (Extended System Configuration Data) is a method that the BIOS uses to store resource information for both PNP and non PNP devices in a bit string format. When *Enabled*, the system will rebuild ESCD and you will see the message “ESCD Update Successfully” on boot up.

Resources Controlled By

When selecting *Auto(ESCD)*, BIOS will automatically configure all the boot and PnP (Plug & Play) compatible devices and assigns system resources like IRQ to these devices. However, this feature means absolutely nothing unless you are using a Plug and Play operating system such as Windows®

Chapter 3

98. If you want to configure the system by yourself, select *Manual*.

IRQ Resources

This item is adjustable only when **Resources Controlled By** is set to *Manual*. Press <Enter> and you will enter the sub-menu of this item. The item lists IRQ resources and allows you to set each IRQ a type depending on the type of device using the IRQ. Settings: *PCI/ISA PnP* and *Legacy ISA*.



Note: *IRQ (Interrupt Request) lines are system resources allocated to I/O devices. When an I/O device needs to gain attention of the operating system, it signals this by causing an IRQ to occur. After receiving the signal, when the operating system is ready, the system will interrupt itself and perform the service required by the I/O device.*

PCI/VGA Palette Snoop

PCI VGA palette is the set of colors currently used by the video device. Some special VGA cards may not show colors correctly and need to look into the video device's VGA palette to determine what colors are in use. Then you have to turn on the palette "snoop", permitting the palette registers of both VGA devices to be identical. The setting must be set to *Enabled* if any non-standard VGA adapter card, such as MPEG card, installed in the system requires VGA palette snooping.

PC Health Status

This section is to monitor the current hardware status including CPU temperature, CPU Fan speed, Vcore etc. This is available only if there is hardware monitoring mechanism onboard.

CMOS Setup Utility - Copyright(C) 1984-2001 Award Software
PC Health Status

Current System Temp.	32°C/89°F	Item Help
Current CPU Temperature	58°C/132°F	
POWER fan	0RPM	Menu Level ▶
SYSTEM fan	0RPM	
CPU fan	4560RPM	
Vcore	1.66V	
VTT	1.47V	
3.3 V	3.33V	
+5V	5.02V	
+12V	12.05V	
-12V	-11.56V	
-5V	-4.99V	
VBAT(V)	3.22V	
5VSB(V)	4.87V	
CPU Critical Temperature	[Disabled]	
↑↓→←:Move Enter:Select +/-/PU/PD:Value F10:Save ESC:Exit F1:General Help F5:Previous Values F6:Fail-Safe Defaults F7:Optimized Defaults		

Current System Temp., Current CPU Temperature, POWER/SYSTEM/CPU fan, Vcore, VTT, 3.3 V/+ 5V/+12V/-12V/- 5V, VBAT(V), 5VSB(V)

These items display the current status of all monitored hardware devices/ components such as CPU voltages, temperatures and all fans' speeds.

CPU Critical Temperature

This item is used to specify a thermal limit for CPU. If CPU temperature reaches the specified limit, the system will issue a warning and allows you to prevent the CPU overheat problem. Settings: *Disabled, 80°C/176°F, 85°C/185°F* and *90°C/194°F*.

Chapter 3

Frequency/Voltage Control

CMOS Setup Utility - Copyright(C) 1984-2001 Award Software
Frequency/Voltage Control

CPU Ratio Selection	[X 8(Safe)]	Item Help
Auto Detect PCI Clock	[Enabled]	
Spread Spectrum	[+/-0.25%]	
CPU Host/PCI Clock	[Default]	Menu Level ▶
↑↓→←:Move Enter:Select +/-/PU/PD:Value F10:Save ESC:Exit F1:General Help F5:Previous Values F6:Fail-Safe Defaults F7:Optimized Defaults		

CPU Ratio Selection

End users can overclock the processor by specifying the CPU ratio (clock multiplier) in this field. Settings: *x 8(Safe)* to *x 23*.

Auto Detect PCI Clock

This item is used to auto detect the PCI slots. When set to *Enabled*, the system will remove (turn off) clocks from empty PCI slots to minimize the electromagnetic interference (EMI). Settings: *Enabled* and *Disabled*.

Spread Spectrum

This item is used to configure the clock generator's Spread Spectrum feature. Settings: *Disabled*, *+/-0.25%*, *-0.5%*, *+/-0.5%*, and *+/-0.38%*. Always disable the feature when overclocking the processor.

CPU Host/PCI Clock

This item specifies the combination of CPU host bus (FSB) and PCI bus

frequency. It provides end users an overclocking method. Settings: 100/33Mhz and higher frequency combination.

Chapter 3

Load Fail-Safe/Optimized Defaults

The two options on the main menu allow users to restore all of the BIOS settings to the default Fail-Safe or Optimized values. The Optimized Defaults are the default values set by the mainboard manufacturer specifically for the optimal performance of the mainboard. The Fail-Safe Defaults are the default values set by the BIOS vendor for the stable system performance.

When you select Load Fail-Safe Defaults, a message as below appears:

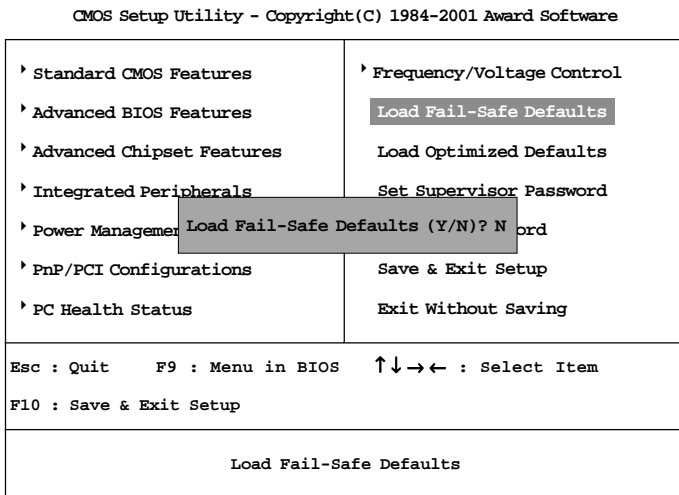

Pressing Y loads the BIOS default values for the most stable, minimal system performance.

When you select Load Optimized Defaults, a message as below appears:

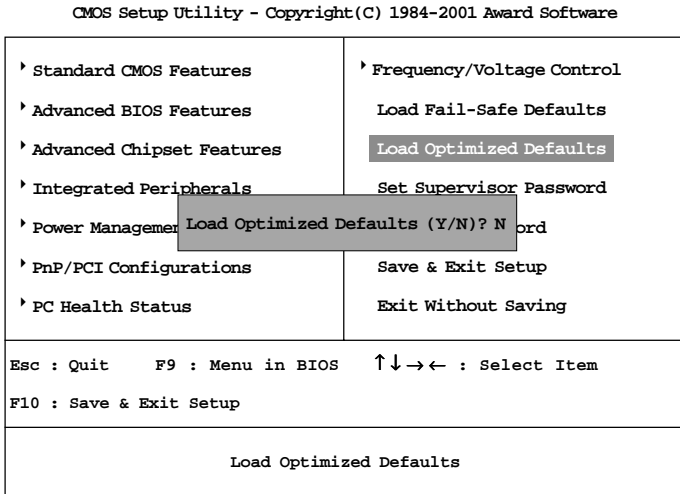

Pressing Y loads the default factory settings for optimal system performance.

Chapter 3

Set Supervisor/User Password

When you select this function, a message as below will appear on the screen:

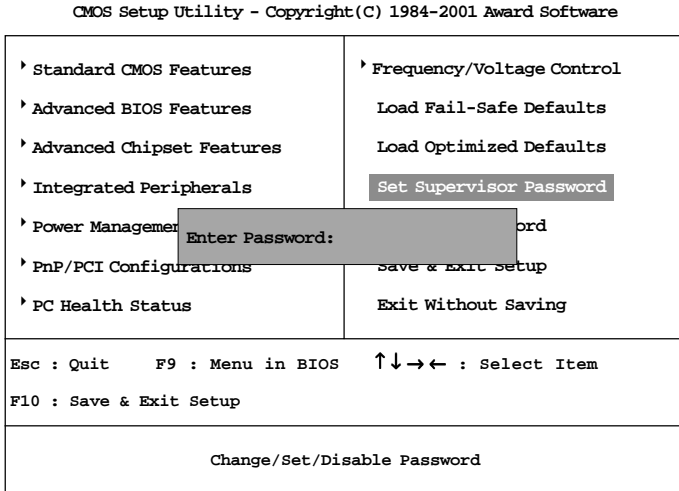

Type the password, up to eight characters in length, and press <Enter>. The password typed now will replace any previously set password from CMOS memory. You will be prompted to confirm the password. Re-type the password and press <Enter>. You may also press <Esc> to abort the selection and not enter a password.

To clear a set password, just press <Enter> when you are prompted to enter the password. A message will show up confirming the password will be disabled. Once the password is disabled, the system will boot and you can enter Setup without entering any password.

When a password has been set, you will be prompted to enter it every time you try to enter Setup. This prevents an unauthorized person from changing any part of your system configuration.

Additionally, when a password is enabled, you can also have BIOS to request a password each time the system is booted. This would prevent unauthorized

use of your computer. The setting to determine when the password prompt is required is the Security Option in the Advanced BIOS Features menu. If the Security Option is set to *System*, the password is required both at boot and at entry to Setup. If set to *Setup*, password prompt only occurs when trying to enter Setup.

About Supervisor Password & User Password:



Supervisor password : Can enter and change the settings of the setup menu.

User password: Can only enter but do not have the right to change the settings of the setup menu.

Chapter 3

Save & Exit Setup

When you want to quit the Setup menu, you can select this option to save the changes and quit. A message as below will appear on the screen:

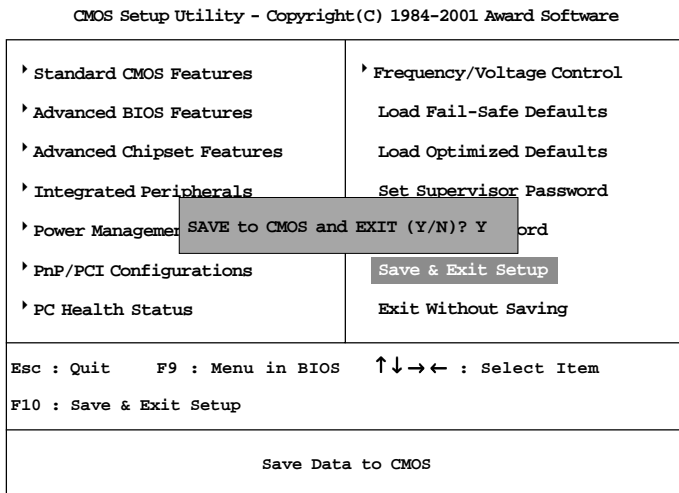

Typing *Y* will allow you to quit the Setup Utility and save the user setup changes to RTC CMOS.

Typing *N* will return to the Setup Utility.

Exit Without Saving

When you want to quit the Setup menu, you can select this option to abandon the changes. A message as below will appear on the screen:

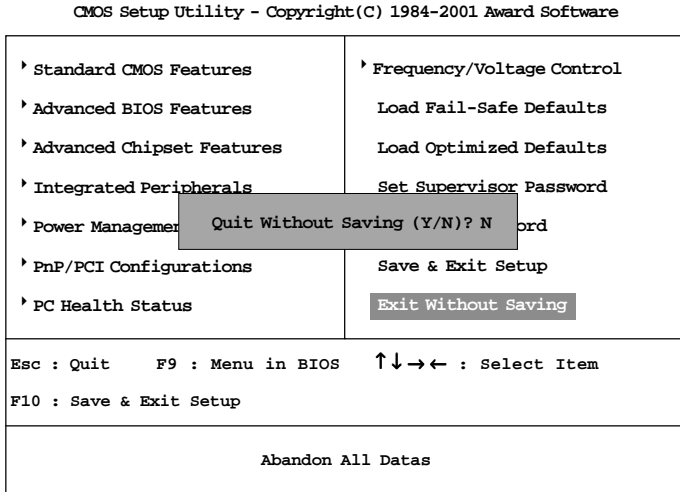

Typing *Y* will allow you to quit the Setup Utility without saving any changes to RTCCMOS.

Typing *N* will return to the Setup Utility.

AMI® BIOS Setup

4

If your motherboard comes with the AMI® BIOS ROM, read this chapter for an overview of the AMI® BIOS settings. AMI® BIOS ROM provides a Setup utility for users to modify the basic system configuration. The information is stored in a battery-backed CMOS RAM so it retains the Setup information when the power is turned off.

The chapter contains the following topics:

Entering Setup	4-2
Selecting the First Boot Device	4-2
Control Keys	4-3
Getting Help	4-4
The Main Menu	4-5
Standard CMOS Setup	4-7
BIOS Features Setup	4-9
Chipset Features Setup	4-12
Power Management Setup	4-14
PNP/PCI Configurations	4-18
Integrated Peripherals	4-20
Hardware Monitor Setup	4-24
Load Optimal/Fail Safe Defaults	4-26
Supervisor/User Password	4-28
IDE HDD AUTO Detection	4-30
Save & Exit Setup	4-31
Exit Without Saving	4-32

Chapter 4

Entering Setup

Power on the computer and the system will start POST (Power On Self Test) process. When the message below appears on the screen, press key to enter Setup.

DEL:Setup F11:Boot Menu F12:Network boot TAB:Logo

If the message disappears before you respond and you still wish to enter Setup, restart the system by turning it OFF and On or pressing the RESET button. You may also restart the system by simultaneously pressing <Ctrl>, <Alt>, and <Delete> keys.

Selecting the First Boot Device

You are allowed to select the 1st boot device without entering the BIOS setup utility by pressing <F11>. When the same message as listed above appears on the screen, press <F11> to trigger the boot menu.

The POST messages might pass too quickly for you to respond in time. If so, restart the system and press <F11> after around 2 or 3 seconds to activate the boot menu similar to the following.

Select First Boot Device	
Floppy	: 1st Floppy
IDE-0	: IBM-DTLA-307038
CDROM	: ATAPI CD-ROM DRIVE 40X M
[Up/Dn] Select	[RETURN] Boot [ESC] cancel

The boot menu will list all the bootable devices. Select the one you want to boot from by using arrow keys and then pressing <Enter>. The system will boot from the selected device. The selection will not make changes to the settings in the BIOS setup utility, so next time when you power on the system, it will still use the original first boot device to boot up.

Control Keys

<↑>	Move to the previous item
<↓>	Move to the next item
<←>	Move to the item in the left hand
<→>	Move to the item in the right hand
<Enter>	Select the item
<Esc>	Jumps to the Exit menu or returns to the main menu from a submenu
<+/PU>	Increase the numeric value or make changes
<-/PD>	Decrease the numeric value or make changes
<F5>	Restore the previous CMOS value from CMOS, only for Option Page Setup Menu
<F6>	Load the default CMOS value from Fail-Safe default table, only for Option Page Setup Menu
<F7>	Load BIOS Setup defaults
<F10>	Save all the CMOS changes and exit

Chapter 4

Getting Help

After entering the Setup utility, the first screen you see is the Main Menu.

Main Menu

The main menu displays the setup categories the BIOS supplies. You can use the arrow keys (↑↓) to select the item. The on-line description for the selected setup category is displayed on the bottom of the screen.

General Help <F1>

The BIOS setup program provides a General Help screen. You can call up this screen by simply pressing <F1>. The Help screen lists the appropriate keys to use. To exit the Help screen, press <Esc>.

Default Settings

The BIOS setup program contains two kinds of default settings: the Optimal and Fail Safe defaults. Optimal defaults provide optimum performance settings for all devices and the system. Fail Safe defaults provide stable but minimal system performance.

The Main Menu

Once you enter AMIBIOS SIMPLE SETUP UTILITY, the Main Menu will appear on the screen. The Main Menu displays twelve configurable functions and two exit choices. Use arrow keys to move among the items and press <Enter> to enter the sub-menu.

AMIBIOS SIMPLE SETUP UTILITY - VERSION 1.41 (C)1999 American Megatrends, Inc. All Rights Reserved	
STANDARD CMOS SETUP BIOS FEATURES SETUP CHIPSET FEATURES SETUP POWER MANAGEMENT SETUP PNP/PCI CONFIGURATION INTEGRATED PERIPHERALS HARDWARE MONITOR SETUP	LOAD OPTIMAL DEFAULTS LOAD FAIL SAFE DEFAULTS SUPERVISOR PASSWORD USER PASSWORD IDE HDD AUTO DETECTION SAVE & EXIT SETUP EXIT WITHOUT SAVING
ESC : Quit ↑↓←→ : Select Item (Shift)F2 : Change Color F5 : Old Values F7 : Load Fail Safe Defaults F10 : Save & Exit	
Time, Date, Hard Disk Type,...	

Standard CMOS Setup

Use this menu for basic system configurations, such as time, date etc.

BIOS Features Setup

Use this menu to setup the items of AMI® special enhanced features.

Chipset Features Setup

Use this menu to change the values in the chipset registers and optimize your system's performance.

Power Management Setup

Use this menu to specify your settings for power management.

Chapter 4

PNP/PCI Configuration

This entry appears if your system supports PnP/PCI.

Integrated Peripherals

Use this menu to specify your settings for integrated peripherals.

Hardware Monitor Setup

This entry shows your PC's current status, and allows you to adjust CPU clock etc. The hardware monitoring data appears only if your motherboard comes with the Hardware Monitor chipset installed.

Load Optimal Defaults

Use this menu to load the default factory settings for BIOS for optimal system performance.

Load Fail Safe Defaults

Use this menu to load the BIOS default values for the minimal/stable performance of your PC.

Supervisor Password

Use this menu to set Supervisor Password.

User Password

Use this menu to set User Password.

Save & Exit Setup

Save changes to CMOS and exit setup.

Exit Without Saving

Abandon all changes and exit setup.

Standard CMOS Setup

The items inside STANDARD CMOS SETUP menu are divided into 9 categories. Each category includes none, one or more setup items. Use the arrow keys to highlight the item you want to modify and use the <PgUp> or <PgDn> key to switch to the value you prefer.

AMBIOS SETUP - STANDARD CMOS SETUP (C)1999 American Megatrends, Inc. All Rights Reserved																																									
Date (mm/dd/yyyy) : Thu Aug 02, 2001 Time (hh/mm/ss) : 00:00:00																																									
	<table border="1"> <thead> <tr> <th>TYPE</th> <th>SIZE</th> <th>CYLS</th> <th>HEAD</th> <th>PRECOMP</th> <th>LANDZ</th> <th>SECTOR</th> <th>MODE</th> </tr> </thead> <tbody> <tr> <td>Pri Master</td> <td>: AUTO</td> <td></td> <td></td> <td></td> <td></td> <td></td> <td></td> </tr> <tr> <td>Pri Slave</td> <td>: AUTO</td> <td></td> <td></td> <td></td> <td></td> <td></td> <td></td> </tr> <tr> <td>Sec Master</td> <td>: AUTO</td> <td></td> <td></td> <td></td> <td></td> <td></td> <td></td> </tr> <tr> <td>Sec Slave</td> <td>: AUTO</td> <td></td> <td></td> <td></td> <td></td> <td></td> <td></td> </tr> </tbody> </table>	TYPE	SIZE	CYLS	HEAD	PRECOMP	LANDZ	SECTOR	MODE	Pri Master	: AUTO							Pri Slave	: AUTO							Sec Master	: AUTO							Sec Slave	: AUTO						
TYPE	SIZE	CYLS	HEAD	PRECOMP	LANDZ	SECTOR	MODE																																		
Pri Master	: AUTO																																								
Pri Slave	: AUTO																																								
Sec Master	: AUTO																																								
Sec Slave	: AUTO																																								
Floppy Drive A : 1.44 MB 3½ Floppy Drive B : Not Installed	<table border="1"> <tbody> <tr> <td>Base Memory : 640 Kb Other Memory : 384 Kb Extended Memory : 127 Mb Total Memory : 128 Mb</td> </tr> </tbody> </table>	Base Memory : 640 Kb Other Memory : 384 Kb Extended Memory : 127 Mb Total Memory : 128 Mb																																							
Base Memory : 640 Kb Other Memory : 384 Kb Extended Memory : 127 Mb Total Memory : 128 Mb																																									
Boot Sector Virus Protection Disabled																																									
Month: Jan - Dec Day: 01 - 31 Year: 1901 - 2099	ESC : Exit ↑↓ : Select Item PU/PD/+/- : Modify (Shift) F2 : Color																																								

Date

This allows you to set the system to the date that you want (usually the current date). The format is <day><month> <date> <year>.

- day** Day of the week, from Sun to Sat, determined by BIOS. Read-only.
- month** The month from Jan. through Dec.
- date** The date from 1 to 31 can be keyed by numeric function keys.
- year** The year can be adjusted by users.

Time

This allows you to set the system time that you want (usually the current time). The time format is <hour> <minute> <second>.

Chapter 4

Pri Master/Pri Slave/Sec Master/Sec Slave

Press PgUp/<+> or PgDn/<-> to select the hard disk drive type. The specification of hard disk drive will show up on the right hand according to your selection.

TYPE	Type of the device.
SIZE	Capacity of the device.
CYLS	Number of cylinders.
HEAD	Number of heads.
PRECOMP	Write precompensation cylinder.
LANDZ	Cylinder location of Landing zone.
SECTOR	Number of sectors.
MODE	Access mode.

Floppy Drive A/B

This item allows you to set the type of floppy drives installed. Available options: *Not Installed*, *360 KB 5¼*, *1.2 MB 5¼*, *720 KB 3½*, *1.44 MB 3½* and *2.88MB 3½*.

Boot Sector Virus Protection

The item is to set the Virus Warning feature for IDE Hard Disk boot sector protection. When *Enabled*, BIOS will issue a virus warning message and beep if a write to the boot sector or the partition table of the HDD is attempted. Setting options: *Disabled* and *Enabled*.



Note: *This feature only protects the boot sector, not the whole hard disk.*

BIOS Features Setup

AMIBIOS SETUP - BIOS FEATURES SETUP (C)1999 American Megatrends, Inc. All Rights Reserved	
Quick Boot	:Enabled
1st Boot Device	:Floppy
2nd Boot Device	:IDE-0
3rd Boot Device	:CDROM
Try Other Boot Devices	:Yes
Full Screen LOGO Show	:Disabled
S.M.A.R.T. for Hard Disks	:Disabled
BootUp Num-Lock	:On
Swap Floppy	:Disabled
Seek Floppy	:Disabled
Password Check	:Setup
Boot OS/2 for DRAM > 64MB	:No
L1 Cache	:Enabled
Flash Protection	:Enabled
System BIOS Cacheable	:Enabled
ESC : Quit ↑↓←→ : Select Item F1 : Help PU/PD/+/- : Modify F5 : Old Values (Shift)F2 : Color F6 : Load BIOS Defaults F7 : Load Setup Defaults	

Quick Boot

Setting the item to *Enabled* allows the system to boot within 5 seconds by skipping some check items. Settings: *Enabled* and *Disabled*.

1st/2nd/3rd Boot Device

The items allow you to set the sequence of boot devices where AMIBIOS attempts to load the operating system. Possible settings are:

- IDE-0* The system will boot from the first HDD.
- IDE-1* The system will boot from the second HDD.
- IDE-2* The system will boot from the third HDD.
- IDE-3* The system will boot from the fourth HDD.
- Floppy* The system will boot from floppy drive.
- ARMD-FDD* The system will boot from any ARMD device, such as LS-120 or ZIP drive, that functions as a floppy drive.
- ARMD-HDD* The system will boot from ARMD device, such as MO or ZIP drive, that functions as hard disk drive.

Chapter 4

<i>CDROM</i>	The system will boot from the CD-ROM.
<i>SCSI</i>	The system will boot from the SCSI.
<i>NETWORK</i>	The system will boot from the Network drive.
<i>BBS-0</i>	The system will boot from the first BBS (BIOS Boot Specification) compliant device.
<i>BBS-1</i>	The system will boot from the second BBS (BIOS Boot Specification) compliant device.
<i>BBS-2</i>	The system will boot from the third BBS (BIOS Boot Specification) compliant device.
<i>BBS-3</i>	The system will boot from the fourth BBS (BIOS Boot Specification) compliant device.
<i>Disabled</i>	Disable this sequence.



Note: Available settings for “1st/2nd/3rd Boot Device” vary depending on the bootable devices you have installed. For example, if you did not install a floppy drive, the setting “Floppy” does not show up.

Try Other Boot Devices

Setting the option to *Yes* allows the system to try to boot from other devices if the system fails to boot from the 1st/2nd/3rd boot device.

Full Screen LOGO Show

This item enables you to show the company logo on the bootup screen.

Settings are:

<i>Disabled</i>	Shows the POST messages at boot.
<i>Enabled</i>	Shows a still image (logo) on the full screen at boot.

S.M.A.R.T. for Hard Disks

This allows you to activate the S.M.A.R.T. (Self-Monitoring Analysis & Reporting Technology) capability for the hard disks. S.M.A.R.T is a utility that monitors your disk status to predict hard disk failure. This gives you an opportunity to move data to a safe place before the hard disk becomes offline. Settings: *Enabled* and *Disabled*.

BootUpNum-Lock

This item is to set the Num Lock status when the system is powered on. Setting to *On* will turn on the Num Lock key when the system is powered on.

Setting to *Off* will allow end users to use the arrow keys on the numeric keypad. Settings: *On* and *Off*.

SwapFloppy

Setting to *Enabled* will swap floppy drives A: and B:.

Seek Floppy

Setting to *Enabled* will make BIOS seek floppy drive A: before booting the system. Settings: *Disabled* and *Enabled*.

Password Check

This specifies the type of AMIBIOS password protection that is implemented. Setting options are described below.

Option	Description
Setup	The password prompt appears only when end users try to run Setup.
Always	A password prompt appears every time when the computer is powered on or when end users try to run Setup.

Boot OS/2 for DRAM > 64MB

This allows you to run the OS/2® operating system with more than 64MB DRAM. When you choose *No*, you cannot run the OS/2® operating system with more than 64MB DRAM. But it is possible if you choose *Yes*.

L1 Cache

The item enables or disables the L1 cache memory for CPU. Setting to *Enabled* will speed up the system performance.

Flash Protection

The item is used to enable or disable the BIOS Flash Protection function. Select *Disabled* when performing BIOS update with the flash utility.

System BIOS Cacheable

AMIBIOS always copies the system BIOS from ROM to RAM for faster execution. Selecting *Enabled* allows the contents of F0000h RAM memory segment to be written to and read from cache memory. Settings: *Enabled* and *Disabled*.

Chapter 4

Chipset Features Setup

AMIBIOS SETUP - CHIPSET FEATURES SETUP (C)1999 American Megatrends, Inc. All Rights Reserved	
***** DRAM Timing ***** Configure DRAM Timing by :SPD CAS# Latency :3 Clocks RAS# Precharge :3 Clocks RAS# to CAS# Delay :3 Clocks Precharge Delay :7 Clocks DRAM Integrity Mode :Non-ECC AGP Aperture Size :64MB Delayed Transaction :Enabled	
	ESC : Quit ↑↓←→ : Select Item F1 : Help PU/PD/+/- : Modify F5 : Old Values (Shift)F2 : Color F6 : Load BIOS Defaults F7 : Load Setup Defaults

 **Note:** Change these settings only if you are familiar with the chipset.

Configure DRAM Timing by

Selects whether DRAM timing is controlled by the SPD (Serial Presence Detect) EEPROM on the DRAM module. Setting to *SPD* enables CAS# Latency, RAS# Precharge, RAS# to CAS# Delay and Precharge Delay automatically to be determined by BIOS based on the configurations on the SPD. Selecting *Manual* allows users to configure these fields manually.

CAS# Latency

This controls the timing delay (in clock cycles) before SDRAM starts a read command after receiving it. Settings: *3 Clocks* and *2 Clocks*. *2 Clocks* increases the system performance while *3 Clocks* provides more stable performance.

RAS# Precharge

This item controls the number of cycles for Row Address Strobe (RAS) to be

allowed to precharge. If insufficient time is allowed for the RAS to accumulate its charge before DRAM refresh, refresh may be incomplete and DRAM may fail to retain data. This item applies only when synchronous DRAM is installed in the system. Available settings: *3 Clocks* and *2 Clocks*.

RAS# to CAS# Delay

This field allows you to set the number of cycles for a timing delay between the CAS and RAS strobe signals, used when DRAM is written to, read from or refreshed. Fast speed offers faster performance while slow speed offers more stable performance. Settings: *3 Clocks* and *2 Clocks*.

Precharge Delay

The field specifies the idle cycles before precharging an idle bank. Settings: *7 Clocks*, *6 Clocks* and *5 Clocks*.

DRAM Integrity Mode

Select *ECC* (Error-Correcting Code) or *Non-ECC* according to the type of installed DRAM.

AGP Aperture Size

The field selects the size of the Accelerated Graphics Port (AGP) aperture. Aperture is a portion of the PCI memory address range dedicated for graphics memory address space. Host cycles that hit the aperture range are forwarded to the AGP without any translation. Settings: *4MB*, *8MB*, *16MB*, *32MB*, *64MB*, *128MB* and *256MB*.

Delayed Transaction

The chipset has an embedded 32-bit posted write buffer to support delayed transactions cycles so that transactions to and from the ISA bus are buffered and PCI bus can perform other transactions while the ISA transaction is underway. Select *Enabled* to support compliance with PCI specification version 2.1. Settings: *Enabled* and *Disabled*.

Chapter 4

Power Management Setup

AMIBIOS SETUP - POWER MANAGEMENT SETUP (C)1999 American Megatrends, Inc. All Rights Reserved			
IPCA Function	:Yes	RTC Alarm Hour	:12
ACPI Standby State	:S1/POS	RTC Alarm Minute	:30
USB Wakeup From S3	:Disabled	RTC Alarm Second	:30
Mouse Wakeup From S3	:Disabled	Power Again	:Last State
Keyboard Wakeup From S3	:Disabled		
Specific Key for Wakeup	:N/A		
Power Management/APM	:Enabled		
Sleep State LED	:Blinking		
Suspend Time Out (Minute)	:Disabled		
FDC/LPT/COM Ports	:Monitor		
Primary Master IDE	:Monitor		
Primary Slave IDE	:Ignore		
Secondary Master IDE	:Monitor		
Secondary Slave IDE	:Ignore		
Power Button Function	:Suspend		
Wake Up On Ring	:Enabled	ESC : Quit	↑↓←→ : Select Item
Wake Up On LAN	:Disabled	F1 : Help	PU/PD/+/- : Modify
Wake Up On PME	:Enabled	F5 : Old Values	(Shift)F2 : Color
Resume By RTC Alarm	:Disabled	F6 : Load BIOS Defaults	
RTC Alarm Date	:15	F7 : Load Setup Defaults	

IPCA Function

This item is to activate the ACPI (Advanced Configuration and Power Management Interface) Function. If your operating system is ACPI-aware, such as Windows 98SE/2000/ME, select *Yes*. Settings: *Yes* and *No*.

ACPI Standby State

This item specifies the power saving modes for ACPI function. Options are:

- S1/POS* The S1 sleep mode is a low power state. In this state, no system context is lost (CPU or chipset) and hardware maintains all system context.
- S3/STR* The S3 sleep mode is a lower power state where the information of system configuration and open applications/files is saved to main memory that remains powered while most other hardware components turn off to save energy. The information stored in memory will be used to restore the system when an “wake up” event occurs.

USB Wakeup From S3

This item allows the activity of the USB device to wake up the system from S3 sleep state. S3 is the STR (Suspend to RAM) mode. Available settings: *Enabled* and *Disabled*.

Mouse Wakeup From S3

The item controls which button on the PS/2 mouse can wake up the system from S3 mode. Settings: *Disabled*, *Left-button* and *Right-button*.

Keyboard Wakeup From S3

The item controls which button on the PS/2 keyboard can wake up the system from S3 mode. Settings: *Disabled*, *PowerKey*, *Any Key* and *Specific Key*.

Specific Key for Wakeup

If **Keyboard Wakeup From S3** is set to *Specific Key*, you can assign a password for the keyboard to awaken the system in the field.

Power Management/APM

Setting to *Enabled* will activate the Advanced Power Management (APM) features to enhance power saving modes. Settings: *Enabled* and *Disabled*.

Sleep State LED

This item sets how the system uses Power LED on the case to indicate the suspend/sleep state. Settings are:

- Blinking* The Power LED blinks to indicate the suspend/sleep state.
- Dual Color* The Power LED changes its color to indicate the suspend/sleep state.

Suspend Time Out (Minute)

The item specifies the length of the period of system inactivity before the system enters the suspend mode from the standby mode. Nearly all power use is reduced in the suspend mode. Settings: *Disabled*, *1*, *2*, *4*, *8*, *10*, *20*, *30*, *40*, *50* and *60* (Minutes).

Chapter 4

FDC/LPT/COM Ports, Primary Master IDE, Primary Slave IDE, Secondary Master IDE, Secondary Slave IDE

These items specify if the BIOS will monitor the activity of the listed hardware peripheral or component. If set to *Monitor*, any activity detected on the specified hardware peripheral or component will wake up the system or prevent the system from entering the power saving modes. Settings: *Monitor* and *Ignore*.

Power Button Function

This feature sets the function of the power button. Settings:

<i>On/Off</i>	The power button functions as normal on/off button.
<i>Suspend</i>	When you press the power button, the computer enters the suspend/sleep mode, but if the button is pressed for more than four seconds, the computer is turned off.

Wake Up On Ring/LAN/PME

When setting to *Enabled*, these features allow your system to be awakened from the power saving modes through an incoming call from the modem, a signal from the LAN, or any event on PME (Power Management Event). Settings: *Enabled* and *Disabled*.



Note: You need to install a modem/LAN card supporting power on function for Wake Up On Ring/LAN function.

Resume By RTC Alarm

This is used to enable or disable the feature of booting up the system on a scheduled time/date. Settings: *Enabled* and *Disabled*.

RTC Alarm Date/Hour/Minute/Second

If **Resume By RTC Alarm** is set to *Enabled*, the system will automatically resume (boot up) on a specific date/hour/minute/second specified in these fields. Available settings for each item are:

RTC Alarm Date	01 ~ 31, Every Day
RTC Alarm Hour	00 ~ 23
RTC Alarm Minute	00 ~ 59
RTC Alarm Second	00 ~ 59



Note: *If you change these settings, you must reboot the system until it enters the operating system and then power off the system. By doing so, the changed settings will come into effect next time you power on the system.*

Power Again

This item specifies whether your system will reboot after a power failure or interrupt occurs. Available options:

- Power Off* Leaves the computer in the power off state.
- Power On* Reboots the computer.
- Last State* Restores the system to the previous status before the power failure or interrupt occurred.

Chapter 4

PNP/PCI Configuration

This section describes configuring the PCI bus system and PnP (Plug & Play) feature. PCI, or Personal Computer Interconnect, is a system which allows I/O devices to operate at speeds nearing the speed the CPU itself uses when communicating with its special components. This section covers some very technical items and it is strongly recommended that only experienced users should make any changes to the default settings.

AMIBIOS SETUP - PNP/PCI CONFIGURATION	
(C)1999 American Megatrends, Inc. All Rights Reserved	
Clear ESCD	:No
PCI VGA Palette Snoop	:Disabled
DMA Channel 0	:PnP
DMA Channel 1	:ISA/EISA
DMA Channel 3	:PnP
DMA Channel 5	:PnP
DMA Channel 6	:PnP
DMA Channel 7	:PnP
IRQ3	:PCI/PnP
IRQ4	:PCI/PnP
IRQ5	:ISA/EISA
IRQ7	:PCI/PnP
IRQ9	:PCI/PnP
IRQ10	:PCI/PnP
IRQ11	:PCI/PnP
ESC : Quit ↑↓←→ : Select Item F1 : Help PU/PD/+/- : Modify F5 : Old Values (Shift)F2 : Color F6 : Load BIOS Defaults F7 : Load Setup Defaults	

Clear ESCD

The ESCD (Extended System Configuration Data) NVRAM (Non-volatile Random Access Memory) is where the BIOS stores resource information for both PNP and non-PNP devices in a bit string format. When the item is set to *Yes*, the system will reset ESCD NVRAM right after the system is booted up and then set the setting of the item back to *No* automatically.

PCI VGA Palette Snoop

PCI VGA palette is the set of colors currently used by the video device. Some special VGA cards may not show colors correctly and need to look into the video device's VGA palette to determine what colors are in use. Then you have to turn on the palette "snoop", permitting the palette

registers of both VGA devices to be identical. The setting must be set to *Enabled* if any non-standard VGA adapter card, such as MPEG card, installed in the system requires VGA palette snooping.

DMA Channel 0/1/3/5/6/7

These items specify the bus that the system DMA (Direct Memory Access) channel is used. The settings determine if AMIBIOS should remove a DMA from the available DMAs passed to devices that are configurable by the system BIOS. The available DMA pool is determined by reading the ESCD NVRAM. If more DMAs must be removed from the pool, the end user can reserve the DMA by assigning an *ISA/EISA* setting to it.

IRQ 3/4/5/7/9/10/11

These items specify the bus where the specified IRQ line is used. The settings determine if AMIBIOS should remove an IRQ from the pool of available IRQs passed to devices that are configurable by the system BIOS. The available IRQ pool is determined by reading the ESCD NVRAM. If more IRQs must be removed from the IRQ pool, the end user can use these settings to reserve the IRQ by assigning an *ISA/EISA* setting to it. Onboard I/O is configured by AMIBIOS. All IRQs used by onboard I/O are configured as *PCI/PnP*. If all IRQs are set to *ISA/EISA*, and IRQ 14/15 are allocated to the onboard PCI IDE, IRQ 9 will still be available for PCI and PnP devices. Settings: *ISA/EISA* and *PCI/PnP*.

Chapter 4

Integrated Peripherals

AMIBIOS SETUP - INTEGRATED PERIPHERALS (C)1999 American Megatrends, Inc. All Rights Reserved		
USB Controller	:All USB Port	
USB Legacy Support	:Disabled	
On-Chip IDE	:Both	
Onboard Audio Chip	:Enabled	
AC'97 Audio	:Auto	
AC'97 Modem	:Auto	
Floppy Controller	:Enabled	
Serial Port A	:Auto	
Serial Port B	:Auto	
Serial Port B Mode	:Normal	
IR Duplex Mode	:Half Duplex	
IR Pin Select	:IRRX/IRTX	
Parallel Port	:Auto	
Parallel Port Mode	:ECP	
EPP Version	:N/A	
IRQ	:Auto	ESC : Quit ↑↓←→ : Select Item
DMA Channel	:Auto	F1 : Help PU/PD/+/- : Modify
OnBoard Midi Port	:330	F5 : Old Values (Shift)F2 : Color
Midi IRQ Select	:5	F6 : Load BIOS Defaults
OnBoard Game Port	:200	F7 : Load Setup Defaults

USB Controller

This is used to enable or disable the USB ports. Settings: *Disabled*, *USB Port 0&1*, *USB Port 2&3* and *All USB Port*.

USB Legacy Support

Set to *All Device* if you need to use any USB device in the operating system that does not support or have any USB driver installed, such as DOS and SCO Unix. Set to *No Mice* if your need to use any USB device except for the USB mouse.

On-ChipIDE

This allows you to enable or disable on-chip IDE controller. Settings: *Disabled*, *Primary*, *Secondary* and *Both*.

Onboard Audio Chip (Optional)

Use the item to enable or disable the OPTIONAL onboard hardware audio controller.

AC'97 Audio

This item is used to enable or disable the onboard AC'97 (Audio Codec'97) feature. Selecting *Auto* allows the mainboard to detect whether an audio device is used. If an audio device is detected, the onboard AC'97 controller will be enabled; if not, the controller is disabled. Disable the function if you want to use other controller cards to connect an audio device. Settings: *Disabled* and *Auto*.

AC'97 Modem

This item is used to enable or disable the onboard MC'97 (Modem Codec'97) feature. Selecting *Auto* allows the mainboard to detect whether a modem is used. If a modem is detected, the onboard MC'97 controller will be enabled; if not, the controller is disabled. Disable the controller if you want to use other controller cards to connect modems. Settings: *Auto* and *Disabled*.

Floppy Controller

This is used to enable or disable the onboard Floppy controller.

Option	Description
Auto	BIOS will automatically determine whether to enable the onboard Floppy controller or not.
Enabled	Enables the onboard Floppy controller.
Disabled	Disables the onboard Floppy controller.

Serial Port A/B

These items specify the base I/O port addresses of the onboard Serial Port A (COM A)/Serial Port B (COM B). Selecting *Auto* allows AMIBIOS to automatically determine the correct base I/O port address. Settings: *Auto*, *Disabled*, *3F8/COM1*, *2F8/COM2*, *3E8/COM3* and *2E8/COM4*.

Serial Port B Mode

This item sets the operation mode for Serial Port B (COM B). Settings: *Normal*, *1.6 uS*, *3/16 Baud* and *ASKIR*.

IRDuplexMode

This field specifies a duplex value for the IR device connected to COM B.

Chapter 4

Full-Duplex mode permits simultaneous two-direction transmission. Half-Duplex mode permits transmission in one direction only at a time. Settings: *Half Duplex* and *Full Duplex*.

IR Pin Select

Set to *IRRX/IRTX* when using an internal IR module connected to the IR (**IR1 or IR2**) connector. Set to *SINB/SOUTB*. when connecting an IR adapter to COM B.

Parallel Port

This field specifies the base I/O port address of the onboard parallel port. Selecting *Auto* allows AMIBIOS to automatically determine the correct base I/O port address. Settings: *Auto*, *Disabled*, *378*, *278* and *3BC*.

Parallel Port Mode

This item selects the operation mode for the onboard parallel port: *Normal*, *Bi-Dir*, *EPP* (Enhanced Parallel Port) or *ECP* (Extended Capability Port).

EPP Version

The item selects the EPP version used by the parallel port if the port is set to *EPP* mode. Settings: *1.7* and *1.9*.

IRQ

The item shows *Auto* indicating that BIOS determines the IRQ for the parallel port automatically.

DMA Channel

This feature is configured only when **Parallel Port Mode** is set to the *ECP* mode. When **Parallel Port** is set to *ECP*, the field will show *Auto* indicating that BIOS automatically determines the DMA channel for the parallel port.

OnBoard Midi Port

The item specifies I/O port address for the onboard Midi port. Settings: *Disabled*, *300*, *330*, *290* and *292*.

Midi IRQ Select

The item specifies the IRQ channel for the onboard Midi port. Settings: *5*, *7*,

9, 10 and 11.

OnBoard Game Port

The item specifies I/O port address for the onboard Joystick/Game port.
Settings: *Disabled*, 200 and 208.

Chapter 4

Hardware Monitor Setup

This section describes how to set the CPU FSB frequency, monitor the current hardware status including CPU/system temperatures, CPU/System Fan speeds, Vcore etc. Monitor function, such as “Chassis Intrusion” and “CPU Temperature”, is available only if there is hardware monitoring mechanism onboard.

AMIBIOS SETUP - Hardware Monitor Setup	
(C)1999 American Megatrends, Inc. All Rights Reserved	
CPU Ratio Selection	8.0x
CPU FSB Clock (Mhz)	100
Spread Spectrum	±0.38%
Chassis Intrusion	Disabled
CPU Temperature	29°C/84°F
System Temperature	39°C/102°F
CPU Fan Speed	6124 RPM
System Fan Speed	0 RPM
Vcore	1.71V
Vio	3.26V
+ 5.0V	4.92V
+12.0V	11.40V
-12.0V	-11.56V
- 5.0V	- 4.99V
Battery	3.22V
+5V SB	4.87V
ESC : Quit ↑↓←→ : Select Item	
F1 : Help PU/PD/+/- : Modify	
F5 : Old Values (Shift)F2 : Color	
F6 : Load BIOS Defaults	
F7 : Load Setup Defaults	

CPU Ratio Selection

The item is used to adjust the CPU clock multiplier (ratio). The item enables you to overclock the processor.

CPU FSB Clock (Mhz)

This item is used to set clock frequencies (in MHz) for CPU FSB (Front Side Bus). The field provides you an overclocking method. Settings include 100 (MHz) and above .

Spread Spectrum

This item is used to configure the clock generator’s Spread Spectrum feature. Always disable the feature when overclocking the processor.

Chassis Intrusion (Optional)

The field enables or disables the feature of recording the chassis intrusion status and issuing a warning message if the chassis is once opened. To clear the warning message, set the field to *Reset*. The setting of the field will automatically return to *Enabled* later. Settings: *Enabled, Reset* and *Disabled*.

CPU Temperature, System Temperature, CPU Fan Speed, System Fan Speed, Vcore, Vio, +5.0V, +12.0V, -12.0V, -5.0V, Battery, +5V SB (All Optional)

These OPTIONAL items display the current status of all monitored hardware devices/components such as system voltages, temperatures and fan speeds.

Chapter 4

Load Optimal/Fail Safe Defaults

The two options on the main menu allow users to restore all of the BIOS settings to the default Fail Safe or Optimal values. The Optimal Defaults are the default values set by the mainboard manufacturer specifically for the optimal performance of the mainboard. The Fail Safe Defaults are the default values set by the BIOS vendor for the stable system performance.

When you select Load Optimal Defaults, a message as below appears:

AMIBIOS SIMPLE SETUP UTILITY - VERSION 1.41 (C)1999 American Megatrends, Inc. All Rights Reserved	
STANDARD CMOS SETUP	LOAD OPTIMAL DEFAULTS
BIOS FEATURES SETUP	LOAD FAIL SAFE DEFAULTS
CHIPSET FEATURES SETUP	SUPERVISOR PASSWORD
POWER MANAGEMENT SETUP	Load Optimal Defaults(Y/N)? N
PNP/PCI CONFIGURATION	
INTEGRATED PERIPHERALS	SAVE & EXIT SETUP
HARDWARE MONITOR SETUP	EXIT WITHOUT SAVING
ESC : Quit ↑↓←→ : Select Item (Shift)F2 : Change Color	
F5 : Old Values F7 : Load Fail Safe Defaults F10 : Save & Exit	
Load Optimal Defaults except Standard CMOS SETUP	

Pressing Y loads the default factory settings for optimal system performance.

When you select Load Fail Safe Defaults, a message as below appears:

AMIBIOS SIMPLE SETUP UTILITY - VERSION 1.41 (C)1999 American Megatrends, Inc. All Rights Reserved	
STANDARD CMOS SETUP	LOAD OPTIMAL DEFAULTS
BIOS FEATURES SETUP	LOAD FAIL SAFE DEFAULTS
CHIPSET FEATURES SETUP	SUPERVISOR PASSWORD
POWER MANAGEMENT SETUP	Load Fail Safe Defaults(Y/N)? N
PNP/PCI CONFIGURATION	
INTEGRATED PERIPHERALS	SAVE & EXIT SETUP
HARDWARE MONITOR SETUP	EXIT WITHOUT SAVING
ESC : Quit ↑↓←→ : Select Item (Shift)F2 : Change Color F5 : Old Values F7 : Load Fail Safe Defaults F10 : Save & Exit	
Load Fail Safe Defaults except Standard CMOS SETUP	

Pressing Y loads the BIOS default values for the most stable, minimal system performance.

Chapter 4

Supervisor/User Password

When you select this function, a message as below will appear on the screen:

AMIBIOS SIMPLE SETUP UTILITY - VERSION 1.41 (C)1999 American Megatrends, Inc. All Rights Reserved	
STANDARD CMOS SETUP	LOAD OPTIMAL DEFAULTS
BIOS FEATURES SETUP	LOAD FAIL SAFE DEFAULTS
CHIPSET FEATURES SETUP	SUPERVISOR PASSWORD
POWER MANAGEMENT SETUP	USER PASSWORD
PNP/PCI CONFIGURATION	Enter new supervisor password:
INTEGRATED PERIPHERALS	
HARDWARE MONITOR SETUP	EXIT WITHOUT SAVING
ESC : Quit ↑↓←→ : Select Item (Shift)F2 : Change Color	
F5 : Old Values F7 : Load Fail Safe Defaults F10 : Save & Exit	
Change/Set/Disable Password	

Type the password, up to six characters in length, and press <Enter>. The password typed now will replace any previously set password from CMOS memory. You will be prompted to confirm the password. Retype the password and press <Enter>. You may also press <Esc> to abort the selection and not enter a password.

To clear a set password, just press <Enter> when you are prompted to enter the password. A message will show up confirming the password will be disabled. Once the password is disabled, the system will boot and you can enter Setup without entering any password.

When a password has been set, you will be prompted to enter it every time you try to enter Setup. This prevents an unauthorized person from changing any part of your system configuration.

Additionally, when a password is enabled, you can also have AMIBIOS to request a password each time the system is booted. This would prevent unauthorized use of your computer. The setting to determine when the password prompt is required is the PASSWORD CHECK option of the BIOS FEATURES SETUP menu. If the PASSWORD CHECK option is set to *Always*, the password is required both at boot and at entry to Setup. If set to *Setup*, password prompt only occurs when you try to enter Setup.



About Supervisor Password & User Password:

Supervisor password: Can enter and change the settings of the setup menu.

User password: Can only enter but do not have the right to change the settings of the setup menu.

Chapter 4

IDE HDD AUTO Detection

You can use this utility to AUTOMATICALLY detect the characteristics of most hard drives.

AMIBIOS SETUP - STANDARD CMOS SETUP (C)1999 American Megatrends, Inc. All Rights Reserved									
Date (mm/dd/yyyy) : Thu Aug 02, 2001									
Time (hh/mm/ss) : 00:00:00									
	TYPE	SIZE	CYLS	HEAD	PRECOMP	LANDZ	SECTOR	MODE	
Pri Master	: AUTO								
Pri Slave	: AUTO								
Sec Master	: AUTO								
Sec Slave	: AUTO								
Floppy Drive A : 1.44 MB 3½									
Floppy Drive B : Not Installed									
Boot Sector Virus Protection Disabled								Base Memory : 640 Kb Other Memory : 384 Kb Extended Memory : 127 Mb Total Memory : 128 Mb	
Month:	Jan - Dec							ESC : Exit	
Day:	01 - 31							↑↓ : Select Item	
Year:	1901 - 2099							PU/PD/+/- : Modify	
								(Shift) F2 : Color	

Save & Exit Setup

When you want to quit the Setup menu, you can select this option to save the changes and quit. A message as below will appear on the screen.

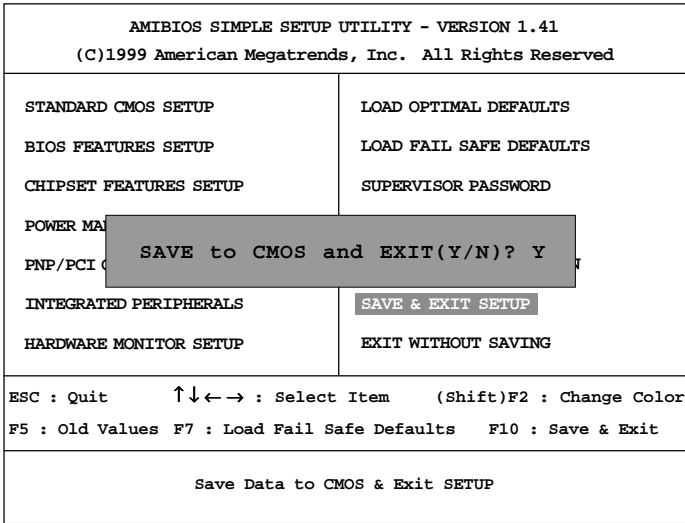

Typing *Y* will allow you to quit the Setup Utility and save the user setup changes to RTC CMOS.

Typing *N* will return to the Setup Utility.

Chapter 4

Exit Without Saving

When you want to quit the Setup menu, you can select this option to abandon the changes. A message as below will appear on the screen.

AMIBIOS SIMPLE SETUP UTILITY - VERSION 1.41 (C)1999 American Megatrends, Inc. All Rights Reserved	
STANDARD CMOS SETUP	LOAD OPTIMAL DEFAULTS
BIOS FEATURES SETUP	LOAD FAIL SAFE DEFAULTS
CHIPSET FEATURES SETUP	SUPERVISOR PASSWORD
POWER MANAGEMENT SETUP	USER PASSWORD
PNP/PCI CO	Quit without saving(Y/N)? N
INTEGRATE	EXIT WITHOUT SAVING
HARDWARE MONITOR SETUP	
ESC : Quit ↑↓←→ : Select Item (Shift)F2 : Change Color F5 : Old Values F7 : Load Fail Safe Defaults F10 : Save & Exit	
Abandon all Datas & Exit SETUP	

Typing *Y* will allow you to quit the Setup Utility without saving any changes to RTCMOS.

Typing *N* will return to the Setup Utility.

Using 4-/6-channel Audio Function **A**

The mainboard comes with C-Media 6-channel audio function, which allows you to attach 4 or 6 speakers for better space sound effect. The section will tell you how to activate 4-/6-channel audio function.

This section includes the following topics:

Installing C-Media Drivers	A-2
Hardware Configuration	A-2
Software Configuration	A-3

Appendix A

Installing C-Media Drivers

The mainboard is able to transform the audio connectors on the back panel from 2-channel to 4-/6-channel. To use the function, you need to install the C-Media drivers.

To install C-Media drivers:

1. Insert the companion CD into the CD-ROM drive. The setup screen will automatically appear.
2. Click on **C-Media Sound Drivers**.
3. Follow the on-screen instructions to complete installation.
4. Restart the system.



Note: For Windows NT4.0, you need to install the C-Media Sound Drivers *manually*.

Hardware Configuration

After installing the C-Media drivers, you can attach the speakers for 4-/6-channel audio output. Always connect the speakers to the LINE OUT connectors. Different connector configurations for 2-/4-/6-channel operations are listed below:

2-Channel

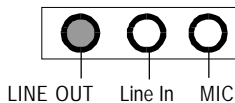

In 2-channel configuration, Line Out, Line In and MIC functions all exist.

4-Channel

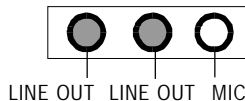

When set to 4-channel configuration, LINE IN function DOES NOT WORK any more.

6-Channel

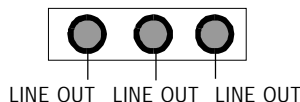

When set to 6-channel configuration, LINE IN and MIC functions DO NOT WORK anymore.

Software Configuration

To have 4-/6-channel audio work, you must set appropriate configuration in the C-Media software application.

To set the multi-channel configuration:

1. Click the C-Media Mixer icon  from the window tray on the bottom.
2. The following screen appears. Click the indicated button.



Click here

3. The “Advanced” window appears.



4. Select 5.1 for 6-channel or 4 for 4-channel audio output.
5. Click OK.

Free Manuals Download Website

<http://myh66.com>

<http://usermanuals.us>

<http://www.somanuals.com>

<http://www.4manuals.cc>

<http://www.manual-lib.com>

<http://www.404manual.com>

<http://www.luxmanual.com>

<http://aubethermostatmanual.com>

Golf course search by state

<http://golfingnear.com>

Email search by domain

<http://emailbydomain.com>

Auto manuals search

<http://auto.somanuals.com>

TV manuals search

<http://tv.somanuals.com>