

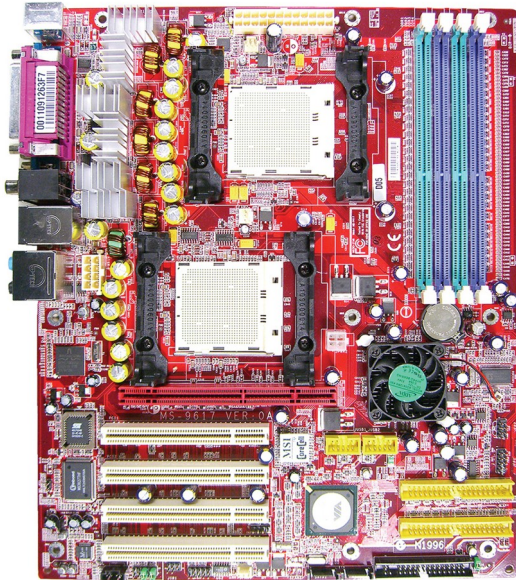

K8T Master2-FAR7
MS-9617 (v1.X) Workstation Board



English Version
G52-S9617X1

Copyright Notice

The material in this document is the intellectual property of **MICRO-STAR INTERNATIONAL**. We take every care in the preparation of this document, but no guarantee is given as to the correctness of its contents. Our products are under continual improvement and we reserve the right to make changes without notice.

Trademarks

All trademarks are the properties of their respective owners.

AMD, Athlon™, Athlon™ XP, Thoroughbred™, and Duron™ are registered trademarks of AMD Corporation.

Intel® and Pentium® are registered trademarks of Intel Corporation.

PS/2 and OS®/2 are registered trademarks of International Business Machines Corporation.

Windows® 95/98/2000/NT/XP are registered trademarks of Microsoft Corporation.

Netware® is a registered trademark of Novell, Inc.

Award® is a registered trademark of Phoenix Technologies Ltd.

AMI® is a registered trademark of American Megatrends Inc.

Revision History

Revision	Revision History	Date
V1.0	First release	June 2005

Technical Support

If a problem arises with your system and no solution can be obtained from the user's manual, please contact your place of purchase or local distributor. Alternatively, please try the following help resources for further guidance.

- 🔍 Visit the MSI website for FAQ, technical guide, BIOS updates, driver updates, and other information: http://www.msi.com.tw/program/service/faq/faq/esc_faq_list.php
- 📧 Contact our technical staff at: support@msi.com.tw

Safety Instructions

1. Always read the safety instructions carefully.
2. Keep this User's Manual for future reference.
3. Keep this equipment away from humidity.
4. Lay this equipment on a reliable flat surface before setting it up.
5. The openings on the enclosure are for air convection hence protects the equipment from overheating. **DO NOT COVER THE OPENINGS.**
6. Make sure the voltage of the power source and adjust properly 110/220V before connecting the equipment to the power inlet.
7. Place the power cord such a way that people can not step on it. Do not place anything over the power cord.
8. Always Unplug the Power Cord before inserting any add-on card or module.
9. All cautions and warnings on the equipment should be noted.
10. Never pour any liquid into the opening that could damage or cause electrical shock.
11. If any of the following situations arises, get the equipment checked by a service personnel:
 - † The power cord or plug is damaged.
 - † Liquid has penetrated into the equipment.
 - † The equipment has been exposed to moisture.
 - † The equipment has not work well or you can not get it work according to User's Manual.
 - † The equipment has dropped and damaged.
 - † The equipment has obvious sign of breakage.
12. **DO NOT LEAVE THIS EQUIPMENT IN AN ENVIRONMENT UNCONDITIONED, STORAGE TEMPERATURE ABOVE 60°C (140°F), IT MAY DAMAGE THE EQUIPMENT.**



CAUTION: Danger of explosion if battery is incorrectly replaced. Replace only with the same or equivalent type recommended by the manufacturer.



警告使用者：
這是甲類的資訊產品，在居住的環境中使用時，可能會造成無線電干擾，在這種情況下，使用者會被要求採取某些適當的對策。



廢電池請回收

For better environmental protection, waste batteries should be collected separately for recycling or special disposal.

FCC-B Radio Frequency Interference Statement

This equipment has been tested and found to comply with the limits for a Class B digital device, pursuant to Part



15 of the FCC Rules. These limits are designed to provide reasonable protection against harmful interference in a residential installation. This equipment generates, uses and can radiate radio frequency energy and, if not installed and used in accordance with the instructions, may cause harmful interference to radio communications. However, there is no guarantee that interference will not occur in a particular installation. If this equipment does cause harmful interference to radio or television reception, which can be determined by turning the equipment off and on, the user is encouraged to try to correct the interference by one or more of the measures listed below.

- † Reorient or relocate the receiving antenna.
- † Increase the separation between the equipment and receiver.
- † Connect the equipment into an outlet on a circuit different from that to which the receiver is connected.
- † Consult the dealer or an experienced radio/television technician for help.

Notice 1

The changes or modifications not expressly approved by the party responsible for compliance could void the user's authority to operate the equipment.

Notice 2

Shielded interface cables and A.C. power cord, if any, must be used in order to comply with the emission limits.

VOIR LA NOTICE D'INSTALLATION AVANT DE RACCORDER AU RESEAU.



This device complies with Part 15 of the FCC Rules. Operation is subject to the following two conditions:

- (1) this device may not cause harmful interference, and*
- (2) this device must accept any interference received, including interference that may cause undesired operation.*

WEEE (Waste Electrical and Electronic Equipment) Statement



ENGLISH

To protect the global environment and as an environmentalist, MSI must remind you that...

Under the European Union ("EU") Directive on Waste Electrical and Electronic Equipment, Directive 2002/96/EC, which takes effect on August 13, 2005, products of "electrical and electronic equipment" cannot be discarded as municipal waste anymore and manufacturers of covered electronic equipment will be obligated to take back such products at the end of their useful life. MSI will comply with the product take back requirements at the end of life of MSI-branded products that are sold into the EU. You can return these products to local collection points.

DEUTSCH

Hinweis von MSI zur Erhaltung und Schutz unserer Umwelt

Gemäß der Richtlinie 2002/96/EG über Elektro- und Elektronik-Altgeräte dürfen Elektro- und Elektronik-Altgeräte nicht mehr als kommunale Abfälle entsorgt werden. MSI hat europaweit verschiedene Sammel- und Recyclingunternehmen beauftragt, die in die Europäische Union in Verkehr gebrachten Produkte, am Ende seines Lebenszyklus zurückzunehmen. Bitte entsorgen Sie dieses Produkt zum gegebenen Zeitpunkt ausschliesslich an einer lokalen Altgerätesammelstelle in Ihrer Nähe.

FRANÇAIS

En tant qu'écologiste et afin de protéger l'environnement, MSI tient à rappeler ceci...

Au sujet de la directive européenne (EU) relative aux déchets des équipement électriques et électroniques, directive 2002/96/EC, prenant effet le 13 août 2005, que les produits électriques et électroniques ne peuvent être déposés dans les décharges ou tout simplement mis à la poubelle. Les fabricants de ces équipements seront obligés de récupérer certains produits en fin de vie. MSI prendra en compte cette exigence relative au retour des produits en fin de vie au sein de la communauté européenne. Par conséquent vous pouvez retourner localement ces matériels dans les points de collecte.

РУССКИЙ

Компания MSI предпринимает активные действия по защите окружающей среды, поэтому напоминаем вам, что...

В соответствии с директивой Европейского Союза (ЕС) по предотвращению загрязнения окружающей среды использованным электрическим и электронным оборудованием (директива WEEE 2002/96/EC), вступающей в силу 13 августа 2005 года, изделия, относящиеся к электрическому и электронному оборудованию, не могут рассматриваться как бытовой мусор, поэтому производители вышеперечисленного электронного оборудования обязаны принимать его для переработки по окончании срока службы. MSI обязуется соблюдать требования по приему продукции, проданной под маркой MSI на территории ЕС, в переработку по окончании срока службы. Вы можете вернуть эти изделия в специализированные пункты приема.

ESPAÑOL

MSI como empresa comprometida con la protección del medio ambiente, recomienda:

Bajo la directiva 2002/96/EC de la Unión Europea en materia de desechos y/o equipos electrónicos, con fecha de rigor desde el 13 de agosto de 2005, los productos clasificados como "eléctricos y equipos electrónicos" no pueden ser depositados en los contenedores habituales de su municipio, los fabricantes de equipos electrónicos, están obligados a hacerse cargo de dichos productos al término de su período de vida. MSI estará comprometido con los términos de recogida de sus productos vendidos en la Unión Europea al final de su período de vida. Usted debe depositar estos productos en el punto limpio establecido por el ayuntamiento de su localidad o entregar a una empresa autorizada para la recogida de estos residuos.

NEDERLANDS

Om het milieu te beschermen, wil MSI u eraan herinneren dat....

De richtlijn van de Europese Unie (EU) met betrekking tot Vervuiling van Elektrische en Electronische producten (2002/96/EC), die op 13 Augustus 2005 in zal gaan kunnen niet meer beschouwd worden als vervuiling.

Fabrikanten van dit soort producten worden verplicht om producten retour te nemen aan het eind van hun levenscyclus. MSI zal overeenkomstig de richtlijn handelen voor de producten die de merknaam MSI dragen en verkocht zijn in de EU. Deze goederen kunnen geretourneerd worden op lokale inzamelingspunten.

SRPSKI

Da bi zaštitili prirodnu sredinu, i kao preduzeće koje vodi računa o okolini i prirodnoj sredini, MSI mora da vas podesti da...

Po Direktivi Evropske unije ("EU") o odbačenju elektronskoj i električnoj opremi, Direktiva 2002/96/EC, koja stupa na snagu od 13. Avgusta 2005, proizvodi koji spadaju pod "elektronsku i električnu opremu" ne mogu više biti odbaceni kao običan otpad i proizvođači ove opreme biće prinudeni da uzmu nafrag ove proizvode na kraju njihovog uobičajenog veka trajanja. MSI će poštovati zahtev o preuzimanju ovakvih proizvoda kojima je istekao vek trajanja, koji imaju MSI oznaku i koji su prodati u EU. Ove proizvode možete vratiti na lokalnim mestima za prikupljanje.

POLSKI

Aby chronić nasze środowisko naturalne oraz jako firma dbająca o ekologię, MSI przypomina, że...

Zgodnie z Dyrektywą Unii Europejskiej ("UE") dotyczącą odpadów produktów elektrycznych i elektronicznych (Dyrektywa 2002/96/EC), która wchodzi w życie 13 sierpnia 2005, tzw. "produkty oraz wyposażenie elektryczne i elektroniczne" nie mogą być traktowane jako śmieć komunalne, tak więc producenci tych produktów będą zobowiązani do odbierania ich w momencie gdy produkt jest wycofywany z użycia. MSI wypełni wymagania UE, przyjmując produkty (sprzedawane na terenie Unii Europejskiej) wycofywane z użycia. Produkty MSI będzie można zwracać w wyznaczonych punktach zbiorczych.

TÜRKÇE

Çevreci özelliğiyle bilinen MSI dünyada çevreyi korumak için hatırlatır:

Avrupa Birliği (AB) Kararnamesi Elektrik ve Elektronik Malzeme Atığı, 2002/96/EC Kararnamesi altında 13 Ağustos 2005 tarihinden itibaren geçerli olmak üzere, elektrikli ve elektronik malzemeler diğer atıklar gibi çöpe atılmayacak ve bu elektronik cihazların üreticileri, cihazların kullanım süreleri bittikten sonra ürünleri geri toplamakla yükümlü olacaktır. Avrupa Birliği'ne satılan MSI markalı ürünlerin kullanım süreleri bittiğinde MSI ürünlerin geri alınması isteği ile işbirliği içerisinde olacaktır. Ürünlerinizi yerel toplama noktalarına bırakabilirsiniz.

ČESKY

Záleží nám na ochraně životního prostředí - společnost MSI upozorňuje...

Podle směrnice Evropské unie ("EU") o likvidaci elektrických a elektronických výrobků 2002/96/EC platné od 13. srpna 2005 je zakázáno likvidovat "elektrické a elektronické výrobky" v běžném komunálním odpadu a výrobě elektronických výrobků, na které se tato směrnice vztahuje, budou povinni odebírat takové výrobky zpět po skončení jejich životnosti. Společnost MSI splní požadavky na odebrání výrobků značky MSI, prodávaných v zemích EU, po skončení jejich životnosti. Tyto výrobky můžete odevzdat v místních sběrnách.

MAGYAR

Annak érdekében, hogy környezetünkét megvédjük, illetve környezetvédként fellépve az MSI emlékezteti Önt, hogy ...

Az Európai Unió („EU”) 2005. augusztus 13-án hatályba lépő, az elektromos és elektronikus berendezések hulladékairól szóló 2002/96/EK irányelve szerint az elektromos és elektronikus berendezések többé nem kezelhetőek lakossági hulladékként, és az ilyen elektronikus berendezések gyártói kötelessé válnak az ilyen termékek visszavételére azok hasznos élettartama végén. Az MSI betartja a termék visszavétellel kapcsolatos követelményeket az MSI márkanév alatt az EU-n belül értékesített termékek esetében, azok élettartamának végén. Az ilyen termékeket a legközelebbi gyűjtőhelyre viheti.

ITALIANO

Per proteggere l'ambiente, MSI, da sempre amica della natura, ti ricorda che....

In base alla Direttiva dell'Unione Europea (EU) sullo Smaltimento dei Materiali Elettrici ed Elettronici, Direttiva 2002/96/EC in vigore dal 13 Agosto 2005, prodotti appartenenti alla categoria dei Materiali Elettrici ed Elettronici non possono più essere eliminati come rifiuti municipali: i produttori di detti materiali saranno obbligati a ritirare ogni prodotto alla fine del suo ciclo di vita. MSI si adeguerà a tale Direttiva ritirando tutti i prodotti marchiati MSI che sono stati venduti all'interno dell'Unione Europea alla fine del loro ciclo di vita. È possibile portare i prodotti nel più vicino punto di raccolta.

CONTENTS

Copyright Notice	ii
Trademarks	ii
Revision History	ii
Technical Support	ii
Safety Instructions	iii
FCC-B Radio Frequency Interference Statement	iv
WEEE (Waste Electrical and Electronic Equipment) Statement	v
Chapter 1. Getting Started	1-1
Mainboard Specifications	1-2
Mainboard Layout	1-4
MSI Special Features	1-5
Core Center	1-5
Chapter 2. Hardware Setup	2-1
Quick Components Guide	2-2
Central Processing Unit: CPU	2-3
CPU Installation Procedures for Socket 940	2-4
Installing AMD Opteron™ CPU Cooling System	2-5
Memory	2-7
Installing DDR Modules	2-7
Memory Population Rules	2-8
Power Supply	2-9
SSI 4-Pin VGA Power Connector: JPWR2 (Optional)	2-9
SSI 8-Pin CPU Power Connector: JPWR1	2-9
SSI 24-Pin System Power Connector: JPR1	2-10
Back Panel	2-11
Mouse Connector (Green) / Keyboard Connector (Purple)	2-11
Serial Ports	2-12
USB Connectors	2-12
RJ-45 LAN Jack	2-13
Audio Port Connectors	2-13
Parallel Port Connector: LPT1	2-14
Connectors	2-15
Floppy Disk Drive Connector: FDD1	2-15
Hard Disk Connectors: IDE1, IDE2	2-15
Serial ATA/Serial ATA RAID Connectors: SATA1, SATA2	2-16
SCSI LED Connector: J7	2-17

Fan Power Connectors: CFAN1/2, SFAN1, NBFAN1	2-17
IrDA Infrared Module Header: JIR1	2-18
Front Panel Audio Connector: JAUD1	2-18
Chassis Intrusion Switch Connector: JCI1	2-19
CD-In Connector: JCD1	2-19
Front Panel Connectors: JFP1, JFP2	2-19
D-Bracket™ 2 Connector: JLED	2-20
Front USB Connectors: JUSB1, JUSB2	2-22
Jumper	2-23
Clear CMOS Jumper: JBAT1	2-23
Slots	2-24
AGP (Accelerated Graphics Port) Pro Slot	2-24
PCI (Peripheral Component Interconnect) Slots	2-24
PCI Interrupt Request Routing	2-24
Chapter 3. BIOS Setup	3-1
Entering Setup	3-2
Control Keys	3-2
Getting Help	3-3
The Main Menu	3-4
Standard CMOS Features	3-6
Advanced BIOS Features	3-8
Advanced Chipset Features	3-10
Integrated Peripherals	3-14
Power Management Setup	3-19
PC Health Status	3-22
Frequency/Voltage Control	3-24
Load Fail-Safe/Optimized Defaults	3-25
Set Supervisor/User Password	3-26
Appendix A: VIA VT8237R SATA RAID	A-1
Introduction	A-2
BIOS Configuration	A-3
Installing RAID Software & Drivers	A-10
Using VIA RAID Tool	A-13
Appendix B: Using 2-, 4-, 6- or 8- Channel Audio Function	B-1
Installing the Audio Driver	B-2
Installation for Windows 98SE/ME/2000/XP	B-2

Software Configuration	B-4
Sound Effect	B-5
Speaker Configuration	B-7
3D Audio Demo	B-9
General	B-10
SPDIF	B-11
Microphone Effect	B-12
Using 2-, 4-, 6- & 8- Channel Audio Function	B-13



Getting Started

Thank you for choosing the K8T Master2-FAR7 (MS-9617 v1.x), an excellent ATX workstation board from MSI. Based on the innovative **VIA® K8T800 Pro** and **VIA® VT8237R** chipsets for optimal system efficiency, the K8T Master2-FAR7 mainboard accommodates dual latest AMD Opteron DP™/UP™ processors in the 940-pin lidded ceramic micro PGA package, and supports up to four 144-bit DDR registered ECC DIMMs (at 200, 266, 333 and 400MHz) to provide the maximum of 8 GB memory capacity. This mainboard provides a cost-effective and professional solution for high-end workstation and server markets.

Mainboard Specifications

CPU

- † Supports dual Socket 940 for AMD Opteron™ processors, from 1.4 ~ 3.6 GHz
(For more information on compatible components, please visit http://www.msi.com.tw/program/products/server/svr/pro_svr_qvl.php)

Chipset

- † VIA® K8T800 Pro Northbridge
 - HyperTransport link to the AMD Opteron™ CPU
 - 800/600/400/200 MHz "Double Data Rate" operation both direction
 - AGP v3.0 compliant with 8X transfer mode
- † VIA® VT8237R Southbridge
 - Integrated Hardware Sound Blaster/Direct Sound AC97 audio
 - Ultra DMA 66/100/133 master mode PCI EIDE controller
 - Supports Serial ATA RAID
 - Supports eight high-speed USB 2.0 ports at up to 480Mb/s transfer
 - Extensive ACPI-compliant power management
 - Integrated Faster Ethernet LPC

Main Memory

- † 144-bit DDR at 200/266/333/400 MHz
- † Supports four 184-pin DDR DIMMs up to 8GB
- † Supports interleaving memory within DIMMs
- † ChipKill ECC allows continuous correction of 4-bit errors in a failed x 4 memory device
(For more information on compatible components, please visit http://www.msi.com.tw/program/products/server/svr/pro_svr_qvl.php)

Slots

- † One AGP Pro 8x/4x slot.
- † Four 32-bit/33 MHz PCI slots

HDD Interface

- † An IDE controller on the VT8237R chipset
 - Provides IDE HDD/CD-ROM with PIO, Bus Master and Ultra DMA 133/100/66 operation modes
 - Can connect up to 4 IDE devices
- † Serial ATA/150 controller integrated in VT8237R
 - Up to 150MB/sec transfer rate
 - Can connect up to two Serial ATA drives

Onboard Peripherals

- † 2 x IDE ports
- † 1 x PS/2 keyboard port and 1 x PS/2 mouse port
- † 2 x serial ports
- † 1 x parallel port supports SPP/EPP/ECP mode

- † 1 x RJ-45 port (with LEDs)
- † 8 x USB ports (front*4 and rear*4)
- † 2 x SATA ports

Networking

- † Broadcom BCM5705 Gigabit Ethernet controller

Audio

- † AC'97 link controller integrated in VIA VT8237R
- † 8-channel audio codec Realtek ALC850
 - Compliance with AC97 v2.3 Spec
 - Meets PC2001 audio performance requirement

Power Management Features

- † Wake up on LAN (WOL), wake up on PCI
- † RTC alarm and wake up
- † Wake up on keyboard/mouse/USB from S1
- † Supports ACPI S1, S4, S5 function

System Management

- † SMBus (I2C)
- † Temperature, voltage, and fan monitors
- † Chassis intrusion

BIOS

- † The mainboard BIOS provides "Plug & Play" BIOS which detects the peripheral devices and expansion cards of the board automatically
- † The mainboard provides a Desktop Management Interface (DMI) function which records your mainboard specifications
- † Supports boot from LAN, USB Device 1.1 & 2.0, and SATA HDD

Dimension

- † ATX Form Factor: 12.0 x 10.0 inch (H x W)

Mounting

- † 9 mounting holes (ATX Form standard)



MSI Reminds You...

To create a bootable RAID volume for a Windows 2000 environment, Microsoft's Windows 2000 Service Pack 4 (SP4) is required. As the end user cannot boot without SP4, a combination installation CD must be created before attempting to install the operating system onto the bootable RAID volume.

To create the combination installation CD, please refer to the following website:

<http://www.microsoft.com/windows2000/downloads/servicepacks/sp4/HFdeploy.htm>

Mainboard Layout

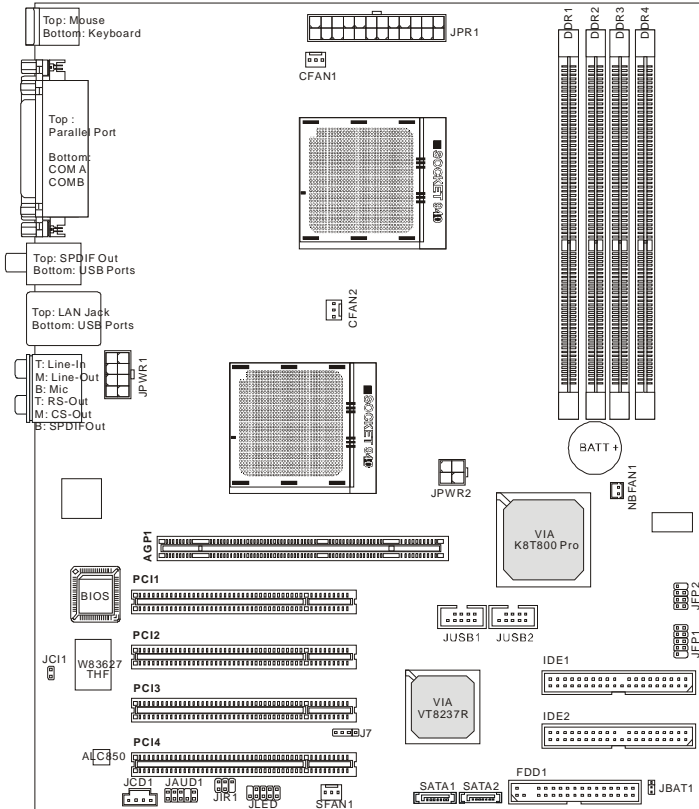

K8T Master2-FAR7 (MS-9617 v1.X) ATX Workstation Board

MSI Special Features

Core Center

The Core Center is a new utility you can find in the CD-ROM disk. The utility is just like your PC doctor that can detect, view and adjust the PC hardware and system status during real time operation. In the left side it shows the current system status, including the Vcore, 3.3V, +5V and 12V. In the right side it shows the current PC hardware status such as the CPU & system temperatures and all fans speeds.



When you click the red triangles in the left and right sides, two sub-menus will open for users to overclock, overspec or to adjust the thresholds of system to send out the warning messages. If you click the **Core Center** button on the top, a screen pops up for you to choose the **"Auto mode"** or **"User mode"** of CPU fan. You may adjust the speeds of CPU fans and system fan here.



Left-side: Current system status

In the left sub-menu, you can configure the settings of FSB, Vcore, Memory Voltage and AGP Voltage by clicking the radio button in front of each item and make it available (the radio button will be lit as yellow when selected), use the “+” and “-” buttons to adjust, then click “**ok**” to apply the changes. Then you can click **Save** to save the desired FSB you just configured.

Also you may click **Auto** to start testing the maximal CPU overclocking value, The CPU FSB will automatically increase the testing value until the PC reboots. Or you may click **Default** to restore the default values.

Right-side: PC hardware status during real time operation

In the right sub-menu, here you can configure the PC hardware status such as CPU & system temperatures and fan speeds. You may use the scroll bars to adjust each item, then click “**ok**” to apply the changes. The values you set for the temperatures are the maximum thresholds for the system for warnings, and the value for fan speeds are the minimum thresholds.

Top-side: User mode/Auto mode

Here you may adjust the CPU fan speed. If you choose **User mode**, you may adjust the CPU fan speed in 8 different modes, from **Stop** to **Full speed**.



MSI Reminds You...

Items shown on Core Center may vary depending on your system status.

2

Hardware Setup

This chapter provides you with the information about hardware setup procedures. While doing the installation, be careful in holding the components and follow the installation procedures. For some components, if you install in the wrong orientation, the components will not work properly.

Use a grounded wrist strap before handling computer components. Static electricity may damage the components.

Quick Components Guide

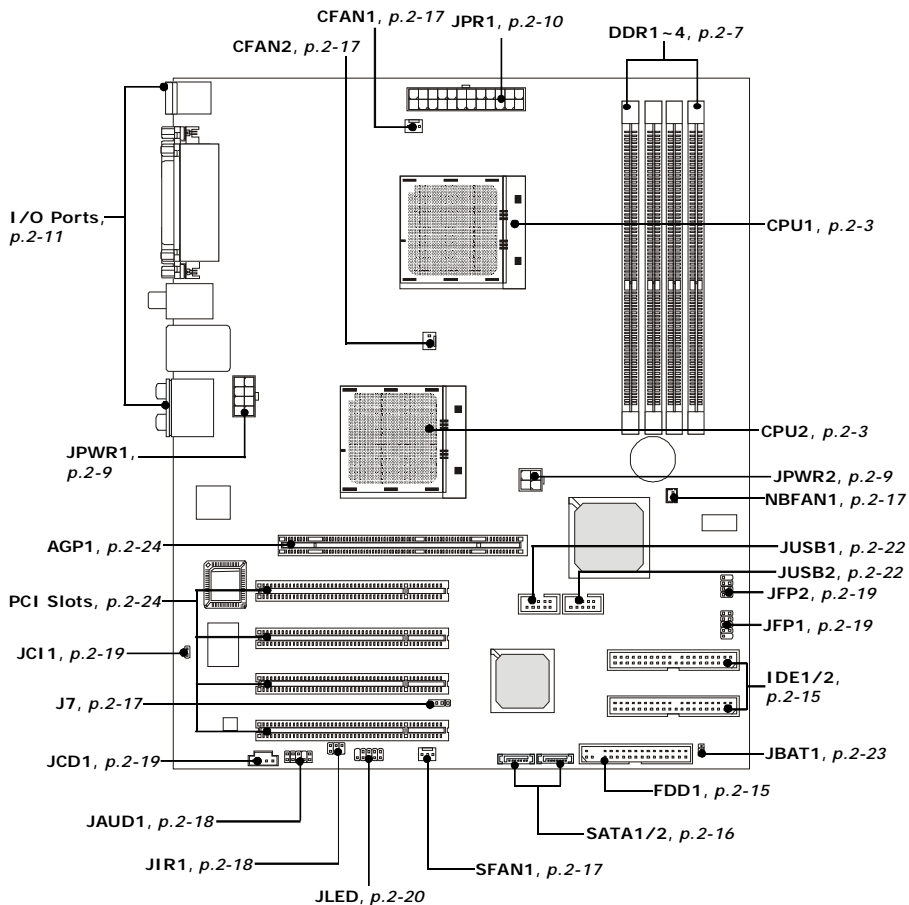

Central Processing Unit: CPU

The mainboard supports dual AMD® Opteron processors. The mainboard uses two CPU sockets called Socket 940 for easy CPU installation. You can install SINGLE or DUAL CPUs on the mainboard to meet your own needs. Keep the following points in mind before installing CPU(s).

1. If **SINGLE** CPU is intended, always install the CPU on the **CPU1** socket.

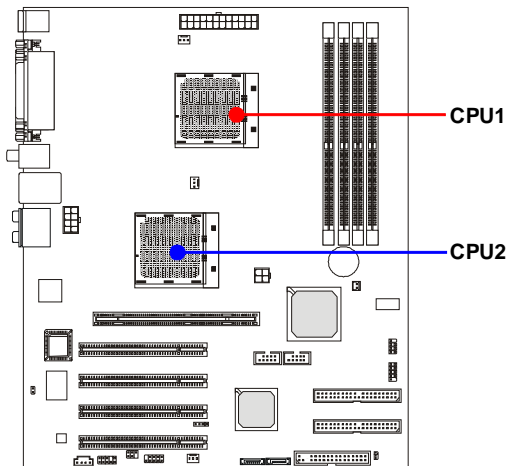

2. To install **DUAL** CPUs on the board, you must use **the same type of CPUs running at the same frequency**.

When you are installing the CPU, **make sure the CPU has a Heat Sink and a cooling fan attached on the top to prevent overheating**. If you do not find the Heat Sink and cooling fan, contact your dealer to purchase and install them before turning on the computer.

For more information on compatible components, please visit http://www.msi.com.tw/program/products/server/svr/pro_svr_qvl.php.



MSI Reminds You...

Overheating will seriously damage the CPU and system, always make sure the cooling fan can work properly to protect the CPU from overheating.

The system temperature needs to remain under 45°C.

We highly recommend that the direction of inlet air should follow the direction indicated above for better cooling effect.

CPU Installation Procedures for Socket 940

1. Make sure that the computer is turned off, and the power cord disconnected before installing the CPU.

2. Pull the lever sideways away from the socket, and raise it up to a 90-degree angle.

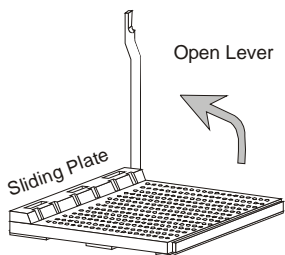

3. Locate the cut edge of the CPU. When the CPU is installed into the socket, this cut edge should be aligned with the corner marking an arrow on the Socket 940.

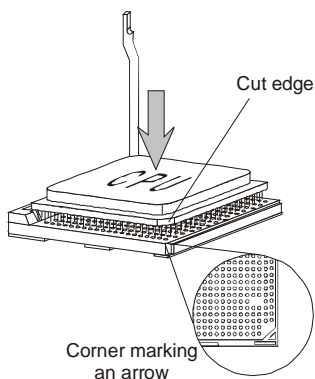

Please note that the CPU can only fit in a correct orientation, DO NOT use force to install the CPU into the socket.

4. Place the CPU onto the socket and press it down firmly into the socket. The pins of the CPU should be embedded into the socket completely.

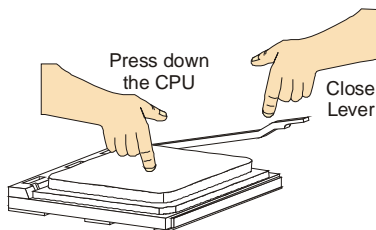

5. Close the lever to secure the CPU. Do not close the lever until the CPU's pins are fully inserted; otherwise, the pins may be damaged.

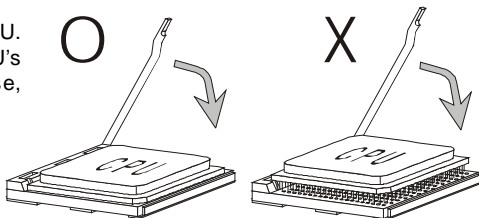

Installing AMD Opteron™ CPU Cooling System

When you are installing the CPU, **make sure the CPU has a heat sink and a cooling fan attached on the top to prevent overheating.** If you do not find the heat sink and cooling fan, contact your dealer to purchase and install them before turning on the computer.



MSI Reminds You...

Please refer to the recommended CPU fans at AMD® official website or consult the vendors for proper CPU cooling fan.

u For CPU2

1. Locate the 4 screws of the heatsink to the 4 screw holes in the CPU area on the mainboard.
2. Use the screw driver to fasten each screw into each screw hole. Please note the orientation of the heatsink/cooler for CFAN2 should be the same as shown below to prevent the intervention with AGP card.

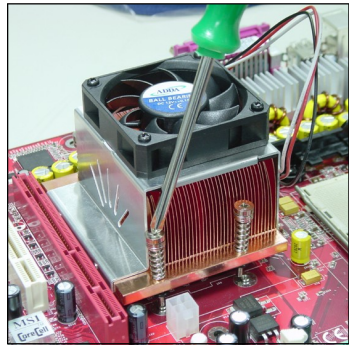
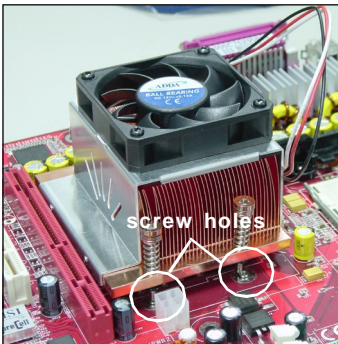

MSI Reminds You...

Overheating

Overheating will seriously damage the CPU and system, always make sure the cooling fan can work properly to protect the CPU from overheating.

Replacing the CPU

While replacing the CPU, always turn off the power supply or unplug the power supply's power cord from grounded outlet first to ensure the safety of CPU.

u For CPU1

1. Locate the CPU and its retention modules on the motherboard.
2. Position the heatsink/cooler onto the retention modules. Connect the wires to the fan power connector (CFAN1), then press down the fan until its four clips get wedged in the holes of the retention modules.

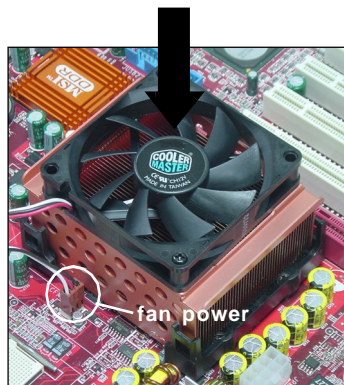
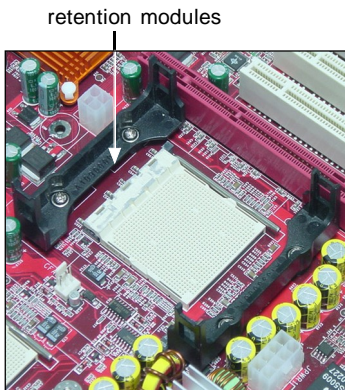

3. Hook one end of the clip into the hole of the retention module, then push down the handle to hook the other end to the retention module.
4. Repeat step 3 on the other clip.

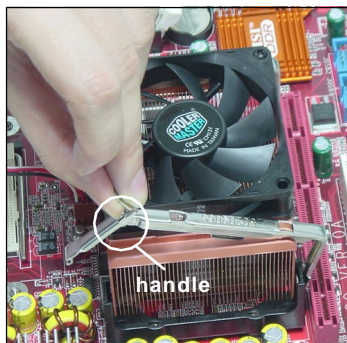

Memory

The mainboard provides four slots for 184-pin DDR SDRAM DIMM (Double In-Line Memory Module) modules and supports up to 8GB memory size. You can install PC3200/DDR400, PC2700/DDR333, PC2100/DDR266, or PC1600/DDR200 modules on the DDR DIMM slots (DDR 1~4).



**DDR DIMM Slots
(DDR1~4)**

Installing DDR Modules

1. The DDR DIMM has only one notch on the center of module. The module will only fit in the right orientation.
2. Insert the DIMM memory module vertically into the DIMM slot. Then push it in until the golden finger on the memory module is deeply inserted in the socket.



MSI Reminds You...

You can barely see the golden finger if the module is properly inserted in the socket.

3. The plastic clip at each side of the DIMM slot will automatically close.

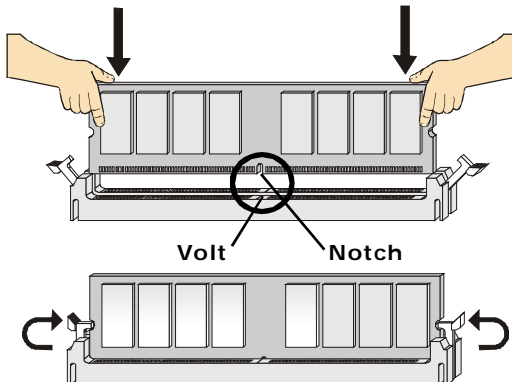

Memory Population Rules

The mainboard supports DDR200/266/333/400 memory interface.

Each DIMM slot supports up to a maximum size of 2GB. Users can install either single- or double-sided modules depending on their needs.

Memory modules can be installed in any combination as follows:

Slot	Memory Module Population Rules (Dual channel - 128 bits)		
DIMM 1	Install		Install
DIMM 2	Install		Install
DIMM 3		Install	Install
DIMM 4		Install	Install

Slot	Memory Module Population Rules (Single channel - 64 bits)		
DIMM 1	Install		Install
DIMM 2			
DIMM 3		Install	Install
DIMM 4			

For more information on compatible components, please visit http://www.msi.com.tw/program/products/server/svr/pro_svr_qvl.php.



MSI Reminds You...

Make sure that you install memory modules of the same type and density on DDR DIMMs.

Power Supply

The mainboard supports SSI power supply for the power system, while ATX power supply is also available for this mainboard. Before inserting the power supply connector, always make sure that all components are installed properly to ensure that no damage will be caused.

SSI 4-Pin VGA Power Connector: JPWR2 (Optional)

This connector is used to provide +12V power output to AGP Pro add-on card.



JPWR2 Pin Definition

PIN	SIGNAL
1	GND
2	GND
3	12V
4	12V

SSI 8-Pin CPU Power Connector: JPWR1

This connector is used to provide the power output to the CPU.

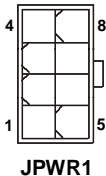

JPWR1 Pin Definition

PIN	SIGNAL	PIN	SIGNAL
1	GND	5	+12V
2	GND	6	+12V
3	GND	7	+12V
4	GND	8	+12V



MSI Reminds You...

For this JPWR1 power connector, you may use the 4-pin ATX power supply or 8-pin SSI power supply as you like. If you'd like to use the SSI power supply, please remove the sticker (covered the 1, 2, 5 and 6 pins, shown as the photo in the right) marked "SSI ONLY" on the JPWR1 power connector to insert the SSI power supply in the proper orientation for correct alignment. If you'd like to use the ATX power supply, please just insert your power supply in the rest pins without removing the sticker.



SSI 24-Pin System Power Connector: JPR1

This connector allows you to connect an SSI power supply. To connect the SSI power supply, make sure the plug of the power supply is inserted in the proper orientation and the pins are aligned. Then push down the power supply firmly into the connector.

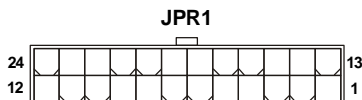

JPR1 Pin Definition

PIN	SIGNAL	PIN	SIGNAL
1	+3.3V	13	+3.3V
2	+3.3V	14	-12V
3	GND	15	GND
4	+5V	16	PS-ON#
5	GND	17	GND
6	+5V	18	GND
7	GND	19	GND
8	PWROK	20	Res
9	5VSB	21	+5V
10	+12V	22	+5V
11	+12V	23	+5V
12	+3.3V	24	GND



MSI Reminds You...

For this JPR1 power connector, you may use the 20-pin ATX power supply or 24-pin SSI power supply as you like. If you'd like to use the SSI power supply, please remove the sticker (covered the 11, 12, 23 and 24 pins, shown as the photo below) marked "SSI ONLY" on the JPR1 power connector to insert the SSI power supply in the proper orientation for correct alignment. If you'd like to use the ATX power supply, please just insert your power supply in the rest pins without removing the sticker.

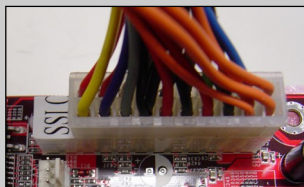

Back Panel

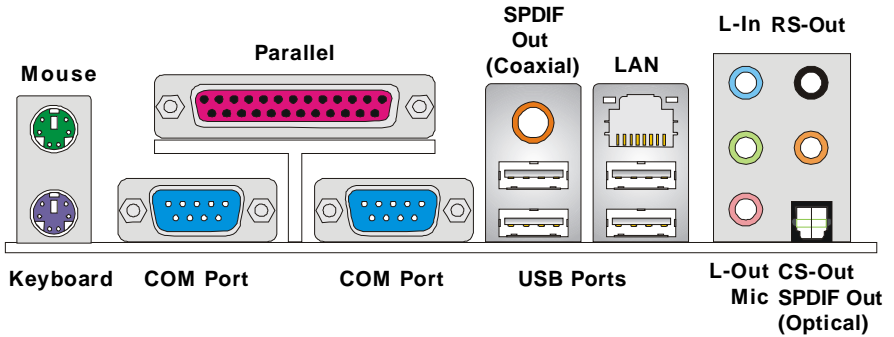

Mouse Connector (Green) / Keyboard Connector (Purple)

The mainboard provides a standard PS/2[®] mouse/keyboard mini DIN connector for attaching a PS/2[®] mouse/keyboard. You can plug a PS/2[®] mouse/keyboard directly into this connector. The connector location and pin assignments are as follows:

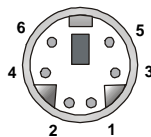

**PS/2 Mouse / Keyboard
(6-pin Female)**

Pin Definition

PIN	SIGNAL	DESCRIPTION
1	Mouse/Keyboard Data	Mouse/Keyboard data
2	NC	Noconnection
3	GND	Ground
4	VCC	+5V
5	Mouse/KeyboardClock	Mouse/Keyboard clock
6	NC	Noconnection

Serial Ports

The mainboard offers two 9-pin male DIN serial ports. The ports are 16550A high speed communications ports that send/receive 16 bytes FIFOs. You can attach a serial mouse or other serial devices directly to them.

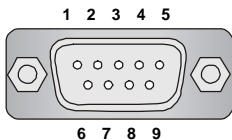

9-Pin Male DIN Connector

Pin Definition

PIN	SIGNAL	DESCRIPTION
1	DCD	Data Carry Detect
2	SIN	Serial In or Receive Data
3	SOUT	Serial Out or Transmit Data
4	DTR	Data Terminal Ready
5	GND	Ground
6	DSR	Data Set Ready
7	RTS	Request To Send
8	CTS	Clear To Send
9	RI	Ring Indicate

USB Connectors

The rear panel provides four OHCI (Open Host Controller Interface) Universal Serial Bus roots for attaching USB devices such as keyboard, mouse or other USB-compatible devices. You can plug the USB device directly into them.

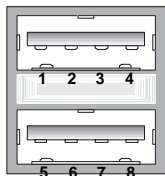

USB Ports

USB Port Description

PIN	SIGNAL	DESCRIPTION
1	VCC	+5V
2	-Data 0	Negative Data Channel 0
3	+Data0	Positive Data Channel 0
4	GND	Ground
5	VCC	+5V
6	-Data 1	Negative Data Channel 1
7	+Data 1	Positive Data Channel 1
8	GND	Ground

RJ-45 LAN Jack

The mainboard provides 1 standard RJ-45 jack for connection to single Local Area Network (LAN). This Giga-bit LAN enables data to be transferred at 1000, 100 or 10Mbps. You can connect a network cable to it.

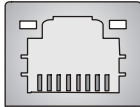

RJ-45 LAN Jack

Giga-bit LAN Pin Definition

PIN	SIGNAL	DESCRIPTION
1	D0P	Differential Pair 0+
2	D0N	Differential Pair 0-
3	D1P	Differential Pair 1+
4	D2P	Differential Pair 2+
5	D2N	Differential Pair 2-
6	D1N	Differential Pair 1-
7	D3P	Differential Pair 3+
8	D3N	Differential Pair 3-

Audio Port Connectors

The left 3 audio jacks are 2-channel mode for stereo speaker output. **Line Out** is a connector for Speakers or Headphones. **Line In** is used for external CD player, Tape player, or other audio devices. **Mic** is a connector for microphones.

However, there is an advanced audio application provided by Realtek ALC850 to offer support for **7.1-channel audio operation** and can turn rear audio connectors from 2-channel to 4-/5.1-/7.1 channel audio.



S/PDIF Out-Coaxial

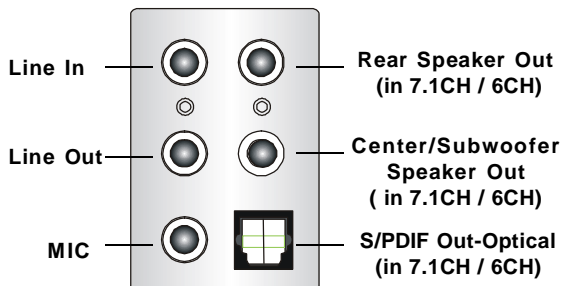

Parallel Port Connector: LPT1

The mainboard provides a 25-pin female centronic connector as LPT. A parallel port is a standard printer port that supports Enhanced Parallel Port (EPP) and Extended Capabilities Parallel Port (ECP) mode.

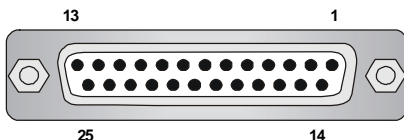

Pin Definition

PIN	SIGNAL	DESCRIPTION
1	STROBE	Strobe
2	DATA0	Data0
3	DATA1	Data1
4	DATA2	Data2
5	DATA3	Data3
6	DATA4	Data4
7	DATA5	Data5
8	DATA6	Data6
9	DATA7	Data7
10	ACK#	Acknowledge
11	BUSY	Busy
12	PE	PaperEnd
13	SELECT	Select
14	AUTO FEED#	AutomaticFeed
15	ERR#	Error
16	INIT#	Initialize Printer
17	SLIN#	Select In
18	GND	Ground
19	GND	Ground
20	GND	Ground
21	GND	Ground
22	GND	Ground
23	GND	Ground
24	GND	Ground
25	GND	Ground

Connectors

The mainboard provides connectors to connect to FDD, IDE HDD, case, LAN, USB Ports, CPU/system power supply fans, ... and etc.

Floppy Disk Drive Connector: FDD1

The mainboard provides a standard floppy disk drive connector that supports 360K, 720K, 1.2M, 1.44M and 2.88M floppy disk types.

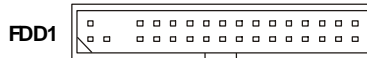

Hard Disk Connectors: IDE1, IDE2

The mainboard provides a 32-bit Enhanced PCI IDE and Ultra DMA 33/66/100/133 controller that supports PIO mode 0 ~ 4, Bus Master, and Ultra DMA 33/66/100/133 function. You can connect up to four hard disk drives, CD-ROM drives, 120MB floppy disk drive (reserved for future BIOS), and other devices.

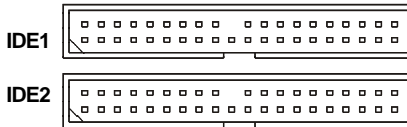

IDE1 (Primary IDE Connector)

The first hard drive should always be connected to IDE1. IDE1 can connect a Master and a Slave drive. You must configure second hard drive to Slave mode by setting the jumper accordingly.

IDE2 (Secondary IDE Connector)

IDE2 can also connect a Master and a Slave drive.



MSI Reminds You...

If you install two hard disks on cable, you must configure the second drive to Slave mode by setting its jumper. Refer to the hard disk documentation supplied by hard disk vendors for jumper setting instructions.

Serial ATA/Serial ATA RAID Connectors: SATA1, SATA2

SATA1 & SATA2 are dual high-speed Serial ATA interface ports. Each supports 1st generation serial ATA data rates of 150 MB/s. Both connectors are fully compliant with Serial ATA 1.0 specifications. Each Serial ATA connector can connect to 1 hard disk device. Please refer to *Appendix VIA VT8237 Serial ATA RAID* for detailed software installation procedures.

SATA1/2 Pin Definition

PIN	SIGNAL	PIN	SIGNAL
1	GND	2	TXP
3	TXN	4	GND
5	RXN	6	RXP
7	GND		

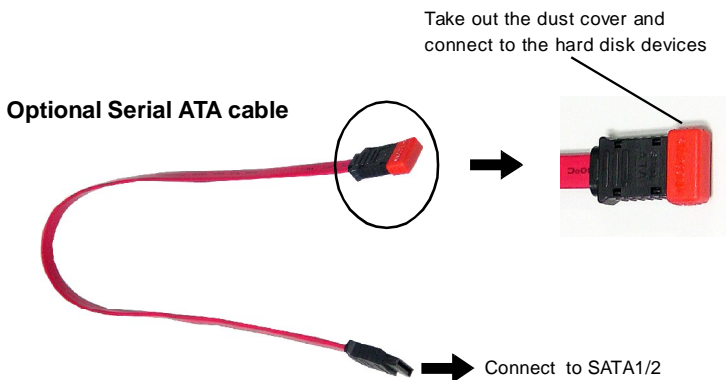
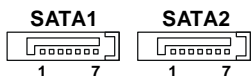

MSI Reminds You...

Please do not fold the Serial ATA cable into 90-degree angle. Otherwise, the loss of data may occur during transmission.

SCSI LED Connector: J7

Connect the J7 to the LED connector on the add-on SCSI adaptor and the HDD LED will blink when add-on SCSI device is active.

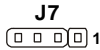

Pin Definition

PIN	SIGNAL
1	VCC5
2	SCSI LED
3	HDD LED
4	VCC5

Fan Power Connectors: CFAN1/2, SFAN1, NBFAN1

The fan power connectors support system cooling fan with +12V. When connecting the wire to the connectors, always note that the red wire is the positive and should be connected to the +12V; the black wire is Ground and should be connected to GND. If the mainboard has a System Hardware Monitor chipset onboard, you must use a specially designed fan with speed sensor to take advantage of the CPU fan control.

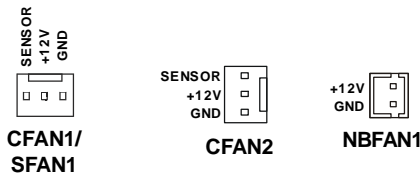

MSI Reminds You...

Please refer to the recommended CPU fans at AMD® official website or consult the vendors for proper CPU cooling fan.

IrDA Infrared Module Header: JIR1

The connector allows you to connect to IrDA Infrared module. You must configure the setting through the BIOS setup to use the IR function. JIR1 is compliant with Intel® Front Panel I/O Connectivity Design Guide.



Pin Definition

Pin	Signal
1	NC
2	NC
3	VCC5
4	GND
5	IRTX
6	IRRX

Front Panel Audio Connector: JAUD1

The JAUD1 front panel audio connector allows you to connect to the front panel audio and is compliant with Intel® Front Panel I/O Connectivity Design Guide.



Pin Definition

PIN	SIGNAL	DESCRIPTION
1	AUD_MIC	Front panel microphone input signal
2	AUD_GND	Ground used by analog audio circuits
3	AUD_MIC_BIAS	Microphone power
4	AUD_VCC	Filtered +5V used by analog audio circuits
5	AUD_FPOUT_R	Right channel audio signal to front panel
6	AUD_RET_R	Right channel audio signal return from front panel
7	HP_ON	Reserved for future use to control headphone amplifier
8	KEY	No pin
9	AUD_FPOUT_L	Left channel audio signal to front panel
10	AUD_RET_L	Left channel audio signal return from front panel



MSI Reminds You...

If you don't want to connect to the front audio header, pins 5 & 6, 9 & 10 have to be jumpered in order to have signal output directed to the rear audio ports. Otherwise, the Line-Out connector on the back panel will not function.



Chassis Intrusion Switch Connector: JCI1

This connector is connected to a 2-pin chassis switch. If the chassis is opened, the switch will be short. The system will record this status and show a warning message on the screen. To clear the warning, you must enter the BIOS utility and clear the record.



CD-In Connector: JCD1

The connector is for CD-ROM audio connector.

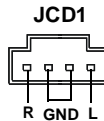

Front Panel Connectors: JFP1, JFP2

The mainboard provides two front panel connectors for electrical connection to the front panel switches and LEDs. The JFP1 is compliant with Intel® Front Panel I/O Connectivity Design Guide.

JFP1 Pin Definition

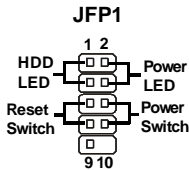

PIN	SIGNAL	DESCRIPTION
1	HD_LED_P	Hard disk LED pull-up
2	FPPWR/SLP	MSG LED pull-up
3	HD_LED_N	Hard disk active LED
4	FPPWR/SLP	MSG LED pull-up
5	RST_SW_N	Reset Switch low reference pull-down to GND
6	PWR_SW_P	Power Switch high reference pull-up
7	RST_SW_P	Reset Switch high reference pull-up
8	PWR_SW_N	Power Switch low reference pull-down to GND
9	RSVD_DNU	Reserved. Do not use.

JFP2 Pin Definition

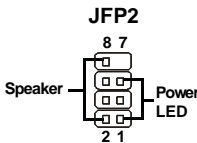

PIN	SIGNAL	PIN	SIGNAL
1	GND	2	SPK-
3	SLED	4	BUZ+
5	PLED	6	BUZ-
7	NC	8	SPK+

D-Bracket™ 2 Connector: JLED







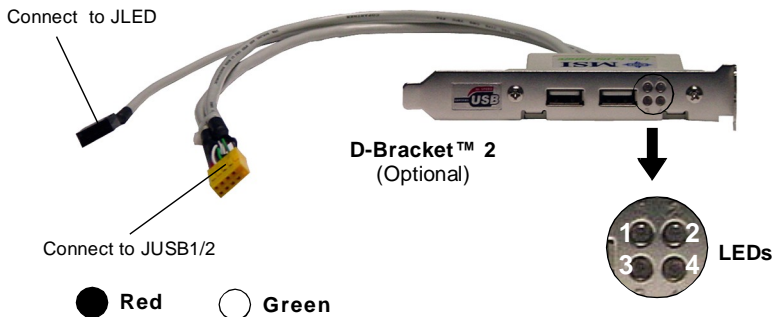
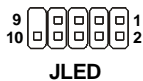





The mainboard comes with a JLED connector for you to connect to D-Bracket™ 2. D-Bracket™ 2 is an external USB Bracket that supports both USB1.1 & 2.0 spec. It integrates four LEDs and allows users to identify system problems through 16 various combinations of LED signals.

Pin Definition

Pin	Signal
1	DBG1 (high for green color)
2	DBR1 (high for red color)
3	DBG2 (high for green color)
4	DBR2 (high for red color)
5	DBG3 (high for green color)
6	DBR3 (high for red color)
7	DBG4 (high for green color)
8	DBR4 (high for red color)
9	Key
10	NC



D-Bracket™ 2	Description
	System Power ON The D-LED will hang here if the processor is damaged or not installed properly.
	Early Chipset Initialization
	Memory Detection Test Testing onboard memory size. The D-LED will hang if the memory module is damaged or not installed properly.
	Operating System Booting

	<p>Decompressing BIOS image to RAM for fast booting.</p>
	<p>Initializing Keyboard Controller.</p>
	<p>Testing VGA BIOS This will start writing VGA sign-on message to the screen.</p>
	<p>Processor Initialization This will show information regarding the processor (like brand name, system bus, etc...)</p>
	<p>Testing RTC (Real Time Clock)</p>
	<p>Initializing Video Interface This will start detecting CPU clock, checking type of video onboard. Then, detect and initialize the video adapter.</p>
	<p>BIOS Sign On This will start showing information about logo, processor brand name, etc...</p>
	<p>Testing Base and Extended Memory Testing base memory from 240K to 640K and extended memory above 1MB using various patterns.</p>
	<p>Assign Resources to all ISA.</p>
	<p>Initializing Hard Drive Controller This will initialize IDE drive and controller.</p>
	<p>Initializing Floppy Drive Controller This will initialize Floppy Drive and controller.</p>
	<p>Boot Attempt This will set low stack and boot via INT 19h.</p>

Front USB Connectors: JUSB1, JUSB2

The mainboard provides two standard USB 2.0 pin headers. USB 2.0 technology increases data transfer rate up to a maximum throughput of 480Mbps, which is 40 times faster than USB 1.1, and is ideal for connecting high-speed USB interface peripherals such as **USB HDD, digital cameras, MP3 players, printers, modems and the like.**

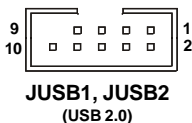

Pin Definition

PIN	SIGNAL	PIN	SIGNAL
1	VCC	2	VCC
3	USB0-	4	USB1-
5	USB0+	6	USB1+
7	GND	8	GND
9	Key (no pin)	10	USBOC

Connect to JUSB1/JUSB2
(the USB pinheader in **YELLOW** color)



MSI Reminds You...

Note that the pins of VCC and GND must be connected correctly to avoid possible damage.

Jumper

The motherboard provides the following jumpers for you to set the computer's function. This section will explain how to change your motherboard's function through the use of jumpers.

Clear CMOS Jumper: JBAT1

There is a CMOS RAM on board that has a power supply from external battery to keep the data of system configuration. With the CMOS RAM, the system can automatically boot OS every time it is turned on. If you want to clear the system configuration, use the JBAT1 (Clear CMOS Jumper) to clear data.

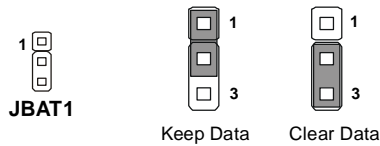

MSI Reminds You...

You can clear CMOS by shorting 2-3 pin while the system is off. Then return to 1-2 pin position. Avoid clearing the CMOS while the system is on; it will damage the mainboard.

Slots

This mainboard provides one AGP Pro slot and four 32-bit/33MHz PCI slots.

AGP (Accelerated Graphics Port) Pro Slot

AGP Pro is a Hardware Interface for high-power graphics cards which can deliver more electrical power than the standard AGP Hardware Interface. It is simply an extended slot that adds power pins to both ends of the slot to facilitate certain graphics cards' added power requirements. Because of its added pins, an AGP Pro card won't fit into a standard slot.

For the same reason, however, motherboards with a wider AGP Pro slot can accommodate a standard card. In this case, the added power pins of an AGP Pro slot go safely unused.



PCI (Peripheral Component Interconnect) Slots

The PCI slots allow you to insert the expansion cards to meet your needs. When adding or removing expansion cards, make sure that you unplug the power supply first. Meanwhile, read the documentation for the expansion card to make any necessary hardware or software settings for the expansion card, such as jumpers, switches or BIOS configuration.

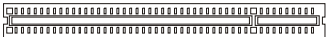

PCI Interrupt Request Routing

The IRQ, acronym of interrupt request line and pronounced I-R-Q, are hardware lines over which devices can send interrupt signals to the microprocessor. The PCI IRQ pins are typically connected to the PCI bus INT A# ~ INT D# pins as follows:

	Order 1	Order 2	Order 3	Order 4
PCI Slot 1	INT A#	INT B#	INT C#	INT D#
PCI Slot 2	INT B#	INT C#	INT D#	INT A#
PCI Slot 3	INT C#	INT D#	INT A#	INT B#
PCI Slot 4	INT D#	INT A#	INT B#	INT C#

3

BIOS Setup

This chapter provides information on the BIOS Setup program and allows you to configure the system for optimum use. You may need to run the Setup program when:

- ² An error message appears on the screen during the system booting up, and requests you to run SETUP.
- ² You want to change the default settings for customized features.



MSI Reminds You...

1. The items under each BIOS category described in this chapter are under continuous update for better system performance. Therefore, the description may be slightly different from the latest BIOS and should be held for reference only.

2. Upon boot-up, the 1st line appearing after the memory count is the BIOS version. It is usually in the format:

W9617VMS V1.0 150305 where:

1st digit refers to BIOS maker as A = AMI, W = AWARD, and P = PHOENIX.

2nd - 5th digit refers to the model number.

6th digit refers to the chipset as I = Intel, N = nVidia, and V = VIA.

7th - 8th digit refers to the customer as MS = all standard customers.

V1.0 refers to the BIOS version.

150305 refers to the date this BIOS was released.

Entering Setup

Power on the computer and the system will start POST (Power On Self Test) process. When the message below appears on the screen, press key to enter Setup.

Press DEL to enter SETUP

If the message disappears before you respond and you still wish to enter Setup, restart the system by turning it OFF and On or pressing the RESET button. You may also restart the system by simultaneously pressing <Ctrl>, <Alt>, and <Delete> keys.

Control Keys

<↑>	Move to the previous item
<↓>	Move to the next item
<←>	Move to the item in the left hand
<→>	Move to the item in the right hand
<Enter>	Select the item
<Esc>	Jumps to the Exit menu or returns to the main menu from a submenu
<+/PU>	Increase the numeric value or make changes
<-/PD>	Decrease the numeric value or make changes
<F1>	General help, only for Status Page Setup Menu and Option Page Setup Menu
<F5>	Load Previous Values
<F6>	Load Fail-safe Defaults
<F7>	Load Optimized Defaults
<F10>	Save and Exit Setup

Getting Help

After entering the Setup menu, the first menu you will see is the Main Menu.

Main Menu

The main menu lists the setup functions you can make changes to. You can use the control keys ($\uparrow\downarrow$) to select the item. The on-line description of the highlighted setup function is displayed at the bottom of the screen.

Sub-Menu

If you find a right pointer symbol (as shown in the right view) appears to the left of certain fields that means a sub-menu containing additional options can be launched from this field. You can use control keys ($\uparrow\downarrow$) to highlight the field and press <Enter> to call up the sub-menu. Then you can use the control keys to enter values and move from field to field within a sub-menu. If you want to return to the main menu, just press <Esc >.

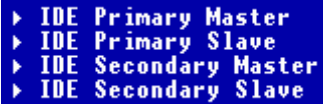

```
▶ IDE Primary Master
▶ IDE Primary Slave
▶ IDE Secondary Master
▶ IDE Secondary Slave
```

General Help <F1>

The BIOS setup program provides a General Help screen. You can call up this screen from any menu by simply pressing <F1>. The Help screen lists the appropriate keys to use and the possible selections for the highlighted item. Press <Esc> to exit the Help screen.

The Main Menu

Once you enter Phoenix-Award Workstation BIOS CMOS Setup Utility, the Main Menu will appear on the screen. The Main Menu allows you to select from several setup functions and two exit choices. Use arrow keys to select among the items and press <Enter> to accept or enter the sub-menu.

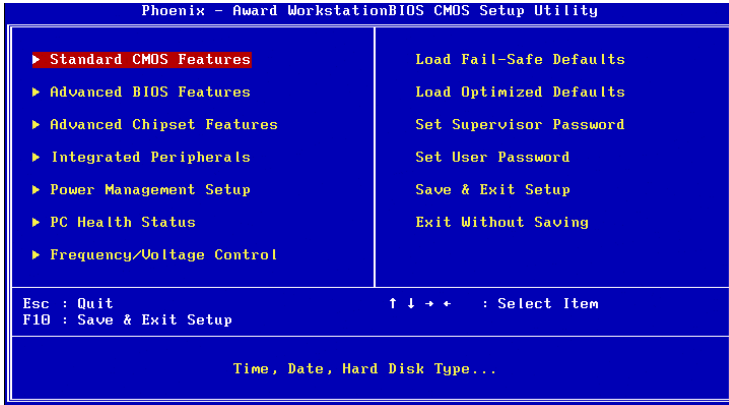

Standard CMOS Features

Use this menu for basic system configurations, such as time, date etc.

Advanced BIOS Features

Use this menu to setup the items of Award® special enhanced features.

Advanced Chipset Features

Use this menu to change the values in the chipset registers and optimize your system's performance.

Integrated Peripherals

Use this menu to specify your settings for integrated peripherals.

Power Management Setup

Use this menu to specify your settings for power management.

PC Health Status

This entry shows your PC health status.

Frequency/Voltage Control

Use this menu to specify your settings for frequency/voltage control.

Load Fail-Safe Defaults

Use this menu to load the BIOS values for the best system performance, but the system stability may be affected.

Load Optimized Defaults

Use this menu to load factory default settings into the BIOS for stable system performance operations.

Set Supervisor Password

Use this menu to set Supervisor Password.

Set User Password

Use this menu to set User Password.

Save & Exit Setup

Save changes to CMOS and exit setup.

Exit Without Saving

Abandon all changes and exit setup.

Standard CMOS Features

The items in Standard CMOS Features Menu are divided into 11 categories. Each category includes no, one or more than one setup items. Use the arrow keys to highlight the item and then use the <PgUp> or <PgDn> keys to select the value you want in each item.

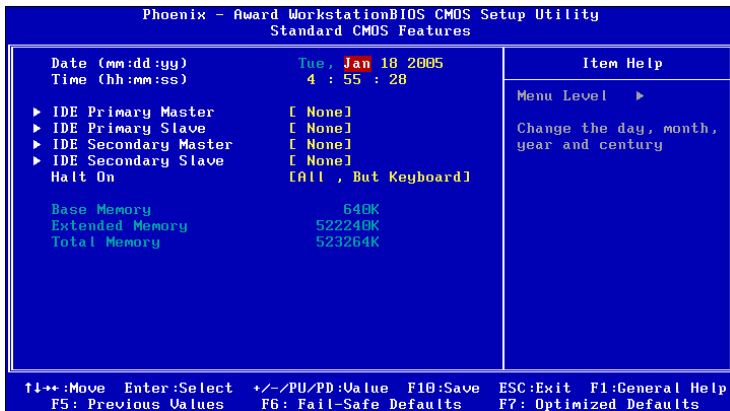

Date

The date format is <day> <month> <date> <year>.

- [day] Day of the week, from Sun to Sat, determined by BIOS. Read-only.
- [month] The month from Jan. through Dec.
- [date] The date from 1 to 31 can be keyed by numeric function keys.
- [year] The year can be adjusted by users.

Time

The time format is <hour> <minute> <second>.

IDE Primary/Secondary Master/Slave

Press PgUp/<+> or PgDn/<-> to select [Manual], [None] or [Auto] type. Note that the specifications of your drive must match with the drive table. The hard disk will not work properly if you enter improper information for this category. If your hard disk drive type is not matched or listed, you can use [Manual] to define your own drive type manually.

If you select [Manual], related information is asked to be entered to the following items. Enter the information directly from the keyboard. This information should be provided in the documentation from your hard disk vendor or the system manufacturer.

- [Access Mode] The settings are CHS, LBA, Large, Auto.
- [Capacity] The formatted size of the storage device.

[Cylinder]	Number of cylinders.
[Head]	Number of heads.
[Precomp]	Write precompensation.
[Landing Zone]	Cylinder location of the landing zone.
[Sector]	Number of sectors.

Halt On

The setting determines whether the system will stop if an error is detected at boot.

Available options are:

[All Errors]	The system stops when any error is detected.
[Disabled]	The system doesn't stop for any detected error.
[All, But Keyboard]	The system doesn't stop for a keyboard error.
[All, But Diskette]	The system doesn't stop for a disk error.
[All, But Disk/Key]	The system doesn't stop for either a disk or a keyboard error.

Base/Extended/Total Memory

The three items show the memory status of your system (read only).

Advanced BIOS Features

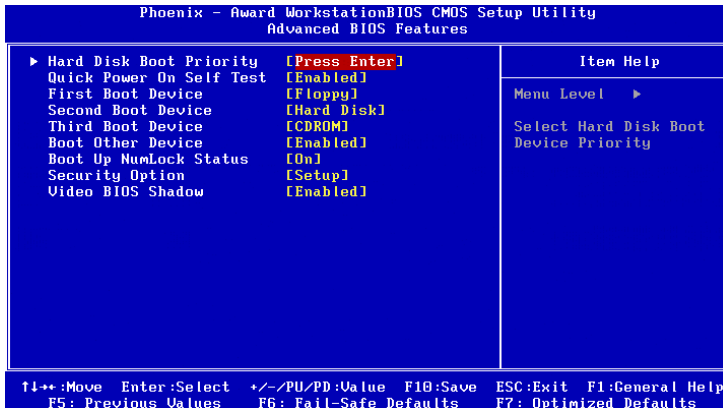

Hard Disk Boot Priority

Press <Enter> and the following sub-menu appears:

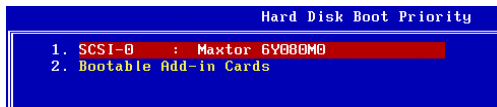

Select the hard disk priority (from the 1st to the 8th) in this list. Use the arrow-up and arrow-down keys to select a device, then press <+> to move it up or <-> to move it down.

Quick Power On Self Test

Select *Enabled* to reduce the amount of time required to run the power-on self-test (POST). A quick POST skips certain steps. We recommend that you normally disable quick POST. Better to find a problem during POST than lose data during your work.

First/Second/Third Boot Device

The items allow you to set the sequence of boot devices where BIOS attempts to load the disk operating system.

Boot Other Device

Setting the option to [Enabled] allows the system to try to boot from other device if the system fails to boot from the 1st/2nd/3rd boot device.

Boot Up NumLock Status

Toggle between [On] or [Off] to control the state of the NumLock key when the system boots. When toggled [On], the numeric keypad generates numbers instead of controlling cursor operations.

Security Option

This specifies the type of BIOS password protection that is implemented. Settings are described below:

Option	Description
<i>Setup</i>	The password prompt appears only when end users try to run Setup.
<i>System</i>	A password prompt appears every time when the computer is powered on or when end users try to run Setup.

Video BIOS Shadow

This allows you to copy Video BIOS to shadow RAM. When setting to [Enabled], the performance improves. Settings: [Enabled] and [Disabled].

Advanced Chipset Features

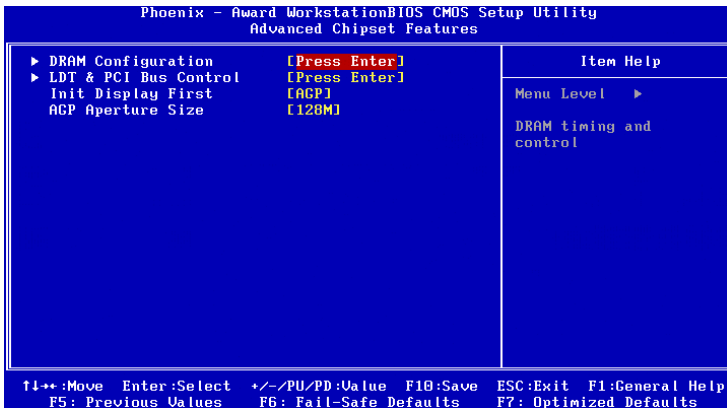

MSI Reminds You...

Change these settings only if you are familiar with the chipset.

DRAM Configuration

Press <Enter> and the following sub-menu appears:

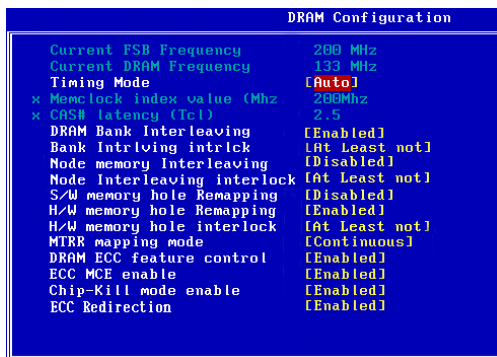

Current FSB Frequency, Current DRAM Frequency

Those two items are read-only to show the current FSB and DRAM Frequency information.

Timing Mode

This field has the capacity to automatically detect all of the DRAM timing. If you set this field to [Manual], the following fields will be selectable. The settings are: [Auto], [Manual].

Memclock index value (Mhz)

When it is set to [Manual] in **Timing Mode**, user can place an artificial memory clock on the system. Please note that memory is prevented from running faster than this frequency.

CAS# Latency (Tcl)

When the **Timing Mode** is set to [Manual], the field is adjustable. This controls the CAS latency, which determines the timing delay (in clock cycles) before SDRAM starts a read command after receiving it. Settings: [Auto], [CL2.0], [CL=2.5], [CL=3.0]. [CL=2.0] increases the system performance the most while [CL=3.0] provides the most stable performance.

DRAM Bank Interleaving

This field selects 2-bank or 4-bank interleave for the installed SDRAM. Disable the function if 16MB SDRAM is installed. Settings: [Disabled], [2-Way], [4-Way].

Bank Intrlving Intrlck

This setting controls the bank interleaving interlock times. Options: [At least not], [All present are].

Node Memory Interleaving

Interleave memory blocks across Processor Nodes. BIOS will AUTO detect the capability of Memory System. Options: [Disabled], [AUTO].

Node Interleaving Interlock

This setting controls the node interlock times. Options: [At least not], [All present are].

S/W Memory Hole Remapping

This field enables software to remap the physical memory to the address higher than 00E0. (This item only activities in 64-bit OS) Setting options: [Disabled], [Enabled].

H/W memory hole Remapping

This field enables hardware to remap the physical memory to the address higher than 00E0. (This item only activities in 64-bit OS.) Setting options: [Disabled], [Enabled].

H/W memory hole interlock

This setting controls the hardware memory hole interlock times. Options: [At least not], [All present are].

MTRR Mapping Mode

This setting controls the MTRR mapping mode. To install the WinXP64, this setting should be set to [Continuous]. Setting options: [Continuous], [Discrete].

DRAM ECC Feature Control

If all memory in the system supports ECC, enabling this will initial scrub dram and enable system requests to dram to be checked and/or corrected. Options: [Enabled], [Disabled].

ECC MCE Enable

This setting enables/disables the ECC MCE function. Options: [Enabled], [Disabled].

Chip-Kill Mode Enable

This item allows you to enable/disable Chip-Kill ECC on Nodes with all x4 ECC capable dimms. Options: [Enabled], [Disabled].

ECC Redirection

Enable Scrubber to correct errors detected in DRAM during normal CPU requests (foreground scrubbing). Options: [Enabled], [Disabled].

LDT & PCI Bus Control

Press <Enter> and the following sub-menu appears:

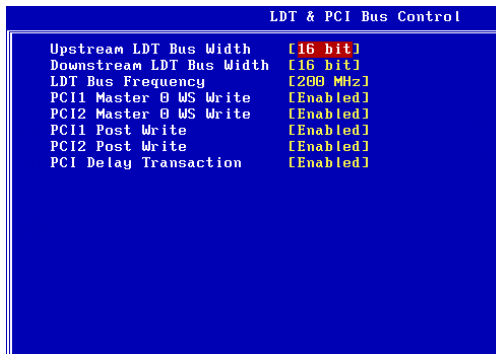

Upstream / Downstream LDT Bus Width

These two item control the utilized widths of the HyperTransport link. Setting options: [8 bit], [16 bit].

LDT Bus Frequency

This item specifies the maximum operating frequency of the link's transmitter clock. Setting options: [Auto], [800 MHz], [600 MHz], [400 MHz], [200 MHz].

PCI1/PCI2 Master 0 WS Write

When [Enabled], writes to the PCI bus are executed with zero wait state.

PCI1/PCI2 Post Write

You can enable or disable the ability of the chipset to use a buffer for posted writes initiated on the PCI bus. Setting options: [Disabled], [Enabled].

PCI Delay Transaction

The chipset has an embedded 32-bit posted write buffer to support delay transactions cycles. Select [Enabled] to support compliance with PCI specification version 2.1.

Init Display First

This item specifies which VGA card is your primary graphics adapter. Settings: [PCI Slot], [AGP].

AGP Aperture Size

This setting controls just how much system RAM can be allocated to AGP for video purposes. The aperture is a portion of the PCI memory address range dedicated to graphics memory address space. Host cycles that hit the aperture range are forwarded to the AGP without any translation.

Integrated Peripherals

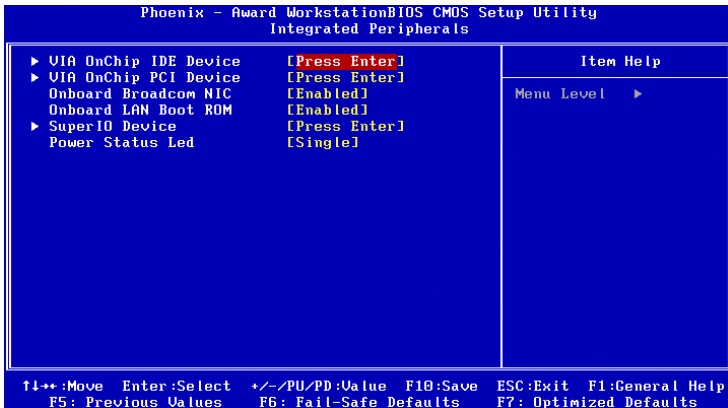

VIA OnChip IDE Device

Press <Enter> and the following sub-menu appears.

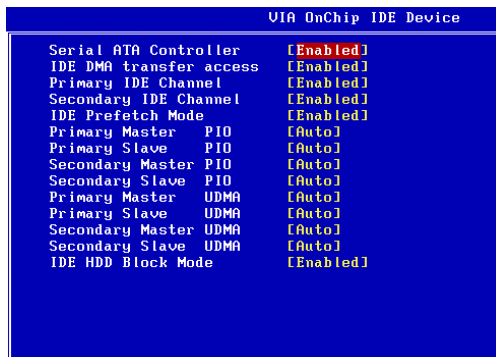

Serial ATA Controller

This allows you to enable or disable onchip Serial ATA controller. Settings: [Disabled] and [Enabled].

IDE DMA Transfer Access

Setting to [Enabled] will open DMA bus master and execute DMA action in DOS, which will make the data transferring faster. Settings: [Disabled], [Enabled].

Primary/Secondary IDE Channel

The chipset contains a PCI IDE interface with support for two IDE channels. Select [Enabled] to activate the first and/or second IDE interface. Select [Disabled] to deactivate an interface, if you install a primary and/or secondary add-in IDE interface.

IDE Prefetch Mode

The onboard IDE drive interfaces support IDE prefetching, for faster drive accesses. When you install a primary and/or secondary add-in IDE interface, set this option to [Disabled] if the interface does not support prefetching.

Primary/Secondary Master/Slave PIO

The four IDE PIO (Programmed Input/Output) fields let you set a PIO mode (0-4) for each of the four IDE devices that the onboard IDE interface supports. Modes 0 through 4 provide successively increased performance. In [Auto] mode, the system automatically determines the best mode for each device. The settings are: [Auto], [Mode 0], [Mode 1], [Mode 2], [Mode 3], [Mode 4].

Primary/Secondary Master/Slave UDMA

Ultra DMA 33/66/100/133 implementation is possible only if your IDE hard drive supports it and the operating environment includes a DMA driver (Windows ME, XP or a third-party IDE bus master driver). If your hard drive and your system software both support Ultra DMA/33, Ultra DMA/66, Ultra DMA/100 and Ultra DMA/133, select [Auto] to enable BIOS support. Settings: [Auto], [Disabled].

IDE HDD Block Mode

Block mode is also called block transfer, multiple commands, or multiple sector read/write. If your IDE hard drive supports block mode (most new drives do), select [Enabled] for automatic detection of the optimal number of block read/write per sector the drive can support. Setting options: [Disabled], [Enabled].

VIA OnChip PCI Device

Press <Enter> and the following sub-menu appears.

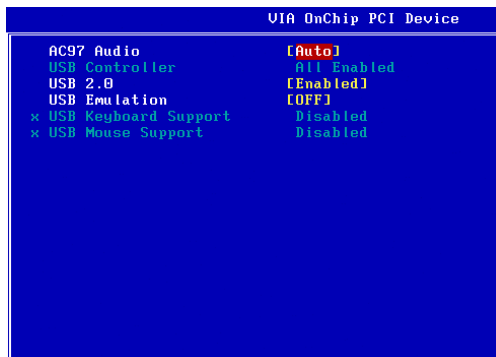

AC97 Audio

[Auto] allows the motherboard's BIOS to detect whether you're using any audio device. If so, the onboard audio controller will be enabled. If not, the onboard audio controller will be disabled. If you want to use different controller cards to connect audio connectors, set the field to [Disabled]. Setting options: [Disabled], [Auto].

USB Controller

Select [Enabled] if your system integrates a Universal Serial Bus (USB) controller and you have USB peripherals. Settings: [All Enabled], [All Disabled], [1&2 USB Port], [2&3 USB Port], [1&3 USB Port], [1 USB Port], [2 USB Port], [3 USB Port].

USB 2.0

Set to [Enabled] if you need to use any USB 2.0 device in the operating system that does not support or have any USB 2.0 driver installed, such as DOS and SCO Unix. Setting options: [Disabled], [Enabled].

USB Emulation

This setting controls the USB Port 64/60 Emulation function. Available setting options are:

- | | |
|---------|---|
| [OFF] | No USB legacy support. |
| [ON] | Supports USB keyboard/mouse and USB storage. When set to [ON], there will be an additional bootable USB device list in the " Boot Device " related settings under the Advanced BIOS Features menu. Users can then select the USB device they want to boot from. |
| [KB/MS] | Supports USB keyboard/mouse under DOS. |

USB Keyboard/Mouse Support

Select [Enabled] if you need to use a USB-interfaced keyboard or mouse in the operating system. Setting options: [Enabled], [Disabled].

Onboard Broadcom NIC

This item enables or disables the initialization of the onboard Broadcom NIC (network interface card). Setting options: [Enabled], [Disabled].

Onboard LAN Boot ROM

This item enables or disables the initialization of the onboard LAN Boot ROMs during bootup. Selecting [Disabled] will speed up the boot process. Setting options: [Disabled], [Enabled].

SuperIO Device

Press <Enter> and the following sub-menu appears.

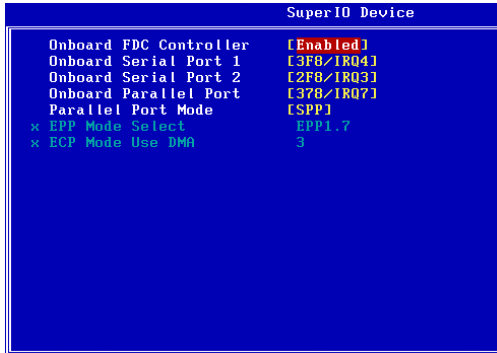

Onboard FDC Controller

Select [Enabled] if your system has a floppy disk controller (FDD) installed on the system board and you wish to use it. If you install add-on FDC or the system has no floppy drive, select [Disabled] in this field. Setting options: [Enabled], [Disabled].

Onboard Serial Port 1/2

These items specify the base I/O port address and IRQ for the onboard Serial Port A (COM A)/Serial Port B (COM B). Selecting [Auto] allows BIOS to automatically determine the correct base I/O port address. Settings: [Disabled], [3F8/IRQ4], [2F8/IRQ3], [3E8/IRQ4], [2E8/IRQ3], [Auto].

Onboard Parallel Port

This specifies the I/O port address and IRQ of the onboard parallel port. Settings: [378/IRQ7], [278/IRQ5], [3BC/IRQ7], [Disabled].

Parallel Port Mode

This item selects the operating mode for the parallel port: [Normal], [SPP], [EPP], [ECP], or [ECP+EPP].

- [SPP] Standard Parallel Port
- [EPP] Enhanced Parallel Port
- [ECP] Extended Capability Port
- [ECP+EPP] Extended Capability Port + Enhanced Parallel Port
- [Normal] Standard Parallel Port + Bi-Directional Mode.

EPP Mode Select

This item selects the EPP mode. Settings: [EPP1.9], [EPP1.7].

ECP Mode Use DMA

The ECP mode has to use the DMA channel, so choose the onboard parallel port with the ECP feature. After selecting it, the following message will appear: "ECP Mode Use DMA." At this time, the user can choose between DMA channel [3] or [1].

Power Status LED

This item sets how the system uses Power LED on the case to indicate the suspend/sleep state. Settings are:

- [Single] The Power LED blinks to indicate the suspend/sleep state.
- [Dual] The Power LED changes its color to indicate the suspend/sleep state.

Power Management Setup

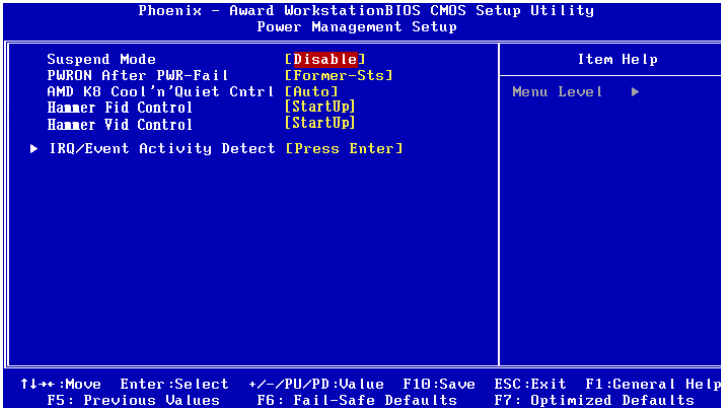

Suspend Mode

If system activity is not detected for the length of time specified in this field, all devices except CPU will be shut off. Settings: [Disable], [1 Min], [2 Min], [4 Min], [6 Min], [8 Min], [10 Min], [20 Min], [30 Min], [40 Min], [1 Hour].

PWRON After PWR-Fail

This item specifies whether your system will reboot after a power failure or interrupt occurs. Available settings are:

- [Off] Leaves the computer in the power off state.
- [On] Leaves the computer in the power on state.
- [Former-sts] Restores the system to the status before power failure or interrupt occurred.

AMD K8 Cool 'n' Quiet Cntrl

This feature is specifically designed for AMD Athlon processors. It provides a CPU temperature detecting function to prevent your CPU from overheating due to heavy workload. Setting options: [Disabled], [Auto].



MSI Reminds You...

To ensure the stability of Cool 'n' Quiet function, it is always recommended to have the memory modules plugged in DIMM1 first.

Hammer Fid Control

This item lets you adjust the CPU ratio. Setting to [Startup] enables the CPU running at the fastest speed which is detected by system. Setting options are: [Startup], [x4]~[x11].

Hammer Vid Control

This item lets you adjust the CPU VID. Setting to [Startup] enables the CPU running at the default VID which is detected by system. Setting options are: [Startup], [0.825V], [0.850V], [0.875V],~, [1.550V].

IRQ/Event Activity Detect

Press <Enter> and the following sub-menu appears.

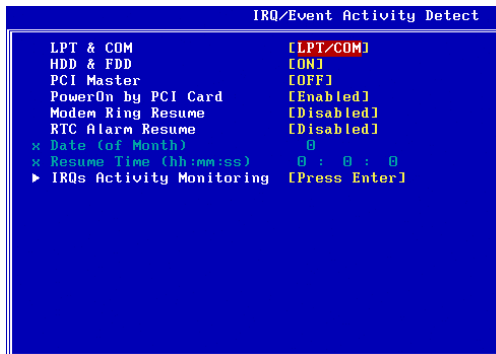

LPT & COM, HDD & FDD, PCI Master

These fields specify whether the system will be awakened from power saving modes when activity or input signal of the specified hardware peripheral or component is detected.

PowerOn by PCI Card

When it is set to [Enabled], the feature allows your system to be powered on by the PCI card. Setting options: [Enabled], [Disabled].

Modem Ring Resume

When it is set to [Enabled], the feature allows your system to support COM port Modem to resume. Setting options: [Enabled], [Disabled].

RTC Alarm Resume

When it is set to [Enabled], you can set the date and time at which the RTC (real-time clock) alarm awakens the system from Suspend mode.

Date (of Month)

The field specifies the date for **RTC Alarm Resume**. Settings: [0] ~ [31].

Resume Time (hh:mm:ss)

The field specifies the time for **RTC Alarm Resume**. Format is [hour] [minute] [second].



MSI Reminds You...

If you have changed this setting, you must let the system boot up until it enters the operating system, before this function will work.

IRQs Activity Monitoring

Press <Enter> and the following sub-menu appears.

IRQs Activity Monitoring	
Primary INTR	[ON]
IRQ3 (COM 2)	[Disabled]
IRQ4 (COM 1)	[Enabled]
IRQ5 (LPT 2)	[Enabled]
IRQ6 (Floppy Disk)	[Enabled]
IRQ7 (LPT 1)	[Enabled]
IRQ8 (RTC Alarm)	[Disabled]
IRQ9 (IRQ2 Redir)	[Disabled]
IRQ10 (Reserved)	[Disabled]
IRQ11 (Reserved)	[Disabled]
IRQ12 (PS/2 Mouse)	[Enabled]
IRQ13 (Coprocessor)	[Enabled]
IRQ14 (Hard Disk)	[Enabled]
IRQ15 (Reserved)	[Disabled]

Primary INTR

Setting [ON] will cause the system to wake up from power saving modes if activity is detected from any enabled IRQ channels. Setting options: [ON], [OFF].

IRQ3-IRQ15

IRQ3-IRQ15 enable or disable the monitoring of the specified IRQ lines. If set to [Enabled], the activity of the specified IRQ line will prevent the system from entering power saving modes or awaken it from power saving modes.

**MSI Reminds You...**

IRQ (Interrupt Request) lines are system resources allocated to I/O devices. When an I/O device needs to gain attention of the operating system, it signals this by causing an IRQ to occur. After receiving the signal, when the operating system is ready, the system will interrupt itself and perform the service required by the I/O device.

PC Health Status

This section shows the status of your CPU, fan, overall system status, etc. Monitor function is available only if there is hardware monitoring mechanism onboard.

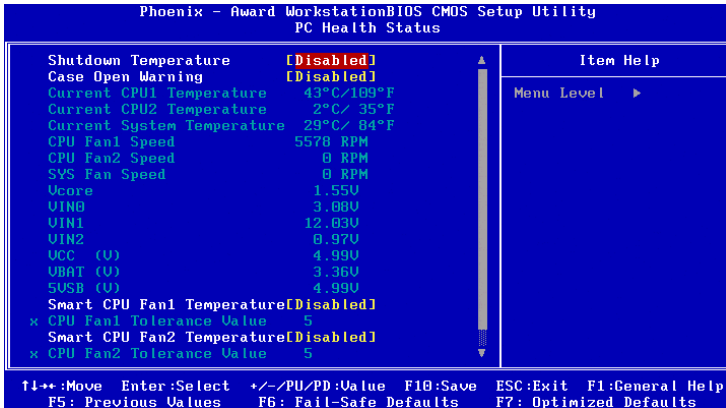

Shutdown Temperature

If the CPU temperature reaches the limit preset in this setting, the system will shutdown automatically. Setting options: [Disabled], [85C/185F], [90C/194F], [95C/203F].

Case Open Warning

The field enables or disables the feature of recording the chassis intrusion status and issuing a warning message if the case is once opened. To clear the warning message, set the field to [Reset]. The setting of the field will automatically return to [Enabled] later. Setting options: [Enabled], [Reset], [Disabled].

Current CPU1/CPU2/System Temperature, CPU Fan1/CPU Fan2/SYS Fan Speed, Vcore, VIN0/1/2, VCC (V), VBAT(V), 5VSB(V)

These items display the current status of all of the monitored hardware devices/components such as CPU voltages, temperatures and all fans' speeds.

Smart CPU Fan1/CPU Fan2/SYS Fan Temperature

There are 3 pairs of Temperature/FAN Speed control: CPU1 Temperature with CPU Fan1, CPU2 Temperature with CPU Fan2, System Temperature with SYS Fan. W83627THF provides the Smart Fan system which can control the fan speed automatically depending on the current temperature to keep it with in a specific range.

CPU Fan1/CPU Fan2/SYS Fan Tolerance Value

You can select a fan tolerance value here for the specific range for the **Smart CPU Fan1/CPU Fan2/SYS Fan Temperature** items. If the current temperatures of the 3 fans reach to the maximum threshold (the temperatures set in the **Smart CPU Fan1/CPU Fan2/SYS Fan Temperature** plus the tolerance values you set here), the fans will speed up for cooling down. On the contrary if the current temperatures reach to the minimum threshold (the set temperatures minus the tolerance values), the fans will slow down to keep the temperatures stable.

Frequency/Voltage Control

Use this menu to specify your settings for frequency/voltage control.

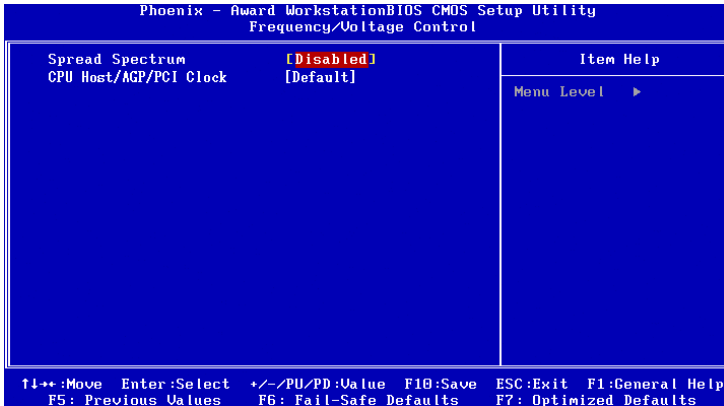

Spread Spectrum

When the motherboard's clock generator pulses, the extreme values (spikes) of the pulses creates EMI (Electromagnetic Interference). The Spread Spectrum function reduces the EMI generated by modulating the pulses so that the spikes of the pulses are reduced to flatter curves. If you do not have any EMI problem, leave the setting at [Disabled] for optimal system stability and performance. But if you are plagued by EMI, activate the Spread Spectrum for EMI reduction. Remember to disable Spread Spectrum if you are overclocking because even a slight jitter can introduce a temporary boost in clockspeed which may just cause your overclocked processor to lock up. Options: [Disabled], [Enabled].

CPU Host/AGP/PCI Clock

This item specifies the clock frequency of CPU host bus (FSB), AGP, and PCI bus. It provides a method for end-users to overclock the processor. When set to [Default], the BIOS adopts the actual CPU/AGP/PCI bus clock values.

Load Fail-Safe/Optimized Defaults

The two options on the main menu allow users to restore all of the BIOS settings to the default Fail-Safe or Optimized values. The Optimized Defaults are the default values set by the mainboard manufacturer specifically for optimal performance of the mainboard. The Fail-Safe Defaults are the default values set by the BIOS vendor for stable system performance.

When you select Load Fail-Safe Defaults, a message as below appears:



Pressing [Y] loads the BIOS default values for the most stable, minimal system performance.

When you select Load Optimized Defaults, a message as below appears:



Pressing [Y] loads the default factory settings for optimal system performance.

Set Supervisor/User Password

When you select this function, a message as below will appear on the screen:

Enter Password:

Type the password, up to eight characters in length, and press <Enter>. The password typed now will replace any previously set password from CMOS memory. You will be prompted to confirm the password. Retype the password and press <Enter>. You may also press <Esc> to abort the selection and not enter a password.

To clear a set password, just press <Enter> when you are prompted to enter the password. A message will show up confirming the password will be disabled. Once the password is disabled, the system will boot and you can enter Setup without entering any password.

When a password has been set, you will be prompted to enter it every time you try to enter Setup. This prevents an unauthorized person from changing any part of your system configuration.

Additionally, when a password is enabled, you can also have BIOS to request a password each time the system is booted. This would prevent unauthorized use of your computer. The setting to determine when the password prompt is required is the **Security Option** of the Advanced BIOS Feature menu. If the **Security Option** is set to [System], the password is required both at boot and at entry to Setup. If set to [Setup], password prompt only occurs when you try to enter Setup.



MSI Reminds You...

About Supervisor Password & User Password:

Supervisor password: Can enter and change the settings of the setup menu.

User password: Can only enter but do not have the right to change the settings of the setup menu.

Appendix A: VIA VT8237R SATA RAID

The Southbridge VT8237 provides a hybrid solution that combines two independent SATA ports for support of up to two Serial ATA (Serial ATA RAID) drives.

Serial ATA (SATA) is the latest generation of the ATA interface. SATA hard drives deliver blistering transfer speeds of up to 150MB/sec. Serial ATA uses long, thin cables, making it easier to connect your drive and improving the airflow inside your PC.

The key features of VT8237 SATA RAID are:

1. Support two SATA + four PATA hard disk drives.
2. Only SATA supports RAID.
3. Supports ATA 133 high performance hard disk drive.
4. Dual independent ATA channels and maximum connection of four hard disk drives allowed.
5. Supports Ultra DMA mode 6/5/4/3/2/1/0, DMA mode 2/1/0, and PIO mode 4/3/2/1/0.
6. Supports RAID 0 and RAID 1.
7. 4 KB to 64 KB striping block size support.
8. Bootable disk or disk array support.
9. Windows-based RAID configure and management software tool.
(Compatible with BIOS)
10. Supports hot-swap failed disk drive in RAID 1 array.
11. ATA SMART function support.
12. Microsoft Windows 98, Me, NT4.0, 2000, XP operating systems support.
13. Event log for easy troubleshooting.

Introduction

This section gives a brief introduction on the RAID-related background knowledge and a brief introduction on VIA SATA RAID Host Controller. For users wishing to install their VIA SATA RAID driver and RAID software, proceed to **Driver and RAID Software Installation** section.

RAID Basics

RAID (Redundant Array of Independent Disks) is a method of combining two or more hard disk drives into one logical unit. The advantage of an Array is to provide better performance or data fault tolerance. Fault tolerance is achieved through data redundant operation, where if one drives fails, a mirrored copy of the data can be found on another drive. This can prevent data loss if the operating system fails or hangs. The individual disk drives in an array are called "members". The configuration information of each member is recorded in the "reserved sector" that identifies the drive as a member. All disk members in a formed disk array are recognized as a single physical drive to the operating system.

Hard disk drives can be combined together through a few different methods. The different methods are referred to as different RAID levels. Different RAID levels represent different performance levels, security levels and implementation costs. The RAID levels which the VIA VT8237 SATA RAID Host Controller supports are RAID 0 and RAID 1. The table below briefly introduced these RAID levels.

RAID Level	No. of Drives	Capacity	Benefits
RAID 0 (Striping)	2	Number drives * 2	Highest performance without data protection
RAID 1 (Mirroring)	2	Smallest size	Data protection

RAID 0 (Striping)

RAID 0 reads and writes sectors of data interleaved between multiple drives. If any disk member fails, it affects the entire array. The disk array data capacity is equal to the number of drive members times the capacity of the smallest member. The striping block size can be set from 4KB to 64KB. RAID 0 does not support fault tolerance.

RAID 1 (Mirroring)

RAID 1 writes duplicate data onto a pair of drives and reads both sets of data in parallel. If one of the mirrored drives suffers a mechanical failure or does not respond, the remaining drive will continue to function. Due to redundancy, the drive capacity of the array is the capacity of the smallest drive. Under a RAID 1 setup, an extra drive called the .spare drive. can be attached. Such a drive will be activated to replace a failed drive that is part of a mirrored array. Due to the fault tolerance, if any RAID 1 drive fails, data access will not be affected as long as there are other working drives in the array.

BIOS Configuration

When the system powers on during the POST (Power-On Self Test) process, press <Tab> key to enter the BIOS configuration.

```
VIA Technologies, Inc. VIA VT6420 RAID BIOS Setting Utility V1.10
Copyright (C) VIA Technologies, Inc. All Right reserved.

Press < Tab > key into User Window!
Scan Devices, Please wait.:
Channel 0 Master: Maxtor 34098H4
Channel 1 Master: Maxtor 34098H4
```

The Serial ATA RAID volume may be configured using the VIA Tech. RAID BIOS. Always use the arrow keys to navigate the main menu, use up and down arrow key to select the each item and press <Enter> to call out the list of creation steps. The main interface of BIOS configuration utility is as below:

Channel	Drive Name	Array Name	Mode	Size(GB)	Status
Channel0 Master	Maxtor 34098H4		ATA	133.37.27	Hdd
Channel1 Master	Maxtor 34098H4		ATA	133.37.27	Hdd

Create Disk Array

Use the up and down arrow keys to select the **Create Array** command and press <Enter>.

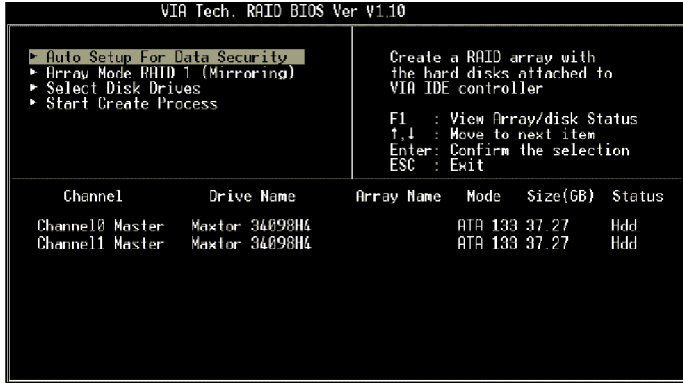

MSI Reminds You...

The "Channel", "Drive Name", "Mode" and "Size (GB)" in the following example might be different from your system.

Select **Array Mode** and press <Enter>, a list of array modes will appear. Highlight the target array mode that you want to create, and press <Enter> to confirm the selection. If RAID 1 or RAID 0/1 is selected, an option list will popup and enable the users to select **Create only** or **Create and duplicate**. **Create only** will allow BIOS to only create an array. The data on the mirroring drive may be different from the source drive. **Create and duplicate** lets BIOS copy the data from the source to the mirroring drive.

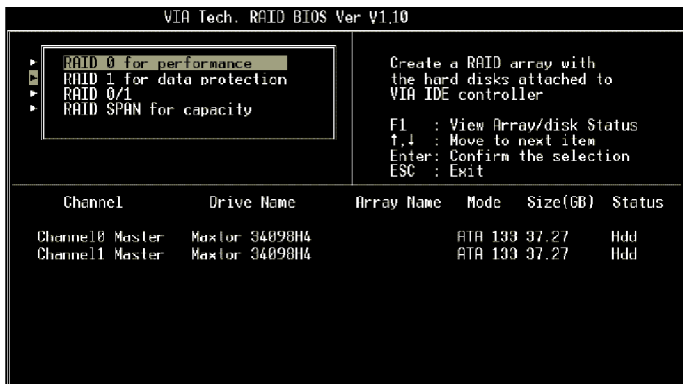

After array mode is selected, there are two methods to create a disk array. One method is **“Auto Setup”** and the other one is **“Select Disk Drives”**. **Auto Setup** allows BIOS to select the disk drives and create arrays automatically, but it does not duplicate the mirroring drives even if the user selected **Create and duplicate** for RAID 1. It is recommended all disk drives are new ones when wanting to create an array. **Select Disk Drives** lets the user select the array drives by their requirements. When using **Select Disk Drives**, the channel column will be activated. Highlight the target drives that you want to use and press <Enter> to select them. After all drives have been selected, press <Esc> to go back to the creation steps menu.

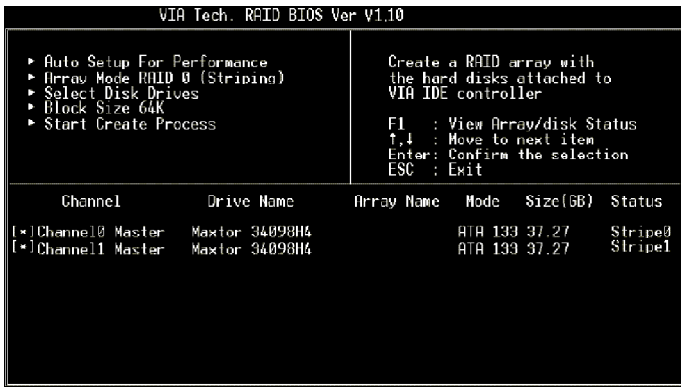

If user selects a RAID 0 array in step 2, the block size of the array can also be selected. Use the arrow key to highlight **Block Size** and press <Enter>, then select a block size from the popup menu. The block size can be 4KB to 64KB.





MSI Reminds You...

Even though 64KB is the recommended setting for most users, you should choose the block size value which is best suited to your specific RAID usage model.

4KB: For specialized usage models requiring 4KB blocks

8KB: For specialized usage models requiring 8KB blocks

16KB: Best for sequential transfers

32KB: Good for sequential transfers

64KB: Optimal setting

Use the arrow key to highlight **Start Create Process** and press <Enter>. A warning message will appear. Press **Y** to finish the creation, or press **N** to cancel the creation. Important note: All existing content in the hard drive will be destroyed after array creation.

Delete Disk Array

A RAID can be deleted after it has been created. To delete a RAID, use the following steps:

1. Select **Delete Array** in the main menu and press <Enter>. The channel column will be activated.
2. Select the member of an array that is to be deleted and press <Enter>. A warning message will show up, press **Y** to delete or press **N** to cancel.



Deleting a disk array will destroy all the data on the disk array except RAID 1 arrays. When a RAID is deleted, the data on these two hard disk drives will be reserved and become two normal disk drives.

Create and Delete Spare Hard Drive

If a RAID 1 array is created and there are drives that do not belong to other arrays, the one that has a capacity which is equal to or greater than the array capacity can be selected as a spare drive for the RAID 1 array. Select **Create/Delete Spare** and press <Enter>, the channel column will then be activated. Select the drive that you want to use as a spare drive and press <Enter>, the selected drive will be marked as **Spare**. The spare drive cannot be accessed in an OS.

To delete a spare drive, highlight **Create/Delete Spare** and press <Enter>. The spare drive will be highlighted, press <Enter> to delete the spare drive.



View Serial Number of Hard Drive

Highlight **Serial Number View** and press <Enter>. Use arrow key to select a drive, the selected drive's serial number can be viewed in the last column. The serial number is assigned by the disk drive manufacturer.

Press the **F1** key to show the array status on the lower screen. If there are no disk arrays then nothing will be displayed on the screen.



Duplicate Critical RAID 1 Array

When booting up the system, BIOS will detect if the RAID 1 array has any inconsistencies between user data and backup data. If BIOS detects any inconsistencies, the status of the disk array will be marked as critical, and BIOS will prompt the user to duplicate the RAID 1 in order to ensure the backup data consistency with the user data.



If user selects **Continue to boot**, it will enable duplicating the array after booting into OS.

Rebuild Broken RAID 1 Array

When booting up the system, BIOS will detect if any member disk drives of RAID has failed or is absent. If BIOS detects any disk drive failures or missing disk drives, the status of the array will be marked as broken.

If BIOS detects a broken RAID 1 array but there is a spare hard drive available for rebuilding the broken array, the spare hard drive will automatically become the mirroring drive. BIOS will show a main interface just like a duplicated RAID 1. Selecting **Continue to boot** enables the user to duplicate the array after booting into operating system.

If BIOS detects a broken RAID 1 array but there is no spare hard drive available for rebuilding the array, BIOS will provide several operations to solve such problem.



1. Power off and Check the Failed Drive:

This item turns off the computer and replaces the failed hard drive with a good one. If your computer does not support APM, you must turn off your computer manually. After replacing the hard drive, boot into BIOS and select **Choose replacement drive and rebuild** to rebuild the broken array.

2. Destroy the Mirroring Relationship:

This item cancels the data mirroring relationship of the broken array. For broken RAID 1 arrays, the data on the surviving disk will remain after the destroy operation. However, **Destroy the Mirroring Relationship** is not recommend because the data on the remaining disk will be lost when the hard drive is used to create another RAID 1 array.

3. Choose Replacement Drive and Rebuild:

This item enables users to select an already-connected hard drive to rebuild the broken array. After choosing a hard drive, the channel column will be activated.

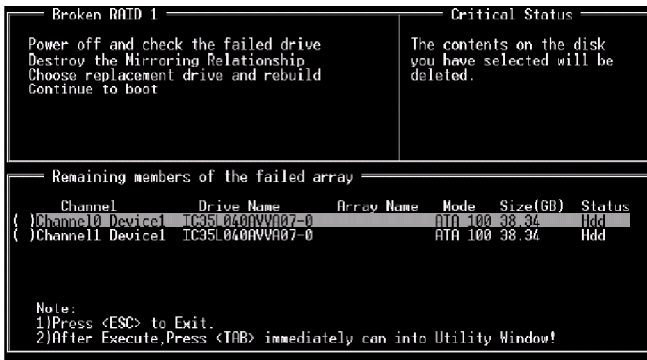

Highlight the target hard drive and press <Enter>, a warning message will appear. Press **Y** to use that hard drive to rebuild, or press **N** to cancel. Please note selecting option **Y** will destroy all the data on the selected hard drive.

4. Continue to boot:

This item enables BIOS to skip the problem and continue booting into OS.

Installing RAID Software & Drivers

Install Driver in Windows OS

† New Windows XP Installation

The following details the installation of the drivers while installing Windows XP.

1. Start the installation:
Boot from the CD-ROM. Press **F6** when the message "Press F6 if you need to install third party SCSI or RAID driver" appears.
2. When the Windows Setup window is generated, press **S** to specify an Additional Device(s).
3. Insert the floppy diskette **which included the VIA IDE RAID Driver** into drive A: and press <Enter>.



MSI Reminds You...

Please follow the instruction below to make a VIA Serial ATA RAID driver for yourself.

1. Insert the MSI CD into the CD-ROM drive.
2. Ignore the Setup screen and use "Explorer" to browse the CD.
3. Copy all the contents (including the sub-folders) in the **WDE\VIA\Driver** to a formatted floppy disk.
4. The driver disk for VIA Serial ATA driver is done.

4. Choose **VIA Serial ATA RAID Controller(Windows XP)** from the list that appears on Windows XP Setup screen, press the <Enter> key.
5. Press <Enter> to continue with installation or if you need to specify any additional devices to be installed, do so at this time. Once all devices are specified, press <Enter> to continue with installation.
6. From the Windows XP Setup screen, press the <Enter> key. Setup will now load all device files and then continue the Windows XP installation.

† Existing Windows XP Driver Installation

1. Insert the MSI CD into the CD-ROM drive.
2. The CD will auto-run and the setup screen will appear.
3. Under the Driver tab, click on **VIA SATA/ IDE Drivers**.
4. The drivers will be automatically installed.

† Confirming Windows XP Driver Installation

1. From Windows XP, open the **Control Panel** from **My Computer** followed by the System icon.
2. Choose the **Hardware** tab, then click the **Device Manager** tab.
3. Click the "+" in front of the **SCSI and RAID Controllers** hardware type. The driver **VIA IDE RAID Host Controller** should appear.

Installation of VIA SATA RAID Utility

The VIA SATA RAID Utility is the software package that enables high-performance RAID 0 arrays in the Windows* XP operating system. This version of VIA SATA RAID Utility contains the following key features:

- † Serial ATA RAID driver for Windows XP
- † VIA SATA RAID utility
- † RAID0 and RAID1 functions

Insert the MSI CD and click on the **VIA Serial ATA** to install the software.

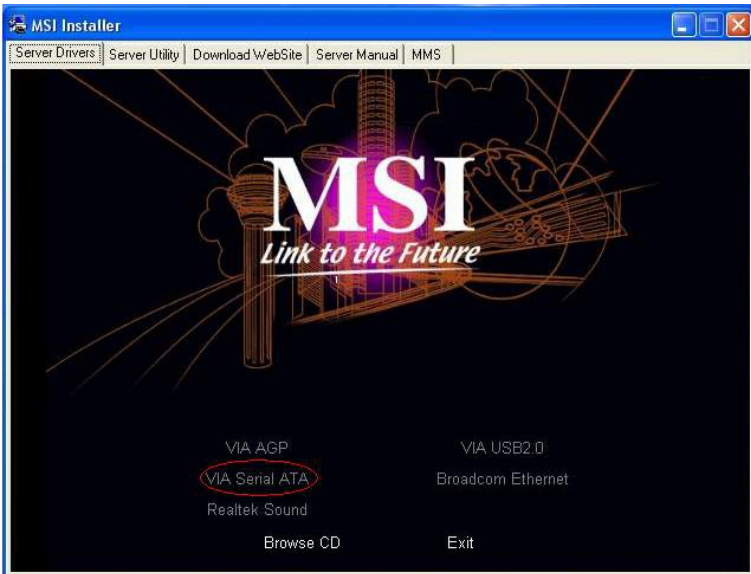

MSI Reminds You...

Due to the different specification of the mainboard you purchased, the screen of MSI CD shown here may be slightly different from the latest software utility and shall be held for reference only.

The **InstallShield Wizard** will begin automatically for installation. Click on the **Next** button to proceed the installation in the welcoming window.

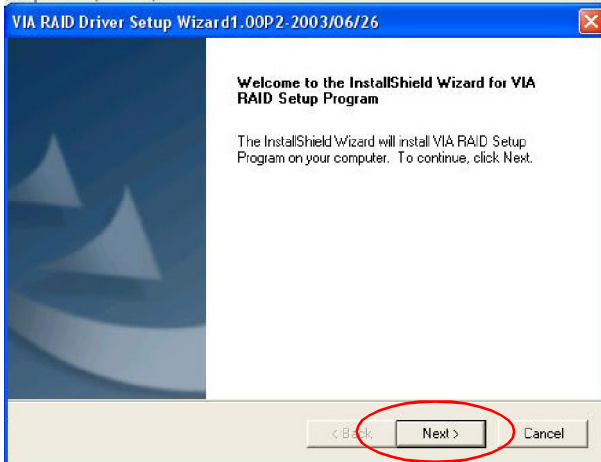

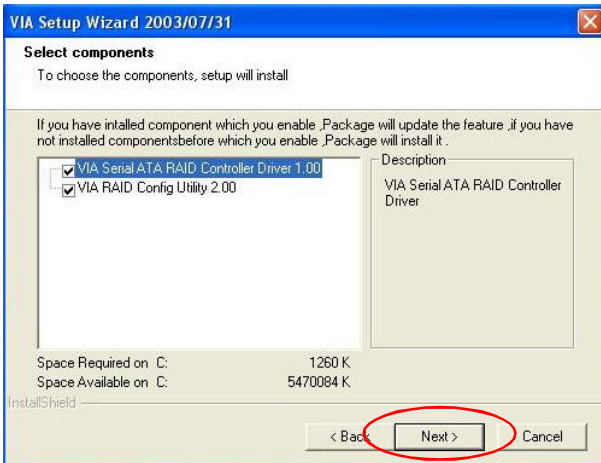

Put a check mark in the check box to install the feature you want. Then click **Next** button to proceed the installation.

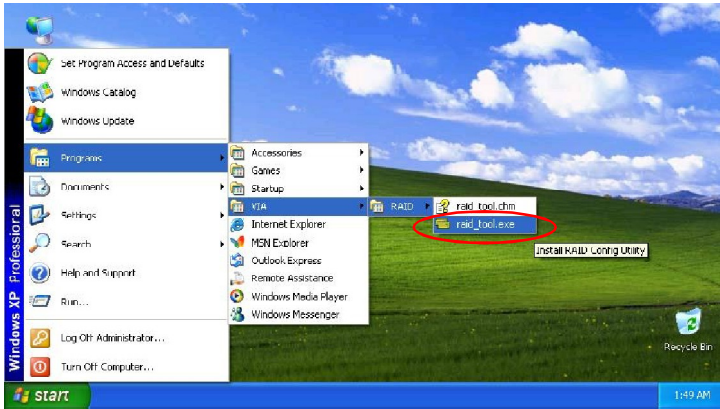

Using VIA RAID Tool

Once the installation is complete, go to **Start ---> Programs --->VIA --->raid_tool.exe** to enable **VIA RAID Tool**.



After the software is finished installation, it will automatically started every time Windows is initiated. You may double-click on the  icon shown in the system tray of the tool bar to launch the **VIA RAID Tool** utility.



The main interface is divided into two windows above contain the main functions. Click on these toolbar buttons to execute their specific functions. The left windowpane displays the controller and disk drives and the right windowpane displays the details of the controller or disk drives. The available features are as following:



View by Controller





View by Devices



View Event log



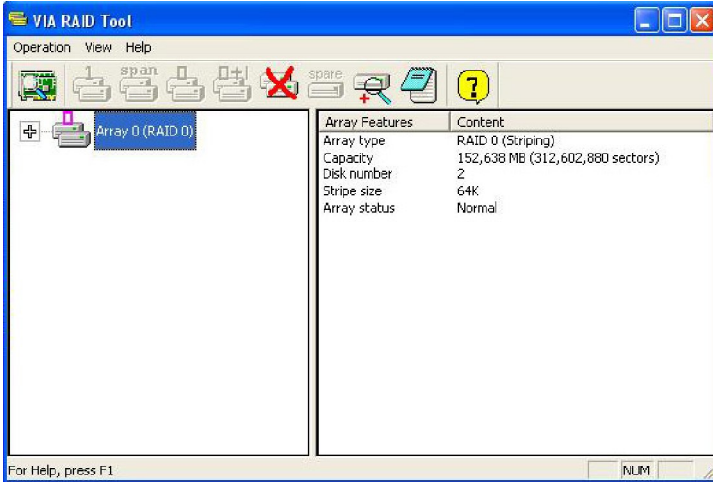

Help Topics

Click on  or  button to determine the viewing type of left window pane. There are two viewing types: By controllers and by device. Click on the object in the left window pane to display the status of the object in the right windowpane. The following screen shows the status of Array 0---RAID 0.

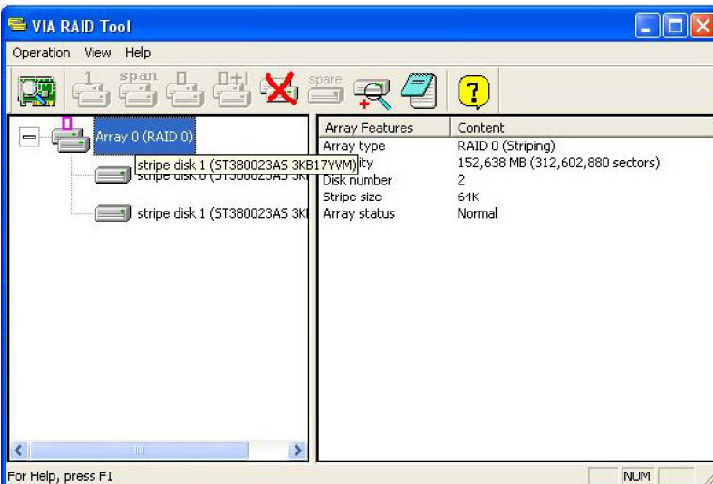

Click on the plus (+) symbol next to Array 0---RAID 0 to see the details of each disk.



You may also use the same  or  button to view the statuses of Array 0--RAID 1.

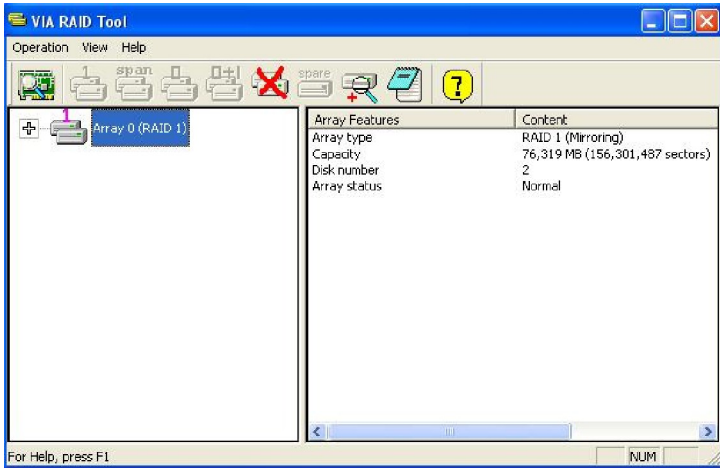

Click on the plus (+) symbol next to Array 0---RAID 1 to see the details of each disk.

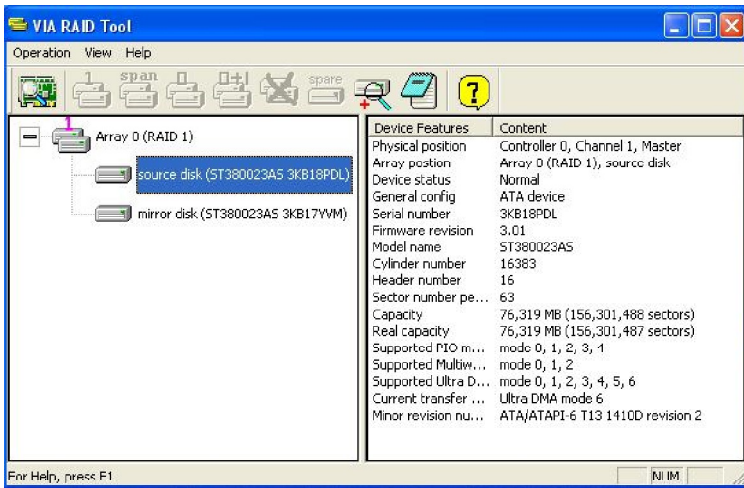

Appendix B: Using 2-, 4-, 6- or 8- Channel Audio Function

The mainboard is equipped with Realtek ALC850 chip, which provides support for 8-channel audio output, including 2 Front, 2 Rear, 1 Center and 1 Subwoofer channel. ALC850 allows the board to attach 2, 4, 6 or 8 speakers for better surround sound effect. The section will tell you how to install and use 2-, 4-, 6- or 8-channel audio function on the board.

Installing the Audio Driver

You need to install the driver for Realtek ALC850 codec to function properly before you can get access to 2-, 4-, 6- or 8- channel audio operations. Follow the procedures described below to install the drivers for different operating systems.

Installation for Windows 98SE/ME/2000/XP

For Windows® 2000, you must install Windows® 2000 Service Pack2 or later before installing the driver.

The following illustrations are based on Windows® XP environment and could look slightly different if you install the drivers in different operating systems.

1. Insert the companion CD into the CD-ROM drive. The setup screen will automatically appear.
2. Click **Realtek Sound**.

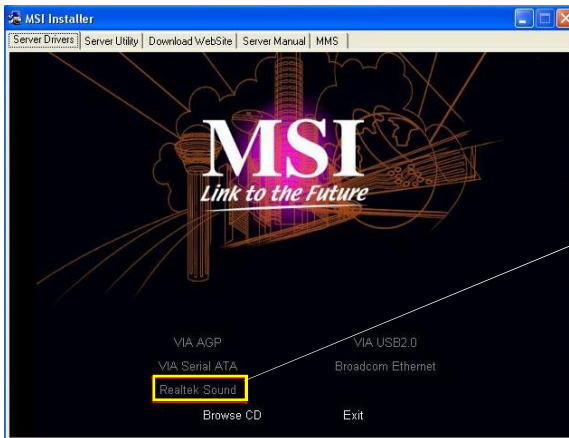

MSI Reminds You...

The **AC97 Audio Configuration**  software utility is under continuous update to enhance audio applications. Hence, the program screens shown here in this appendix may be slightly different from the latest software utility and shall be held for reference only.

3. Click **Next** to install the AC'97 Audio software.

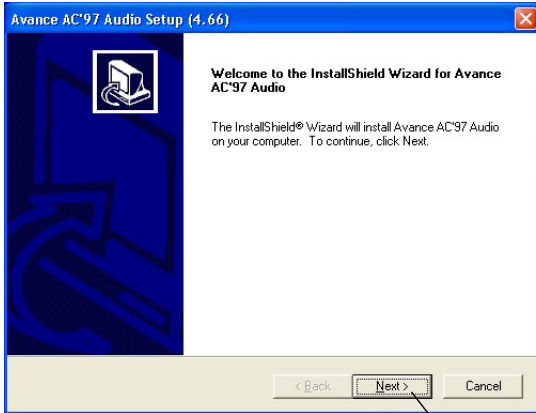

Click here

4. Click **Finish** to restart the system.

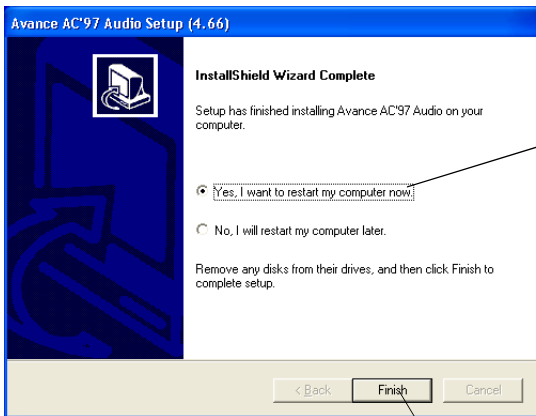

Select this option

Click here

Software Configuration

After installing the audio driver, you are able to use the 2-, 4-, 6- or 8- channel audio feature now. Click the audio icon  from the system tray at the lower-right corner of the screen to activate the **AC97 Audio Configuration**. It is also available to enable the audio driver by clicking the **Sound Effect Manager** from the **Control Panel**.

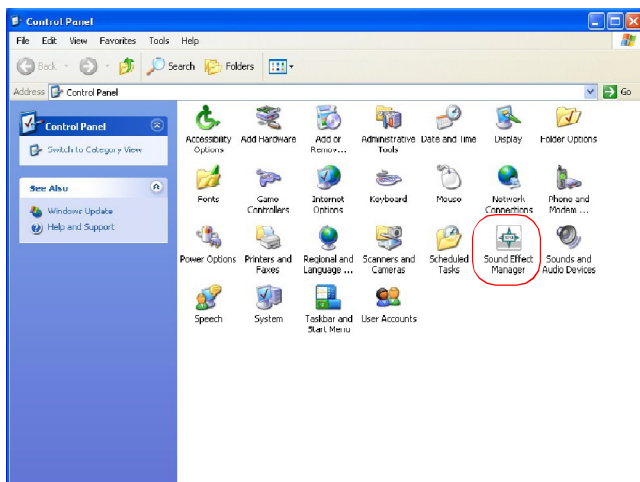

Sound Effect

Here you can select a sound effect you like from the **Environment** list.



You may also edit the properties for an environment as you wish by clicking the "Edit" button, then just scroll the bar in the bottom for each property to adjust.

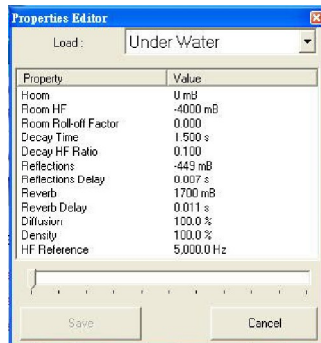

You may choose the provided sound effects, and the equalizer will adjust automatically. If you like, you may also load an equalizer setting or make an new equalizer setting to save as an new one by using the **“Load EQ Setting”** and **“Save Preset”** button, click **“Reset EQ Setting”** button to use the default value, or click **“Delete EQ Setting”** button to remove a preset EQ setting.

There are also other pre-set equalizer models for you to choose by clicking **“Others”** under the **Equalizer** part.

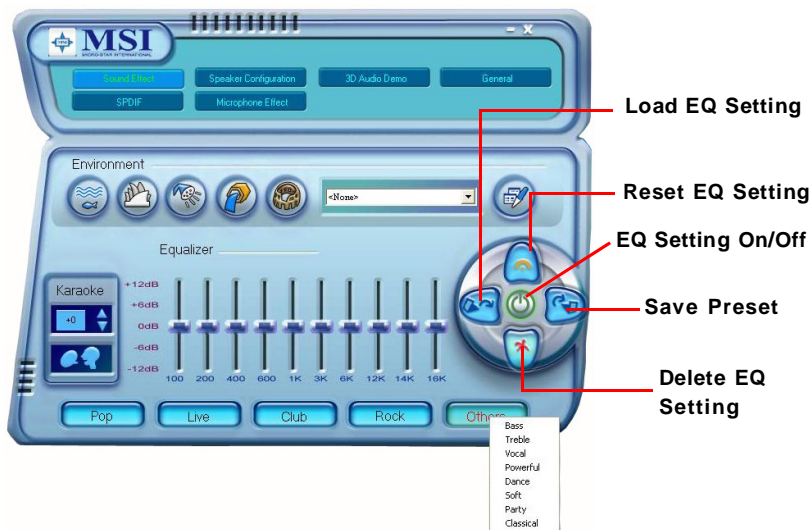

Here it provides the Karaoke function which will automatically remove human voice (lyrics) and leave melody for you to sing the song. You may use the “up arrow” and “down arrow” button to raise/lower the key, and press the lower button to remove the human voice.



Speaker Configuration

In this tab, you can easily configure your multi-channel audio function and speakers.

1. First you have to select the audio configuration below which is identical to the audio jack on your mainboard. In this model it uses Realtek ALC850 codec which supports 8-channel S/PDIF, therefore you should choose **8CH-S/PDIF (Optical & Coaxial)**.

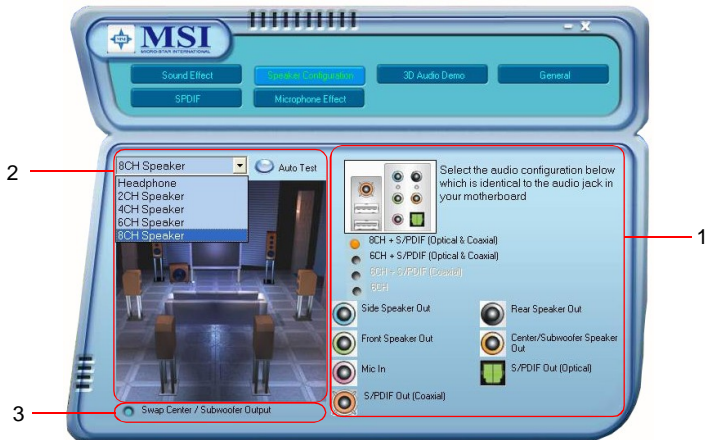

2. Select a desired multi-channel operation here.
 - a. **Headphone** for the common headphone
 - b. **2CH Speaker** for Stereo-Speaker Output
 - c. **4CH Speaker** for 4-Speaker Output
 - d. **6CH Speaker** for 5.1-Speaker Output
 - e. **8CH Speaker** for 8-Speaker Output



Select the speaker by clicking it to test its functionality. The one you select will light up and make testing sound. If any speaker fails to make sound, then check whether the cable is inserted firmly to the connector or replace the bad speakers with good ones. Or you may click the **“Auto Test”** button to test the sounds of each speaker automatically.

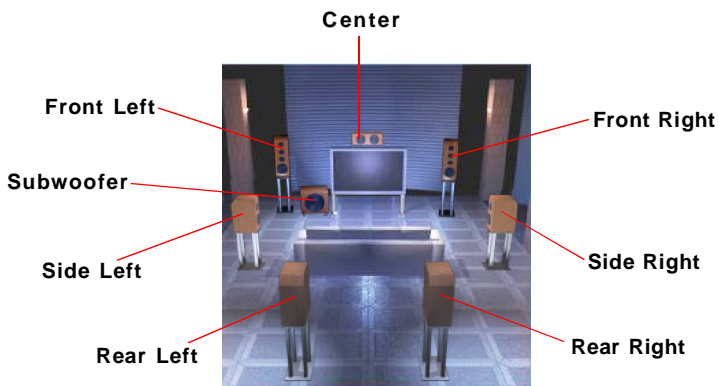

3. While you are testing the speakers in 8-Channel / 6-Channel Mode, if the sound coming from the center speaker and subwoofer is swapped, you should select **Swap Center/Subwoofer Output** to readjust these two channels.

3D Audio Demo

In this tab you may adjust your 3D positional audio before playing 3D audio applications like gaming. You may also select different environment to choose the most suitable environment you like.



General

In this tab it provides some information about this AC97 Audio Configuration utility, including Audio Driver Version, DirectX Version, Audio Controller & AC97 Codec. You may also select the language of this utility by choosing from the **Language** list.

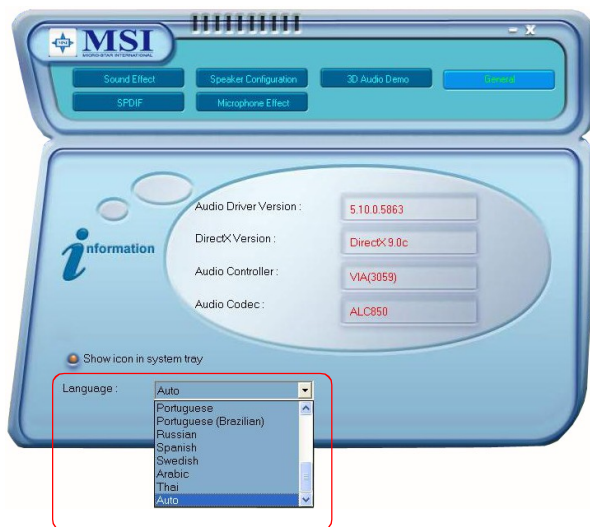

Also there is a selection **Show icon in system tray**. Switch it on and an icon  will show in the system tray. Right-click on the icon and the **Audio Accessories** dialogue box will appear which provides several multimedia features for you to take advantage of.



SPDIF

In this tab it provides options about SPDIF-Out for you to configure.



- † **No Output:** With this option, there is no S/PDIF output signal while playing analog and digital audio.
- † **Output digital only:** With this option, only digital audio will be allowed to play via SPDIF out while playing analog and digital audio.
- † **Output digital and analog:** With this option, both digital and analog audio will be allowed to play via SPDIF out while playing analog and digital audio.

Microphone Effect

In this tab you may add special effects to the connected microphone.



Using 2-, 4-, 6- & 8- Channel Audio Function

Connecting the Speakers

When you have set the Multi-Channel Audio Function mode properly in the software utility, connect your speakers to the correct phone jacks in accordance with the setting in software utility.

n 2-Channel Mode for Stereo-Speaker Output

Refer to the following diagram and caption for the function of each phone jack on the back panel when 2-Channel Mode is selected.

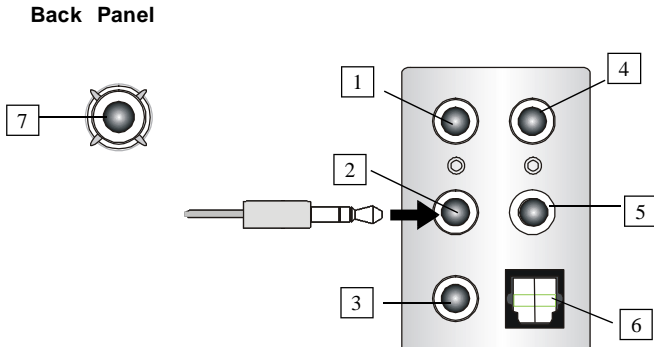

2-Channel Analog Audio Output

- 1 Line In
- 2 Line Out (*Front channels*)
- 3 MIC
- 4 Line Out (*Rear channels, but not functioning in this mode*)
- 5 Line Out (*Center and Subwoofer channel, but not functioning in this mode*)
- 6 Optical SPDIF jack
- 7 Coaxial SPDIF jack

n 4-Channel Mode for 4-Speaker Output

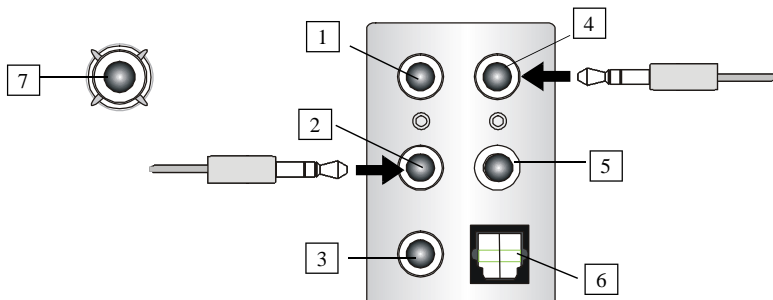

Description:
Connect two speakers to back panel's Line Out connector and two speakers to the real-channel Line Out connector.

4-Channel Analog Audio Output

- 1 Line In
- 2 Line Out (*Front channels*)
- 3 MIC
- 4 Line Out (*Rear channels*)
- 5 Line Out (*Center and Subwoofer channel, but no functioning in this mode*)
- 6 Optical SPDIF jack
- 7 Coaxial SPDIF jack

n 6-Channel Mode for 6-Speaker Output

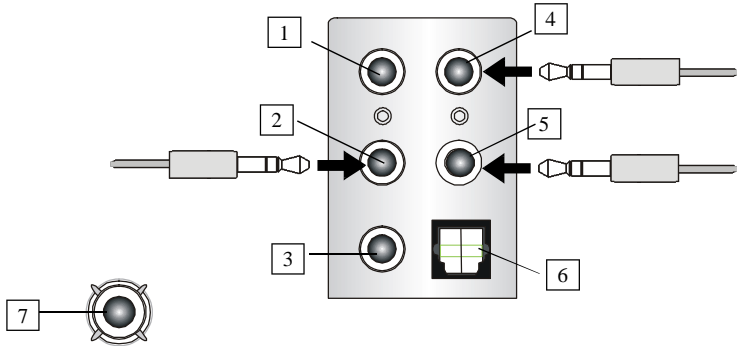

6-Channel Analog Audio Output

- 1 Line In
- 2 Line Out (*Front channels*)
- 3 MIC
- 4 Line Out (*Rear channels*)
- 5 Line Out (*Center and Subwoofer channel*)
- 6 Optical SPDIF jack
- 7 Coaxial SPDIF jack

Description:

Connect two speakers to back panel's Line Out connector, two speakers to the rear-channel and two speakers to the center/subwoofer-channel Line Out connectors.

n 8-Channel Mode for 8-Speaker Output

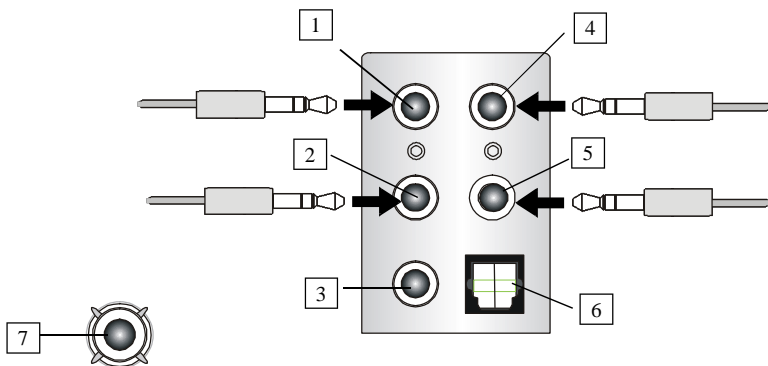

8-Channel Analog Audio Output

- 1 Line Out (*Side channels*)
- 2 Line Out (*Front channels*)
- 3 MIC
- 4 Line Out (*Rear channels*)
- 5 Line Out (*Center and Subwoofer channel*)
- 6 Optical SPDIF jack
- 7 Coaxial SPDIF jack

Description:

Connect two speakers to back panel's Line Out connector, two speakers to the rear-channel, two speakers to the center/subwoofer-channel Line Out connectors, and two speakers to the side-channel Line Out connectors.

Free Manuals Download Website

<http://myh66.com>

<http://usermanuals.us>

<http://www.somanuals.com>

<http://www.4manuals.cc>

<http://www.manual-lib.com>

<http://www.404manual.com>

<http://www.luxmanual.com>

<http://aubethermostatmanual.com>

Golf course search by state

<http://golfingnear.com>

Email search by domain

<http://emailbydomain.com>

Auto manuals search

<http://auto.somanuals.com>

TV manuals search

<http://tv.somanuals.com>