

Panasonic®

Operating Instructions IC Recorder

Model No. **RR-US550**

If you have any questions contact

In the U.S.A. and Puerto Rico: 1-800-211-PANA(7262)

In Canada: 1-800-561-5505

Dear customer

Thank you for purchasing this product.

For optimum performance and safety, please read these instructions carefully.

Before connecting, operating or adjusting this product, please read the instructions completely. Please keep this manual for future reference.

For Canada only

**The warranty can be found
on pages 40 and 41.**

For U.S.A. and Puerto Rico only

**The warranty can be found
on pages 42 and 43.**



Features

Recording



Meeting



Lesson
Lecture



Dictation

Playing back to listen

- Recorded file
- MP3 music file



with speaker



or earphones
(not included)

Connecting this unit to a computer

Using a computer

- Copy/Organize (Delete) recorded files/
Play back to listen

From a computer

- Transfer MP3 music files

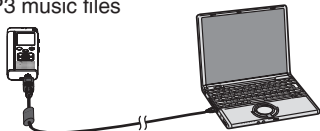

Supplied accessories



Please check and identify the supplied accessories.

Use numbers indicated in parentheses when asking for replacement parts.

(Product numbers correct as of December 2008. These may be subject to change.)

Only for the U.S.A. and Puerto Rico:

To order accessories, refer to
“Accessory Purchases (United
States and Puerto Rico)” on page 43.

Only for Canada: To order accessories, call the dealer from
whom you have made your purchase.

1 USB cable [K2KZ4CB00012]

CAUTION

Danger of explosion if battery is incorrectly replaced. Replace only with the same or equivalent type recommended by the manufacturer. Dispose of used batteries according to the manufacturer's instructions.

FC **Panasonic**
RR-US550

Table of contents

Preparation

Features	2
Supplied accessories	2
Part names	4
Inserting the batteries.....	5
Turning ON/OFF the Power	6
Hold function.....	6
Setting the time.....	7

Basic Operations

Recording settings.....	8
Switching recording position	8
Recording	9
Playing.....	10
Listening to the audio using earphones.....	11
Deleting recorded files.....	12
Locking recorded files (File protection).....	13

Advanced Operations

Changing recording settings (Microphone sensitivity).....	14
Changing recording settings (Zoom microphone/Recording mode (XP/LP/SLP))	15
Preventing unnecessary recording (VAS).....	16
Confirming possible (remaining) recording time	16
Setting the playback speed control function	17
Reducing noise (EQ setting).....	18
Slight return playback.....	18
Repeat play/Successive play.....	19
A-B Repeat play	19
Security functions	20

Recording using an external microphone	22
Recording from other devices.....	22
Recording to other devices.....	23
Canceling the operation beep.....	23

Using with a computer

Connecting this unit to a computer	24
Opening the folder of this unit using a computer	25
Importing the recorded files in this unit to a computer/Organizing files.....	26
Returning the files imported to the computer to this unit	27
Listening to music on this unit (Transferring MP3 music files to this unit).....	28
Listening to music on this unit (Playing MP3 music files on this unit).....	29
Creating MP3 music files.....	30

Other

System requirements.....	31
Q & A (Frequently Asked Questions).....	32
Troubleshooting guide	33
Care and use	36
Maintenance.....	37
Product Service	38
Specifications	39
Limited Warranty (ONLY FOR CANADA).....	40
Limited Warranty (ONLY FOR U.S.A. AND PUERTO RICO)	42

Part names

Main unit

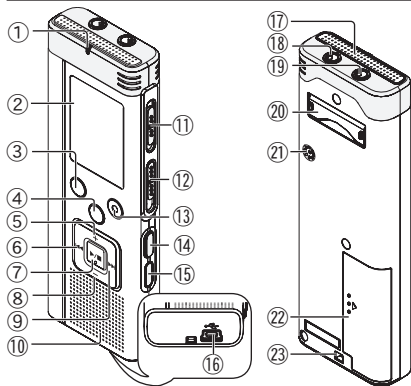

- ① Recording indicator (red)
- ② LCD display
- ③ FOLDER
- ④ STOP
- ⑤ + (Volume)
- ⑥ ◀◀ (Fast backward)
- ⑦ ▶▶ (Play/Stop/Enter)
- ⑧ - (Volume)
- ⑨ ▶▶ (Fast forward)
- ⑩ Built-in speaker
- ⑪ OPR/HOLD
- ⑫ Recording position switch (ZOOM/NORMAL/MANUAL)
- ⑬ REC/PAUSE
- ⑭ •MENU/-REPEAT
- ⑮ ERASE

- ⑯ USB jack
- ⑰ Built-in microphone
- ⑱ External microphone jack (MIC)
- ⑲ Headphone/earphone jack (🎧)
- ⑳ Stand

When you perform zoom recording with the unit placed on the desk, etc., stable zoom effect can be obtained by putting up the stand.

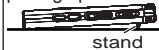

- ㉑ Zoom microphone
- ㉒ Battery cover
- ㉓ Hand strap hole

The enclosed Canadian French label sheet corresponds to English display on the unit.

Display

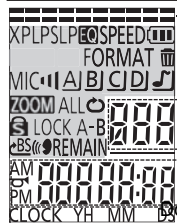

Remaining memory/Recording level
 XPLPSLP: Recording mode
 MIC: Microphone sensitivity

File number
 ↶BS : Slight return playback

Recording (Playback) elapsed time/Possible remaining recording time/Recording (Playback) elapsed time/Recording (Playback) elapsed time/Recording (Playback) elapsed time

EQ : Noise reduction
 SPEED : Playback speed control
 FORMAT : Formatting
 A|B|C|D|J : Folder
 ZOOM : Zoom recording
 ALL A-B : Successive/Repeat play

⏴ : Battery indicator
 🗑️ : Delete
 🛡️ : Security
 LOCK : File protection
 🎧 : VAS recording
 🔔 : Operation beep

Inserting the batteries

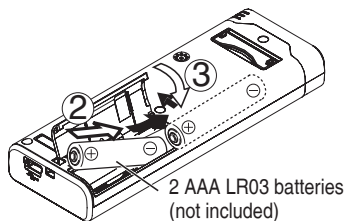
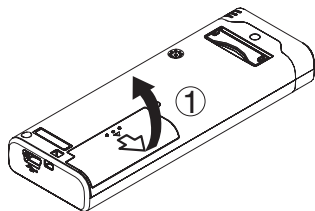

Make sure the batteries face the right direction.

- Use alkaline batteries.

The remaining battery display shown below is displayed while recording or playing.



- If the batteries run out, “” blinks. Replace the batteries as soon as possible.
- Remove the batteries from the unit if you will not use it for a long period of time.
- Please replace batteries within approx. 30 seconds for preservation of the clock data.

Make sure to turn the power off before removing the batteries.

- If the batteries are removed while recording, deleting, etc, all data on this unit may be lost or this unit may be destroyed.

Turning ON/OFF the Power

OPERATION/HOLD Switch

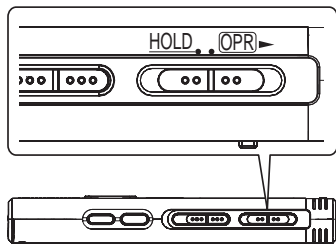

OPR: operation

Turning the power ON

- Slide OPERATION/HOLD switch to **OPR** side, then the power turns on and the display lights on.

Turning the power OFF

- Slide and hold OPERATION/HOLD switch to **OPR** side for 2 seconds.

Also, when you do not operate the unit for more than approx. 15 minutes while the unit is stopped, "batt" is displayed and the power automatically turns off.

- When batteries are inserted for the first time, "CLOCK" blinks on the display. Please set the time (→ page 7).

Hold function

Button operations are ignored when you set Hold on.

Switching Hold on/off

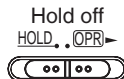
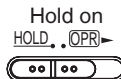

- When the Hold function is on, button operation is ignored even if the unit is on ("hold" is displayed). Accordingly, operation mistakes (i.e. Recording or playback stops midway.) can be prevented.

Setting the time

When the power is turned on, "CLOCK" blinks on the display when the time is not set (e.g. at the time of purchase). (In power-on condition, the display changes to "12:00" (blinking) in approx. 1 minute.)

The clock is used for preserving recording date. Please set the time first.

Recording is possible even if the clock is not set. However, the Recording date, Recording start time will be displayed as " - - - -".

When "CLOCK" is blinking

- Turn the power on (→ page 6).

- 1 Press **▶/■**.
- 2 Press **+**, **-** to set the year and press **▶/■** to enter.

Set month and day in the same way.



The above illustration is a display example.

- 3 Press **◀▶**, **▶▶** to select the time display and press **▶/■** to enter.



24-hour display 12-hour display

- 4 Press **+**, **-** to set the time and press **▶/■** to enter.

You can adjust the time quickly by pressing and holding **+**, **-**.



24-hour display 12-hour display

When the time display is "12:00" (blinking) or you change the time

- Turn the power on (→ page 6).
- Press **STOP** to stop the unit.

- 1 Press **▶/■** .
"XPLPSLP" (blinking) or "CLOCK" (blinking) is displayed.
- 2 Press **+**, **-** to select "CLOCK" and press **▶/■** to enter.
If "CLOCK" blinks, press **▶/■** to enter.
- 3 Follow step 2, 3 and 4 shown at left.

- Press **STOP** to stop the setting process midway.
- The clock operates with the monthly loss/gain of approx. 60 seconds at normal temperature.
- The time setting is cleared, if the battery has been consumed completely.

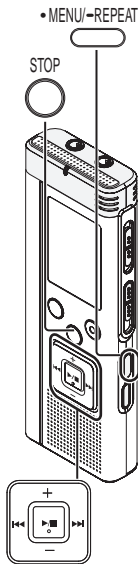

Recording settings

This unit has 3 recording setting items related to recording quality. Using different combinations of recording settings, you can adjust audio quality according to recording situations.

Recording setting item	Setting contents and display
Recording mode (→ page 15)	High-quality : XP Long recording : LP : SLP
Microphone sensitivity (→ page 14)	High : MIC ■■■ Normal : MIC ■■ Low : MIC ■
Zoom microphone (→ page 15)	Zoom microphone ON : ZOOM Zoom microphone OFF : No display

The total possible recording time (→ page 39) changes according to the recording mode.

Switching recording position

This unit is equipped with 3 recording positions: [ZOOM], [NORMAL] and [MANUAL]. The [ZOOM] and [NORMAL] content settings are fixed while [MANUAL] content settings can be changed according to your preference. You can switch among the positions using Recording position switch.

Recording position	Setting contents (display) and situations
ZOOM	XP MIC ■■ ZOOM For lessons, lectures, etc. (Recording the aimed person's voice).
NORMAL	XP MIC ■■ For meetings, etc.
MANUAL	XP MIC ■ ZOOM * For dictation, etc. * [MANUAL] position has been set to be suitable for dictation at the time of purchase. You can change the setting according to your preference (→ pages 14, 15).

You can change the recording mode (XP, LP, SLP) in all positions (→ page 15)

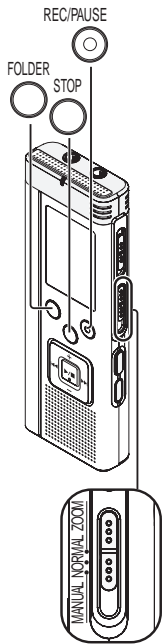

Recording position switch

Recording

- Turn the power on (→ page 6).
- Press  to stop the unit.

1 Slide recording position switch to select a position.

Switch modes according to situations (→ page 8).

2 Select a folder for recording.

The folder is switched each time you press . Select among "A|B|C|D" (The factory setting is "A").

When you select "D", recording is automatically saved in "A" (If the folder already contains 99 files, the next folder with recordable space is used).

3 Press (Recording starts).

Each time you press Pause ⇄ Recording resumes

Display during recording

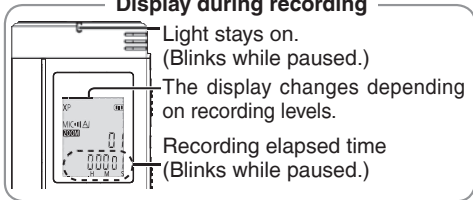

To stop: Press 

Download from Wwww.Somanuals.com. All Manuals Search And Download.

Folder

[Folder] for this unit means locations in which recording (music) files are stored. There are 4 audio folders "A|B|C|D" and 1 music folder "M" in this unit.

Using each folder according to the purposes of recording enables you to search files easily later. A maximum of 99 files can be saved into each audio folder A) to D).

File

Recorded audio data from the starting point to the ending point is saved as a file. The saved data is called a file.

-
- **Even if you change the position of Recording position switch during recording, the setting will not be changed until the recording is complete.**
 - Change the recording mode as necessary (→ page 15).
 - Do not block the holes of the zoom microphone and built-in microphone during recording (→ page 4)

Playing

- Press  to stop the unit.
- Select a folder (→ right).
- Select a file (→ right).

1 Press  (Playback starts).

Adjusting the volume

Turn up the volume: Press +.

Turn down the volume: Press -.



Volume range is 0 to 20.

(The factory setting is 13.)

Operations during playback

Jump (Skip):

Press  , .

Press  midway while playing a file and the playback jumps to the beginning of the file. To return to the previous file, press  again within 1 second.

Fast backward/Fast forward

(Search):

Press and hold  , .

Stop: Press  or .

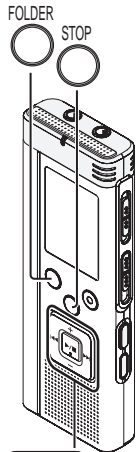

Select a folder

The folder is switched each time you press .

Select among "A", "B", "C", "D", "J".
Select the folder that contains the file to play.

Select a file

Press  ,  to select.

Each time you press, the file number changes.

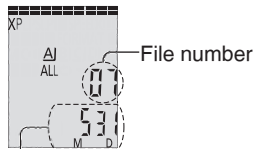

When a file is selected, the recording information below is displayed.

Recording date → Recording start time →
Recording time → Total number of files in the folder

Listening to the audio using earphones

Connect earphones (not included). (Sounds are monaural).
Plug type: \varnothing 3.5 mm (1/8") mini plug

Confirming the remaining time

Press and hold  for 1 second or longer during playback.

The remaining time of the file being played is displayed for approx. 3 seconds.

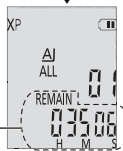

Remaining playback time

- The remaining playback time for the last approx. 3 seconds of file is not displayed.

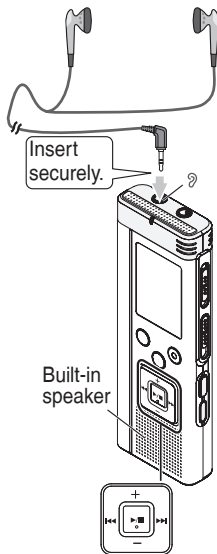

Monitoring the recording progress

Adjusting the volume:

You can adjust the volume by pressing +, -, but the recording level is not affected.

Listening to the audio during playback

The audio during playback comes from the speaker. Listening may be difficult in noisy places due to the speaker output. In that case, connect earphones (not included).

- The built-in speaker is turned off when earphones are connected.

Deleting recorded files

- Select a folder (→ page 10).

1 Press **ERASE** while playing or the unit is stopped.



2 Press **◀▶** to select the file.

① Deleting one file

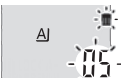

② Deleting all files in one folder

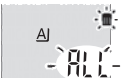

③ Deleting all files in folder A through D



④ Deleting all files in all folders



⑤ Formatting this unit



① to ④ : Protected files and files which cannot be played back on this

unit cannot be deleted.

3 Press **▶/■** to enter.

4 Press **◀▶** to select "YES" and press **▶/■** to enter.



When deleting is complete, "- -" is displayed.

It may take dozens of seconds until deleting is complete.

Formatting

If the unit is formatted, all existing files including protected files, music files, data files transferred from PCs, etc. are deleted.

- Deleted files cannot be recovered.
- You cannot delete a portion of a file.
- Press **STOP** to stop the operation midway.
- The file numbers displayed on this unit are moved forward after deleting files.
- Both deleting and formatting data are not available when the remaining battery display shows "⏻" (blinking).

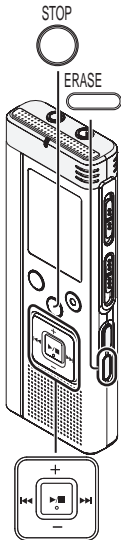

Locking recorded files (File protection)

Locked files cannot be deleted on this unit (except when formatting).
Use this function to protect files.

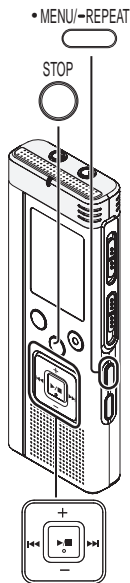

- Select a folder (→ page 10).
- Press ^{STOP} to stop the unit.

- 1** Press ^{MENU/-REPEAT} .
“XPLPSLP” (blinking) is displayed.
- 2** Press +, - to select “LOCK” and press ^{▶/■} to enter.



- 3** Press ^{<<<, >>>} to select the file.

① Selecting one file



② Selecting all files in one folder

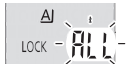

③ Selecting all files in all folders

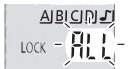

- 4** Press ^{▶/■} to enter.

- 5** Press ^{<<<, >>>} to select “OFF” and press ^{▶/■} to enter.

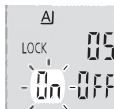

Lock is performed.
It may take dozens of seconds until locking is complete.

To cancel lock:



Follow step **1** to **4**, select “OFF” and enter in step **5**.

- Press ^{STOP} to stop the setting process midway.
- “LOCK” is displayed for the locked files when the file is selected.
- “LOCK” is not displayed when there is no file in the selected folder.
- You cannot lock files when the remaining battery display shows “” (clicking).

Changing recording settings (Microphone sensitivity)

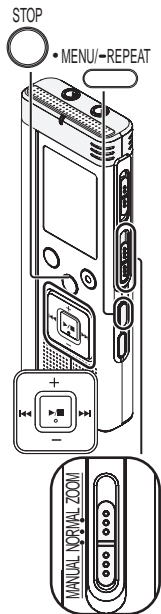
- Set the Recording position switch to [MANUAL] (→ page 8).
- Press  to stop the unit.



- 1** Press  .
“XPLPSLP” (blinking) is displayed.
- 2** Press +, – to select “MIC||” and press  to enter.



- 3** Press ,  to select microphone sensitivity and press  to enter.

MIC	MIC	MIC
Low	Normal	High

-
- Press  to stop the setting process midway.

Recording position switch

Download from Www.Somanuals.com. All Manuals Search And Download.

Changing recording settings (Zoom microphone/Recording mode (XP/LP/SLP))

Changing Zoom microphone setting

When the zoom is set to “ON”, the surrounding sound volume is lowered, and the sound in front is clearly recorded.

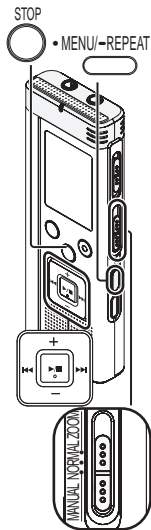

Recording position switch

- Set the Recording position switch to [MANUAL] (→ page 8).
- Press to stop the unit.

- 1 Press .
“XPLPSLP” (blinking) is displayed.
- 2 Press +, – to select “**ZOOM**” and press to enter.
- 3 Press , to select “ON” or “OFF” and press to enter.

Zoom ON



Zoom OFF



- Press to stop the setting process midway.
- The zoom function does not work as long as a device is connected to the external microphone jack even if the zoom is set to ON on this unit.
- When you perform zoom recording with the unit placed on the desk, etc., we recommend putting up the stand (→ page 4).

How to set the recording mode (XP/LP/SLP)

- Press to stop the unit.

- 1 Press .
“XPLPSLP” (blinking) is displayed.
- 2 Press to enter.
- 3 Press , to select among “XP”, “LP” and “SLP” and press to enter.

-
- If noise bothers you when recording/playing in SLP mode, use XP or LP mode.

Preventing unnecessary recording (VAS)/Confirming possible (remaining) recording time

VAS (Voice Activated System) function

Recording stops automatically when silence continues for about 3 seconds. If the unit detects sound, the recording resumes.

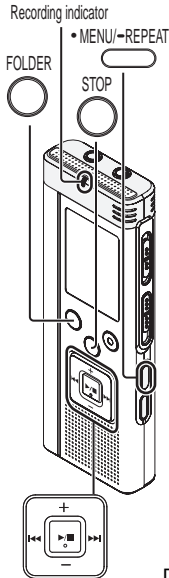

- Press **STOP** to stop the unit.

- 1 Press** **MENU/-REPEAT**.
“XPLPSLP” (blinking) is displayed.
- 2 Press** **+**, **-** to select “((()))” and press **▶/■** to enter.

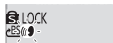

- 3 Press** **◀◀**, **▶▶** to select “0n” and press **▶/■** to enter.
Then “((()))” is displayed.



Start recording to activate this function. When the VAS function is active and the recording is paused during recording, “((()))” and the recording indicator blink.

Canceling VAS function:

Select “OFF” and enter in step **3**.

- **Turn the function off when recording important matters.**

- Press **STOP** to stop the setting process midway.

Confirming possible (remaining) recording time

- 1 Press and hold** **FOLDER** for **1 second or longer while recording or stopped.**

Remaining recording time is displayed for approx. 3 seconds.

When there is only a little* remaining memory left while recording, the display is automatically changed to the remaining recording time display.



The “= ” display while stopped shows approximate remaining memory.

“= ” lights up in response to the remaining time.

When there is only a little* remaining memory left, “= ” blinks.

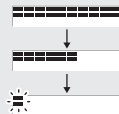

- * When the remaining recording time falls below approx. 1 hour.

Setting the playback speed control function

Playback speed can be adjusted at 5 different speeds.

- 1 Press **MENU/REPEAT** during playback.
“EQ” (blinking) and “SPEED” (lighting) are displayed.
(Only “SPEED” (blinking) is displayed when “♪” is selected.)
- 2 Press **▶▶▶** to select “SPEED” and press **▶/■** to enter.

- 3 Press **◀◀◀, ▶▶▶** to select playback speed.
When pressing **▶▶▶**, the playback speed becomes faster and “=” (blinking) moves to the right.
When pressing **◀◀◀**, the playback speed becomes slower and “=” (blinking) moves to the left.

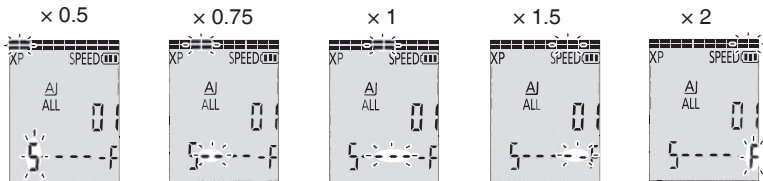

- 4 Press **▶/■** to enter.

- Press **STOP** to stop the setting process midway.
- When playing with speed other than $\times 1$ speed, the bar at the top blinks and “SPEED” lights up.

e.g. When playing back with $\times 0.75$ speed



Download from Www.Somanuals.com. All Manuals Search And Download.

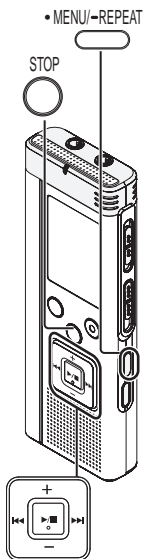

Reducing noise (EQ setting)/Slight return playback

Reducing noise (EQ setting)

This function makes it easier to hear sounds during playback.
You cannot make this setting when “♪” is selected.

- 1 Press **MENU/REPEAT** during playback.
“EQ” (blinking) and “SPEED” (lighting) are displayed.
- 2 Press **▶/■** to enter.
- 3 Press **◀◀, ▶▶** to select “**OFF**” and press **▶/■** to enter.



After setting, “EQ” is displayed while playing.

Canceling Noise reduction (EQ setting):

Select “**OFF**” and enter in step 3.

Setting Slight return playback

Slight Return Playback function: When **◀◀** is pressed during playback, the play point reverses about 5 seconds, and playback resumes from the point.

- Press **STOP** to stop the unit.

- 1 Press **MENU/REPEAT**.
“XPLPSLP” (blinking) is displayed.
- 2 Press **+, -** to select “**BS**” and press **▶/■** to enter.
- 3 Press **◀◀, ▶▶** to select “**OFF**” and press **▶/■** to enter.
Then “**BS**” is displayed.



Canceling Slight return playback:

Select “**OFF**” and enter in step 3.

-
- Press **STOP** to stop the setting process midway.
 - Slight return playback cannot be done during A-B Repeat play (→ page 19).
- Download from Www.Somanuals.com. All Manuals Search And Download.

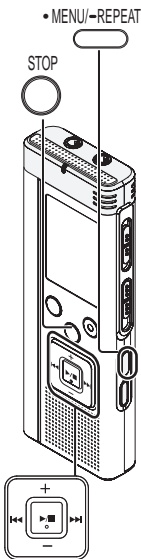

Repeat play/Successive play, A-B Repeat play

Repeat play/Successive play

Each time you press and hold  for 1 second or longer while stopped, the playback style is switched as follows.

ALL → ALL  → No display → 

"ALL" display

The selected file until the last file in the selected folder are played successively. The unit stops when the playback finishes. (The factory setting is "ALL".)

"ALL " display

Plays all files in the folder repeatedly.

No display

When the playback for one file finishes, the unit stops.

"" display

Plays one file repeatedly.

- Select one of the above settings and, press  to start playback.

A-B Repeat play

Playback repeats between the start point (A) and finish point (B) if those points are set.

- 1 Press and hold  for 1 second or longer while playing.

The start point (A) is set and "A-B" (blinking) and "" (lighting) are displayed.

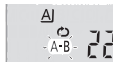



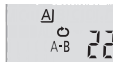

- 2 Press  at the finish point (B).

The display changes to "A-B" (lighting) and repeat play starts.



Canceling A-B Repeat:

Press and hold  for 1 second or longer, or press   while playing or the unit is stopped.

- You cannot set A-B Repeat in the following cases;
 - Within approx. 1 second from the beginning of the file and within approx. 2 seconds from the end of the file
 - Less than approx. 2 seconds between the start point (A) and finish point (B)
- When only the start point (A) is set and playback continues until the end of the file, the end becomes the finish point (B) and A-B Repeat begins.
- During A-B Repeat playback, the Slight return playback ( page 18) is not available.

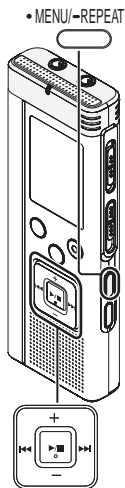



Security functions

If you set a password, password authentication is necessary when playing back this unit or connecting to a computer. When the unit is lost or stolen, the recorded data stored in this unit cannot be played or the computer does not recognize this unit as long as the password does not match.

If you forget the password, you cannot play files in folder A to D. Please write it down in MEMO section (→ right) not to forget.

Setting the password (4-digit number)

• Press  to stop the unit.

- 1 Press .
“XPLPSLP” (blinking) is displayed.
- 2 Press **+**, **-** to select “” and press **▶/■** to enter.
- 3 Press **◀◀**, **▶▶** to select “On” and press **▶/■** to enter.
Enters the password entry display.

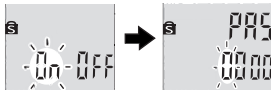

- 4 Press **+**, **-** to select a number and press **▶/■** to enter.

Move to the next digit and select a number. Repeat this until the 4th digit. (You can select a digit with **◀◀**, **▶▶**.) The password is determined when you finish entering the 4th digit. Then “” is displayed.

MEMO

Password	
----------	--

If the password has been set and you press **▶/■** to play a file, the password entry display appears (→ page 21).

Canceling the security lock:

- 1 Select “Off” and enter in step 3.
- 2 Perform step 4. (Enter the password.)

.....

- Press  to stop the setting process midway.
- To change the password, cancel the security lock and set a password again from step 1.

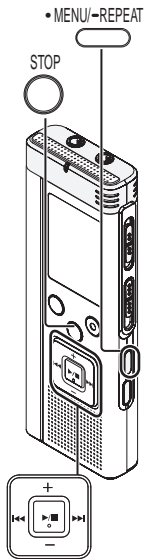

Authenticating the password

Perform step ④ in page 20.
(Enter the password.)



■ When the password matches

- The security lock is temporarily released and the audio file can be played. (“S” blinks while temporarily canceling.)
- In the condition ①, the security lock is set again.

①

- When you do not operate for more than approx. 15 minutes and the power turns off while the unit is stopped (→ page 6)
- When the unit is off for more than approx. 15 minutes

■ When the password is wrong

- The unit beeps and “PAS Err” is displayed, then the password entry display reappears. When wrong passwords are entered 5 times in succession, the unit stops accepting password entry. In that case, reenter the password in the condition ① (→ above).

■ When you have forgotten the password

To initialize the password, delete all files.

- ① Release all locks set on files in folder A through D (→ page 13).
- ② Delete all files in folder A through D (→ page 12).
- ③ Select “FF” in step ③ of “Setting the password (4-digit number)” and press ▶/■ to enter (→ page 20).

- If this unit is connected to a computer when the security lock is not canceled, the computer does not recognize this unit. After connecting the USB cable, the password entry display appears. Then, authenticate the password.
- Even if the security lock is not canceled, recording and playing music are available.

This security function is only to limit a playback function for files by password, not by encryption. We do not guarantee any kind of loss in case your password gets discovered.

Recording using an external microphone/Recording from other devices

Recording using an external microphone

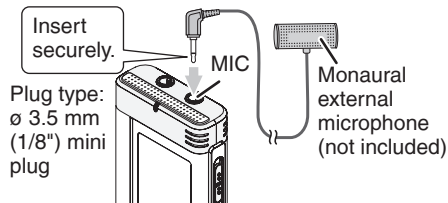

- 1 Record the audio (→ page 9).
- If the recording level is too low or high, adjust the microphone sensitivity (→ page 14).

Recording from other devices

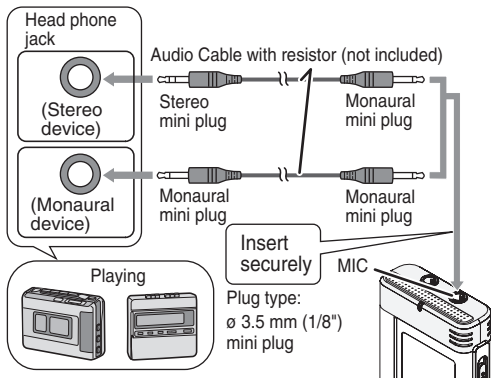

- 1 On the source, play audio you want to copy.
 - 2 On this unit, record the audio (→ page 9).
- Use the connection cable that matches monaural/stereo of the connected device. Wrong connection may cause recording trouble (i.e. Only 1 channel is recorded.).
 - The recorded sound may differ from the original recording sound.
 - Adjust the recording volume on the source to the desired level.

● **Read the operating instructions for the connected device.**

- The microphone function of this unit does not work as long as a device is connected to the external microphone jack.

Recording to other devices

- Cancel the operation beep while copying (→ right).

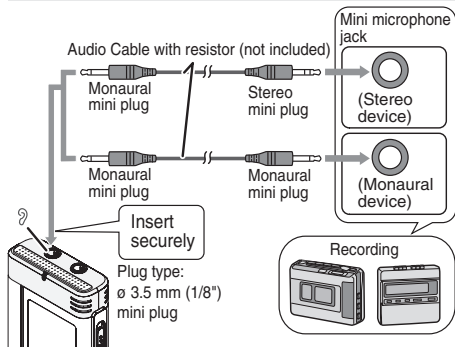

- ① On this unit, play the file you want to copy (→ page 10).
- ② Record using recording equipment.







.....

● Read the operating instructions for the connected device.

- Use the connection cable that matches monaural/stereo of the connected device. Wrong connection may cause recording trouble (i.e. Only 1 channel is recorded.).
- The recorded sound quality may differ from the sound quality of this unit.
- Adjust the recording volume on this unit to the desired level.

Canceling the operation beep

- Press  to stop the unit.

- ① Press  .
“XPLPSLP” (blinking) is displayed.
- ② Press +, - to select “” and press  to enter.
- ③ Press ,  to select “” and press  to enter.

Setting the operation beep ON:
Select “” and enter in step ③.

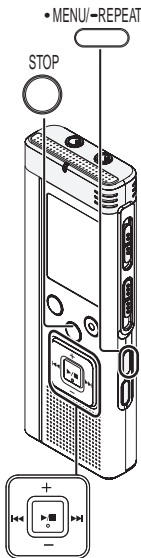

-
- Press  to stop the setting process midway.

Connecting this unit to a computer

You can copy files recorded on this unit to the computer.

- Start the computer beforehand.
- Press  to stop the unit.

1. Insert the USB cable into this unit.
2. Insert the USB cable into the computer.

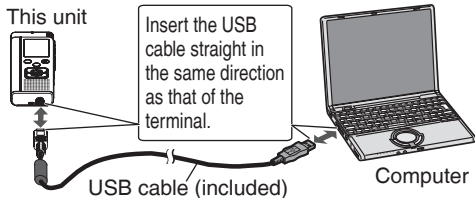

- Do not use any other USB connection cables except the supplied one. "PL" is displayed on the unit's screen when the computer recognizes this unit.

Use the supplied USB cable.
Do not use the supplied cable with other devices.

Caution: Use only the included USB cable with a ferrite core when connecting to computer.

When the computer does not recognize this unit

If "PAS" is displayed, enter the password (→ page 21).

00 00

If "USB--n0" is displayed, disconnect this unit from the computer once, replace the batteries, and reconnect the unit to the computer.



- Even if you connect this unit to the computer without the battery or with the depleted battery, the computer cannot recognize this unit (→ page 33).

System requirements (OS)

Windows 2000 (SP4), Windows XP and SP2, SP3, Windows Vista and SP1 (As of December 2008)

- Please see page 31 for details of system requirements.

Removing the USB cable

Double-click the icon (Windows 2000/Windows XP: , Windows Vista: ) on the task tray at the bottom of the computer screen and follow the on-screen instructions to remove the USB cable. (The icon may not be displayed depending on the OS settings.) After the cable is removed, this unit turns off.

USB mass storage function

This unit functions as a USB memory and is recognized as a computer's external storage device. Data files in the computer can be transferred and saved in this unit.

-
 - When the unit is connected to the computer, the computer may not start (restart). It is recommended that the USB cable is removed from this unit when starting (restarting) the computer.
 - When the unit is connected to the computer, if you start (restart) the computer or the computer enters standby mode, the computer may not recognize the unit. Disconnect the unit and reconnect to the computer or reconnect the unit after the computer is restarted.
 - Operation is not guaranteed when 2 or more USB devices are connected to 1 computer, or a USB hub or extension cable are used.
- Manual Search And Download

Opening the folder of this unit using a computer

The illustrations show Windows XP (OS). The display may differ depending on the OS.

- Connect this unit to a Computer beforehand (→ page 24).

1. Click [Start] → [My Computer].

This unit is displayed as a removable disk.

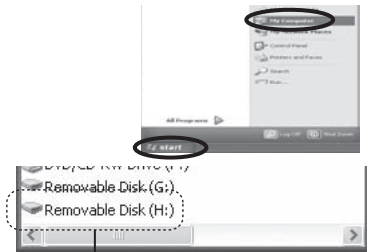

A removable disk is an external storage device (SD memory card, USB memory etc.) connected to the computer.

The components of the computer and the external storage device illustrated here is an example.

The display may differ depending on the computer you are using.

"H" indicated in Removable Disk (H:) is not a fixed character.

2. Right-click to open the removable disk (this unit).

The folders (A to D, MUSIC) in this unit appear. (They are displayed as **A|B|C|D|♪** on this unit's screen.)

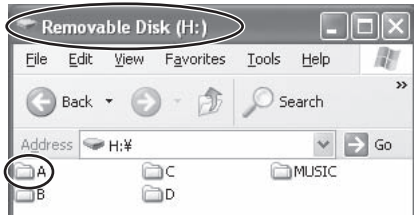

3. Right-click to open the folder.

Recorded files in this unit appear.



Importing the recorded files in this unit to a computer/Organizing files

- Open the removable disk (this unit) displayed on the computer screen and open the audio folder (A to D) beforehand (→ page 25).

Importing recorded files to a computer

1. Select the recorded file in this unit, right-click and select [Copy].
2. Select a folder in the computer, right-click and select [Paste] to import to the computer.

Folder in this unit



Folder in the computer

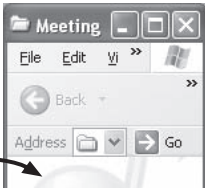

Playing recorded files on the computer:

Select the recorded file in this unit, right-click and select [Play].

Delete unnecessary files using the computer:

Select the recorded file in this unit, right-click, select [Delete] and [Yes] to enter.

Do not change the folder names

If you change the names of folders (A, B, C, D, MUSIC) of this unit, new A, B, C, D and MUSIC folders are generated when this unit is disconnected from the computer. The files in the folders with changed names cannot be played on this unit.

- Using [drag and drop], you can import the files to the computer as well.
- If the file is deleted, file numbers displayed on this unit are moved forward.
- “P” (blinking) is displayed during the data transmission. **Never remove the USB cable** while “P” is blinking. File data or this unit may be destroyed, or all the data in this unit may be lost.
- When this unit is removed from the computer or the power is turned on afterwards, “CF” is displayed for a moment while updating the file data.
- **Do not format this unit using a computer.**

Returning the files imported to the computer to this unit

- Open the audio folder (A to D) of this unit beforehand (→ page 25).

Returning recorded files to this unit from the computer

1. Select the recorded file imported to the computer (→ page 26), right-click and select [Copy].
2. Select the original folder in this unit, right-click and select [Paste] to return the recorded file.

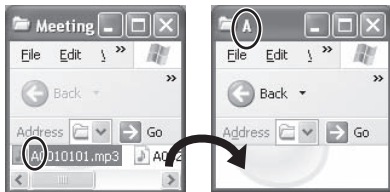

Reload the files to the original folder that the files were imported from. When you reload the files to other folders, those files cannot be played on this unit. (Confirm the first character (A to D) of the file name matches the folder name (A to D).)

Do not change the file names

If you change file names, those files cannot be played on this unit. Return the file name to the original one or move the file to MUSIC folder.

- MP3 music files which were not recorded on this unit can be played only in MUSIC folder. If the file is returned to folder A to D, it cannot be played on this unit. (The file number is not displayed on the screen of this unit.)
- Up to 99 files in folder A to D respectively can be played on this unit. Files over 99 cannot be played on this unit.
- If you create folders in folder A to D, and put recorded files in the new folder, those files cannot be played on this unit.
- The files that are returned to this unit are played back in the order the files are received. For example, even if the file is recorded first, the playback order becomes 5th if the file is reloaded from the computer at 5th.

File naming rules (for recorded files on this unit)

The file name consists of [Folder name (1 byte, 1 character (A to D)) + File number (1 byte, 3 characters + Recording date (1 byte, 4 numbers)].
e.g. if the file is recorded as the first file in folder A on July 20, the name is "A0010720.mp3". The second file on the same day is named as "A0020720.mp3".

Listening to music on this unit (Transferring MP3 music files to this unit)

You can enjoy music by transferring MP3 music files stored in the computer to this unit.

Transferring MP3 music files to this unit from the computer

- Open MUSIC folder (📁) of this unit beforehand (→ page 25).

1. Select an MP3 music file or folder which has MP3 music files in the computer, right-click and select [Copy].
2. Select MUSIC folder of this unit, right-click and select [Paste] to transfer to this unit.

.....

- The files in the folder that was created into the MUSIC folder are playable. However, note that playable folders are the ones on the 1st hierarchy and 2nd hierarchy only. Folders on the 3rd hierarchy and after are not playable.

- The audio files and folders that are loaded to this unit are played back in the order the files and folders are received. But in case of the structure at right, files in M2 are played after all files in M1 are played since the loaded order of 1st hierarchy takes priority. Even if M1-2 is loaded after M2-1, the files in M1-2 are played first.

- Files just under the folder are played first; e.g., even if A.mp3 was loaded last, A.mp3 is played first.

- In the case of the structure shown at right, the order of successive playback on this unit is A.mp3 → B.mp3 → C.mp3 → D.mp3 → E.mp3 → F.mp3 → G.mp3 → H.mp3.

Folder/file structure in MUSIC folder (example)

This is an example when M1 was loaded before M2 for M1 and M2, M1-1 was loaded before M1-2 for M1-1 and M1-2, C.mp3 was loaded before D.mp3 for C.mp3 and D.mp3.

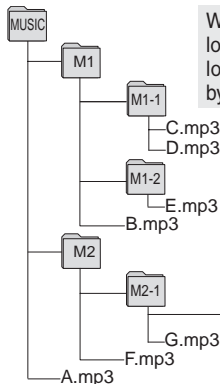

When two or more files are loaded at a time, those are loaded in an order decided by the computer.

This is not playable because this is on the 3rd hierarchy.

(M1, etc. represent a folder and A.mp3, etc. represent a file.)

-
- “” (blinking) is displayed during data transmission. **Never remove the USB cable** while “” is blinking. File data or this unit may be destroyed.

Listening to music on this unit (Playing MP3 music files on this unit)

- Remove the USB cable (→ page 24).
- Turn the power on (→ page 6).
- Press  to stop the unit.

1 Press  to select “” (MUSIC folder).

2 Press ,  to select the file you want to listen.

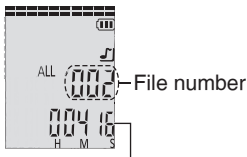

After selection, the length of the music and the total number of files in MUSIC folder are displayed.

3 Press  (Playback starts).

Stop:

Press  or .

- See pages 10 and 11 for playback operations.
- In “” folder, you can play a maximum of 999 files. Files over 999 cannot be played on this unit.
- The file name or folder name cannot be displayed. Successive numbers, starting from “001” (file number) are displayed according to the order of playback.
- Files other than files with MP3 format, such as WMA, AAC format files cannot be played. (The number is not displayed on screen.)
- Copyright-protected MP3 music files cannot be played.
- MP3 music files with variable bit rate may be played, but the playback elapsed time display may differ from the actual time.

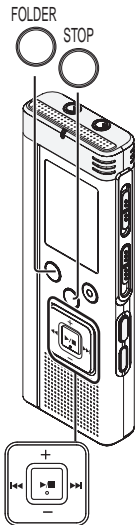

Creating MP3 music files

This unit is not equipped with the function or computer software to create MP3 file from music CD. You can create MP3 music files using separately sold computer software, etc.

Windows XP or Windows Vista users can create MP3 music files using Windows Media Player 11.

Following is the example of operating instructions when using Windows XP and Windows Media Player 11. See [Help] section of Windows Media Player for more details. (The display and operations may differ depending on the OS.)

- Start the computer beforehand.

1. Select [Start] - [All Programs] and start [Windows Media Player] on the computer.
2. Select [Rip] → [Format] → [mp3].
3. Select [Rip] → [Bit Rate] and select among [128kbps] (Smallest Size), [192kbps], [256kbps] and [320kbps] (Best Quality).
If you select low Bit Rate for ripping, more songs will be ripped.
4. Select [Rip] → [Rip CD Automatically When Inserted] and select [Never].
5. Set music CD into the computer.
6. In “” for the album, add the check mark as “”.
If there are songs you do not want to rip, remove the check mark “”.
7. Click [Start Rip] to begin ripping.

Music files ripped (encoded) into the computer using Windows Media Player are saved in [My Music] folder of [My Document] if the destination to save has not been changed.

- ● Windows Media Player 9 and older versions cannot create MP3 music file.
- ● Please see the homepage of the Microsoft company for details of download/update of Windows Media Player etc.
<http://www.microsoft.com/windows/windowsmedia/player/11/default.aspx>
- ● If you cannot create MP3 music files successfully or do not know how to operate the computer, please consult the computer manufacturer.
- ● See page 28 for transferring MP3 music file to this unit and page 29 for playback.

System requirements

Computer	IBM PC/AT compatible machines
OS	<ul style="list-style-type: none">• Windows® 2000 Professional SP4• Windows® XP Home Edition/Professional and SP2, SP3• Windows Vista® Home Basic/Home Premium/Business/Ultimate and SP1
Interface	USB port (Operation cannot be guaranteed if you use a USB hub or extension cable.)
<p>* Even if the system requirements mentioned in this document are fulfilled, some personal computers cannot be used.</p> <p>* Operation is guaranteed only on compliant OSes.</p> <p>* Operation is not guaranteed on an upgraded OS.</p> <p>* Not compatible with multiboot environments.</p> <p>* Operation is not guaranteed on home-made computers.</p> <p>* Operation is not guaranteed on 64-bit computers.</p> <p>* When using Windows Media® Player, your computer must fulfill the system requirements of Windows Media® Player. Please consult Microsoft Corporation for details of Windows Media® Player.</p> <p>* Microsoft, Windows, Windows Media and Windows Vista are registered trademarks or trademarks of Microsoft Corporation of the U.S. and other countries.</p> <p>* MPEG Layer-3 audio coding technology licensed from Fraunhofer IIS and Thomson multimedia.</p> <p>* IBM and PC/AT are registered trademarks of International Business Machines Corporation of the U.S.</p> <p>* Other system names and product names appearing in this document are in general the registered trademarks or trademarks of the respective developer companies. Note that the ™ mark and ® mark do not appear in this document.</p> <p>* Depending on the computer environment, malfunctions may occur (e.g. Audio data recorded on this unit cannot be used. etc.). Panasonic and Panasonic dealers cannot be held liable for any lost audio data or other direct or indirect damage except in cases of intentional or gross negligence.</p> <p>* This model is not compatible with TRC/ADPCM format IC recorders made by Panasonic. Also, files recorded on this unit cannot be played on those IC recorders and/or cannot be read using Voice Editing software supplied with those IC recorders.</p> <p>* You can transfer contents recorded on this unit to your PC without using the dedicated software. The computer software (Voice Editing) is not supplied with this unit.</p>	

Q & A (Frequently Asked Questions)

Question	Answer
Can I play recording files stored on Panasonic IC recorder RR-US750?	• Can play if they are transferred to MUSIC folder (→ page 27).
Can I play recording files stored on other Panasonic IC recorders than RR-US750?	• Cannot play because the recording format is different.
Can I use audio editing software (Voice Editing) included in other Panasonic IC Recorder?	• The Voice Editing cannot be used for this product because the recording format differs from the format used for other Panasonic IC recorders. The recording format used for this product is MP3 format. This product is not compatible with the voice editing software (Voice Editing) supplied with Panasonic IC recorders using ADPCM and TRC format.
Can I secure any folder in this unit?	• Only folder A through D can be secured. MUSIC folder cannot be secured. • If the security lock is set when connected to a computer, the password authentication is necessary for the computer to recognize this unit.
What kind of files can be played?	• Only MP3 file can be played. WMA, AAC and other files cannot be played.
What kind of computers can be connected with this unit?	• Windows 2000 (SP4), Windows XP, Windows Vista only. Please refer to "System requirements" (→ page 31).
Can I do timer recording?	• No, you cannot.
Can I divide a file or delete a portion of a file?	• No, you cannot.

Troubleshooting guide

Before requesting service, make the following checks. If you are in doubt about some of the check points, or if the remedies indicated in the chart do not solve the problem, refer to “Customer Services Directory (United States and Puerto Rico)” on page 43 if you reside in the U.S.A. and Puerto Rico, or refer to “Product information” on page 38 if you reside in Canada.

Symptom	Checkpoints
Battery	
Cannot use a battery that can be still used on other equipment.	<ul style="list-style-type: none">This unit considers the battery as empty even if there is actually power left in it. This is to preserve the clock setting.
Operations	
No operation.	<ul style="list-style-type: none">Make sure the batteries are correctly inserted.You cannot operate on this unit when the unit is connected to a computer.
Cannot operate when “HOLD” appears.	<ul style="list-style-type: none">The Hold function is on. Switch Hold off (→ page 6).
Display	
“CLOCK”, “12:00” blinks.	<ul style="list-style-type: none">Please set the time (→ page 7).
“FULL” appears.	<ul style="list-style-type: none">There are 99 files in folder A, B, C, D.There is no remaining memory (→ page 39). Delete unnecessary recording files, files and data other than MP3 files (→ pages 12, 26).
“BATT - -” appears.	<ul style="list-style-type: none">If the batteries are extremely exhausted, “BATT - -” is displayed even if the unit is connected to the computer and the computer does not recognize this unit. Disconnect this unit from the computer once, replace the batteries (if batteries are not inserted, insert batteries.) (→ page 5) and reconnect it.
“ [F]” RECE SS appears.	<ul style="list-style-type: none">This appears when updating data in this unit (e.g. after disconnecting this unit from the computer, when turning the power on, etc.).
Normal display appears during setting operation	<ul style="list-style-type: none">When you do not operate for 60 seconds during setting operation, the setting in process is canceled and normal display appears.
“FAT Err” appears.	<ul style="list-style-type: none">Format was performed on a computer, etc., or the file system is damaged. Perform format on this unit (The data is all erased after formatting is complete.) (→ page 12).

Troubleshooting guide

Symptom	Checkpoints
Display	
“ FILE ERROR ” appears.	<ul style="list-style-type: none"> The operation program is damaged. Consult your dealer.
“ FILE ” appears.	<ul style="list-style-type: none"> You tried to play an MP3 file that cannot be played on this unit, or the MP3 file is damaged. Delete the MP3 file that cannot be played. If the problem persists, the file system is damaged. Perform format on this unit (The data is all erased after formatting is complete.) (→ page 12).
Record	
<p>The memory is used completely earlier than expected. (“FULL” is displayed earlier than expected.)</p>	<ul style="list-style-type: none"> Available recording time differs approx. 8 times, comparing XP mode with SLP mode (→ page 39). You can record longer if recording in SLP mode (→ page 15). If you lower the Bit Rate for ripping music CDs, more songs will be saved (→ page 30). Is much data other than MP3 stored? Delete unnecessary data (→ page 26).
Recording stops halfway.	<ul style="list-style-type: none"> VAS is functioning (→ page 16).
Howling occurs when listening to the recording in progress with earphones.	<ul style="list-style-type: none"> Turn down the volume (→ page 10). Keep earphones and this unit separate. When you are using an external microphone, keep earphones and external microphone separate.
Recording ended halfway.	<ul style="list-style-type: none"> The data may not be updated if the unit receives a shock (e.g. it is dropped), or the batteries go out during recording.
“---” appears instead of the recording date.	<ul style="list-style-type: none"> Set the time (→ page 7).
“ZOOM” is not displayed.	<ul style="list-style-type: none"> You are using the external microphone (→ page 15).
Playing	
Cannot play the recorded file though it was recorded on this unit.	<ul style="list-style-type: none"> The file name was changed. Only files named according to the file naming rules (→ page 27) can be played in folder A through D.

Symptom	Checkpoints
Playing	
Playback speed is too fast or slow.	<ul style="list-style-type: none"> You changed the playback speed (→ page 17).
The order of playing changed after reloading files that were once imported to the computer to this unit.	<ul style="list-style-type: none"> This occurs because files imported from the computer are placed at the end in the folder.
There is no sound from the earphones or it is difficult to hear or noisy.	<ul style="list-style-type: none"> Ensure the plug is inserted firmly. Wipe the plug clean.
The sound is distorted. There is a noise at the beginning of sound.	<ul style="list-style-type: none"> Please lower the microphone sensitivity (→ page 14) or keep more distance from the recording sound source.
No sound from the speaker.	<ul style="list-style-type: none"> There is no sound when you have connected earphones.
I hear noises.	<ul style="list-style-type: none"> Move a mobile telephone away from this unit when you use the two in the same area.
Recorded sounds contain noise that makes it difficult to hear sounds.	<ul style="list-style-type: none"> Reduce noise (→ page 18). Noise is reduced and listening may become easier.
Others	
The power cannot be turned on.	<ul style="list-style-type: none"> The batteries may have run out. Replace the batteries with the new ones (→ page 5).
The power automatically turns off.	<ul style="list-style-type: none"> When you do not operate for more than approx. 15 minutes, the power automatically turns off. When you slide the OPERATION/HOLD switch to "OPER-" side, the power is turned on (→ page 6).
Cannot delete a file or folder.	<ul style="list-style-type: none"> The file is protected (→ page 13). The folder is already empty. " (blinking) is displayed (→ page 12).
This unit is not recognized by a computer.	<ul style="list-style-type: none"> The OS on the computer may not be compliant with this unit (→ page 31). The password has been set (→ page 21). Are the batteries in this unit? If they are not, insert batteries. When the voltage of the batteries are too low, "U5b--nU" is displayed and the computer cannot recognize this unit (→ page 33).

Care and use

To reduce risk of radio interference caused by headphone-, earphone- or microphone cables, only use adequate accessories with a cable length of less than 3 m (9.8 ft.).

■ Unit

- Avoid using or placing this unit near sources of heat.
- To avoid product damage, do not expose this product to rain, water or other liquids.
- The unit's speaker does not have magnetic shielding. Do not place the unit near televisions, personal computers, magnetized cards (bank cards, commuter passes) or other devices easily influenced by a magnet.

■ Batteries

- Do not peel off the covering on batteries and do not use the batteries if the covering has been peeled off.
- Align the poles \oplus and \ominus correctly when inserting the batteries.
- Do not mix different types of batteries or old and new batteries.
- Remove the batteries if you do not intend to use the unit for a long time.
- Do not heat or expose to flame.
- Do not leave the batteries in an automobile exposed to direct sunlight for a long period of time with doors and windows closed.
- Do not attempt to recharge dry cell batteries.
- Battery mishandling can cause electrolyte leakage which can damage items the fluid contacts and may cause a fire. If electrolyte leaks from the batteries, consult your dealer. Wash thoroughly with water if electrolyte comes in contact with any part of your body.
- Keep the AAA LR03 batteries out of reach of children to prevent swallowing. Accidental swallowing of batteries can result in stomach and intestinal damage.
- When carrying batteries in a pocket or bag, ensure no metal objects such as necklaces are placed together with them. Contact with metal may cause short-circuiting which can cause a fire. For safety, carry the batteries in the battery carrying case.

■ Allergies

- Discontinue use if you experience discomfort with the earphones or any other parts that directly contact your skin.
- Continued use may lead to skin irritation or allergic reactions.

■ Listening caution



Do not play your headphones or earphones at a high volume. Hearing experts advise against continuous extended play.

If you experience a ringing in your ears, reduce volume or discontinue use.

Do not use while operating a motorized vehicle. It may create a traffic hazard and is illegal in many areas.

You should use extreme caution or temporarily discontinue use in potentially hazardous situations.

Even if your headphones or earphones are the open-air type designed to let you hear outside sounds, don't turn up the volume so high that you can't hear what's around you.

Sound can be deceiving. Over time your hearing "comfort level" adapts to higher volumes of sound. So what sounds "normal" can actually be loud and harmful to your hearing.

Guard against this by setting your equipment at a safe level BEFORE your hearing adapts.

To establish a safe level:

- Start your volume control at a low setting.
- Slowly increase the sound until you can hear it comfortably and clearly, and without distortion.

Once you have established a comfortable sound level:

- Leave it there.

Maintenance

Clean this unit with a dry and soft cloth.

- If the unit becomes too dirty, wring a cloth moistened in water, wipe the dirt with it and clean with a dry cloth.
- Do not use solvents including benzene, thinner, alcohol, kitchen detergent, a chemical wiper, etc. This might cause the exterior case to be deformed or the coating to come off.

-If you see this symbol-

Information on Disposal in other Countries outside the European Union



This symbol is only valid in the European Union.

If you wish to discard this product, please contact your local authorities or dealer and ask for the correct method of disposal.

Product Service

- 1. Damage requiring service** – The unit should be serviced by qualified service personnel if:
 - (a) Objects or liquids have gotten into the unit; or
 - (b) The unit has been exposed to rain; or
 - (c) The unit does not operate normally or exhibits a marked change in performance; or
 - (d) The unit has been dropped or the cabinet damaged.
- 2. Servicing** – Do not attempt to service the unit beyond that described in these operating instructions. Refer all other servicing to authorized servicing personnel.
- 3. Replacement parts** – When parts need replacing ensure the servicer uses parts specified by the manufacturer or parts that have the same characteristics as the original parts. Unauthorized substitutes may result in fire, electric shock, or other hazards.
- 4. Safety check** – After repairs or service, ask the servicer to perform safety checks to confirm that the unit is in proper working condition.

Product information

For product information or assistance with product operation:

In the U.S.A. and Puerto Rico, refer to “Customer Services Directory (United States and Puerto Rico)” on page 43.

In Canada, contact the Panasonic Canada Inc. Customer Care Centre at 1-800-561-5505, or visit the website (www.panasonic.ca), or an authorized Servicentre closest to you.

Specifications

Power

Batteries	DC 3.0 V (2 AAA LR03 batteries)
------------------	---------------------------------

Audio

Sampling Frequency	XP: 44.1 kHz LP: 16 kHz SLP: 8 kHz
---------------------------	--

Recording Format	MP3
-------------------------	-----

Playable Bit Rate (MUSIC folder)	8 kbps to 320 kbps
---	--------------------

Playable Sampling Frequency (MUSIC folder)	8 kHz to 48 kHz
---	-----------------

Frequency Response (-10 dB, Rec-Play, Monaural)	XP: 180 Hz to 15,100 Hz LP: 180 Hz to 6,700 Hz SLP: 180 Hz to 2,900 Hz
--	--

Built-in Microphone S/N Ratio	40.5 dB (XP) Filter (JIS A)
--------------------------------------	-----------------------------

USB	USB2.0 (Hi-Speed)
------------	-------------------

Audio Output	Earphone	ø 3.5 mm (1/8"), 16 Ω, Max. 3 mW
	Speaker output	ø 20 mm (25/32"), 8 Ω, Max. 330 mW

Audio Input	External Microphone	ø 3.5 mm (1/8"); 0.80 mV plug in power
--------------------	----------------------------	---

Built-in Memory	512 MB ^{*1}
------------------------	----------------------

Operating Temperature	0°C to 40°C (32°F to 104°F)
------------------------------	-----------------------------

Operating Humidity	20% to 80% (non-condensing)
---------------------------	-----------------------------

*1 MB means one million bytes. Usable capacity will be less.

Battery life (may be less depending on the operating conditions.)

Battery (AAA LR03)	Recording mode	Rec^{*3}	Play^{*4}
Alkaline battery ^{*2}	XP	approx.32 h.	approx.35 h.
	LP	approx.42 h.	approx.35 h.
	SLP	approx.45 h.	approx.35 h.

*2 Using Panasonic Alkaline battery.

*3 When zoom microphone is off.

*4 When audio is output from speaker (Volume: 13, EQ: off, playback speed control : x 1)

Standard recordable time

Recording mode	Time	Bit rate
XP	17 h.50 min.	64 kbps
LP	35 h.40 min.	32 kbps
SLP	142 h.50 min.	8 kbps

Max. Dimensions (W × H × D)

40.4 mm × 110.6 mm × 16.8 mm (1-19/32" × 4-11/32" × 21/32")

Cabinet dimensions (W × H × D)

39 mm × 110.3 mm × 15.1 mm (1-17/32" × 4-11/32" × 19/32")

Mass (Weight)

Approx. 65 g (2.29 oz.) with battery

Approx. 43 g (1.51 oz.) without battery

● Specifications are subject to change without notice.

Limited Warranty (ONLY FOR CANADA)

Panasonic Canada Inc.

5770 Ambler Drive, Mississauga, Ontario L4W 2T3

PANASONIC PRODUCT – LIMITED WARRANTY

EXCHANGE PROGRAM

Panasonic Canada Inc. warrants this product to be free from defects in material and workmanship and agrees to replace the product for a period as stated below from the date of original purchase.

Panasonic Portable / Clock Radio (without Tape, CD, MD)	One (1) year
Panasonic Audio Product	One (1) year
Panasonic DVD Product	One (1) year
Accessories including rechargeable batteries	Ninety (90) days

LIMITATIONS AND EXCLUSIONS

This warranty does not apply to products purchased outside Canada or to any product which has been improperly installed, subjected to usage for which the product was not designed, misused or abused, damaged during shipping, or which has been altered or repaired in any way that affects the reliability or detracts from the performance, nor does it cover any product which is used commercially. Dry cell batteries are also excluded from coverage under this warranty.

This warranty is extended to the original end user purchaser only. A purchase receipt or other proof of date of original purchase is required before warranty service is performed.

THIS EXPRESS, LIMITED WARRANTY IS IN LIEU OF ALL OTHER WARRANTIES, EXPRESS OR IMPLIED, INCLUDING ANY IMPLIED WARRANTIES OF MERCHANTABILITY AND FITNESS FOR A PARTICULAR PURPOSE.

IN NO EVENT WILL PANASONIC CANADA INC. BE LIABLE FOR ANY SPECIAL, INDIRECT OR CONSEQUENTIAL DAMAGES.

Download from Www.Somanuals.com. All Manuals Search And Download.

Limited Warranty (ONLY FOR U.S.A. AND PUERTO RICO)

Panasonic Consumer Electronics Company,
Division of Panasonic Corporation of North America
One Panasonic Way, Secaucus, New Jersey 07094

Panasonic Audio Products Limited Warranty

Limited Warranty Coverage (For USA and Puerto Rico Only)

If your product listed below does not work properly because of a defect in materials or workmanship, Panasonic Consumer Electronics Company (referred to as "the warrantor") will, for the length of the period indicated on the chart below, which starts with the date of original purchase ("warranty period"), at its option either (a) repair your product with new or refurbished parts, or (b) replace it with a new or a refurbished product. The decision to repair or replace will be made by the warrantor.

Product or Part Name	Parts	Labor
Radio, Clock Radio, Radio with Tape Player or Recorder, Portable CD Player, IC Recorder, Headphone Stereo, Tape Recorder	One (1) Year	One (1) Year
Rechargeable batteries (in exchange for defective item)	Ten (10) Days	Not Applicable
SD Memory Card (in exchange for defective item)	Ninety (90) Days	Not Applicable

During the "Labor" warranty period there will be no charge for labor. During the "Parts" warranty period, there will be no charge for parts. You must mail-in your product during the warranty period. This Limited Warranty excludes both parts and labor for batteries, antennas, and cosmetic parts (cabinet). This warranty only applies to products purchased and serviced in the United States or Puerto Rico. This warranty is extended only to the original purchaser of a new product which was not sold "as is". A purchase receipt or other proof of the original purchase date is required for warranty service.

Mail-In Service

For assistance in the U.S.A. and Puerto Rico in obtaining repairs please ship the product prepaid to:

**Panasonic Service and Technology Company, Exchange Center,
4900 George McVay Drive, Suite B Door #12, McAllen, TX 78503**

panacare@us.panasonic.com

When shipping the unit carefully pack, include all accessories, and send it prepaid, adequately insured and preferably in the original carton. Include a letter detailing the complaint, a return address and provide a day time phone number where you can be reached. A valid registered receipt is required under the Limited Warranty.

Limited Warranty Limits And Exclusions

This warranty ONLY COVERS failures due to defects in materials or workmanship, and DOES NOT COVER normal wear and tear or cosmetic damage. The warranty ALSO DOES NOT COVER damages which occurred in shipment, or failures which are caused by products not supplied by the warrantor, or failures which result from accidents, misuse, abuse, neglect, mishandling, misapplication, alteration, faulty installation, set-up adjustments, misadjustment of consumer controls, improper maintenance, power line surge, lightning damage, modification, introduction of sand, humidity or liquids, commercial use such as hotel, office, restaurant, or other business or rental use of the product, or service by anyone other than a Factory Service Center or other Authorized Servicer, or damage that is attributable to acts of God.

THERE ARE NO EXPRESS WARRANTIES EXCEPT AS LISTED UNDER "LIMITED WARRANTY COVERAGE".

THE WARRANTOR IS NOT LIABLE FOR INCIDENTAL OR CONSEQUENTIAL DAMAGES RESULTING FROM THE USE OF THIS PRODUCT, OR ARISING OUT OF ANY BREACH OF THIS WARRANTY.

(As examples, this excludes damages for lost time, cost of having someone remove or re-install an installed unit if applicable, travel to and from the servicer, loss of or damage to media or images, data or other memory or recorded content. The items listed are not exclusive, but are for illustration only.)

ALL EXPRESS AND IMPLIED WARRANTIES, INCLUDING THE WARRANTY OF MERCHANTABILITY, ARE LIMITED TO THE PERIOD OF THE LIMITED WARRANTY.

Some states do not allow the exclusion or limitation of incidental or consequential damages, or limitations on how long an implied warranty lasts, so the exclusions may not apply to you.

This warranty gives you specific legal rights and you may also have other rights which vary from state to state. If a problem with this product develops during or after the warranty period, you may contact your dealer or Service Center. If the problem is not handled to your satisfaction, then write to the warrantor's Consumer Affairs Department at the addresses listed for the warrantor.

PARTS AND SERVICE, WHICH ARE NOT COVERED BY THIS LIMITED WARRANTY, ARE YOUR RESPONSIBILITY.

Customer Services Directory (United States and Puerto Rico)

Obtain Product Information and Operating Assistance; locate your

nearest Dealer or Service Center; purchase Parts and Accessories; or make Customer Service and Literature requests by visiting our Web Site at:

<http://www.panasonic.com/help>

or, contact us via the web at:

<http://www.panasonic.com/contactinfo>

You may also contact us directly at:

1-800-211-PANA (7262),

Monday-Friday 9 am-9 pm; Saturday-Sunday 10 am-7 pm, EST.

For hearing or speech impaired TTY users, TTY: 1-877-833-8855

Accessory Purchases (United States and Puerto Rico)

Purchase Parts, Accessories and Instruction Books online for all Panasonic Products by visiting our Web Site at: <http://www.pstc.panasonic.com>

or, send your request by E-mail to: npcparts@us.panasonic.com

You may also contact us directly at:

1-800-332-5368 (Phone) 1-800-237-9080 (Fax Only)

(Monday – Friday 9 am to 9 pm, EST.)

Panasonic Service and Technology Company

20421 84th Avenue South, Kent, WA 98032

(We Accept Visa, MasterCard, Discover Card, American Express, and Personal Checks)

For hearing or speech impaired TTY users, TTY: 1-866-605-1277

As of October 2008

Other

RQT9422

43

THE FOLLOWING APPLIES ONLY IN THE U.S.A.

FCC Note:

This equipment has been tested and found to comply with the limits for a Class B digital device, pursuant to Part 15 of the FCC Rules. These limits are designed to provide reasonable protection against harmful interference in a residential installation. This equipment generates, uses, and can radiate radio frequency energy and, if not installed and used in accordance with the instructions, may cause harmful interference to radio communications. However, there is no guarantee that interference will not occur in a particular installation. If this equipment does cause harmful interference to radio or television reception, which can be determined by turning the equipment off and on, the user is encouraged to try to correct the interference by one or more of the following measures:

- Reorient or relocate the receiving antenna.
- Increase the separation between the equipment and receiver.
- Connect the equipment into an outlet on a circuit different from that to which the receiver is connected.
- Consult the dealer or an experienced radio/TV technician for help.

FCC Caution: To assure continued compliance, follow the attached installation instructions and use only shielded interface cables with ferrite core when connecting to computer or peripheral devices.

Any changes or modifications not expressly approved by the party responsible for compliance could void the user's authority to operate this equipment.

Declaration of Conformity

Trade Name: Panasonic
Model no.: RR-US550
Responsible party: Panasonic Corporation of North America
One Panasonic Way,
Secaucus, NJ 07094
Support Contact: Panasonic Consumer
Electronics Company 1-800-
211-PANA (7262)

This device complies with Part 15 of the FCC Rules. Operation is subject to the following two conditions: (1) This device may not cause harmful interference, and (2) this device must accept any interference received, including interference that may cause undesired operation.

THE FOLLOWING APPLIES ONLY IN CANADA.

This Class B digital apparatus complies with Canadian ICES-003.

Panasonic Consumer Electronics Company, Division of Panasonic Corporation of North America

One Panasonic Way, Secaucus, New Jersey 07094

Panasonic Canada Inc.

5770 Ambler Drive, Mississauga, Ontario L4W 2T3

<http://www.panasonic.com>

www.panasonic.ca

© Panasonic Corporation 2008

Printed in Malaysia Download from Www.Somanuals.com. All Manuals Search And Download.

Free Manuals Download Website

<http://myh66.com>

<http://usermanuals.us>

<http://www.somanuals.com>

<http://www.4manuals.cc>

<http://www.manual-lib.com>

<http://www.404manual.com>

<http://www.luxmanual.com>

<http://aubethermostatmanual.com>

Golf course search by state

<http://golfingnear.com>

Email search by domain

<http://emailbydomain.com>

Auto manuals search

<http://auto.somanuals.com>

TV manuals search

<http://tv.somanuals.com>