

SWT-1

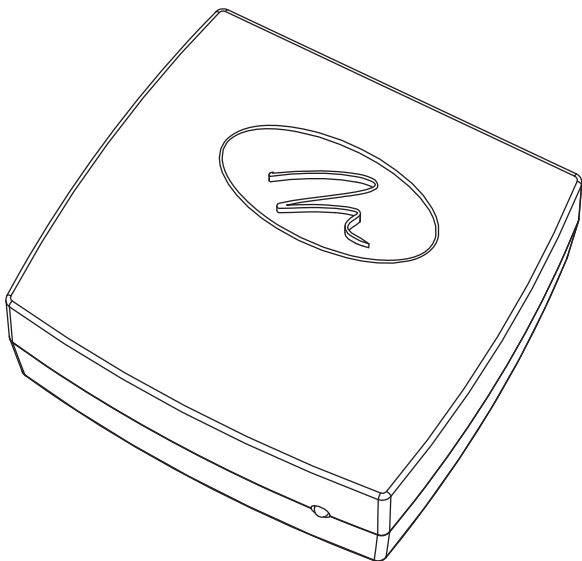

MARTIN LOGAN®

www.MartinLogan.com

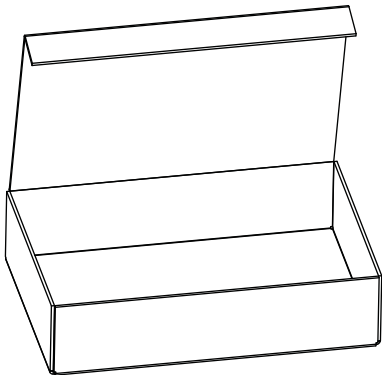
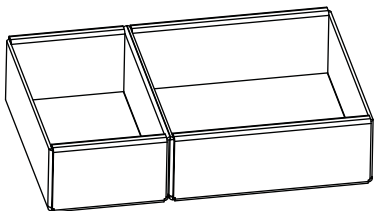
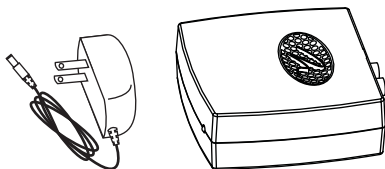
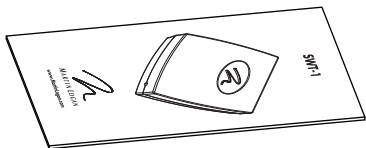

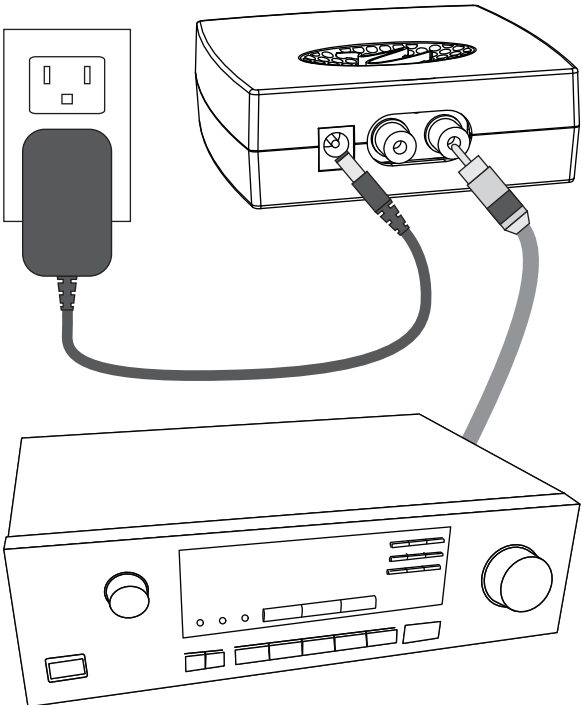
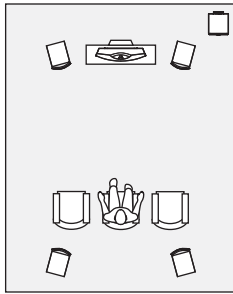

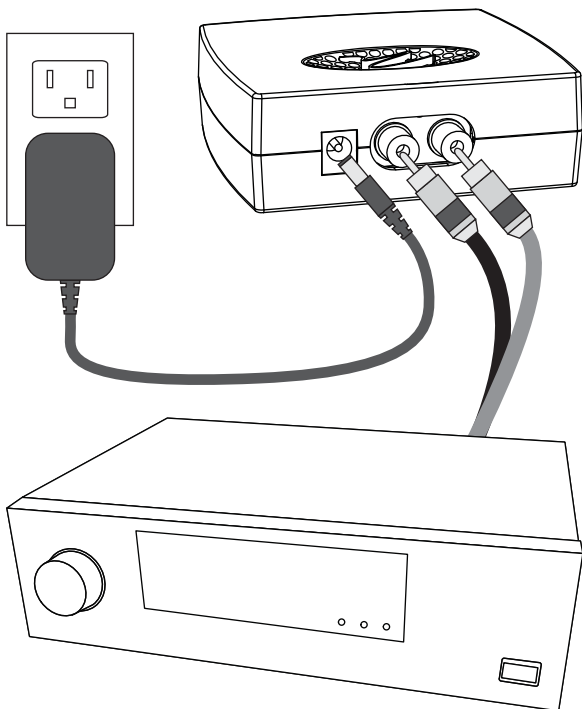
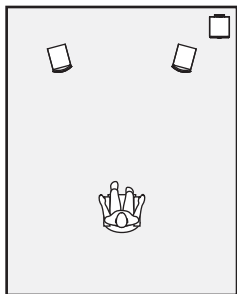

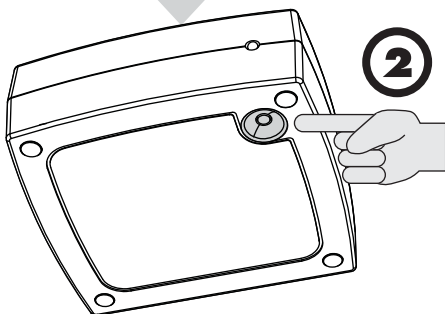
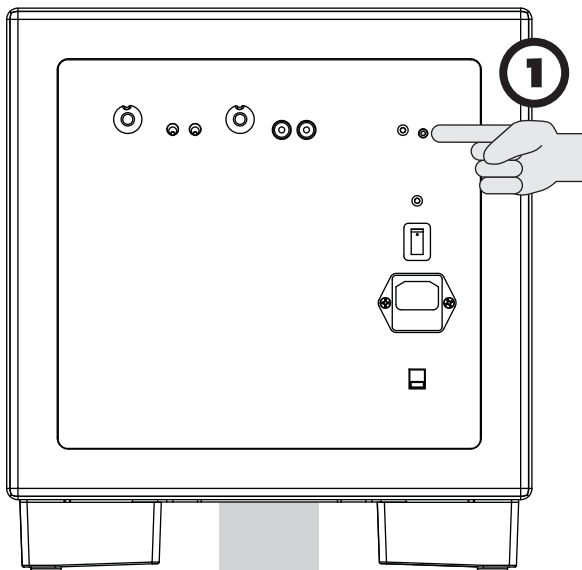

16-bit 48kHz
<30-40ft (10-12.5m)

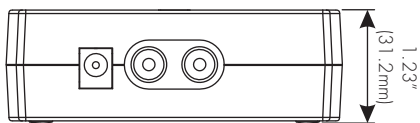
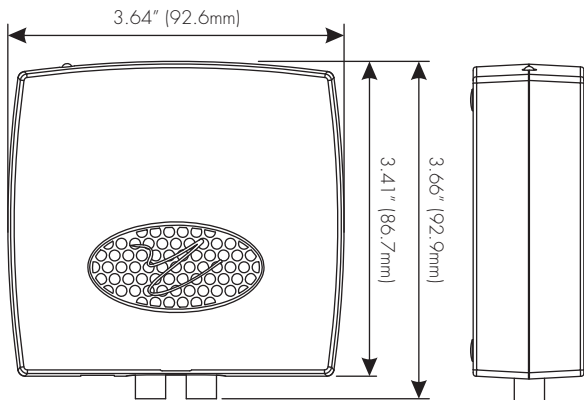
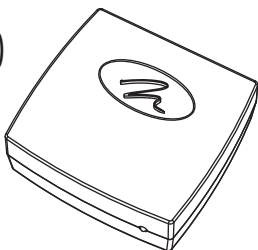



MARTIN LOGAN®

©2009 MartinLogan, Ltd. All rights reserved.

Rev. #081409

Free Manuals Download Website

<http://myh66.com>

<http://usermanuals.us>

<http://www.somanuals.com>

<http://www.4manuals.cc>

<http://www.manual-lib.com>

<http://www.404manual.com>

<http://www.luxmanual.com>

<http://aubethermostatmanual.com>

Golf course search by state

<http://golfingnear.com>

Email search by domain

<http://emailbydomain.com>

Auto manuals search

<http://auto.somanuals.com>

TV manuals search

<http://tv.somanuals.com>