

Marshall Electronics

V-R842DP-DVI

High Definition Dual Screen LCD Monitor Set

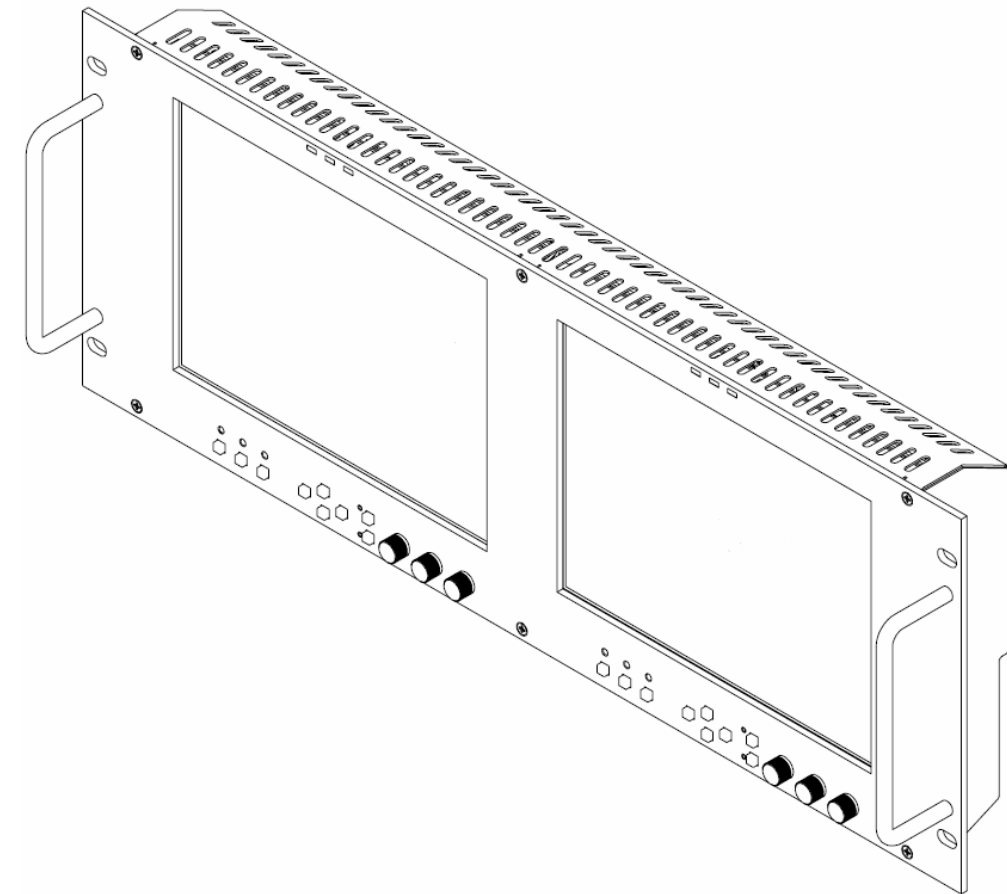

Operating Instructions

Marshall Electronics, Inc.
1910 East Maple Ave.
El Segundo, CA 90245
Tel: (800) 800-6608 / (310) 333-0606 • Fax: 310-333-0688
www.LCDRacks.com • sales@lcdracks.com

Warranty

Marshall Electronics warrants to the first consumer that this **V-R842DP-DVI** LCD monitor will, under normal use, be free from defects in workmanship and materials, when received in its original container, for a period of one year from the purchase date. This warranty is extended to the first consumer only, and proof of purchase is necessary to honor the warranty. If there is no proof of purchase provided with a warranty claim, Marshall Electronics reserves the right not to honor the warranty set forth above. Therefore, labor and parts may be charged to the consumer. This warranty does not apply to the product exterior or cosmetics. Misuse, abnormal handling, alterations or modifications in design or construction void this warranty. *It is considered normal for a minimal amount of pixels, not to exceed three, to fail on the periphery of the display active viewing area.* Marshall Electronics reserves the option to refuse service for display pixel failure if deemed unobtrusive to effective use of the monitor by our technicians. No sales personnel of the seller or any other person is authorized to make any warranties other than those described above, or to extend the duration of any warranties on behalf of Marshall Electronics, beyond the time period described above. Due to constant effort to improve products and product features, specifications may change without notice.

11/05/07

Contents

Product Overview	4
Features	4
Installation and Initial Setup	5
Unpacking	5
Installation	5
Connections and Power-On.....	5
Front Panel Features	6
Power Button	6
Input Select Buttons.....	6
On-Screen Menu Navigation Buttons	6
User-Definable Function Buttons.....	6
Image Adjustment Knobs.....	6
Tally Lights.....	6
Rear Panel Features	7
Power Input.....	7
Signal Input/Output	7
Tally Interface	7
Compatible Input Formats	8
On-Screen Menu	9
STRUCTURE OVERVIEW	9
MAIN MENU AND NAVIGATION	9
MARKER SETUP SUBMENU	10
16:9 Markers.....	10
4:3 Markers.....	11
Marker Background	11
Center Marker.....	11
VIDEO CONFIGURATION SUBMENU	12
Color Temperature Presets	12
Adjusting Color Bias	12
Adjusting Color Gain.....	12
Monochrome Mode.....	13
Blue Only Mode	13
Pixel-to-Pixel Mode.....	13
Aspect Ratio Setting.....	14
Scanning Modes.....	14
Delay Modes.....	14
SYSTEM CONFIGURATION SUBMENU.....	15
Internal SMPTE Color Bars	15
User-Definable Function Buttons	15
Status Display.....	15
Saving and Loading User Configuration Presets	15
Specifications	16
Maintenance	17
Warranty	18

The **V-R842DP-DVI** is a dual screen high definition LCD monitor set featuring our completely digital TFT-MegaPixel™ active matrix LCD platform. Utilizing 8.4-inch panels with 2.4 million pixels each, the V-R842DP-DVI provides the highest pixel density available while occupying only 4RU. Our proprietary digital signal processing features 10-bit A/D conversion of all analog signals, with 4X over-sampling and 5-line super-adaptive 2D comb filtering of composite signals. Emulation of SMPTE-C/EBU color and adjustable color temperature enable the most precise color representation possible. De-interlacing is performed using our HyperProcess algorithm with motion adaptive interpolation. Multi-format compatibility accommodates virtually all video formats including NTSC/PAL, 480i/p, 720p, and 1080i standards. VGA and DVI inputs accept VESA standards allowing the display to be used as a computer monitor. Advanced features include aspect ratio settings, a variety of screen markers, underscan mode, blue-only mode, monochrome mode, H/V delay, and Pixel-to-Pixel mode.

Features

■ High-Resolution Dual 8.4" Panels

The V-R842DP-DVI features an all-digital TFT-MegaPixel™ active matrix LCD system with 2.4 million pixels. Each LCD panel features a brightness of 400 cd/m², 400:1 contrast ratio, and a 170° all-around viewing angle making the display ideal in a variety of environments and lighting conditions.

■ Multi-Format Compatibility

With analog and digital inputs, the V-R842DP-DVI accommodates many video formats. Input types include **VGA** and **DVI** with HDCP. Accepted formats include 480i/p, 576i/p, 720p, and 1080i standards, as well as VESA PC formats through SXGA (1280 x 1024).

■ End-to-End Digital Signal Processing

Analog signals are digitized using an advanced 10-bit process with 4x over-sampling, 5-line super-adaptive 2D comb filtering, and exacting color space conversion. Video is scaled to fit on the screen in the highest possible resolution using a state-of-the-art LSI that incorporates precision gamma correction and our HyperProcess motion adaptive interpolation for interlaced images.

■ ColorMatch Conversion with Color Temperature Adjustment

Emulation of SMPTE-C/EBU color space allows the V-R842DP-DVI to replace any broadcast CRT monitor. Settings include D55, D65 and D95. Bias and Gain adjustment for each color enables precise color matching and white balance.

■ Advanced Features

Aspect ratio settings, underscan mode, blue-only mode, monochrome mode, and H/V delay are a few of the advanced features making the V-R842DP-DVI at home in any broadcast environment. Pixel-to-Pixel mode also allows native display of any incoming image format. Underscan and H/V delay are available only when monitoring standard-definition formats.

■ Flexible Screen Markers

A variety of screen markers in both 4:3 and 16:9 modes allow accurate monitoring of the different aspect ratios used in broadcast environments.

■ User-Definable Function Buttons

Two user-assignable function buttons allow quick access to numerous settings and features including aspect ratio, screen markers, monochrome mode, color temperature, delay mode, and more.

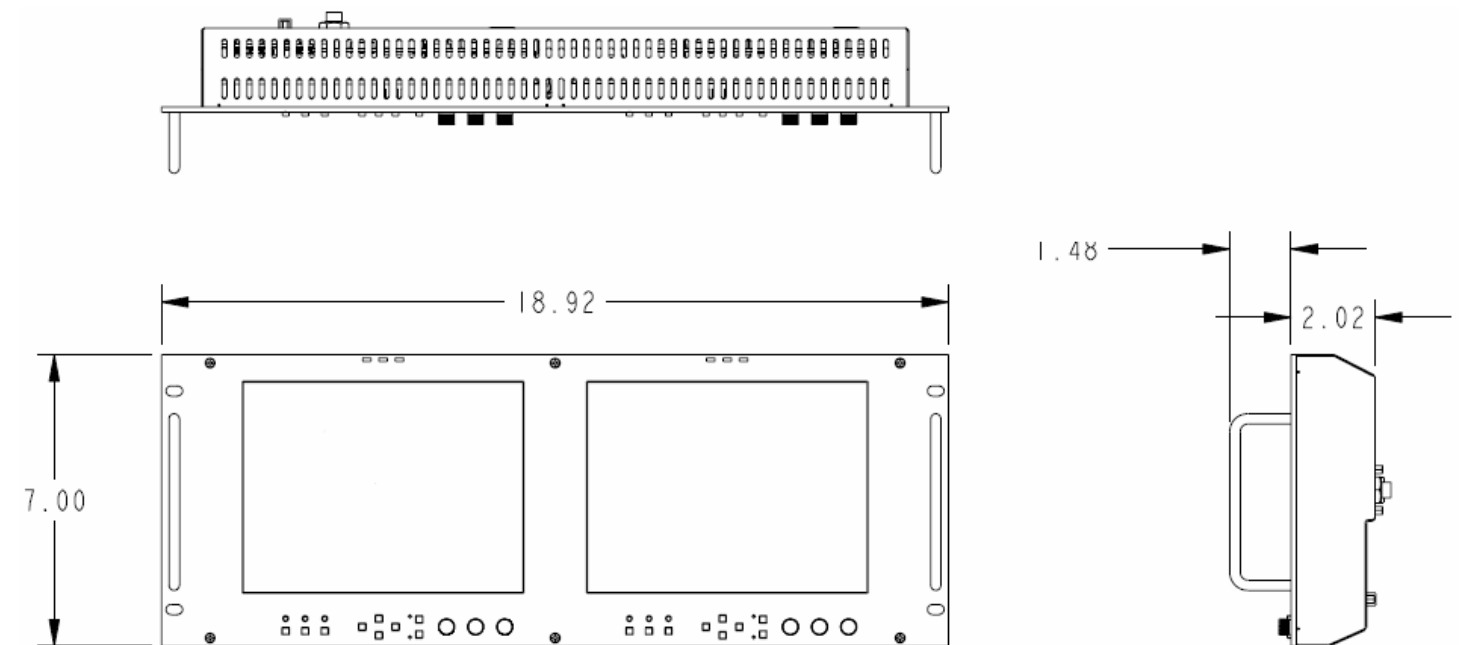

Maintenance

■ Screen Cleaning

Periodically clean the screen surface using ammonia-free cleaning wipes (Marshall Part No. **V-HWP-K**). A clean micro-fiber cloth can also be used using only non-abrasive and ammonia-free cleaning agents. Do not use paper towels. Paper towel fibers are coarse and may scratch the surface of the polycarbonate faceplate or leave streaks on the surface. Antistatic and fingerprint resistant cleaning agents are recommended. Do not apply excessive pressure to the screen to avoid damaging the LCD.

■ Faceplate Dusting

Dust the unit with a soft, damp cloth or chamois. Dry or abrasive cloths may cause electrostatic charge on the surface, attracting dust particles. Neutralize static electricity effects by using the recommended cleaning and polishing practice.

Specifications

■ PANEL

Screen Size	8.4" Diagonal
Display Area (h x v)	170.469 x 127.872 mm
Aspect Ratio	4:3 Native (4:3/16:9 Modes)
Pixels	1024 x RGB x 768
Color Depth	24-bit (16,777,216 Colors)
Viewing Angle (h x v)	170° x 170°
Brightness	400 cd/m ²
Contrast Ratio	400:1
Dot Pitch (h x v)	0.0555 x 0.1665 mm
Pixel Pitch (h x v)	0.1665 x 0.1665 mm

■ VIDEO INPUT/OUTPUT

VGA Input

Supports RGBHV, RsGsBs, RGSB, RGB CS,

DVI Input

Supports Digital Signals Only (DVI-D)
HDMI, HDCP Supported

■ CONNECTORS

Video Input

VGA	1 x HD-15 Female
DVI	1 x DVI-I 29-Pin Female

Power Input

2-Pin Twist Lock Connector

Tally Interface

HD-15 Female

■ TALLY

3 LEDs (Green, Red, Yellow). Activation requires contact closure of pin to ground on the HD-15 connector:

Pin No.	Signal
1	M1 Green
2	M1 Red
3	M1 Yellow
4	Ground
5	Ground
6	N/C
7	N/C
8	N/C
9	N/C
10	N/C
11	M2 Green
12	M2 Red
13	M2 Yellow
14	Ground
15	Ground

■ ELECTRICAL

Power Consumption	3.5A @ 12VDC (42 W)
Voltage Requirement	12 VDC

V-PS12-5V-1 Power Supply:

Input	100V-240V, 1.5A, 50-60Hz
Output	12VDC, 5A, 60W Max

■ MECHANICAL

Dimensions (w x h x d): 18.92" x 7.00" x 2.02"

Weight (Monitor Only): **6.70 lbs**

Operating Temperature 32°F to 120°F (0°C to 50°C)
Storage Temperature -4°F to 120°F (-20°C to 50°C)

Compliance €; FCC-Class A, ANSI-63.4 (Certificates on file)

RoHs Do not dispose. Return to Manufacturer or Authorized Recycle Facility.

Installation and Initial Setup

■ Unpacking

Carefully unpack the V-R842DP-DVI monitor and verify that the following items are included:

- V-R842DP-DVI Monitor
- V-PS12-5V-1 Power Supply with 2-Pin Twist Lock Connector
- Operating Instructions

Inspect the unit for any physical damage that may have occurred during shipping. Should there be any damage, immediately contact Marshall Electronics at (800) 800-6608. If you are not located within the continental United States, call +1 (310) 333-0606.

■ Installation

The V-R842DP-DVI can be mounted in any standard EIA 19" equipment rack. Adequate ventilation is required when installed to prevent possible damage to the monitor's internal components.

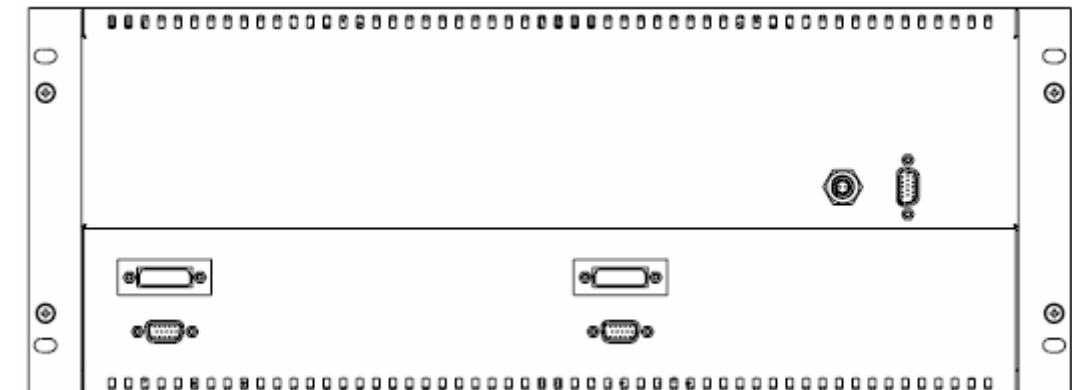

■ Connections and Power-On

Plug the V-PS12-5V-1 power supply into an AC power source (100-240 V @ 50/60 Hz). Attach the 2-pin twist lock connector to the back of the monitor. Please note that 12VDC can be also supplied directly to the monitor from a variety of sources. The monitor will draw approximately 3.5 Amps at 12 Volts in operation.

Connect the required cables for video signal input and output.

Each screen may be turned on by pressing the power button located on the front panel. Select a video input by pressing the corresponding input select button.

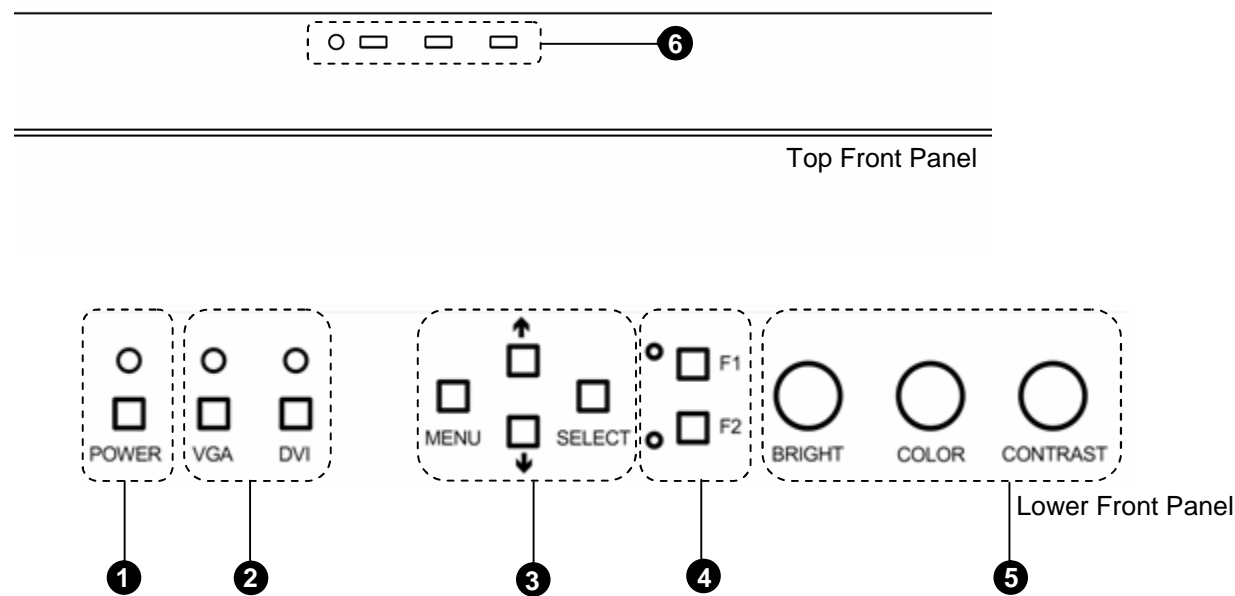

1 Power Button

Turn the monitor on by pressing the power button. In the OFF state, the LED will shine red. The LED will shine green when the monitor is turned on.

2 Input Select Buttons

Use the input select buttons to select the input to be displayed:

- VGA
- DVI

Each input automatically detects the applicable formats (See **Compatible Input Formats – Page 8**).

3 On-Screen Menu Navigation Buttons

Use the **Menu**, **↑**, **↓**, and **Select** buttons to display and navigate the on-screen menu (See **Main Menu and Navigation – Page 9**).

4 User-Definable Function Buttons

Two user-definable function buttons can be used for direct access to various settings. Functions are assigned using the on-screen menu (See **User-Definable Function Buttons – Page 15**).

5 Image Adjustment Knobs

Use the image adjustment knobs to adjust the following settings. Pressing each knob will display the current status of the corresponding control:

- Brightness (0-64)
- Color (0-64)
- Contrast (0-64)

6 Tally Lights

Three tally LEDs (green, red, and yellow) are provided as general purpose indicators. Each LED can be individually controlled, providing multiple indications. Tally LEDs are controlled via the HD-15 connector on the rear panel (See **Tally Interface – Page 7**).

SYSTEM CONFIGURATION SUBMENU



Video Configuration Submenu

Internal SMPTE Color Bars

Use to display internally generated SMPTE split-field color bars.

User-Definable Function Buttons

Use the **FUNCTION 1** and **FUNCTION 2** menu items to define each function button on the front panel of the monitor. The following options are available for each button:

- DELAY Enable and rotate amongst delay modes.
- RATIO Toggle between 4:3 and 16:9 aspect ratios.
- BACK Rotate amongst marker backgrounds.
- CENTER Enable/disable center marker.
- MARKER Enable and rotate amongst marker settings (choices depend on aspect ratio setting).
- MONO Enable/disable monochrome mode.
- CTEMP Rotate amongst color temperature settings.
- PTP Enable/disable Pixel-to-Pixel mode.

FUNCTION 1 is set to **RATIO** by default.

FUNCTION 2 is set to **PTP** by default.

Status Display

Use to enable on-screen display of input/format status in the upper-left corner of the screen.

Saving and Loading User Configuration Presets

Use the **SAVE CONFIG** and **LOAD CONFIG** menus to save current settings to one of 6 presets, or load a preset. All monitor settings on the monitor are saved, including the image adjustment knob settings.

- Use the **LOAD CONFIG** menu to load one of presets USR1 – USR6. Factory default settings can also be loaded by selecting **MFG**. (Factory defaults cannot be overwritten.)
- Use the **SAVE CONFIG** menu to save the current settings to a preset from USR1- USR6.

On-Screen Menu (continued)

VIDEO CONFIGURATION SUBMENU (continued)

■ Aspect Ratio Settings

Use to switch between 4:3 and 16:9 aspect ratios.

As the V-R842DP-DVI monitor has a native resolution of 1024 x 768 RGB pixels, incoming images are automatically scaled to fit the screen:

- In 4:3 mode, images are scaled up or down to fill the entire 4:3 screen (1024 x 768).
- In 16:9 mode, images are scaled to fill the maximum 16:9 portion of the screen (1024 x 576), with black bars filling the remainder of the screen.

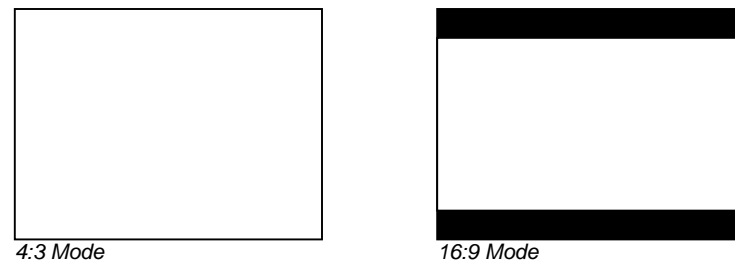

Note: The aspect ratio setting is ignored when Pixel-to-Pixel mode is enabled.

■ Scanning Modes

Use this setting to switch between normal and underscan modes:

- In normal scan mode, the active portion of the video signal is displayed on the screen, with 0% overscan.
- In underscan mode, area around the active video area is displayed on the screen, resulting in blanking intervals being shown around the perimeter of the active image. Use this mode to clearly view the edges of the active video area.

■ Delay Modes

Use this setting to enable one of three delay modes (H/V, H, V):

- In H/V delay mode, both horizontal sync and vertical sync are delayed, resulting in both horizontal and vertical blanking periods being shown on the screen.
- In V delay mode, vertical sync is delayed so that the vertical blanking period is displayed on screen.
- In H delay mode, horizontal sync is delayed so that the horizontal blanking period is displayed on the screen.

Note: Delay modes are only available in normal scan mode.

Rear Panel Features

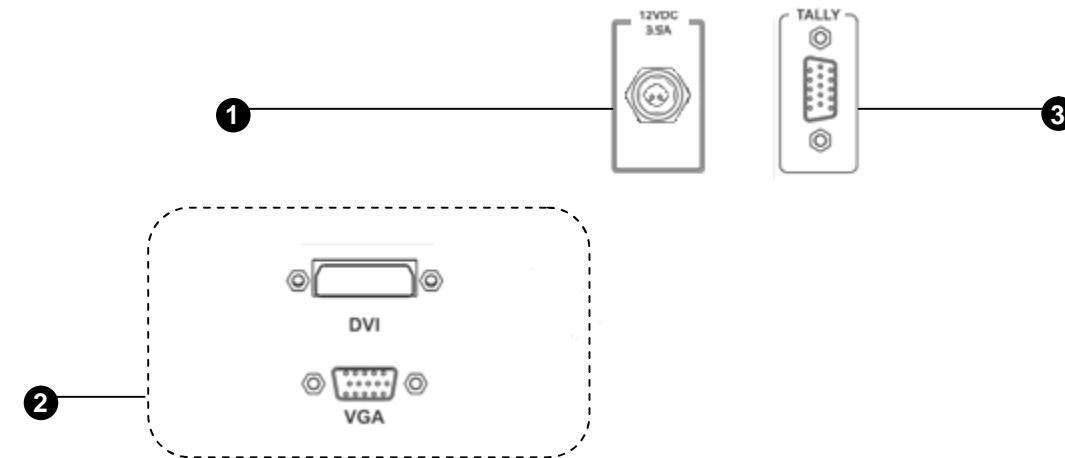

① Power Input

Connect the 12VDC input to the 2-Pin twist lock power input connector. Power can be supplied from the included power supply, or from a variety of DC sources supplying at least 3.5 Amps at 12 Volts.

IMPORTANT: If using a power source other than the included power supply, be sure that the polarity of the DC input is correct:

② Signal Input/Output

Connections:

- VGA (HD-15)
- DVI (29-Pin connector, DVI-D signals only)

③ Tally Interface

Each tally light is activated via the HD-15 connector by connecting the corresponding pin to ground. A variety of external devices can be used to perform the contact closure. No additional power should be supplied to the HD-15 port.

Tally Interface: HD-15 Pinout

Pin No.	Signal
1	M1 Green
2	M1 Red
3	M1 Yellow
4	Ground
5	Ground
6	N/C
7	N/C
8	N/C
9	N/C
10	N/C
11	M2 Green
12	M2 Red
13	M2 Yellow
14	Ground
15	Ground

VIDEO CONFIGURATION SUBMENU (continued)

■ Monochrome Mode

Use this setting to enable monochrome mode. Only the luminance of the image will be displayed as a grayscale picture.

■ Blue-Only Mode

Use this setting to enable Blue-Only mode. This mode displays only the blue color component of the image, switching off the red and green components. Use this mode when calibrating the monitor to SMPTE color bars with the following procedure:

1. Allow the monitor to warm up for at least 5-10 minutes.
2. Display SMPTE split-field color bars on the monitor using the internal generator or an external source.
3. Enable **Monochrome mode**.
4. Locate the pluge pattern (super black, black, and gray bars) at the lower-right corner of the screen. Adjust the **Brightness** knob until there is no visible difference between the super black and black bars, but the gray bar is still visible.
5. Adjust the **Contrast** knob until an even grayscale appears along the top bars.
6. Disable **Monochrome mode**.
7. Enable **Blue-Only mode** and adjust the **Color** knob so that the outermost bars (white and blue) appear to match in brightness.
8. Disable **Blue-Only mode**.

■ Pixel-to-Pixel Mode

Use this setting to enable Pixel-to-Pixel mode.

This mode bypasses the monitor's internal scaling function and displays incoming images in their native resolution and aspect ratio, with a one-to-one mapping:

- For incoming formats smaller than the native resolution of the LCD panel (1024 x 768), the image will be displayed in the center of the screen using only the necessary LCD pixels.
- For incoming formats exceeding 1024 x 768 pixels, only the center 1024 x 768 of the incoming image will be displayed occupying the whole screen, with the remainder of the picture cropped. For example, 1080i formats will both be cropped to 1024 x 768 and displayed full-screen.

Note: Pixel-to-Pixel mode will utilize the entire screen (1024 x 768) regardless of the aspect ratio setting.

Format	Composite	S-Video	YPbPr	SDI	VGA	DVI-D
NTSC						
PAL						
525i					•	
625i					•	
486p / 59.94						•
576p / 50						•
1035i / 60						
1035i / 59.94						
1080i / 60					•	•
1080i / 59.95					•	•
1080i / 50					•	•
1080psF / 24					•	•
1080psF / 23.98					•	•
1080p / 30						
1080p / 29.97						
1080p / 25						
720p / 60					•	•
720p / 59.94					•	•
720p / 50					•	•
720p / 30						
720p / 29.97						
720p / 25						
640 x 480 @ 60Hz					•	•
640 x 480 @ 75Hz					•	•
640 x 480 @ 85Hz					•	•
800 x 600 @ 60Hz					•	•
800 x 600 @ 75Hz					•	•
800 x 600 @ 85Hz					•	•
1024 x 768 @ 60Hz					•	•
1024 x 768 @ 75Hz					•	•
1024 x 768 @ 85Hz					•	•
1280 x 1024 @ 60Hz					•	•

VIDEO CONFIGURATION SUBMENU



Video Configuration Submenu

Color Temperature Presets

Use this setting to choose one of three color temperature presets:

- D55 (5500K)
- D65 (6500K)
- D93 (9300K)
- USER (Adjustable Color Bias and Gain)

Adjusting Color Bias



Color Bias Menu

Use this submenu to adjust bias of the color response. Adjust the bias for each color to alter the white balance of the image. The Color Temperature preset will automatically switch to USER when Color Bias settings are adjusted. It is normal for color bias adjustments to be very subtle.

Adjusting Color Gain



Color Gain Menu

Use this submenu to adjust gain of the color response. The Color Temperature preset will automatically switch to USER when Color Gain settings are adjusted.

STRUCTURE OVERVIEW

MAIN	MARKER SETUP	MARKER 16:9	OFF, 13:9, 14:9, 4:3, 2.35:1, 1.85:1, 95%, 93%, 90%, 88%, 80%
		MARKER 4:3	OFF, 95%, 93%, 90%, 88%, 80%
		MARKER BACKGROUND	OFF, HALF, BLACK
		CENTER MARKER	OFF, ON
	VIDEO CONFIG	COLOR TEMP	D55, D65, D93, USER
		ADJ COLOR BIAS	RED (0-100)
			GREEN (0-100)
			BLUE (0-100)
		ADJ COLOR GAIN	RED (0-100)
			GREEN (0-100)
			BLUE (0-100)
		MONO	OFF, ON
	BLUE ONLY	OFF, ON	
	PIXEL TO PIXEL	OFF, ON	
	ASPECT RATIO	4:3, 16:9	
	SCAN	NORMAL, UNDER	
	DELAY	OFF, H/V, V, H	
	SYSTEM CONFIG	SMPTE BAR	OFF, ON
FUNCTION 1		DELAY, RATIO, BACK, CENTER, MARKER, MONO, CTEMP, PTP	
FUNCTION 2		DELAY, RATIO, BACK, CENTER, MARKER, MONO, CTEMP, PTP	
STATUS DISPLAY		OFF, ON	
LOAD CONFIG		USR1, USR2, USR3, USR4, USR5, USR6, MFG	
SAVE CONFIG	USR1, USR2, USR3, USR4, USR5, USR6		

MAIN MENU AND NAVIGATION

Access the main menu by pushing and holding the **MENU** button on the front panel of the monitor.



Main Menu

- Step through menu items using the ↑ and ↓ buttons.
- Choose a menu item by pressing **SELECT**.
- Rotate through options using the ↑ and ↓ buttons.
- Choose a setting by pressing **SELECT**.
- Return to the previous menu by pressing **MENU**.
- Exit the main menu by pressing **MENU**. The menu will automatically time out after 8 seconds. After exiting the menu, wait 1-2 seconds before displaying the menu again.

MARKER SETUP SUBMENU



16:9 Markers

Use this setting to superimpose one of 10 markers on the screen when in 16:9 mode. This setting is disabled when the aspect ratio is set to 4:3, or when Pixel-to-Pixel, Underscan, or H/V Delay is enabled.

- OFF (No Marker)
- 13:9 Aspect Ratio
- 14:9 Aspect Ratio
- 4:3 Aspect Ratio
- 2.35:1 Aspect Ratio
- 1.85:1 Aspect Ratio
- 95% Safe Area
- 93% Safe Area
- 90% Safe Area
- 88% Safe Area
- 80% Safe Area

16:9 Marker Examples:



OFF (No Marker)



90% Safe Area



2.35:1 Aspect Ratio



4:3 Aspect Ratio Marker

MARKER SETUP SUBMENU (continued)

4:3 Markers

Use this setting to superimpose one of 5 markers on the screen when in 4:3 mode. This setting is disabled when the aspect ratio is set to 16:9, or when Pixel-to-Pixel, Underscan, or H/V Delay is enabled.

- OFF (No Marker)
- 95% Safe Area
- 93% Safe Area
- 90% Safe Area
- 88% Safe Area
- 80% Safe Area

4:3 Marker Examples:

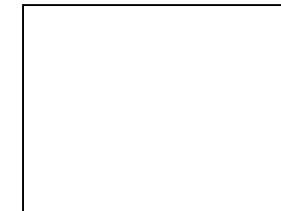

OFF (No Marker)

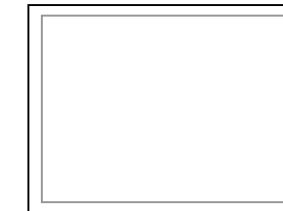

90% Safe Area

Marker Background

Use this setting to choose how selected markers are displayed on the screen:

- OFF The marker is superimposed on the complete image.
- Half-tone Image area beyond the marker is shown at 50% intensity.
- Black Image area beyond the marker is shown at 0% intensity (black).

Example (80% Marker in 4:3 Mode):



Background OFF

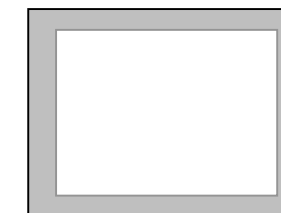

Half-tone Background



Black Background

Center Marker

Use this setting to display a center marker on the screen. This feature is not available when H/V delay is on.

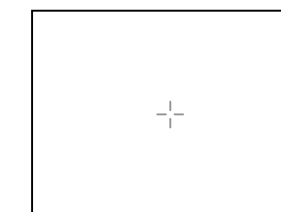

Center Marker

Free Manuals Download Website

<http://myh66.com>

<http://usermanuals.us>

<http://www.somanuals.com>

<http://www.4manuals.cc>

<http://www.manual-lib.com>

<http://www.404manual.com>

<http://www.luxmanual.com>

<http://aubethermostatmanual.com>

Golf course search by state

<http://golfingnear.com>

Email search by domain

<http://emailbydomain.com>

Auto manuals search

<http://auto.somanuals.com>

TV manuals search

<http://tv.somanuals.com>