

marantz®

Model BD8002 User Guide

Blu-ray / DVD Player



Introduction

Safety Precautions



CAUTION
RISK OF ELECTRIC SHOCK
DO NOT OPEN



CAUTION:
TO REDUCE THE RISK OF ELECTRIC SHOCK, DO NOT REMOVE COVER (OR BACK). NO USER-SERVICEABLE PARTS INSIDE. REFER SERVICING TO QUALIFIED SERVICE PERSONNEL.



The lightning flash with arrowhead symbol, within an equilateral triangle, is intended to alert the user to the presence of uninsulated "dangerous voltage" within the product's enclosure that may be of sufficient magnitude to constitute a risk of electric shock to persons.



The exclamation point within an equilateral triangle is intended to alert the user to the presence of important operating and maintenance (servicing) instructions in the literature accompanying the appliance.

WARNING:
TO REDUCE THE RISK OF FIRE OR ELECTRIC SHOCK, DO NOT EXPOSE THIS APPLIANCE TO RAIN OR MOISTURE.

Laser Safety

CAUTION:
VISIBLE AND INVISIBLE LASER RADIATION WHEN OPEN.
DO NOT STARE INTO BEAM.

LOCATION: INSIDE, NEAR THE DECK MECHANISM.

CAUTION:
USE OF CONTROLS OR ADJUSTMENTS OR PERFORMANCE OF PROCEDURES OTHER THAN THOSE SPECIFIED HEREIN MAY RESULT IN HAZARDOUS RADIATION EXPOSURE.
THIS PRODUCT SHOULD NOT BE ADJUSTED OR REPAIRED BY ANYONE EXCEPT PROPERLY QUALIFIED SERVICE PERSONNEL.

SAFETY INSTRUCTIONS

1. Read Instructions - All the safety and operating instructions should be read before the product is operated.
2. Retain Instructions - The safety and operating instructions should be retained for future reference.
3. Heed Warnings - All warnings on the product and in the operating instructions should be adhered to.
4. Follow Instructions - All operating and use instructions should be followed.
5. Cleaning - Unplug this product from the wall outlet before cleaning. Do not use liquid cleaners or aerosol cleaners.
6. Attachments - Do not use attachments not recommended by the product manufacturer as they may cause hazards.
7. Water and Moisture - Do not use this product near water - for example, near a bath tub, wash bowl, kitchen sink, or laundry tub; in a wet basement; or near a swimming pool; and the like.
8. Accessories - Do not place this product on an unstable cart, stand, tripod, bracket, or table. The product may fall, causing serious injury to a child or adult, and serious damage to the product. Use only with a cart, stand, tripod, bracket, or table recommended by the manufacturer, or sold with the product. Any mounting of the product should follow the manufacturer's instructions, and should use a mounting accessory recommended by the manufacturer.
9. A product and cart combination should be moved with care. Quick stops, excessive force, and uneven surfaces may cause the product and cart combination to overturn.
10. Ventilation - Slots and openings in the cabinet are provided for ventilation and to ensure reliable operation of the product and to protect it from overheating, and these openings must not be blocked or covered. The openings should never be blocked by placing the product on a bed, sofa, rug, or other similar surface. This product should not be placed in a built-in installation such as a bookcase or rack unless proper ventilation is provided or the manufacturer's instructions have been adhered to.
11. Power Sources - This product should be operated only from the type of power source indicated on the marking label. If you are not sure of the type of power supply to your home, consult your product dealer or local power company. For products intended to operate from battery power, or other sources, refer to the operating instructions.
12. Grounding or Polarization - This product may be equipped with a polarized alternating-current line plug (a plug having one blade wider than the other). This plug will fit into the power outlet only one way. This is a safety feature. If you are unable to insert the plug fully into the outlet, try reversing the plug. If the plug should still fail to fit, contact your electrician to replace your obsolete outlet. Do not defeat the safety purpose of the polarized plug.



13. Power-Cord Protection - Power-supply cords should be routed so that they are not likely to be walked on or pinched by items placed upon or against them, paying particular attention to cords at plugs, convenience receptacles, and the point where they exit from the product.
14. Outdoor Antenna Grounding - If an outside antenna or cable system is connected to the product, be sure the antenna or cable system is grounded so as to provide some protection against voltage surges and built-up static charges. Article 810 of the National Electrical Code, ANSI/NFPA 70, provides information with regard to proper grounding of the mast and supporting structure, grounding of the lead-in wire to an antenna discharge unit, size of grounding conductors, location of antenna-discharge unit, connection to grounding electrodes, and requirements for the grounding electrode. See Figure A.
15. Lightning - For added protection for this product during a lightning storm, or when it is left unattended and unused for long periods of time, unplug it from the wall outlet. This will prevent damage to the product due to lightning and power-line surges.
16. Power lines - An outside antenna system should not be located in the vicinity of overhead power lines or other electric light or power circuits, or where it can fall into such power lines or circuits. When installing an outside antenna system, extreme care should be taken to keep from touching such power lines or circuits as contact with them might be fatal.
17. Overloading - Do not overload wall outlets, extension cords, or integral convenience receptacles as this can result in a risk of fire or electric shock.
18. Object and Liquid Entry - Never push objects of any kind into this product through openings as they may touch dangerous voltage points or short-out parts that could result in a fire or electric shock. Never spill liquid of any kind on the product.
19. Servicing - Do not attempt to service this product yourself as opening or removing covers may expose you to dangerous voltage or other hazards. Refer all servicing to qualified service personnel.
20. Damage Requiring Service - Unplug this product from the wall outlet and refer servicing to qualified service personnel under the following conditions:
 - a) When the power-supply cord or plug is damaged.
 - b) If liquid has been spilled, or objects have fallen into the product.
 - c) If the product has been exposed to rain or water.
 - d) If the product does not operate normally by following the operating instructions. Adjust only those controls that are covered by the operating instructions as an improper adjustment of other controls may result in damage and will often require extensive work by a qualified technician to restore the product to its normal operation.
 - e) If the product has been dropped or damaged in any way.
 - f) When the product exhibits a distinct change in performance - this indicates a need for service.
21. Replacement Parts - When replacement parts are required, be sure the service technician has used replacement parts specified by the manufacturer or have the same characteristics as the original part. Unauthorized substitutions may result in fire, electric shock, or other hazards.
22. Safety Check - Upon completion of any service or repairs to this product, ask the service technician to perform safety checks to determine that the product is in proper operating condition.
23. Wall or Ceiling Mounting - The product should be mounted to a wall or ceiling only as recommended by the manufacturer.
24. Heat - The product should be situated away from heat sources such as radiators, heat registers, stoves, or other products (including amplifiers) that produce heat.

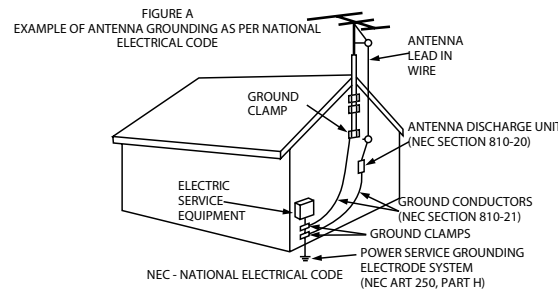

FCC INFORMATION (For US customers)

1. PRODUCT

This product complies with Part 15 of the FCC Rules. Operation is subject to the following two conditions: (1) this product may not cause harmful interference, and (2) this product must accept any interference received, including interference that may cause undesired operation.

2. IMPORTANT NOTICE: DO NOT MODIFY THIS PRODUCT

This product, when installed as indicated in the instructions contained in this manual, meets FCC requirements. Modification not expressly approved by Marantz may void your authority, granted by the FCC, to use the product.

3. NOTE

This product has been tested and found to comply with the limits for a Class B digital device, pursuant to Part 15 of the FCC Rules. These limits are designed to provide reasonable protection against harmful interference in a residential installation.

This product generates, uses and can radiate radio frequency energy and, if not installed and used in accordance with the instructions, may cause harmful interference to radio communications. However, there is no guarantee that interference will not occur in a particular installation. If this product does cause harmful interference to radio or television reception, which can be determined by turning the product OFF and ON, the user is encouraged to try to correct the interference by one or more of the following measures:

- Reorient or relocate the receiving antenna.
- Increase the separation between the equipment and receiver.
- Connect the product into an outlet on a circuit different from that to which the receiver is connected.
- Consult the local retailer authorized to distribute this type of product or an experienced radio/TV technician for help.

This Class B digital apparatus complies with Canadian ICES-003. Cet appareil numérique de la classe B est conforme à la norme NMB-003 du Canada.

CAUTION:

TO PREVENT ELECTRIC SHOCK, MATCH WIDE BLADE OF PLUG TO WIDE SLOT, FULLY INSERT.





ATTENTION:

POUR ÉVITER LES CHOC ÉLECTRIQUES, INTRODUIRE LA LAME LA PLUS LARGE DE LA FICHE DANS LA BORNE CORRESPONDANTE DE LA PRISE ET POUSSER JUSQU'AU FOND.

■ Copyrights / Droits d'auteur / Derechos de Autor

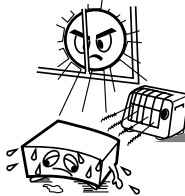
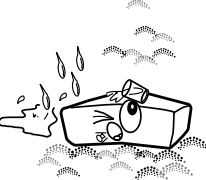
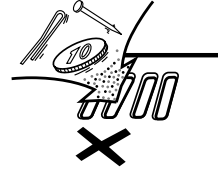
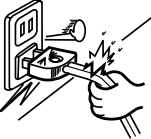
- It is prohibited by law to reproduce, broadcast, rent or play discs in public without the consent of the copyright holder.
- La reproduction, la diffusion, la location, le prêt ou la lecture publique de ces disques sont interdits sans le consentement du détenteur des droits d'auteur.
- De acuerdo con las leyes está prohibido reproducir, emitir, alquilar o interpretar discos en público sin la autorización del propietario de los derechos de autor.

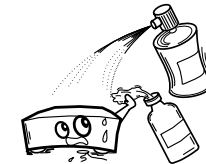
■ Note on use / Observations relatives a l'utilisation / Notas sobre el uso

 <ul style="list-style-type: none"> • Avoid high temperatures. Allow for sufficient heat dispersion when installed in a rack. • Eviter des températures élevées. Tenir compte d'une dispersion de chaleur suffisante lors de l'installation sur une étagère. • Evite altas temperaturas. Permite la suficiente dispersión del calor cuando está instalado en la consola. 	 <ul style="list-style-type: none"> • Keep the apparatus free from moisture, water, and dust. • Protéger l'appareil contre l'humidité, l'eau et la poussière. • Mantenga el equipo libre de humedad, agua y polvo. 	 <ul style="list-style-type: none"> • Do not let foreign objects into the apparatus. • Ne pas laisser des objets étrangers dans l'appareil. • No deje objetos extraños dentro del equipo.
 <ul style="list-style-type: none"> • Handle the power cord carefully. Hold the plug when unplugging the cord. • Manipuler le cordon d'alimentation avec précaution. Tenir la prise lors du débranchement du cordon. • Maneje el cordón de energía con cuidado. Sostenga el enchufe cuando desconecte el cordón de energía. 	 <ul style="list-style-type: none"> • Unplug the power cord when not using the apparatus for long periods of time. • Débrancher le cordon d'alimentation lorsque l'appareil n'est pas utilisé pendant de longues périodes. • Desconecte el cordón de energía cuando no utilice el equipo por mucho tiempo. 	 <ul style="list-style-type: none"> • Do not let insecticides, benzene, and thinner come in contact with the apparatus. • Ne pas mettre en contact des insecticides, du benzène et un diluant avec l'appareil. • No permita el contacto de insecticidas, gasolina y diluyentes con el equipo.
<ul style="list-style-type: none"> • Do not obstruct the ventilation holes. • Ne pas obstruer les trous d'aération. • No obstruya los orificios de ventilación. 	 <p>*(For apparatuses with ventilation holes)</p>	 <ul style="list-style-type: none"> • Never disassemble or modify the apparatus in any way. • Ne jamais démonter ou modifier l'appareil d'une manière ou d'une autre. • Nunca desarme o modifique el equipo de ninguna manera.

Contents

Introduction

Features	1
Important	2
Power Supply	2
Warning	2
Installation Location	2
Cautions on Installation	2
Caution on Handling	3
Dew Warning	3
Avoid the Hazards of Electrical Shock and Fire	3
Before Using	3
About Copyright	3
Supplied Accessories	3
Trademark Information	3
About Discs	4
Disc Handling	4
Cleaning Discs	4
Playable Discs and Files	4
Unplayable Discs	5
Color Systems	5
Region Codes	5
Structure of Disc/SD Memory Card Contents	5
Symbols Used in this Operating Instructions	5
About the Remote Control	6
Loading the Batteries	6
Using a Remote Control	6
Changing the Signal Code of a Remote Control	6
Part Names and Functions	7
Front Panel	7
Rear Panel	7
Remote Control	8
Front Panel Display	9
Adjusting the Brightness of the Display	9
Examples of Displays during Operation	9

Connections

Connecting to a TV	10
Connecting to a Display Device with HDMI Cable	10
Connecting to a Display Device and an Amplifier/ Receiver with HDMI Cable	10
HDMI Output Mode and Actual Output Signals	11
Audio Setting	11
Digital Connection to an AV Amplifier with Built-in Decoder	12
Connection to a Device with 2-channels of Analog Audio Inputs	13

Surround Connections to a Device with 7.1/5.1-channels of Analog Audio Inputs	13
Connecting the AC cord	13

Playback

Turning the Power On	14
Direct Playback	14
Operations Using Disc Menu, Title Menu, and Popup Menu	15
Playing Back a BDAV mode BD-RE/-R and a VR mode DVD-RW/-R	15
Pause	15
Resume Playback	16
Fast Forward / Fast Reverse Playback	16
Slow Forward Playback	16
Step by Step Playback	16
Dialog Speed	17
Repeat Playback	17
A-B Repeat	17
Program Playback	18
Random Playback	18
Zoom	19
Camera Angle	19
Search	19
On-Screen Display	20
Selecting the Format of Audio and Video	22
Selecting Audio Streams/Channels	22
Selecting Subtitle Language	22
Virtual Surround	23
Pure Direct Mode	23
Setting the BD Audio Mode	23
Adjusting the Picture	24
Playing Back an MP3, Windows Media™ Audio, JPEG and DivX® File	25
Kodak Picture CD	27
Reading the SD Memory Card	27

Function Setup

Using the Setup Menu	29
Quick	29
Custom	29
Initialize	37

Others

Troubleshooting	38
Language Code	39
Specifications	40

Features

- **HDMI (High-Definition Multimedia Interface)**
You can enjoy clearer video output when connecting this unit to a display device with an HDMI-compatible port.
- **Dialog Speed**
Playback in slightly faster speed while keeping the sound output.
Dialog speed is available only on discs recorded in the Dolby Digital format.
- **Still/Fast/Slow/Step Playback**
Various playback modes are available including still pictures, fast forward/reverse, slow motion and step frames.
- **Still Mode**
The resolution of pictures while in the still (pause) mode can be adjusted.
- **Random Playback for audio CD, MP3, JPEG, and Windows Media™ Audio**
This unit can shuffle the playback order of tracks/files.
- **Program Playback for audio CD, MP3, JPEG, and Windows Media™ Audio**
You can program the playback order of tracks/files in a desired order.
- **BD/DVD Menus in a Desired Language**
You can display BD/DVD menus in a desired language, if available on a BD/DVD.
- **Auto Power Off**
The power turns off automatically if there is no activity at the unit or its remote control for more than 30 minutes (refer to page 37).
- **Subtitles in a Desired Language**
You can select a desired language for subtitles if that language is available on the BD/DVD and DivX®.
- **Selecting a Camera Angle**
You can select a desired camera angle if a disc contains sequences recorded from different angles.
- **Choices for Audio Language and Sound Mode**
You can select a desired audio language and sound mode if different languages and modes are available on a disc.
- **Ratings Control (Parental Lock)**
You can set the control level to limit playback of discs which may not be suitable for children.
- **Automatic Detection of Discs**
This unit automatically detects if a loaded disc is BD, DVD, audio CD, MP3, JPEG, Windows Media™ Audio or DivX®.
- **Pure Direct**
The sound quality of analog audio output is improved by stop output of video signals, etc.

Introduction

●On-Screen Display

Information about the current operation can be displayed on a screen, allowing you to confirm the currently active functions (such as program playback) using the remote control.

●Dimmer

The brightness of the front panel display can be adjusted.

●Screen Saver

The screen saver program starts if there is no activity at the unit or its remote for more than 5 minutes. The brightness of the display is darkened by 75%. The program is deactivated when there is any activity.

●Picture Control

Picture control adjusts black level and noise reduction of the specific display.

●Search

Chapter search: Search for a desired chapter.

Title search: Search for a desired title.

Track search: Search for a desired track/file.

Time search: Search for a desired time point or a title or a track/file.

●Repeat

Chapter: Repeated playback of a chapter of the disc.

Title: Repeated playback of a title of the disc.

Track: Repeated playback of a track/file of the disc.

All: Repeated playback of the entire disc.
(not available for BD, DVD-video)

A-B: Repeated playback of a part between two points.
Group: Repeated playback of a folder of the MP3/JPEG/
Windows Media™ Audio/DivX® disc being played
back is possible.

●Zoom

x1.2, x1.5, x2.0, x4.0 magnified image can be displayed. (not available for BD)

●Marker

Electric reference points designated by user can be called back.

●Resume Playback

User can resume playback from the point at which the playback has been stopped even if the power is turned off.

●Bit Rate Indication

The bit rate (the amount of video data currently being read) can be displayed during the playback of video contents. (not available for BD)

●DRC (Dynamic Range Control)

Use this procedure to set the dynamic range of the output signals when playing back DVD/BD recorded in Dolby Digital/ Dolby Digital Plus/Dolby TrueHD.

●Displaying a JPEG picture

Kodak Picture CD can be played back. Still images stored in JPEG format on DVD-RW/-R, CD-RW/-R or SD Memory Card can also be played back.

●Playing Back Windows Media™ Audio File

You can enjoy Windows Media™ Audio files which are recorded on DVD-RW/-R, CD-RW/-R or SD Memory Card.

●Playing Back an MP3 File

You can enjoy MP3 files which are recorded on DVD-RW/-R, CD-RW/-R or SD Memory Card.

●Playing Back DivX® File

You can enjoy DivX® files which are recorded on DVD-RW/-R or CD-RW/-R.

- Official DivX® Certified product

- Plays all versions of DivX® video (including DivX® 6) with standard playback of DivX® media files.

●Playing Back the Contents in SD Memory Card

- You can playback MP3, Windows Media™ Audio, or JPEG stored in an SD Memory Card.

- You can store picture-in-picture commentary, subtitles or other extras for BD-ROM Profile 1.1 files in an SD Memory Card and playback with the BD-ROM.

●BD-J Application

- With some BD that supports Java applications (BD-J), you can enjoy interactive function (e.g., game).

●Analog 7.1ch Surround Output

This player is equipped with analog 7.1-channel surround audio out jacks for playback.

Important

Use only discs marked with logos listed on page 4.

Power Supply

The main power supply is engaged when the main plug is plugged in a 120V, 60Hz AC outlet. To operate the unit, press <ON / OFF> to turn on the unit.

Introduction

Warning

To avoid fire or electric shock, do not expose this unit to rain or moisture.

WARNING:
LIVE PARTS INSIDE.
DO NOT REMOVE ANY SCREWS.

Installation Location

For safety and optimum performance of this unit:

- Do not stand the unit up vertically. Install the unit in a horizontal and stable position. Do not place anything directly on top of the unit. Do not place the unit directly on top of the TV.
- Shield it from direct sunlight and keep it away from sources of intense heat. Avoid dusty or humid places. Avoid places with insufficient ventilation for proper heat dissipation. Do not block the ventilation holes on the sides of the unit. Avoid locations subject to strong vibration or strong magnetic fields.
- Be sure to remove a disc and unplug the AC cord from the outlet before carrying the unit.

Non-use periods - Turn off the unit when it is not in use. Unplug the unit from the household AC outlet if it is not to be used for a long time. Unplug the unit during lightning storms.

Please read this operating instructions carefully before using the unit, and keep it for future reference.

Cautions on Installation

Noise or disturbance of the picture may be generated if this unit or any other electronic equipment using microprocessors is used near a tuner or TV.

If this happens, take the following steps:

- Install this unit as far as possible from the tuner or TV.
- Set the antenna wires from the tuner or TV away from this unit's AC cord and input/output connection cords.
- Noise or disturbance tends to occur particularly when using indoor antennas or 300Ω/ohms feeder wires. We recommend using outdoor antennas and 75Ω/ohms coaxial cables.

Note

- For heat dispersal, do not install this equipment in a confined space such as a book case or similar unit.

Introduction

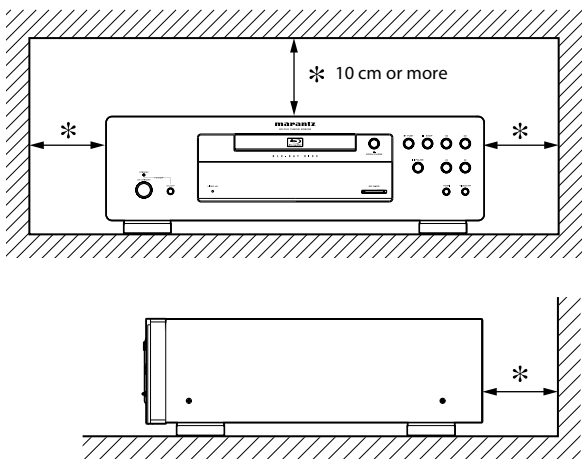

Caution on Handling

●Cautions on using mobile phones.

Using a mobile phone near this unit may result in noise. If so, move the mobile phone away from this unit when it is in use.

●Before turning the power operation button on.

Check once again that all connections are correct and that there are not problems with the connection cables. Always set the power operation button to the standby position before connecting and disconnecting connection cables.

●Sufficiently ventilate the place of installation.

If the unit is left in a room full of the smoke from cigarettes, etc., for long periods of time, the surface of the optical pickup could get dirty, in which case it will not be able to read the signals properly.

Dew Warning

Moisture condensation may occur inside the unit when it is moved from a cold place to a warm place, or after heating a cold room or under conditions of high humidity. Do not use the unit at least for 2 hours until its inside is dry.

Avoid the Hazards of Electrical Shock and Fire

- Do not handle the AC cord with wet hands.
- Do not pull on the AC cord when disconnecting it from AC wall outlet. Grasp it by the plug.
- If, by accident, water is spilled on this unit, unplug the AC cord immediately and take the unit to our authorized service center for servicing.

Before Using

Pay attention to the following before using this unit:

●Moving the unit.

To prevent short-circuits or damaged wires in the connection cables, always unplug the power supply cord and disconnect the connection cables between all other audio components when moving the unit.

●Store the operating instructions in a safe place.

After reading the operating instructions, store them in a safe place as they could come in handy in the future.

●Whenever <ON/STANDBY> is in the STANDBY state, the unit is still connected to AC line voltage.

Please be sure to press <ON / OFF> to turn off the power or unplug the cord when you leave home for, say, a vacation.

●Note that the illustrations in these instructions may differ from the actual unit for explanation purposes.

The serial number of this product may be found on the back of the unit. No others have the same serial number as yours. You should record the number and other vital information here and retain this book as a permanent record of your purchase to aid identification in case of theft.

Date of Purchase	
Dealer Purchase from	
Dealer Address	
Dealer Phone No.	
Model No.	
Serial No.	

About Copyright

Unauthorized copying, broadcasting, public performance and lending of discs are prohibited.

This product incorporates copyright protection technology that is protected by U.S. patents and other intellectual property rights. Use of this copyright protection technology must be authorized by Macrovision, and is intended for home and other limited viewing uses only unless otherwise authorized by Macrovision. Reverse engineering or disassembly is prohibited.

U.S. Patent Nos. 6,836,549; 6,381,747; 7,050,698; 6,516,132; and 5,583,936.

Introduction

Supplied Accessories

Please check to make sure the following items are included with the main unit in the carton.

remote control (RC001BD)

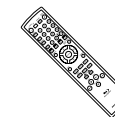

AC cord

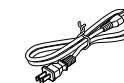

RCA audio cable

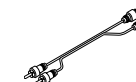

RCA video cable



"AA" (R6P) batteries x2



user guide

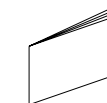

warranty card

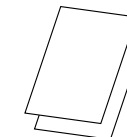

Trademark Information



HIGH-DEFINITION MULTIMEDIA INTERFACE

HDMI, the HDMI logo and High-Definition Multimedia Interface are trademarks or registered trademarks of HDMI Licensing LLC.



Manufactured under license from Dolby Laboratories. Dolby and the double-D symbol are trademarks of Dolby Laboratories.



Manufactured under license under U.S. Patent #'s: 5,451,942; 5,956,674; 5,974,380; 5,978,762; 6,487,535 & other U.S. and worldwide patents issued & pending. DTS and DTS Digital Surround are registered trademarks and the DTS logos and Symbol are trademarks of DTS, Inc. © 1996-2007 DTS, Inc. All Rights Reserved.

Introduction



Java and all other trademarks and logos are trademarks or registered trademarks of Sun Microsystems, Inc. in the United States and/or other countries.



DivX, DivX Certified, and associated logos are trademarks of DivX, Inc. and are used under license.



Windows Media and the Windows logo are trademarks or registered trademarks of Microsoft Corporation in the United States and/or other countries.

"Blu-ray Disc" and  are trademarks.

 is a trademark of DVD Format/Logo Licensing Corporation.



is trademark of Eastman Kodak Company.

About Discs

Disc Handling

- Handle the discs so that fingerprints and dust do not adhere to the surfaces of the discs.
- Always store the disc in its protective case when it is not used.
- Note that discs with special shapes cannot be played on this product. Do not attempt to play back such discs, as they may damage the unit.



Cleaning Discs

- When a disc becomes dirty, clean it with a cleaning cloth. Wipe the disc from the center to out. Do not wipe in a circular motion.
- Do not use solvents such as benzene, thinner, commercially available cleaners, detergent, abrasive cleaning agents or antistatic spray intended for analog records.

Playable Discs and Files

This unit is compatible to play back the following discs. To play back a BD or DVD, make sure that it meets the requirements for region codes and color systems as described on page 5. You can play back discs that have the following logos on the disc. Other disc types are not guaranteed to play back.

Playable discs	Logos
Blu-ray Disc - BD-video - BD-RE (ver.2.1) - BD-R (ver.1.1) (Unclosed discs may not be played back.)	
DVD-video	
DVD-RW (Finalized discs only)	
DVD-R DVD-R DL (Finalized discs only)	
CD-DA (audio CD)	
CD-RW	
CD-R	
Kodak Picture CD	
DTS - CD (5.1 Music Disc)	—

Playable files	Logos	Media
MP3	—	DVD-RW/-R CD-RW/-R SD Memory Card (including SDHC) miniSD Card microSD Card
Windows Media™ Audio		
JPEG	—	
DivX®		DVD-RW/-R CD-RW/-R

Introduction

Note

- Discs containing the DivX® files with the DivX® GMC (Global Motion Compensation) playback feature, which is DivX® supplemental function, cannot be played back on this unit.
- This unit cannot play back the disc contents protected by Windows Media™ Digital Rights Management (DRM).
- "WMA" (Windows Media™ Audio) is an audio codec developed by Microsoft® in the United States of America.
- This unit supports AAC as an audio format recorded with video contents for BD-R, BD-RE. This unit does not support AAC as an independent audio file.

Readable cards	Playable files / data
SD Memory Card (8MB - 2GB)	MP3, Windows Media™ Audio, JPEG, Picture-in-picture commentary, subtitles or other extras for BD-ROM Profile 1.1
SDHC Memory Card (4GB)	
miniSD Card (8MB - 2GB)	
microSD Card (8MB - 2GB)	

Note for SD Memory Cards

- Do not remove the SD Memory Card or turn off the unit while the contents of the card is in playback. It may result in malfunction or loss of the card's data.
- Please keep the SD Memory Cards in their cases when you are not using them.
- Do not try to open or modify the card.
- Do not touch the terminal surface with your fingers or any metals.
- Do not attach additional labels or stickers to cards.
- Do not remove the label of the SD Memory Cards.
- This unit supports SD Memory Card with FAT12/FAT16 file system, and SDHC Memory Card with FAT32 file system.
- This unit may not read the SD Memory Cards formatted on computer. If that is the case, please reformat the SD Memory Cards on this unit and try again.
- This unit does not supports mini SDHC and micro SDHC Memory Card.
- For miniSD Card and microSD Card adapter is necessary.

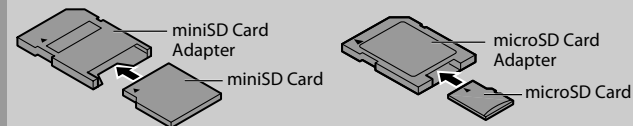

• Portions of this product are protected under copyright law and are provided under license by ARIS/SOLANA/4C.

Introduction

Unplayable Discs

The following discs will not play back on this unit.

- BD-RE Ver.1.0 (BD-disc with cartridge)
- BD-R Ver.1.2 (HTL 4x or LTH 2x)
- BD contains MP3/ Windows Media™ Audio/ JPEG/ DivX® files
- BD/DVD hybrid disc (e.g., Total Hi Def hybrid disc)
- BD-video that does not include "A" on its region code.
- DVD-video that does not include either "1" nor "ALL" on its region code.
- DVD-ROM/RAM (For DVD-ROM discs, data files in DivX® 3.11, 4.x, 5.x and 6 can be played)
- DVD-RW/-R recorded in non-compatible recording format
- CD-ROM (Data files in DivX® 3.11, 4.x, 5.x and 6 can be played)
- CDV (Only the audio part can be played)
- CD-G (Only the audio signals can be output)
- CompactDisc-Interactive (CD-I)
- Video Single Disc (VSD)
- Video CD, Super Video CD
- Super audio CD (Only the sound on the CD layer can be heard. The sound on the high-density super audio CD layer cannot be heard.)
- DVD-audio
- HD DVD
- Disc with recording area less than 55mm in diameter
- Unauthorized disc (Pirated disc)
- Unfinalized disc

Color Systems

BD and DVD are recorded in different color systems throughout the world. The most common color system is NTSC (which is used primarily in the United States and Canada).

This unit uses NTSC, so BD or DVD you play back must be recorded in the NTSC system. You cannot play back BD or DVD recorded in other color systems.

Region Codes

This unit has been designed to play back BD with region A and DVD-video with region 1. You cannot play back BD or DVD-video that are labeled for other regions. Look for the symbols on the right on your BD or DVD-video. If these region symbols do not appear on your BD or DVD-video, you cannot play back the disc in this unit. The letter or number inside the globe refers to region of the world. A BD or DVD-video labeled for a specific region can only play back on the unit with the same region code.



Structure of Disc/SD Memory Card Contents

The contents of BD / DVD are generally divided into titles. Titles may be further subdivided into chapters.

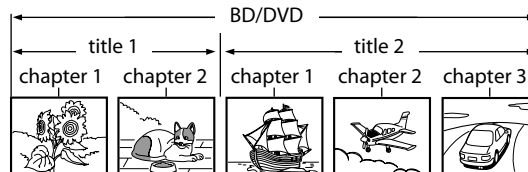

Audio CDs are divided into tracks.



Data discs or SD Memory Cards contains MP3/Windows Media™ Audio/JPEG/DivX® is divided into folders, and the folders are subdivided into files.

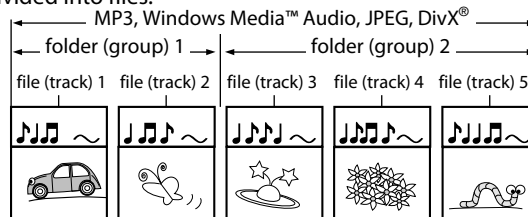

Introduction

Symbols Used in this Operating Instructions

To specify for which media type each function is, we put the following symbols at the beginning of each item to operate.

Symbol	Description
BD-V	Description refers to BD-video and BD-RE (ver. 2.1)/BD-R (ver.1.1) recorded in BDMV mode
BDAV	Description refers to BD-RE (ver.2.1)/BD-R (ver1.1) recorded in BDAV mode
DVD-V	Description refers to DVD-video and DVD-RW/-R recorded in video mode
DVD-VR	Description refers to DVD-RW/-R recorded in VR mode
CD	Description refers to audio CD and DTS-CD
MP3	Description refers to DVD-RW/-R, CD-RW/-R and SD Memory Card with MP3 files
WMA	Description refers to DVD-RW/-R, CD-RW/-R and SD Memory Card with Windows Media™ Audio files
JPEG	Description refers to DVD-RW/-R, CD-RW/-R and SD Memory Card with JPEG files
DivX®	Description refers to DVD-RW/-R and CD-RW/-R with DivX® files

If you do not find any of the symbols listed above under the function heading, the operation is applicable to all media.

About the button names in this explanation

< > : Buttons on the main unit
[] : Buttons on the remote control

Button name only:
Buttons on the main unit and remote control

Introduction

About the Remote Control

Loading the Batteries

1 Open the battery compartment cover.

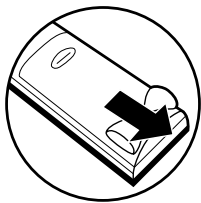

2 Insert two "AA" (R6P) batteries, with each one oriented correctly.

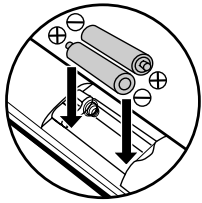

3 Close the cover.

Cautions on Batteries

- Use "AA" (R6P) batteries in this remote control.
- Replace the batteries with new ones approximately once a year, though this depends on the frequency with which the remote control is used.
- If the remote control does not operate within a close proximity of the main unit, replace the batteries with new ones, even if less than a year has passed.
- The included batteries serve only for verifying operation. Replace them with new batteries as soon as possible.
- When inserting the batteries, be careful to do so in the proper direction, following the ⊕ and ⊖ marks in the remote control's battery compartment.
- To prevent damage or battery fluid leakage:
 - Do not mix a new battery with an old one.
 - Do not mix two different types of batteries such as alkaline and manganese.
 - Do not short-circuit, disassemble, heat or dispose of batteries in flames.
- Remove the batteries when not planning to use the remote control for a long period of time.
- If the batteries should leak, carefully wipe off the fluid from the inside of the battery compartment, then insert new batteries.

Using a Remote Control

Keep in mind the following when using the remote control:

- Make sure that there are no obstacles between the remote control and infrared sensor window on the unit.
- Remote operation may become unreliable if strong sunlight or fluorescent light is shining on infrared sensor window of the unit.
- Remote control for different devices can interfere with each other. Avoid using remote control for other equipment located close to the unit.
- Replace the batteries when you notice a fall off in the operating range of the remote control.
- The maximum operable ranges from the unit are as follows.
 - **Line of sight:** approx. 16 feet (5m)
 - **Either side of the center:** approx. 16 feet (5m) within 30°

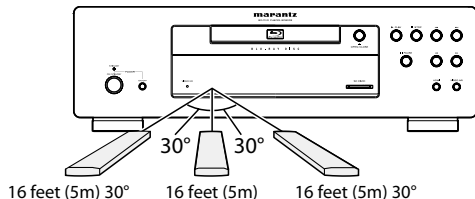

Changing the Signal Code of a Remote Control

To avoid the other Marantz's BD players responding the remote signal of this unit, you can change the signal code of the remote control. If the signal code of the remote control does not match to the signal code of the unit, you cannot control the unit with the remote control.

Change the signal code of the unit

- 1) In stop mode, press [SETUP].
- 2) Use [◀/▶] to select **Other**, then press [ENTER].
- 3) Use [◀/▶] to select **Other**, then press [ENTER].
- 4) Use [△/▽] to select "Remote Control Setting".
- 5) Press [ENTER] to select "BD1" or "BD2".

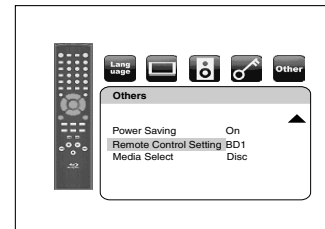

6) Press [SETUP] to exit.

- At this point the new signal code of the unit is effective. Please change the signal code of the remote control to match to the signal code of the unit with following procedure.

Change the signal code of the remote control

Set to "BD1":

Press hold down both **■** and [1] on the remote control for at least five seconds.

Set to "BD2":

Press hold down both **■** and [2] on the remote control for at least five seconds.

- If the signal code does not match, the signal code of the remote control will be displayed on the front panel display.
- The default setting and the setting after you change the batteries is "BD1".

Part Names and Functions

Front Panel

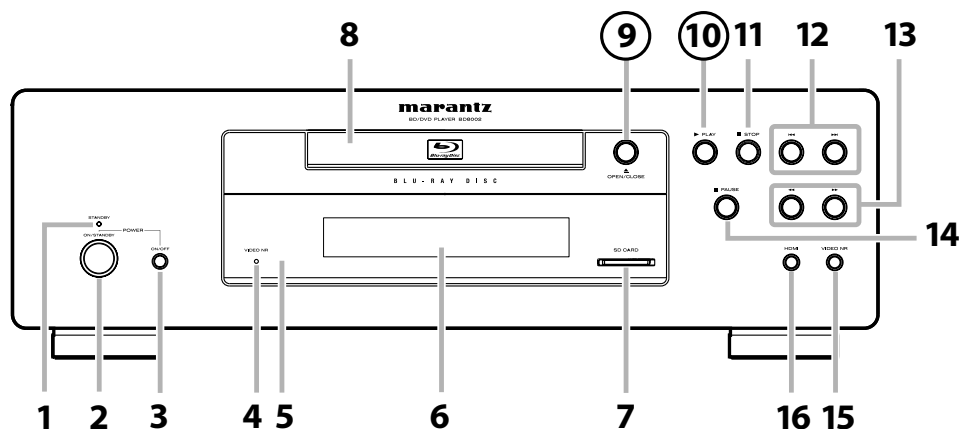

The unit can also be turned on by pressing the buttons with circled numbers.

1. STANDBY indicator

This indicator lights up in green when the power is on, and lights up in red in standby mode.

2. ON/STANDBY button

Press to turn the unit to standby mode. In standby mode, this unit still consumes small amount of power.

3. ON / OFF (POWER) switch

Press to turn the unit on and off. If you turn off the unit using this switch, the unit does not consume power. In this condition, this unit does not accept any button except this switch.

4. VIDEO NR indicator

Indicates that video signals of a BD, DVD, etc., are being processed digitally with the DNR (Digital Noise Reduction) processing.

5. Infrared sensor window

Receives signals from your remote control so that you can control the unit from a distance.

6. Display

Refer to "Front Panel Display" on page 9.

7. SD CARD slot

Insert an SD Memory Card, and play back the contents in it.

8. Disc tray

Place a disc when opening the disc tray.

9. ▲ OPEN/CLOSE button

Press to open or close the disc tray.

10. ► PLAY button

Press to start or resume playback.

11. ■ STOP button

Press to stop playback.

12. ◀◀ / ▶▶ (SKIP DOWN/UP) button

Press to skip down/up titles/chapters/tracks/files.

13. ◀◀ / ▶▶ (FAST FORWARD/REVERSE) button

Press to search forward / backward through a disc.

14. || PAUSE button

Press to pause playback.

15. VIDEO NR (NOISE REDUCTION) button

Press repeatedly to reduce the overall level of noise on the picture (DNR). Each time you press the button, the level of the DNR switches "Off" → "+1" → "+2" → "+3" → "Off".

16. HDMI (RESOLUTION) button

Press to set the HDMI jack's video signal output mode.

Rear Panel

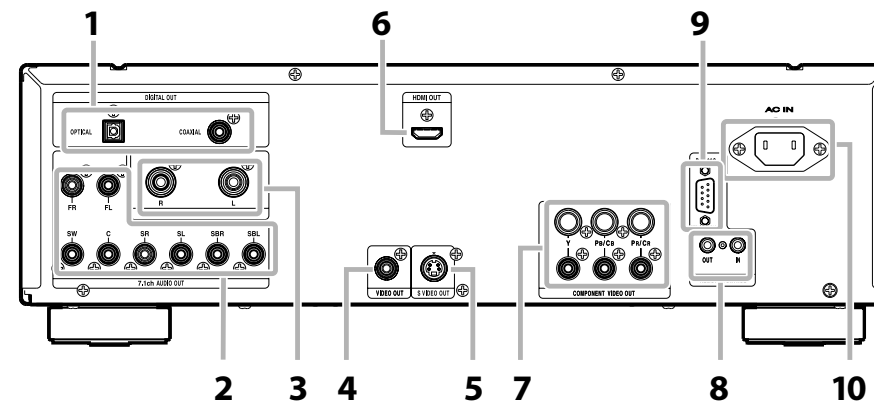

1. DIGITAL OUT jack

Use digital audio coaxial/optical cable to connect to an AV receiver, Dolby Digital decoder or other device with a digital audio coaxial/optical input jack.

2. 7.1ch AUDIO OUT jacks

Use an RCA audio cable to connect these jacks to the 7.1-channel audio input jacks of your amplifier with 7.1-channel input terminals.

3. 2ch AUDIO OUT jacks

Use an RCA audio cable to connect these jacks to the 2-channel audio input jacks of your amplifier with 2-channel input terminals.

4. VIDEO OUT jack

Use an RCA video cable to connect to a TV monitor, AV receiver or other device.

5. S VIDEO OUT jack

Use an S-video cable to connect to the S-video input jack of external device.

6. HDMI OUT jack

Use an HDMI cable to connect to a display with an HDMI input jack.

7. COMPONENT VIDEO OUT jacks

Use a component video cable to connect to a display device with component input jacks.

8. REMOTE CONTROL OUT/ IN jacks

By connecting this Blu-ray player to another Marantz component, you can remotely operate the components as a single system. For connections, use the control adaptor cable. (Mini Jack to RCA)

9. CONTROL CONNECTOR (RS-232C)

This is a terminal for future system extension.

10. AC IN Terminal

Use to connect the AC cord to supply the power.

Note

- Do not touch the inner pins of the jacks on the rear panel. Electrostatic discharge may cause permanent damage to the unit.

Remote Control

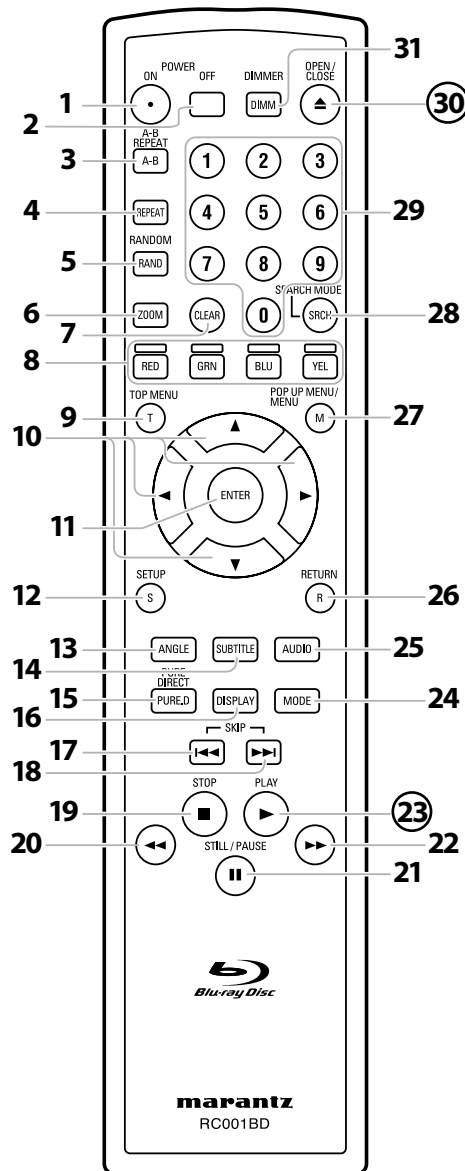

The unit can also be turned on by pressing the buttons with circled numbers.

- 1. POWER ON button**
 - Press to turn the unit on.
- 2. POWER OFF button**
 - Press to turn the unit to standby mode.
- 3. A-B REPEAT button**
 - Press to mark a segment between A and B for A-B repeat playback.
- 4. REPEAT button**
 - Press to select the repeat mode.
- 5. RANDOM button**
 - Press to display the random playback screen for shuffling the playback order of tracks/files.
- 6. ZOOM button**
 - During playback, press to enlarge the picture on the screen.
- 7. CLEAR button**
 - Press to clear the information once entered, to clear the marker settings, or to cancel the programming for CD, etc.
- 8. RED/GRN/BLU/YEL button**
 - Press to select item on some BD menus.
- 9. TOP MENU button**
 - Press to display the top menu.
- 10. Cursor Δ / ∇ / \triangleleft / \triangleright buttons**
 - Press to select items or settings.
- 11. ENTER button**
 - Press to confirm or select menu items.
- 12. SETUP button**
 - Press to display the setup menu.
- 13. ANGLE button**
 - Press to access various camera angles on the disc.
 - Press to rotate the JPEG/Kodak Picture images.
- 14. SUBTITLE button**
 - Press to display the subtitle menu.
- 15. PURE DIRECT button**
 - Press to stop output of video signals, etc., and output only the analog audio signals to achieve high quality sound from analog audio outputs.
- 16. DISPLAY button**
 - Press to display the On-Screen display menu.
- 17. SKIP $\triangleleft\triangleleft$ button**
 - During playback, press to return to the beginning of the current title chapter, track or file.
- 18. SKIP $\triangleright\triangleright$ button**
 - During playback, press to skip the next chapter, track or file.
- 19. STOP \blacksquare button**
 - Press to stop playback.
 - Press to exit from the title menu.
- 20. REW $\triangleleft\triangleleft$ button**
 - During playback, press to fast reverse the playback.
- 21. STILL/PAUSE \parallel button**
 - Press to pause playback.
 - When playback is in pause, press repeatedly to forward the playback step by step.
- 22. FFW $\triangleright\triangleright$ button**
 - During playback, press to fast forward the playback.
 - When playback is in pause, press to slow forward the playback.
- 23. PLAY \triangleright button**
 - Press to start playback or resume playback.
- 24. MODE button**
 - During playback, press to display the picture adjustment menu, and rapid playback.
 - During the JPEG playback, press to display menus for changing the visual effect for switching the image or changing the size of the image.
 - In stop mode with BD inserted, press to display a menu for setting the BD audio mode.
 - In stop mode with BD or DVD inserted, press to display a menu for setting the virtual surround.
 - In stop mode with audio CD, or disc with MP3, Windows Media™ Audio, JPEG files inserted, press to display menus for program and random playback.
- 25. AUDIO button**
 - Press to display the audio menu.
- 26. RETURN button**
 - Press to return to the previously displayed menu screen.
- 27. POP UP MENU / MENU button**
 - Press to display the disc menu.
- 28. SEARCH MODE button**
 - Press to display the search menu.
- 29. Number buttons**
 - Press to enter the title/chapter/track/file numbers.
- 30. OPEN/CLOSE \blacktriangle button**
 - Press to open or close the disc tray.
- 31. DIMMER button**
 - Press to adjust the brightness of the front panel display.

Note

- [ZOOM] and [RANDOM] are not available for BD.

Front Panel Display

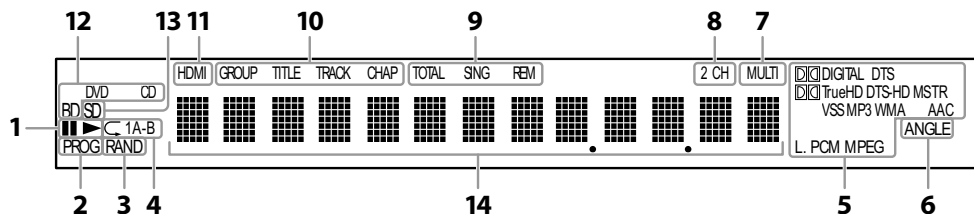

1. ► : Appears when playing back a disc.
 || : Appears when playback is paused.
2. Appears during program playback.
3. Appears during random playback.
4. Appears during repeat playback.
5. These indicate the format being decoded.
 • This is not an indication of the recorded format or the format that will be output.
6. Appears when playing back a multi angle disc.
7. Appears when playing back a multi-channel audio disc.
8. Appears when playing back a 2-channel audio disc.
9. Indicates the time display mode.
 TOTAL : Appears when displaying the total remain/elapsed time of audio CD.
 SING : Appears when sound data is being played or sound data is highlighted in program menu.
 REM : Appears when displaying remaining time.
10. These indicate the type of the different sections of the currently playing disc.
11. Appears when HDMI video or audio signals are being output.
 Does not appear when HDMI connection is not verified.
12. Indicates the type of the currently playing disc.
13. Appears when inserting an SD Memory Card.
14. Appears various type of information on the disc, the elapsed playing time, etc.

Adjusting the Brightness of the Display

You can adjust the brightness of the display by the pressing [DIMMER] repeatedly. The brightness changes as bright → dimmer → auto each time you press [DIMMER]. If you select auto, the display gets dimmer during playback.

Note

- [DIMMER] is not available when the setup menu is displayed.

Examples of Displays during Operation

Display	Description
POWER-ON	Power on
POWER-OFF	Standby mode
OPEN	Tray open
CLOSE	Tray is closing
LOADING	Loading the disc
NO DISC	No disc inserted
NO SD MEMORY	No SD Memory Card inserted
-----	This unit cannot read the disc or SD Memory Card inserted.
STOP	Stop mode.
480.P	HDMI output mode(480p) is selected.
720.P	HDMI output mode(720p) is selected.
1080.i	HDMI output mode(1080i) is selected.
1080.P	HDMI output mode(1080p) is selected.
1080.P24	HDMI output mode(1080p24 frame) is selected.
Normal	Pure direct mode is set to pure direct off.
Display Off	Pure direct mode is set to front panel display off.
Video Off	Pure direct mode is set to video signal off.
All Off	Pure direct mode is set to video signal and front panel off.
P00 01	The total number of the track that has been registered for the program playback and track number currently selected.
P00 F001-0002	The total number of the files that has been registered for the program playback and folder/file number currently selected.
P00 ROOT-0002	When the root folder is selected "ROOT" is displayed.
ALL CLEAR	"All Clear" for program playback setting is selected.

Note

- When playing back the disc that contains more than 100 titles, display of the chapter and time on the front panel display will be moved a few dots to the right.

Connections

Connecting to a TV

Make one of the following connections, depending on the capabilities of your existing device.

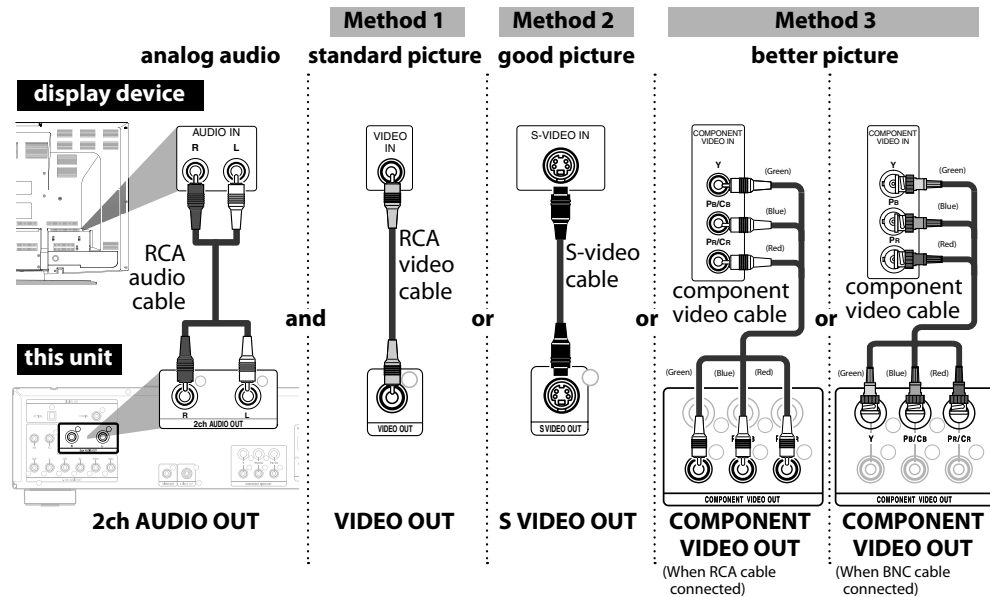

Supplied cables used in this connection are as follows:

- RCA audio cable (L/R) x 1
- RCA video cable x 1

Please purchase the rest of the necessary cables at your local store.

Note

- Connect this unit directly to the TV. If the RCA audio/video cables are connected to a VCR, pictures may be distorted due to the copy protection system.
- If the display device to which the player is to be connected is compatible with progressive scan video, connect to the component video input.
- This unit's COMPONENT VIDEO OUT jacks are compatible for 480i/480p/720p/1080i video resolution. If the connected display device is not compatible for 480p/720p/1080i video resolution, set "Component Output" to "480i". (For playing back BD, 480i video resolution is not available.)
- If the picture is not output properly to the display device because of the "HDMI Video Resolution" or "Component Output" setting, press and hold **▶** on the front panel for more than 5 seconds. The "HDMI Video Resolution" setting will be reset to the default automatically.
- If you are using HDMI connection and set "HDMI Video Resolution" to "1080p" or "1080p24", picture may not be output properly to the display device. In that case, set "HDMI Video Resolution" to "480p", "720p" or "1080i".

Connecting to a Display Device with HDMI Cable

Connecting this unit to device with an HDMI jack using an HDMI cable enables digital transfer of both digital video signals and multi-channel audio signals.

After making the connection, please make HDMI settings on setup menu according to your display device. Refer to page 30-32.

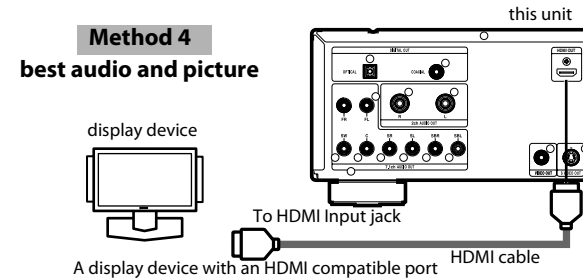

Cables not included.

Please purchase the necessary cables at your local store.

Connecting to a Display Device and an Amplifier/Receiver with HDMI Cable

Connecting this unit to display device and an amplifier/receiver with an HDMI jack using HDMI cables enables digital surround sound with high quality video.

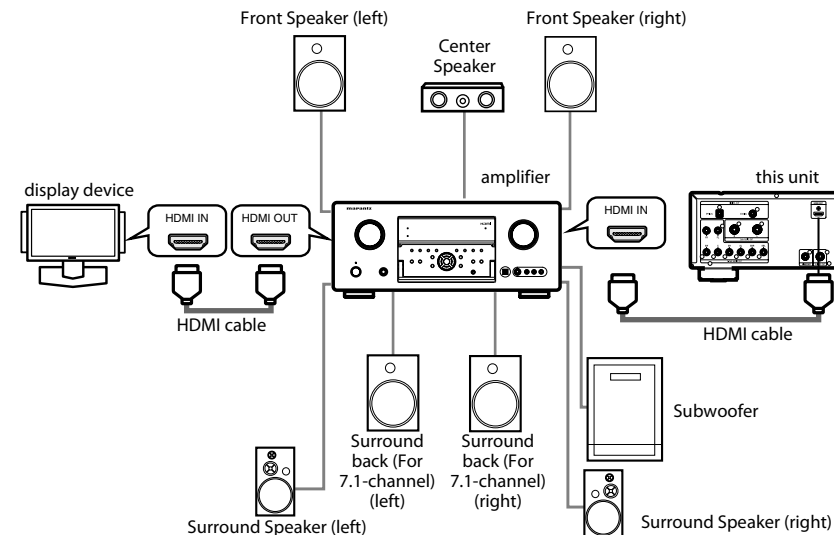

Cables not included.

Please purchase the necessary cables at your local store.

Connections

HDMI Output Mode and Actual Output Signals

Press <HDMI (RESOLUTION)> to select the HDMI output mode. HDMI video resolution changes as following.

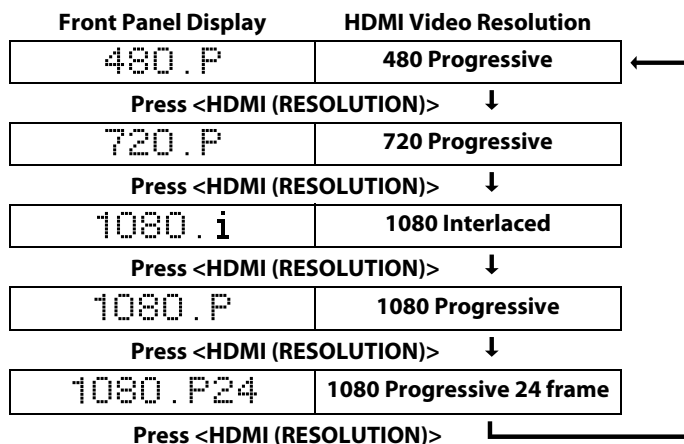

Note

- You can change the HDMI output mode with <HDMI (RESOLUTION)> during playback as well.
- After you select a HDMI output mode, the supported HDMI video resolution will be output.
- Video and audio signals may be distorted temporarily when switching to/from the HDMI output mode.
- You can also change the HDMI output mode from "HDMI Video Resolution" in the "Video" menu on the setup menu. In this menu, you can confirm what HDMI video resolutions are supported by connected display device. Refer to page 31.
- In order to get natural and high quality film reproduction of 24-frame film material, use HDMI cable (High Speed HDMI cable is recommended) and select "1080p24" if the connected display device is compatible with 1080p24 frame input.
- For BD, with the 1080p24 frame, you can enjoy natural and high quality film production of 24-frame film material. If the connected display device is not compatible for 1080p24 frame, you cannot set "HDMI Video Resolution" to "1080p24".
- Even when "HDMI Video Resolution" is set to "1080p24", if "I/P Direct" is set to "Off" or for playing back DVD, a video resolution supported by the disc and the display device will be output instead of 1080p24 frame.
- There is no output from VIDEO OUT, S VIDEO OUT and COMPONENT VIDEO OUT jacks when you play back a BD that recorded 24-frame film material.
- COMPONENT VIDEO OUT jacks may not output any signals when you set "HDMI Select" to "RGB" or "HDMI Deep Color" to "Auto".
- When both HDMI OUT and COMPONENT VIDEO OUT jacks are connected to display device, and HDMI output is "1080p", the video signal may not be output properly from the COMPONENT VIDEO OUT jacks.
- If you change the HDMI output mode with <HDMI (RESOLUTION)> during BD playback, it may take 2 to 10 seconds to change, and while changing the HDMI output mode, sound and video will be stopped.
- "HDMI Deep Color" is available only when the display device is connected by HDMI cable and supports HDMI Deep Color.
- For "Auto" in "HDMI Deep Color" and for "1080p" or "1080p24" in "HDMI Video Resolution", using the High Speed HDMI cable is recommended.

Connections

Audio Setting

When using HDMI connections make the "HDMI Audio Out" settings in the "Audio" menu on the setup menu according to the specifications of the device or monitor to be connected.

Device to be connected	"HDMI Audio Out" setting	Output HDMI audio signal
Device compatible with DTS, DTS-HD, Dolby Digital, Dolby Digital Plus or Dolby TrueHD decoding	HDMI Multi(Normal)	Dolby Digital, Dolby Digital Plus, Dolby TrueHD, DTS, or DTS-HD bitstream are output from HDMI OUT. Make the speaker settings on the connected AV amplifier, etc.
Device compatible with 3 or more channels of audio inputs (not DTS, DTS-HD, Dolby Digital, Dolby Digital Plus or Dolby TrueHD compatible)	HDMI Multi(LPCM)	Multi-channel audio signals are output from the HDMI terminal. Make the speaker settings with the speaker setting items appear after you select "HDMI Multi(LPCM)". Refer to page 32.
Device compatible with 2-channel audio input or device not compatible with audio input	HDMI 2ch	Down-mixed 2-channel audio signals are output from HDMI OUT.
HDMI connection to a display device, and digital audio connection (coaxial/optical) to an AV amplifier.	Audio Mute	HDMI audio will be muted, and Dolby Digital/DTS bitstream or LPCM will be output from DIGITAL OUT depending on the "Digital Out" setting. Refer to page 12.

Audio signals output from HDMI OUT

Disc type	Audio recording format	"HDMI Audio Out" setting		
		HDMI Multi(Normal)	HDMI Multi(LPCM)	HDMI 2ch
BD-video	Dolby Digital	Dolby Digital*1	Multi LPCM	2ch Downmix LPCM
	Dolby Digital Plus	Dolby Digital Plus*1	Multi LPCM*2	2ch Downmix LPCM
	Dolby TrueHD	Dolby TrueHD*1	Multi LPCM	2ch Downmix LPCM
	DTS	DTS*1	Multi LPCM	2ch Downmix LPCM
	DTS-HD	DTS-HD*1	Multi LPCM*3	2ch Downmix LPCM
	LPCM	Multi LPCM	Multi LPCM	2ch Downmix LPCM
BD-RE/BD-R	AAC	AAC	Multi LPCM	2ch Downmix LPCM
	LPCM	Multi LPCM	Multi LPCM	2ch Downmix LPCM
DVD-video	Dolby Digital	Dolby Digital	Multi LPCM	2ch Downmix LPCM
	DTS	DTS	Multi LPCM	2ch Downmix LPCM
	LPCM	Multi LPCM	Multi LPCM	2ch Downmix LPCM
DivX®	Dolby Digital	Dolby Digital	Multi LPCM	2ch Downmix LPCM
	MP3/MP2	2ch LPCM	2ch LPCM	2ch LPCM
audio CD/ MP3/Windows Media™ Audio		2ch LPCM	2ch LPCM	2ch LPCM
DTS-CD		DTS	Multi LPCM	2ch Downmix LPCM

Connections

- *1 If "BD Audio Mode" is set to "Mix Audio Output" audio will be output as Multi LPCM. Refer to page 23.
- *2 Outputs audio signals decoded from independent substream.
- *3 For DTS-HD Master Audio, outputs audio signals decoded from DTS-HD Master Audio stream, and for DTS-HD High Resolution Audio, outputs audio signals decoded from DTS core stream.
- If the connected device is not compatible with the HDMI BITSTREAM, audio will be output as Multi LPCM or 2ch Downmix LPCM depends on the capability of the connected device even if you select "HDMI Multi(Normal)" in "HDMI Audio Out" setting. Refer to page 32.

Copyright protection system
 To play back the digital video images of a BD/DVD via an HDMI connection, it is necessary that both the unit and the display device (or an AV amplifier) support a copyright protection system called HDCP (high-bandwidth digital content protection system). HDCP is copy protection technology that comprises data encryption and authentication of the connected AV device. This unit supports HDCP. Please read the operating instructions of your display device (or AV amplifier) for more information.

* HDMI: High-Definition Multimedia Interface

Note

- When using HDCP-incompatible display device, the image will not be viewed properly.
- Among the devices that support HDMI, some devices can control other devices via the HDMI jack, this unit cannot be controlled by another device via the HDMI jack.
- The audio signals from the HDMI jack (including the sampling frequency, the number of channels and bit length) maybe limited by the device that is connected.
- Among the monitors that support HDMI, some do not support audio output (e.g, projectors). In connections with device such as this unit, audio signals are not output from the HDMI output jack.

Digital Connection to an AV Amplifier with Built-in Decoder

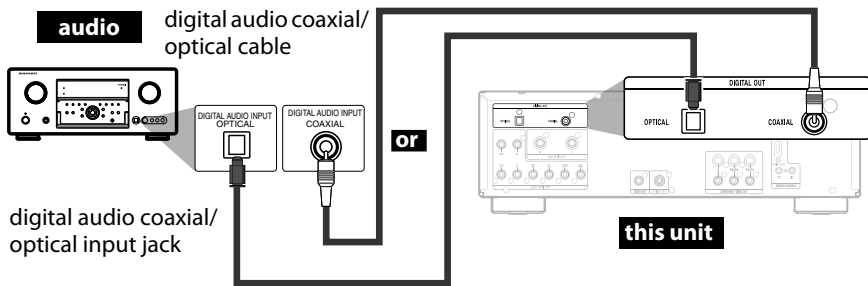

Audio signals output from DIGITAL OUT

When both HDMI and DIGITAL OUT is connected to other devices, the audio signals currently output from the HDMI OUT will be output from the DIGITAL OUT jack as well, except that Dolby Digital signal will be output instead of Dolby Digital Plus and Dolby TrueHD, and DTS signal will be output instead of DTS-HD.

< When HDMI is not connected or "Audio Mute" is selected...>

When HDMI is not connected or the "Audio Mute" is selected in "HDMI Audio Out" setting, the audio signals output from DIGITAL OUT changes depending on the "Digital Out" setting. Refer to the following table.

To set "Digital Out", press **[SETUP]**, then select "Quick" → "HDMI Audio Out" → "Audio Mute" or "Custom" → "Audio" → "HDMI Audio Out" → "Audio Mute".

Connections

Disc type	Audio recording format	"Digital Out" setting	
		Bitstream	LPCM
BD-video	Dolby Digital	Dolby Digital	2ch Downmix LPCM
	Dolby Digital Plus	Dolby Digital	2ch Downmix LPCM
	Dolby TrueHD	Dolby Digital	2ch Downmix LPCM
	DTS	DTS*1	2ch Downmix LPCM
	DTS-HD	DTS*1	2ch Downmix LPCM
	LPCM	2ch Downmix LPCM*1	2ch Downmix LPCM
BD-RE/BD-R	AAC	AAC	2ch Downmix LPCM
	LPCM	2ch Downmix LPCM	2ch Downmix LPCM
DVD-video	Dolby Digital	Dolby Digital	2ch Downmix LPCM
	DTS	DTS	2ch Downmix LPCM
	LPCM	2ch Downmix LPCM	2ch Downmix LPCM
DivX®	Dolby Digital	Dolby Digital	2ch Downmix LPCM
	MP3/MP2	2ch LPCM	2ch LPCM
audio CD/ MP3/Windows Media™ Audio		2ch LPCM	2ch LPCM
DTS-CD		DTS	2ch Downmix LPCM

*1 For the BD title with secondary or interactive audio, these audio will be output as Dolby Digital when all the conditions listed below are met:

- When "BD Audio Mode" is set to "Mix Audio Output".
- When "HDMI Audio Out" is set to "Audio Mute".
- When "Digital Out" is set to "Bitstream".

If the BD title does not have secondary or interactive audio, the audio will be output as shown in the table.

- This table applies only when HDMI is not connected or the "Audio Mute" is selected in "HDMI Audio Out" setting.

Note

- In order to output LPCM signal from DIGITAL OUT jack while outputting the HDMI audio signal, set "BD Audio Mode" to "Mix Audio Output" and set "HDMI Audio Out" to "HDMI Multi(LPCM)".

Note for Optical Cable

- Optical cable may be damaged when bent at sharp angles. Ensure cables are coiled in loops with a diameter of 6 inches (15cm) or more when storing them.
- Use a cable which is 9.8 feet (3m) or shorter.
- Insert cable plugs firmly into the jacks when making connections.
- If a plug has dust or is dirty, clean it with a soft cloth before inserting it into a jack.

Cables not included.
 Please purchase the necessary cables at your local store.

Connections

Connection to a Device with 2-channels of Analog Audio Inputs

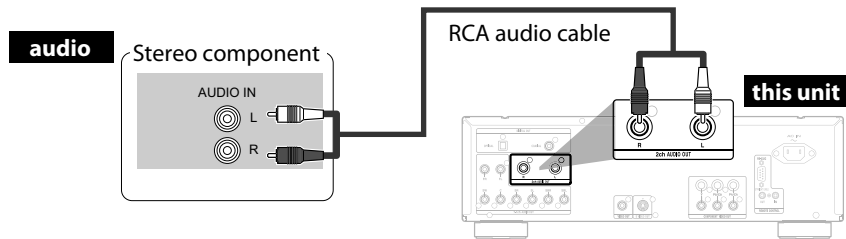

Supplied cables used in this connection are as follows:

- RCA audio cable (L/R) x 1

Note

• When connecting to a 2-channel audio stereo device, use the 2ch AUDIO OUT jacks. If the 7.1ch AUDIO OUT jacks are used, set "7.1ch Audio Out" in the "Audio" menu to "2 Channel" (Refer to page 33). For software recorded in multi-channel, analog signals that have been down-mixed into 2 channels are output. (For sources which are prohibited from down-mixing, only the FL/FR signals are output.)

Surround Connections to a Device with 7.1/5.1-channels of Analog Audio Inputs

Analog 7.1ch/5.1ch audio signals can be output from 7.1ch AUDIO OUT jacks.

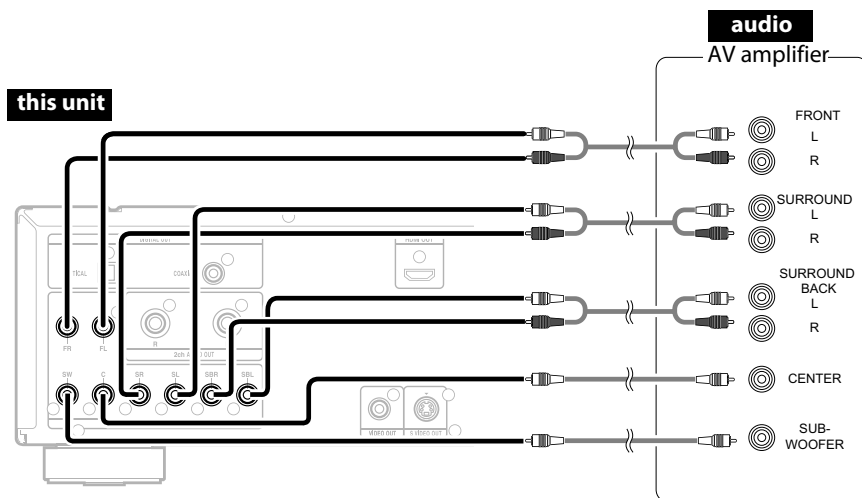

Supplied cables used in this connection are as follows:

- RCA audio cable (L/R) x 1
- Please purchase the rest of the necessary cables at your local store.

Connections

Note

• If you connect to 5.1-channel surround system, do not connect to SBR/SBL (surround back R/L) jacks, then set "Surround Back" in "Speaker Configuration" to "None".

Connecting the AC cord

After you made all necessary connections, connect the AC cord to the AC IN. Then connect the AC cord to the AC outlet.

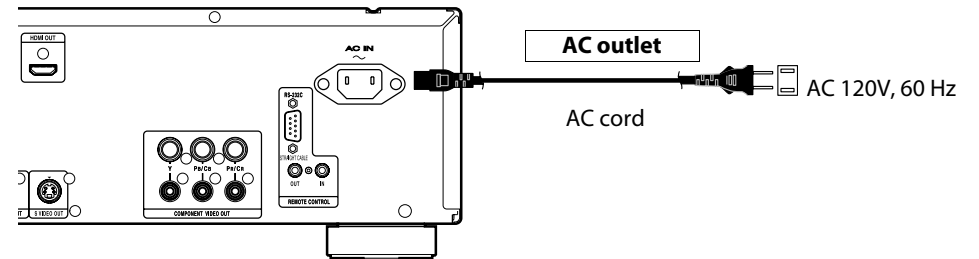

Supplied cables used in this connection are as follows:

- AC cord x 1

Note

• Insert the plugs securely. Incomplete connections will result in the generation of noise.

Playback

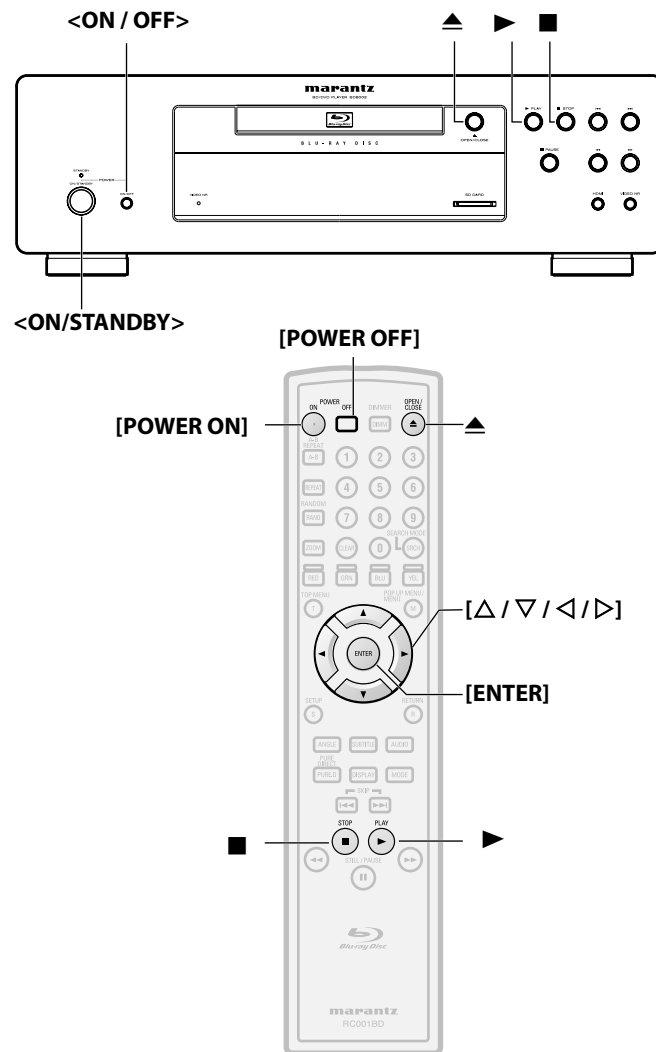

About the button names in this explanation

< >: Buttons on the main unit

[] : Buttons on the remote control

Button name only:

Buttons on the main unit and remote control

Turning the Power On

- 1 Press <ON / OFF>. The power indicator lights red and the power is set to the standby mode.
- 2 Press <ON/STANDBY> or [POWER ON]. The power indicator lights green and the power turns on.

Turning the power off

Press <ON/STANDBY> or [POWER OFF].

- The power is set to the standby mode. Press <ON / OFF> .
- The power indicator turns off, and so does the power.

Note

- Power continues to be supplied to some of the circuitry even when the power is in the standby mode. When leaving home for long periods of time or when traveling, either press <ON / OFF> to turn off the power, or unplug the AC cord from the AC outlet.

Direct Playback

BD-V BDAV DVD-V DVD-VR CD

- 1 Turn on the power of this unit. (Refer to "Turning the Power On" on this page.)
- 2 Turn on the display device and select the appropriate input on the device to which the unit is connected.
- 3 Press ▲ to open the disc tray.

- 4 Place the disc on the disc tray with its label side facing up.

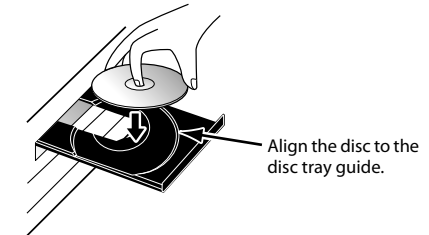

- 5 Press ▲ to close the disc tray.

It may take a while to load the disc.

Some discs may start playback automatically.

- 6 Press ▶ to start playback. For many of BD-video and DVD-video, a menu screen may appear. In this case, use [Δ / ▽ / ◀ / ▶] to select the desired item, then press [ENTER].

- 7 Press ■ once to stop playback temporarily. Refer to "Resume Playback" on page 16.

To eject the disc:

Press ▲ to open the disc tray, then remove the disc before turning off the unit.

Note

- Ⓞ may appear at the top-right on the screen when the operation is prohibited by the disc or this unit.
- During the playback of 2-layered disc, pictures may stop for a moment. This happens when the 1st layer switches to the 2nd layer. This is not a malfunction.
- The operation may vary when you play back BD/DVD with disc menu. Refer to the manual accompanying the disc for details.

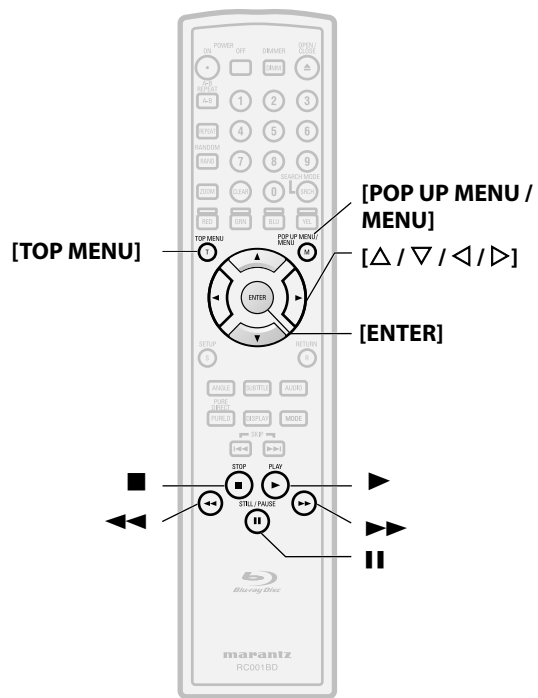
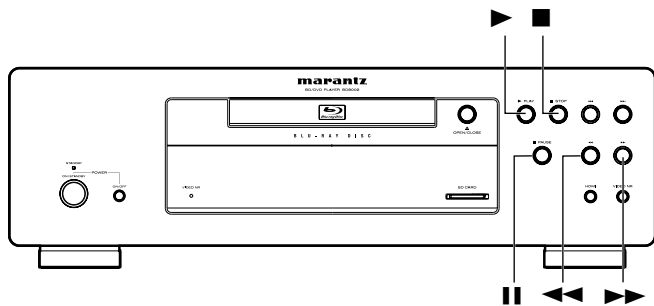

About the button names in this explanation
 < >: Buttons on the main unit
 [] : Buttons on the remote control
Button name only:
 Buttons on the main unit and remote control

Operations Using Disc Menu, Title Menu, and Popup Menu

BD-V DVD-V

Many of BD and DVD disc contains Disc menu (DVD), Title menu (BD/DVD) or Pop-up menu (BD-video) which describes the contents of the disc, or a disc menu, which guides you through the available functions in the disc. The contents of the menus may differ depending on the discs.

Disc menu (DVD)

- 1) Press [POP UP MENU / MENU].
 - The disc menu will appear.
- 2) Use [Δ / ▽ / ◀ / ▶] to select an item, then press [ENTER].

Title menu (BD/DVD)

- 1) Press [TOP MENU].
- 2) Use [Δ / ▽ / ◀ / ▶] to select an item, then press [ENTER].

Pop-up menu (BD-video)

- This is a special feature available for some BD. When you press [POP UP MENU / MENU], a menu pops out on the screen while the contents still play back.
- 1) During BD playback, press [POP UP MENU / MENU].
 - 2) Use [Δ / ▽ / ◀ / ▶] to select an item, then press [ENTER].

Note

- If the feature is not available,  may appear on the TV screen.
- Contents of menus and corresponding menu operations may vary among discs. Refer to the manual accompanying the disc for details.

Playing Back a BDAV mode BD-RE/-R and a VR mode DVD-RW/-R

BDAV DVD-VR

When you are playing back a BDAV mode BD-RE/-R and a VR mode DVD-RW/-R, you can choose "Original" or "Playlist" if the disc contains a "Playlist".

- 1) In stop mode, press [POP UP MENU / MENU] to call up BD/DVD menu.
- 2) Use [◀ / ▶] to select "Original" or "Playlist".

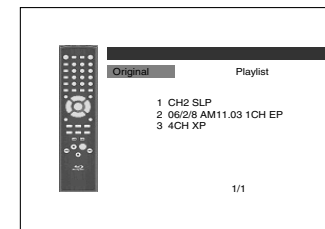

- 3) Use [Δ / ▽] to select desired title, then press [ENTER].

Note

- "Original" is the title which is actually recorded on the disc.
- Playlist is edited version of the Original.
- BD/DVD menu varies depending on discs.
- If the disc does not contain Playlist, Playlist will not be displayed on the BD/DVD menu.

Pause

- 1) During playback, press II. Playback will be paused.



- 2) Press ▶ to return to normal playback.

Note

- For BD, DVD and DivX®, set "Still Mode" to "Field" in the "Video" menu if pictures in the pause mode are blurred (refer to page 31).

Playback

Resume Playback

1) During playback, press ■.

- Resume message will appear on the screen.

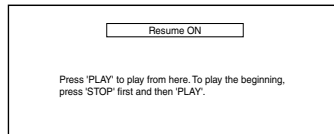

<Example: BD>

2) Press ►.

In a few seconds, playback will resume from the point at which it stopped last. To cancel the resume playback and start playing back the disc from the beginning, press ■ again while the playback is stopped.

Note

- For MP3, JPEG or Windows Media™ Audio, playback will resume from the beginning of the current file.
- The resume information will be saved even when the power is in standby mode.
- If you open the disc tray or press ■ again in stop mode, the resume information will be cleared.
- If you switch between "Disc" mode and "SD Memory" mode, the resume information will be cleared.
- Resume playback is not available for the BD that supports Java applications (BD-J).

Fast Forward / Fast Reverse Playback

BD-V BDAV DVD-V DVD-VR CD MP3
WMA DivX®

1) During playback, press ◀◀ or ▶▶ repeatedly to select a desired forward or reverse speed.

◀◀ Button



▶▶ Button



2) Press ► to return to normal playback.

- For BD and DVD, speed changes in 5 different levels. For audio CD, MP3, Windows Media™ Audio, and DivX®, speed changes in 3 different levels.
- For audio CD, MP3 and Windows Media™ Audio, sound will be output at any speed of fast forward and reverse search.

Note

- For MP3 and Windows Media™ Audio, fast forward/fast reverse search between different files are not available.
- For audio CD, fast forward/fast reverse search between different tracks are not available during the program and random playback.
- For some DivX® files, fast forward/fast reverse search may not function.

Slow Forward Playback

BD-V BDAV DVD-V DVD-VR DivX®

1) During playback, press ■.

2) Press ►►.

- Slow motion playback will begin and sound will be muted.

3) Press ►► repeatedly to select a desired speed.

- Slow forward speed changes in 3 different levels.

►► Button

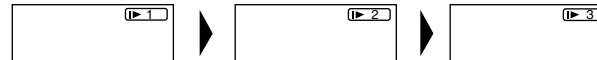

4) Press ► to return to normal playback.

Note

- Set "Still Mode" to "Field" in the "Video" menu if pictures in the slow playback mode are blurred (refer to page 31).
- Slow reverse is not available.

Step by Step Playback

BD-V BDAV DVD-V DVD-VR DivX®

1) During playback, press ■.

- Playback will pause and sound will be muted. The disc advances frame by frame each time ■ is pressed.



2) Press ► to return to normal playback.

Note

- Set "Still Mode" to "Field" in the "Video" menu if pictures in the pause mode are blurred (refer to page 31).
- Only step by step forward is available.

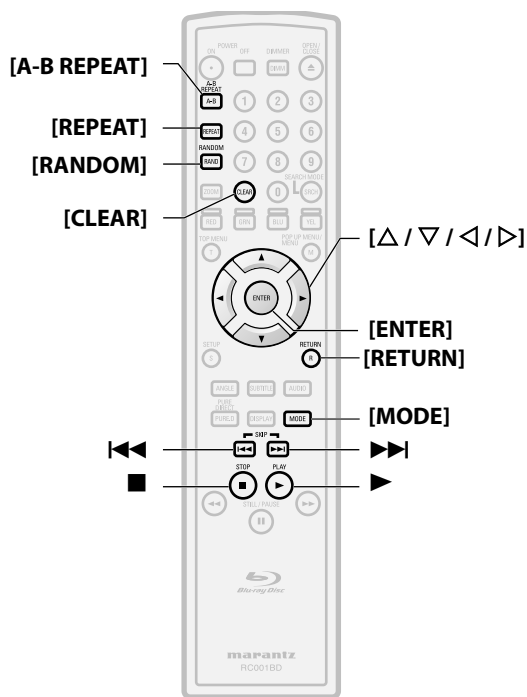
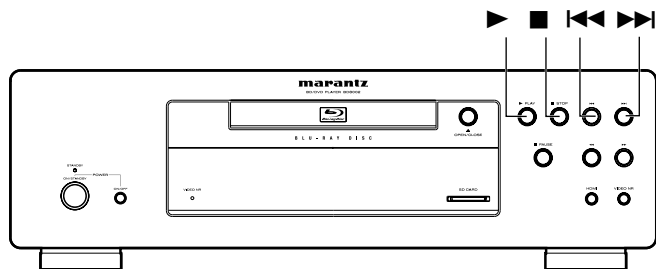

About the button names in this explanation
 < >: Buttons on the main unit
 [] : Buttons on the remote control
Button name only:
 Buttons on the main unit and remote control

Dialog Speed

BD-V BDAV DVD-V DVD-VR

This function plays back approximately at 1.3 times of normal playback while keeping the sound output. This function is available only on discs recorded in the Dolby Digital format.

- 1) During playback, press [MODE] repeatedly until the dialog speed setting appears.



- 2) Press [ENTER] or [Δ / ▽ / ◀ / ▶] to switch ♪♪ (x1.3), or off.
 "Off" : Plays back in normal speed.
 "♪♪" : Plays back approximately at 1.3 times of normal playback.

- 3) Press ▶ to return to normal playback.

Note

- Every time you press ■, the setting will be turned "Off".
- Subtitle can be viewed during this function.
- Picture adjustment, and audio language setting cannot be changed during this function.
- Virtual surround does not function during this function.
- This function may not work at some points on a disc.
- During this function, Multi/2ch LPCM will be output from HDMI output, 2ch LPCM will be output from digital audio output, or 2ch analog sound will be output from analog audio out.

Repeat Playback

Available repeat function may vary depending on the discs.

- 1) During playback, press [REPEAT] repeatedly until desired repeat mode appears on the screen.

The following repeat modes are available.

Repeat mode	Available media
Chapter repeat The current chapter will be played back repeatedly.	BD-V BDAV DVD-V DVD-VR
Title repeat The current title will be played back repeatedly.	BD-V BDAV DVD-V DVD-VR
Track repeat The current track or file will be played back repeatedly.	CD MP3 WMA JPEG DivX®
Group repeat The current folder will be played back repeatedly.	MP3 WMA JPEG DivX®
All repeat All titles, tracks or files in the media will be played back repeatedly.	BDAV DVD-VR CD MP3 WMA JPEG DivX®

A-B Repeat

BD-V BDAV DVD-V DVD-VR CD DivX®

Desired section can be played back repeatedly.

- 1) Press [A-B REPEAT] at the desired starting point A.
- 2) Press [A-B REPEAT] at the desired ending point B.
 - The repeat sequence begins.
- 3) Press [A-B REPEAT] to exit the sequence.

Playback

Note

- The chapter/title/track/group repeat setting will be cleared when moving to other chapter, title, track/file or folder.
- Repeat playback does not function during A-B repeat playback.
- Repeat chapter/title is not available with some scenes.
- A-B Repeat can only be set within the current title or current track/file.
- A-B Repeat is not available with some scenes.
- To cancel the A point which was set, press **[CLEAR]**.
- A-B Repeat playback does not function during chapter, title, track, group or all repeat playback.
- For some DivX[®] files, A-B Repeat playback may not function.

Program Playback

CD **MP3** **WMA** **JPEG**

You can program the disc to play back in your desired order.

1) In stop mode, press **[MODE]**.

- The program screen will appear.

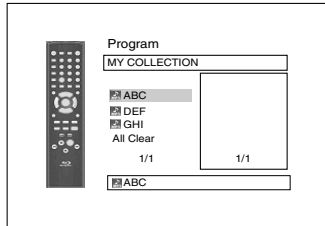
2) Use **[Δ / ▽]** to select a track/file, then press **[ENTER]**.

<Example : MP3>

- For MP3, Windows Media™ Audio, and JPEG, use **[Δ / ▽]** to select a folder, then press **[ENTER]** first, and then use **[Δ / ▽]** to select a track/file, then press **[ENTER]**.
- Press **[CLEAR]** to erase the last track/file of the program.
- Select "All Clear" at the bottom of the list to erase all the tracks/files in the program.
- The programmed track/file is displayed in the right hand screen.
- If the entire program cannot be displayed on the screen, "▼" or "▲" appears.
- Use **[◀ / ▶]** to go back forward between the hierarchy of folders.
- If eight or more tracks/files were set in a program, use the **◀◀ / ▶▶** to see all the tracks/files.

3) Press **▶** to start program playback.

- Program playback will start.

Note

- During the program playback, press **■** once to set the resume point, and then press **▶** to resume the program playback from where **■** was pressed (audio CD) or from beginning of the file where **■** was pressed (MP3, Windows Media™ Audio, or JPEG).
- During the program playback, press **■** twice to display the program screen. To go back to the normal program playback, press **[RETURN]** to exit from the program screen, then press **▶**.
- Your program is still stored until either the disc tray is open or power is turned off.
- Up to 99 tracks/files can be entered.
- To repeat the current track/file in the program, press **[REPEAT]** repeatedly until "**↺** Track" appears during playback. To repeat the entire program press **[REPEAT]** repeatedly until "**↺** All" appears during playback.
- Even if an inserted disc contains mixed MP3, JPEG and Windows Media™ Audio files, program function allows 99 files in combination of MP3, JPEG and Windows Media™ Audio files.
- The current selected number on the front panel display blinks while setting the program playback.
- "F***" is displayed in the front panel display while selecting the folder. (***) is folder number., and file is displayed as "_****" after the folder indication.
- Playback from a desired track/ file and random playback are not available during program playback.

Random Playback

CD **MP3** **WMA** **JPEG**

This function shuffles the play back order of tracks/files.

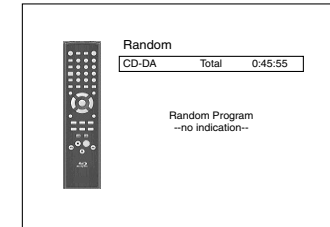
1) In stop mode, press **[RANDOM]**.

<Example: audio CD>

2) Press **▶** to start random playback.**Note**

- During the random playback, press **■** once to set the resume point, and then press **▶** to resume the random playback from where **■** was pressed (audio CD) or from beginning of the file where **■** was pressed (MP3, Windows Media™ Audio, or JPEG).
- During the random playback, press **■** twice to display the random playback screen. To cancel the random playback, press **[RANDOM]** when the random playback screen is displayed.
- To repeat the current track/file in the random selection, press **[REPEAT]** repeatedly until "**↺** Track" appears during playback. To repeat the entire random selection press **[REPEAT]** repeatedly until "**↺** All" appears during playback.
- You cannot go back to the previous track/file during random playback.
- For a disc containing mixed MP3, JPEG and Windows Media™ Audio files, random playback of those files will be performed.
- "RAND" is displayed on the front panel display.

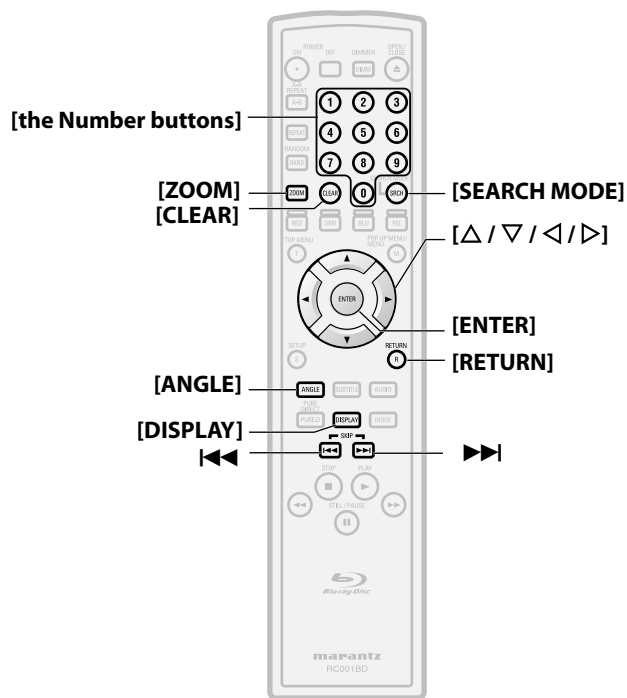
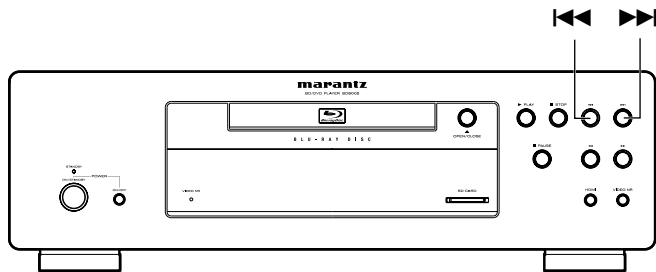

About the button names in this explanation
 < >: Buttons on the main unit
 [] : Buttons on the remote control unit
Button name only:
 Buttons on the main unit and remote control unit

Zoom

DVD-V DVD-VR JPEG DivX®

This function allows you to enlarge the video image and to pan through the zoomed image.

- 1) Press **[ZOOM]** during playback.
 - Playback will continue.
- 2) Press **[ZOOM]** repeatedly to select a desired zoom factor: **x1.2, x1.5, x2.0, x4.0** or off.
 - “x4.0” zoom is not available for JPEG and DivX®.

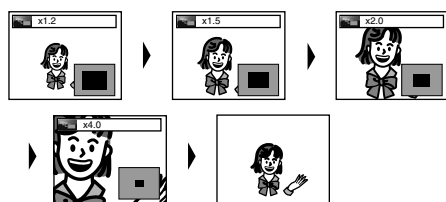

- 3) Use **[Δ / ▽ / ◀ / ▶]** to move the zoomed picture across the screen.

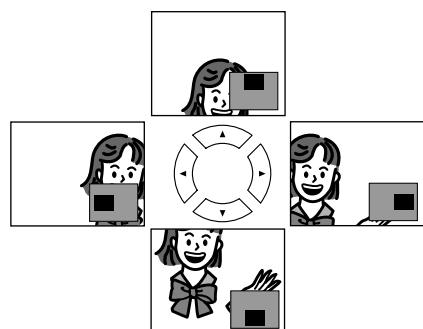

- 4) Press **[ZOOM]** to exit zoom mode.

Note

- For BD, zoom function is not available.
- Zoom function does not work while disc menu is shown.
- Navigation screen is not available on JPEG.
- You cannot pan through the zoomed picture on some JPEG files.
- For some DVD, “x4.0” zoom is not available.
- For DivX® files with small image, zoom function is not available.
- For DivX®, depends on the size of the image, some zoom factor may not be available.

Camera Angle

BD-V DVD-V

Some BD and DVD contain scenes which have been shot simultaneously from various angles. You can change the camera angle when  appears on the screen.

- 1) Press **[ANGLE]** during playback.
 - The selected angle will be displayed on the display bar at the top of the screen.
- 2) Use **[Δ / ▽]** to select your desired angle.

Note

- If the “Angle Icon” setting is “Off” in the “Others” menu,  will not appear. Refer to page 37.

Search

Using [◀◀ / ▶▶]

- 1) Press **[▶▶]** to skip to the next chapter, track or file during playback. To go back to the previous chapter, track or file, press **[◀◀]** twice in quick successions.

Note

- If title contains no chapters, **[◀◀ / ▶▶]** changes the title.

Using [SEARCH MODE]

By using the **[SEARCH MODE]**, you can select following search options.

Search mode	Available media
Title / Chapter search	BD-V BDAV DVD-V DVD-VR
Track Search	CD MP3 WMA JPEG DivX®
Time Search	BD-V BDAV DVD-V DVD-VR CD DivX®
Marker Search	BD-V BDAV DVD-V DVD-VR CD

Playback

- 1) **Select a type of search by pressing [SEARCH MODE].**
 - Every time you press [SEARCH MODE], type of search changes.
- 2) **Enter the desired chapter, track, file, title number or time to search for using [the Number buttons].**
 - Chapter, title, track or time search will start.

Note

- During program and random playback, search functions are not available except the search using ◀◀ / ▶▶.
- Time search function is available only in the same track, file or title.
- For some DivX® files, time search may not function.
- For BD, chapter and time search are available only during playback.

■ Marker search

This feature allows you to assign a specific point on a title or track to be called back later.

- 1) **During playback, press [SEARCH MODE] repeatedly until marker setting appears.**
- 2) **Use [◀ / ▶] to select a marker number (1-9).**



- 3) **When the disc reaches the point you want to set a marker, press [ENTER].**
 - The title or track and elapsed playback time will appear on the screen.
- 4) **Press [SEARCH MODE] or [RETURN] to exit.**
- 5) **To return to the marker later, call the marker setting by pressing [SEARCH MODE] repeatedly during playback or in stop mode, and use [◀ / ▶] to choose a desired marker, then press [ENTER].**

Note

- Opening the disc tray, turning off the power or selecting "AC" at step 2 and pressing [ENTER] will erase all markers.
- To clear a marker, use [◀ / ▶] to select the marker number to be cleared and press [CLEAR].
- You can mark up to 9 points.
- For BD-video, marker search between different titles is not available.
- For BD, you can return to the maker only during playback.

On-Screen Display

You can check information about the current disc by pressing [DISPLAY].

To call the On-Screen Display, press [DISPLAY] during playback. Each time you press [DISPLAY], the information changes. Depending on the media, available information varies.

BD-V BDAV

OFF → Title/Chapter information → Title information(elapsed time) → Title information(remaining time) → HDMI information → OFF

DVD-V DVD-VR

OFF → Chapter information (elapsed time) → Chapter information (remaining time) → Title information (elapsed time) → Title information (remaining time) → Bit rate information → HDMI information → OFF

CD

OFF → Track information (elapsed time) → Track information (remaining time) → Disc information* (elapsed time) → Disc information* (remaining time) → HDMI information → OFF
 (*not available during the program/random playback)

MP3 JPEG

OFF → File name information → File information (elapsed time*) → HDMI information → OFF
 (*not available for JPEG)

WMA

OFF → File name information → Tag information (title name) → Tag information (artist name) → File information (elapsed time) → HDMI information → OFF

DivX®

OFF → File name information → File information (elapsed time) → File information (remaining time) → HDMI information → OFF

- For audio CD, MP3, Windows Media™ Audio and JPEG, during the program or random playback, the indication will be displayed after the track/file information.

■ Chapter information

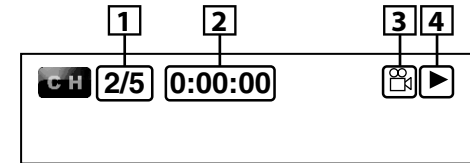

<Title / Chapter information for BD>

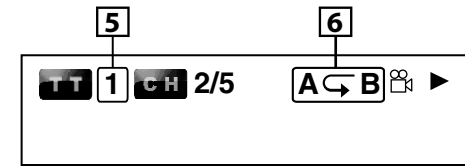

1. **Current chapter number/total number of chapters**
2. **Elapsed time/remaining time of the current chapter**
3. **Indicates that the multi camera angle images are available on the scene (For BDAV mode BD-RE/-R, the type of title (ORG: original, PL: playlist) will be displayed)**
4. **Current playback status**
5. **Current title number**
6. **Current repeat setting (Only when repeat setting is active) (C: Chapter repeat, T: Title repeat, AB : A-B repeat)**

■ Title information

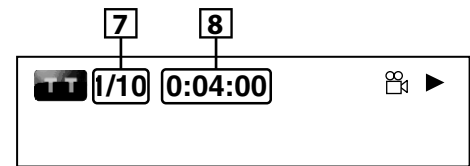

7. **Current title number/total number of titles**
8. **Elapsed time/remaining time of the current title**

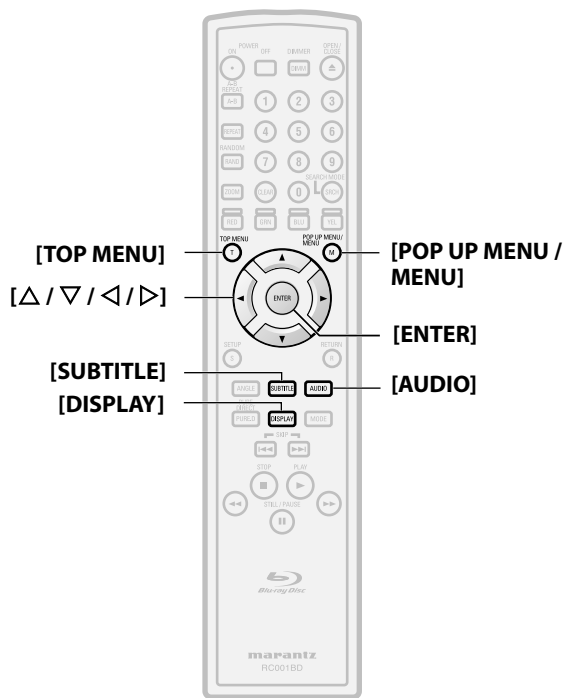
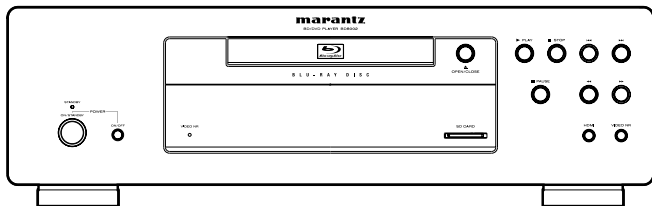

About the button names in this explanation
 < >: Buttons on the main unit
 [] : Buttons on the remote control
Button name only:
 Buttons on the main unit and remote control

Bit rate information

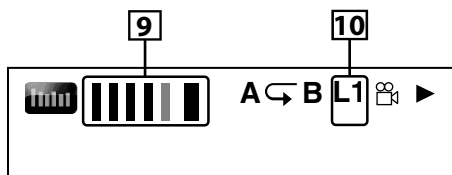

<For VR mode DVD-RW/-R>

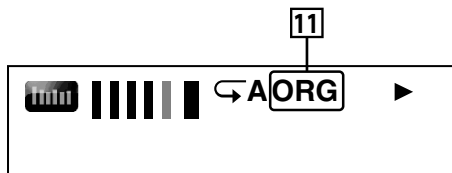

- 9. Bit rate (the amount of video data currently being read)
- 10. Layer number (Only for 2-layered discs)
(L0: Layer 0 is played back. L1: Layer 1 is played back)
- 11. Type of title (ORG: original, PL: playlist)

Track/File information

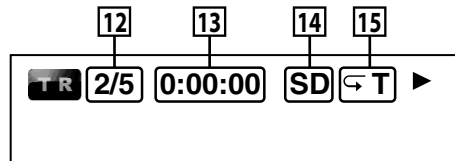

- 12. Current track (file) number/total number of track (file)
- 13. Elapsed time/remaining time of the current track (file)
- 14. Indication of SD Memory Card playback
- 15. Current repeat setting (Only when repeat setting is active)
(T: Track/file repeat, G: Group repeat, A: All repeat)

Disc information

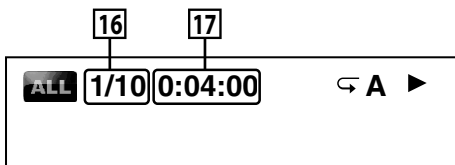

- 16. Current track number/Total number of tracks
- 17. Elapsed time/remaining time of the current disc

File name information

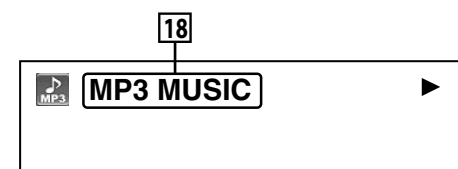

18. Media icon and File name

- : MP3 file
- : Windows Media™ Audio file
- : JPEG file
- : DivX® file

Tag information

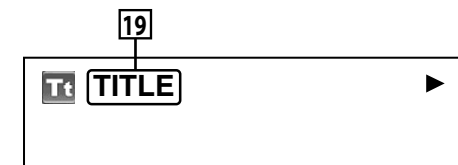

[DISPLAY]



- 19. Title name based on tag information of current Windows Media™ Audio file
- 20. Artist name based on tag information of current Windows Media™ Audio file

HDMI information

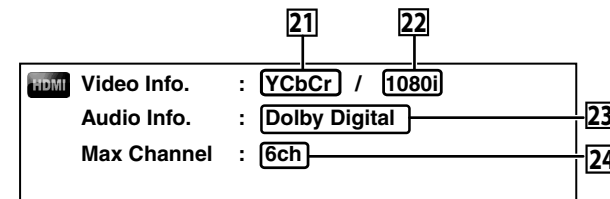

Playback

21. HDMI video format
22. Resolution of the HDMI output image
23. HDMI audio format
24. Maximum numbers of audio channels that can be accepted by the connected device

Note

- If HDMI is not connected, "----" will be displayed for HDMI information.

Selecting the Format of Audio and Video

Selecting Audio Streams/Channels

BD-V **BDAV** **DVD-V** **DVD-VR** **CD** **DivX®**

Some BD and DVD contain multiple audio streams. Those are often in different audio languages or audio formats. For BD available audio varies depends on the "BD Audio Mode" setting. Refer to page 23 for more information.

■ **BD-V**

- 1) During playback, press [AUDIO].
- 2) Use [△ / ▽] to select "Primary" or "Secondary" audio to set, then press [ENTER].

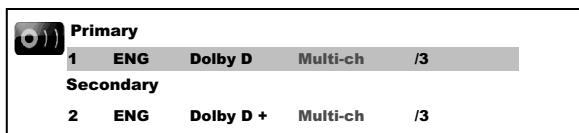

"Primary" : Sets the audio for the main picture.

"Secondary" : Sets the audio for the sub-picture. When sub-picture is on, the "Secondary" audio will be output with the sub-picture.

- In order to listen to the secondary audio, the "BD Audio Mode" must be set to "Mix Audio Output". Refer to page 23.

- 3) Use [△ / ▽] to select your desired audio stream/channel.
- 4) Press [AUDIO] to exit.

■ **BDAV** **DVD-V** **DVD-VR** **CD** **DivX®**

- 1) During playback, press [AUDIO].
- 2) Use [△ / ▽] to select your desired audio stream/channel.

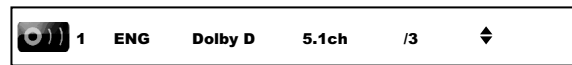

- For audio CD, you can select following options.

"Stereo" : Both right and left channels are active (stereo)

"L-ch" : Only left channel is active

"R-ch" : Only right channel is active

- 3) Press [AUDIO] to exit.

Note

- For BDAV mode BD-RE/-R and VR mode DVD-RW/-R with MTS (Multi-channel Television Sound) system, you can switch between "1.Main" (main audio), "1. Sub" (sub audio), and "1.Main/Sub" (main and sub audio).
- For some BD, secondary audio will be output even when sub-picture is off.
- The sound mode cannot be changed during playback of discs not recorded in multiple sound.
- Some discs allow to change audio language setting on the disc menu. (Operation varies between discs. Refer to the manual accompanying the disc.)
- Pressing [AUDIO] may not work on some discs with multiple audio Streams/Channels (e.g. DVD which allow to change audio setting on the disc menu).
- If you choose a language that has a 3-letter-language code, the code will be displayed every time you change the Audio Language setting. If you choose any other Languages, "----" will be displayed instead (refer to page 39).
- Audio Language selection cannot be made during dialog speed (refer to page 17).
- If the disc has no audio language, "Not Available" will be displayed.
- For discs with DivX® files, only MP3, MP2 or Dolby Digital audio is displayed. Other audio will be displayed with "----".
- For DTS-CD(5.1 music disc), selecting audio streams or channels is not available.

Playback

Selecting Subtitle Language

BD-V **DVD-V** **DivX®**

BD, DVD-video and DivX® may have subtitles in 1 or more languages. Available subtitle languages can be found on the disc case. You can switch subtitle languages anytime during playback.

■ **BD-V**

- 1) During playback, press [SUBTITLE].
- 2) Use [△ / ▽] to select "Primary Subtitle", "Secondary Subtitle" or "Subtitle Style", then press [ENTER].

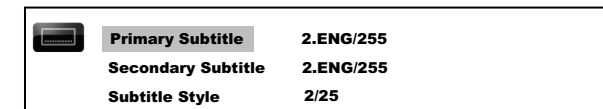

"Primary Subtitle": Sets the subtitle for the main picture.

"Secondary Subtitle": Sets the subtitle for the sub-picture.

"Subtitle Style": Sets style of the subtitle.

- 3) Use [△ / ▽] to select your desired subtitle.
- 4) Press [SUBTITLE] to exit.

■ **DVD-V** **DivX®**

- 1) During playback, press [SUBTITLE].
- 2) Use [△ / ▽] to select your desired subtitle.



- 3) Press [SUBTITLE] to exit.

Note

- Some discs will only allow you to change the subtitle from the disc menu. Press [TOP MENU] or [POP UP MENU / MENU] to display the disc menu.
- If 4 digit language code appears in the subtitle menu, refer to "Language Code" on page 39.
- If the disc has no subtitle language or subtitle style, "Not Available" will be displayed.
- For DivX®, the screen only displays the number of subtitle languages.

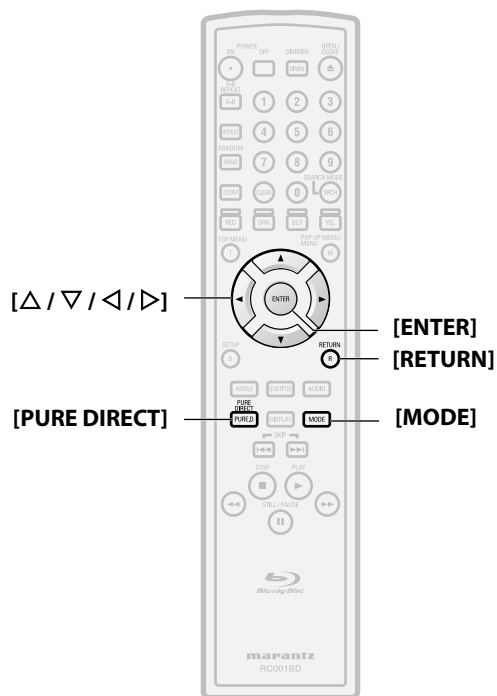
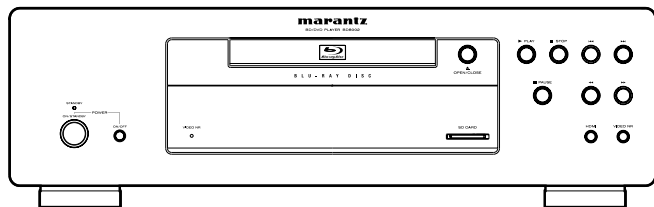

About the button names in this explanation
 < >: Buttons on the main unit
 [] : Buttons on the remote control
Button name only:
 Buttons on the main unit and remote control

Virtual Surround

BD-V BDAV DVD-V DVD-VR

You can enjoy stereo phonic virtual space through your existing 2-channel stereo system.

- 1) In stop mode, press [MODE] repeatedly until the virtual surround setting appears.



- 2) Use [Δ / ∇] to select "1" (Natural effect), "2" (Emphasized effect) or "Off".
- 3) Press [RETURN] to exit.

Note

- Select virtual surround "Off" or lower the volume if the sound is distorted.
- This function cannot be used during dialog speed (refer to page 17).
- For the virtual surround, audio signal will always be 2-channel LPCM.

Pure Direct Mode

BD-V BDAV DVD-V DVD-VR CD MP3 WMA DivX®

Use this function to shut down unused circuitry to achieve high quality analog sound.

- 1) Press [PURE DIRECT] repeatedly to select your desired pure direct mode.
 - Each time you press [PURE DIRECT], the pure direct mode changes as "Normal" → "Video Off" → "Display Off" → "All Off" → "Normal". The modes will be displayed on the front panel display.

Video / audio outputs for each mode

- "Normal"** : Normal playback mode (pure direct mode is off).
- "Video Off"** : Video signal will not be output.
- "Display Off"** : Circuitry for front panel display and indicators will be shut down.
- "All Off"** : Video signal will not be output and circuitry for front panel display and indicators will be shut down.

Note

- If you turn off the unit or put this unit to standby mode, the pure direct mode will go back to "Normal".

Setting the BD Audio Mode

BD-V

BD audio mode is to choose between two ways; you could output the secondary and interactive audio accompanied by the primary audio or you could output the primary audio only. Depending on the setting of the mode, Dolby Digital, DTS, Dolby Digital Plus, Dolby TrueHD, or DTS-HD output changes between Multi LPCM and bitstream.

- 1) In stop mode with BD inserted, press [MODE].
- 2) Use [Δ / ∇] to select desired setting.

■ "Mix Audio Output"

If it is available, BD video's secondary and interactive audio will be output with the primary audio.

- The secondary audio is the audio for the sub picture (Director's comment etc.) and the interactive audio is the audio for the interactive application (Button click sounds etc.).

■ "HD Audio Output"

Only the primary audio will be output. Set this mode in order to output Dolby Digital, Dolby Digital Plus, Dolby TrueHD, DTS or DTS-HD sound of BD through HDMI connection.

- 3) Press [RETURN] to exit.
 - You can also set "BD Audio Mode" from the setup menu. Refer to page 32.

Note

- In "Mix Audio Output" mode, even you set "HDMI Multi(Normal)" in "HDMI Audio Out" setting, multi LPCM will be output from HDMI OUT for BD audio. Refer to page 11.
- In "Mix Audio Output" mode with HDMI audio being output, 2-channel downmix LPCM will be output from DIGITAL OUT for BD audio.
- In "Mix Audio Output" mode with "HDMI Audio Out" set to "Audio Mute" and "Digital Out" set to "Bitstream", DTS, DTS-HD and LPCM will be output as Dolby Digital for BD audio. Refer to page 12.
- In "Mix Audio Output" mode, from 7.1ch AUDIO OUT, Dolby Digital Plus, Dolby TrueHD and DTS-HD will be output as multi LPCM decoded from its corresponding core stream.

Playback

Adjusting the Picture

BD-V **BDAV** **DVD-V** **DVD-VR** **DivX®**

You can adjust the picture quality and store the setting you have adjusted on memory 1-5.

1) During playback, press [MODE] repeatedly until the picture adjustment menu appears.

- Picture adjustment menu:



2) Use [Δ / ▽] to select a memory from "Memory 1" to "Memory 5" to store your setting, then press [ENTER].

3) Use [Δ / ▽] to select an item to be adjusted, then use [◀ / ▶] to adjust the setting.



- To reset to the default setting, press [RETURN], use [Δ / ▽] to select "STD", then press [ENTER].

Gamma correction

- To adjust "Gamma Correction", after selecting the item at step 3, press [ENTER], then use [Δ / ▽ / ◀ / ▶] to adjust the setting.
- In the graph of gamma correction, the horizontal axis indicates the brightness level of the image that is recorded on the disc, and the vertical axis indicates the brightness level of the image when it is output from this unit.

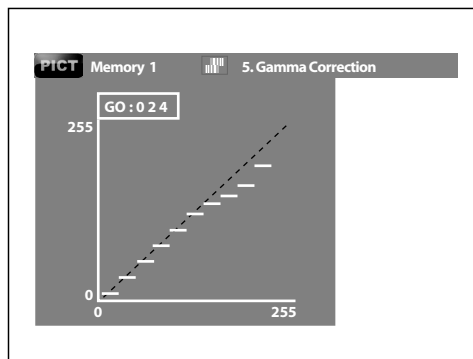

- When bright points of the disc side are adjusted to the "dark" of the output side, the fine parts of the bright portion that normally become hard to see, become an easily discerned image.

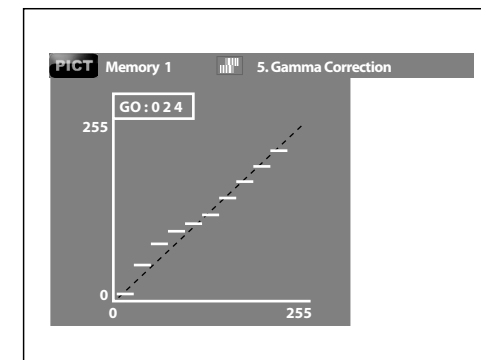

- When dark points of the disc side are adjusted to the "bright" of the output side, the fine parts of the dark portion that normally become hard to see, become an easily discerned image.

4) Press [RETURN] repeatedly to exit.

Note

- This setting is not effective for the picture output from VIDEO OUT and S VIDEO OUT jack.
- The setting remains even you turn off the unit.
- You cannot adjust the setting during the rapid playback, or when the pure direct is set to "Video Off" or "All Off".
- DNR can also be adjusted by pressing <VIDEO NR (NOISE REDUCTION)> on the front panel. (refer to page 7.)

List of picture adjustment item/values

Item	Description	Adjustment range (default)
1. Contrast	Adjusts the difference between the bright and dark parts of the picture.	-6 to +6 (0)
2. Brightness	Adjusts the brightness of the picture.	0 to +12 (0)
3. Enhancer*1	Strengthens the contours of the picture.	0 to +11 (0)
4. DNR*1	Reduces the overall level of noise on the picture.	Off to +3 (Off)
5. Gamma Correction	Detailed adjustment of the picture's brightness.	16 to 235 (G0=24/G1=32/G2=48/G3=64/ G4=80/G5=96/ G6=128/G7=160/ G8=192/G9=224)
6. Sharpness Mid*2	Adjusts the sharpness of the picture for the medium frequency range.	-6 to +6 (0)
7. Sharpness High*1	Adjusts the sharpness of the picture for the high frequency range.	-6 to +6 (0)
8. Hue*2	Adjusts the balance between the green and red.	-6 to +6 (0)
9. White Level	Adjusts the white level.	-5 to +5 (0)
10.Black Level*1	Adjusts the black level.	-5 to +5 (0)
11.Chroma Level	Adjusts the density of the colors.	-6 to +6 (0)
12.Setup Level	Makes the black parts of the pictures brighter.	0 IRE : Shows the original picture as recorded. 7.5 IRE : Makes the dark parts brighter. (7.5 IRE)
13.H_Position Control*1	Adjusts the left/right position.	-7 to +7 (0)
14.V_Position Control*1	Adjusts the top/bottom position.	-7 to +7 (0)

*1 Effective for the video signal of COMPONENT VIDEO OUT (except for 480i) and HDMI OUT jacks.

*2 Not effective for the video signal of HDMI OUT jack.

Playback

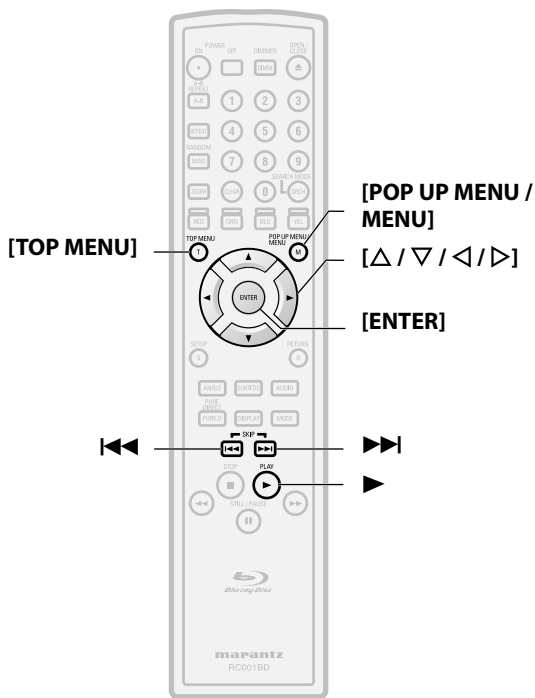
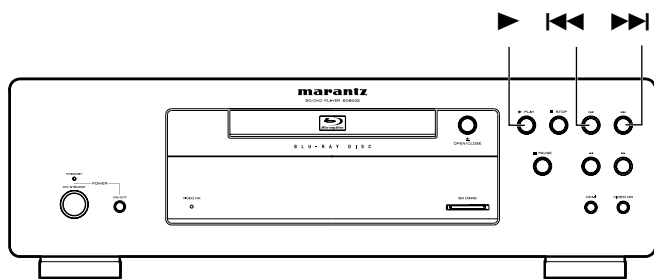

About the button names in this explanation
 < >: Buttons on the main unit
 [] : Buttons on the remote control
Button name only:
 Buttons on the main unit and remote control

Playing Back an MP3, Windows Media™ Audio, JPEG and DivX® File

MP3 **WMA** **JPEG** **DivX®**

- 1** Insert a DVD-RW/-R or CD-RW/-R with MP3, Windows Media™ Audio, JPEG, DivX® files.
 - The file list will appear on the screen.
 - If file list does not appear automatically, press [POP UP MENU / MENU].
 - Press [POP UP MENU / MENU] to exit and resume the file list.
-
- 2** Use [Δ / ▽] to select a desired folder or file, then press [ENTER]. Use [◀ / ▶] to go back and forward between the hierarchies.
 - If you press [ENTER] on the files playback will start.

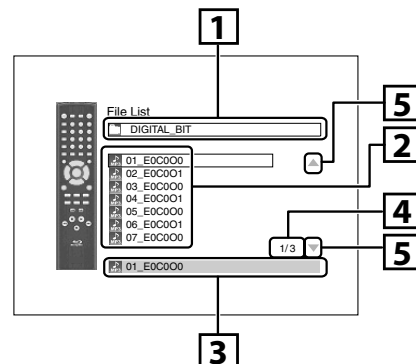

- 1. Current folder name (Disc or SD Memory Card name will be displayed for the top of the hierarchies.)**
- 2. List of the file/folder names in the current folder/disc**
- 3. Selected file/folder name**
- 4. Current page / total page number**
- 5. Indication of previous/next page**
 - Use [◀◀ / ▶▶] to go back and forward between the pages.
 - Press [TOP MENU] to return to the first item.

- Icons:**
- : Folders
 - : MP3 files
 - : Windows Media™ Audio files
 - : JPEG files
 - : DivX® files

Playback
It is recommended that files to be played back in this unit are recorded under the following specifications:

- <MP3 / Windows Media™ Audio>**
- Sampling frequency : 44.1 kHz or 48 kHz
 - Constant bit rate : 112 kbps - 320 kbps (MP3), 48 kbps - 192 kbps (Windows Media™ Audio)
- <JPEG>**
- Upper limit : 2,560 x 1,900 dots (sub sampling is 4:4:4)
5,120 x 3,840 dots (sub sampling is up to 4:2:2)
 - Lower limit : 32 x 32 dots
 - File size of image maximum : 12 MB
- <DivX®>**
 Official DivX® Certified product
- Playable codec of AVI files : DivX® 3.x, DivX® 4.x, DivX® 5.x, DivX® 6.0
 - Maximum size of image : 720 x 480 @30 fps, 720 x 576 @25 fps
 - Sampling frequency of audio : 8 kHz - 48 kHz
 - Audio type : MPEG1 audio layer 3 (MP3), MPEG1 audio layer 2, Dolby Digital

Note

- The system can recognize up to 255 folders/999 files for CD, 999 folders/9999 files for DVD and SD Memory Card.
- The name of folder and file can be displayed up to 28 characters. Unrecognizable characters will be replaced with asterisks.
- The 9th and deeper hierarchies cannot be displayed for CD and the 10th and deeper hierarchies cannot be displayed for DVD and SD Memory Card.
- Files whose extension is other than ".mp3(MP3)", ".wma(Windows Media™ Audio)", ".jpg / .jpeg(JPEG)" or ".avi / .divx" will not be listed.
- Some unplayable folders or files may be listed due to the recording status.
- High-resolution JPEG files take longer to be displayed.
- Progressive JPEG files (JPEG files saved in progressive format) cannot be played back on this unit.
- This unit recognize up to 8 characters of file name in the SD Memory Card. Characters after 9th will not be displayed.

Playback

To Play Back the DivX® Subtitle Created by the User.

The subtitle created by the user can be displayed during DivX® playback.

- 1) After selecting the DivX® file, the “Subtitle List” will appear when “DivX Subtitle” is set to anything other than “Off”. (Refer to page 30.)
- 2) Use [Δ / ▽] to select the desired extension you want to display, then press [ENTER].

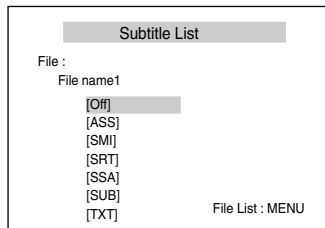

DivX® with the subtitle starts playback. The subtitle cannot be displayed when the setting is “Off”.

- If there is more than one extension, the extension selection appears in the subtitle list.
- If you insert a DVD-RW/-R, CD-RW/-R with DivX® files that are mixed with MP3/Windows Media™ Audio/JPEG files, the playback media selection screen will be displayed. Use [Δ / ▽] to select your desired media to play back then press [ENTER].

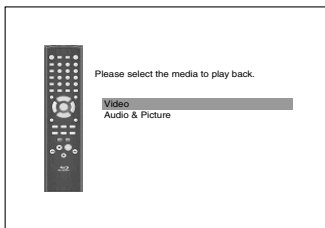

- Press [TOP MENU] to call up the playback media selection screen in stop mode.

Hint for the purchased or rental official DivX® Certified product

- When you purchased or rented a DivX® file through the official site of DivX® video which is called DivX® Video-On-Demand (VOD) services, a registration code is required every time you get the new file from the DivX® VOD services. Refer to “DivX(R) VOD” on page 37.
- Some DivX® VOD files are restricted with the limited playable times (you cannot play them back beyond the limit). If your DivX® VOD file has such limit, the playback confirmation screen will appear.
- Use [◀ / ▶] to select “Yes” if you want to play back the file, or to select “No” if you do not wish to play it back. Then, press [ENTER] to confirm the selection.
- You cannot play back the DivX® VOD files, of which rental period has been expired. In such case, press [POP UP MENU / MENU] and select other files that can be played back.
- You cannot play back the DivX® VOD files obtained with different registration codes on this unit. Press [POP UP MENU / MENU] and select other files that can be played back.
- You cannot playback the DivX® file that has the resolution which this unit does not support. This unit does not support the DivX® files that have the image size that exceeds 720 x 480 @ 30fps or 720 x 576 @ 25fps.

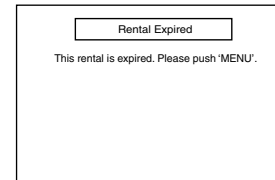
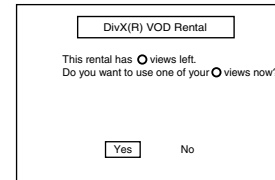

Playback

What is DivX®?

- DivX® is a codec (compression/decompression) that can compress images to a very small amount of data. The software can compress video data from almost any devices to the size that can be sent on the Internet without compromising visual quality of the images.
- A file with an extension of “.avi” and “.divx” is called an DivX® file. All files with the DivX® extension are recognized as MPEG4.
- For more information for DivX®, please visit <http://www.divx.com>.

Note for DivX®

- Even if the file has an extension of either “.avi” and “.divx”, this unit cannot play it back if it is recorded in the format other than DivX®.
- It may take a while for audio and images to be output after you inserted a disc and pressed ▶.
- When playing back the files recorded in high bit rates, the images can be interrupted in some occasions.
- Although DivX® logo has been obtained for this unit, it may not be able to play back some data, depending on the characteristics, bit rates, or audio format settings, etc.
- A DivX® file whose file size exceeds 2 GB cannot be played back.
- If a large-sized DivX® file is selected, it may take awhile to start the playback (over 20 seconds sometimes).
- If you try to playback the DivX® file that has the screen resolution which this unit does not support, the playback will be stopped and error message will appear.
- Some DivX® files cannot be played back on this unit due to the configuration and characteristics of the disc, or due to the condition of recording and authoring software.
- Multi-session burn DivX® DVD cannot be played back on this unit.

Note for DivX® Subtitle

- To utilize this function, the following conditions must meet.
 - “DivX Subtitle” must be activated in “Language” setting. (Refer to “DivX Subtitle” on page 30.)
 - Playback file and the subtitle file must have the same name.
 - Playback file and the subtitle file must locate in the same folder.
 - Only the subtitle files with the following extensions are supported; .smi (.SMI), .srt (.SRT), .sub (.SUB), .ass (.ASS), .ssa (.SSA), .txt (.TXT). (.sub (.SUB) and .txt (.TXT) files may not be recognized.)
 - The subtitles that exceeds the playback time of the DivX® file will not be displayed.

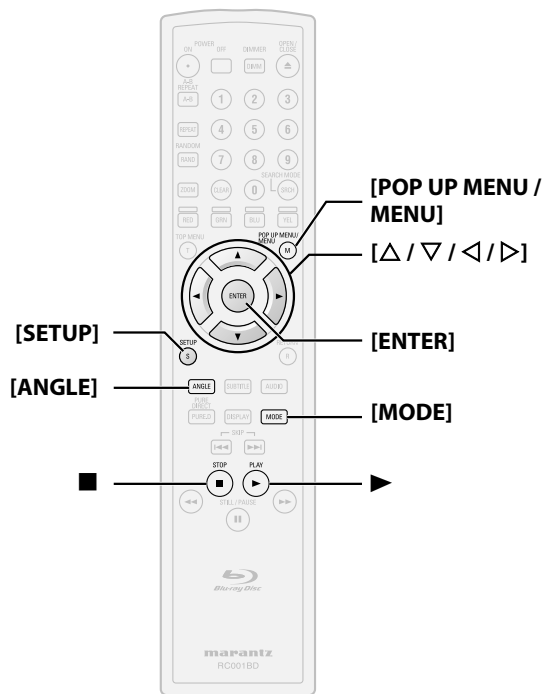
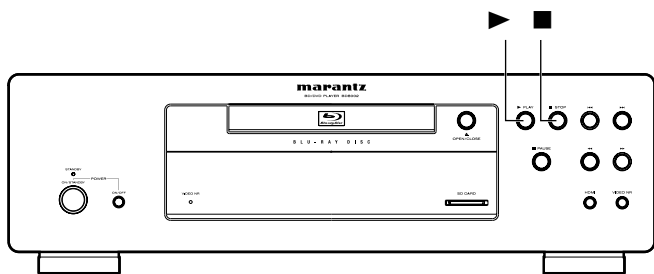

About the button names in this explanation
 < > : Buttons on the main unit
 [] : Buttons on the remote control
Button name only:
 Buttons on the main unit and remote control

Kodak Picture CD

JPEG

This unit can also run JPEG files stored on Kodak Picture CD. You can enjoy picture images on the display device set by playing back the Picture CD. This unit confirms to ver.7.0 of Kodak Picture CD. For details of Kodak Picture CD, contact a shop that provides developing service of Kodak Inc.

1 When Kodak Picture CD is inserted in this unit, Kodak Picture CD menu appear automatically on the screen.

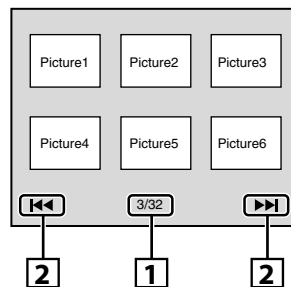

- 1. Current track number/the total number of tracks**
- 2. Indication of previous/next page**
 - In stop mode, press [POP UP MENU / MENU] to call Kodak Picture CD menu.

2 Use [Δ / ▽ / ◀ / ▶] to select a desired track to be played back, then press ▶ or [ENTER].

- An image will be played back from the selected track and go to the next one in turn.

3 Press ■ to stop playback.

Tips for JPEG/Kodak Picture Playback

- Every press on [ANGLE] will turn the image clockwise by 90 degrees when an image is displayed.
- To change the visual effect for switching the playback image, press [MODE] once, then use [Δ / ▽] or [ENTER] to switch between "Cut In/Out" and "Fade In/Out". The size change may have no effect on some files (e.g. files with a small picture size).
- To change the size of the playback image, during the JPEG/Kodak Picture playback. Press [MODE] twice, then use [Δ / ▽ / ◀ / ▶] or [ENTER] to switch between "Normal" (100%) and "Small" (93%). The size change may have no effect on some files (e.g. files with a small picture size).

Reading the SD Memory Card

MP3 WMA JPEG

You can play back the MP3, Windows Media™ Audio and JPEG files in an SD Memory Card. With the SD Memory Card, you can also enjoy the special additional contents for BD-ROM Profile 1.1 which can be downloaded from the internet. You can store the contents on an SD Memory Card via computer and play them back with the BD-video. For more information about the special additional contents, please refer to the instruction book that came with the disc.

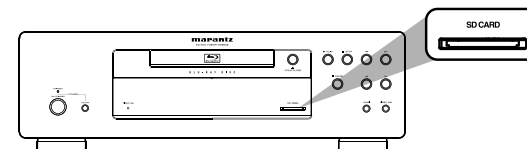

Setting the media mode

- 1** Press [SETUP] in stop mode.
- 2** Use [◀ / ▶] to select **CUSTOM**, then press [ENTER].
- 3** Use [◀ / ▶] to select **Other**, then press [ENTER].
- 4** Use [Δ / ▽] to select "Media Select".
- 5** Press [ENTER] repeatedly to select "SD Memory".

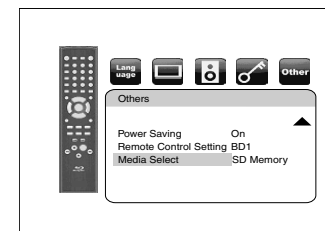

• This will set the unit to "SD Memory" mode. To play back the contents in any discs, exit "SD Memory" mode by selecting "Disc".

6 Press [SETUP] to exit.

Playback

■ Inserting the SD Memory Card and playback

- 1** Insert an SD Memory Card into the SD CARD slot until it clicks with the label facing up.
File list will appear.

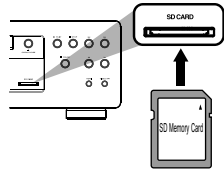

-
- 2** Follow the step 2 in “Playing Back an MP3, Windows Media™ Audio, JPEG and DivX® File” on page 25.

■ Removing the SD Memory Card

- 1** In stop mode, push the SD Memory Card and then slowly remove your finger.

-
- 2** Grasp the card and pull it out from the SD CARD slot.

Compatible Cards:

- SD Memory Card (8MB - 2GB)
- SDHC Memory Card (4GB)
- miniSD Card (8MB - 2GB)
- microSD Card (8MB - 2GB)
- For miniSD Card and microSD Card, adapter will be required.

Note

- Do not remove the card during its playback.
- This unit supports SD Memory Card with FAT12/FAT16 file system, and SDHC Memory Card with FAT32 file system.
- Do not delete the folders or files in the SD Memory Card with your computer. This unit might not read the SD Memory Card.
- This unit recognizes up to 8 characters of file name in the SD Memory Card. Characters after 9th will not be displayed.

Function Setup

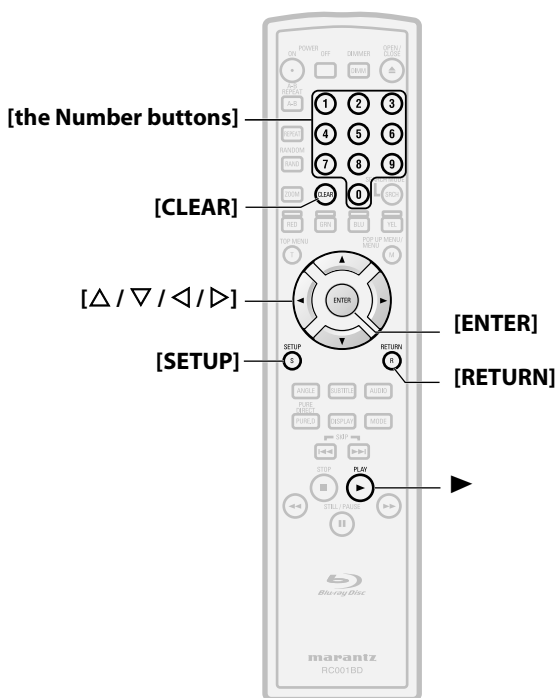
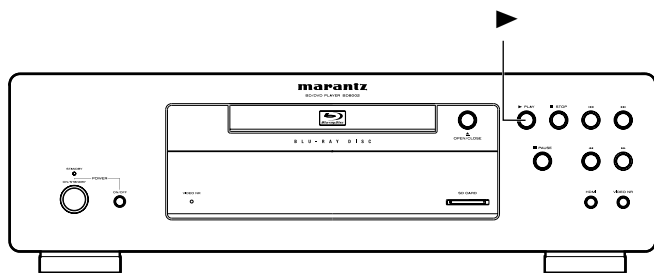

About the button names in this explanation
 < >: Buttons on the main unit
 [] : Buttons on the remote control
Button name only:
 Buttons on the main unit and remote control

Using the Setup Menu

In the setup menu you can change the setting for audio, video, language, etc. You cannot change the setting during playback.

Quick

Quick setting menu contains setting items extracted from custom setting menu which may be used frequently.

- 1 Press [SETUP] in stop mode.
- 2 Use [◀/▶] to select **QUICK**, then press [ENTER].

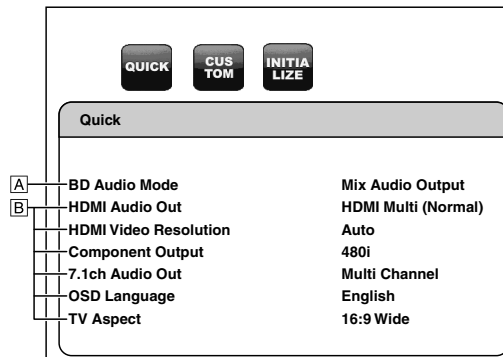

- 3 Use [△/▽] to select setting items.
- 4 Follow the procedure below depending on the setting items.
For setting item A:
 Press [ENTER] repeatedly to change options.
For setting item B:
 1) Press [ENTER].
 2) Use [△/▽] to select options, then press [ENTER].
 • Use [◀] or [RETURN] to go back to the previous screen.

5 Press [SETUP] to exit.

Custom

Custom menu contains all the setting items.

- 1 Press [SETUP] in stop mode.
- 2 Use [◀/▶] to select **CUS TOM**, then press [ENTER].
- 3 Use [◀/▶] to select your desired setting category, then press [ENTER].
Lang: Language **VID**: Video **AUD**: Audio **RAT**: Ratings
Other: Others
 • For "Ratings", follow the procedure on page 36.
- 4 Use [△/▽] to select setting items.
 • The setting items which are not available with current situation of this unit will be displayed in gray and you cannot select the items.
- 5 Follow the procedure below depending on the setting items.
For setting item A:
 Press [ENTER] repeatedly to change options.
 • For "DivX(R) VOD", press [ENTER] to display your registration code.
For setting item B:
 1) Press [ENTER].
 2) Use [△/▽] to select options, then press [ENTER].
 • Use [◀] or [RETURN] to go back to the previous screen.
- 6 Press [SETUP] to exit.

Function Setup
Language

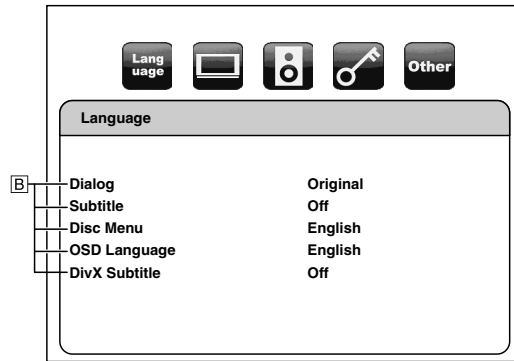

• For how to select the setting items and options, refer to “Custom” on page 29.

Setting items	Options
Dialog Sets the language for audio.	Original*/English/French/Spanish/German/Italian/Swedish/Dutch/Russian/Chinese/Japanese/Korean/Danish/Finnish/Norwegian/Icelandic/Hungarian/Romanian/Turkish/Greek/Irish/Portuguese/Polish/Czech/Slovak/Bulgarian/Other
Subtitle Sets the language for subtitle.	Off*/English/French/Spanish/German/Italian/Swedish/Dutch/Russian/Chinese/Japanese/Korean/Danish/Finnish/Norwegian/Icelandic/Hungarian/Romanian/Turkish/Greek/Irish/Portuguese/Polish/Czech/Slovak/Bulgarian/Other
Disc Menu Sets the language for disc menu.	English*/French/Spanish/German/Italian/Swedish/Dutch/Russian/Chinese/Japanese/Korean/Danish/Finnish/Norwegian/Icelandic/Hungarian/Romanian/Turkish/Greek/Irish/Portuguese/Polish/Czech/Slovak/Bulgarian/Other
OSD Language Sets the language for OSD (on-screen display).	English*/Français/Español
DivX Subtitle Sets the language for DivX® Subtitle.	Off* / English / French / Spanish

- Settings with (*) are the default.
- Quick menu consists of the setting menus frequently used, and they are accompanied with mark.
- If you select “Other”, enter the 4-digit number code for the desired language (refer to “Language Code” on page 39). Only the languages supported by the disc can be selected.

Function Setup

Video

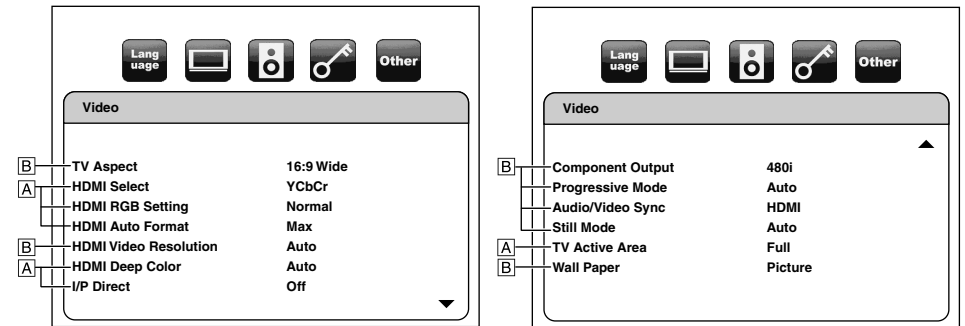

• For how to select the setting items and options, refer to “Custom” on page 29.

Setting items	Options
TV Aspect Sets a picture size according to aspect ratio of the connected display device.	16:9 Wide*: Select this when a wide-screen TV is connected. Disc recorded in wide screen format is played over the entire screen. 4:3 Pan & Scan: Select this to play back the disc recorded in wide screen format with 4:3 TV in the pan & scan mode (with the sides of the picture cut off). Discs which pan & scan is not specified are played in the letter box mode. 4:3 Letter Box: Select this to play back the disc recorded in wide screen format with 4:3 TV in the letter box mode. (with black strips at the top and bottom). 4:3 Squeeze Auto: When playing 4:3 images, the picture is displayed in the center of the 16:9 screen with a 4:3 aspect ratio. 4:3 Squeeze On: The picture is displayed in the center of the 16:9 TV screen with a 4:3 aspect ratio, regardless of the original image size.
HDMI Select Select an HDMI output mode between “YCbCr” and “RGB”.	YCbCr*: Component format video signals and audio signals are output from the HDMI OUT. RGB: RGB format video signals and audio signals are output from the HDMI OUT.

Function Setup



Setting items	Options
HDMI RGB Setting Sets the digital RGB image range (data range) output from the HDMI OUT.	Normal*: Output as "16 (black)" to "235 (white)". Enhanced: Output as "0 (black)" to "246 (white)". Depending on the display device you are using, the black colors may seem to stand out when using HDMI connections. If so, set to "Enhanced".
HDMI Auto Format Makes the setting of the "Auto" for "HDMI Video Resolution".	Max*: The maximum resolution that can be input to the connected HDMI device is detected and the HDMI output resolution is selected automatically. Panel: The number of pixels of the connected HDMI device's panel is detected and the HDMI output resolution is selected automatically.
HDMI Video Resolution  Sets the HDMI video resolution.	Auto*: HDMI video resolution will be selected automatically depending on the connected HDMI device and setting of the "HDMI Auto Format". 480p 720p 1080i 1080p 1080p24: Gives a natural and high quality film reproduction of 24-frame film material. The connected display device has to be compatible with 1080p24 frame input.
HDMI Deep Color Sets whether output the picture from HDMI with the Deep Color or not.	Auto*: The picture through the HDMI will be output with Deep Color if connecting device supports Deep Color. Off: The picture through the HDMI will be output without Deep Color.
I/P Direct Sets whether output the 24-frame material directly from the HDMI OUT or not. This setting is for BD only.	Off*: 24 frame material will be converted to 60 frame and output 1080p60 frame from the HDMI OUT. On : 24 frame material will be output directly 1080p24 frame from the HDMI OUT.

Function Setup

Setting items	Options
Component Output Sets the video resolution for component output.	480i* 480p 720p 1080i
Progressive Mode Sets the optimum progressive mode for the image material output from HDMI OUT jack and COMPONENT VIDEO jacks.	Auto*: The progressive mode will be selected automatically depends on the material type (film or video). Video1: Suited for playing video material discs. Video2: Suited for playing video material discs and 30-frame film material discs.
Audio/Video Sync Sets which video signal to synchronize the audio signal with.	HDMI*: Synchronizes the audio with the video signal from HDMI OUT. Progressive: Synchronizes the audio with the progressive video signal from COMPONENT VIDEO OUT. Interlace: Synchronizes the audio with the Interlace video signal from COMPONENT VIDEO OUT(480i), VIDEO OUT or S VIDEO OUT. Other: Select this when you want to view progressive, interlaced and HDMI pictures simultaneously. The audio signals are set to the optimum timing for the respective pictures. (They are not synchronized.)
Still Mode Adjusts picture resolution and quality in still mode.	Auto*: Automatically selects the best resolution setting ("Frame" or "Field") based on the data characteristics of the pictures. Field: Stabilizes the pictures, although the picture quality may become coarse due to the limited amount of data. Select "Field" when the pictures are still unstable even if "Auto" is selected. Frame: Displays relatively motionless pictures in higher resolution. "Frame" improves the picture quality, although it may unstabilize the pictures due to alternate output of two field data.

Function Setup

Setting items	Options
TV Active Area Sets the horizontal display area for interlace (480i) output.	Normal: Select this if the image is not stable with connecting to professional-use display. Full*: Select this for connecting to commonly-marketed display.
Wall Paper Sets the picture to be displayed on the screen for stop mode or audio playback mode.	Picture* Blue Black Gray



- Settings with (*) are the default.
- Quick menu consists of the setting menus frequently used, and they are accompanied with  mark.
- For "HDMI RGB Setting", select "Enhanced" if the black-white contrast is not clear. The setting is effective only for HDMI RGB output.
- Even if "HDMI Video Resolution" is set to "1080p24" and "I/P Direct" is set to "On", for the BD that is not recorded by 1080p24 frame or for DVD, a video resolution supported by the disc and the display device will be output instead of 1080p24 frame.
- An individual picture on the screen is called as "Frame", which consists of two separate images called as "Field". Some pictures may be blurred at the auto setting in "Still Mode" due to their data characteristics.
- If the picture is not output properly to the display device because of the "HDMI Video Resolution" or "Component Output" setting, press and hold  on the front panel for more than 5 seconds. Both settings will be reset to the default automatically.
- If "Component Output" is set to "480i", "4:3 Squeeze Auto" and "4:3 Squeeze On" in "TV Aspect" are not available.
- If HDMI is connected, for video resolution for the component output, you can only select video resolution that currently output from HDMI OUT or 480i.
- If the video resolution for the component output and HDMI video resolution does not match, the video resolution for the component output will be switched to current HDMI output resolution. COMPONENT VIDEO OUT jacks may not output any signals depend on the disc material.
- If you play back copy-protected DVD video, 480p signal will be output from the COMPONENT VIDEO OUT jacks, when "Component Output" is set to "720p" or "1080i".
- If connected display device does not support 1080p24 frame or "I/P Direct" is set to "Off", "1080p24" in "HDMI Video Resolution" will be displayed in gray and you can not select the item.
- For playing back BD, if you set "Component Output" to "480i", 480p signal will be output from the COMPONENT VIDEO OUT jacks.
- The setting items which are not available with current situation of this unit will be displayed in gray and you cannot select the items.
- Even if "HDMI Select" is set to "YCbCr", if the display device does not support YCbCr, RGB will be output.
- If "HDMI Video Resolution" is set to "1080p" or "1080p24", you cannot set "Component Output".

Function Setup

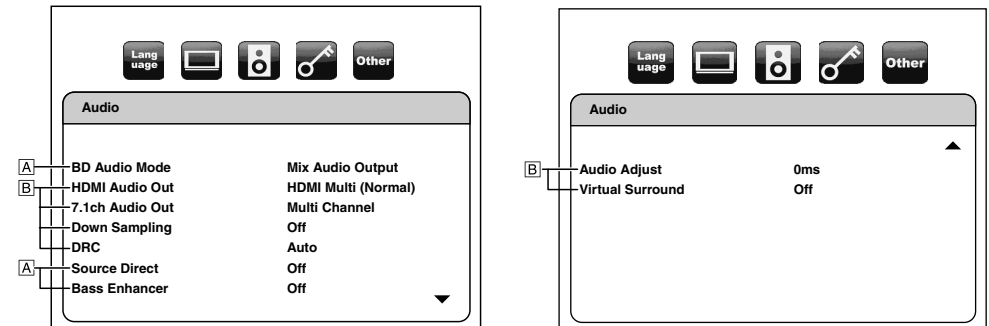
 Audio



• For how to select the setting items and options, refer to "Custom" on page 29.

Setting items	Options
BD Audio Mode  For BD, select whether to output the secondary and interactive audio with primary audio if it is available or only the primary audio. Refer to "Setting the BD Audio Mode" on page 23.	Mix Audio Output*: Output the secondary and interactive audio with primary audio if it is available. HD Audio Output: Output only the primary audio. Set this mode in order to output Dolby Digital, Dolby Digital Plus, Dolby TrueHD, DTS or DTS-HD sound of BD through HDMI connection.
HDMI Audio Out  Sets the audio format for the audio output from the HDMI OUT.	HDMI Multi(Normal)*: The multi-channel audio signals are output from the HDMI OUT with a bitstream or LPCM. HDMI Multi(LPCM): The multi-channel audio signals are output from the HDMI OUT with a LPCM. • Refer to pages 34-35 for setting options. HDMI 2ch: The audio signals are output from the HDMI OUT with a downmixed to 2ch LPCM.
	Audio Mute: Mutes the HDMI audio signal, and set the signal format of the DIGITAL OUT. • Refer to the "Digital Out Setting" on page 33 for setting options.

• The default setting of the "BD Audio Mode" is "Mix Audio Output". If you want to output only the high quality primary audio, set "BD Audio Mode" to "HD Audio Output".

Function Setup

Setting items	Options
7.1ch Audio Out Sets the audio format for the audio output from the 7.1ch AUDIO OUT.	Multi Channel*: The multi-audio signals are output from the 7.1ch AUDIO OUT. Refer to pages 34-35 for setting options. 2 Channel: Down-mixed 2-channel audio signals are output from the 7.1ch AUDIO OUT jacks.
Down Sampling Sets the digital audio output when playing BD or DVD recorded in LPCM.	On: LPCM signals are converted to 48 kHz for output. • Set to "On" when using digital connections to an AV amplifier that is not compatible with sampling frequencies of 96 kHz. Off*: For BD or DVD recorded in LPCM without copyright protection, 2-channel audio signals up to 192 kHz are output as LPCM signals with no conversion.
DRC Sets whether to compress the range of sound volume (Dynamic Range Control) when Dolby Digital, Dolby Digital Plus or Dolby TrueHD audio is played back.	Auto*: When the discs that are recorded in the Dolby TrueHD format is in playback, this unit detects DRC setting of the disc and set the DRC setting of this unit to "On" or "Off" automatically. Off On
Source Direct Sets to output the audio without adding speaker settings to the audio signals from the disc.	On: Select this to output the audio without any effect of speaker setting. Off*: Select this to output the audio with the effect of speaker setting.
Bass Enhancer Sets whether to output the subwoofer when playing back content that does not have LFE (Low Frequency Effect) signal. (e.g. content with only 2 channel audio signal.)	On: Audio signal will be output from the subwoofer. (Please set "Subwoofer" in the "Speaker Configuration" to "On".) Off*: No audio signal will be output from the subwoofer.
Audio Adjust Sets the amount of the delay time between the picture and audio signal.	0ms to 200ms (0ms*) The audio signal will be delayed for the amount of time you set.

Function Setup

Setting items	Options
Virtual Surround Sets to create a surround effect in a system with 2 speakers connected.	Off*: Virtual surround is set to off. 1: A natural surround effect in a system with 2 speakers connected. 2: A stronger surround effect in a system with 2 speakers connected than "1".

- Settings with (*) are the default.
- Quick menu consists of the setting menus frequently used, and they are accompanied with  mark.
- If you set "Source Direct" to "On", "HDMI Audio Out" to "HDMI 2ch" or "7.1ch Audio Out" to "2 Channel", "Bass Enhancer" is not available.
- Under following circumstances, "HDMI Multi(Normal)", "HDMI Multi(LPCM)" and "HDMI 2ch" is not available.
 - HDMI cable is not connected to HDMI OUT jack.
 - Connected display device is off.
 - Connected display device is not compatible with audio output.
- When "Source Direct" is set to "On", "Bass Enhancer" and "Speaker Configuration" are not available.

Digital Out Setting

When the "Audio Mute" is selected in "HDMI Audio Out" setting, audio signal of the HDMI is muted and the audio signals output from DIGITAL OUT changes depending on the "Digital Out" setting.

<"Digital Out" setting>
 Audio → HDMI Audio Out → Audio Mute

Bitstream*: When playing back discs recorded in Dolby Digital, Dolby Digital Plus, Dolby TrueHD, DTS or DTS-HD, the corresponding core stream (Dolby Digital or DTS) are output.
LPCM: LPCM signal will be output from DIGITAL OUT.

- This setting is not effective when the HDMI audio signal is output.
- When both HDMI and DIGITAL OUT is connected to other devices, the audio signals currently output from the HDMI OUT will be output from the DIGITAL OUT jack as well, except that Dolby Digital signal will be output instead of Dolby Digital Plus and Dolby TrueHD, and DTS signal will be output instead of DTS-HD.
- When "BD Audio Mode" is set to "HD Audio Output", Dolby Digital Plus, Dolby TrueHD, or DTS-HD will be output as core stream (Dolby Digital or DTS). If the audio source is Dolby Digital, DTS, or LPCM, the same audio stream type set in the "HDMI Audio Out" will be output. (When outputting Multi LPCM from HDMI OUT, 2ch Downmix LPCM will be output from DIGITAL OUT.)
- When "BD Audio Mode" is set to "Mix Audio Output", the audio output from DIGITAL OUT will follow the setting in the "HDMI Audio Out". (When outputting Multi LPCM from HDMI OUT, 2ch Downmix LPCM will be output from DIGITAL OUT.)

Function Setup
Speaker Setting

This unit allows you to enjoy multi-channel surround sound such as 7.1-channel / 5.1-channel surround.

<Example of basic layout with 7.1ch surround system>

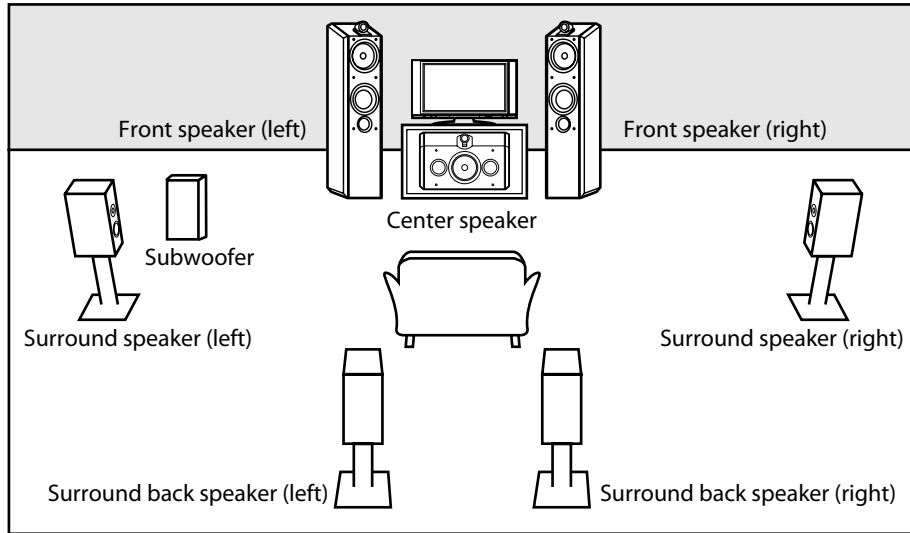

To make the most of its feature, set up your speakers appropriately by referring to the table below.

Speaker setting options are available at the following locations;

<Speaker setting for the audio signal output from the HDMI OUT jack >

(Available when you have HDMI cable connected to the HDMI OUT jack)

Setup → Quick → HDMI Audio Out → HDMI Multi(LPCM)

Setup → Custom → Audio → HDMI Audio Out → HDMI Multi(LPCM)

<Speaker setting for the audio signal output from the 7.1ch AUDIO OUT jacks >

Setup → Quick → 7.1ch Audio Out → Multi Channel

Setup → Custom → Audio → 7.1ch Audio Out → Multi Channel

Function Setup

How to navigate through the “HDMI Multi(LPCM)” and “Multi Channel” setting

1) Use [△ / ▽] to select the menu item.

2) Use [△ / ▽] to select setting items.

• Use [RETURN] to go back to the previous screen.

3) Use [◀ / ▶] to select desired options.(Except for “Test Tone” and “Default”.)

For “Test Tone”:

Use [◀ / ▶] to select “Manual” or “Auto”, then press [ENTER].

• The test tone will be output. If you select “Manual”, use [△ / ▽] to select desired speaker, then use [◀ / ▶] to adjust the volume. If you select “Auto”, use [◀ / ▶] to adjust the volume of the speaker that output the test tone.

• If you want to stop the test tone, press [RETURN].

For “Default”:

Press [ENTER] to reset the “Delay Time” setting to the default.

4) Press [SETUP] to exit.

Menu	Setting items	Options	Descriptions
Speaker Configuration Select the desired speaker to set. Then change the setting appropriately by referring to the descriptions.	Front	Large*	Large: For the large speakers with strong low frequency reproduction capabilities.
		Small	
	Center	Large*	Small: For the small speakers which do not provide strong bass sound.
		Small/None	
	Subwoofer	On*	None: No speakers.
		Off	
	Surround	Large*	For “Subwoofer” there is only “On” or “Off”.
Small/None			
Surround Back	Large*		
	Small/None		
Crossover Freq: For speakers set to “Small”, the sound with frequencies below that of this frequency are cut. This bass sound that has been cut is output from the subwoofer or a speaker for which “Large” is set.		40/60/80*/100/120Hz	Select according to the low frequency reproduction capabilities of the connected speaker.

• For “Speaker Configuration”, the settings of each speaker sizes may be adjusted automatically corresponding to each setting. (e.g. If the “Front” is set to “Small”, the “Subwoofer” will automatically set to “On” and also you cannot set “Center”, “Surround”, and “Surround Back”, to “Large”.)

• If you connect to 5.1-channel surround system, set “Surround Back” in “Speaker Configuration” to “None”.

• “None” for “Center”, “Surround” and “Surround Back” is not available for the speaker setting for the audio signal output from the HDMI OUT jack .

• “Off” for “Subwoofer” is not available for the speaker setting for the audio signal output from the HDMI OUT jack.

Function Setup

Menu	Setting items	Options	Descriptions
Channel Level Tests or sets the volume for each speaker.	Test Tone: "Test Tone" is the test tone which can be output from the speakers so that you can adjust the volume for each speaker.	Off*	Select "Off" to deactivate the "Test Tone" feature. Select "Manual", then press [ENTER] to manually set the volume for the desired speaker.
		Manual	Select "Auto", then press [ENTER] to automatically output the test tone from each speakers.
		Auto	
	Front Lch	0 dB to -12 dB (0 dB*)	If you have selected "Manual" in "Test Tone", select the desired speaker to set and adjust the volume for the selected speaker. If you have selected "Auto" in "Test Tone", test tone will be output automatically in order. Adjust the volume of the speaker that output the test tone.
	Center	0 dB to -12 dB (0 dB*)	
	Front Rch	0 dB to -12 dB (0 dB*)	
	Surround Rch	0 dB to -12 dB (0 dB*)	
	Surround Back Rch	0 dB to -12 dB (0 dB*)	
	Surround Back Lch	0 dB to -12 dB (0 dB*)	
	Surround Lch	0 dB to -12 dB (0 dB*)	
Subwoofer	0 dB to -12 dB (0 dB*)		
SW + 10 dB (Not available for HDMI)	On/Off*	Set "On" to increases the volume level that is output from the subwoofer by 10 dB.	

Function Setup

Menu	Setting items	Options	Descriptions	
Delay Time This is a parameter for optimizing the timing at which the sound is output from the speakers according to their distance from the listening position.	Distance	Feet*	Set the desired measure system. This measure system will be used for "Delay Time" setting. Press [ENTER] to switch the setting.	
		Meters		
	Front Lch	0ft to 60ft (12ft*) (0m to 18m (3.6m*))	Select the distance from the listening point to the speaker to get the ideal delay time.	
	Front Rch	0ft to 60ft (12ft*) (0m to 18m (3.6m*))		
	Center	0ft to 60ft (12ft*) (0m to 18m (3.6m*))		
	Surround Lch	0ft to 60ft (10ft*) (0m to 18m (3.0m*))		
	Surround Rch	0ft to 60ft (10ft*) (0m to 18m (3.0m*))		
	Surround Back Lch	0ft to 60ft (10ft*) (0m to 18m (3.0m*))		
	Surround Back Rch	0ft to 60ft (10ft*) (0m to 18m (3.0m*))		
	Subwoofer	0ft to 60ft (12ft*) (0m to 18m (3.6m*))		
	Default			Select "Default", then press [ENTER] , to reset the "Delay Time" setting to the default.

- Settings with (*) are the default.
- For HDMI, "None" and "Off" options for "Speaker Configuration" are not available.
- For "Delay Time", the difference among the value of the each speaker cannot exceed 15 ft (4.5m).
- If you want to stop the test tone, press **[RETURN]**.

Function Setup

 Ratings

Ratings control allows you to set a limit, which prevents your children from viewing inappropriate materials. Playback will stop if the ratings exceed the levels you set, and it will require you to enter a password before the disc will play back.

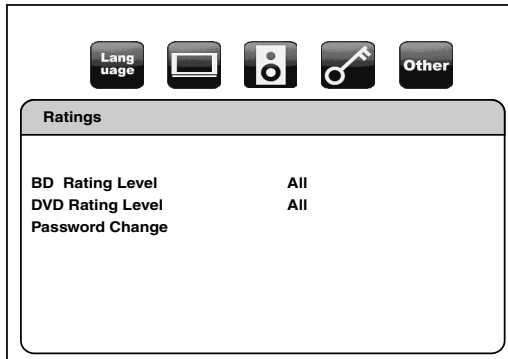

1) Use [\leftarrow / \rightarrow] to select , then press [ENTER].

2) Press [the Number buttons] to enter your 4-digit password.

For the first time use: Press [the Number buttons] to enter any 4-digit number (except for 4737), then press [ENTER]. That number will be used as the password from the second time. Record your password in case you forget it.

- If you forgot the password, enter [4], [7], [3], [7]. The password will be cleared and rating level will be set to "All".
- While you input the password, press [CLEAR] to clear the number, then re-enter the password.

Proceed to A – C

A) BD Rating Level

1) Use [Δ / ∇] to select "BD Rating Level", then press [ENTER].

2) Use [Δ / ∇] to select your desired option, then press [ENTER].

"All" : To release the limitation.

"Age Setting": To set the age limitation.

- After selecting "Age Setting", use [the Number buttons] to enter the age from 0 – 254, then press [ENTER].
(e.g. for age 15, press [0],[1],[5])

3) Press [SETUP] to exit.

B) DVD Rating Level

1) Use [Δ / ∇] to select "DVD Rating Level", then press [ENTER].

2) Use [Δ / ∇] to select a desired level, then press [ENTER].

3) Press [SETUP] to exit.

Function Setup

RATING EXPLANATIONS

- All : Parental control is inactive; all discs can play back.
- 8 [Adult] : DVD software of any grades (adult/general/children) can be played back.
- 7 [NC-17] : No one under 17 admitted.
- 6 [R] : Restricted; under 17 requires accompanying parent or adult guardian.
- 5 [PGR] : Parental guidance recommended.
- 4 [PG13] : Unsuitable for children under 13.
- 3 [PG] : Parental guidance suggested.
- 2 [G] : General audience.
- 1 [Kid Safe] : Suitable for children.

C) Password Change

1) Use [Δ / ∇] to select "Password Change", then press [ENTER].

2) Enter a new 4-digit password, then press [ENTER].

3) Press [SETUP] to exit.

Function Setup

Other

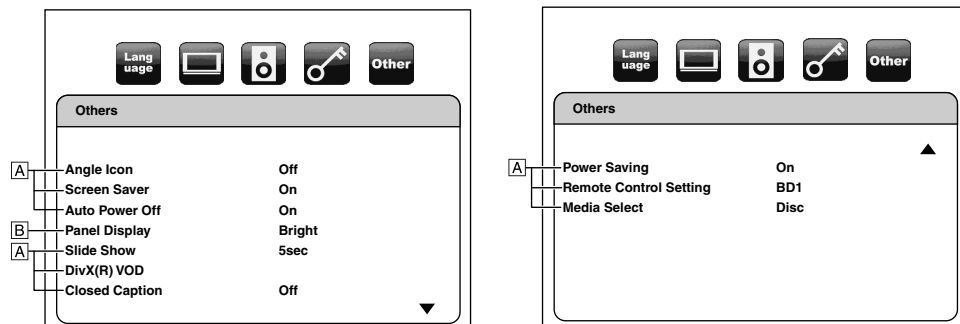

• For how to select the setting items and options, refer to “Custom” on page 29.

Setting items	Options
Angle Icon	On: The angle icon appears on the screen when playback the scene with various angle. Off*: The angle icon disappears on the screen.
Screen Saver	On*: If this unit is left with no activity for more than 5 minutes, the screen saver will be activated. Off: Sets off the screen saver.
Auto Power Off	On*: If this unit is left with no activity for more than 30 minutes, this unit turns off automatically. Off: Sets off the auto power off.
Panel Display Sets the brightness of the front panel display.	Bright*: Front panel display gets brighter. Dimmer: Front panel display gets darker. Auto: Front panel gets darker during playback.
Slide Show Sets the display time for the still picture (in JPEG format) playback	5sec* 10sec
DivX(R) VOD Provides DivX® VOD registration code.	For more information about DivX® VOD visit www.divx.com/vod

Function Setup

Setting items	Options
Closed Caption Sets whether display the closed caption or not using the caption decoder (commercially available).	On Off*
Power Saving Lower the power consumption for standby mode by denying the command from RS-232C during standby mode.	On*: Denies the command from RS-232C when the power is in standby mode. Off: Accepts the command from RS-232C when the power is in standby mode.
Remote Control Setting Changes the signal code of a remote control. (Refer to page 6)	BD1* BD2
Media Select Select the media to playback.	Disc*: Select this when you play back a disc. SD Memory: Select this when you play back a SD Memory Card.

INITIALIZE Initialize

Initialize the setting or SD Memory Card.

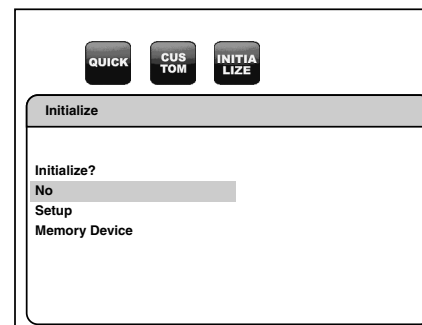

- 1) Press [SETUP] in stop mode.
- 2) Use [◀ / ▶] to select “Initialize”, then press [ENTER].
- 3) Use [△ / ▽] to select a desired option, then press [ENTER].
 “No” :Exit without any initialization.
 “Setup” :Reset the SETUP setting to the factory default.
 “Memory Device” :Initializes the SD Memory Card. After confirmation message appears, use [△ / ▽] to select “Yes”, then press [ENTER].
- 4) Press [ENTER]. (For “Setup” and “Memory Device” only)
- 5) Press [SETUP] to exit.

Note

• The setting for “Ratings” will not be reset.

Others

Troubleshooting

If the unit does not perform properly when operated as instructed in this Operating Instruction, check the unit, consulting the following checklist.

Problem	Solution	Page	Problem	Solution	Page
No power	<ul style="list-style-type: none"> - Check if the AC cord is properly connected. - Unplug the AC cord once, and wait for 5-10 seconds and then plug it in again. 	- -	Buttons do not work or the unit stops responding	- To completely reset the unit, unplug the AC cord from the AC outlet for 5-10 seconds.	-
No sound or picture	<ul style="list-style-type: none"> - Check if the connected display device is turned on. - Check the HDMI connection. (Check the status of the HDMI related indications.) - Check the RCA audio/video cable connections. - Check if the pure direct mode is set to "Video Off" or "All Off". If it is the case, set it to "Display Off" or "Normal". - Check whether the connected display device or other device supports HDCP. (This unit will not output a video signal unless the other device supports HDCP.) - Check whether the output format of this unit (HDMI FORMAT) matches the supported input format of other connected device. - Check if the "HDMI Deep Color" is set to "Auto". If it is the case, set it to "Off". - Check if the "I/P Direct" is set to "On". If it is the case, set it to "Off". 	- 10 10, 13 23 12 10,30,31 31 31	The unit does not respond to some operating commands during playback	- Operations may not be permitted by the disc. Refer to the instructions of the disc.	14
Distorted picture	<ul style="list-style-type: none"> - Sometimes a small amount of picture distortion may appear. This is not a malfunction. - Connect this unit directly to the TV. If the RCA audio/video cables are connected to a VCR, pictures may be distorted due to the copy protection system. 	- 10	The unit cannot read BD/DVD/CD	<ul style="list-style-type: none"> - Condensation ? (Let sit 1 or 2 hours) - You are attempting to play a disc other than one with one of the marks on page 4. - Wipe the dirt off the disc or replace the disc. 	3 4 4
Completely distorted picture or black/white picture with BD/DVD	<ul style="list-style-type: none"> - Make sure the disc is compatible with this unit. 	4	Angle does not switch	- The angle cannot be switched for BD/DVD which do not contain multiple angles. In some cases multiple angles are only recorded for specific scenes.	19
No sound or distorted sound	<ul style="list-style-type: none"> - Adjust the volume. - Check that the speakers are connected correctly. - Check the HDMI connections. - Check the "Audio" settings. 	- 10,12,13 10 32,33	Playback does not start when the title is selected	- Check the "Ratings" setting.	36
Picture freezes momentarily during playback	<ul style="list-style-type: none"> - Check the disc for fingerprints/scratches and clean with a soft cloth wiping from center to edge. - Clean the disc. 	4 4	The password for rating level has been forgotten	- Enter the default password "4737", then your forgotten password will be cleared.	36
Disc cannot be played back	<ul style="list-style-type: none"> - Clean the disc. - Ensure the disc label is facing up. - Check if the disc is defective by trying another disc. - Cancel the ratings control or change the control level. - Insert a correct disc that can be played back on this unit. 	4 14 - 36 4			
SD Memory Card cannot be read.	<ul style="list-style-type: none"> - The format of the card does not match to this unit or the card is not compatible. 	-			
No return to start-up screen when disc is removed	<ul style="list-style-type: none"> - Reset this unit by turning it off, then on again. 	-			
The unit does not respond to the remote control	<ul style="list-style-type: none"> - Aim the remote control directly at infrared sensor window on the front of the unit. - Reduce the distance to infrared sensor window. - Replace the batteries in the remote control. - Re-insert the batteries with their polarities (+/- signs) as indicated. - Make the signal code of the remote control match to the signal code of the unit. 	6 - 6 6 6			

Note

- Some functions are not available in specific modes, but this is not a malfunction. Read the description in this Operating Instructions for details on correct operations.
- Some functions are prohibited on some discs.

Language Code

Language	Code	Language	Code	Language	Code	Language	Code	Language	Code
A-B		Esperanto	5161	Kinyarwanda	6469	Quechua	6367	Tigrinya	6655
Abkhazian	4748	Estonian	5166	Kirghiz	5771	Rhaeto-Romance	6459	Tonga	6661
Afar	4747	F-H		Kirundi	6460	Romanian [RUM]	6461	Tsonga	6665
Afrikaans	4752	Faroese	5261	Korean [KOR]	5761	Russian [RUS]	6467	Turkish [TUR]	6664
Albanian	6563	Fiji	5256	Kurdish	5767	S			
Amharic	4759	Finnish [FIN]	5255	L-N					
Arabic	4764	French [FRE]	5264	Laothian	5861	Samoan	6559	Sangho	6553
Armenian	5471	Frisian	5271	Latin	5847	Sanskrit	6547	Serbian	6564
Assamese	4765	Galician	5358	Latvian;Lettish	5868	Scots Gaelic	5350	Serbo-Croatian	6554
Aymara	4771	Georgian	5747	Lingala	5860	Sesotho	6566	Setswana	6660
Azerbaijani	4772	German [GER]	5051	Lithuanian	5866	Shona	6560	Sindhi	6550
Bashkir	4847	Greek [GRE]	5158	Macedonian	5957	Singhalese	6555	Siswat	6565
Basque	5167	Greenlandic	5758	Malagasy	5953	Slovak [SLO]	6557	Slovenian	6558
Bengali;Bangla	4860	Guarani	5360	Malay	5965	Somali	6561	Somali	6561
Bhutani	5072	Gujarati	5367	Malayalam	5958	Spanish [SPA]	5165	Sundanese	6567
Bihari	4854	Hausa	5447	Maltese	5966	Swahili	6569	Swedish [SWE]	6568
Bislama	4855	Hebrew	5569	Maori	5955	T			
Breton	4864	Hindi	5455	Marathi	5964	Tagalog	6658	Tajik	6653
Bulgarian [BUL]	4853	Hungarian [HUN]	5467	Moldavian	5961	Tamil	6647	Tatar	6666
Burmese	5971	I-K		Mongolian	5960	Telugu	6651	Thai	6654
Byelorussian	4851	Icelandic [ICE]	5565	Nauru	6047	Tibetan	4861		
C-E		Indonesian	5560	Nepali	6051				
Cambodian	5759	Interlingua	5547	Norwegian [NOR]	6061				
Catalan	4947	Interlingue	5551	O-R					
Chinese [CHI]	7254	Inupiak	5557	Occitan	6149				
Corsican	4961	Irish [IRI]	5347	Oriya	6164				
Croatian	5464	Italian [ITA]	5566	Oromo(Afan)	6159				
Czech [CZE]	4965	Japanese [JPN]	5647	Panjabi	6247				
Danish [DAN]	5047	Javanese	5669	Pashto;Pushto	6265				
Dutch [DUT]	6058	Kannada	5760	Persian	5247				
English [ENG]	5160	Kashmiri	5765	Polish [POL]	6258				
		Kazakh	5757	Portuguese [POR]	6266				

Note

- If you choose a language that has a 3-letter-language code (written in bracket), the code will be displayed every time you change the audio or subtitle language setting on page 22. If you choose any other languages, '----' will be displayed instead.

Specifications

SIGNAL SYSTEM

NTSC color

APPLICABLE DISCS

- (1) BD/DVD-video Discs
 - 1-layer 12cm single-sided discs, 2-layer 12cm single-sided discs, 2-layer 12cm double-sided discs (1 layer per side)
 - 1-layer 8cm single-sided discs, 2-layer 8cm single-sided discs, 2-layer 8cm double-sided discs (1 layer per side)
- (2) BD-RE / BD-R
 - 1-layer 12cm single-sided discs, 2-layer 12cm single-sided discs
 - 1-layer 8cm single-sided discs, 2-layer 8cm single-sided discs
- (3) DVD-R
 - 1-layer 12cm single-sided discs, 2-layer 12cm single-sided discs
 - 1-layer 8cm single-sided discs, 2-layer 8cm single-sided discs
- (4) DVD-RW
 - 1-layer 12cm single-sided discs
 - 1-layer 8cm single-sided discs
- (5) Compact discs (audio CD)
 - 12cm discs, 8cm discs
- (6) CD-RW/-R
 - 12cm discs, 8cm discs

APPLICABLE MEMORY CARDS

- (1) SD Memory Card
- (2) SDHC Memory Card
- (3) miniSD Card
- (4) microSD Card

S-VIDEO OUTPUT

Y output level: 1Vp-p (75Ω/ohms)

C output level: 0.286Vp-p

Output connectors: S connector, 1 set

VIDEO OUTPUT

Y output level: 1Vp-p (75Ω/ohms)

Output connectors: Pin jack, 1 set

COMPONENT OUTPUT

Y output level: 1Vp-p (75Ω/ohms)

PB/Cb output level: 0.648Vp-p (75Ω/ohms)

PR/CR output level: 0.648Vp-p (75Ω/ohms)

Output connectors: BNC jacks, 1 set/Pin jacks, 1 set

HDMI OUTPUT

Output jack: 19-pin HDMI terminal, 1 set

HDMI ver. 1.3a (Deep Color, Dolby Digital Plus, Dolby TrueHD, DTS-HD)

ANALOG AUDIO OUTPUT

Output level: 2Vrms

2 channel (L, R) output connector: Pin jacks,

Multi channel (FL, FR, C, SL, SR, SBL, SBR, SW): Pin jacks, 1set

AUDIO OUTPUT PROPERTIES

- (1) Frequency response
 - 1 BDs (linear PCM) : 4Hz to 22kHz (48kHz sampling)
 - : 4Hz to 44kHz (96kHz sampling)
 - : 4Hz to 88kHz (192kHz sampling)
 - 2 DVDs (linear PCM) : 4Hz to 22kHz (48kHz sampling)
 - : 4Hz to 44kHz (96kHz sampling)
 - 3 CDs : 4Hz to 20kHz
- (2) S/N ratio : 125dB
- (3) Total harmonic distortion : 1kHz 0.0008%
- (4) Dynamic range : 110dB

DIGITAL AUDIO OUTPUT

Optical digital output: Optical connector, 1 set

Coaxial digital output: Pin jack, 1 set

POWER SUPPLY

AC 120V, 60Hz

POWER CONSUMPTION

68W (Standby: 0.8W)

MAXIMUM EXTERNAL DIMENSIONS

W :440mm (17-3/8")

H :140mm (5-9/16")

D :402mm (15-13/16")

(including protruding parts)

MASS

10.5 kg (23.1 lbs)

REMOTE CONTROL

RC001BD

Infrared pulse type

Supply: DC 3V, 2 R6P/AA batteries

External dimensions:

W :52mm (2-1/16")

H :227mm (8-15/16")

D :30mm (1-3/16")

Mass: 171g (0.4 lbs) (included batteries)

• For purposes of improvement, specifications and design are subject to change without notice.

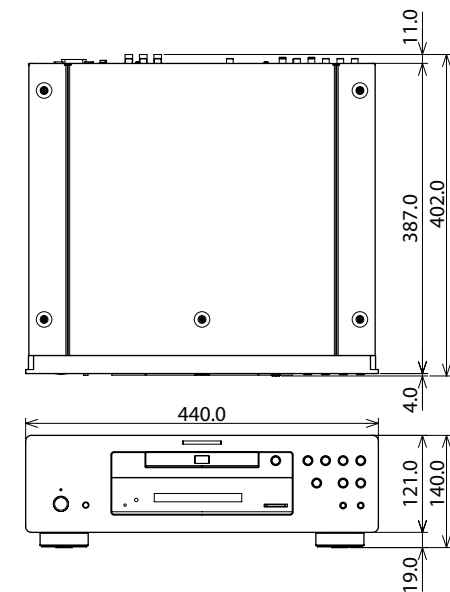

www.marantz.com

You can find your nearest authorized distributor or dealer on our website.

marantz[®] is a registered trademark.

Free Manuals Download Website

<http://myh66.com>

<http://usermanuals.us>

<http://www.somanuals.com>

<http://www.4manuals.cc>

<http://www.manual-lib.com>

<http://www.404manual.com>

<http://www.luxmanual.com>

<http://aubethermostatmanual.com>

Golf course search by state

<http://golfingnear.com>

Email search by domain

<http://emailbydomain.com>

Auto manuals search

<http://auto.somanuals.com>

TV manuals search

<http://tv.somanuals.com>