



marantz[®]

Integrated Amplifier
PM8003

User Guide



CAUTION
RISK OF ELECTRIC SHOCK
DO NOT OPEN



**CAUTION: TO REDUCE THE RISK OF ELECTRIC SHOCK,
 DO NOT REMOVE COVER (OR BACK) NO USER-SERVICEABLE
 PARTS INSIDE REFER SERVICING TO QUALIFIED
 SERVICE PERSONNEL**



The lightning flash with arrowhead symbol within an equilateral triangle is intended to alert the user to the presence of uninsulated "dangerous voltage" within the product's enclosure that may be of sufficient magnitude to constitute a risk of electric shock to persons.



The exclamation point within an equilateral triangle is intended to alert the user to the presence of important operating and maintenance (servicing) instructions in the literature accompanying the product.

WARNING

TO REDUCE THE RISK OF FIRE OR ELECTRIC SHOCK, DO NOT EXPOSE THIS APPLIANCE TO RAIN OR MOISTURE.

CAUTION: TO PREVENT ELECTRIC SHOCK, MATCH WIDE BLADE OF PLUG TO WIDE SLOT, FULLY INSERT.

ATTENTION: POUR EVITER LES CHOCS ELECTRIQUES, INTRODUIRE LA LAME LA PLUS LARGE DE LA FICHE DANS LA BORNE CORRESPONDANTE DE LA PRISE ET POUSSER JUSQU'AU FOND.

NOTE:

This equipment has been tested and found to comply with the limits for a Class B digital device, pursuant to Part 15 of the FCC Rules. These limits are designed to provide reasonable protection against harmful interference in a residential installation. This equipment generates, uses and can radiate radio frequency energy and, if not installed and used in accordance with the instructions, may cause harmful interference to radio communications. However, there is no guarantee that interference will not occur in a particular installation. If this equipment does cause harmful interference to radio or television reception, which can be determined by turning the equipment off and on, the user is encouraged to try to correct the interference by one or more of the following measures:

- Reorient or relocate the receiving antenna.
- Increase the separation between the equipment and receiver.
- Connect the equipment into an outlet on a circuit different from that to which the receiver is connected.
- Consult the dealer or an experienced radio/TV technician for help.

NOTE:

Changes or modifications may cause this unit to fail to comply with Part 15 of the FCC Rules and may void the user's authority to operate the equipment.

This Class B digital apparatus complies with Canadian ICES-003.

Cet appareil numerique de la Classe B est conforme a la norme NMB-003 du Canada.

DECLARATION OF CONFORMITY

This device complies with Part 15 of the FCC rules. Operation is subject to the following conditions: (1) This device may not cause harmful interference, and (2) this device must accept any interference received, including interference that may cause undesired operation.

**U.S. Responsible Party: Marantz America, Inc.
 100 Corporate Drive,
 Mahwah, NJ, 07430, U.S.A.
 TEL: 201-762-6500**

Type of Product: Integrated Amplifier

Model: PM8003

IMPORTANT SAFETY INSTRUCTIONS

READ BEFORE OPERATING EQUIPMENT

This product was designed and manufactured to meet strict quality and safety standards. There are, however, some installation and operation precautions which you should be particularly aware of.

1. Read these instructions.
2. Keep these instructions.
3. Heed all warnings.
4. Follow all instructions.
5. Do not use this apparatus near water.
6. Clean only with dry cloth.
7. Do not block any ventilation openings. Install in accordance with the manufacture's instructions.
8. Do not install near any heat sources such as radiators, heat registers, stoves, or other apparatus (including amplifiers) that produce heat.
9. Do not defeat the safety purpose of the polarized or grounding-type plug. A polarized plug has two blades with one wider than the other. A grounding type plug has two blades and a third grounding prong. The wide blade or the third prong are provided for your safety. If the provided plug does not fit into your outlet, consult an electrician for replacement of the obsolete outlet.
10. Protect the power cord from being walked on or pinched particularly at plugs, convenience receptacles, and the point where they exit from the apparatus.
11. Only use attachments/accessories specified by the manufacturer.
12. Use only with the cart, stand, tripod, bracket, or table specified by the manufacturer, or sold with the apparatus. When a cart is used, use caution when moving the cart/apparatus combination to avoid injury from tip-over.



13. Unplug this apparatus during lightning storms or when unused for long periods of time.
14. Refer all servicing to qualified service personnel. Servicing is required when the apparatus has been damaged in any way, such as power-supply cord or plug is damaged, liquid has been spilled or objects have fallen into the apparatus, the apparatus has been exposed to rain or moisture, does not operate normally, or has been dropped.

Additional Safety Information!

- This product should not be placed in a built-in installation such as a bookcase or rack unless proper ventilation is provided or the manufacturer's instructions have been adhered to.
- Apparatus shall not be exposed to dripping or splashing and that no objects filled with liquids, such as vases, shall be placed on the apparatus.
- When the switch is in the OFF position, the apparatus isn't completely switched-off from the MAINS.
- The equipment shall be installed near the power supply so that the power supply is easily accessible.
- Do not touch hot areas, especially around the "hot surface mark" during and immediately after use.
- During and immediately after use, this product is hot in areas other than the controls and rear panel connection jacks.
- Do not touch hot areas, especially around the "hot surface mark" and the top panel. Contact with hot areas can cause burns.



- Do not expose the unit and batteries to excessive heat such as direct sunlight, fire or the like.
- Make a space of about 8 inches (0.2 m) around the unit.

INTRODUCTION

Thank you for selecting the Marantz PM8003 Integrated amplifier for your Audio system. Please read these operating instructions carefully. We recommend that you read the entire user guide before you attempt to connect or operate the amplifier. After you have reviewed the contents of this manual, we suggest that you make all system connections before you attempt to operate the unit.

ACCESSORIES CHECK

Before use, check the below accessories were included in the package.

- Remote controller

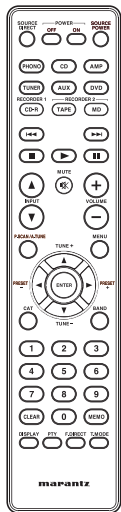

- User Guide

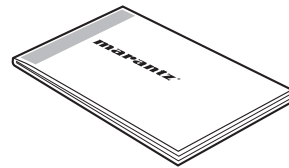

- Warranty Card
USA x 1
Canada x 1

- Size "AAA" batteries x 2

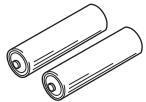

- AC Power cord

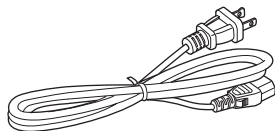

CONTENTS

FEATURES	2
BEFORE USE	2
USAGE OF REMOTE CONTROLLER	3
NAMES AND FUNCTIONS.....	4
FRONT PANEL.....	4
REMOTE CONTROLLER.....	5
REAR PANEL	6
BASIC CONNECTIONS	7
CONNECTING AUDIO COMPONENTS	7
CONNECTING SPEAKER SYSTEMS.....	8
WIRING SPEAKER CABLE.....	8
CONNECTING OF AC POWER CABLE.....	8
BASIC OPERATION	9
PLAYBACK.....	9
ADVANCED CONNECTIONS.....	10
CONNECTING POWER DIRECT IN JACKS.....	10
CONNECTING PRE OUT JACKS.....	10
BI-WIRE CONNECTIONS.....	11
CONNECTING REMOTE CONTROL JACKS.....	11
REMOTE CONTROLLER OPERATION	12
TROUBLESHOOTING.....	13
OTHERS	14
SPECIFICATIONS & DIMENSIONAL DRAWINGS	14

NAMES AND FUNCTIONS
 BASIC CONNECTIONS
 BASIC OPERATION
 ADVANCED CONNECTIONS
 REMOTE CONTROLLER OPERATION
 TROUBLESHOOTING
 OTHERS

FEATURES

ALL-DISCRETE CURRENT-FEEDBACK AMPLIFIER

Marantz' proprietary current-feedback circuit, using discrete components, is adopted in the pre amplifier and power amplifier. It is a high-speed amplifier using the latest technology developed for the higher-grade amplifiers.

HDAM-SA3 TECHNOLOGY

The V/I converter circuit, which is the key block of the current-feedback pre-amplifier and power amplifier, is equivalent to the HDAM-SA3 amp-module developed for such higher-grade models as the SC-11S1.

CD DIRECT BUFFER AMPLIFIER

An input buffer amplifier exclusive for CD is mounted near the CD input jacks. This is a high-speed buffer amplifier made with discrete components, which avoids interference between right and left channels and can send the signals to the pre-amplifier with very high fidelity.

IMPROVED MOMENTARY CURRENT SUPPLY ABILITY

It is generally known that the sound quality is not necessarily the same even if amplifiers have the same specifications. Marantz considers the cause to be the power to drive speakers. The power amplifier of this unit has the ability to momentarily supply current of 25 A or more to drive speakers strongly.

SHORT-POWER-LINE LAYOUT

For strong momentary current supply, a short power-line layout unifies the power circuit and output stage of the power amplifier section. This layout allows connecting the large-current lines via the shortest route while arranging the left and right channels symmetrically.

ALL-DISCRETE CURRENT-FEEDBACK PHONO EQUALIZER

As a phono equalizer amplifier for MM cartridges, a constant current-feedback PHONO equalizer of quality equal to that of the higher-grade model SC-11S1 is used.

DOUBLE-SHIELDED TOROIDAL TRANSFORMER

The unit is equipped with a toroidal power transformer to minimize vibration and leakage flux specific to the transformer. Especially to reduce leakage flux, which affects sound quality, the periphery is double-shielded, using a core ring and a short ring.

BLOCK CONDENSER OF LARGE CAPACITY

A large-capacity condenser of 18,000 μ F is used in the power circuit of the power amplifier. In the pre-amplifier, a 4,700 μ F condenser is used.

HIGH-PERFORMANCE VOLUME

CAPACITOR FOR HIGH QUALITY SOUND

DOUBLE-LAYERED CHASSIS

HIGH-GRADE SPEAKER TERMINALS

BEFORE USE

This section must be read before any connection is made to the mains supply.

EQUIPMENT MAINS WORKING SETTING

Your Marantz product has been prepared to comply with the household power and safety requirements that exist in your area. PM8003 can be powered by 120V AC only.

COPYRIGHT

Recording and playback of any material may require consent. For further information refer to the following:

- Copyright Act 1956
- Dramatic and Musical Performers Act 1958
- Performers Protection Acts 1963 and 1972
- Any subsequent statutory enactments and orders

DO NOT LOCATE IN THE FOLLOWING PLACES

To ensure long-lasting use, do not locate the unit where:

- Exposed to direct sunlight.
- Near to sources of heat such as heaters.
- Highly humid or poorly ventilated.
- Dusty.
- Subjected to mechanical vibrations.
- On wobbly, inclined or otherwise unstable surfaces.
- Radiated heat is blocked such as in cramped audio racks.

To ensure proper heat radiation, ensure the below clearance from walls and other equipment.

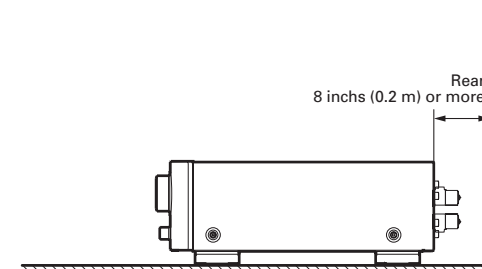
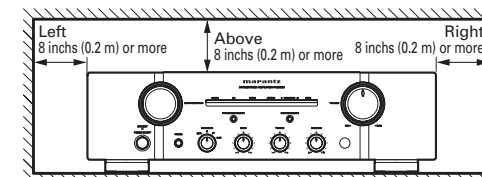

KEEP OBJECTS OFF

Keep objects off the unit. Blocking the vent can result in accident and damage.

DO NOT TOUCH HOT SPOTS DURING AND IMMEDIATELY AFTER USE

During and immediately after use, the unit is hot in areas other than the controls and rear panel connection jacks. Do not touch hot spots and especially the top panel. Contact with hot areas can cause burns.

USAGE OF REMOTE CONTROLLER

LOADING BATTERIES

Before using the remote controller for the first time, load the batteries in the remote controller. The batteries provided are used to verify the operations of the remote controller only.

1. Remove the battery cover.

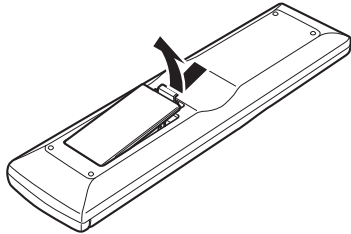

2. Insert the batteries with correct +/- orientation.

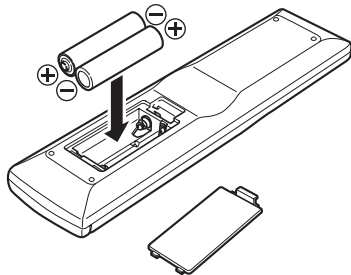

3. Close the battery cover until it clicks shut.

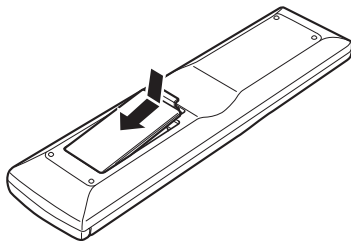

CAUTIONS ON HANDLING BATTERIES

Misuse of the batteries can result in electrolyte leakage, rupturing, corrosion, etc.

Bear in mind the following points when using batteries.

- Remove the batteries from the remote control unit if the unit is not going to be used for a prolonged period (a month or more).
- Do not use an old battery together with a new one.
- Insert the batteries while ensuring that their \oplus and \ominus poles are properly aligned with the corresponding markings on the remote control unit.
- Batteries with the same shape may have different voltages. Do not use different types of batteries together.
- If electrolyte has leaked, thoroughly wipe the inside of the battery compartment, and then insert new batteries.
- When batteries which are no longer required are to be discarded, follow the directions (regulations) laid down by the local authorities in the area concerned for their disposal.

OPERATIONAL RANGE

Operate the unit with the remote controller within the range of the illustration below.

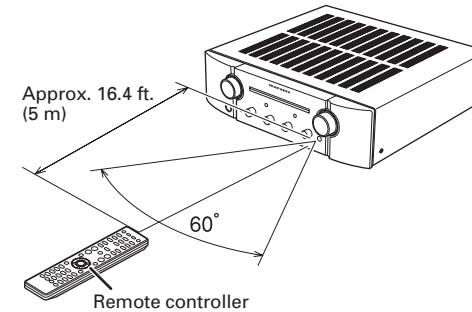

Precautions

- Do not allow direct sunlight, an inverter fluorescent light or other strong source of light to shine onto the player's infrared signal reception window (remote sensor). Otherwise, the operation of the remote control unit may be disabled.
- Bear in mind that operating the remote control unit may cause other devices operated by infrared rays to be operated by mistake.
- The remote control unit cannot be operated if the space between the controller and the player's remote sensor is obstructed.
- Do not place any objects on top of the remote control unit. Doing so may cause one or more buttons to be held down which will cause the batteries to run down.

NAMES AND FUNCTIONS

FRONT PANEL

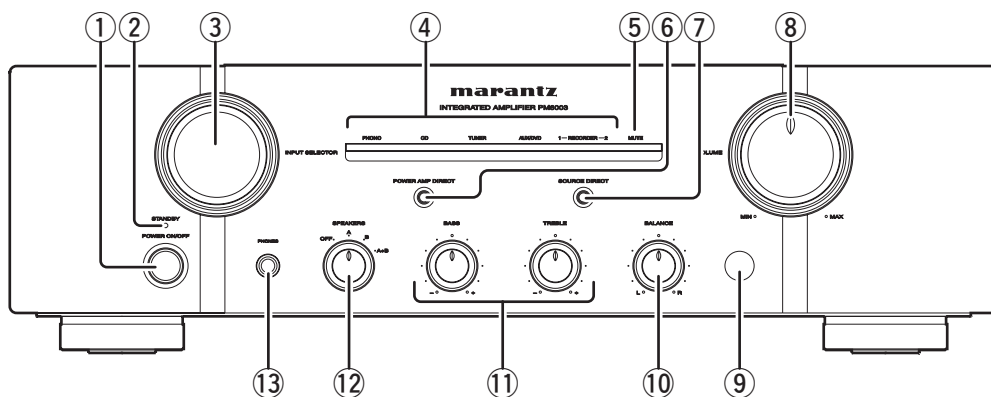

① POWER ON/OFF button

Pressing this button once turns power to the amplifier ON, and pressing it again turns power to the amplifier OFF. When the button is in the ON position, power can be switched ON/OFF using the remote controller.

If the power is switched OFF using the remote controller, the amplifier engages in standby mode. When in this mode, you cannot switch the power ON by pressing the POWER ON/OFF button. The amplifier remains in standby mode even if this button is pressed. To switch the power ON, either turn the INPUT SELECTOR knob or press the POWER ON button on the remote controller.

② STANDBY indicator

This indicator is lit red when the amplifier is in standby mode. When in standby mode, you can switch the power ON by using the POWER ON button on the remote controller. If the amplifier's protective circuit activates, this indicator flashes.

③ INPUT SELECTOR knob

This knob selects the input source for playback. The selected input source is displayed on the function indicator. The amplifier memorize the selected input source when the power is turned OFF, and then re-selects the same input source when the power is turned ON again.

④ Function indicator

This indicator displays the input source currently selected by the INPUT SELECTOR knob.

⑤ MUTE indicator

When the MUTE button on the remote controller is pressed, the MUTE function is activated and the volume is lowered. Pressing the MUTE button again releases the MUTE function. Moreover, the MUTE function can also be released by pressing the VOLUME +/- button on the remote controller. If the amplifier's protective circuit activates, this indicator flashes for approx. 15 seconds and the MUTE function activates. While this indicator is flashing, the VOLUME knob automatically turns and the volume decreases.

⑥ POWER AMP DIRECT button

The POWER DIRECT IN jacks are provided on the rear panel of the unit. Holding this button pressed for more than 3 seconds lights the indicator around the button, and this unit functions as the power amplifier.

In this status, the sound volume cannot be adjusted by turning the VOLUME knob.

To release POWER AMP DIRECT mode, hold this button pressed for more than 3 seconds again.

⑦ SOURCE DIRECT button

Pressing this button lights the indicator around the button. The signal bypasses the balance and tone control circuits, boosting sound quality. When this button is set to ON, the BALANCE, BASS, and TREBLE knobs are disabled.

⑧ VOLUME knob

Turning this knob clockwise increases the volume, while turning it counterclockwise decreases the volume. The volume can also be adjusted using the remote controller. If the amplifier's protective circuit activates, the VOLUME knob automatically turns for approx. 15 seconds and the volume decreases.

⑨ Infrared Receptor Window

This is the receptor of control signals sent from the remote controller. Point the remote controller towards this window to properly transmit signals.

⑩ BALANCE knob

This knob is used to adjust the sound level from one of either the L (left) or R (right) channels. If the BALANCE knob is turned all the way round to one side, sound is not output from the opposite side. Please note that this knob does not function when the SOURCE DIRECT button is in the ON position.

⑪ Tone Control knobs (BASS/TREBLE)

These knobs are used to adjust the BASS and TREBLE sound level. Turning the knobs clockwise increases the sound level, and turning them counterclockwise decreases the sound level. Please note that these knobs do not function when the SOURCE DIRECT button is in the ON position.

⑫ SPEAKERS knob

This knob is for selecting the speakers connected to the SPEAKERS SYSTEM A and/or B terminals on the rear panel. When you use headphones, set the knob to OFF.

⑬ PHONES jack

This jack is for connecting headphones with a standard stereo plug. To listen with headphones, turn the speaker output OFF by setting the SPEAKERS knob in the OFF position.

REMOTE CONTROLLER

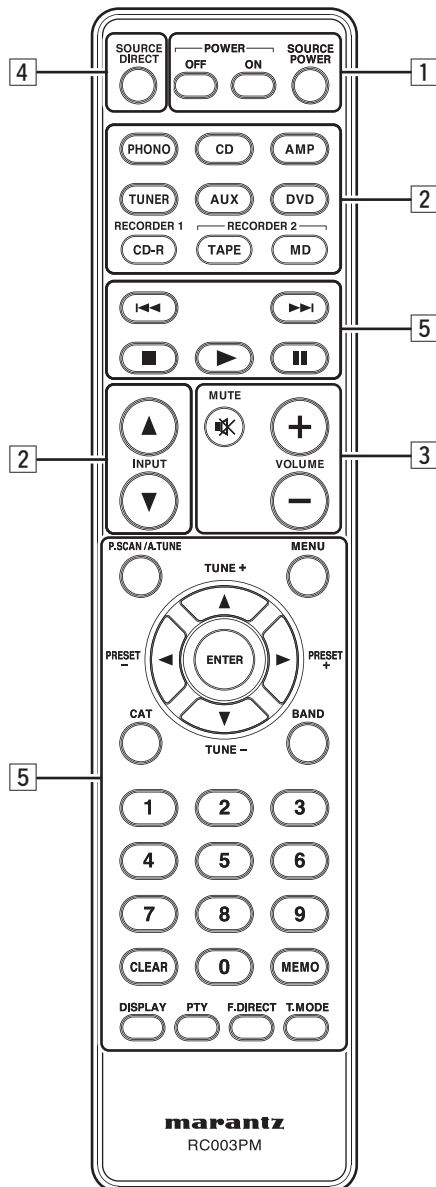

Using this remote controller, you can control this unit and Marantz CD players, DVD players, tuners, tape decks etc. that have a remote control receptor. The operations possible by remote controller may differ with each component; therefore see the instruction manual that came with the component.

The remote controller buttons are laid out as shown below.

1 POWER ON/STANDBY buttons

POWER ON button

Turns the unit power on when it is in the standby mode.

POWER OFF button

Sets the unit power to the standby mode when it is set to the power-on mode.

SOURCE POWER button

Switching the mode of a CD player, DVD player or other Marantz component equipped with a power standby function between power-on and standby is enabled by pressing this button after the INPUT SOURCE button corresponding to the component has been pressed.

When this button is pressed after pressing the TUNER button, the tuner's power is turned on; when it is pressed again, the tuner is set to the standby mode.

When this button is pressed after pressing the AMP button, the unit is switched from the power-on mode to the standby mode or vice versa.

* The remote controller cannot be used to turn the primary power of the amplifier ON and OFF.

2 Input selector buttons

Input source Button

These buttons are for directly selecting the input source.

Caution:

Some input jacks of this unit and the corresponding input selector buttons on the remote controller differ, as shown below.

The unit	Buttons on the remote controller
AUX/DVD	AUX, DVD
RECORDER2	TAPE, MD

For the input sources shown in the table above, although the same jacks are used for two types of sources on the unit, separate buttons are provided on the remote controller.

When using the remote controller for operation of a Marantz component connected to the unit, select the input source first, then perform operations.

INPUT ▲ Button

This button is for forward-feeding the input source indications to select a desired source.

The input source indication, which is displayed on the function indicator on the main frame, is fed to the right.

INPUT ▼ Button

This button is for backward-feeding the input source indications to select a desired source.

The input source indication, which is displayed on the function indicator on the main frame, is fed to the left.

3 VOLUME adjustment buttons

MUTE Button

This button activates the mute function. Pressing this button again releases the MUTE function. The MUTE function can also be released by pressing either the VOLUME + or – buttons.

VOLUME + Button

This button increases the volume level.

VOLUME – Button

This button decreases the volume level.

4 SOURCE DIRECT button

This button is for switching Source Direct mode ON or OFF.

5 Component operating buttons

These buttons are for performing basic operations of a Marantz CD player, DVD player, etc. The function of each button changes to match the component selected as the input source using the input selector buttons. For details, see page 12.

NAMES AND FUNCTIONS

REAR PANEL

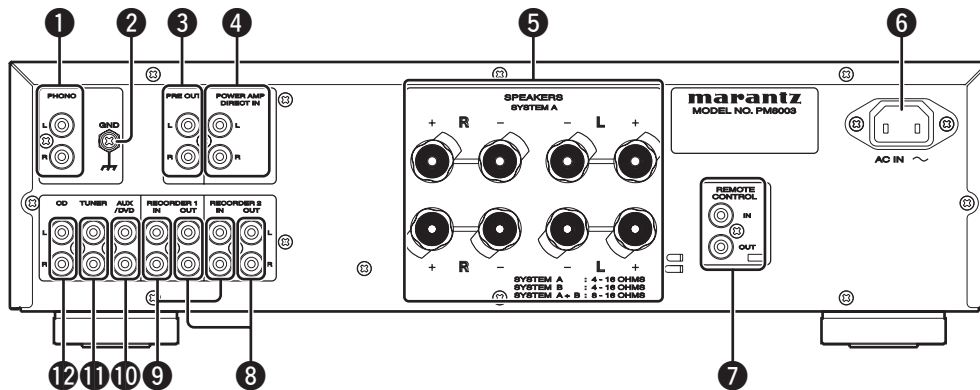

1 PHONO Input jacks

These jacks are for connecting to an analog record player. MM cartridges can be used.

2 PHONO GND terminal

Connect the grounding wire from an analog record player.

3 PRE OUT jacks

These jacks are for connection via the input jacks of another main amplifier or active subwoofers. These jacks cannot be used in Power Amp Direct mode.

4 POWER AMP DIRECT IN jacks

These jacks are used as input jacks when you use this unit as a power amplifier in Power Amp Direct mode. If you use another preamplifier, connect it via these jacks. In this status, the sound volume cannot be adjusted by turning the VOLUME knob.

5 SPEAKERS SYSTEM A, B output terminals

You can connect 2 speaker systems, SYSTEM A and SYSTEM B. Speaker output can be turned ON/OFF from the SPEAKERS knob on the front panel.

6 AC IN socket

Connect the supplied AC power cable to this socket and a power outlet.

7 REMOTE CONTROL jacks

These jacks are for connecting to other Marantz components such as a CD player or DVD player that has a remote control connector (D.BUS jack). You can use the remote controller supplied with the unit to control the system. For more details, see page 11.

8 RECORDER 1/RECORDER 2 output jacks

These jacks are for connecting to the recording input jacks of a CD-R recorder, MD deck, tape deck, etc.

9 RECORDER 1/RECORDER 2 input jacks

These jacks are for connecting to the output jacks of a CD-R player, MD deck, tape deck, etc.

10 AUX/DVD input jacks

These jacks are for connecting to the output jacks of a DVD player or other audio component.

11 TUNER input jacks

These jacks are for connecting to the output jacks of a tuner or other audio component.

12 CD input jacks

These jacks are for connecting to the output jacks of a CD player or similar component.

BASIC CONNECTIONS

CONNECTING AUDIO COMPONENTS

Caution:

- Do not connect the power cord of this amplifier or any of the other components to the power supply until all of the connections are completed.
- Insert the plugs of the connections cords firmly into the connecting jacks. Incorrect insertion may cause noise.
- Connect the wires correctly to the L (left) and R (right) channels.
- Make sure that input and output are connected correctly.
- Refer also to the instruction manuals of components to connect equipment correctly.

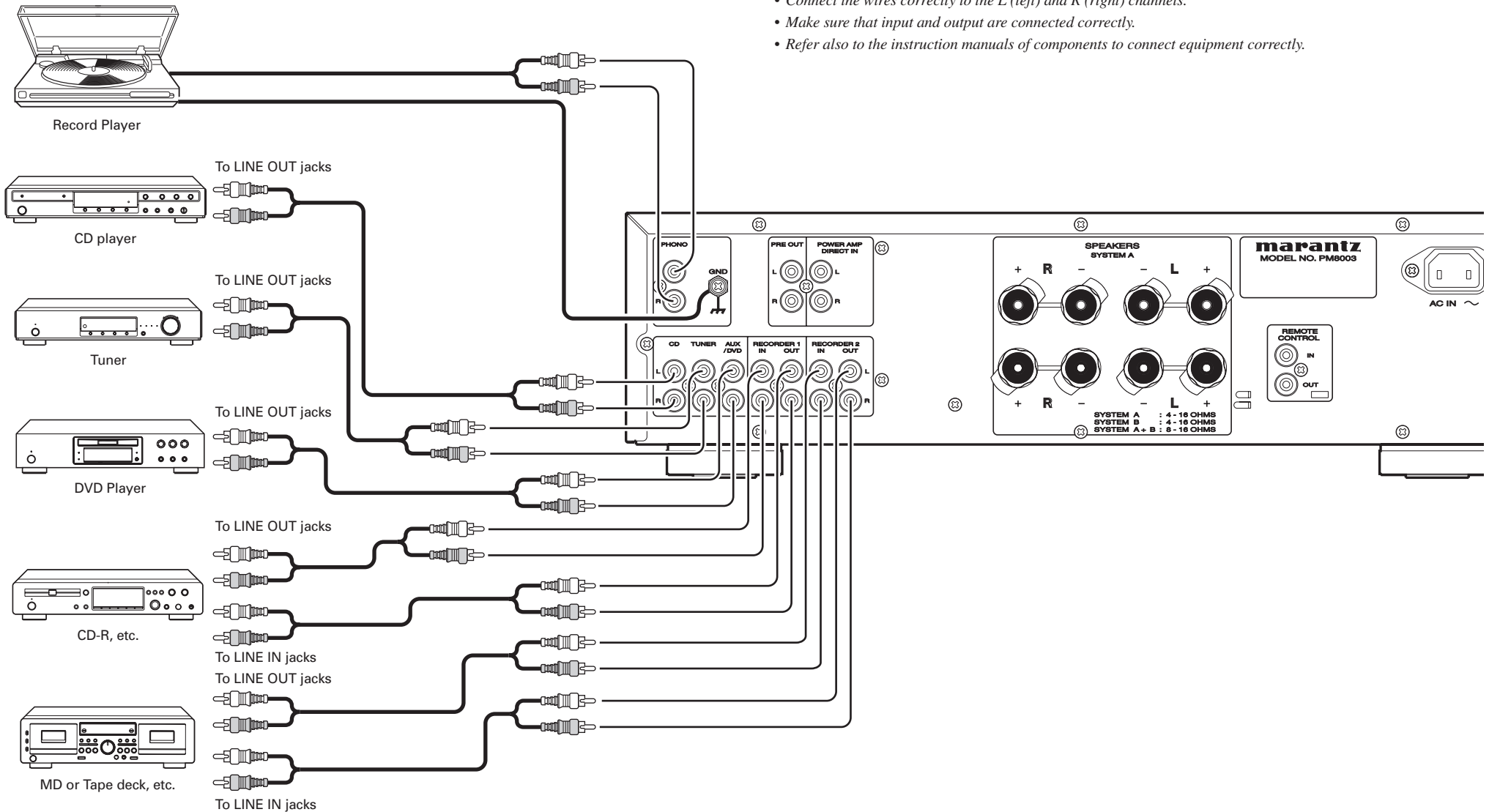

BASIC CONNECTIONS

CONNECTING SPEAKER SYSTEMS

Your speaker system must satisfy the below conditions. If it does not, this unit's protective circuit will activate, whereby preventing proper playback. In some cases, the amplifier and speakers may be damaged.

- If using 1 set of speakers, total speaker impedance must be 4Ω or more.
- If using 2 sets of speakers, total speaker impedance must be 8Ω or more.

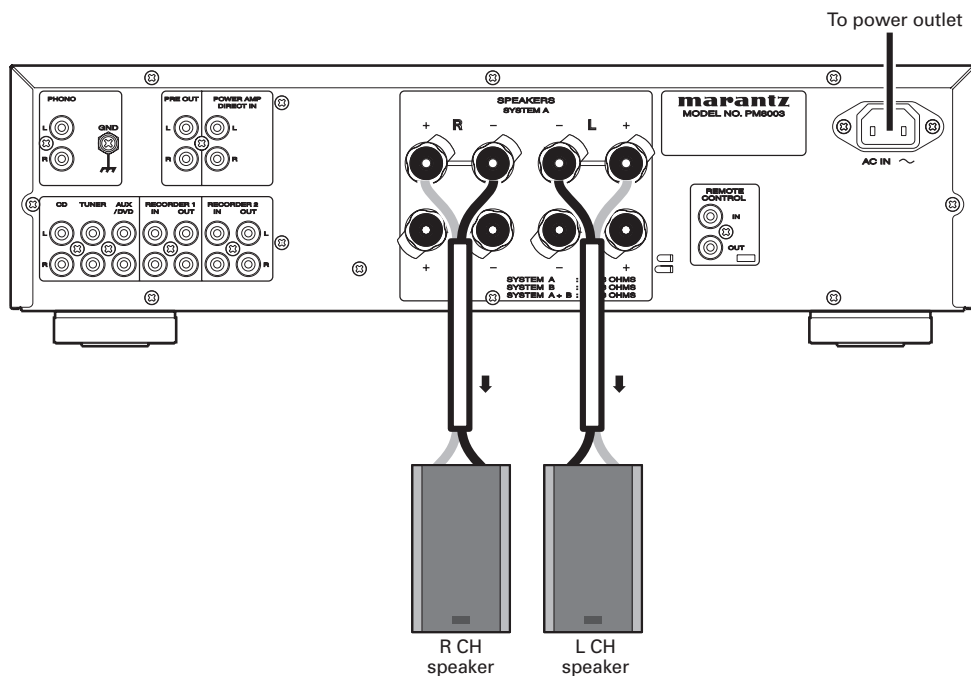

- Set the **SPEAKERS** knob on the front panel in the A or A+B position.

Notes:

- To prevent damage to circuitry, do not let the bare speaker wires touch each other and do not let them touch any metal part of this unit.

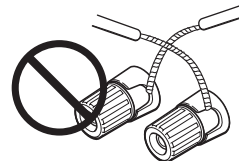

- Do not touch the speaker terminals when the power is on. It may cause you to receive an electric shocks.
- Be sure to connect the positive and negative cables for the speaker properly. If they are miss-connected, the signal phase will be reversed and the signal quality will be corrupted.

WIRING SPEAKER CABLE

- Peel off the coating of speaker cable as shown below.

Approx. 1 cm

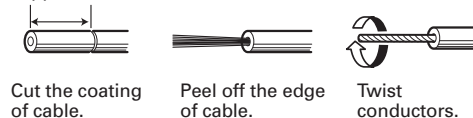

- Wiring with speaker cable.

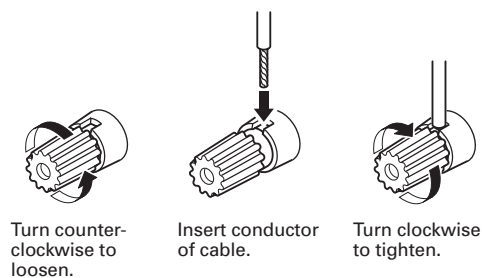

CONNECTING OF AC POWER CABLE

1. Plug the supplied AC power cable to the AC IN socket on the rear panel of the main unit.

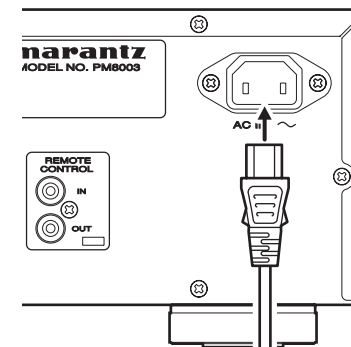

2. Plug the power cable into an AC outlet.

BASIC OPERATION

PLAYBACK

To explain how to play back input sources, representative examples are given with an CD player and analog record player. Before starting either procedure, check the component is correctly connected to the unit.

DISC PLAYBACK ON AN CD PLAYER

1. Press the power ON/OFF button of the CD player to activate power to it.
2. Press the **POWER ON/OFF** button ① to activate power to it. Approximately 8 seconds after power has been activated, the muting turns OFF and audio output is enabled.
3. Select the **CD** with the **INPUT SELECTOR** knob ③.
4. To use the speakers connected to the **SPEAKERS SYSTEM** terminals, set the **SPEAKERS** knob ⑫.
5. Load a disc into the CD player and press the play button to start playback.
6. Adjust the volume with from the **VOLUME** knob ⑧.
7. Adjust bass/treble as desired with the **BASS** and **TREBLE** knobs ⑪. Be sure to first set the **SOURCE DIRECT** button ⑦ in the **OFF** position.

DISC PLAYBACK ON AN ANALOG RECORD PLAYER

1. Press the **POWER ON/OFF** switch ① to activate power to it. Approximately 8 seconds after power has been activated, the muting turns OFF and audio output is enabled.
2. Select "PHONO" as the input source with the **INPUT SELECTOR** knob ③. To prevent unexpected accidents, it is recommended to set the volume level to **MIN.** by turning the **VOLUME** knob ⑧ until muting the volume level.
3. MM type cartridges can be connected. Use a step-up transformer when using an MC cartridge.
4. To use the speakers connected to the **SPEAKERS SYSTEM** terminals, set the **SPEAKERS** knob ⑫.
5. Set a record on the analog record player and play it.
6. Adjust the volume level with the **VOLUME** knob ⑧.
7. Adjust bass/treble as desired with the **BASS** and **TREBLE** knobs ⑪. Be sure to first set the **SOURCE DIRECT** button ⑦ in the **OFF** position.

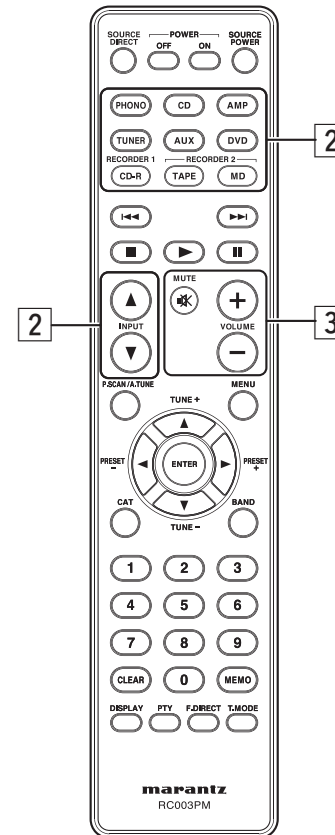
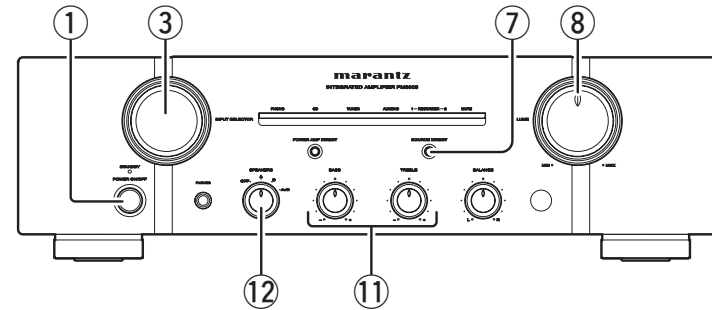

BI-WIRE CONNECTIONS

BI-WIRE connection is a technique for improving sound quality. It connects speaker systems and an amplifier, using two speaker cables; one for mid-to-high range speakers and another for bass speakers. It eliminates the influence on a mid-to-high range speaker unit due to back electromotive force generated by the bass speaker unit.

For BI-WIRE connection, a speaker system must comply with the BI-WIRE connection specifications. Refer to the instruction manual supplied with the speaker system.

Connect a mid-to-high range speaker via the SYSTEM A terminals and a bass speaker via the SYSTEM B terminals. Then set the SPEAKER knob on the front panel in the A+B position.

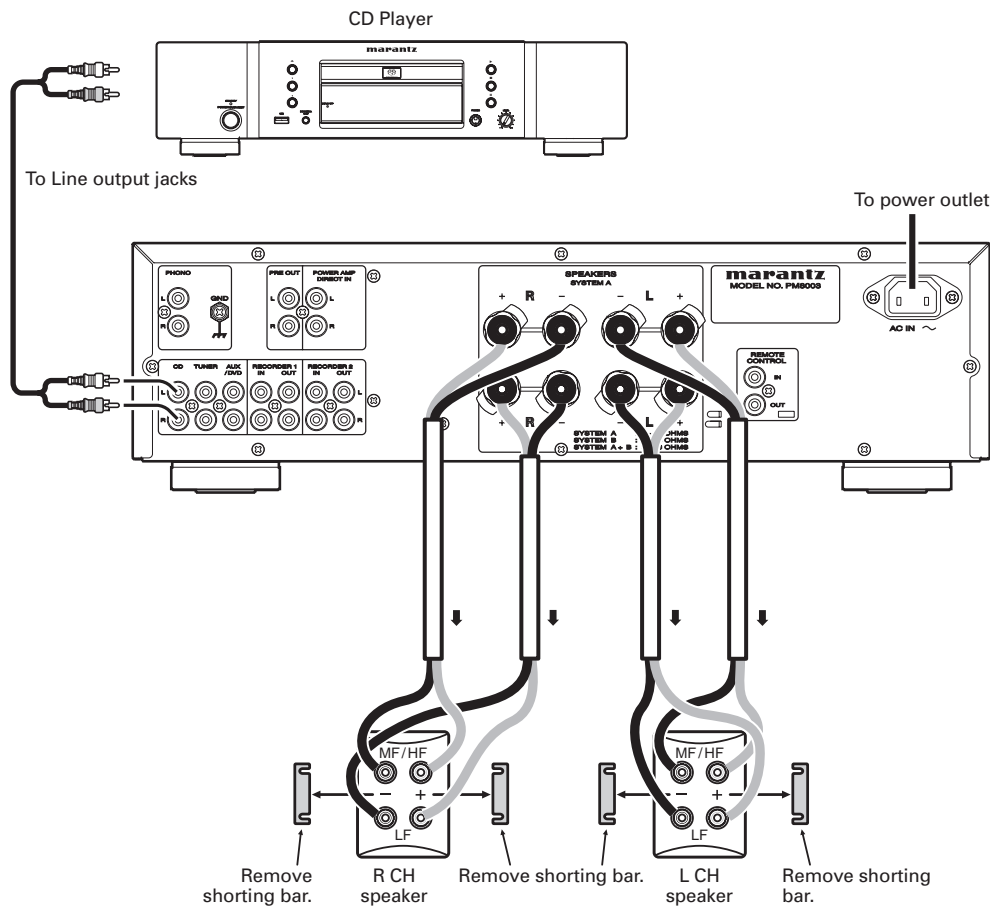

CONNECTING REMOTE CONTROL JACKS

The **REMOTE CONTROL** jacks are for connecting components that are capable of remote control (**D.BUS** jacks) such as a Marantz CD Player or DVD Player. This enables these other components to be operated with the remote controller included with the unit. The unit comes with the system remote controller that can operate the basic features of Marantz CD Players and DVD Players. Here, a brief explanation of how to control the unit and CD Player using this remote controller is provided.

As shown in the illustration below, connect the **REMOTE CONTROL "IN"** jack of the CD Player to the **REMOTE CONTROL "OUT"** jack of the unit, and set the CD Player switch to **"EXTERNAL"**. Both this model and CD Player can be operated by pointing the **remote controller** at the receptor of this model.

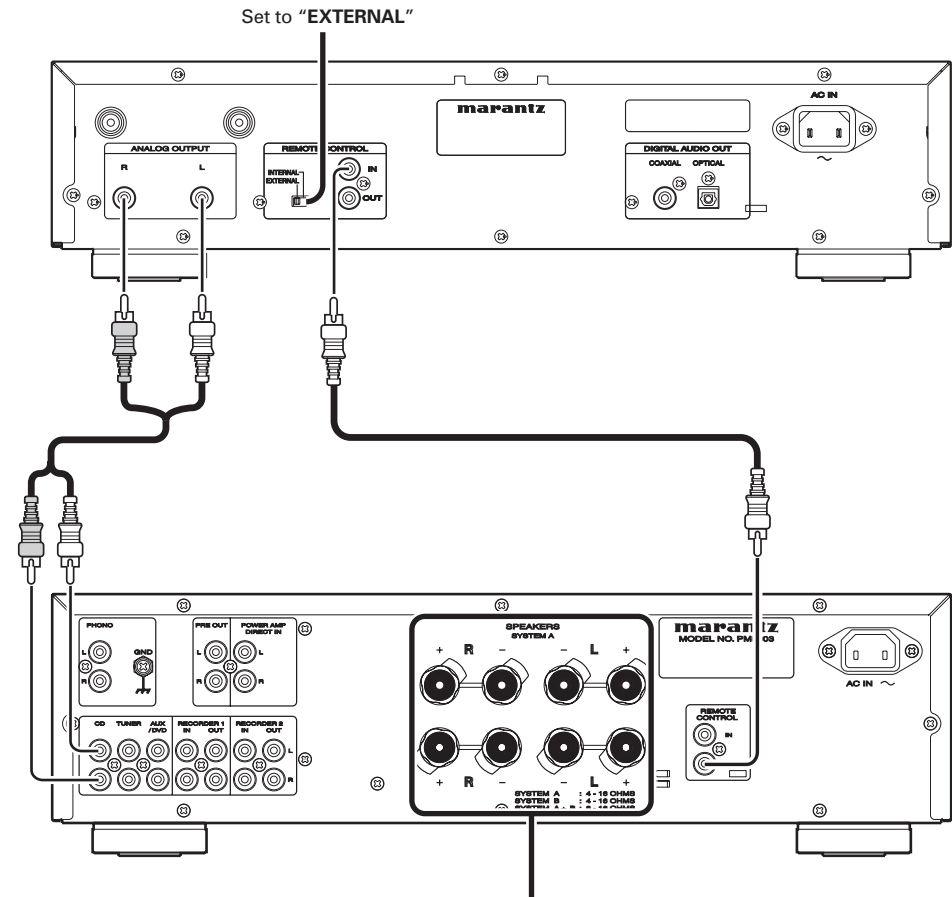

For details connecting the speakers, see page 8.

REMOTE CONTROLLER OPERATION

CD

When the CD button is pressed, the buttons in group [5] function as indicated in the table below. These buttons can only be used when a Marantz CD player is connected to the CD input jacks.

BUTTON NAME	FUNCTION
⏮	Skips to the start of the current track
⏭	Skips to the next track
■	Stops playback
▶	Starts playback
⏸	Pauses a disc that's playing
P.SCAN/A.TUNE	Not for use
MENU	Not for use
▲/TUNE+	Not for use
▼/TUNE-	Not for use
◀/PRESET-	Not for use
▶/PRESET+	Not for use
ENTER	Not for use
CAT	Not for use
BAND	Not for use
0-9	Inputs the numeric
CLEAR	Not for use
MEMO	Not for use
DISPLAY	Not for use
PTY	Not for use
F.DIRECT	Not for use
T.MODE	Selects the sound mode

TUNER

When the TUNER button is pressed, the buttons in group [5] function as indicated in the table below. These buttons can only be used when a Marantz tuner is connected to the TUNER input jacks.

BUTTON NAME	FUNCTION
⏮	Not for use
⏭	Not for use
■	Not for use
▶	Not for use
⏸	Not for use
P.SCAN/A.TUNE	Starts preset scan
MENU	Not for use
▲/TUNE+	Tuning (frequency) increase
▼/TUNE-	Tuning (frequency) decrease
◀/PRESET-	Preset stations forward feed
▶/PRESET+	Preset stations backward feed
ENTER	Not for use
CAT	Not for use
BAND	Selects the band
0-9	Inputs the numeric
CLEAR	Clears the inputting
MEMO	Enters the tuner preset memory numbers
DISPLAY	Selects the display mode in RDS
PTY	Displays the programme type information of the current station
F.DIRECT	Selects the "frequency direct input"
T.MODE	Selects the auto stereo mode or mono mode

DVD

When the DVD button is pressed, the buttons in group [5] function as indicated in the table below. These buttons can only be used when a Marantz DVD player is connected to the AUX/DVD input jacks.

BUTTON NAME	FUNCTION
⏮	Skips to the start of the current track or chapter
⏭	Skips to the next track or chapter
■	Stops playback
▶	Starts playback
⏸	Pauses a disc that's playing
P.SCAN/A.TUNE	Not for use
MENU	Displays a DVD disc menu
▲/TUNE+	Move the cursor upward
▼/TUNE-	Move the cursor downward
◀/PRESET-	Move the cursor leftward
▶/PRESET+	Move the cursor rightward
ENTER	Selects the current menu option
CAT	Not for use
BAND	Not for use
0-9	Inputs the numeric
CLEAR	Not for use
MEMO	Not for use
DISPLAY	Displays the disc playback information
PTY	Not for use
F.DIRECT	Not for use
T.MODE	Not for use

TAPE

When the RECORDER 2 (TAPE) button is pressed, the buttons in group [5] function as indicated in the table below. These buttons can only be used when a Marantz tape deck is connected to the RECORDER 2 (TAPE) jacks.

BUTTON NAME	FUNCTION
⏮	Fast backward
⏭	Fast forward
■	Stops playback
▶	Starts playback
⏸	Pauses a tape that's playing
P.SCAN/A.TUNE	Not for use
MENU	Not for use
▲/TUNE+	Not for use
▼/TUNE-	Not for use
◀/PRESET-	Not for use
▶/PRESET+	Not for use
ENTER	Not for use
CAT	Not for use
BAND	Not for use
0-9	Not for use
CLEAR	Resets counter
MEMO	Not for use
DISPLAY	Not for use
PTY	Not for use
F.DIRECT	Not for use
T.MODE	Not for use

TROUBLESHOOTING

BEFORE CONSIDERING IT AS A FAILURE

In case of trouble with this component, first check the following before calling for service.

What seems to be a serious malfunction is often due to a simple operation mistake.

If the trouble is not fixed after making the following checks, contact the place of purchase, your nearest Marantz dealer, our customer service center, or our repair service center.

Phenomenon	Causes	Actions
Power is not supplied.	The power cable is disconnected.	Check the power cable connections.
	The unit is in STANDBY mode.	Turn the INPUT SELECTOR knob or press the POWER ON button on the remote controller.
	The protection circuit is activated.	If the STANDBY indicator is flashing, turn the power OFF, then ON again after 1 minute or more.
Power is supplied, but no sound is heard from the speaker.	Speaker connection is incomplete.	Check the speaker cable connection.
	Input cord connection is incomplete.	Check the input cable connection.
	The INPUT SELECTOR knob is not set correctly.	Set the INPUT SELECTOR knob properly.
	The VOLUME knob is set to minimum.	Turn the VOLUME knob to the proper level.
	<ul style="list-style-type: none"> The SPEAKERS knob is set to OFF. Setting of the SPEAKERS knob is incorrect. 	Set the SPEAKERS knob properly according to the SPEAKER terminals to which the speakers are connected.
	Setting of the POWER AMP DIRECT button is incorrect.	Set the POWER AMP DIRECT button properly.
	The MUTE function is activated.	If the MUTE indicator is lit, press the MUTE button on the remote controller to release the MUTE function.
Sound is heard from left or right speakers only.	Speaker connection is incomplete.	Check the speaker connections.
	Setting of the BALANCE knob is incorrect.	Set the BALANCE knob properly.
Left and right channels are reversed.	Connection of left and right speaker cords or input cords is reversed.	Make connections properly.
Noise occurs during record playing.	Grounding connection from the record player is improper.	Check the connections to the PHONO GND terminal.
	Connection to the PHONO jacks is incorrect.	Check the connection to the PHONO input jacks.
	A TV set or the like placed too close to the record player may affect the sound.	Place the TV set or record player in another position.
Howling occurs when sound volume is increased during record playing.	Speakers are placed too close to the record player.	Place the speakers away from the record player as far as possible.
	The record player is placed on a rack or floor that is easily vibrated.	If an insulating pad is not supplied with the record player, use an insulating pad available in the market.

ABOUT THE PROTECTIVE CIRCUIT

This unit is equipped with a protective circuit to protect the amplifier circuits and speaker system against damage.

If the protective circuit is activated, the sound is instantly muted.

In this case, either the MUTE indicator flashes, or the STANDBY indicator above the POWER ON/OFF button flashes.

AT POWER ON

For about 8 seconds after the power is turned on, the protective circuit is activated muting the sound to give the amplifier circuits time to stabilize. Once the amplifier circuits stabilize, the protective circuit releases and audio is enabled.

IN THE EVENT OF OVERCURRENT

The protective circuit is activated if current exceeding a certain level is detected, which can happen if excessive signal flow is input to the amplifier or if the unit is connected to a speaker system of less than 4Ω impedance. The protective circuit is also activated if a speaker cable shorts.

In these cases, the MUTE indicator flashes, and the volume is automatically reduced. Approximately 15 seconds later the protective circuit is released, therefore the volume needs readjusting to continue normal use.

Moreover, if the overcurrent continues, the amplifier's power shuts OFF and the STANDBY indicator above the POWER ON/OFF button flashes.

IF EXCESSIVE ULTRA-BASS SIGNALS ARE INPUT

The protective circuit is also activated if ultra-bass signals that exceed the base signal range settings are input. In this case, the MUTE indicator flashes, and the volume is automatically reduced. Approximately 15 seconds later, the protective circuit is released, therefore the volume needs readjusting to continue normal use. If excessive ultra-bass signal input continues or if DC voltage is detected due to trouble with the amplifier, the power shuts OFF and the STANDBY indicator above the POWER ON/OFF button flashes.

IF THE MAIN-AMPLIFIER OVERHEATS

The protective circuit is activated if the temperature of the main-amplifier section rises above a certain level, which can happen if the amplifier is continually used with excessive signal flow being input into it. The protective circuit is also activated when the set operating temperature is exceeded, which can happen if the vents on top of the amplifier are covered, or if the amplifier is installed on a cramped audio rack. In these cases, the MUTE indicator flashes, and the volume is automatically reduced. Approximately 15 seconds later, the protective circuit is released, therefore the volume needs readjusting to continue normal use.

If the temperature does not sufficiently lower within a certain amount of time after the protective circuit activation, the power shuts OFF and the STANDBY indicator above the POWER ON/OFF button flashes.

IN THE EVENT OF AMPLIFIER TROUBLE

The protective circuit is activated and the power is automatically shut OFF if an abnormality is detected in the power circuit. The same happens if the main fuse inside the amplifier blows. In these cases, the STANDBY indicator above the POWER ON/OFF button flashes.

In cases as mentioned above, immediately disconnect the power cord, and contact the place of purchase, your nearest Marantz dealer, our customer service center, or our repair service center.

OTHERS

SPECIFICATIONS & DIMENSIONAL DRAWINGS

Power output (20Hz – 20kHz simultaneous drive of both channels)
70W x 2 (8Ω load)
100W x 2 (4Ω load)
 Total harmonic distortion (20Hz – 20kHz simultaneous drive of both channels, 8Ω load)
 0.02%
 Output band width (8Ω load, 0.05%)
5Hz – 60kHz
 Frequency response (CD, 1W, 8Ω load)
 5Hz – 100kHz ±3dB
 Dumping factor (8Ω load, 20Hz – 20kHz)..... 100
 Input sensitivity/Input impedance
 PHONO (MM)..... 2mV/47kΩ
 CD, LINE, TUNER, AUX/DVD, RECORDER
 200mV/20kΩ
 POWER AND DIRECT IN 1.6V/20kΩ
 Output voltage/Output impedance
 PRE OUT.....1.6V/600Ω
 Maximum allowable PHONO input level (1kHz)
 MM 100mV
 RIAA deviation (20Hz ~ 20kHz) ±0.5dB
 S/N (IHF-A, 1W, 8Ω load)
 PHONO (MM)..... 87dB
 CD, LINE, TUNER, AUX/DVD, RECORDER
 90dB
 POWER AMP DIRECT IN 106dB
 Tone control
 Bass (50Hz)..... ± 10dB
 Treble (20kHz) ± 10dB

Power requirement..... AC 120V 60Hz
 Power consumption
 (UL60065) 200W
 Standby power consumption 0.3W
 Accessories
 Remote controller..... 1
 AAA batteries..... 2
 Detachable AC power cable 1
 Maximum outer dimensions (Amplifier)
 Width 17-5/16 inch (440mm)
 Height 5-1/8 inch (129.8mm)
 Depth 15 inch (379mm)
 Weight (Amplifier) 26.5 lbs (12.0kg)

Specifications subject to change without prior notice.

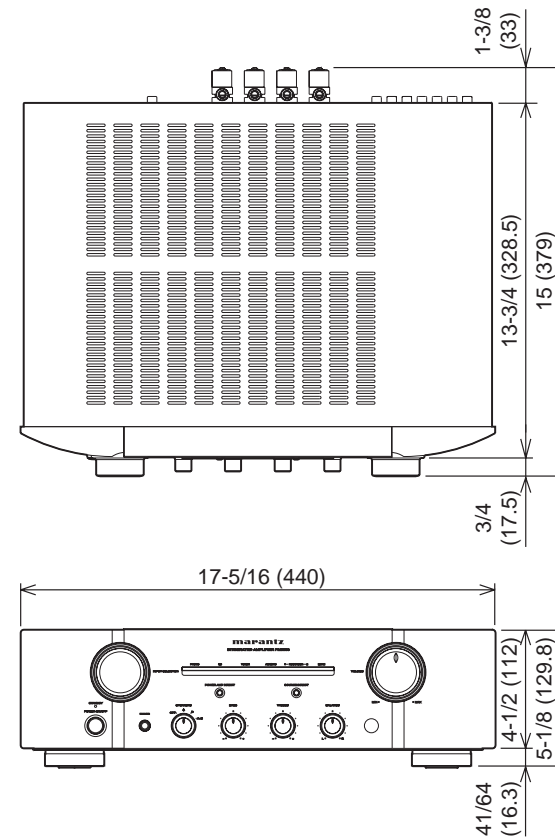

(unit : inch (mm))

CLEANING OF EQUIPMENT EXTERNAL SURFACES

The exterior finish of your unit will last indefinitely with proper care and cleaning, Never use scouring pads, steel wool, scouring powders or harsh chemical agents (e.g., lye solution), alcohol, thinner, benzene, insecticide or other volatile substances as these will mar the finish of the equipment. Likewise, never use cloths containing chemical substances. If the equipment get dirty, wipe the external surfaces with a soft, lint-free cloth.

If the equipment becomes heavily soiled:

- dilute some washing up liquid in water, in a ratio of one part detergent to six parts water.
- dip a soft, lint free in the solution and wring the it is damp.
- wipe the equipment with the damp cloth.
- dry the equipment by wiping it with a dry cloth.



REPAIRS

Only the most competent and qualified service technicians should be allowed to service the factory-trained warranty station personnel have the knowledge and special facilities needed for repair and calibration of this precision equipment. After the warranty period has expired, repairs will be performed for a charge if the equipment can be returned to normal operation.

In the event of difficulty, refer to your dealer or write directly to the nearest location to you that is listed on the Marantz Authorized Service Station list. If writing, please include the model and serial number of the equipment together with a full description of what you think is abnormal about the equipment's behaviour.

USING HEADPHONES

If the volume in the headphones is too high, it may injure your ears. Do not set the sound volume too high.

www.marantz.com

You can find your nearest authorized distributor or dealer on our website.

marantz[®] is a registered trademark.



Free Manuals Download Website

<http://myh66.com>

<http://usermanuals.us>

<http://www.somanuals.com>

<http://www.4manuals.cc>

<http://www.manual-lib.com>

<http://www.404manual.com>

<http://www.luxmanual.com>

<http://aubethermostatmanual.com>

Golf course search by state

<http://golfingnear.com>

Email search by domain

<http://emailbydomain.com>

Auto manuals search

<http://auto.somanuals.com>

TV manuals search

<http://tv.somanuals.com>