

**INSTALLER / CONSUMER
SAFETY INFORMATION**

**PLEASE READ THIS
MANUAL BEFORE INSTALL-
ING AND USING APPLIANCE**

IMPORTANT: Installation of natural gas should be completed by a qualified installer, service agency or gas supplier.

WARNING: If the information in this manual is not followed exactly, a fire or explosion may result causing property damage, personal injury or loss of life.

FOR YOUR SAFETY:

- Installation and service must be performed by a qualified installer, service agency or the gas supplier.
- Do not store or use gasoline or other flammable vapors and liquids in the vicinity of this or any other appliance.

FOR YOUR SAFETY:

—— If you smell gas:

- Do not touch any electrical switches
- Do not try to light any appliance. Extinguish any open flame
- Do not use the phone in your building
- Immediately call your gas supplier from a neighbor's phone
- Follow your gas supplier's instructions
- If you cannot reach your gas supplier, call the fire department

WARNING: For outdoor use only!

WARNING:

Do not use for cooking!



Gas Patio Fire

Models: GPFMN, GPFMP

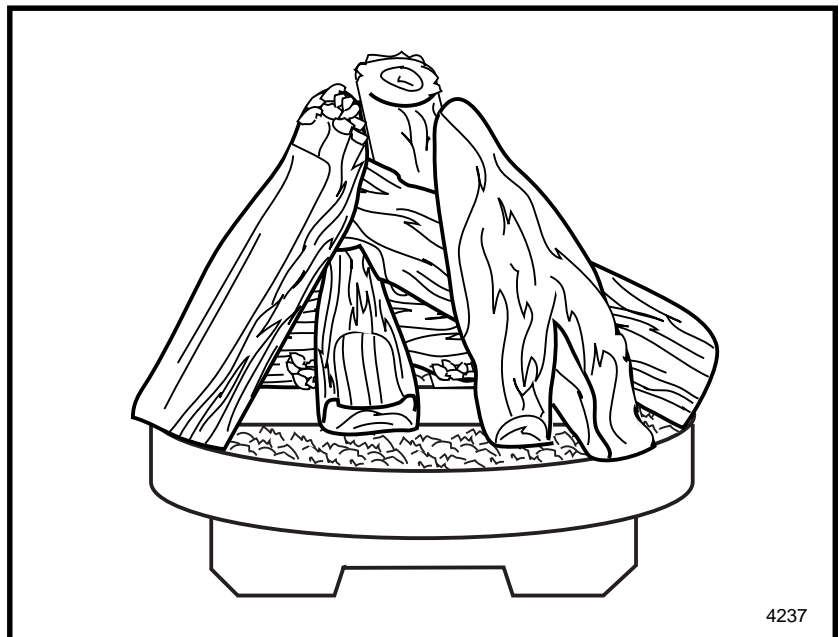

**Homeowner's Installation and
Operating Manual**



**INSTALLER: Do Not Discard This Manual
Leave for Homeowner**

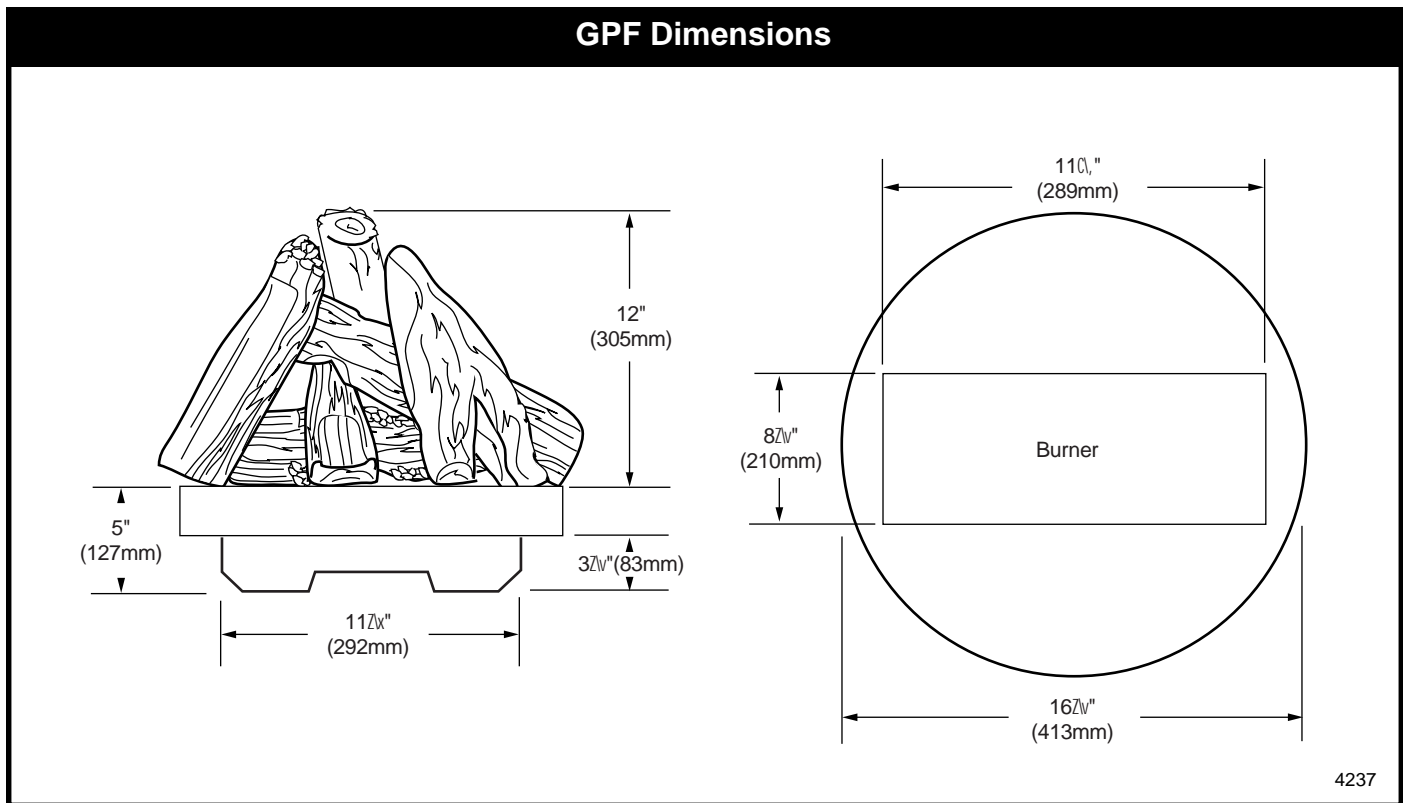

4237

Fig. 1 Physical dimensions.

Table of Contents	
Specifications	2
General Information	3
Assembly & Installation	4
Log Placement	7
Operation	9
Maintenance	10
Replacement Parts	11
Accessories	12

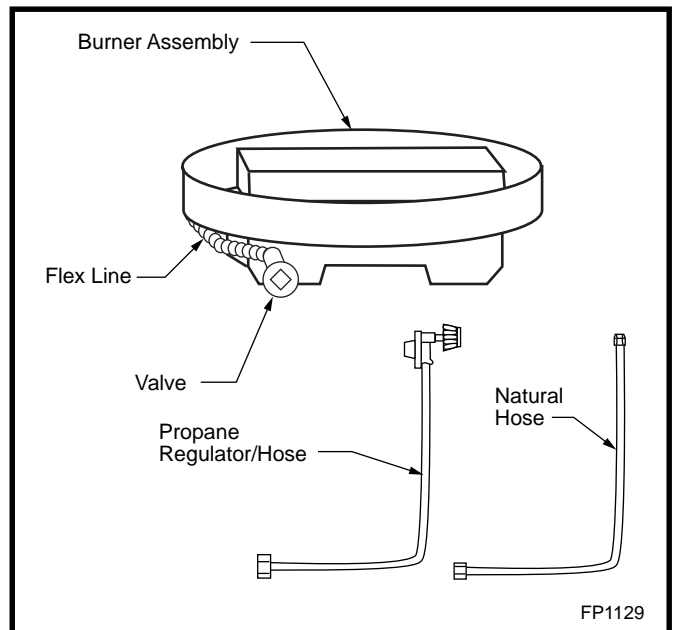

FP1129

Fig. 2 GPF parts.

General Information

Model GPF is a decorative gas log set for outdoor use only. This appliance **must not** be used for cooking.

IMPORTANT: Read all instructions and warnings carefully before starting installation. Failure to follow these instructions may result in a possible fire hazard and will void the warranty.

WARNING: Improper installation, adjustment, alteration, service or maintenance can cause injury or property damage. Read the installation, operating and maintenance instructions thoroughly before installing or servicing this equipment.

WARNING: This appliance shall be used only outdoors in a well-ventilated space and shall **NOT** be used inside a building, garage or any other enclosed area.

WARNING: This log set must **NOT** be installed in an unvented appliance.

WARNING: This unit is not for use with solid fuel.

NOTE: All new LP cylinders (and in many cases used cylinders) may contain water, air or other contaminants, and it is essential that these be removed before filling the cylinder and placing into service. Water vapor present in the gas vapor may cause the regulator to “freeze up” and cause an interruption to the gas flow. This interruption will cause the unit to shut down. To prevent this from occurring it is essential that a qualified individual **ALWAYS** purge a new tank thoroughly before placing it into service. It is recommended that cylinders that have not been used for extended periods of time also be purged before use.

The installation must conform with Local Codes or, in the absence of local codes, with the National Fuel Gas Code ANSI Z223.1 or CSA-B149.1 Installation Code.

The appliance and its individual shut off valve must be disconnected from the gas supply piping system during any pressure testing or the system at test pressures in excess of 1/2 psig (3.5kPa).

This appliance must be isolated from the gas supply piping system by closing its individual manual shut off valve during any pressure testing of the gas supply piping system at test pressures equal to or less than 1/2 psig (3.5kPa).

The following clearances to combustible construction must be maintained: Bottom - 0 inches (0mm), Sides (all around) - 16 inches (406mm) and Top - (7 feet (2.1m).

Always keep the appliance area clear and free from combustible materials, gasoline and other flammable vapors and liquids.

Do not locate appliance where it can get excessively wet. Do not use this appliance if any part has been under water. Immediately call a qualified service technician to inspect the unit and to replace any part of the control system and any gas control which has been under water.

- **Children and adults should be alerted to the hazards of high surface temperatures and should stay away to avoid burns or clothing ignition.**
- **Young children should be carefully supervised when they are in the area of the appliance.**
- **Never leave unit unattended during operation.**
- **Clothing or other flammable materials should not be hung from the appliance, or placed on or near the appliance.**
- **Any guard or other protective device removed for servicing the appliance must be replaced prior to operating the appliance.**
- **Installation and repair should be done by a qualified service person. The appliance should be inspected before use and at least annually by a qualified service person. More frequent cleaning may be required as necessary. It is imperative the control compartment, burners and circulating air passageways of the appliance be kept clean.**
- **Inspect the fuel supply connection (including the hose for LP models) before each use of the appliance.**
- **If it is evident there is excessive abrasion or wear, or the hose is cut, it must be replaced prior to the appliance being put into operation.**
- **The pressure regulator and hose assembly supplied with LP models must be used. Replacement pressure regulators and hose assemblies must be those specified in this manual.**
- **The LP gas supply cylinder used with LP models must be constructed and marked in accordance with the specifications for LP gas cylinders of the U.S. Department of Transportation (DOT).**
- **Cylinders must be stored outdoors in a well-ventilated area out of reach of children. Disconnected cylinders must have threaded valve plugs tightly installed and must not be stored in a building, garage or any other enclosed area.**
- **Storage of this appliance indoors is permissible only if it has been disconnected from its fuel supply (natural gas line or LP gas cylinder).**
- **The LP gas cylinder supply system must be arranged for vapor withdrawal.**
- **The LP gas cylinder used must include a collar to protect the cylinder valve.**
- **When an LP model is not in use, the LP gas must be turned off at the supply cylinder.**

Assembly and Installation

The logs and burner assembly are shipped together.

1. Remove the gas log set and burner assembly and check for damage. **DO NOT** install damaged components. The logs are fragile - handle with care.
2. Place the burner assembly on a flat, stable surface in an outdoor location such as a patio or a deck. This location must be adjacent to the gas supply line (natural gas) or LP gas supply cylinder. **NOTE:** Minimum clearances to combustibles must be maintained.

Remember, you must have easy access to the gas valve control knob **AFTER** the appliance is installed and connected to the gas supply.

The ON/OFF Gas Valve is used to turn the burner on and off.

Natural Gas Models

Connect the incoming gas supply line to the on/off gas valve of the appliance. (Fig. 3) Make certain **ALL** gas connections are tight. Test for leaks. Use a 50/50 solution of liquid soap and water to test for leaks at gas fittings and joints. Apply water/soap solution with a brush only - *do not over apply*. **NEVER test with an open flame.**

LP Gas Models

1. Place cylinder base (provided with unit) on a level surface.
2. Be sure to place cylinder in ring on base.
3. Make sure tank valve is in its full off position. (Turn clockwise to stop)

4. Check tank valve features to ensure it has proper external mating threads. (Tank valve Marked: **USE WITH TYPE 1**)
5. Inspect hose shipped with the unit for damage. Never attempt to use damaged or plugged equipment. See your local LP Gas Dealer for repairs.
6. After inspecting the LP hose shipped with the unit, connect the end with the female fitting on the hose to the male fitting on the on/off gas valve at the end of the flex tube and make sure it is tight.
7. When connecting regulator assembly to the tank valve, hand tighten nut clockwise to a positive stop. **DO NOT** use a wrench to tighten. Use of a wrench may damage quick closing coupling nut and result in a hazardous condition. (Fig. 3)
8. Locate the hose out of pathways where people may trip over it or in areas where the hose may be subject to accidental damage.
9. Open tank valve fully (counterclockwise). Turn the on/off valve at the unit slowly to the on position and use a 50/50 solution of liquid soap and water to test for leaks at gas fitting and joints. Apply water/soap solution with a brush only - *do not over apply*. **NEVER test with an open flame.** If a leak is found, turn tank valve off and do not use the appliance until repairs can be made by a local LP Gas Dealer. **DO NOT** attempt to make repairs yourself.
10. Never attempt to use this appliance or any components that have been damaged or exposed to an accidental fire.

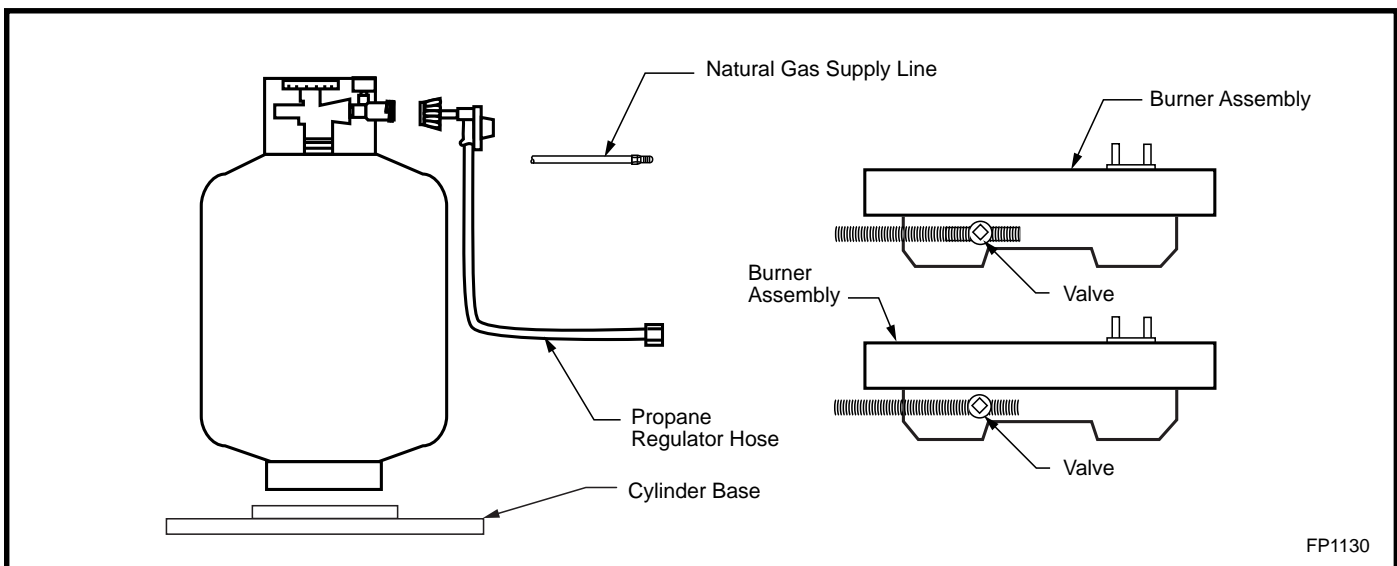

Fig. 3 Gas line connection.

Enclosures for LP Gas Supply Systems

If you build an enclosure for an LP gas cylinder, follow these recommended specifications. You must also follow local codes.

Enclosures for LP gas supply cylinders shall be ventilated by openings at the level of the cylinder valve and at floor level. The effectiveness of the opening(s) for purposes of ventilation shall be determined with the LP gas supply cylinder(s) in place. This shall be accomplished by one of the following:

1. One side of the enclosure shall be completely open; or
2. For an enclosure having four sides, a top and bottom:
 - a. At least two ventilation openings at cylinder valve level shall be provided in the side wall, equally sized, spaced at 180 degrees (3.14 rad), and unobstructed. Each opening shall have a total free area of not less than 1/2 square inch per pound (3.2 sq. cm/kg) of stored fuel capacity and not less than a total free area of 10 square inches (64.5sq. cm).
 - b. Ventilation opening(s) shall be provided at floor level and shall have a total free area of not less than 1/2 inch per pound (3.2 sq. cm/kg) of stored fuel capacity and not less than a total free area of 10 square inches (64.5 sq. cm). If ventilation openings at floor level are in a side wall, there shall be at least two openings. The bottom of the openings shall be at floor level and the upper edge no more than 5 inches (127mm) above the floor. The openings shall be equally sized, spaced at 180 degrees (3.14 rad) and unobstructed.
 - c. Every opening shall have minimum dimensions so as to permit the entrance of a 1/8 inch (3.2mm) diameter rod.
3. Cylinder valves shall be readily accessible for hand operation. A door on the enclosure to gain access to the cylinder valves is acceptable, provided it is nonlocking and can be opened without the use of tools.

4. There shall be a minimum clearance of 2 inches (50.8 mm) between the lower surface of the floor of the LP gas supply cylinder enclosure and the ground.
5. The design of the enclosure shall be such that (1) the LP gas supply cylinder(s) can be connected, disconnected and the connections inspected and tested outside the cylinder enclosure; and (2) those connections which could be disturbed when installing the cylinder(s) in the enclosure can be leak tested inside the enclosure.
6. Be certain to mount or set the LP gas cylinder on a flat stable surface and restrain it to prevent it from tipping.

Purge the gas supply line of any trapped air prior to the first firing of the unit.

WARNING: During the initial purging and subsequent lightings, NEVER allow gas valve to remain in the "Open" position without first placing a burning match on the top of the burner.

Place the logs on the burner assembly. Refer to log placement instructions.

Test fire the unit after referring to the SAFETY INFORMATION and Lighting Instructions found on page 9.

CAUTION: Do not leave the burner on with the cover on.

NOTE: Carbon (soot) may build up on the surface of the logs with heavy use. This is more likely to occur when using LP gas. The soot should be cleaned off the surface of the logs periodically to prevent excessive build up. To clean the logs, be sure the fire is out, the gas supply is turned off and the logs are cool to the touch. The soot can then be brushed off with a dry bristle brush or cloth. Take care while cleaning the logs as they can become damaged if mishandled. Care should be taken to dispose of the soot and cleaning materials properly. Keep away from clothing and outdoor furniture.

Installation of GPF in Optional Villa Base

The Villa Base is designed as a decorative enhancement for use with the Gas Patio Fire.

Tools required: 7/16", 3/4" and 11/16" wrenches, phillips screwdriver.

Installation Instructions

1. Remove octagonal plate from shipping carton.
2. Remove base/Villa from shipping carton. Remove four (4) 1/4-20 fasteners, four (4) nuts and eight (8) washers that fasten the base to the Villa. Remove base. Remove two (2) 1/4-20 x 1/2" fasteners, two (2) washers from cast valve panel. Set hardware aside. (Fig. 4) Orient the Villa so the 3/4" diameter hole in the Villa's valve panel is facing 90° from the fuel line opening in the base. Replace the fasteners, nuts and washers removed in step 1. Be sure to use washers under both the fastener heads and nuts. Tighten the fasteners tight, but do not over-tighten. (Fig. 5) Remove decorative brass ring from the burner valve on the GPF and discard. Remove the four metal screws that hold the valve bracket to the leg support on the GPF and discard. 5. Disconnect the fuel supply line from the venturi (tube secured to the bottom of the burner). Assemble the valve and bracket assembly to the urn using the 1/4-20 x 3/8" fasteners and washers removed in Step 4. Reconnect the fuel supply line to the valve and tighten. Feed the fuel line from the gas supply through the fuel



Octagonal Plate Base Valve Panel Villa KT260 Fig. 4 Remove base/Villa from s

KT261

Fig. 5 Secure Villa to base.

line opening in the base. (Fig. 5) Place the octagonal mounting plate on the Villa. (Fig. 6) Orient the plate with the long side of the rectangular opening parallel to the valve panel. Pass the fuel line through the rectangular opening and reconnect the fuel supply line to the venturi on the GPF and tighten using the 3/4" and 11/16" wrenches.

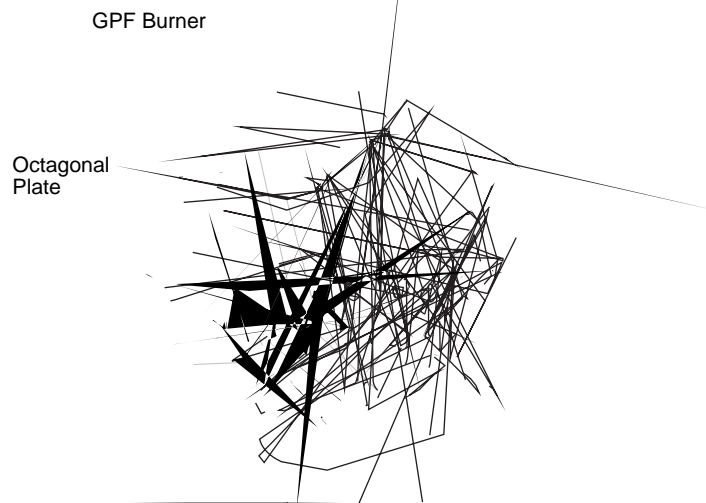

KT262

Fig. 6 Set the octagonal plate on the Villa, then place the GPF burner.

6. Seat the octagonal plate on the Villa. Pass the GPF legs through the rectangular opening in the plate. (Fig. 6)
7. Continue with volcanic rock and log placement on page 8.

... of
 ... pa
 ... brass ri
 ... rd. Rem
 ... old the va
 ... discard.

... at the fuel supp
 ... ch. (Fig. 7) Usin
 ... es, remove the fuel
 ... secured to the botto
 ... valve and bracket as
 ... 1/4-20 x 1/2" fasteners a
 Reconnect the fuel sup
 Feed the fuel line from
 line opening in the ba
 plate on the Chalet. V
 long side of the rect
 valve panel. Pass th
 opening and recon
 venturi on the GP
 11/16" wrenches

6. Seat the oct
 GPF legs thro
 (Fig. 8)

7. Continue
 page 8.

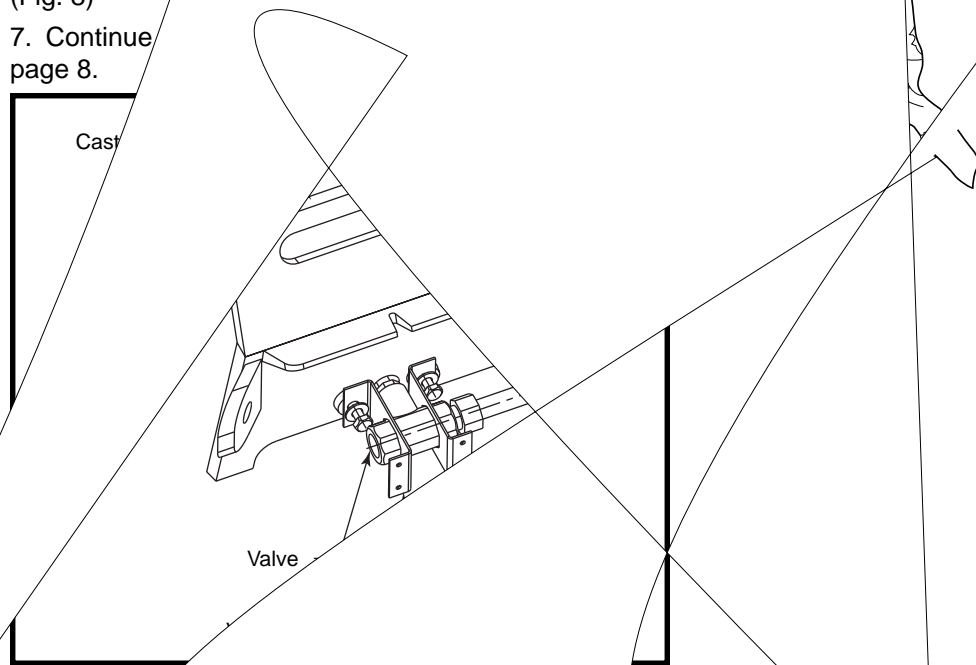

Fig. 7 Attach

Log & Volcanic Rock Placement

...s from packaging and examine each for
 ...ny logs are damaged or missing, contact
DO NOT install damaged logs.

Volcanic Rock Placement

...c rock into outer ring and over burner
 ...e volcanic rock is level with the out
 ... to cover the burner.

Log Placement

...gs on floor near burner ar
 ...g to
 ...As shown in Figure 9, th
 ...n of the
 ...e toward the outside of
 ...urner ring.
 ...ne as reference. Be
 ...n line to your

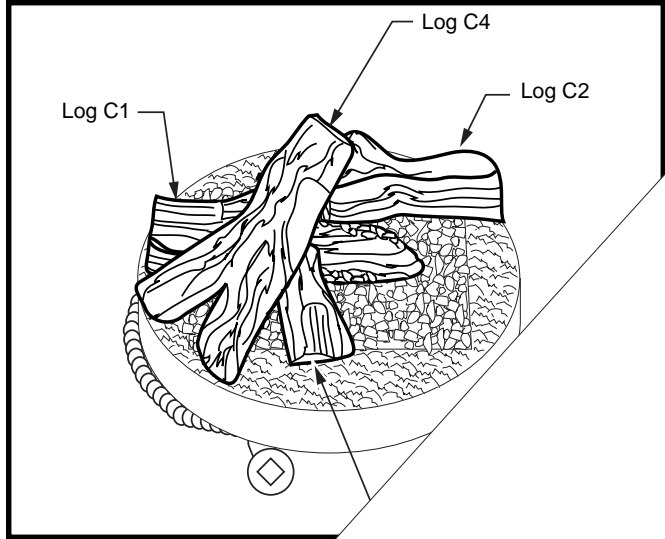
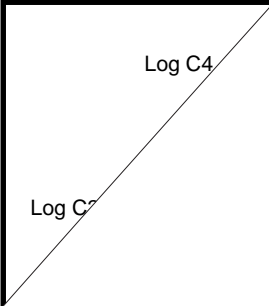

Fig. 13 Logs C3 & C4 place



log
e cc
oa

Operation

Upon completing the gas line connection, a small amount of air will be in the lines. When first lighting the burner, it will take a few minutes for the lines to purge themselves of this air. Once the purging is complete, the burner will light and operate as indicated in the instruction manual. Subsequent lighting of the appliance will not require such purging.

WARNING: Read and follow the Safety and Lighting Instructions page in this manual and on labels on the appliance. IF YOU DO NOT FOLLOW THESE INSTRUCTIONS PRECISELY, A FIRE OR EXPLOSION MAY RESULT AND YOU MAY BE SERIOUSLY INJURED!



Lighting And Operating Instructions

FOR YOUR SAFETY READ BEFORE LIGHTING



WARNING: If you do not follow these instructions exactly, a fire or explosion may result causing property damage, personal injury or loss of life.

- A. This outdoor cooking appliance must be lit manually. When lighting, follow these instructions exactly.
 - B. BEFORE LIGHTING smell all around the appliance area for gas. Be sure to smell next to the floor because some gas is heavier than air and will settle on the floor.
- WHAT TO DO IF YOU SMELL GAS**
- Do not try to light any fireplace
 - Do not touch any electric switch
 - Do not use any phone in your building
 - Immediately call your gas supplier from a neighbor's phone. Follow the gas supplier's instructions.
- If you cannot reach your gas supplier, call the Fire Department
 - C. Use only your hand to push in or turn the gas control knob. Never use tools. If the knob will not push in or turn by hand, do not try to repair it, call a qualified service technician. Applying force or any attempted repair may result in a fire or explosion.
 - D. Do not use this appliance if any part has been under water. Immediately call a qualified service technician to inspect the appliance and to replace any part of the gas control which has been under water.

Lighting Instructions

1. STOP! Read the safety information above.
2. Remove the cover.
3. Insert the "TEE" handle in the valve.
4. Place a burning match on top of burner in the middle where ports are present. DO NOT HOLD THE MATCH IN HAND.
 - For Natural Gas unit, turn the "TEE" handle slowly  counterclockwise.
 - For LP unit, turn valve on the LP tank  counterclockwise all the way and then turn the "TEE" handle on the valve slowly  counterclockwise.
5. If the burner does not light before the match goes out, immediately turn the gas valve to "OFF".
6. Wait at least five (5) minutes to clear out any gas. If you have unsuccessfully tried to light the burner, wait longer. Then smell for gas, including near the floor. If you smell gas, STOP! Follow "B" in the safety information above. If you do not smell gas, repeat step 4.

To Turn Off Gas To Heater

1. Turn the valve to the "OFF" position at the unit for natural gas unit. For LP unit, turn the valve to the "OFF" position, fully clockwise  at the unit, then turn the valve on the LP tank to the "OFF" position, clockwise .
2. Replace the cover.

Maintenance

1. The appliance should be inspected before initial use and inspected and cleaned at least annually by a qualified field service person.
2. Tampering is DANGEROUS and voids all warranties. Any component that is found to be faulty, must be replaced with an approved component.
3. To obtain proper operation, it is imperative that the burner flame characteristics are steady, not lifting or floating. Check the burner flame patterns with Figure 13.

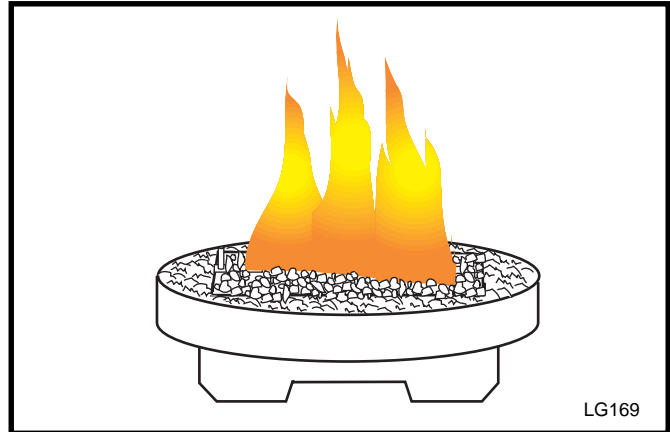

Fig. 17 Correct burner flame appearance.

High Elevation Installation

This U.L. listed gas appliance is tested and approved for elevations from 0 to 2,000 feet in the US and from 0 to 4,500 feet in Canada.

When installing this appliance at an elevation above 2,000 feet (in the US), it may be necessary to decrease the input rating by changing the existing burner orifice to a smaller size. Input should be reduced four percent (4%) for each 1,000 feet above sea level, unless the heating value of the gas has been reduced, in which case this general rule will not apply. To identify the proper orifice size, check with the local gas utility.

When installing this fireplace at an elevation between 2,000 and 4,500 feet (in Canada), the input rating must be reduced by ten percent (10%).

When installing this fireplace at an elevation above 4,500 feet (in Canada), check with local authorities.

Consult your local gas utility for assistance in determining the proper orifice for your location.



Fig. 16 GPF flame appearance.

4. Periodically remove the logs and examine the burner. If dirty, clean with a soft brush. Also examine the area around the burner air shutter. Any dirt or lint in this area should be removed. This will ensure long life and trouble free operation. When the appliance is put back in service, check the burner flame patterns with Figure 17. Reinstall the logs as shown in the log placement instructions.
5. Periodically check the hose connecting the LP gas cylinder to ensure it is not damaged in any way.

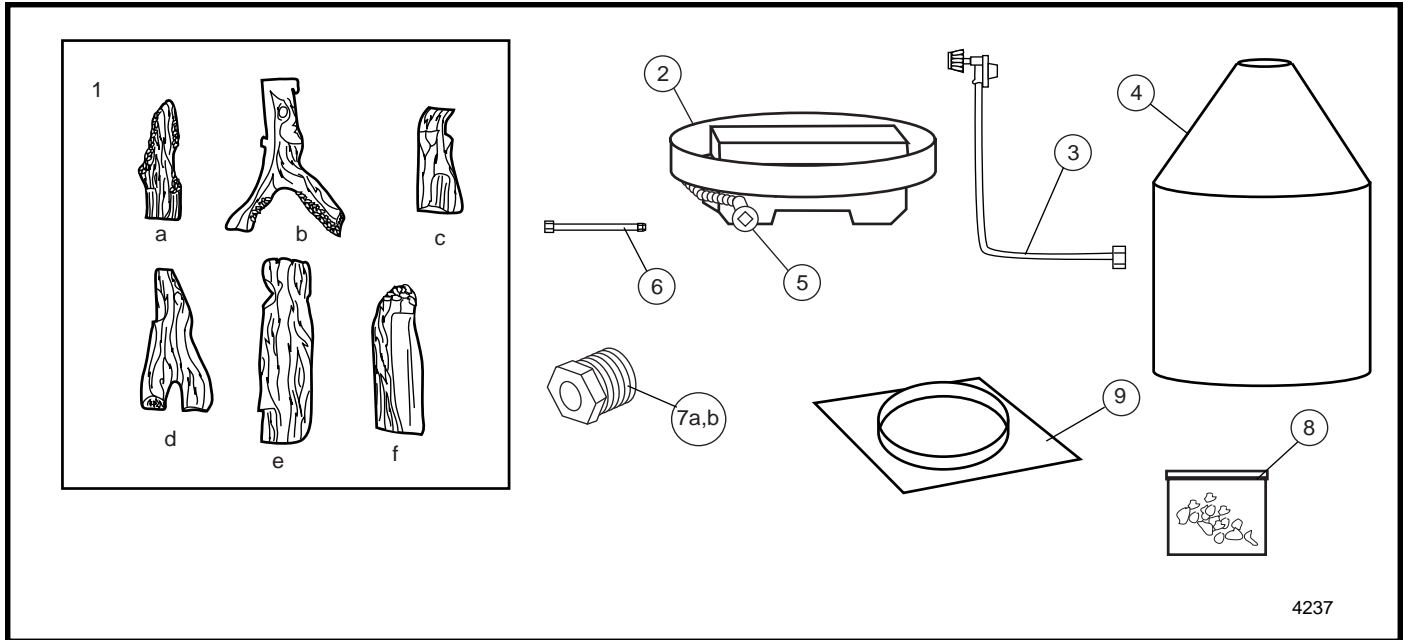

4237

The Vermont Castings Majestic Products Company reserves the right to make changes in design, materials, specifications, prices and discontinue colors and products at any time, without notice.

GPF

Item / Model Number	Part Number
1. Complete Log Set	20004457
1a. Log C1	20004451
1b. Log C2	20004452
1c. Log C3	20004454
1d. Log C4	20004453
1e. Log C5	20004455
1f. Log C6	20004456
2. Burner Assy.	20003733
3. Hose/Regulator Assy. - LP	50000248
4. Cover	20004450
5. Dante Valve	20004482
6. Natural Supply Line	50000198
7a. Short Stem Orifice - Natural	20004497
7b. Short Stem Orifice - LP	20004498
8. Volcanic Rock	20000198
9. LP Gas Cylinder Base	20004578
10. LP Conversion Kit	20004752
11. NG Conversion Kit	20004753

Contact The Vermont Castings Majestic Products Company with questions concerning prices and policies covering replacement parts. Parts may be ordered through your distributor or dealer.

Should you need additional information beyond what your dealer can furnish, contact:

The Vermont Castings Majestic Products Company
 410 Admiral Blvd.
 Mississauga, Ontario
 Canada L5T 2N6

You will need the following information when ordering replacement parts:

- The appliance model number.
- The serial number.
- A description of the part.

Accessories

The following accessories for these appliances are available from your local Vermont Castings Majestic Products Company distributor. Each accessory comes with a separate installation instruction for the particular appliance. Be sure to read each instruction thoroughly before installing.

Description	Model Number
Patio Fire Optional Safety Screen Kit	PFOSK
Villa Patio Fire (Urn) Base	PFCBUMB
Chalet Patio Fire (Octagonal) Base	PFCBOMB

CAUTION: This appliance is a highly engineered system, and, as such, must be operated only with The Vermont Castings Majestic Products Company approved components. If you use an unapproved component to make any modifications, you may create a possible fire hazard and will void the Vermont Castings Majestic Products Company warranty. In addition, such action may void the coverage provided by the owner's insurance.

LIMITED WARRANTY & EXTENDED LIFE TIME PROTECTION

For Vermont Castings Gas Appliance Products*

BASIC WARRANTY:

The Vermont Castings, Majestic Products Company (hereinafter referred to collectively as the "Company") warrants that your new Vermont Castings Gas Appliance is free from manufacturing and material defects for a period of one year from date of installation, subject to the following conditions and limitations.

EXTENDED LIFE TIME WARRANTY:

The heat exchanger, combustion chamber and ceramic burner parts of every *The Vermont Castings, Majestic Products Company products are warranted for life to the original owner, subject to proof of purchase and the following conditions and limitations:

1. This new Vermont Castings product must be installed by a competent, authorized service contractor. It must be installed and operated at all times in accordance with the Installation and Operating instructions furnished with the product. Any alteration, willful abuse, accident, or misuse of the product shall nullify this warranty.
2. This warranty is non-transferrable, and is made to the original owner, provided that the purchase was made through an authorized supplier of the Company.
3. This warranty is limited to the repair or replacement of part(s) found to be defective in material or workmanship, provided that such part(s) have been subjected to normal conditions of use and service, after said defect is confirmed by the Company's inspection.
4. The Company may, at its discretion, fully discharge all obligations with respect to this warranty by refunding the wholesale price of the defective part(s).
5. Any installation, labour, construction, transportation, or other related costs/ expenses arising from defective part(s), repair, replacement, or otherwise of same, will not be covered by this warranty, nor shall the Company assume responsibility for same. Further, the Company will not be responsible for any incidental, indirect, or consequential damages, except as provided by law.
6. All other warranties - expressed or implied - with respect to the product, its components and accessories, or any obligations/liabilities on the part of the Company are hereby expressly excluded.
7. The Company neither assumes, nor authorizes any third party to assume, on its behalf, any other liabilities with respect to the sale of this Vermont Castings product.
8. The warranties as outlined within this document do not apply to chimney components or other non Vermont Castings accessories used in conjunction with the installation of this product.
9. **The Company will not be responsible for . . .**
 - a) Down drafts or spillage caused by environmental conditions such as nearby trees, buildings, roof tops, hills, or mountains.
 - b) Inadequate ventilation or negative air pressure caused by mechanical systems such as furnaces, fans, clothes dryers, etc.
10. **This warranty is void if:**
 - a) The fireplace has been operated in atmospheres contaminated by chlorine, fluorine or other damaging chemicals.
 - b) The fireplace is subjected to prolonged periods of dampness or condensation.
 - c) Any damage to the fireplace, combustion chamber, heat exchanger or other components due to water, or weather damage which is the result of, but not limited to, improper chimney/venting installation.
 - d) Any alteration, willful abuse, accident, or misuse of the product.

GLASS DOORS & BRASS PLATED PARTS

Glass doors are not warranted for breakage due to misuse or accident.

Brass parts should be cleaned with lemon oil **only**. Brass cleaners **cannot** be used. Mortar mix and masonry cleaners may corrode the brass finish. The Company will not be responsible for, nor will it warrant any brass parts which are damaged by external chemicals or down draft conditions.

IF WARRANTY SERVICE IS NEEDED . . .

- 1) Contact your supplier. Make sure you have your warranty, your sales receipt, and the model/serial number of your Vermont Castings product.
- 2) **DO NOT ATTEMPT TO DO ANY SERVICE WORK YOURSELF.**

*The Vermont Castings, Majestic Products Company products bearing this special Warranty Seal of Approval carry a comprehensive Limited Lifetime Warranty. This includes the *Insta-Flame* Ceramic Burners, Heat Exchange System and Combustion Chamber. All other parts are covered for one year.



410 Admiral Blvd.
Mississauga ON L5T 2N6

GARANTIE DE BASE:

The Vermont Castings, Majestic Products Company (aux présentes nommée la "Société") garantit votre nouveau foyer au gaz Vermont Castings contre tous défauts de fabrication et de matières premières pour une période d'un an à compter de la date d'installation, sujet aux conditions et limitations suivantes.

GARANTIE A VIE PROLONGEE:

Les pièces de l'échangeur de chaleur, de la chambre à combustion et du brûleur en céramique de tout produit *The Vermont Castings, Majestic Products Company sont garanties pour la vie de l'acheteur d'origine, le tout sujet à une preuve d'achat et aux conditions et limitations suivantes:

1. Ce nouveau produit Vermont Castings doit être installé par un entrepreneur de service autorisé et compétent. Il doit être installé et utilisé en tout temps selon les instructions d'installation et de fonctionnement fournies avec le produit. Toute altération, abus volontaire, accident ou mauvais usage du produit annulera cette garantie.
2. Cette garantie n'est pas transférable et est offerte à l'acheteur au détail d'origine, à condition que l'achat soit effectué par l'entremise d'un détaillant autorisé de la Société.
3. Cette garantie est limitée à la réparation ou au remplacement de(des) pièce(s) trouvée(s) défectueuse(s) en matières premières ou main-d'oeuvre, à condition que lesdites pièces aient été sujettes aux conditions normales d'usage et de service, après que ledit défaut a été confirmé par une inspection par la Société.
4. La Société peut, à sa discrétion, se décharger entièrement de toutes obligations se rapportant à cette garantie en remboursant le prix de gros de la(des) pièce(s) défectueuse(s).
5. Tous les frais/dépenses d'installation, de main-d'oeuvre, de construction, de transport ou autres causés par une (des) pièce(s) défectueuse(s), une réparation, un remplacement ou autre, ne seront pas couverts sous cette garantie, et la Société n'assume aucune responsabilité pour ceux-ci. De plus, la Société ne pourra être tenue responsable pour tous dommages fortuits ou indirects sauf la ou prévu par la loi.
6. Toutes autres garanties, exprimées ou sous-entendues, en ce qui a trait au produit, ses composants et accessoires, ou toutes obligations/responsabilités de la part de la Société sont aux présentes expressément exclues.
7. La Société n'assume et n'autorise personne à assumer, en son nom, toutes responsabilités en ce qui a trait à la vente de ce produit Vermont Castings.
8. Les garanties, telles que décrites dans ce document, ne s'appliquent pas aux composants de cheminée ou aux autres accessoires non Vermont Castings utilisés conjointement pour l'installation de ce produit.
9. **La Société n'encourra aucune responsabilité pour . . .**
 - a) Les refoulements de cheminées ou débordements causés par les conditions environnementales comme par les arbres, les édifices, les toits, les côtes ou les montagnes adjacents.
 - b) Une ventilation inadéquate ou une pression d'air négative causée par des systèmes mécaniques comme les fournaies, les ventilateurs, les sècheuses, etc.
10. **Cette garantie est nulle si:**
 - a) Le foyer a été utilisé dans une atmosphère contaminée par du chlore, du fluor ou tous autres produits chimiques.
 - b) Le foyer est assujéti à de longues périodes d'humidité ou de condensation.
 - c) Des dommages sont causés au foyer, à la chambre de combustion, à l'échangeur de chaleur ou aux autres composants par de l'eau ou par la température qui est le résultat mais sans y être limité, d'une mauvaise installation de cheminée/ventilation.
 - d) Toute altération, abus volontaire, accident ou mauvais usage du produit annulera cette garantie.

PORTES EN VERRE & PIÈCES PLAQUÉES LAITON

Les portes en verre ne sont pas garanties contre le bris causé par un mauvais usage ou un accident.

Les pièces en laiton devraient être nettoyées qu'avec de l'essence de citron. Les nettoyeurs de laiton ne peuvent pas être utilisés. La Société ne sera pas responsable pour, et ne garantit pas les pièces en laiton qui sont endommagées par des conditions chimiques externes ou de refoulement.

SI UN SERVICE SOUS GARANTIE EST REQUIS . . .

1. Communiquez avec votre détaillant. Assurez-vous que vous avez votre garantie, votre reçu de caisse ainsi que le numéro de modèle/série de votre produit Vermont Castings.
2. **NE TENTEZ PAS D'EFFECTUER DES REPARATIONS VOUS-MEME.**

*Les foyers à gaz The Vermont Castings, Majestic Products Company portant ce sceau d'approbation de la garantie spéciale sont couverts par une garantie limitée à vie. Celle-ci inclut les brûleurs en céramique Insta-Flame, l'échangeur de chaleur et la chambre à combustion. Toutes les autres pièces sont couvertes pour un an.



The Vermont Castings
Majestic Products Company

410 Admiral Blvd. • Mississauga, Ontario, Canada L5T 2N6 • 905-670-7777
www.majesticproducts.com • www.vermontcastings.com

© The Vermont Castings Majestic Products Company

Free Manuals Download Website

<http://myh66.com>

<http://usermanuals.us>

<http://www.somanuals.com>

<http://www.4manuals.cc>

<http://www.manual-lib.com>

<http://www.404manual.com>

<http://www.luxmanual.com>

<http://aubethermostatmanual.com>

Golf course search by state

<http://golfingnear.com>

Email search by domain

<http://emailbydomain.com>

Auto manuals search

<http://auto.somanuals.com>

TV manuals search

<http://tv.somanuals.com>