



**WINCHESTER**  
RIFLES AND SHOTGUNS

Licensee

Important instructions for

## Winchester Model 9422 Lever Action Rifle

U.S. Repeating Arms Company, Inc.

275 Winchester Ave.

New Haven, CT, U. S. A. 06511-1970

*Winchester trademarks licensed from Olin Corporation.*

Use the space below to record information about your new Model 9422 rifle.

Model \_\_\_\_\_

Caliber \_\_\_\_\_

Serial Number \_\_\_\_\_

Purchased From \_\_\_\_\_

Date of Purchase \_\_\_\_\_

We sincerely hope that you are pleased with your new Winchester Model 9422 rifle. We at U.S. Repeating Arms Company thank you for the privilege of crafting this rifle for you. We are especially proud of the many years of enjoyment it is certain to provide for you and your family. The Model 9422 is another rifle in an over 130 year-old tradition of producing quality firearms for the World's sportsmen. Quality of manufacture, design, craftsmanship and function are of utmost concern to us. We believe you'll find that your new 9422 meets the Winchester tradition of quality in every way. If you have any questions or comments regarding your new firearm, please feel free to write us at our administrative offices:

Customer Service Department

U. S. Repeating Arms Company, Inc.

275 Winchester Avenue

Morgan, Utah 84050-9333

Phone: 1-800-945-5237

Print Code: 9803/94539

Contents	Page
Gun safety warnings .....	2
Features .....	4
General description .....	6
Terminology and descriptions .....	6
Serial number .....	7
Ammunition .....	8
Full disassembly/takedown .....	8
Operating instructions .....	11
How to load .....	12
How to operate .....	13
To unload the magazine and chamber .....	14
Sight adjustments .....	14
Mounting a scope .....	17
Using the hammer extension .....	17
Cleaning and maintenance suggestions .....	19
Ordering parts .....	22
Service or repair .....	22
Questions & <a href="http://www.Winchester-guns.com">www.Winchester-guns.com</a> .....	23

## **MODEL 9422**

---

**Over 25 years ago Winchester set out to create a new 22 caliber rifle.** They wanted it to be a quick handling, easy-to-use design with traditional craftsmanship and a large dose of 19th century nostalgia. The rest is history.

Importantly, your new Model 9422 is made by U.S. Repeating Arms Company in New Haven, Connecticut in one of the world's most modern firearms factories. The most current computer design and machining equipment was used. It is the the product of the world's most highly trained, highly skilled firearms craftsmen and women. Today's Model 9422 has a level of quality and precision that was not possible just a few years ago.

This manual covers all current versions of the Model 9422 rifle. Likely, you have one of two basic versions: the version that handles Long and Long Rifle cartridges interchangeably, or the special 22WMR (Magnum) version that handles the 22 WMR cartridge only. Study these entire instructions carefully to be sure you have covered all information about your specific Model 9422.

## GUN SAFETY WARNINGS

***IT IS ESSENTIAL THAT THESE OPERATING INSTRUCTIONS BE THOROUGHLY STUDIED BEFORE USING THIS FIREARM TO ASSURE PROPER AND SAFE GUN HANDLING. FAILURE TO FOLLOW THESE INSTRUCTIONS OR FAILURE TO OBEY ANY SAFETY WARNING MAY RESULT IN INJURY TO YOURSELF OR OTHERS, OR CAUSE DAMAGE TO YOUR GUN.***

As a gun owner, you accept a set of demanding responsibilities. How seriously you take these responsibilities can be the difference between life and death. There is no excuse for careless or abusive handling of any firearm. At all times handle your rifle and any other firearm with intense respect for its power and potential danger.

***PLEASE READ AND UNDERSTAND ALL OF THE CAUTIONS, PROPER HANDLING PROCEDURES AND INSTRUCTIONS OUTLINED IN THIS BOOKLET BEFORE USING YOUR NEW FIREARM.***

1. Do not carry a loaded gun with a live round in the chamber while walking, running, climbing a tree, crossing a fence or anywhere you might slip or fall, drop the gun or otherwise bump or jar the gun. A gun that is dropped,

bumped, or jarred with a chambered round might accidentally discharge even with the safety on, causing serious injury to you or someone else. When a round is chambered keep the safety on until you are ready to shoot.

2. Do not rely on the safety (half-cock position) to prevent accidental discharge. Many safeties merely block the trigger and prevent firing by pulling the trigger. The safety may not prevent an accidental discharge due to dropping, jarring, or bumping a gun.

3. Use only ammunition for which the gun is chambered as indicated on the barrel, to prevent excessive pressure and possible serious personal injury.

4. Incorrectly reloaded ammunition can cause serious personal injury and damage to the firearm due to excessive pressure. Reload only after proper instruction and in strict compliance with instruction and data contained in current reloading manuals.

5. Never point a gun at anything you do not intend to shoot. Always keep it pointed in a safe direction in case of accidental discharge.

6. Always check to ensure that the barrel is free of obstructions before loading and using the gun. If you experience light recoil or off sound, check the barrel for an obstruction.

7. Before firing, clean any grease or oil out of barrel with cleaning rod and patch. Grease or heavy accumulation of oil can cause excessive pressure and result in serious personal injury.
8. Keep barrel, chamber and action free of rust. Rust in the barrel and chamber can cause excessive pressures resulting in serious injury. A rusted, pitted or eroded barrel should be replaced.
9. Use hearing protection to prevent ear damage from repeated exposure to gunfire.
10. Always use proper shooting glasses to prevent eye injury from flying particles.
11. Never carry a loaded gun in a motor vehicle or carry one into a dwelling. Always carefully unload the gun before entering a motor vehicle, a dwelling or an area such as a camp. Always point a gun in a safe direction while loading or unloading to prevent serious injury in case of an accidental discharge. Never load in the house or in your vehicle.
12. Never shoot at a hard, flat surface or at the surface of water to avoid a ricochet and possible serious personal

injury to yourself or a bystander.

13. Store your gun in a clean dry place out of reach of children and separated from stored ammunition.
14. Never alter any parts of your gun. Any alterations or adjustments that may become necessary to the operating mechanism should be performed by a qualified gunsmith.
15. Hunting from elevated surfaces such as tree stands is dangerous. Doing so may increase the risk of handling any firearm. Always make certain that the stand being used is safe, sturdy and stable. Always make certain your firearm is unloaded when it is being taken up and down from the stand. Always make certain that your firearm is not dropped from the stand or dropped while it is being taken up or down from the stand.
16. Discharging firearms in poorly ventilated areas, cleaning firearms, or handling ammunition may result in exposure to lead and other substances known to cause birth defects, reproductive harm and other serious physical injury. Have adequate ventilation at all times. Wash hands thoroughly after exposure.

## **MODEL 9422 FEATURES**

*You can be proud of the Model 9422 in every way. The Model 9422 possesses classic lever action styling like no other 22 you can own. No other rifle has a feel and function that so closely emulates the famous Winchester lever actions of the last century. Its speed of handling combines with its top rimfire accuracy to make it the best choice — whether you are looking for a great plinking rifle or doing some serious small game hunting.*

*A hammer extension is provided with your Model 9422. This makes cocking the hammer convenient, even when using a scope.*

*The receiver top is grooved to easily accept rimfire-type scope bases. When your 9422 is taken down, the scope stays attached to the barrel half to preserve accuracy.*

*Conventional lever action design with three-position hammer.*

*Unlike some rifles made today, the 9422 comes with no compromises. You can feel the precision and craftsmanship in the smoothness of the action as you work the lever.*

*Whether yours has a walnut or laminated stock you'll enjoy the classic styling of the stock and forearm.*

*All-steel receiver and steel components. Every component of the internal firing mechanism is of durable metal.*

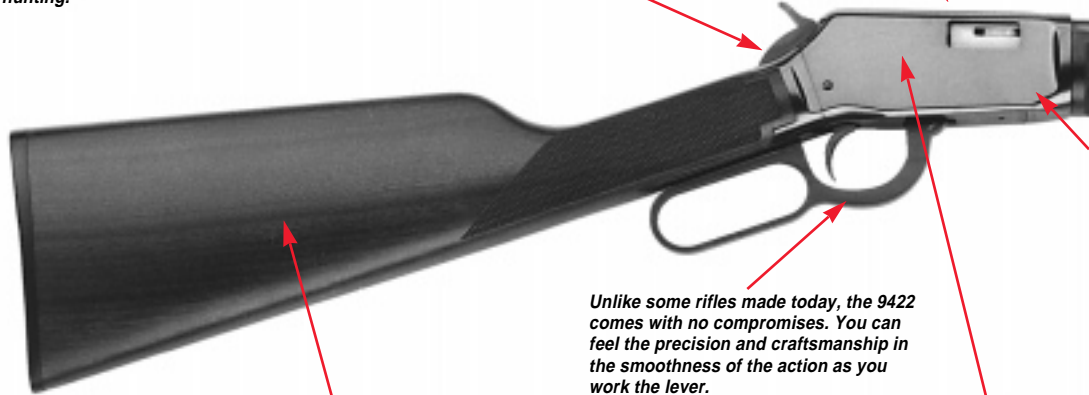

**FIGURE 1**

*Sights are made to handle rough conditions. Front and rear sights are drift adjustable for windage. The rear sight also features an elevator system for quick elevation changes, plus the sight blade can be adjusted for small changes with screw-type sight blade attachment.*

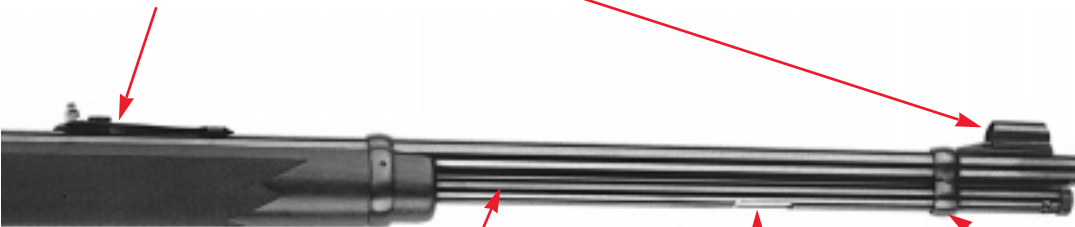

*The authentic look of the Model 9422 isn't just for fun. The Model 9422's lever action design with tubular magazine is reliable and fast handling.*

*The tubular magazine design with tube-mounted loading port makes loading easy for any hands, young or old.*

*The inner magazine tube is of durable brass. For convenience, the magazine follower is colored to distinguish it from a cartridge in the magazine.*

*Classic barrel band styling.*

*The quick take-down feature allows you to easily disassemble your Model 9422 into two halves. A single screw on the left side of the receiver is all it takes. It makes it easy to clean and oil your rifle, plus it allows cleaning of the muzzle from the breech end, protecting the crown of the barrel so you don't risk affecting accuracy.*

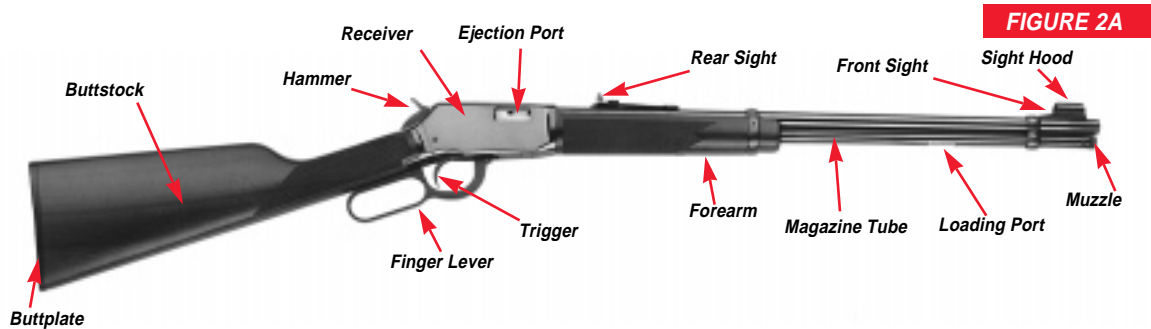

## GENERAL DESCRIPTION

---

Your new Model 9422 is one of several different versions and configurations offered. The basic operating procedures are the same for all of them. Where there are differences they are pointed out in this booklet for your convenience.

The Model 9422 is a lever action design that allows the shooter to load a round by cycling the action and moving a cartridge from a loaded magazine tube to the chamber. After firing, working the finger lever ejects the empty cartridge out the ejection port to the right. Returning the finger lever upward cycles a new cartridge from the magazine into the chamber. This can be repeated until the magazine is empty. The basic function and the classic

looks are much like that experienced by hunters, trappers, farmers and sportsmen with their Model 94 centerfire rifles.

## TERMINOLOGY AND DESCRIPTIONS

---

Descriptions in this booklet generally refer to the gun in the horizontal position. That is, in the normal firing position. For example, the muzzle is forward or front; the butt stock is rearward or rear; the trigger is downward or underneath; the sight is upward or on top.

Figure 1 covers the general features and benefits of the Model 9422 design. For general parts terminology, refer to Figures 2A through 2C.



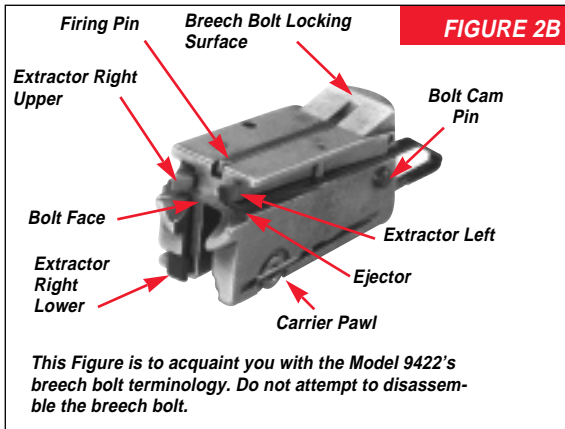

The Winchester Model 9422 is also shown disassembled to the extent necessary in order to follow instructions contained in this book (see Figure 9 later in this manual). Throughout this manual the “action” refers to the mechanism of this rifle which loads and secures the cartridges in the chamber.

### SERIAL NUMBER

The serial number is located in two places on your Model 9422: one on each half when disassembled (see Figure 3). One is on the bottom of the forward receiver/frame assembly (barrel half of the rifle) toward the front. The other is just rearward of the first one, on the rear receiver/frame assembly (buttstock half of the rifle). Record the serial number at the front of this book for future reference.

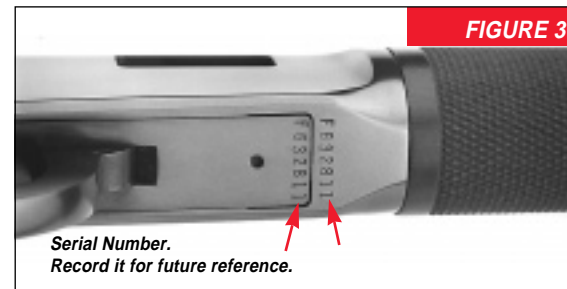
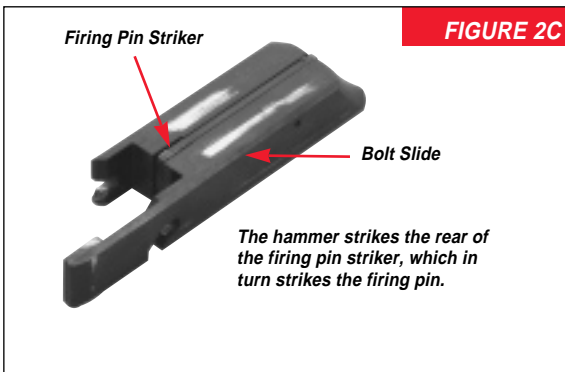

## AMMUNITION

---

The caliber of your Model 9422 is inscribed on left side of the barrel, toward the receiver. Three versions are currently made and will be marked one of these ways.

- **.22 S-L-L.R.** This model is designed to handle .22 caliber Shorts, Longs or Long Rifle cartridges only. These can be inserted into the magazine in any order. This version of the Model 9422 rifle is not designed to handle 22WMR (magnum) cartridges. All variations of this model are designed to function best with 22 Long Rifle cartridges.
- **.22 L-L.R.** Same as above but use of Shorts is not recommended.
- **.22 WMR.** This model is made to handle .22 caliber WMR (magnum) calibers only.

U.S. Repeating Arms Co. can assume no responsibility for incidents which occur through use of cartridges of nonstandard dimension or those developing pressures in excess of SAAMI (Sporting Arms and Ammunition Manufacturer's Institute) established standards.

Winchester ammunition is always an excellent choice for your new Winchester rifle, delivering the unmatched performance and dependability you want.

**DISCHARGING FIREARMS IN POORLY VENTILATED AREAS, CLEANING FIREARMS, OR HANDLING AMMUNITION MAY RESULT IN EXPOSURE TO LEAD AND OTHER SUBSTANCES KNOWN TO CAUSE BIRTH DEFECTS, REPRODUCTIVE HARM AND OTHER SERIOUS PHYSICAL INJURY. HAVE ADEQUATE VENTILATION AT ALL TIMES. WASH HANDS THOROUGHLY AFTER EXPOSURE.**

## FULL DISASSEMBLY / TAKEDOWN

---

Knowing how to easily take down your Model 9422 is important for cleaning and maintenance.

**TO ENSURE RIFLE IS UNLOADED, OPEN ACTION AND CAREFULLY CHECK CHAMBER AND MAGAZINE TUBE FOR AMMUNITION.**



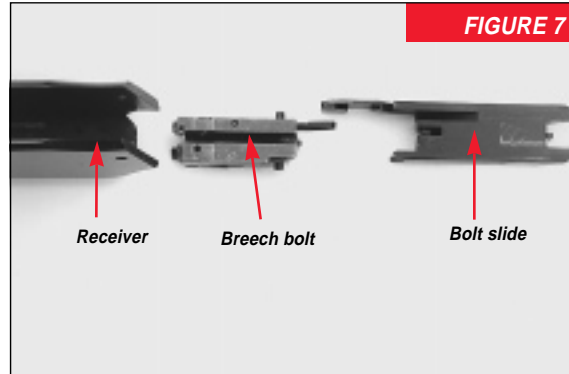
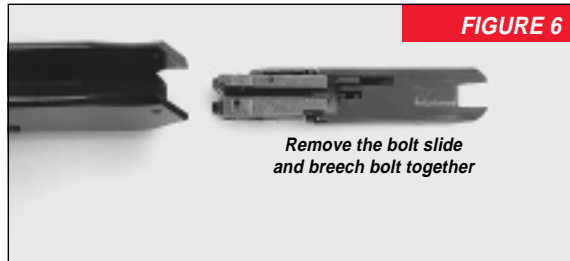
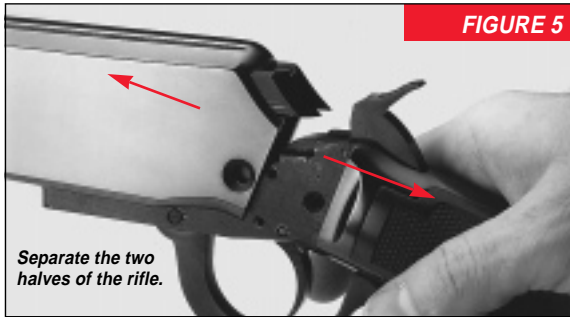

3. The bolt slide may now be removed by sliding rearward out of receiver (see Figure 6). Use care to prevent the cam pin from dropping free of the bolt.
4. Bolt and bolt slide may now be separated (see Figure 7).

#### DISASSEMBLY —

1. Unscrew and remove takedown screw on left side of receiver (see Figure 4).
2. Separate the gun into two halves by pulling the butt stock downward to the rear (see Figure 5).

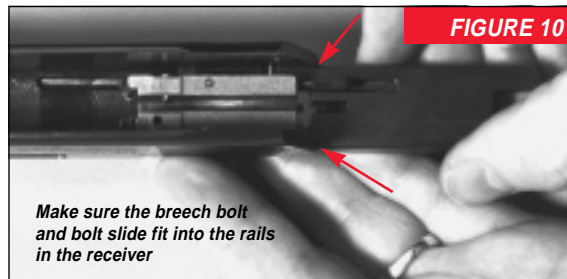
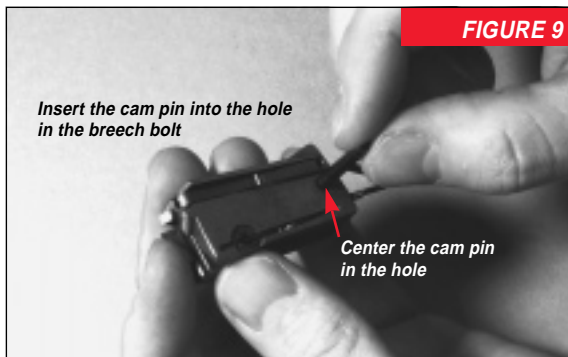
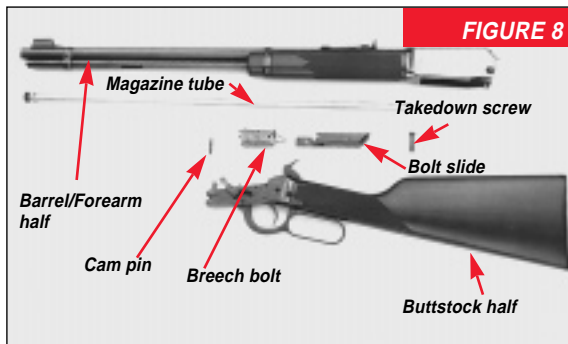

Your Model 9422 will now be in these pieces:  
(see Figure 8):

- Barrel/forearm half
- Buttstock half
- Breech bolt
- Bolt slide
- Cam pin
- Magazine tube
- Takedown screw

#### REASSEMBLY —

1. Assemble bolt and bolt slide, keeping cam pin centered (see Figure 9).
2. Insert assembly into the receiver from rear, pushing forward until it locks (see Figure 10).
3. Pull hammer back to full-cock position and close finger lever.

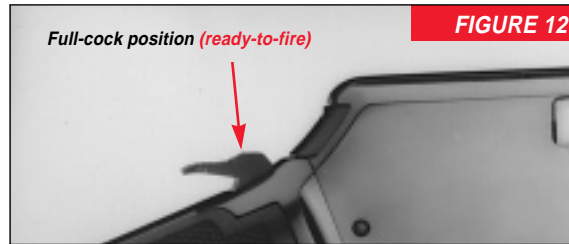
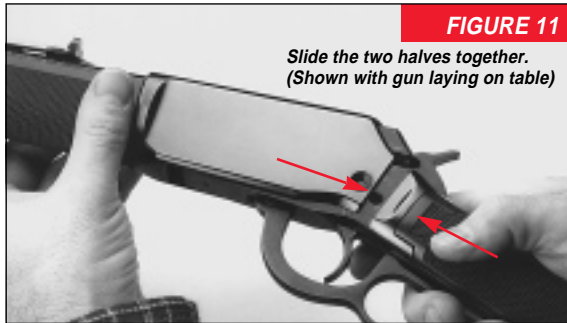

4. Slide the frame into the receiver from the rear (see Figure 11).

5. Insert and tighten the takedown screw. Be sure to lower hammer from full-cock position by carefully applying pressure on the trigger as explained under “Operating Instructions.”

## OPERATING INSTRUCTIONS

**CAUTION — ALWAYS KEEP THE MUZZLE POINTED IN A SAFE DIRECTION. PRIOR TO USING LIVE AMMUNITION, FAMILIARIZE YOURSELF THOROUGHLY WITH THESE OPERATING INSTRUCTIONS.**

Get accustomed to the feel of your new gun — know the forces required to operate the action,\* to pull the trigger and above all, know how to place the hammer into the safety position. The rifle is in the safety position when the hammer is in the half cocked location.

\*ACTION: The mechanism of a firearm which loads and secures the cartridge in the chamber.

### **HOW TO PLACE THE HAMMER INTO THE SAFETY (HALF-COCK) POSITION —**

First, with the gun pointed in a safe direction, cock the hammer by swinging the lever down and back. Then firmly hold the hammer back with your thumb. While holding the hammer, apply just enough pressure on the trigger to release the hammer from the full-cock position (Figure. 12).

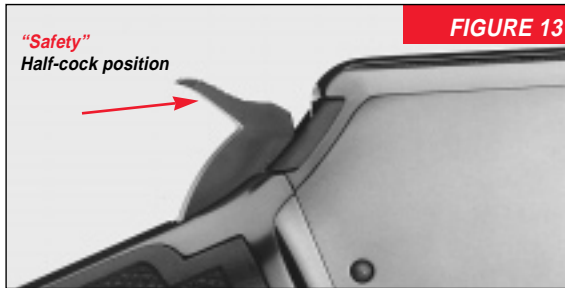

Immediately remove your finger from the trigger and slowly and carefully allow the hammer to lower into the “safety” half-cock position (Figure 13). When the chamber is loaded never place the hammer in the fired (down) position (Figure. 14).

***WARNING: THE HALF-COCK TYPE SAFETY IS DESIGNED TO SECURE THE HAMMER, HOLDING IT FROM CONTACTING THE FIRING PIN. HOWEVER, THIS MECHANISM WILL NOT NECESSARILY PREVENT THE ACCIDENTAL DISCHARGE OF THIS FIREARM AS A RESULT OF JARRING OR ABUSE SUCH AS OCCURS WHEN A FIREARM IS DROPPED.***

The safety (half-cock) arrangement is also designed to resist greater forces than are normally required to pull the

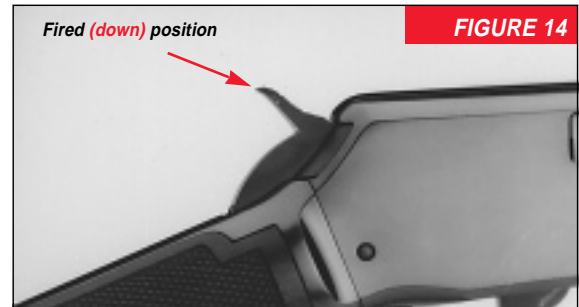

trigger. The half-cock position is not intended to test one's finger strength, but rather, to provide sufficient protection against unintentional or accidental firing. To forcibly pull on the trigger to cause the hammer to fall from the half-cock position will strain the parts and reduce the pressure needed to dislodge the hammer, thus damaging the safety feature of your rifle.

***IMPORTANT: CLEAN THE INSIDE OF THE BARREL AND CHAMBER TO REMOVE ALL GREASE AND OTHER POSSIBLE OBSTRUCTIONS BEFORE FIRING YOUR GUN.***

#### **HOW TO LOAD**

Use the correct ammunition referenced by the inscription

on the barrel. Before loading your gun be sure all grease and oil has been removed from the barrel and chamber, and there is no obstruction.

The rifle chamber is loaded by operating the finger lever, transferring a cartridge that has been previously placed in the magazine. To load the magazine, **first place the hammer in the safety (half-cock) position.**

Twist the magazine tube plug to unlock and pull the tube out until the colored follower clears the loading port in the outer magazine tube. With the muzzle pointed upward, insert the rimmed end of the cartridges into the magazine (Figure 15) and allow them to slide down towards the action. Do not exceed the recommended

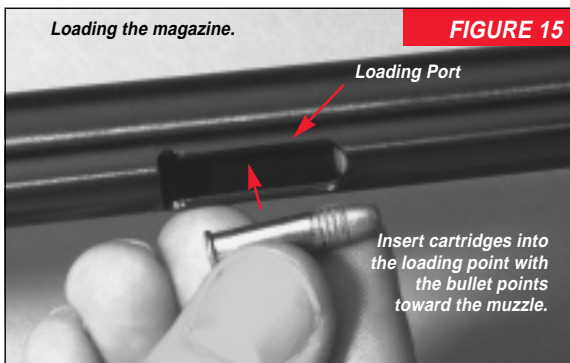

capacity of the magazine. Next, push the magazine tube down into position and lock into place.

Care should be taken while pushing the tube in, as it is under spring tension.

The rifle is now ready for operation.

## HOW TO OPERATE

---

Load the chamber by pivoting the finger lever down fully and return back to a closed position.

**CAUTION: THE HAMMER HAS BEEN AUTOMATICALLY MOVED FROM THE SAFETY (HALF-COCK) POSITION TO THE FULL COCK POSITION AND IS NOW SET TO FIRE. ALWAYS PLACE THE HAMMER BACK INTO THE SAFETY (HALF-COCK) POSITION UNTIL YOU ARE READY TO SHOOT.**

When ready to shoot, remove your finger from the trigger and firmly grip the hammer spur with your thumb, then carefully draw the hammer back to the full cock position.

Take aim and when on target, squeeze the trigger.

To chamber another round for the next shot, swing the finger lever down, extracting and ejecting the fired car-

tridge case from the chamber. The closing of the action will transfer a new cartridge from the magazine to the chamber, leaving the hammer in a cocked “ready to fire” position. When through firing always place the hammer in the safety (half-cock) position.

### **TO UNLOAD THE MAGAZINE AND CHAMBER**

---

Place the hammer in the safety (half-cock) position. With the rifle pointed upward, withdraw the inside magazine tube from the gun. Tip the gun downward allowing the cartridges to slide out into a suitable container. Replace the inside magazine tube. Operate the finger lever, opening the action to eject the round from the chamber. Look into the open action making sure there are no cartridges in the action, and see both the empty chamber and the colored magazine follower.

Always unload your gun when you have finished shooting, and before putting your gun away.

### **SIGHT ADJUSTMENTS**

---

All Model 9422 rifles are fitted with open sights. The style and adjustment system may vary between models and grades.

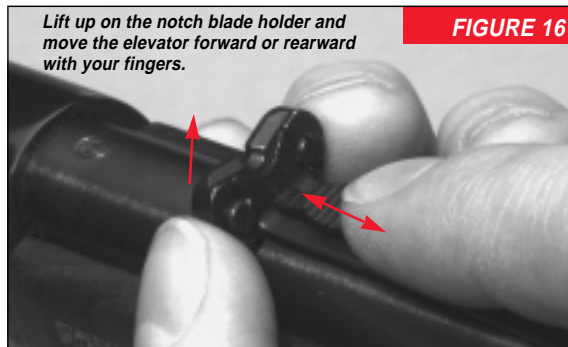

The proper procedure is to shoot a group with the sights set as they come from the factory (intermediate position on both elevation and windage), and then make incremental adjustments to move the sight blade and blade holder to position the group on your target. The procedures below are for the type of open sights found on current Model 9422 rifles.

***BEFORE MAKING ANY SIGHT ADJUSTMENTS, MAKE SURE YOUR RIFLE IS FULLY UNLOADED AND THE MUZZLE IS POINTED IN A SAFE DIRECTION. PLACE THE HAMMER IN THE HALF COCK (SAFETY) POSITION.***



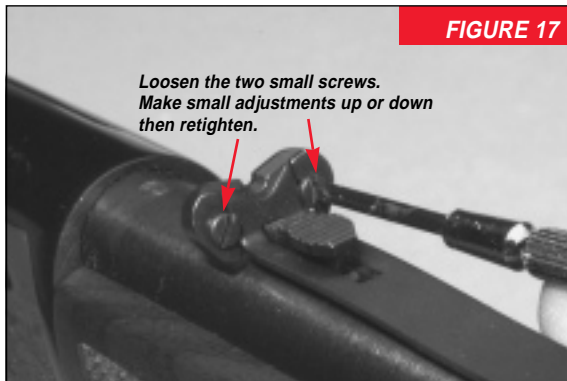

#### UP OR DOWN ELEVATION ADJUSTMENTS —

Adjusting elevation on your Model 9422 requires you to lift up the rear notch blade holder on your rifle's rear sight with your fingers and move the notched elevator either forward or backward (see Figure 16). To raise point of impact, use your fingers to lift up on the blade and slide the elevator rearward. Adjusting the sight to make your gun shoot lower is just the opposite — move the elevator forward. Remember:

- Move the blade and holder up to shoot higher.
- Move the blade and holder down to shoot lower.

For finer elevation adjustments the sight blade itself can be moved up or down. This is done by loosening the two screws that secure the blade to the blade holder and then moving the blade up or down as desired (see Figure 17). The screws are then retightened.

#### RIGHT OR LEFT WINDAGE ADJUSTMENTS —

On most Model 9422 sights, the entire rear sight blade holder is dove-tailed in the rear sight base. To adjust for windage, gently move the rear sight blade to the right or left by tapping at the dove-tail using a wood or fiber dowel or hammer that will not mar the sight (see Figure 18). If you tap to the right your gun will shoot more to the

right. Moving the blade holder to the left is just as easily done. Note how much you adjust the sight as you sight-in your Model 9422. Remember:

- Move the rear sight to the right to shoot farther to the right on the target.
- Move the rear sight to the left to shoot farther to the left on the target.

Care should be taken not to mar the finish, damage the attaching screws or bend sight components when adjustments are made.

The front sight bead is also held in a dove-tail mount on the sight base. It is possible to make windage adjustments by tapping it to one side or the other, just like the rear base. Remember, when adjusting the front sight you get the opposite results: move to the right and you shoot more to the left, move the bead to the left and you'll shoot more to the right.

All sight adjustments — of course — are a matter of trial and error. Remember, it is usually necessary to reset your sights when you change type or even brand of ammunition. High velocity 22 Long Rifle ammunition will almost always have a different point of impact than a target grade load or a hollow point load.

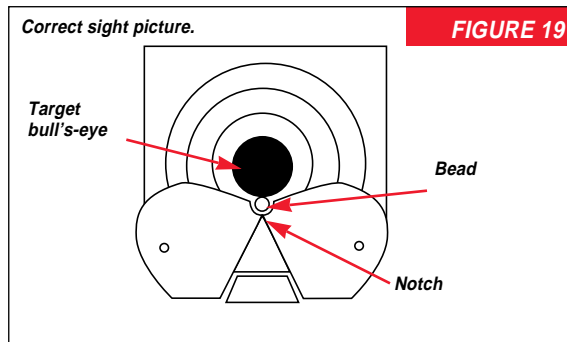

#### SIGHT MAINTENANCE —

Occasionally check your sights to make sure they have not been jarred or vibrated out of adjustment. This is especially important after extensive shooting or after hunting under rugged conditions. Check the two screws holding the rear sight blade in place on the blade mount and carefully tighten if necessary. Check the screw holding the front sight base to the barrel. The front hood is held in place by slight indents in each side rail. If necessary it can be removed by carefully pulling it forward and off. Re-installation is the reverse. Front and rear sight bases should always be tight on the barrel and dove-tails should be snug.

## SIGHT PICTURE —

The correct sight picture for the sights on your Model 9422 is with the front bead resting in the U-shaped notch in the sight blade. The bead itself should rest directly under the point of impact. For example, if you were shooting a conventional small bore target, the round, black bull's-eye would appear to rest on top of the front bead (see Figure 19).

## MOUNTING A SCOPE

---

The top of the receiver on every Model 9422 is grooved to accept standard 22 caliber rifle-type scope mounts. Depending on the type of bases and/or mounts you purchase, your rifle will accept thin-tube scopes, red-dot type sights or standard rifle scopes. On the 9422 the barrel is attached rigidly to the top portion of the receiver. So, even though your rifle is a take-down design, your scope stays sighted in even after the action is taken down.

Carefully follow all instructions provided with your scope mounts, rings and scope when mounting your scope. When a scope mount is used you may need to use the hammer extension provided with your rifle (refer to the instructions under “Using the Hammer Extension”).

## USING THE HAMMER EXTENSION

---

Your Model 9422 is provided with a hammer extension that makes it easier to operate the hammer when a scope is used. It is also recommend for use even when a scope is not installed. It offers an excellent grip and facilitates better control over the hammer. It should be found in a small bag inside the larger bag containing this owner's manual and other important literature. Also included is an allen wrench (hex-type) and set screw for securing the extension to your rifle's hammer. If your box did not contain an extension, an allen wrench and a small set screw, ask your dealer to locate yours.

The hammer spur can be used in either the left hand or right hand position. Installation is as follows:

**BEFORE ATTACHING YOUR HAMMER EXTENSION ALWAYS MAKE CERTAIN THERE ARE NO CARTRIDGES IN THE CHAMBER, MAGAZINE OR ACTION/FEED AREAS.**

**WARNING: PROPER MOUNTING OF THE HAMMER EXTENSION IS IMPORTANT TO PREVENT ACCIDENTAL DISCHARGE.**

1. Determine which side you want the extension to extend. For right-handed shooters the round, hollow part of the extension should protrude to the right. For left

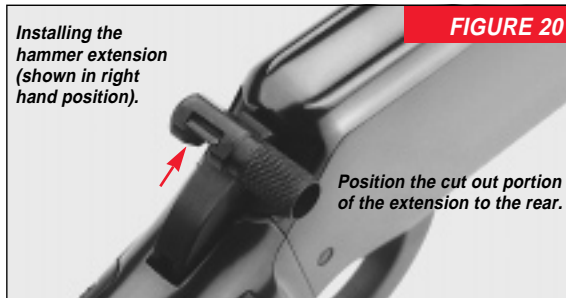

hand shooters it should protrude to the left side.

2. Slide the hammer extension over the end of the hammer spur. The notch in the mount has an internal rail that guides the extension into place. The cut out portion of the extension goes to the rear (see Figure 20)

3. The hammer extension is secured to the hammer with an allen wrench. It is located inside the hollow tube-like extension itself. With the extension pushed fully forward into position, insert the allen wrench into the head of the screw and tighten the allen screw against the side of the hammer.

If you have trouble starting the screw into the threads it may be because of the thread locking compound on the screw itself. This thread locking compound is a blue-green

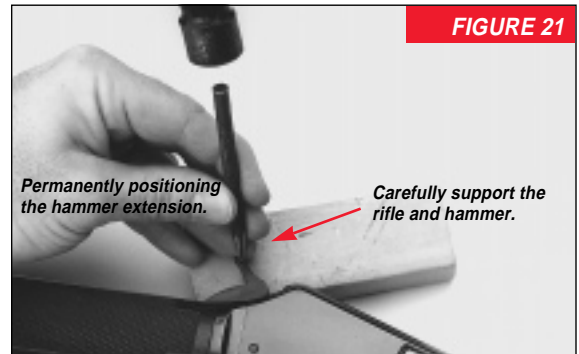

color and is important in keeping your extension tight on the hammer spur. To make it easier to start the screw you may need to back it out and clean the compound off of the first thread of the screw. Then reinsert and tighten lightly.

4. Test the extension by working the hammer through its full range. Under most circumstances the extension will operate best when fully forward on the hammer spur. If there isn't sufficient clearance between the extension and scope or if the extension contacts the receiver at full-cock, it is possible to reposition the extension slightly along the hammer spur.

5. Once the position of the extension has been finalized it

is important to “set” it permanently in place. Do this by tightening the set screw enough that it leaves a mark on the side of the hammer. Then remove the extension. Support the hammer on a firm work bench or padded anvil and center punch the mark left by the set screw. The gun and hammer must be well supported during this operation (see Figure 21).

6. Reinstall the hammer extension in the location determined previously. If the locking compound has been worn off of the screw you will want to put a drop of locking compound (like Loctite®) on the threads before inserting.

7. Tighten the set screw, making sure it engages into the indent made by the center punch.

***WARNING: HAMMER EXTENSIONS CAN LOOSEN WITH USE. OCCASIONALLY CHECK TO MAKE SURE YOUR HAMMER EXTENSION IS STILL ON TIGHTLY.***

### CLEANING AND MAINTENANCE SUGGESTIONS

Your Model 9422 will function better and more reliably over a longer period of time if it is properly maintained and kept clean.

***BEFORE PERFORMING ANY CLEANING PROCEDURES, ALWAYS MAKE CERTAIN THERE***

### ***ARE NO CARTRIDGES IN THE CHAMBER, MAGAZINE OR ACTION/FEED AREAS.***

You should clean your Model 9422 after every day of shooting and more often if it becomes excessively dirty.

A minimum cleaning includes wiping down the action and oiling key parts. Most regular maintenance will also include cleaning the barrel. If you encounter a function problem be sure to give your gun a thorough cleaning to see if it solves the problem before seeking the services of one of our Authorized Repair Centers, our service facility or a competent gunsmith. To clean your firearm, adhere to the following general guidelines.

#### **CLEANING PROCEDURES —**

***BE CERTAIN YOUR GUN'S CHAMBER AND MAGAZINE ARE UNLOADED. ALWAYS WEAR PROTECTIVE SAFETY GLASSES DURING ALL CLEANING PROCEDURES. KEEP AMMUNITION AWAY FROM THE CLEANING AREA. DO NOT TEST THE FUNCTION OF YOUR FIREARM WITH LIVE AMMUNITION.***

To protect the rifling at the muzzle of your rifle from damage (which can affect accuracy) take down your Model 9422 into the barrel/receiver half and the buttstock/lever half as explained previously.

When cleaning the bore with the rifle fully assembled, open the action and turn the gun so the ejection port on the right side of the receiver is down to prevent the bore cleaner from running into the action.

1. Use a cleaning rod with a tip and patch suitable for the size of your Model 9422's .22 caliber bore. Make sure the patch is large enough for a snug fit in the bore. Insert the rod and patch into the barrel *at the receiver end* and run it back and forth several times.

2. Inspect the chamber and bore for brass, copper, lead and powder fouling. A normal amount of powder residue can be expected and is not serious. It can usually be removed by repeating step one, using a patch saturated with solvent. If or when fouling should become heavy, it can be removed with a brass bore brush. Dip or spray the brush with solvent and scrub the chamber and bore until the fouling is removed. To prevent brass bristles from breaking off, the brush should be pushed completely through the bore before being withdrawn.

3. After fouling has been removed the bore should be wiped dry. Then pass a slightly oiled patch through the bore, for preservation. A fine, light gun oil is recommended.

4. Wipe all exposed metal surfaces of the receiver, forearm and barrel with a clean rag. Finger marks should be removed because they provide a place where moisture can accumulate. Any dried oil in the receiver area should also be removed.

5. Lightly oil your gun's action. Ordinary good judgment will, of course, indicate that the metal of the gun should receive a light film of oil any time the rifle has been exposed to weather or handling. This is very important and must be done with every gun. Remember, the polished, finely fitted surfaces of the receiver and action mechanisms must always have a thin film of oil. Make sure that the surfaces of the breech bolt and bolt slide are especially clean and lightly oiled with a high quality gun oil. Use solvent and a toothbrush or other suitable brush

to clean around the extractor, ejector and other small breech bolt components. An aerosol-type oil can help in “spraying away” residues on the breech bolt. When satisfied, wipe clean and lightly oil.

**6. INSPECT THE BARREL AND CHAMBER. TO MAKE CERTAIN THAT NO PATCHES HAVE BEEN INADVERTENTLY LEFT IN THEM.**

Remove any that remain.

7. Reassemble your rifle if you performed a complete cleaning.

8. Wipe all wood surfaces with a soft cloth.

9. When transporting only, store your Model 9422 in a quality protective case to prevent scratches and dents. For long term storage, store in a dry place to prevent corrosion. Store away from children.

**MAKE SURE YOUR RIFLE IS UNLOADED AND ALWAYS STORE AMMUNITION SEPARATELY.**

**OTHER CLEANING SUGGESTIONS —**

- Never pour large quantities of oil into the receiver or other parts. It can drain down to the wood and soften it — and cause permanent damage and loosening of the stock.
- After extended periods of heavy use, your rifle should be taken to a qualified gunsmith to have the action disassembled for professional cleaning and lubrication.
- Laminated wood (WinTuff and WinCam) models require the same care and cleaning as walnut or hardwood.

**NEVER ATTEMPT TO TAKE YOUR MODEL 9422 APART FURTHER THAN EXPLAINED IN THIS MANUAL.**

This is a specialized, finely fitted mechanism. You may permanently mar it by attempting to disassemble the inner mechanism assemblies. If further disassembly for service or cleaning is required, take your gun to a U. S. Repeating Arms Company Authorized Repair Center or a competent gunsmith as explained under “Service or Repair.”

## ORDERING PARTS

---

To order parts, please write our parts department and furnish the following: your name, address, and telephone number. Also specify the model and serial number of your Winchester firearm. When we receive your request, we will send an order form and a parts breakdown with prices.

Write to:

### Parts Department

U.S. Repeating Arms Company, Inc.

275 Winchester Avenue

New Haven, Connecticut 06511-1970

***CAUTION: PARTS ARE MADE FOR WINCHESTER BRAND FIREARMS MANUFACTURED BY OR FOR U.S. REPEATING ARMS COMPANY, INC., AND SHOULD NOT BE USED IN OTHER GUNS EVEN THOUGH MODELS MAY BE SIMILAR. IMPROPERLY FITTED PARTS MAY BE DANGEROUS.***

## SERVICE OR REPAIR

---

If your Winchester firearm should ever need repair or service, please utilize one of the world-wide network of U.S. Repeating Arms Company Authorized Repair Centers for Winchester firearms. If you have any questions about how to obtain service, call or write the Authorized Repair Center (ARC) nearest you. A list of ARCs is packaged with your new gun. If you need to obtain a new list of ARCs call us at:

1-203-789-5000



## QUESTIONS

---

If you have other questions about Winchester rifles and shotguns, call or write our Customer Service Department:

**Customer Service**

**U.S. Repeating Arms Company, Inc.**

**275 Winchester Avenue**

**Morgan, Utah 84050-9333**

**Phone: 1-800-945-5237**

## WINCHESTER-GUNS.COM

---

U.S. Repeating Arms Company offers an information resource for you on the world wide web.

- List of authorized repair centers.
- Customer service information.
- Answers to many technical and historical questions.
- Links to helpful sites.

Go to: [www.winchester-guns.com](http://www.winchester-guns.com)

## **You Are Responsible For Firearms Safety**

As a gun owner, you accept a set of demanding responsibilities. How seriously you take these responsibilities can mean the difference between life and death. Failure to follow any of these instructions can cause extensive damage to your gun and/or possible serious injury or death to yourself and others. There is no excuse for careless or abusive handling of any firearm. At all times handle any firearm with intense respect for its power and potential danger.

**PLEASE READ AND UNDERSTAND ALL OF THE CAUTIONS, PROPER HANDLING PROCEDURES AND INSTRUCTIONS OUTLINED IN THE OWNER'S MANUAL BEFORE USING YOUR NEW FIREARM.**

1. **ALWAYS KEEP THE MUZZLE OF YOUR RIFLE POINTED IN A SAFE DIRECTION**, even though you are certain that the rifle is unloaded. Never point any firearm at anything you do not intend to shoot. Be extremely alert and aware of all persons and property within the range of your ammunition.
2. **NEVER RELY TOTALLY ON YOUR RIFLE'S MECHANICAL "SAFETY" DEVICE**. The word "safety" describes a gun's trigger block mechanism, sear block mechanism, hammer block mechanism or firing pin block mechanism. These mechanical devices are designed to place your gun in a **SAFER** status. No guarantee can be made that the gun will not fire even if the "safety" is in the "on safe" position. See "**Operations of the Safety**" for instructions on operation of YOUR gun's "safety."  
**LIKE ANY MECHANICAL DEVICE, A "SAFETY" CAN SOMETIMES FAIL; IT CAN BE JARRED OR INADVERTENTLY MANIPULATED INTO AN UNSAFE CONDITION.**  
Mechanical "safeties" merely aid safe gun handling and are no excuse for pointing your rifle's muzzle in an unsafe direction.  
While it is a good idea to "test" your rifle's mechanical "safeties" periodically for proper function, **NEVER TEST IT WHILE YOUR RIFLE IS LOADED OR POINTED IN AN UNSAFE DIRECTION**  
Safe gun handling does not stop with your gun's mechanical "safety devices -- it starts there. Always treat your rifle with the respect due a loaded, ready-to-fire firearm.
3. **WHENEVER YOU HANDLE A FIREARM, OR HAND IT TO SOMEONE, ALWAYS OPEN THE ACTION IMMEDIATELY, VISUALLY CHECK YOUR RIFLE'S CHAMBER, FEED MECHANISM AND MAGAZINE.**  
Make certain they do not inadvertently contain any ammunition. Always keep the chamber empty and "safety" in the "on safe" position unless shooting is imminent.
4. **DO NOT TRANSPORT YOUR RIFLE LOADED, WHETHER IN A SCABBARD, GUN CASE, OR OTHER CONTAINER.**
5. **HUNTING FROM ELEVATED SURFACES SUCH AS TREE STANDS IS DANGEROUS**, and may increase the risk of handling a firearm. The following rules should always be observed by you and those you hunt with: **Always** make certain that the stand being used is safe and stable. **Always** make certain that your firearm is unloaded when it is being taken up to and down from the stand. **Always** make certain that your firearm is not dropped from the stand, or dropped while it is being taken up to or down from the stand. **Remember**, a loaded firearm may discharge when dropped, even with the safety in the "on safe" position.

6. **BEWARE OF BARREL OBSTRUCTIONS**, for the safety of both your gun and yourself. Mud, snow, and an infinite variety of other obstructions may inadvertently lodge in a barrel bore. It takes only one small obstruction to cause dangerously increased pressures that can ruin (swell or rupture) the finest rifle barrels.  
**BEFORE CHECKING FOR A BARREL OBSTRUCTION, BE CERTAIN NO LIVE ROUND IS IN THE CHAMBER AND THAT THE MAGAZINE IS REMOVED AND FEED MECHANISMS ARE COMPLETELY EMPTY. PLACE THE "SAFETY" IN THE "ON SAFE" POSITION.**  
Look through the barrel to be sure it is clear of any obstruction. If an obstruction is seen, no matter how small it may be, clean the bore with a cleaning rod and patch as described in "**Cleaning and Maintenance Suggestions.**" Before the first firing, clean the bore with a cleaning rod and patch, and wipe away any anti-rust compound in the action/chamber areas.
7. **ALWAYS UNLOAD YOUR RIFLE WHEN NOT IN USE. REFER TO "UNLOADING THE RIFLE" FOR AN EXPLANATION OF HOW TO UNLOAD YOUR RIFLE PROPERLY.**  
As a safety precaution, it is preferable to disassemble your gun for storage. Store your gun and ammunition separately -- well beyond the reach of children. Take all safeguards to ensure your rifle does not become available to untrained, inexperienced or unwelcome hands.
8. **USE THE PROPER AMMUNITION.**  
The barrel and action of this rifle have been made with substantial safety margins over the pressures developed by established American commercial loads. Nevertheless, Browning assumes no liability for incidents which occur through the use of cartridges of nonstandard dimensions which develop pressures in excess of commercially available ammunition with standards established by the Sporting Arms and Ammunitions Manufacturers' Institute (SAAMI).  
**BE ALERT TO THE SIGNS OF AMMUNITION MALFUNCTION.**  
If you detect an off sound or light recoil when a cartridge is fired, **DO NOT LOAD ANOTHER CARTRIDGE INTO THE CHAMBER.** Open the action and remove all cartridges from the magazine, chamber and action areas. With the action open, glance down the barrel to make sure that an obstruction does not remain in the barrel. If there is an obstruction, completely clear the barrel before loading and firing again. Failure to follow these instructions can cause extensive damage to your gun and possible serious injury to yourself and others.  
**MAKE SURE OF ADEQUATE VENTILATION IN THE AREA THAT YOU DISCHARGE A FIREARM. WASH HANDS THOROUGHLY AFTER EXPOSURE TO AMMUNITION OR CLEANING A FIREARM.**  
Lead exposure can be obtained from discharging firearms in poorly ventilated areas, cleaning firearms or handling ammunition. Lead is a substance that has been known to cause birth defects, reproductive harm and other serious injury.
9. **DO NOT SNAP THE FIRING PIN ON AN EMPTY CHAMBER -- THE CHAMBER MAY NOT BE EMPTY!**  
Treat every gun with the respect due a loaded gun, even though you are certain the gun is unloaded.
10. **KEEP FINGERS AWAY FROM THE TRIGGER WHILE UNLOADING, LOADING, UNTIL YOU ARE READY TO SHOOT.**

11. **BE SURE OF YOUR TARGET AND BACKSTOP.**  
Particularly during low light periods. Know the range of your ammunition. Never shoot at water or hard object.
12. **ALWAYS UNLOAD YOUR RIFLE'S CHAMBER BEFORE CROSSING A FENCE, CLIMBING A TREE, JUMPING A DITCH OR NEGOTIATING OTHER OBSTACLES.**  
Refer to "**Unloading The Rifle**" for instructions on the unloading of your rifle. Never place your loaded rifle on or against a fence, tree, car or other similar object.
13. **WEAR EYE AND EAR PROTECTION WHEN SHOOTING.**  
Unprotected, repeated exposure to gunfire can cause hearing damage. Wear ear protectors (shooting ear plugs or muffs) to guard against such damage. Wear shooting glasses to protect your eyes from flying particles. Allow proper distance (eye relief) between the scope and your eye when firing a scoped rifle or shotgun. Always keep a safe distance between the muzzle of your firearm and any persons nearby, as muzzle blast, debris and ejecting shells could inflict serious injury. Also, wear eye protection when disassembling and cleaning your shotgun to prevent the possibility of springs, spring-tensioned parts, solvent or other agents from contacting your eyes.
14. **DROPPING A LOADED GUN CAN CAUSE AN ACCIDENTAL DISCHARGE** even with the "safety" in the "on safe" position. Be extremely careful while hunting or during any shooting activity, to avoid dropping any firearm.
15. **IF YOUR RIFLE FAILS TO FIRE, KEEP THE MUZZLE POINTED IN A SAFE DIRECTION.**  
Hold this position for a minimum of 30 seconds. Carefully open the action and remove the cartridge. If the primer is indented, the cartridge should be disposed of in a way that cannot cause harm. If the primer is not indented, your firearm should be examined by a qualified gunsmith and the cause of the malfunction should be corrected before further use.
16. **BE DEFENSIVE AND ON GUARD AGAINST UNSAFE GUN HANDLING AROUND YOU AND OTHERS.**  
Don't be timid when it comes to gun safety. If you observe other shooters violating any of these safety precautions, politely suggest safer handling practices.
17. **BE CERTAIN YOUR RIFLE IS UNLOADED BEFORE CLEANING.** Because so many gun accidents occur when a firearm is being cleaned, special and extreme care should be taken to be sure your gun is unloaded before disassembly, cleaning and reassembly. Keep ammunition away from the cleaning location. Never test the mechanical function of any firearm with live ammunition.
18. **TEACH AND SUPERVISE FIREARMS SAFETY TO ALL MEMBERS OF YOUR FAMILY -- ESPECIALLY TO CHILDREN AND NONSHOOTERS.**  
Closely supervise newcomers to the shooting sports. Encourage enrolling in hunting/shooting safety courses.
19. **NEVER DRINK ALCOHOLIC BEVERAGES OR TAKE ANY TYPE OF DRUGS BEFORE OR DURING SHOOTING.**  
Your vision and judgment could be dangerously impaired, making your gun handling unsafe to you and to others.

20. **READ AND HEED ALL WARNINGS** in this instruction book, on ammunition boxes and with all accessories that you install on your firearm. It is your responsibility to secure the most up-to-date information on the safe handling procedures of your Browning gun. Browning assumes no liability for incidents which occur when unsafe or improper gun accessories or ammunition combinations are used.
21. **PERIODIC MAINTENANCE -- AVOID UNAUTHORIZED SERVICING.**  
Your rifle is a mechanical device which will not last forever, and as such, is subject to wear and requires periodic inspection, adjustment and service. Browning firearms should be serviced by a Browning Recommended Service Center or by Browning's service facility in Arnold, Missouri. Browning cannot assume any responsibility for injuries suffered or caused by unauthorized servicing, alterations or modifications of Browning firearms.
22. **BROWNING RESERVES THE RIGHT TO REFUSE SERVICE ON FIREARMS THAT HAVE BEEN ALTERED, ADDED TO OR SUBSTANTIALLY CHANGED.**  
Removal of metal from barrel(s), or modification of the firing mechanism and/or operating parts may lead to Browning's refusal of service on such firearms. Browning will charge the owner parts and labor to return the firearm to original Browning specifications.  
**DO NOT, UNDER ANY CIRCUMSTANCES, ALTER THE TRIGGER, SAFETY OR PARTS OF THE FIRING MECHANISM OF THIS OR ANY OTHER FIREARM. FAILURE TO OBEY THIS WARNING MAY RESULT IN INJURY OR DEATH TO YOURSELF OR OTHERS.**

**BE CAREFUL!**



**WINCHESTER**  
EST. 1857

U.S. Repeating Arms Company, Inc.

275 Winchester Avenue

New Haven, Connecticut, U.S.A. 06511-1970

Administrative Offices:

275 Winchester Avenue, Morgan, Utah 84050-9333

## Free Manuals Download Website

<http://myh66.com>

<http://usermanuals.us>

<http://www.somanuals.com>

<http://www.4manuals.cc>

<http://www.manual-lib.com>

<http://www.404manual.com>

<http://www.luxmanual.com>

<http://aubethermostatmanual.com>

Golf course search by state

<http://golfingnear.com>

Email search by domain

<http://emailbydomain.com>

Auto manuals search

<http://auto.somanuals.com>

TV manuals search

<http://tv.somanuals.com>