



MICRONIX PC/104 POWER SUPPLY

PV-1700, 1800 SERIES

*20W Power Supply including GSM/GPRS modem, analogue
and digital I/O channels*

User Manual & Installation Guide

Ver. 1.2



DOC: M5258DM

Micro Technic A-S • Denmark •
Tel. +45 6615 3000 • Fax +45 6615 3077
E-mail: support@micro-technic.com
Website: www.micro-technic.com

Table of contents

GENERAL INFORMATION.....	2
ORDERING CODES	2
ANALOGUE CONFIGURATIONS	2
ACCESSORIES.....	2
DESCRIPTION	2
BLOCK DIAGRAM	2
CONNECTORS.....	2
POWER SUPPLY.....	2
MODEM	2
<i>Modem status LED</i>	2
<i>Setting up the module</i>	2
<i>SIM card</i>	2
<i>Modem AUX connector CN3</i>	2
<i>AT commands</i>	2
<i>Modem on/off</i>	2
RS232 PORT (CN6).....	2
<i>Setting up RS232</i>	2
<i>RS232 connector (CN6)</i>	2
ANALOGUE INPUTS (CN5)	2
DIGITAL INPUTS (CN 1)	2
<i>Counter inputs</i>	2
DIGITAL OUTPUTS (CN2).....	2
UPS SIGNALS (CN7).....	2
PV-1800 REGISTER INTERFACE.....	2
<i>Base address</i>	2
<i>Internal registers</i>	2
TECHNICAL DATA.....	2
MECHANICAL LAYOUT	2
INSTALLATION GUIDE.....	2
PRECAUTIONS TO ESD.....	2
SETTINGS AND CONNECTIONS	2
FACTORY SETTINGS	2

General information

Ordering codes

Model no	Ordering no		Options					
	-S	-	Power Supply	Modem	Analog inputs	Digital inputs	Digital outputs	RS232
PV-1700 -1	016.104.138	016.104.139	X		X	X	X	X
PV-1700 -2	016.104.140	016.104.141						
PV-1700 -3	016.104.142	016.104.143						
PV-1700 -4	016.104.144	016.104.145						
PV-1700 -5	016.104.146	016.104.157						
PV-1700A -1	016.104.148	016.104.149			X	X	X	X
PV-1700A -2	016.104.150	016.104.151						
PV-1700A -3	016.104.152	016.104.153						
PV-1700A -4	016.104.133	016.104.154						
PV-1700A -5	016.104.155	016.104.156						
PV-1720	016.104.128	016.104.127	X			X	X	
PV-1720A	016.104.157	016.104.158				X	X	
PV-1730	016.104.159	016.104.087	X					
PV-1800 -1	016.104.088	016.104.160	X	X	X	X	X	X
PV-1800 -2	016.104.115	016.104.161						
PV-1800 -3	016.104.116	016.104.162						
PV-1800 -4	016.104.117	016.104.124						
PV-1800 -5	016.104.101	016.104.114						
PV-1800A -1	016.104.163	016.104.164		X	X	X	X	X
PV-1800A -2	016.104.118	016.104.165						
PV-1800A -3	016.104.119	016.104.166						
PV-1800A -4	016.104.120	016.104.167						
PV-1800A -5	016.104.121	016.104.168						
PV-1820	016.104.089	016.104.102	X	X		X	X	
PV-1820A	016.104.123	016.104.169		X		X	X	
PV-1830	016.104.096	016.104.100	X	X				
PV-1830A	016.104.106	016.104.170		X				

-S = Stack-through PC/104 connector

Analogue configurations

PV-1700-S, PV-1700A-S, PV-1800-S and PV-1800A-S are available with different analogue configurations.

The configuration is indicated by a digit following the model number, e.g. PV-1800-S-1. Possible configurations are available:

Digit	Configuration
-1	8AI: AI0-7 = 0-2.5V
-2	8AI: AI0-7 = 0-5.0V
-3	8AI: AI0-7 = 0-10.0V
-4	8AI: AI0-7 = 0-20.0mA
-5	8AI: AI0-3 = 0-2.5V, AI4-7 = 0-20mA

Accessories

These accessories must be ordered separately if needed.

Model no	Ordering code	Description
GSM cable	126.033.000	RG136 cable with MMCX-SMA MALE 140mm
GSM Antenna	060.302.001	GSM antenna with SMA connector
CM-2	425.104.001	Mains cable with one crimp connector mating KL1, 30cm
CDB-9M	425.104.002	Cable with one DSUB9 male and one 10pin IDC-connector, 30cm Used for connecting RS232.
CDB-9F	425.104.003	Cable with one DSUB9 female and one 10pin IDC-connector, 30cm Used for connecting Ain, Din, Dout and Modem AUX.

Description

The PV-1800, the fully equipped model, offers the following features:

- a PC/104 20W power supply +5V, 4A.
- a dual band GSM/GPRS modem (Sony Ericsson GM47)
- 8 isolated analogue inputs, 12 bit
- 8 digital inputs, opto-isolated
- 7 digital outputs, opto-isolated
- one RS232 serial port
- non-isolated simple I/O's.

Block diagram

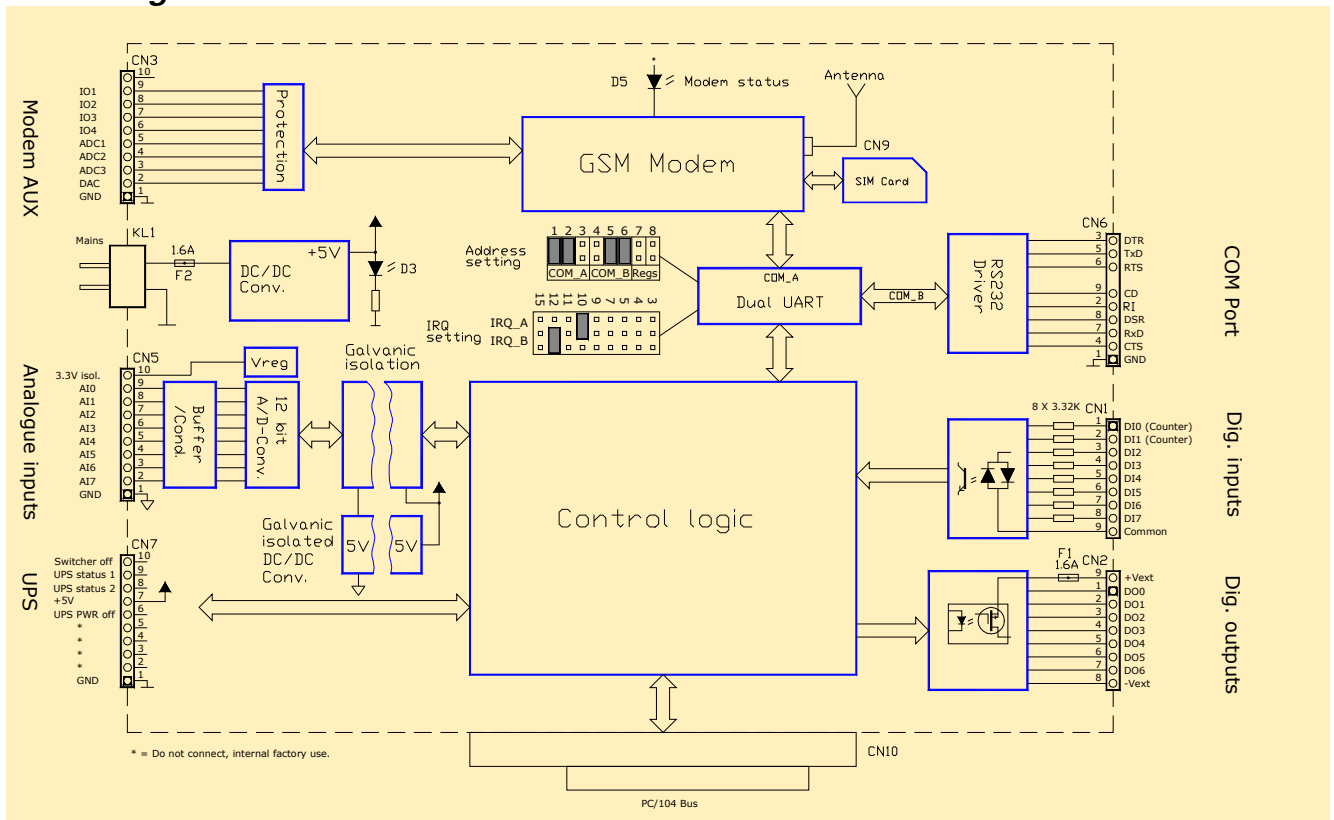

All models, except A-versions, has an onboard DC/DC converter that converts the incoming mains (+8-35V DC) to +5V. This power supply delivers +5V, up to 4A, to the module and to the PC/104 bus. A mains fuse F2 (1.6A) is placed on the rear side of the PCB, near KL1. In A-versions, where the DC/DC-converter is omitted, the module receives its power from the PC/104 bus.

The GSM modem is placed on the top side of the PCB while the SIM card connector is placed on the rear side. The locking mechanism is indicated on the top of the SIM card holder. The connector for the antenna is placed on the GSM modem itself. The base address of the registers and COM ports, and IRQs for the modem and the COM port on CN6, are set by two jumper blocks.

The analogue section (PV-1800, PV1700 only) is available in different configurations including pure voltage inputs (0-2.5V, 0-5V and 0-10V), pure current inputs (0-20mA) and with mixed inputs (0-2.5V and 0-20mA). The configuration must be decided when ordering – see section *ordering codes*.

The digital I/O section is found on all models except PV-1830 and PV-1730 versions. The digital inputs are bipolar isolated with a max. input voltage of +/- 30V. There are 7 isolated digital P-channel outputs each capable of driving up to 0.5A. The load current must be supplied from an external voltage source not exceeding 30V. The UPS connector contains control signals that can be used with external UPS circuitry.

Connectors

The PV-1800 is equipped with several I/O connectors:

- One 2 pole pin header (KL1) for mains power in.
- One MMCX connector for GSM antenna.
- One 10-way box header (CN3) with non-isolated simple I/Os.
- One SIM Card connector (CN9) placed on the rear side of the PCB.
- One 10-way box header (CN1) for digital inputs.
- One 10-way box header (CN2) for digital outputs.
- One 10-way box header (CN5) for analogue inputs.
- One 10-way box header (CN6) for RS232.
- One PC/104 connector (CN8) for bus interface.

Furthermore, there are 10 connection pads/holes (CN7) for special UPS functions.

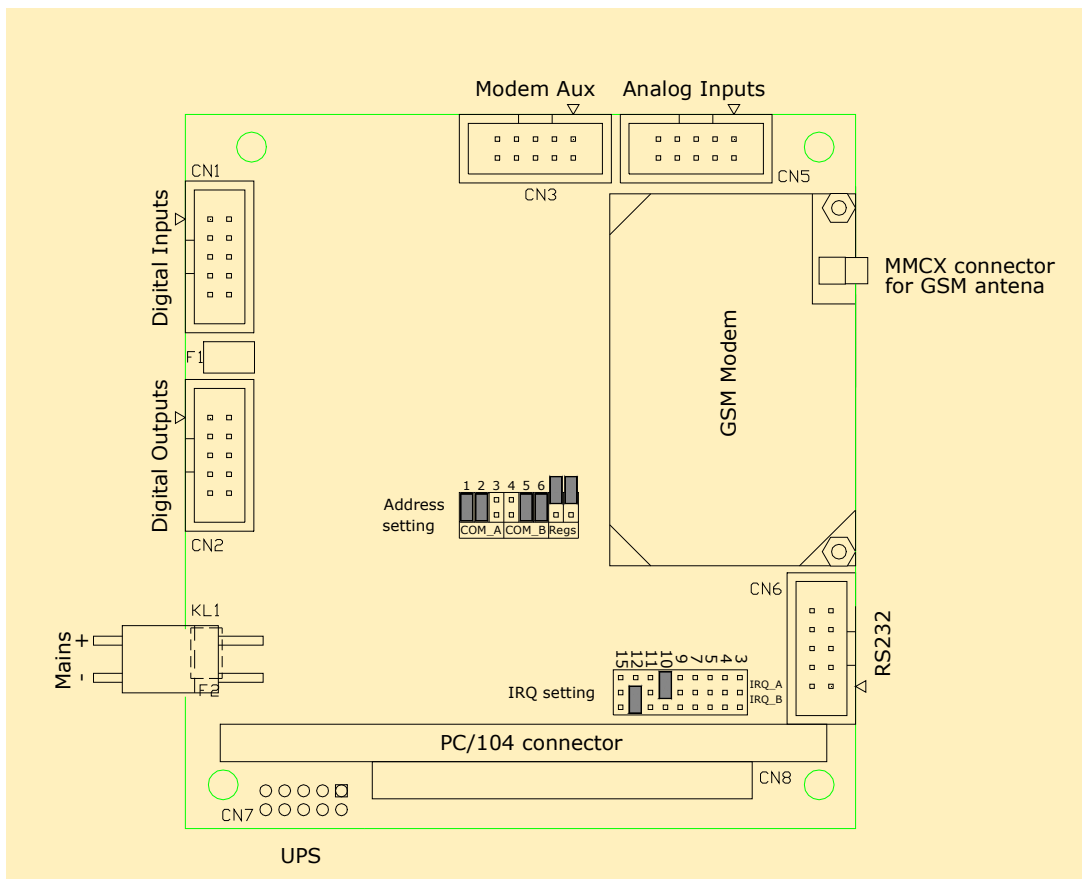

Pin numbers of the box headers are shown in this schematic.

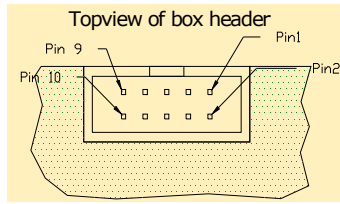

Power Supply

The on-board power supply consists of a synchronous step-down switching regulator with an efficiency of 85-95%, depending on input voltage and load current. At nominal input voltage (24V DC) and a load current of 2A the efficiency is 92%. A green status LED, placed on the rear side of the PCB, is on when the +5V is present.

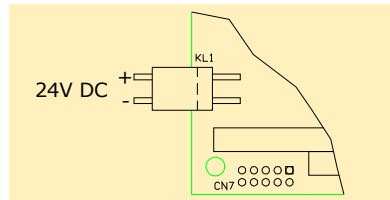

The connector for the power input is a 2 pole pin header from Molex. The mating part for this connector is Molex 10-17-3020 with 2 crimp terminals – Molex 2478.

Modem

The modem unit used in the PV-18xx module is a Sony Ericsson GM47 which is a GSM dual band product for 900/1800 MHz. The unit is placed in a 60pin socket and secured by two M2 screws and nuts.

Modem status LED

A yellow status LED is connected to the modem. This LED is placed on the rear side of the PCB. The LED has this function:

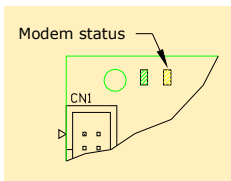

Modem LED	Status
Off	Modem off
On, steady	Power on, not connected to network
On, flashing	Power on, connected to network

Setting up the module

All communication between the modem and the CPU is done through an on-board 16C550 compatible UART. The COM port and the IRQ used for the modem are set by two jumper blocks. The address is set by one to three jumpers in positions 1 to 3 in section COM_A. The table shows how different COM ports can be configured.

ST1			Base address
1	2	3	COM_A
0	0	0	Disabled
0	0	1	2C8
0	1	0	2D8
0	1	1	2E8 (COM4)
1	0	0	2F8 (COM2)
1	0	1	3D8
1	1	0	3E8 (COM3)
1	1	1	3F8 (COM1)

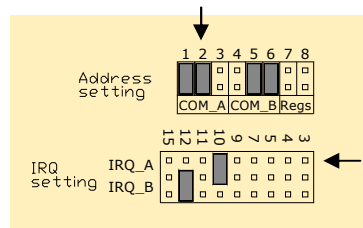

This table is also printed on the board.

The IRQ used for the modem is set in section IRQ_A. Place one jumper in this section to select an IRQ number in the interval IRQ3 to IRQ15.

SIM card

The SIM card connector (CN9) is placed on the rear side of the module. A SIM card must be placed in this connector in order to establish a wireless communication.

Modem AUX connector CN3

The modem has a built-in interface for simple non-isolated digital and analogue channels. This includes:

- Four digital inputs
- Three 8-bit ADC inputs
- One 8-bit DAC output

The table shows the connector layout:

Pin no	Name	Signal name in modem	Pin no CDB-9F
1	GND		1
2	DAC	DAC	6
3	ADC #3	ADC3	2
4	ADC #2	ADC2	7
5	ADC #1	ADC1	3
6	Digital input #4	IO4	8
7	Digital input #3	IO3	4
8	Digital input #2	IO2	9
9	Digital input #1	IO1	5
10	NC		

The protection circuitry between the modem and CN3 is shown here.

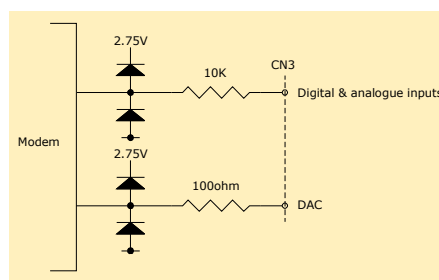

These I/Os are operated by AT commands in the modem.

AT commands

All functions of the modem are carried out by AT commands from a computer application. For documentation of the AT command set please see “Integrators Manual” for GM47 from Sony Ericsson, at http://www.eurodis.com/wireless/hm/suppliers_sonyericsson.asp

Modem on/off

The PV-18xx has circuitry that automatically turns the modem on after a system reset, by activating its ON/OFF input. From software, you can later activate the ON/OFF input, please see section *PV-1800 register interface*.

RS232 port (CN6)

The PV-1800 and PV-1700 is equipped with a 16C550 compatible RS232 port which can be accessed through a 10pin boxheader (CN6).

Setting up RS232

The setup of the serial port is configured by two jumper blocks. The address is set by placing one or more jumpers in the positions 4 to 6 in section COM_B. The table shows how different COM ports can be configured:

ST1			Base address
4	5	6	COM_B
0	0	0	Disabled
0	0	1	2C8
0	1	0	2D8
0	1	1	2E8 (COM4)
1	0	0	2F8 (COM2)
1	0	1	3D8
1	1	0	3E8 (COM3)
1	1	1	3F8 (COM1)

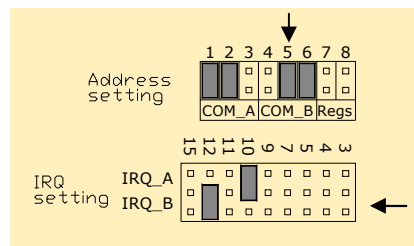

This table is also printed on the board.

The IRQ used for the RS232 is set in section IRQ_B. Place one jumper in this section to select an IRQ number in the interval IRQ3 to IRQ15. Be aware not to make conflict with COM-ports on the CPU module.

RS232 connector (CN6)

The serial connector is a 10pin 2.54mm boxheader placed on the edge of the module. This pinout is chosen so that a 10-wire ribbon cable with a 10-pin connector in one end and a DB9 male connector in the other end can be used. In this way, the DB9 male connector acts like a serial port in a PC.

Function	Pin no CN9	Pin no CDB-9M	I/O
GND	1	5	
RI	2	9	I
DTS	3	4	O
CTS	4	8	I
TxD	5	3	O
RTS	6	7	O
RxD	7	2	I
DSR	8	6	I
CD	9	1	I
N.C.	10		

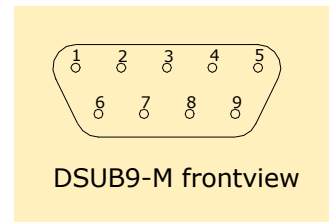

Analogue inputs (CN5)

The PV-1800 and PV-1700 has 8 isolated analogue inputs accessible in a 10pin box header (CN5). Beside these inputs, there is also a +3.3V isolated voltage with common ground reference as the analogue inputs. This voltage can be used to power external conditioning circuitry - (max 10mA). Depending on the model – see section *ordering codes* – each input will have a full scale of 2.5V, 5.0V, 10V, or 20mA. The table shows the connector layout:

Pin no	Name	Pin no CDB-9F
1	Analogue GND	1
2	Analogue input#7	6
3	Analogue input#6	2
4	Analogue input#5	7
5	Analogue input#4	3
6	Analogue input#3	8
7	Analogue input#2	4
8	Analogue input#1	9
9	Analogue input#0	5
10	+3.3V Isolated	

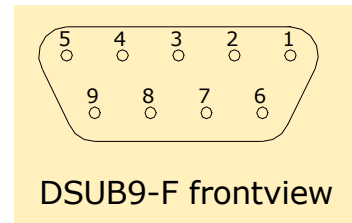

The input circuitry looks like this:

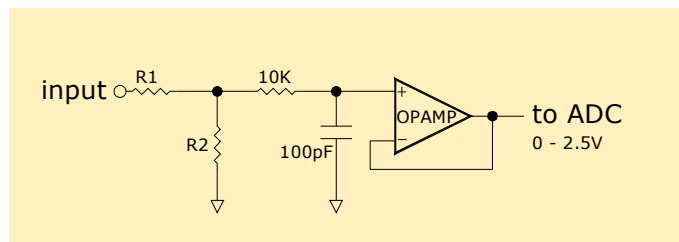

The analogue inputs are factory configured by choosing proper values for R1 and R2. In the table the values are shown for the different models. The input resistance is 1MΩ on all voltage input channels. The software interface is explained in section *PV-1800 register interface*.

Configuration	R1	R2
0 - 2.5V	0 ohm	1 Mohm
0 - 5 .0V	449 Kohm	449 Kohm
0 - 10.0V	741 Kohm	247 Kohm
0 - 20mA	0 ohm	125 ohm

Differential measurement

The analogue inputs can two by two be used for differential measurement. Inputs, which can make up a pair, are defined in the software. One of the wires, in each pair, is inside the ADC connected as a ‘negative’ input; the other as a ‘positive’ input. The common mode voltage on the ‘negative’ input must not exceed 0.5V in a 0 – 2.5V configuration and 1V in a 0 - 5V configuration. The combinations of the actual inputs used for differential measurement are shown in section - *PV-1800 register interface*. Also here it is described which input that is used as the ‘negative’.

Digital inputs (CN 1)

All models, except PV-1830 and PV-1730 has 8 isolated digital inputs connected to a 10-pin box header (CN1). All the inputs have ac-couplers with a common ground reference. Because of the ac-couplers, the inputs can be activated with positive as well as negative input voltages. The table shows the connector layout:

Pin no	Name	Pin no CDB-9F
1	Digital input #0	1
2	Digital input #1	6
3	Digital input #2	2
4	Digital input #3	7
5	Digital input #4	3
6	Digital input #5	8
7	Digital input #6	4
8	Digital input #7	9
9	GND	5
10	NC	

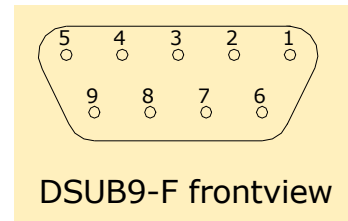

The input circuitry looks like this:

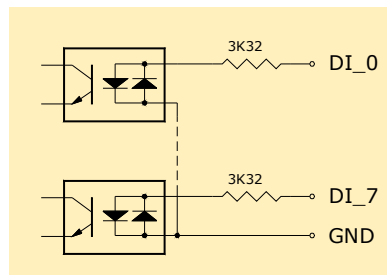

Counter inputs

The digital input section includes a 16-bit counter. Besides acting as normal digital inputs, input #0 and #1 can also be used as counter inputs.

- Input #0: counter input for the 16-bit counter.
- Input #0 together with input #1: counter inputs for a 16-bit quadrature counter.

The counter function can be software programmed to be in one of four modes.

The counter modes are shown here:

Mode	Function
0	Disabled
1	Increment on rising edges on DI #0
2	Increment on falling edges on DI #0
3	DI #0 and DI #1 act as a quadrature counter

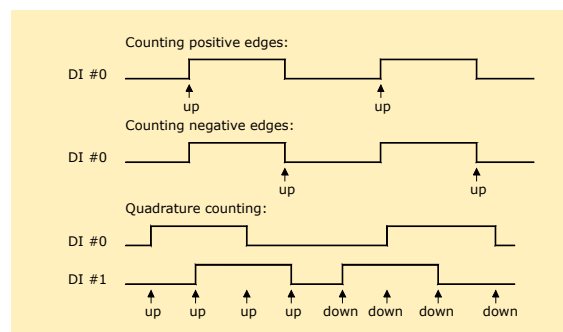

The software interface is explained in section *PV-1800 register interface*.

Digital outputs (CN2)

The digital section has 7 isolated digital outputs connected to a 10pin box header (CN2). The outputs are configured as PNP outputs with their transistors connected to an external supply voltage (+V_EXT). The table shows the connector layout:

Pin no	Name	Pin no CDB-9F
1	Digital output #0	1
2	Digital output #1	6
3	Digital output #2	2
4	Digital output #3	7
5	Digital output #4	3
6	Digital output #5	8
7	Digital output #6	4
8	-Vext	9
9	+Vext	5
10	NC	

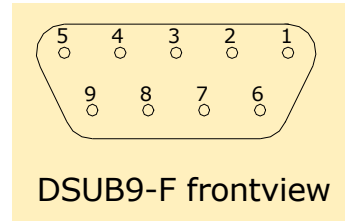

The output circuitry looks like this:

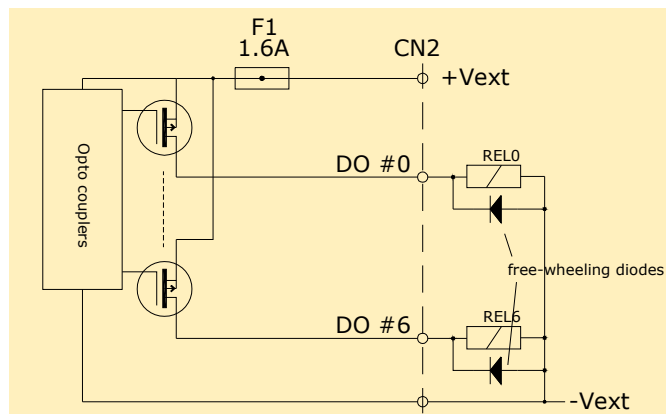

Attention!

The user has to add proper free-wheeling diodes across inductive loads to protect the output transistors against high voltages.

The software interface is explained in section *PV-1800 register interface*.

UPS signals (CN7)

Modules with onboard DC/DC converter has signals that, combined with external circuitry, can be used to implement a UPS function. There is an input for turning off the 20W power supply (SWITCHER_OFF), two status inputs (UPS_STATUS1 and UPS_STATUS2), and an output (UPS_PWROFF) that can tell the external circuitry to turn off power after a programmable delay.

Connector layout:

Pin no	Name
1	GND
2	*
3	*
4	*
5	*
6	UPS_PWROFF
7	+5V
8	UPS_STATUS2
9	UPS_STATUS1
10	SWITCHER_OFF

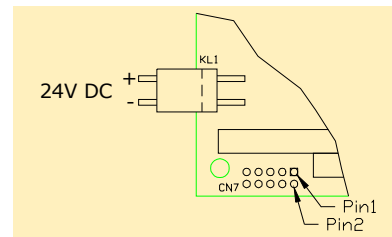

* = do not connect, for internal factory use.

PV-1800 register interface

All modules, except PV-1730 has a register interface with three blocks of I/O ports: the modem UART, the external RS232

UART and the internal registers. The UARTs are 16C550 compatible and use eight I/O ports each.

The base addresses of the modem UART and external RS232 UART are configured on configuration jumper 1,2,3 and 4,5,6 respectively, see the table printed on the board. The IRQ of both UARTs are configured on the IRQ jumpers. You cannot use the same IRQ for both UARTs.

Base address

Configuration jumper 7, 8 configure the base address of the sixteen internal registers. This table is also printed on the board.

ST1	Base address
7 8	Registers
0 0	200h
0 1	220h
1 0	300h
1 1	320h

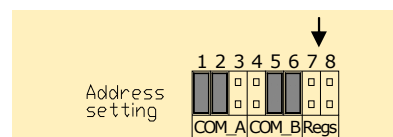

Internal registers

Address	Access	Name	Function
Base+0	Read only	REG_SIGN	Signature (8Ch)
Base+1	Read only	REG_MODEL	Model
Base+2	Read/write	REG_DIGOUT	Digital outputs
Base+3	Read only	REG_DIGIN	Digital inputs
Base+4	Read only	REG_CNTLO	Counter LSB
Base+5	Read only	REG_CNTHI	Counter MSB
Base+6	Read/write	REG_CNTMODE	Counter configuration
Base+7	Read/write	REG_MODEM	Modem status and on/off command
Base+8	Read/write	REG_UPS	UPS status
Base+9	Read/write	REG_UPSSHDN	Delayed UPS shutdown
Base+0Ah	Read/write	REG_ADCLO	ADC command/result LSB
Base+0Bh	Read/write	REG_ADCHI	ADC result MSB
Base+0Ch	-	reserved	
Base+0Dh	-	reserved	
Base+0Eh	-	reserved	
Base+0Fh	-	reserved	

REG_SIGN (base+0): Signature (read only)

Always reads 8Ch. Can be used by software to verify the presence of a module with register interface.

REG_MODEL (base+1): PV-1800 firmware model number (read only)

When the firmware is changed to remove, add, or change features, the model number is changed. Current model number is 00h.

REG_DIGOUT (base+2): Digital outputs (read/write)

Writing to bit 0-6 sets digital output 0-6. 0=off, 1=on.

Reading bit 0-6 returns the current status of digital output 0-6.

Bit 7 is always 0.

REG_DIGIN (base+3): Digital inputs (read only)

Reading bit 0-7 returns the current status of digital input 0-7. 0=off, 1=on.

DI0 and DI1 can also be used as counter inputs. Regardless of this, their current status can always be read at this register.

REG_CNTLO (base+4): Counter low byte (read only)

Reading this register returns bit 0-7 of the current value of the counter, and simultaneously stores bit 8-15 of the counter in the REG_CNTHI register.

REG_CNTHI (base+5): Counter high byte (read only)

Reading this register returns the previously stored value of bit 8-15 of the counter.

REG_CNTMODE (base+6): Counter configuration (read/write)

The counter starts at 0000h after system reset. It cannot be reset or reloaded from software.

Bits: 000000**cc**

cc = counter mode (read/write):

00 = counter disabled, DI0 and DI1 are ignored

01 = counts rising edges of DI0

10 = counts falling edges of DI0

11 = quadrature counter on DI0 and DI1

REG_MODEM (base+7): Modem status and on/off control (read/write)

Bits: 00000**vlo**

v: (read only) 1 = VIO voltage (2.75V) on, 0=off.

l: (read only) Modem LED status. 0=LED off, 1=LED on.

o: (read/write) Force on/off. Writing '1' to this bit pulls the modem on/off pin low. To turn the modem on or off, you should write '1' to this bit, wait at least two seconds, and then write '0' to this bit.

The module has logic that automatically turns the modem on at system reset.

REG_UPS (base+8): UPS status (read only)

The UPS status inputs have no other function than being readable here.

Bits: **ab**000000

a: UPS status1 input from external UPS logic

b: UPS status2 input from external UPS logic

REG_UPSSHDN (base+9): UPS delayed shutdown timer (read/write)

This register holds the number of seconds until the external UPS logic is told to turn off power.

The UPS_PWROFF output is low (0V) when the system should run normally, and high (3.3V) when external UPS circuitry should turn off power.

FFh: Idle, no delayed shutdown is in progress. UPS_PWROFF is low.

00h: Delay expired, UPS_PWROFF is high.

Other values: Delay in progress, the counter decrements towards 00h. UPS_PWROFF is low.

A delayed shutdown is initiated by writing the desired number of seconds to this register. A delayed shutdown in progress can be modified (by writing a new value to this register), cancelled (by writing FFh), or you can turn off immediately by writing 00h.

REG_ADCLO (base+0Ah): ADC command, status, and result low byte (read/write)

Writing to this register starts a new A/D conversion. You should only do this when the ADC is idle.

Command bits: 0000**dccc**

d: 0:single-ended, 1=differential

ccc: Channel.

d	c	c	c	Conversion
0	0	0	0	AIN0 relative to AGND
0	0	0	1	AIN1 relative to AGND
0	0	1	0	AIN2 relative to AGND
0	0	1	1	AIN3 relative to AGND
0	1	0	0	AIN4 relative to AGND
0	1	0	1	AIN5 relative to AGND
0	1	1	0	AIN6 relative to AGND
0	1	1	1	AIN7 relative to AGND
1	0	0	0	Differential AIN0(+) - AIN1(-)
1	0	0	1	Differential AIN1(-) - AIN0(+)
1	0	1	0	Differential AIN2(+) - AIN3(-)
1	0	1	1	Differential AIN3(-) - AIN2(+)
1	1	0	0	Differential AIN4(+) - AIN5(-)
1	1	0	1	Differential AIN5(-) - AIN4(+)
1	1	1	0	Differential AIN6(+) - AIN7(-)
1	1	1	1	Differential AIN7(-) - AIN6(+)

Reading REG_ADCLO returns status and result bits.

Result bits: **rrrr00pb**

p: ADC present. If 1, the ADC is available. If 0, the ADC is not mounted, and you should not write to REG_ADCLO.

b: Busy. 0 = ADC idle. The previous result can be read, and a new conversion can be started. 1 = conversion in progress. All result bits are invalid when **b**=1.

rrrr: Four least-significant bits of the conversion result. Only valid when **b**=0.

REG_ADCHI (base+0Bh): ADC result, high byte (read only)

Reading this register returns the eight most-significant bits of the conversion result. Only valid when the ADC is idle.

Technical data

Power supply		
Input voltage (nominal)	8 – 27Vdc.	
Input voltage (MAX)	35Vdc.	
Output voltage	5Vdc	
External load	Up to 4A, depending on configuration and thermal conditions.	
UPS interface:		
4 pins in CN7	Run/stop, AUX1,AUX2,AUX3 (factory use only).	
GSM-modem:		
Modem type	GM47 (SonyEricsson).	
SIM card interface	3V or 5V	
Frequency range	EGSM 900 MHz	1800 MHz (Dual Band).
Maximum RF output power	2W	1W
Antenna impedance	50 Ω	
Antenna connector type	MMCX RF connector	
Supported I/Os (using AT commands)	Available in 10pin connector	
3 Analogue inputs *	8 bit, 0 – 2.75V	
1 Analogue output *	8 bit, 0 – 2.475V	
4 general purpose digital inputs *	0 – 2.75V	
COM ports:		
Number of ports	Two, one used for GSM modem	
Addressing range	2C8h, 2D8h, 2E8h, 2F8h, 3D8h, 3E8h, 3F8h, disabled	
IRQs supported	3, 4, 5, 7, 9, 10, 11, 12, 15	
Connector	Port 2 available in 10pin box header.	
Analogue inputs:		
Resolution	12 bit	
Inputs	8 ch. single ended or 4 ch. differential – one common	
Isolation	1kV, 1 minute	
Input range configurations (all unipolar)	8 x 0–2.5V (default) or 8 x 0-5V or 8 x 0-10V or 8 x 0-20mA or 4 x 0-20mA + 4 x 0-2.5V	
Input impedance	1MΩ (default).	
Accuracy	0.5% of FSR, ±3LSB (default)	
Conversion time	11us	
Connector type	10 pin box header	
Digital inputs:		
Number of channels	8 isolated, one common ground	
Digital logic levels	0 – 24V, non-polarity, Input low voltage: 0 – 1.5V Input high voltage: 10 – 24V	

Max input voltage	30V, current limiting resistor = 3.32kohm / 250mW
Counter input	DI0 can act as a 16-bit up-counter by counting positive or negative edges (configurable) DI0 and DI1 can act as a 16-bit quadrature counter.
Max counting rate	10kHz
Connector type	10 pin box header
Digital outputs:	
Number of channels	7 isolated PNP outputs
Max load current	0.5A _{dc} , load current external delivered, total current must not exceed 1.5A _{dc} .
Max voltage	30V _{dc}
Protection	Snubber diode at each output
Connector type	10 pin box header
Environmental specifications:	
Operating temperature:	-20° to +70°C
Storage temperature:	-40° to 85°C
Humidity:	20 to 90% non-condensing
Cyclic humidity:	ETS 300 019-2-5 or equal
Vibration:	10-1000 Hz Sinus and random @ 1-1,5G RMS
Sustained vibration:	EN 60068-2-34 & EN 60068-2-36
Shock	IEC 60068-2-27 & IEC 60068-2-29
Size (W x L x H)	90 x 96 x 14 mm – see next page
Weight:	116 g (excl. packaging)

*for details refer to SonyEricsson's documentation:

- GM47_48 Guidelines and
- GM47_48 Integrators Manual

Mechanical Layout

This schematic shows the dimensions for PV-1800.
All dimensions are in mm.

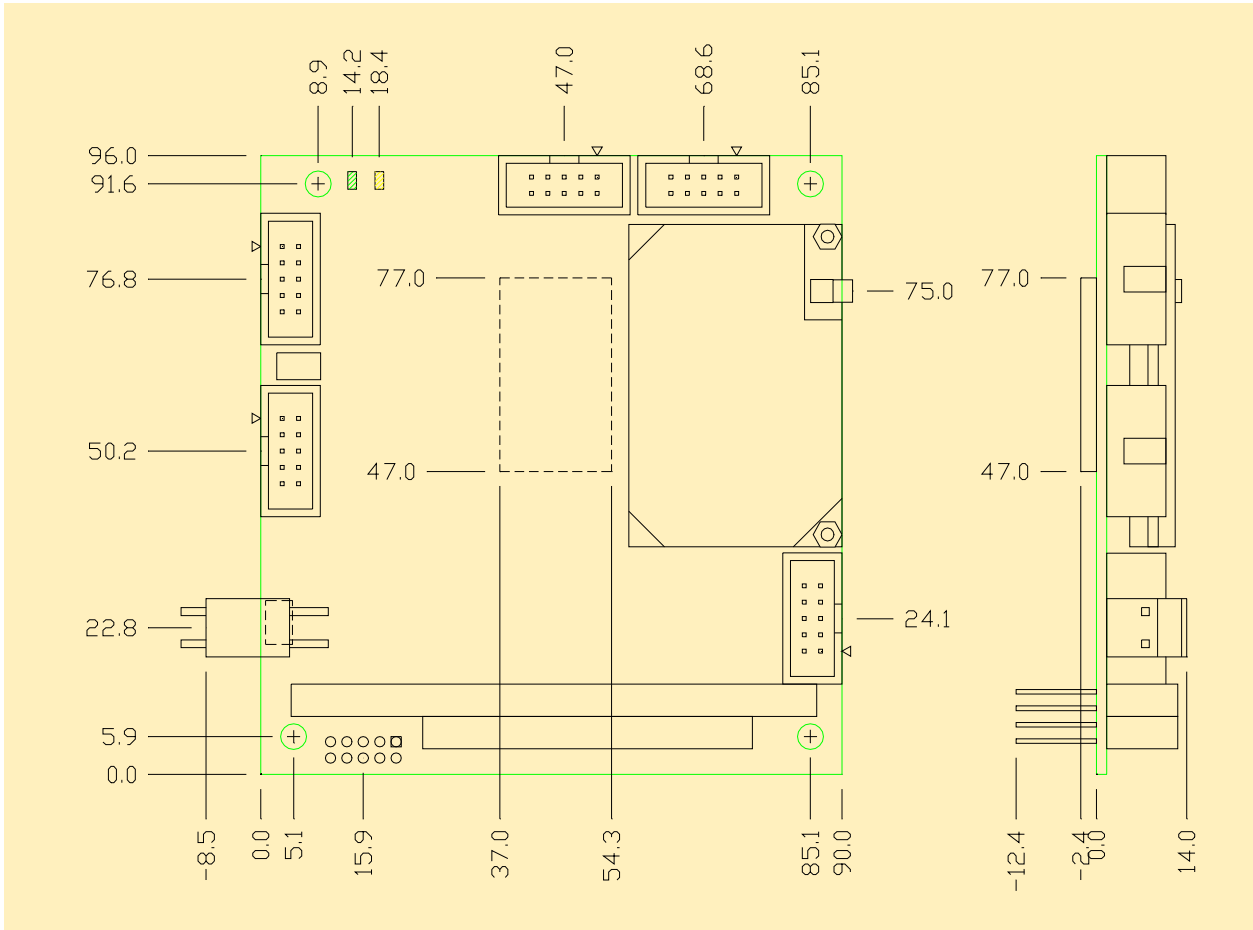

Installation guide

Precautions to ESD

Please note that the Micronix PV modules must be handled with respect to ESD (Electrostatic Discharge). Electrostatic Discharge to the PV modules must be avoided.

Before removing the module from the protection bag, the user must be discharged using a grounded wrist ribbon.

Settings and connections

A typical setup procedure involves these steps:

1. Perform settings of:
 - Base address. (Regs.).
 - Port number for COM_A (modem).
 - IRQ number COM_A (modem).
 - Port number for COM_B (RS232).
 - IRQ number for COM_B (RS232).
2. Place module in the PC/104 stack.
3. Connect interface cables: Analogue, digital etc.
4. Place a SIM card in the SIM card connector.
5. Connect the antenna cable to the MMCX-connector at the modem.
6. Connect the power cable (24V DC) at KL1.

Factory settings

The default jumper setting depends on the model you have purchased.

Factory settings, PV-1800 and PV-1700:

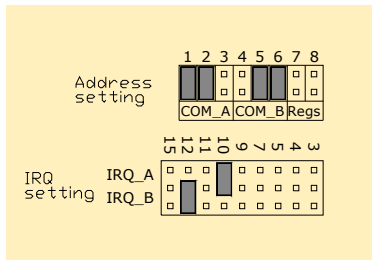

Registers base address: 200h
 Modem port: 3E8 (COM3)
 Modem IRQ: 10
 RS232 port: 2E8 (COM4)
 RS232 IRQ: 12

Factory settings, PV-1820 / PV-1830:

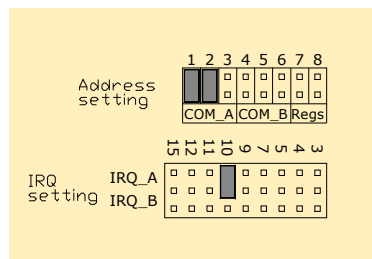

Registers base address: 200h
 Modem port: 3E8 (COM3)
 Modem IRQ: 10

Free Manuals Download Website

<http://myh66.com>

<http://usermanuals.us>

<http://www.somanuals.com>

<http://www.4manuals.cc>

<http://www.manual-lib.com>

<http://www.404manual.com>

<http://www.luxmanual.com>

<http://aubethermostatmanual.com>

Golf course search by state

<http://golfingnear.com>

Email search by domain

<http://emailbydomain.com>

Auto manuals search

<http://auto.somanuals.com>

TV manuals search

<http://tv.somanuals.com>