

# JVC



LYT2112-001A

## WR-MG250

Marine Case

**INSTRUCTIONS**

Unterwassergehäuse

**BEDIENUNGSANLEITUNG**

Boîtier sous-marin

**MANUEL D'UTILISATION**

Onderwaterhuis

**GEbruIKSAANWIJZING**

Carcasa submarina

**MANUAL DE INSTRUCCIONES**

Custodia subacquea

**ISTRUZIONI**

Бокс для подводной съемки

**ИНСТРУКЦИЯ ПО ЭКСПЛУАТАЦИИ**

Obudowa podwodna

**INSTRUKCJA OBSŁUGI**

潜水盒

使用説明書

**ENGLISH**

**DEUTSCH**

**FRANÇAIS**

**NEDERLANDS**

**CASTE.ESP.**

**ITALIANO**

**РУССКИЙ**

**POLSKI**

中文繁體

عربي

الحاوية البحرية  
تعليمات

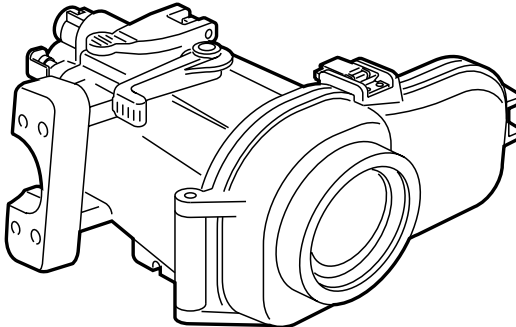

## In order to use this product safely

### Preparation (Pg. 6)

- Check that there is no dirt, cracks, or damage to the O-ring.
- Always apply grease to the O-ring.



### Attaching the Marine Case to the Camera (Pg. 7, 8)

- Make sure that the O-ring is not twisted, and that you do not forget to attach it.
- When tightening the seal, make sure there are no foreign objects caught in the seal.



### Recording the Video/Still Image Files (Pg. 8, 9)

- Avoid opening and closing the marine case in the shooting location.
- When holding the marine case, lower it gently into the water.



### Detaching the Marine Case/Maintenance (Pg. 9, 10, 11)

- Always wash the marine case in fresh water after use.
- Perform maintenance on the O-ring.

---

If water leaks into the case due to careless use of the marine case, JVC cannot accept responsibility for any damage that may occur to the internal equipment and materials (video camera, SD card, etc.), or any expenses incurred in taking the photographs/video. Therefore, please be careful when using the marine case.

## Safety Precaution



**Before use, this unit must be pre-tested to check if there is any water leakage.**

### Please read before use

This marine case is a precision instrument designed to permit safe video recording under high water pressure. Please pay careful attention when handling the unit before and after use, as explained in this user's manual.

Each part of the marine case has been subject to strict controls during the manufacturing process, and the individual functions have faced stringent tests during the assembly process. Each marine case has also had to pass waterproof inspections using high-pressure water testers. However, damage can sometimes occur during transport and distribution, or during storage after purchase, so before diving always carry out the following pre-use test to verify safety.

### Pre-use test

**Be sure to perform the following pre-use test before diving.**

- 1. Before mounting the camera inside the marine case, dive with only the empty marine case and test for water leaks.**

Allow 5 or 6 minutes to ensure there are no leaks.

Be sure to perform this test to ensure the safety of your camera.

- 2. The following are some common causes of water leaks:**

- A.** The marine case is used without attaching the O-ring.
- B.** The O-ring is not mounted in the correct position.
- C.** The O-ring is damaged or deformed.
- D.** There is sand, dirt, hair or other foreign matter on the O-ring.
- E.** There is sand, dirt, hair or other foreign matter on the contact surface of the O-ring or on the inside of the lid.
- F.** The provided strap or drying agent bag is pinched inside the marine case when the lid is closed.

### 3. Check that there are no scratches or cracks on the marine case every time you use it.

The marine case must withstand water pressure with use. Repeated exposure to pressure eventually leads to material fatigue, which may result in damage of the marine case. Every time you use the marine case, check in advance that there are no scratches or cracks. If you frequently use the marine case, be sure to ask for maintenance at the store of purchase. (There is a charge for maintenance.)

To protect your camera and ensure optimum use, keep the examples listed above in mind when using the marine case.

JVC accepts no responsibility for water leakage or damage to anything inside the marine case (camera, SD card, etc.) due to careless usage of this product. Be sure to follow correct procedures when using the marine case.

## Accessories

- Anti-fog liquid
- Silicone grease (5 g) x 1
- Silicone cloth
- Drying agent (2 g) x 5
- Strap
- 2 O-rings
- One spare O-ring.

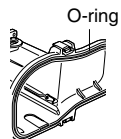

- Base  
To attach to the camera.



- Grip  
Commercially available lights and weights can also be attached.



- Pick



- Screw tightening key



- 2 hexagonal wrenches  
Large: for screwing the grip  
Small: buckle opener

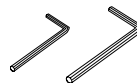

## Maintenance Kit - Sold Separately (Part Number: MG100\_MTKIT)

You can purchase the following set of expendable parts.

Please contact your local JVC service representative.

- O-rings x 2
- Silicone grease (5 g) x 1
- Drying agent (2 g) x 5
- Lens tissue paper (50 sheets) x 1

## Procedures for Using the Supplied Maintenance Kit

### Strap



Pass the strap through the strap attachment hole before using the marine case to maintain a firm grip in water.

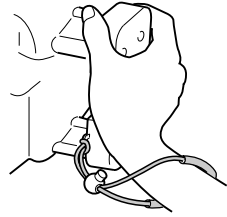

### Anti-fog liquid

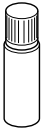

Apply the anti-fog liquid on the inner side of front glass before using the marine case.

Add two to three drops of the liquid on a lens tissue paper (commercially available) or a clean cloth, and apply on the inner side of the front glass.

Front glass

Marine case

### Drying agent

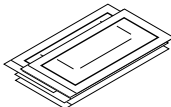

Prevents fogging inside the marine case. Insert it at the back of the base attached to the camera.

★ The moisture absorption ability of drying agent that has previously been used may deteriorate depending on the conditions of use. As such, we recommend that the drying agent be replaced each time.

### Silicone cloth

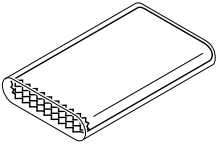

Wash the marine case with fresh water, and wipe the outer side of the whole case with the silicone cloth after drying.

Buckle

### Hexagonal wrench (small) (Buckle opener)



For use when you have difficulty opening the buckle.  
Hook the wrench to the buckle and pull towards you.

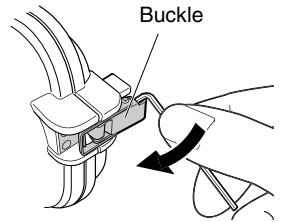

Buckle

Grip belt of camera

Base

### Screw tightening key



Use the key to tighten the screw of the base.

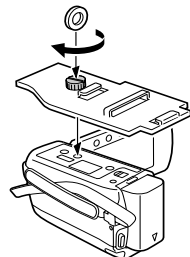

## Parts and Functions

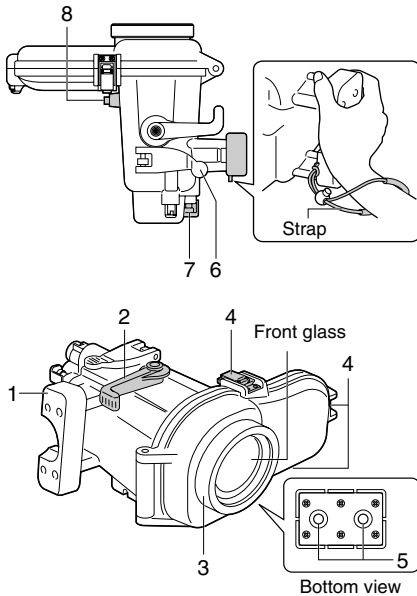

### 1. Main casing grip

Attach the strap provided as shown in the diagram above.

### 2. Zoom lever

Zoom (tele/wide) while shooting.

### 3. Ring

Commercially available filters (67 mm diameter) can be attached.

### 4. Buckle (3 locations)

Seal the marine case.

### 5. Grip attachment holes

You can attach the grip provided, or commercially available weights.

### 6. Still image lever

Press to take still images.

### 7. Video recording start/stop button

Press once to start recording a video. Press again to stop.

### 8. Power button

Turns camera's power on/off.

## Preparation

### 1 Inspect the main casing for scratches and cracks.

Apply 2 or 3 drops of the anti-fog liquid provided onto a lens tissue paper (commercially available) or a clean cloth, and wipe the inner side of the marine case front glass.

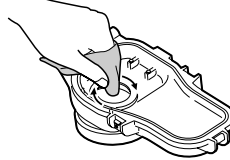

### 2 Check the O-ring.

Using the pick provided, remove the O-ring from the main case.



Check the O-ring, O-ring contact surface, and groove in which the O-ring fits for foreign matter, nicks, cracks, etc.

Be sure to remove any foreign matter (dirt, sand, salt crystals, hair, lint, etc.).

★ For details, refer to the "O-ring Maintenance Manual".

### Caution

- Never use the O-ring in case of nicks and cracks.
- If the O-ring is handled inappropriately, it can cause water leakage .

### 3 Apply grease to the O-ring and re-attach.

### 4 Close the empty marine case (no camera inside).

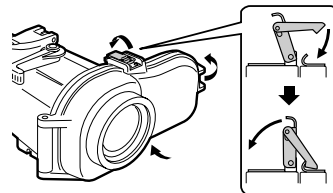

### 5 Submerge the marine case in water and check that there are no water leaks.

(Pg. 8)

## Attaching the Marine Case to the Camera

### 1 Setup the camera.

- For models equipped with light, turn off the light.
- Open the lens cover.
- Set to the shooting mode (video/still image).
- ★ Even when the shooting mode is set to "video", still images can be captured by pressing the still image lever during video recording.
- It is recommended to set to the auto shooting mode.
- Insert the battery and micro SD card beforehand if needed.
- To turn off the camera, press and hold the power button for more than 2 seconds.

### 2 Insert the drying agent at the back of the base.

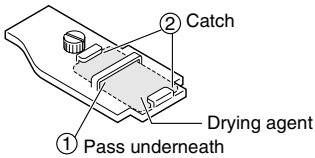

### 3 Attach the base to the bottom of the camera.

- Align the tripod screw hole at the bottom of your camera with the screw of the base, and tighten the screw.

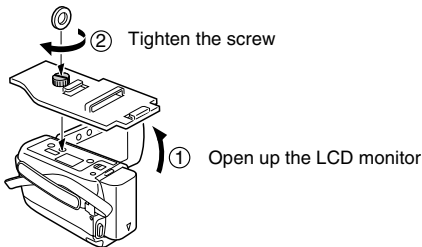

### Caution

- The camera turns on automatically when the LCD monitor is opened. To turn off the camera, press and hold the power button for more than 2 seconds.

### 4 Fold the grip belt.

- Make sure the grip belt is not caught between the marine case when sealing.

1. Unlock the grip belt, pull the belt out and lock again.

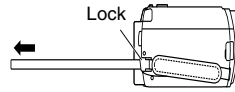

2. Fold the grip belt and pass the front end through the inner side of the belt.

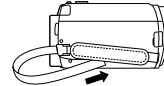

3. Pull the end that has been passed through the inner side of the belt and adjust the length. (If the end is pulled out too much, it may be recorded into the image or get caught in the O-ring when sealing the marine case.)

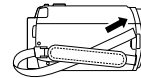

### 5 Open the marine case.

- If it is difficult to open buckles, use the small hexagonal wrench (buckle opener).

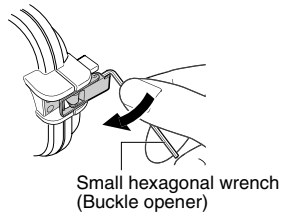

### 6 Insert the camera into the marine case.

- Align the base attachment groove with the base to insert.

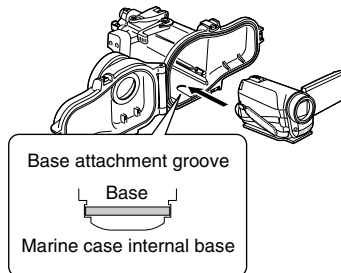

### 7 Adjust the angle of the LCD monitor.

- The LCD monitor can be tilted upwards to a maximum angle of 30 degrees.

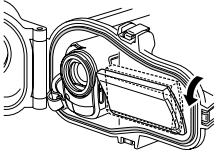

### 8 Seal the marine case.

- Make sure that the O-ring is not twisted, and that you did not forget to attach it.
- Make sure that foreign objects (strap, belt, dirt, etc.) have not been caught in between.

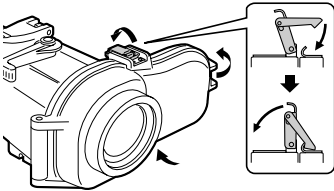

### Caution

- The risk of water leakage is extremely high if the O-ring is twisted, if you forget to attach it, or if something is trapped in the seal.

### 9 Check that all the operation buttons of the camera are functioning properly.

- If it is not functioning, take out the camera and insert again.

### 10 Attach the grips.

- Attach the grips, lights or weights on the bottom of the marine case.

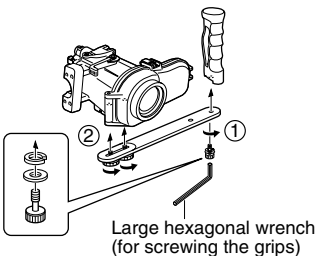

## Recording the Video/Still Image Files

### Before recording

Submerge the marine case with the camera inserted into a bathtub or water tank full of fresh water. Gradually prolong the time the marine case is submerged as follows.

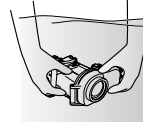

- 1st time: 5 ~ 10 seconds
- 2nd time: 30 seconds ~ 1 minute
- 3rd time: 3 minutes ~ 5 minutes (try operating the levers and buttons while the marine case is submerged).

### Caution

- Always have someone hold the marine case for you when diving into, or getting out of water, to prevent loss or damages.
- If for any reason water leakage occurs, remove the camera battery. It may cause the camera to explode.

### 1 Turn on the camera's power.

- Press and hold the power button for more than 2 seconds to turn on the power. (The camera's power lamp lights and the monitor turns on.)

ON/OFF

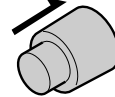

### Note

- Sometimes, due to sudden shaking or impact to the marine case, the camera's drop detection function operates to turn off the camera's power. When the camera's power is turned off, turn it on again. When "VIDEO MANAGEMENT FILE IS BROKEN. TO RECORD/PLAYBACK VIDEO, RECOVERY IS REQUIRED. RECOVER?" is displayed, press the REC button to recover the file.



- 2 Press the video recording start/stop button or the still image lever to start recording.

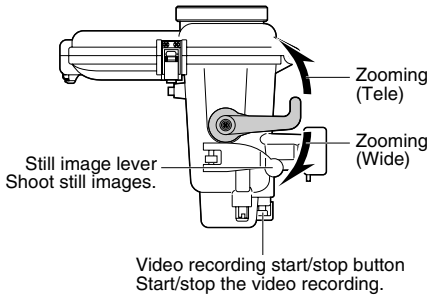

- 3 When you have finished recording, press and hold the power button for more than 2 seconds to turn off the camera.
  - The camera's power lamp goes out and the monitor turns off.

## Detaching the camera

If there is a need to detach immediately:

- 1 Submerge the marine case in fresh water and shake the marine case in the upward, downward, left and right directions for at least 10 times, followed by rinsing it.
- 2 Remove the marine case and wipe off water droplets on the case surface using a dry towel.
- 3 Face the front glass of the marine case upwards, and open the buckles to remove the camera, while paying attention not to let water droplets enter the case.
- 4 Upon removing the camera, close the marine case again while paying attention not to allow water droplets enter the case, followed by tightening all the buckles.
  - \* Always perform maintenance on the marine case after using. (Pg. 10)

If there is no need to detach immediately:

Perform maintenance on the marine case. (Pg. 10)

## Maintenance on the marine case

Always perform maintenance on the marine case after you have finished recording.

Salt crystal or dirt will accumulate inside the marine case if maintenance is not performed, and this can cause water leakage.

### Wash the marine case in water while it is still sealed

- Do this within 30 minutes after diving.
- Pour in fresh water until the marine case is completely submerged in the container, and shake the marine case in the upward, downward, left and right directions.
- Move the buttons and levers while the marine case is submerged, and rinse the dirt out from any gaps or grooves. Proceed to ④
- If used in the sea
  - > Proceed to [Performing salt removal](#)

### Performing salt removal

If the marine case was used in the sea, submerge the marine case in fresh water for at least 1 hour to remove salt.

- 1 Prepare a container that contains fresh water that is five times more than the volume of the marine case.**
  - The container must be big enough to allow the marine case to submerge fully.
  - If only small containers are available, pour in fresh water that is equivalent to at least five times the volume of the marine case over a few times.
  - Shaking the marine case in the upward, downward, left and right directions will be more effective.
  - Move the buttons and levers while the marine case is submerged, and rinse the salt out from any gaps or grooves etc.
  - Make sure the grip is also free of salt.
- 2 Put in fresh water for at least 1 hour.**
- 3 Remove the marine case and wipe off water droplets on the case surface using a dry towel.**
- 4 Remove the camera.**
  - Face the front glass of the marine case upwards, and open the buckles to remove the camera, while paying attention not to let water droplets at O-ring or buckles enter the case.

### Caution

- The camera may fall out if the buckles are opened with the front glass facing down.
- If you cannot avoid opening the marine case at the diving location, pay attention not to let water droplets from your hair or your body enter the case.

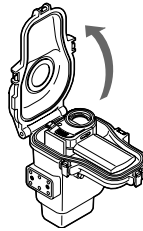

### 5 Remove the O-ring, and wipe off salt, sand and other foreign matter.

- Also wipe the groove in which the O-ring was inserted, and the part of the marine case that was in contact with the O-ring, and allow them to dry.
- ★ For details on handling and storing the O-ring, refer to the "O-ring Maintenance Manual".

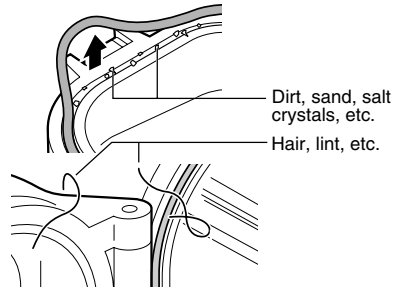

### 6 Wipe the inside and outside of the marine case with a dry cloth.

- ★ Use a lint-free cloth to wipe the inside of the marine case.

### 7 Wipe the inner side of the front glass.

- Add a few drops of the cleaner liquid (commercially available) onto the inner side of the front glass, and wipe off using a lens tissue paper, clean cloth, etc.

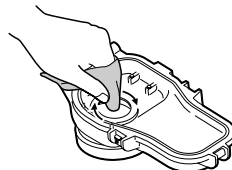

### Caution

- The front glass will fog if it is dirty.
- ⑧ **Let it dry completely in a shaded area.**

### Caution

- Do not leave the marine case in direct sunlight.
- Doing so may cause discoloration of the case, and may cause the O-ring to deteriorate more quickly.

### Note

- The conditions may vary depending on the environment of use such as temperature, humidity, water temperature, salinity and others.

## Storing the O-ring

If you do not intend to use the marine case for longer than one month, remove and store the O-ring away.

★ For details, refer to the “O-ring Maintenance Manual”.

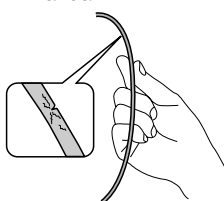

**The O-ring is an expendable part. Replace the O-ring with a brand new one every year.**

### Caution

- When re-using an O-ring after storage, always check the condition of the O-ring. Never use an O-ring if it is deformed (crushed, distorted), cracked, or damaged in any way.

## Specifications

Maximum pressure	Water depth up to 40 meters
Operations	Power on/off Video recording start/stop Still image shooting Zoom (tele/wide)
Buoyancy	+440 g, with the camera (GZ-HD300, 320) inserted and the supplied battery pack attached +460 g, with the camera (GZ-MG840, 880) inserted and the supplied battery pack attached
Filter diameter	67 mm
Main unit dimensions (W x D x H)	216 mm x 179 mm x 128 mm
Main unit weight	Approx. 850 g (excluding grip)

### Applicable camera models

GZ-HD300      GZ-MG840  
GZ-HD320      GZ-MG880



LYT2112-001A

# JVC

ENGLISH

DEUTSCH

FRANÇAIS

NEDERLANDS

CASTE.ESP.

ITALIANO

РУССКИЙ

POLSKI

繁體文中

العربية

## WR-MG250

Marine Case

**INSTRUCTIONS**

Unterwassergehäuse

**BEDIENUNGSANLEITUNG**

Boîtier sous-marin

**MANUEL D'UTILISATION**

Onderwaterhuis

**GEBRUIKSAANWIJZING**

Carcasa submarina

**MANUAL DE INSTRUCCIONES**

Custodia subacquea

**ISTRUZIONI**

Бокс для подводной съемки

**ИНСТРУКЦИЯ ПО ЭКСПЛУАТАЦИИ**

Obudowa podwodna

**INSTRUKCJA OBSŁUGI**

潛水盒

使用說明書

الحاوية البحرية  
تعليمات

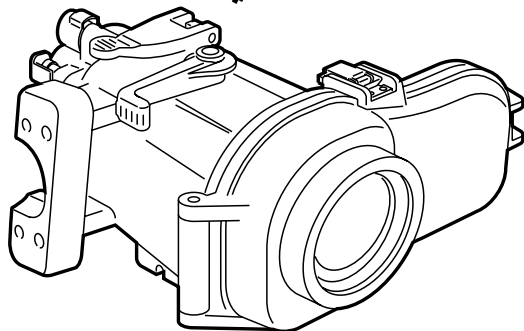

# JVC



LYT2112-002A

**O-ring Maintenance Manual**

**O-Ring-Wartungshandbuch**

**Manuel d'entretien du joint d'étanchéité**

**Onderhoudshandleiding voor de O-ring**

**Manual de mantenimiento de la junta tórica**

**Manuale di manutenzione dell'anello circolare**

**Руководство по уходу за уплотнительным  
кольцом**

**Instrukcja konserwacji pierścienia uszczelniającego**

**0型環維護手冊**

**دليل صيانة الحلقة الدائرية**

**ENGLISH**

**DEUTSCH**

**FRANÇAIS**

**NEDERLANDS**

**CASTE.ESP.**

**ITALIANO**

**РУССКИЙ**

**POLSKI**

**中文繁體**

**عربي**

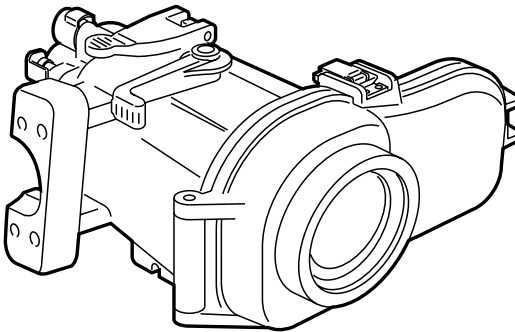

# O-ring

## What is O-ring?

- O-ring is a type of seal used to make underwater cameras, strobes and other diving instruments, waterproof.  
It looks like a big, thick rubber band.
- The O-ring is an important component that protects the camera from water by keeping the marine case airtight.

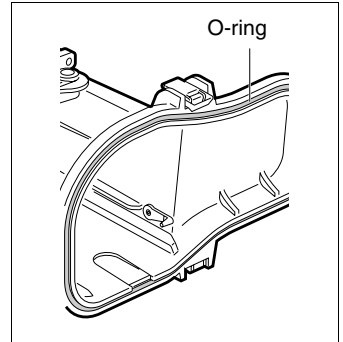

## When should the O-ring be inspected?

- **As a general rule, each time before using**  
(Salt crystals are formed when seawater that entered the O-ring groove dries.  
Salt crystals just like sand, can cause water leakage.)
- **When shooting on the sandy seabed, or when the camera is placed on the sand**
- **When not used for a long period of time**

## Inspection and maintenance of the O-ring

- **Remove the O-ring**
  - ★ To inspect the O-ring, use the pick supplied to remove it from the O-ring groove.
  - ★ Do not use knives, scissors, tweezers, and other sharp objects which might damage the O-ring and the O-ring groove.

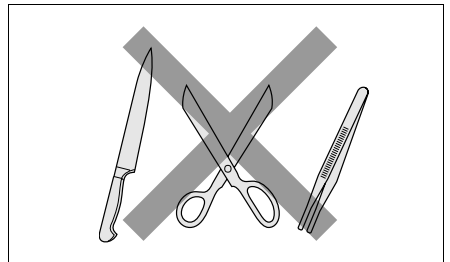
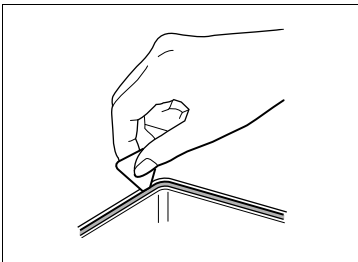

- **Check for hair, dirt, sand, salt, dust, and other foreign matter**

- ★ Even small foreign matter can cause water leakage.

- **Check for foreign matter that are not visible by rubbing gently with your fingers**

- ★ Be sure to remove all foreign matter.

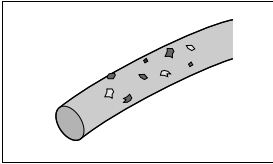

▲Dirt

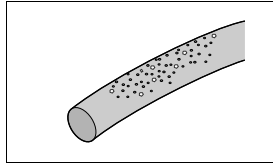

▲Sand

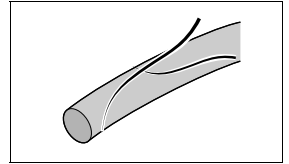

▲Hair

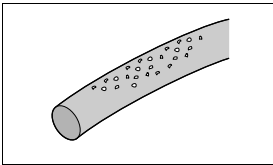

▲Dust

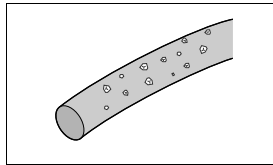

▲Salt

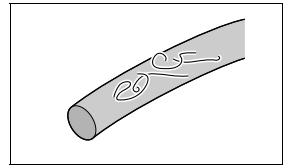

▲Lint

- **Wipe off any residual grease**

Wipe off gently with a soft cloth or tissue paper.

- ★ After wiping, make sure the fiber of the cloth or tissue paper is not adhered to the O-ring.

- **Check for any deforms (distorted, crushed), cracks or cuts on the surface**

Cracks on the O-ring can be easily spotted by bending and twisting it gently.

- ★ Never use an O-ring if it is deformed, cracked, or damaged in any way. It can cause water leakage.

- ★ Replace the O-ring with a brand new one every year. Even if there are no nicks, cracks, etc., its effectiveness will deteriorate due to wear.

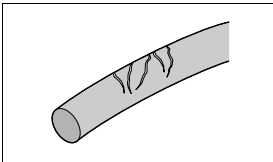
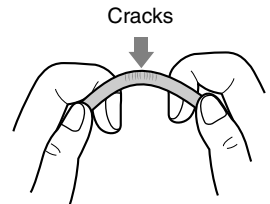

▲Cracks

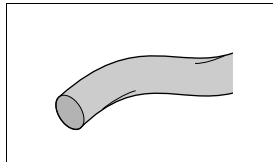

▲Distortion

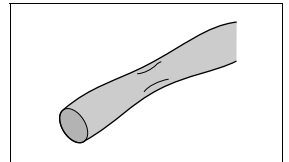

▲Crushed

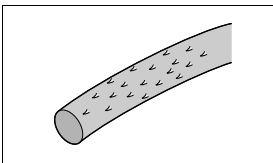

▲Frayed

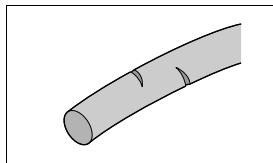

▲Nicks

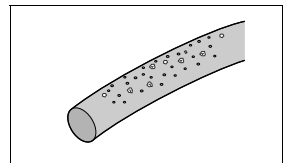

▲Sand corrosion

- **Apply silicone grease on the O-ring**

The O-ring needs to be re-greased when its surface appears dry. Be sure to remove the O-ring and apply the silicone grease on it.

- ① Squeeze about 1 cm onto your finger
- ② Apply it on the O-ring by holding the O-ring with your fingers.

If the amount applied is not enough, repeat the above step.

- ★ Make sure that you do not apply too much grease!  
Dirt and dust will easily adhere if too much grease is applied. Neither will it improve the waterproofing. Be sure to apply moderately.
- ★ Do not pull too strongly!  
This will cause deformation.

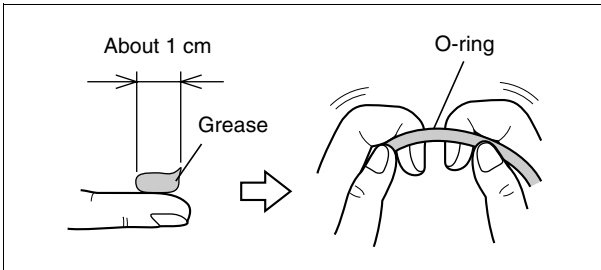

- **Check for any foreign matter in the O-ring groove**

Inspect thoroughly as it is usually not visible. Grains of sand and crystallize salt may be stuck inside. Remove them carefully by either using an air spray or a swab.

- ★ Make sure the fibers of the swab are not adhered.

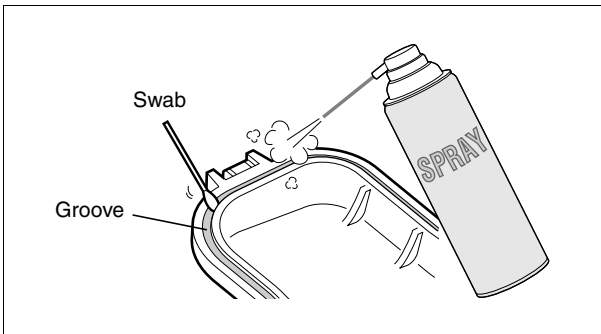



### ● Insert the O-ring after inspection

Make sure no foreign matter is adhered when placing the greased O-ring back to the groove.

Do not pull too strongly, and make sure the O-ring is placed evenly and not twisted.

<POINT>

Insert from the four diagonal corners and smooth out evenly.

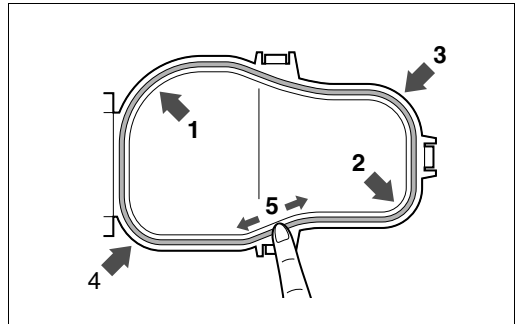

## Storing the O-ring

### ● If you do not intend to use the marine case for a long period of time, remove the O-ring and allow it to rest.

① Remove the O-ring.

★ Be sure to use the pick supplied.

② Wipe off the grease gently.

③ Check for any foreign matter that might be adhered to it.

④ Put the O-ring inside a clean plastic bag, and store in a way that it will not be subject to stress.

★ Do not put in moth balls and other insect repellents.

**★ Do not leave the O-ring as-is in the marine case for a long period of time.**

It may deform due to heat and pressure resulting from the locked and tightened state.

**★ Do not store in hot and humid locations.**

This will cause the O-ring to deteriorate more quickly.



LYT2112-002A

# JVC

**ENGLISH**

**O-ring Maintenance Manual**

**DEUTSCH**

**O-Ring-Wartungshandbuch**

**FRANÇAIS**

**Manuel d'entretien du joint d'étanchéité**

**NEDERLANDS**

**Onderhoudshandleiding voor de O-ring**

**CASTE.ESP.**

**Manual de mantenimiento de la junta tórica**

**ITALIANO**

**Manuale di manutenzione dell'anello circolare**

**РУССКИЙ**

**Руководство по уходу за уплотнительным  
кольцом**

**POLSKI**

**Instrukcja konserwacji pierścienia uszczelniającego**

**中文繁體**

**0 型環維護手冊**

**عربي**

**دليل صيانة الحلقة الدائرية**

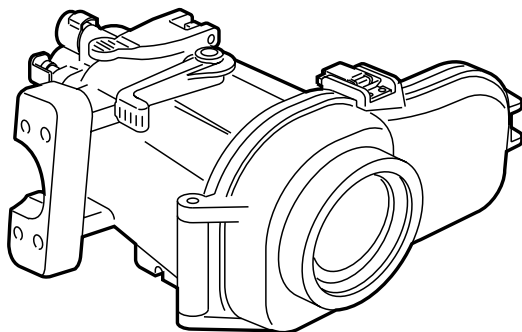

## 水中撮影時のフロントガラスのくもりを防ぐために

以下のような状態で水中撮影を行うと、フロントガラスにくもりが生じ、撮影画像に支障をきたす恐れがあります。ご使用の際は、注意してください。

- マリンケース内部の水分について**

マリンケース内部にわずかでも水分が残っている状態で水中撮影を行うと、くもりが発生することがあります。ご使用の前に、マリンケース内部が十分に乾いていることを確認してください。  
マリンケース開閉時およびビデオカメラ装着時は、水分が入らないように十分にご注意ください。特に、濡れた手で触ったビデオカメラをそのまま装着することは避けてください。
- ビデオカメラ装着時の温度・湿度**

高温・多湿の場所でビデオカメラを装着すると、その後の水中撮影でくもりが発生することがあります。装着や装着後の保管は、できるだけ低い温度・湿度の場所で行なってください。
- 撮影時の温度差**

炎天下の船上に放置するなど、高温にさらされた状態から水中撮影を行うと、その温度差でくもりが発生することがあります。水中撮影を行うときは、できるだけ温度差を少なくしてから撮影してください。
- 急激な水圧変化による影響**

水深が深い所に急に潜水すると、急激な圧力変化でくもりが発生することがあります。潜水時には緩やかに深度をとることをおすすめします。

### Preventing fogging of the front glass during underwater shooting

Performing underwater shooting under the following conditions may cause the front glass to fog, thus affecting the quality of the images taken. Take note of the following precautions during use.

- Moisture inside marine case**

A slight amount of moisture inside the marine case may cause fogging during underwater shooting. Make sure that the interior of the marine case is completely dry before use.  
Pay careful attention not to allow water to enter the case when opening/closing the marine case or when mounting the camera. In particular, do not mount the camera if it has been touched by wet hands.
- Temperature and humidity during camera mounting**

Fogging may occur during underwater shooting if the camera is mounted at a location that has a high temperature or humidity level. Mount the camera or store the camera after mounting at a location with a low temperature and humidity level.
- Temperature difference during shooting**

If the camera is left under a high temperature, such as under the hot sun on the boat, immediately prior to underwater shooting, fogging may occur due to the large temperature difference. Minimize the temperature difference as much as possible before shooting underwater.
- Drastic change in water pressure**

If you dive suddenly into deep water, the drastic change in water pressure may cause fogging to occur. It is recommended that you move gradually into deep water during diving.

### So verhindern Sie, dass sich das Frontglas bei Unterwasseraufnahmen beschlägt

Unterwasseraufnahmen unter folgenden Bedingungen können dazu führen, dass sich das Frontglas beschlägt, was die Aufnahmequalität beeinträchtigt. Folgen Sie deshalb diesen Vorsichtsmaßnahmen.

- Feuchtigkeit im Unterwassergehäuse**

Eine geringe Feuchtigkeitsmenge im Unterwassergehäuse kann bei Unterwasseraufnahmen ein Beschlagen verursachen. Vergewissern Sie sich vor der Verwendung, dass das Innere des Unterwassergehäuses völlig trocken ist.  
Lassen Sie auf keinen Fall beim Öffnen/Schließen des Unterwassergehäuses oder beim Einsetzen der Kamera Wasser eindringen. Setzen Sie vor allem die Kamera nicht ein, wenn diese mit nassen Händen berührt wurde.
- Temperatur und Luftfeuchtigkeit beim Einsetzen der Kamera**

Wenn die Kamera an einem Ort mit hoher Temperatur oder Luftfeuchtigkeit eingesetzt wurde, kann bei Unterwasseraufnahmen ein Beschlagen auftreten. Setzen Sie die Kamera an einem Ort mit niedriger Temperatur und Luftfeuchtigkeit, bzw. lagern Sie sie dort nach dem Einsetzen.
- Temperaturunterschiede während der Aufnahme**

Wenn die Kamera unmittelbar vor der Unterwasseraufnahme hoher Temperatur ausgesetzt wird, wie etwa bei greller Sonne im Boot, kann es aufgrund des großen Temperaturunterschieds zu einem Beschlagen kommen. Halten Sie den Temperaturunterschied vor der Unterwasseraufnahme möglichst gering.
- Starke Änderungen im Wasserdruck**

Wenn Sie plötzlich in tiefes Wasser tauchen, kann die starke Änderung im Wasserdruck ein Beschlagen hervorrufen. Es wird empfohlen, beim Tauchen allmählich in tieferes Wasser vorzudringen.

### Prévenir la formation de buée dans le hublot avant lors de la prise de photos sous l'eau

Prendre des photos sous l'eau dans les conditions suivantes peut causer la formation de buée dans le hublot avant, ce qui pourrait nuire à la qualité des images prises. Prenez note des précautions suivantes lors de l'utilisation.

- Humidité à l'intérieur du boîtier sous-marin**

Un peu d'humidité dans le boîtier sous-marin peut causer la formation de buée pendant la prise de photos sous l'eau. Assurez-vous que l'intérieur du boîtier sous-marin soit complètement sec avant l'utilisation.  
Faites très attention de ne pas laisser d'eau s'infiltrer dans le boîtier au moment d'ouvrir ou de fermer le boîtier sous-marin ou lors du montage de l'appareil photo. Ne montez surtout pas l'appareil photo s'il a été manipulé par une personne avec les mains mouillées.
- Température et humidité au moment du montage de l'appareil photo**

La formation de buée peut se produire pendant la prise de photos sous l'eau si l'appareil photo est monté à un endroit où la température ou le niveau d'humidité sont élevés. Montez l'appareil photo ou entreposez-le après le montage à un endroit où la température et le niveau d'humidité sont peu élevés.
- Différence de température lors de la prise de photos**

Si l'appareil photo est soumis à une température élevée, comme à un soleil chaud sur un bateau, immédiatement avant la prise de photos sous l'eau, la formation de buée peut avoir lieu en raison de l'importante différence de température. Minimisez la différence de température le plus possible avant de prendre des photos sous l'eau.
- Variation draconienne de la pression de l'eau**

Si vous plongez soudainement dans une eau très profonde, la variation draconienne de la pression de l'eau peut causer la formation de buée. Nous vous recommandons de plonger graduellement dans des eaux profondes pendant la plongée.

### Voorkomen dat het voorglas tijdens opnamen onder water beslaat

Als men onder de volgende condities onder water opnamen maakt, kan het voorglas beslaan. Dit kan een negatieve invloed hebben op de beelden die men registreert. Let op de volgende voorzorgsmaatregelen tijdens gebruik.

- Vocht in het onderwaterhuis**

Een kleine hoeveelheid vocht binnen het onderwaterhuis kan tijdens het maken van opnamen onder water tot gevolg hebben dat het glas beslaat. Zorg ervoor dat de binnenkant van de zeebehuizing volledig droog is voor gebruik.  
Let er goed op dat er geen water de behuizing binnensijpelt, wanneer men de zeebehuizing opent/sluit of wanneer men de camera bevestigt. Let er met name op dat u de camera niet bevestigt, als deze is aangeraakt door natte handen.
- Temperatuur en vochtigheid tijdens bevestiging van de camera**

Het glas kan beslaan tijdens opnemen onder water, als de camera wordt bevestigd op een locatie die een hoge temperatuur of een hoog vochtigheidsniveau heeft. Bevestig de camera of sla de camera op na hem te bevestigen op een locatie met een lage temperatuur en een laag vochtigheidsniveau.
- Temperatuurverschillen tijdens opnamen maken**

Als men onmiddellijk voordat men onder water opnamen neemt, de camera onder een hoge temperatuur laat liggen, zoals onder de hete zon op de boot, kan het glas beslaan door het grote temperatuurverschil. Minimaliseer het temperatuurverschil zo veel mogelijk voordat u onder water opnamen maakt.
- Drastische veranderingen in waterdruk**

Als u plotseling in diep water duikt, kan de drastische verandering in waterdruk tot gevolg hebben dat het glas beslaat. Het verdient aanbeveling dat u geleidelijk het diepe water in gaat tijdens het duiken.

### Cómo prevenir el empañamiento del cristal delantero durante el disparo submarino

Efectuar disparos submarinos en las condiciones que se establecen a continuación podría provocar el empañamiento del cristal delantero y de este modo afectar la calidad de las imágenes capturadas. Tenga en cuenta las siguientes precauciones durante la utilización.

- Humedad dentro de la carcasa submarina**

Una pequeña cantidad de humedad dentro de la carcasa submarina podría provocar un empañamiento durante el disparo submarino. Cerciórese de que el interior de la carcasa submarina esté completamente seco antes de utilizarla.  
Evite el ingreso de agua a la carcasa al abrir/cerrar la carcasa submarina o cuando instale la cámara. En especial, no instale la cámara si la ha tocado con las manos húmedas.
- Temperatura y humedad durante la instalación de la cámara**

Se puede producir un empañamiento al realizar disparos submarinos si se coloca la cámara en un sitio donde el nivel de temperatura o humedad sea elevado. Coloque o guarde la cámara luego de instalarla en un sitio donde el nivel de temperatura y de humedad sea bajo.
- Diferencia de temperatura durante el disparo**

Si se deja la cámara expuesta a altas temperaturas, como puede ser bajo el sol en el bote, inmediatamente antes de efectuar disparos submarinos, se podría producir un empañamiento debido a la gran diferencia de temperatura. Reduzca la diferencia de temperatura tanto como pueda antes de efectuar disparos submarinos.
- Cambio drástico en la presión hidrostática**

Si se sumerge bruscamente en aguas profundas, el cambio drástico en la presión hidrostática podría provocar un empañamiento. Se sugiere se desplace de manera gradual en aguas profundas mientras bucea.

## Free Manuals Download Website

<http://myh66.com>

<http://usermanuals.us>

<http://www.somanuals.com>

<http://www.4manuals.cc>

<http://www.manual-lib.com>

<http://www.404manual.com>

<http://www.luxmanual.com>

<http://aubethermostatmanual.com>

Golf course search by state

<http://golfingnear.com>

Email search by domain

<http://emailbydomain.com>

Auto manuals search

<http://auto.somanuals.com>

TV manuals search

<http://tv.somanuals.com>