

Table of Contents

Preface	1
Chapter 1 - QuickStart	3
<i>Installing the card</i>	3
<i>Installing the software</i>	6
Chapter 2 - Installing the MACH Speed G3 Upgrade Card	9
<i>General Installation Instructions</i>	9
<i>Installation in Power Mac 7300, 7500 or 7600 Computers</i>	11
<i>Installation in Power Mac 8500 or 9500 Computers</i>	21
<i>Installation in Power Mac 8600 or 9600 Computers</i>	32
<i>Installation in Non-Apple Systems</i>	40
Chapter 3 - Installing the software	47
<i>The Processor Info Utility</i>	48
<i>The MACH Speed G3 Control</i>	50
Chapter 4 - Advanced Performance Tuning	53
<i>Multiple Variable Processing (MVP)</i>	54
<i>Adjusting for Maximum CPU Operating speed</i>	54
<i>Frequency Chart</i>	56
<i>Adjusting the Maximum Backside Cache Ratios</i>	57
<i>Performance Notes</i>	59
Chapter 5 - Technical Support	61
<i>Troubleshooting</i>	61
<i>Warranty Information</i>	63
<i>Declaration of Conformity</i>	64

Preface

Thank you for choosing the MACH Speed G3 upgrade. You have purchased an award winning product which will provide leading edge performance gains, and is backed by a leader in the computing industry.

The MACH Speed G3 is fully compatible with PowerPC 7300, 7500, 7600, 8500, 8600, 9500 and 9600 Power Computing's PowerTower™, PowerCenter™, and PowerWave™ and Umax® S900 and J700.

This manual provides installation instructions for your new MACH Speed G3 processor upgrade. We have divided this manual into 4 easy sections designed to get your system back in service as soon as possible.

The QuickStart - Provides the information to get your card installed and running immediately. The quickstart is designed for persons familiar with installing add-in cards inside computers. It will provide immediate CPU performance as rated by the manufacture.

Installing the Card - Provides information and detailed instruction on installing the MACH Speed G3 Upgrade Card in various computer systems.

Installing the Software - Provides detailed information on the use of XLR8 exclusive software additions to the MACH Speed G3 package.

Advanced Performance Tuning - Provides information on implementing XLR8's exclusive MVP performance technology, for tuning your system to run up to 20% faster than the standard base upgrade settings.

Technical Support - This section includes support information and a handy troubleshooting section, should you have problems.

Important:

Before installing your MACH Speed G3 CPU card, read the instructions covering your machine model.

- Static electricity can cause damage to the CPU card and other computer components including the motherboard.
- Please use the grounding wrist strap while installing or removing the MACH Speed G3 card.

About Performance Tuning:

Your MACH Speed G3 CPU card was preset from the factory to base BUS speed and BUS ratio settings. Depending upon the hardware and software configuration of your particular computer, you may choose to change the BUS speed and BUS ratio settings to optimize performance. Refer to the Advance Performance Tuning section of this manual to select your preferred settings prior to installation.

Included with your package

The MACH Speed upgrade includes everything you need to install your card with the exception of a couple of basic tools which are usually available to any computer user, a phillips head screwdriver and a ball point ink pen.

Your package includes:

- The MACH Speed G3 Processor Upgrade Card
- High-quality adjustable anti-static wrist strap
- Software on diskette
- Warranty card
- Manual

The Quickstart

Welcome to the QuickStart Section of this manual. This section will provide the information that you need to quickly install your G3 upgrade in the PCI based Mac OS system.

Installing the Card

1. Attach the anti-static wrist strap. The anti-static wrist strap will ensure that you are well grounded and avoid any unexpected static discharges.
 - The elastic end of the wrist strap is put over your wrist. The plug end of the wrist strap is attached to the power cable.
 - The opposite end of the power cable plugged into a “live” wall socket or power strip.

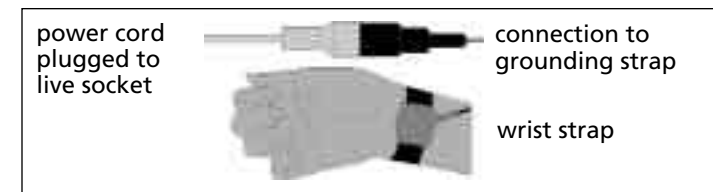

Attaching the anti-static wrist strap

2. Open the Mac OS system chassis.
 - Getting into the chassis varies from system to system. This chapter assumes that you are familiar with the opening of your system chassis. Please refer to later chapters if you need assistance with this operation.

3. Remove the existing CPU card.

- Identify the location of the CPU card. You can refer to the later chapters, or to your Systems user manual.

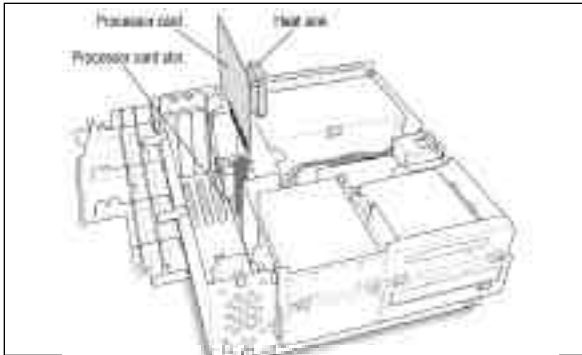

Removing the CPU card from a PowerMacintosh 7300

4. Remove the MACH Speed G3 from its protective package.

- Be sure that you are grounded, and remove the MACH Speed from its protective package.
- Inspect the card for any irregularities or possible damage in shipment.

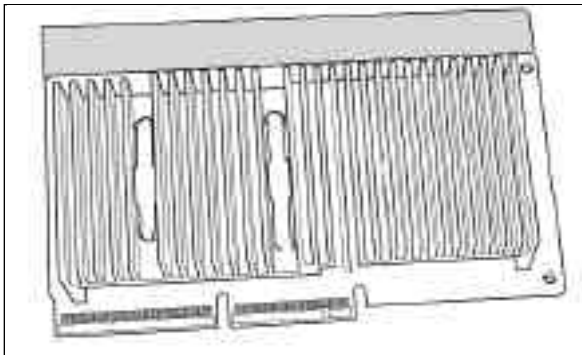

Inspecting the MACH Speed G3

5. Install the MACH Speed G3 into your system.

- The MACH Speed G3 Upgrade will face the same direction as the older card that you just removed. In most cases this is with the heat sink towards the Power Supply. The connector is designed to fit only one way.
- Holding the card by the edges (do not depress the heat sink), insert into the connector without twisting. You may feel two distinct “clicks” as the card seats itself firmly into the connector.

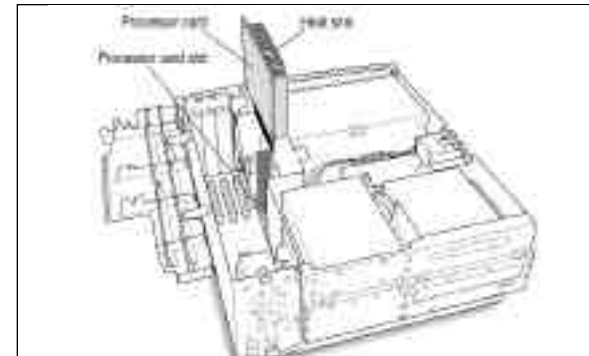

Installing the MACH Speed G3

6. Boot your Mac to test the Card/installation.

- At this point, it is a good idea to check that you get a successful boot up “chime”, ensuring that the card is well seated and working.
- Simply plug the power cord into the Mac, and start up the Mac. Once you have verified the “chime”, you can disconnect power, and complete the card installation. If you do not hear a “chime”, refer to Chapter 5 - Tech Support.
- Note: On some machines it may be mandatory to reassemble the Mac before booting. It is suggested that you test for a successful start-up “chime” at the earliest period possible to streamline any troubleshooting that may later be required.

7. Close up the System.

- With a “chiming” G3 enabled Mac, complete the installation by reversing the steps you followed for the installation.
- Reconnect all power cables/video/ADB
- Reboot the system.

Installing the Software

1. Copy the Software.

- After booting your Macintosh, insert the floppy disk.
- Review the readme file on the disk for any last minute changes or updates.
- Copy the MACH Speed G3 Control file to the Control Panels folder in the System of your start-up System drive.
- Copy the Processor Info file into any Non-System folder.

2. Open the Processor Info file (more detail in Chapter 3).

- Double-click on the XLR8 Processor Info. Review the dialog for correct information.
- If the CPU speed or cache size are reading incorrectly, you may have a problem with your system. Consult Chapter 5 - Tech Support for more information.

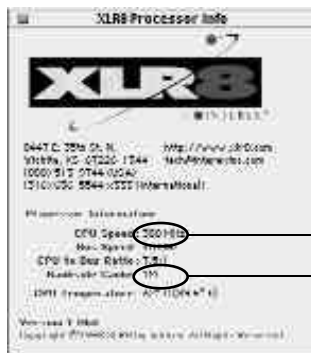

Check CPU Speed

Check Cache Size

3. Enable the MACH Speed G3 Backside Cache.

- In the Control Panels folder of your start-up drive, double-click on the MACH Speed G3 Control.
- This software controls the activation of the backside cache and controls the ratio at which it operates. You are now ready to turn the backside cache on.

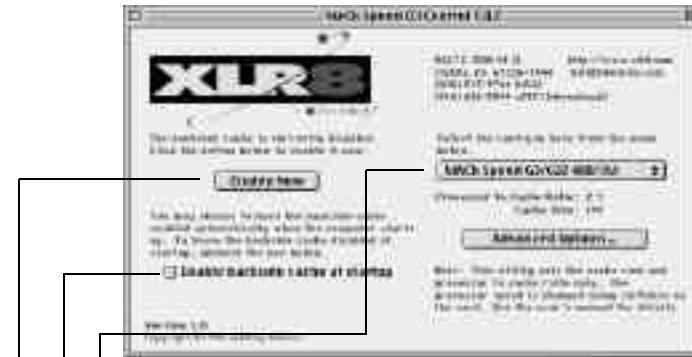

Step A. Select your MACH Speed G3 model from the pull-down menu.

Step B. Select “Enable Now” to enable the backside cache. If your system freezes at this point, you most likely selected the wrong card. Reboot and select again.

Step C. Now that your cache is enabled, you should select “Enable Backside Cache at Startup” to automatically enable the cache every time you boot your system.

Step D. Advanced options. This area is for enabling XLR8’s exclusive MVP technology. Refer to Chapter 4 - Advanced Performance Tuning for more information.

4. Close the MACH Speed G3 Control, restart your system, and enjoy working at new speeds!

NOTE: If your system hangs on boot, or displays any error messages, refer to Chapter 5 - Tech Support for more information.

Installing the MACH Speed G3 Upgrade Card

This chapter provides information for installing the Mach speed Card into individual systems. This information can also be found in the user guides provided by each system manufacturer.

General Installation Instructions

Before installing your MACH Speed Card, you should review this short section. It provides information specific to the Mach speed G3 Upgrade Card.

NOTE: Some of the system pictures may differ slightly from the exact chassis. When in doubt always refer to your Manufacturer's User Guide.

1. Attach the anti-static wrist strap. The anti-static wrist strap will ensure that you are well grounded and avoid any unexpected static discharges.

- The elastic end of the wrist strap is put over your wrist. The plug end of the wrist strap is attached to the power cable from the computer system.
- The opposite end of the power cable plugged into a “live” wall socket or power strip.

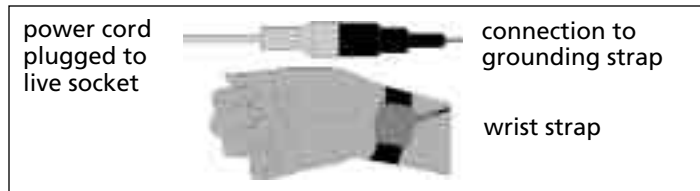

Attaching the anti-static wrist strap

Installation in a PowerMac 7300, 7500, or 7600

The MACH Speed G3 Upgrade Card gives your Macintosh 7300, 7500 or 7600 computer additional processing power. You install the upgrade card in the CPU card slot in your computer.

This section will instruct you on how to:

- Remove the cover from your computer
- Remove expansion card retainer
- Remove current CPU card
- Install the MACH Speed G3 Upgrade Card
- Replace the expansion card retainer
- Replace the computer cover

This chapter explains how to remove the CPU card currently inside your computer and replace it with the MACH Speed G3 Upgrade Card.

Installing the CPU card is technically challenging. If you prefer, you can ask an Apple-authorized dealer or service provider to install it for a fee.

If you attempt to install the card yourself but experience difficulties, it is recommended that you have an Apple-authorized service provider complete the process. Apple does not warranty damage caused by improper removal or installation of CPU cards.

1. Prepare the system and work area.

- Prepare your work area by ensuring that you have a well lighted space, preferably not on carpet (less static), and away from all magnetic devices.
- Put on the anti-static wrist strap, as instructed earlier.
- Turn off the computer and disconnect all cables.

2. Press the two release buttons under the front panel and slide the cover toward you approximately two inches.

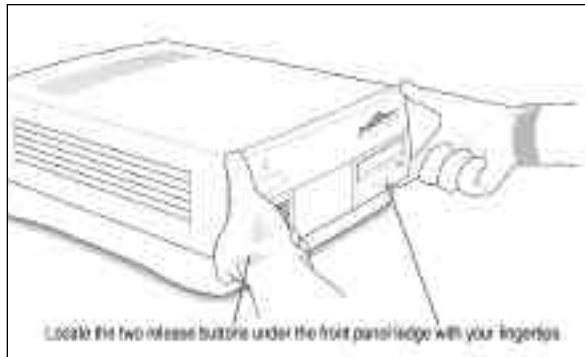

Pressing the release buttons



Sliding the cover towards you

3. Remove the cover from the computer.

- After you've slid the cover forward about two inches, lift it straight up and off the computer.

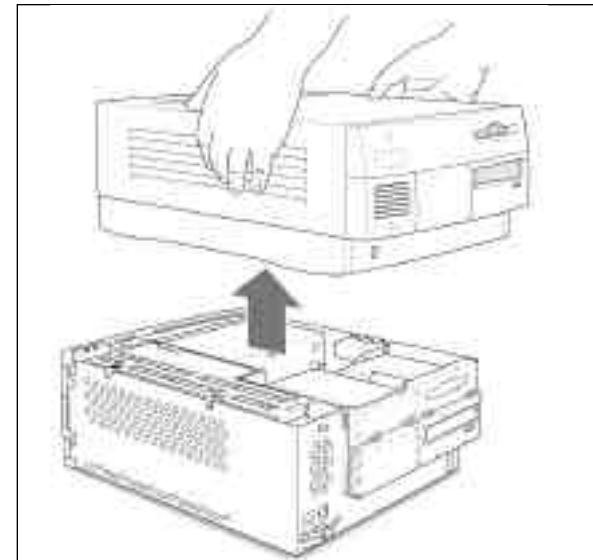

4. Flip the expansion card cover open

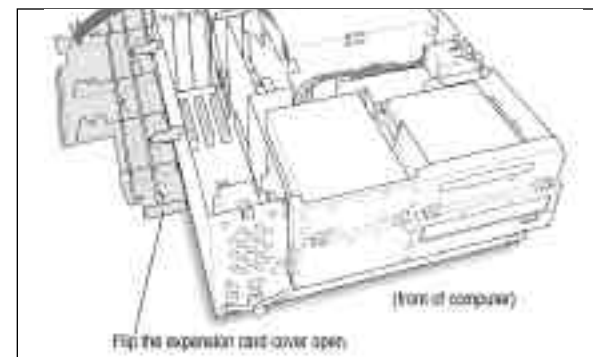

Flopping the cover open

5. Remove the CPU card that's in the computer now.
- Pull the card straight up without rocking it side-to-side. Do not pull on the heat sink because you may damage the card or your computer.

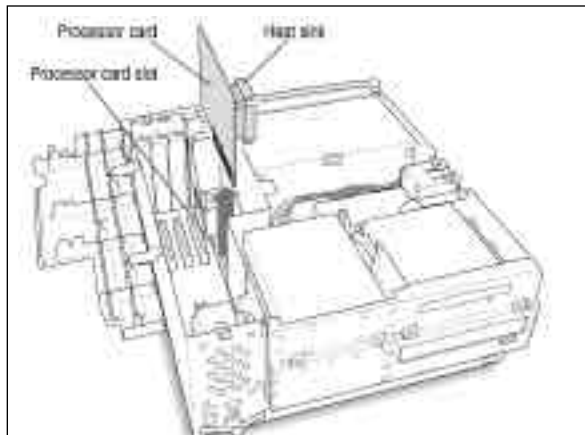

Removing the CPU card

6. Reset the motherboard, by depressing the CUDA switch.
- Located directly below the CPU card slot lies the motherboard reset switch, or CUDA. it is a small red button.
 - Depress this switch for 5 seconds with a small tool or pen point. failure to complete this instruction may cause the CPU not to be recognized when booted up for use.

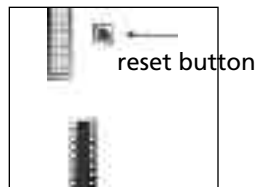

7. Remove the MACH Speed G3 from its protective package.
- Now that you are grounded, you can remove the MACH Speed from its protective package.
 - Inspect the card for any irregularities or possible damage in shipment.

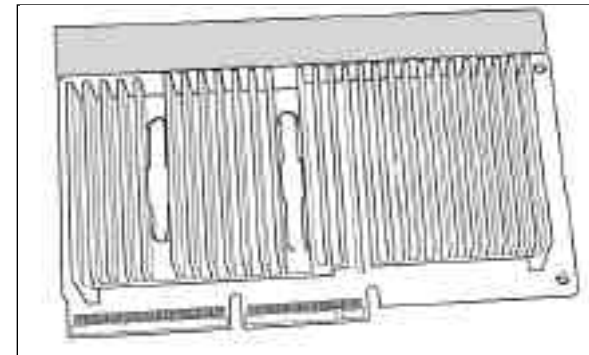

Inspecting the MACH Speed G3

8. Install the MACH Speed G3 into your system.

IMPORTANT: Handle by the edges only! Do not push down on the heat sink. Doing so may damage the card and/or computer. Excessive force is not needed to seat the card. If steady, gentle pressure does not work, pull the card out and insert again.

- The MACH Speed G3 Upgrade will face the same direction as the older card that you just removed. In most cases this is with the heat sink towards the Power Supply. The connector is designed to fit only one way.
- Holding the card by the edges (do not depress the heat sink), insert, into the connector without twisting or rocking.
- You may feel the card going into the slot in two stages: the first row of contacts slides in, and then the second row. Be sure that you push the card all the way into the slot.
- When the card is properly installed, you cannot see any of the gold contacts.

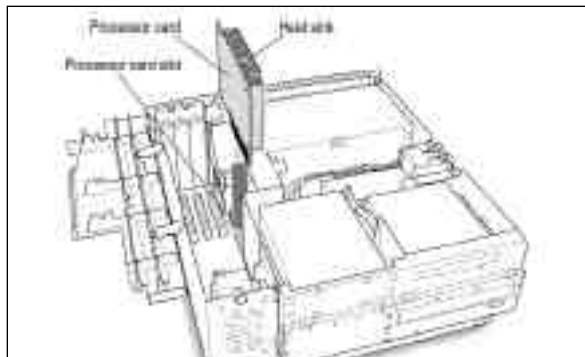

Installing the MACH Speed G3 Upgrade Card

9. Install the grounding clip.

- The clip slides over one wall of the top chassis. Make sure the grounding clip also touches the CPU card heat sink.
NOTE: If your Mac does not have a Grounding Strap, ignore this step.

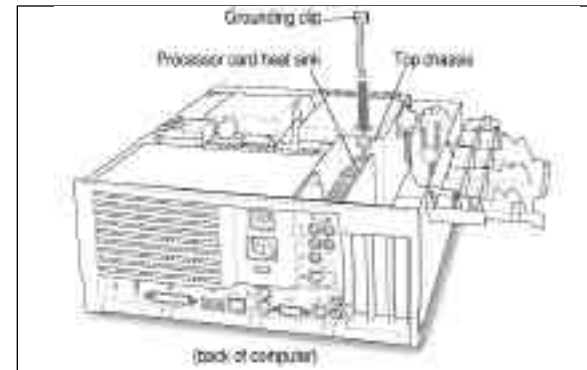

Installing the grounding clip

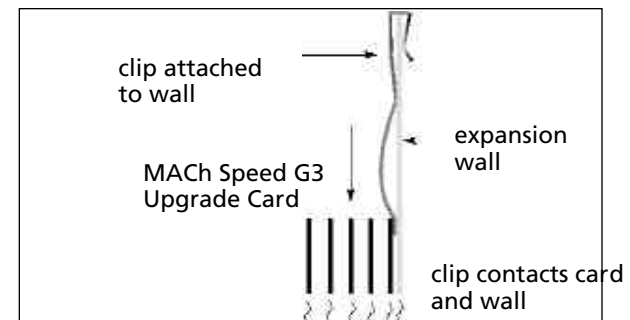

Cutaway view of the installed grounding clip

10. Close the expansion card cover and snap it into place

- If the cover won't close, make sure the CPU card has been inserted all the way into the connector.

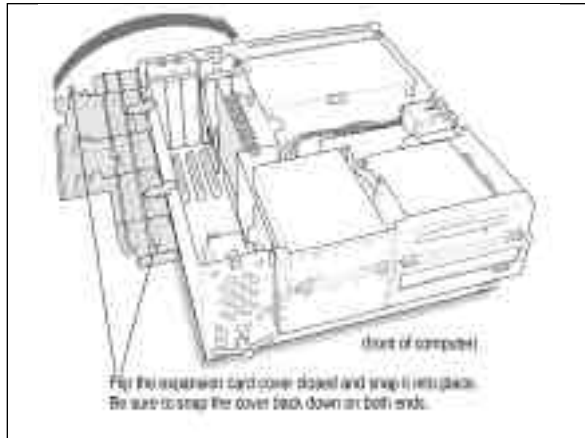

Closing the expansion card cover

11. Boot your Mac to test the Card/installation.

- Check that you get a successful boot up “chime”, ensuring that the card is well seated and working.
- Simply plug the power cord and keyboard into the Mac, and start up the Mac. Once you have verified the “chime”, you can disconnect power, and complete the card installation. If you do not hear a “chime”, refer to Chapter 5 - Tech Support.

12. Replace the cover on the computer



Closing the cover

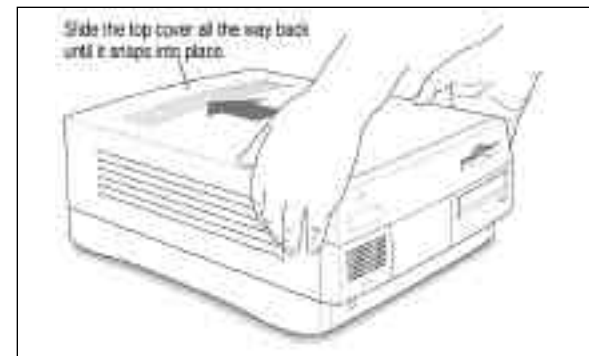

Snapping the cover into place

13. Reconnect all cables.

14. Package the old CPU card for later.

- Put the used card into MACH Speed anti-static bag. If you ever have a problem, it may be handy to be able to use the old card while troubleshooting the system.

15 Reboot your system and work faster than ever before!

- Proceed to Chapter 3 - Installing Software

Installation in a PowerMac 8500 or 9500

The MACH Speed G3 Upgrade Card gives your Macintosh 8500 or 9500 computer additional processing power. You install the upgrade card in the CPU card slot in your computer.

This section will instruct you on how to:

- Remove the cover from your computer
- Remove expansion card retainer
- Remove current CPU card
- Install the MACH Speed G3 Upgrade Card
- Replace the expansion card retainer
- Replace the computer cover

This chapter explains how to remove the CPU card currently inside your computer and replace it with the MACH Speed G3 Upgrade Card.

Installing the CPU card is technically challenging. If you prefer, you can ask an Apple-authorized dealer or service provider to install it for a fee.

If you attempt to install the card yourself but experience difficulties, it is recommended that you have an Apple-authorized service provider complete the process. Apple does not warranty damage caused by improper removal or installation of CPU cards.

1. Prepare the system and work area.

- Prepare your work area by ensuring that you have a well lighted space, preferably not on carpet (less static), and away from all magnetic devices.
- Put on the anti-static wrist strap, as instructed earlier.
- Turn off the computer and disconnect all cables.

2. Loosen the four large screws at the corners of the back panel.

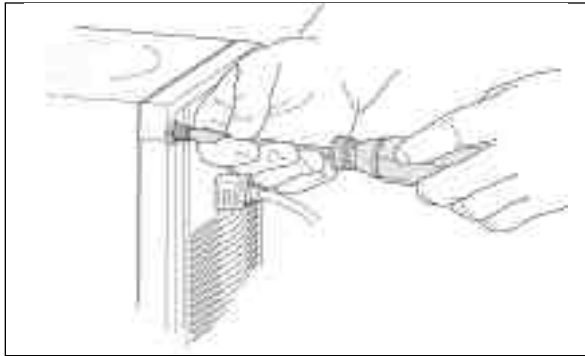

Loosen the screws

3. Remove the cover from the computer.

- Slide the cover away from the back panel an inch or two. Then raise the cover straight up and off the computer.

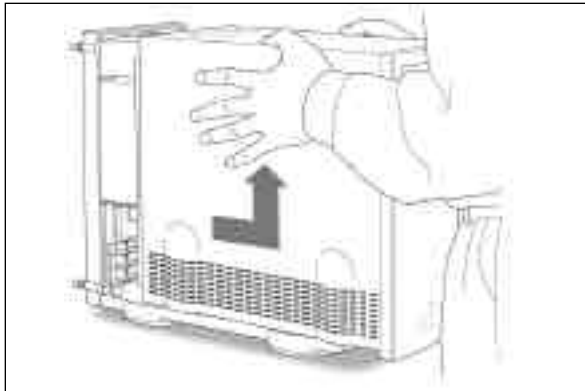

Sliding the cover towards you and up

4. Lower the auxiliary fan (retainer clip on 8500)

- Squeeze the sides and pull it down

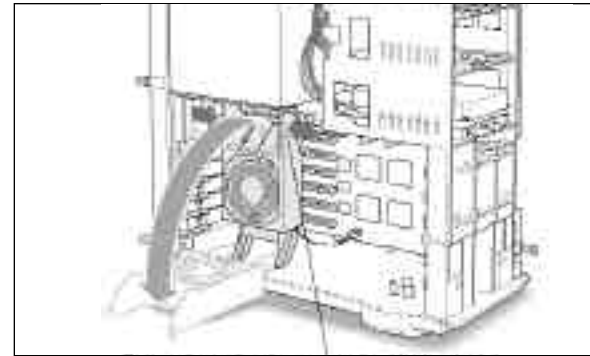

Lowering the auxiliary fan (retaining clip on 8500)

5. Unplug the auxiliary fan from the mains logic board.

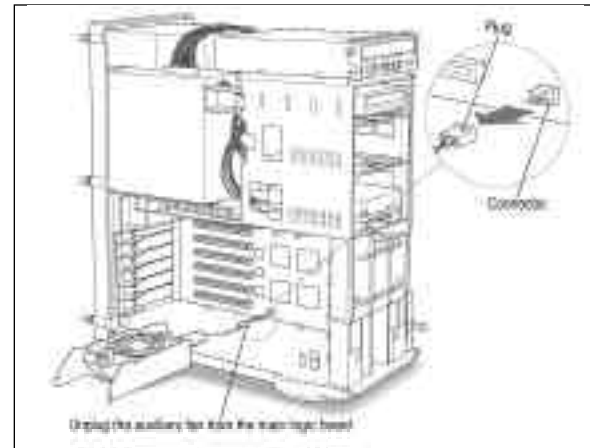

Unplugging the auxiliary fan (retaining clip on 8500)

- Remove the auxiliary fan (retaining clip on 8500).
 - To unlatch the fan, press the small button on the floor of the computer, near the left leg of the fan. Then slide the fan to the right and remove it.

Removing the auxiliary fan (retaining clip on 8500)

- Gently lay the computer on its side on a clean stable surface.
 - This makes it easier to insert the new CPU card correctly.

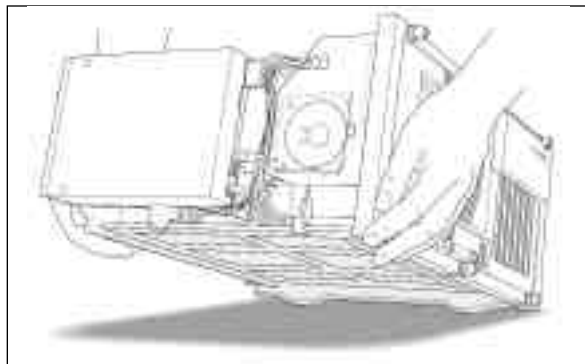

Laying the computer on its side for easy access

- Remove the CPU card that's in the computer now.
 - Grasp the edges of the card firmly and pull the card out of the slot.
 - Pull the card straight up without rocking it side-to-side. Do not pull on the heat sink because you might damage the card or your computer.

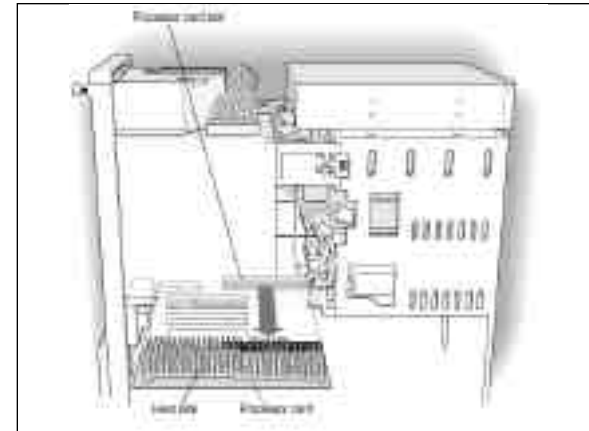

Removing the CPU card

- Reset the motherboard, by depressing the CUDA switch.
 - Located directly above the CPU card slot at the back of the computer, lies the motherboard reset switch, or CUDA. it is a small red button.
 - Depress this switch for 5 seconds with a small tool or pen point. failure to complete this instruction may cause the CPU not to be recognized when boot-ed up for use.

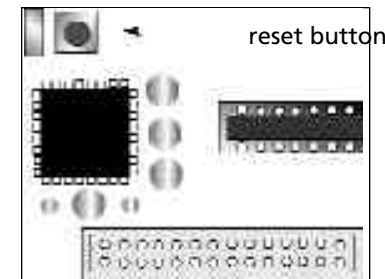

10. Remove the MACH Speed G3 from its protective package.

- Now that you are grounded, you can remove the MACH Speed from its protective package.
- Inspect the card for any irregularities or possible damage in shipment.

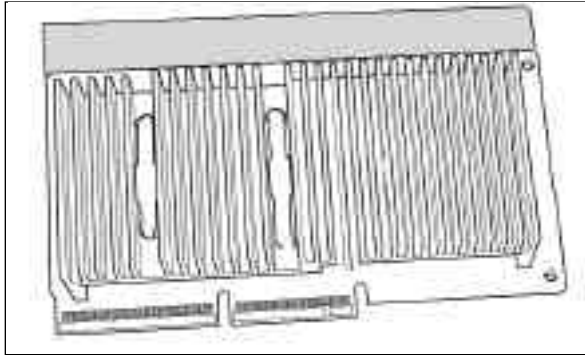

Inspecting the MACH Speed G3

11. Install the MACH Speed G3 into your system.

IMPORTANT: Handle by the edges only! Do not push down on the heat sink. Doing so may damage the card and/or computer. Excessive force is not needed to seat the card. If steady, gentle pressure does not work, pull the card out and insert again.

- The MACH Speed G3 Upgrade will face the same direction as the older card that you just removed. In most cases this is with the heat sink towards the Power Supply. The connector is designed to fit only one way.
- Holding the card by the edges (do not depress the heat sink), align the connector end of the card with the CPU card slot. Then, insert into the connector without twisting or rocking.
- You may feel the card going into the slot in two stages: the first row of contacts slides in, and then the second row. Be sure that you push the card all the way into the slot.
- When the card is properly installed, you cannot see any of the gold contacts.

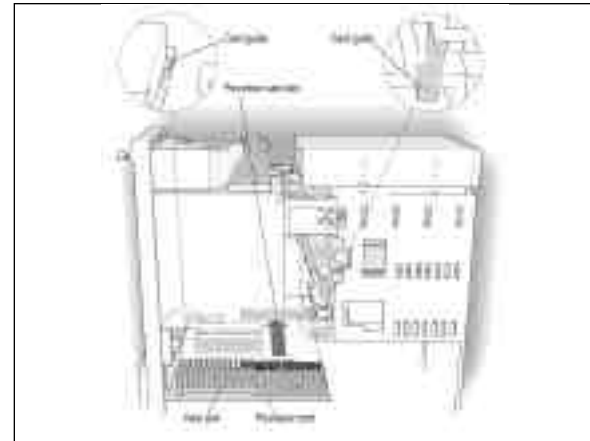

Installing the MACH Speed G3 Upgrade Card

12. Reinstall the auxiliary fan

- Lift the computer back to its upright position.
- Press and hold down the small button on the floor of the computer. Then slide the fan to the left, engaging the two plastic loops on the floor of the computer. When the fan is in place, the button pops up and secures it.

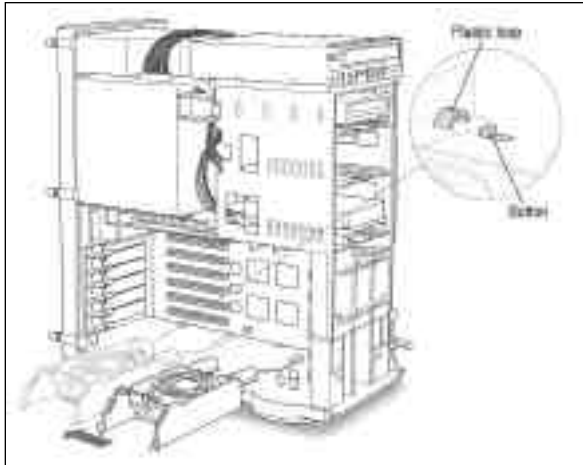

Reinstalling the fan (retaining clip on 8500)

13. Plug the auxiliary fan (9500) into the connector on the main logic board. There is only one correct way to insert the plug. Notice that the notch on the plug must face up

- **IMPORTANT:** If the fan cannot close, so that both sides are latched, the CPU card is not fully inserted. Remove the card, and reinstall.

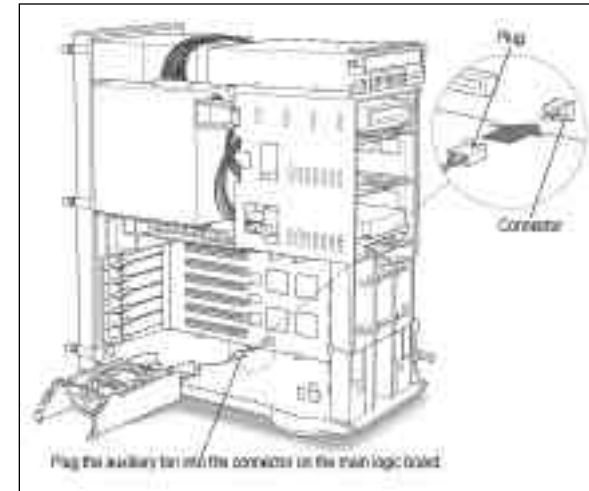

Attaching the fan power to the logic board

14. Lift the auxiliary fan back into place.

- **IMPORTANT:** If the fan cannot close, so that both sides are latched, the CPU card is not fully inserted. Remove the card, and reinstall.

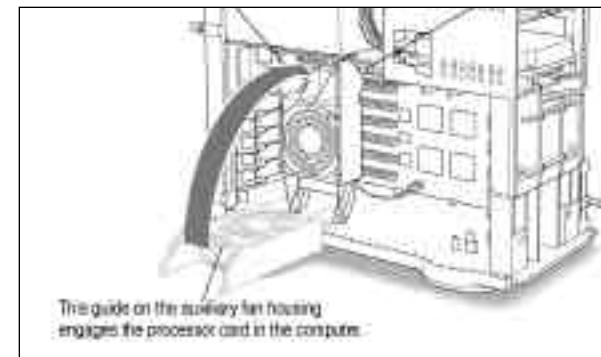

Lifting the auxiliary fan (retaining clip on 8500)

15. Boot your Mac to test the Card/installation.

- Check that you get a successful boot up “chime”, ensuring that the card is well seated and working
- Simply plug the power cord and keyboard into the Mac, and start up the Mac. Once you have verified the “chime, you can disconnect power, and complete the card installation. If you do not hear a “chime”, refer to Chapter 5 - Tech Support.

16. Replace the cover on the computer

- Lower the cover all the way down onto the case. Push the cover back until it touches the back panel.

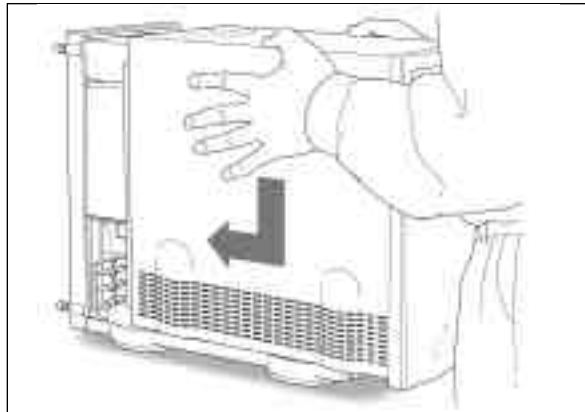

Replacing the cover

17. Tighten the screws on the back panel.

18. Reconnect all cables.

- You are now finished installing the card. You may turn on the computer and start using the new card.

19. Package the old CPU card for later.

- Put the used card into MACH Speed anti-static bag. If you ever have a problem, it may be handy to be able to use the old card while troubleshooting the system.

20. Reboot your system and work faster than ever before!

- Proceed to Chapter 3 - Installing Software

Installation in a PowerMac 8600, or 9600

The MACH Speed G3 Upgrade Card gives your Macintosh 8600 or 9600 computer additional processing power. You install the upgrade card in the CPU card slot in your computer.

This section will instruct you on how to:

- Remove the cover from your computer
- Remove expansion card retainer
- Remove current CPU card
- Install the MACH Speed G3 Upgrade Card
- Replace the expansion card retainer
- Replace the computer cover

This chapter explains how to remove the CPU card currently inside your computer and replace it with the MACH Speed G3 Upgrade Card.

Installing the CPU card is technically challenging. If you prefer, you can ask an Apple-authorized dealer or service provider to install it for a fee.

If you attempt to install the card yourself but experience difficulties, it is recommended that you have an Apple-authorized service provider complete the process. Apple does not warranty damage caused by improper removal or installation of CPU cards.

1. Prepare the system and work area.

- Prepare your work area by ensuring that you have a well lighted space, preferably not on carpet (less static), and away from all magnetic devices.
- Put on the anti-static wrist strap, as instructed earlier.
- Turn off the computer and disconnect all cables.
- If the computer cover is locked shut, unlock it by removing the security cable or padlock from the cover latch.

2. Carefully lay the computer on its side with the cover and button facing up

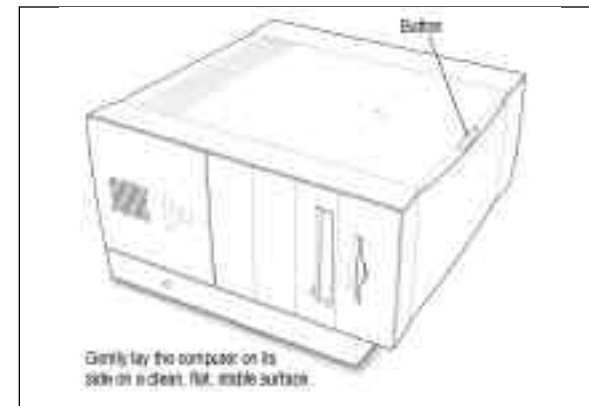

Lay the computer on its side

3. Press the release button on the side of the cover.

- Lift the cover near the button a few inches.
- * Slide the cover to the right and lift it out.

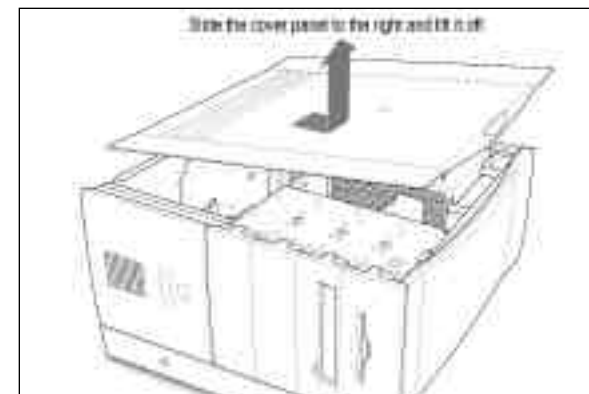

Sliding the cover panel to the right and lifting it off

4. Unlock the top chassis by rotating the two locking levers on the chassis

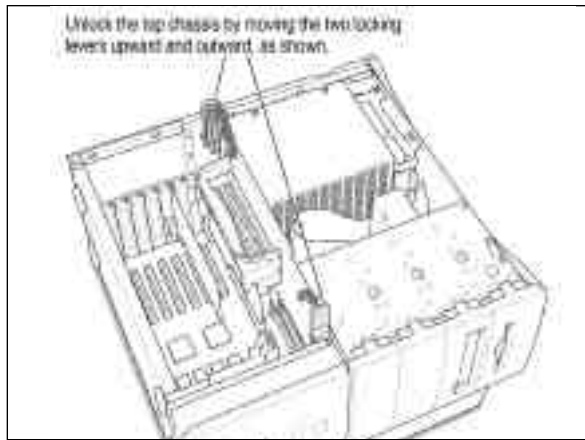

Unlocking the chassis

5. Using the plastic handle, lift the top chassis up and to the side until it rests on your working surface, clearly revealing the CPU card.

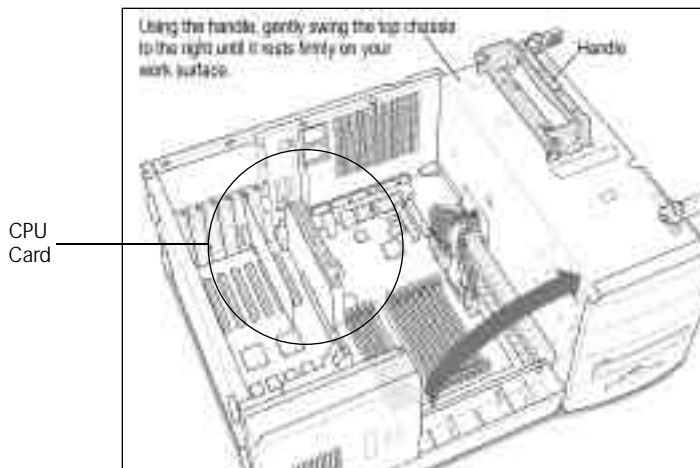

Swing the chassis to reveal the CPU card

6. Remove the CPU card that's in the computer now.
- Grasp the edges of the card firmly and pull the card out of the slot.
 - Pull the card straight up without rocking it side-to-side. Do not pull on the heat sink because you might damage the card or your computer.

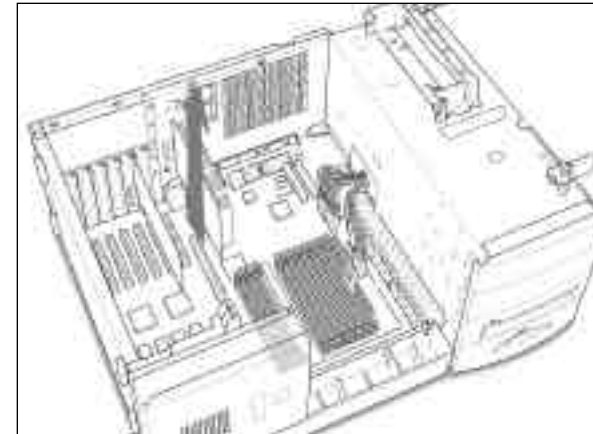

Removing the CPU card

7. Reset the motherboard, by depressing the CUDA switch.
- Located directly above the CPU card slot at the back of the computer, lies the motherboard reset switch, or CUDA. it is a small red button.
 - Depress this switch for 5 seconds with a small tool or pen point. failure to complete this instruction may cause the CPU not to be recognized when booted up for use.

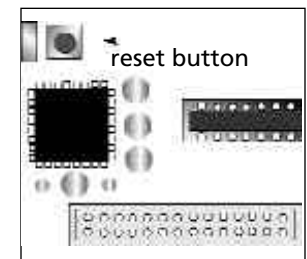

8. Remove the MACH Speed G3 from its protective package.
 - Now that you are grounded, you can remove the MACH Speed from its protective package.
 - Inspect the card for any irregularities or possible damage in shipment.

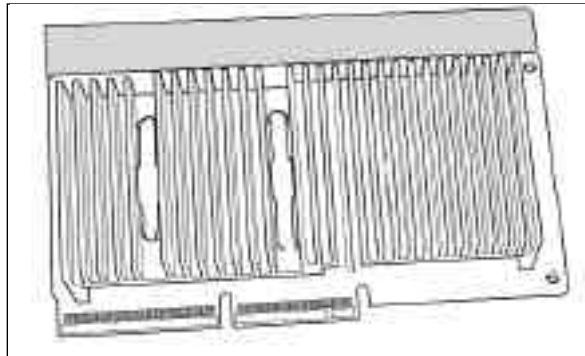

Inspecting the MACH Speed G3

9. Install the MACH Speed G3 into your system.

IMPORTANT: Handle by the edges only! Do not push down on the heat sink. Doing so may damage the card and/or computer. Excessive force is not needed to seat the card. If steady, gentle pressure does not work, pull the card out and insert again.

- The MACH Speed G3 Upgrade will face the same direction as the older card that you just removed. In most cases this is with the heat sink towards the Power Supply. The connector is designed to fit only one way.
- Holding the card by the edges (do not depress the heat sink), align the connector end of the card with the CPU card slot. Then, insert into the connector without twisting or rocking.
- You may feel the card going into the slot in two stages: the first row of contacts slides in, and then the second row. Be sure that you push the card all the way into the slot.

- When the card is properly installed, you cannot see any of the gold contacts.

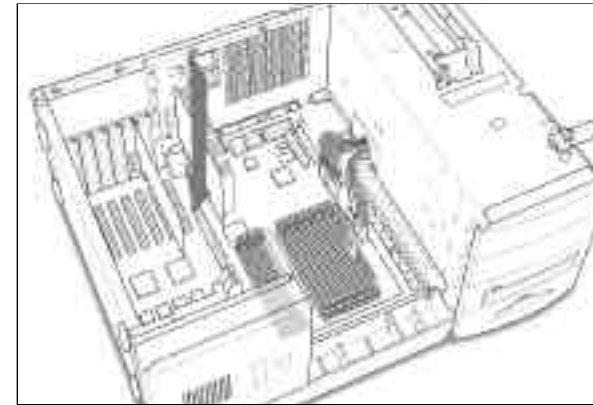

Installing the MACH Speed G3 Upgrade Card

10. Replace the chassis by swinging it back into place

- Using the handle, gently swing the top chassis closed until it rests firmly on the bottom chassis.

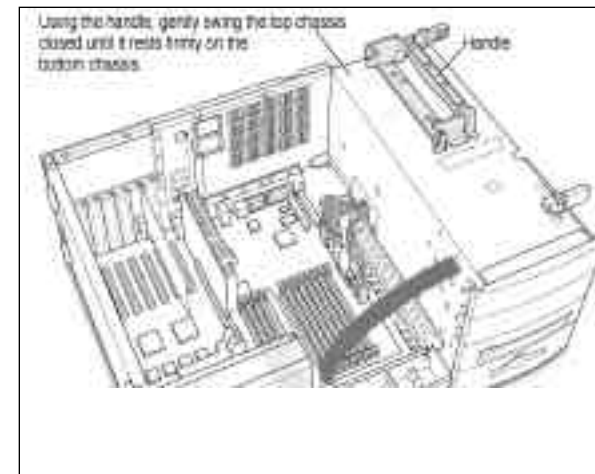

Swinging the chassis into place

11. Boot your Mac to test the Card/installation.

- Check that you get a successful boot up “chime”, ensuring that the card is well seated and working.
- Simply plug the power cord and keyboard into the Mac, and start up the Mac. Once you have verified the “chime”, you can disconnect power, and complete the card installation. If you do not hear a “chime”, refer to Chapter 5 - Tech Support.

12. Lock the chassis by rotating the locking levers.

- Lock the top chassis in place by moving the two locking levers inward and downward, as shown. Be sure that they snap underneath the raised catches on the chassis.

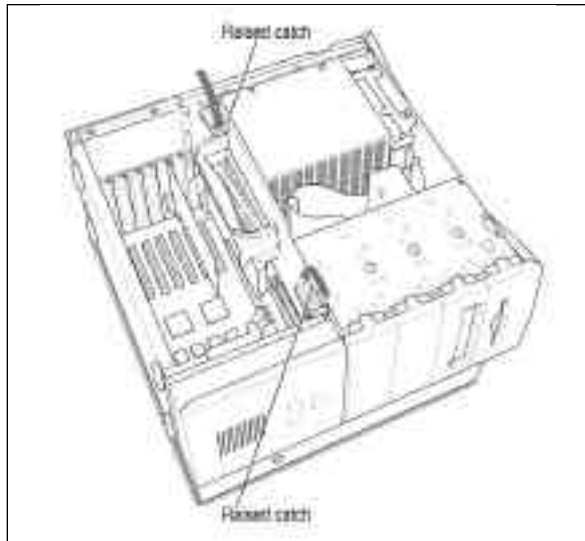

Rotating the locking levers

13. Replace the computer cover panel.

- Align the bottom edges of the cover panel with the computer chassis as shown below.
- Then press the cover panel onto the chassis until it snaps into place.

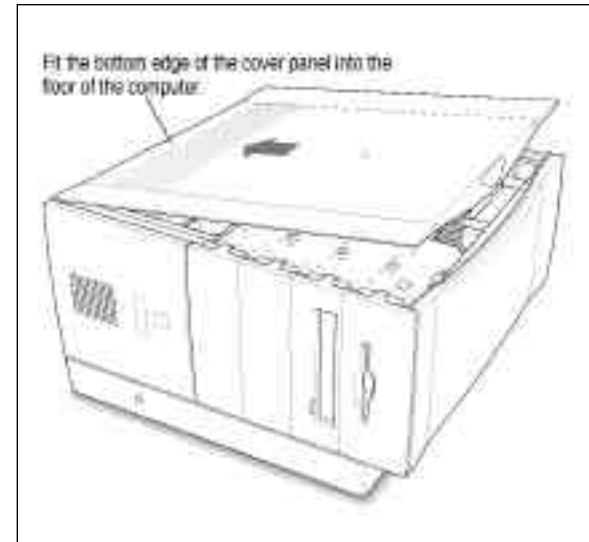

Replacing the cover

14. Reconnect all cables.

- You are now finished installing the card. You may turn on the computer and start using the new card.

15. Package the old CPU card for later.

- Put the used card into MACH Speed anti-static bag. If you ever have a problem, it may be handy to be able to use the old card while troubleshooting the system.

16 Reboot your system and work faster than ever before!

- Proceed to Chapter 3 - Installing Software

Installation in Non-Apple Mac OS Systems UMAX S900, J700, PowerCC PowerWave, DayStar Genesis and Millennium

The MACH Speed G3 Upgrade Card gives your MacOS System additional processing power. You install the upgrade card in the CPU card slot in your computer.

This section will instruct you on how to:

- Remove the cover from your computer
- Remove expansion card retainer
- Remove current CPU card
- Install the MACH Speed G3 Upgrade Card
- Replace the expansion card retainer
- Replace the computer cover

This chapter explains how to remove the CPU card currently inside your computer and replace it with the MACH Speed G3 Upgrade Card.

Installing the CPU card is technically challenging. If you prefer, you can ask an Apple-authorized dealer or service provider to install it for a fee.

If you attempt to install the card yourself but experience difficulties, it is recommended that you have an Apple-authorized service provider complete the process. Apple does not warranty damage caused by improper removal or installation of CPU cards.

1. Prepare the system and work area.
 - Prepare your work area by ensuring that you have a well lighted space, preferably not on carpet (less static), and away from all magnetic devices.
 - Put on the anti-static wrist strap, as instructed earlier.
 - Turn off the computer and disconnect all cables.
2. Following the manufacturer's recommended procedures, remove the cover (PowerCC), or side access door (UMAX, DayStar systems).

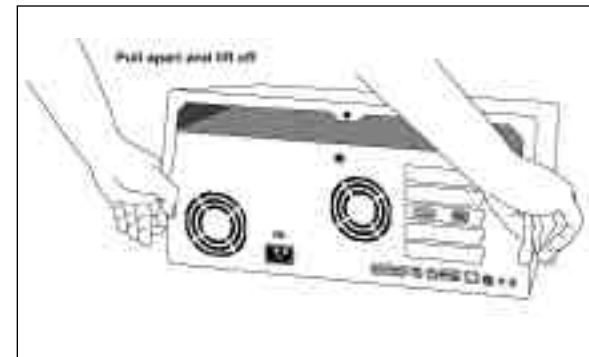

Removing the cover of the PowerCC PowerWave desktop

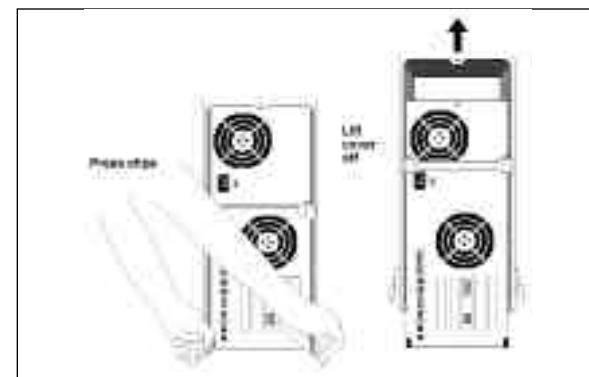

Removing the cover of the PowerCC PowerWave tower

3. Locate & Remove the CPU card that's in the computer now.

- Grasp the edges of the card firmly and pull the card out of the slot.
- Pull the card straight up without rocking it side-to-side. Do not pull on the heat sink because you might damage the card or your computer.

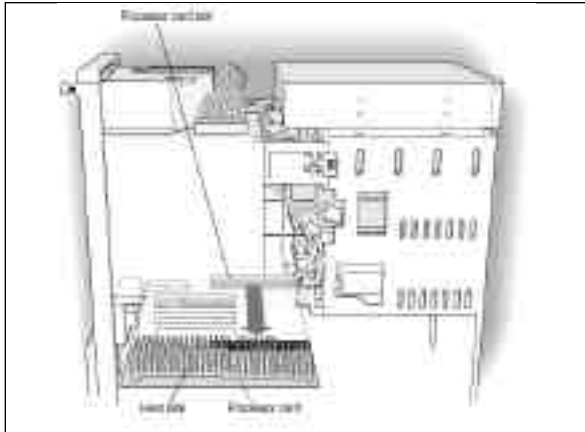

Removing the CPU card from a tower system

4. Reset the motherboard, by depressing the CUDA switch.

- Located directly above the CPU card slot at the back of the computer, lies the motherboard reset switch, or CUDA. it is a small red button.
- If the CUDA switch is not readily noticeable, you need to consult the user manual for your specific system.
- Depress this switch for 5 seconds with a small tool or pen point. failure to complete this instruction may cause the CPU not to be recognized when boot-ed for use.

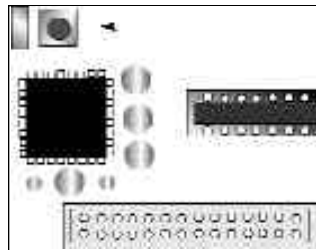

5. Remove the MACH Speed G3 from its protective package.

- Now that you are grounded, you can remove the MACH Speed from its protective package.
- Inspect the card for any irregularities or possible damage in shipment, and check your cache type.

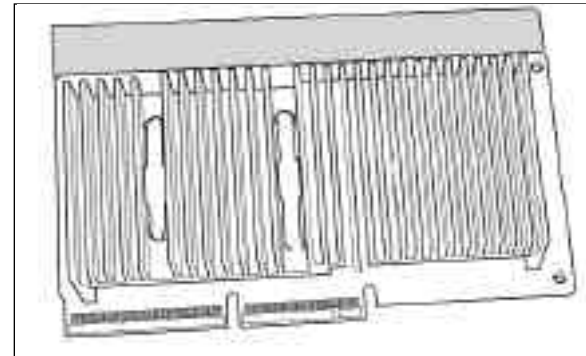

Inspecting the MACH Speed G3

Note on PowerCC Systems: The CPU card bay does not support the full height card on many PowerWave systems. you may need to remove the black extension plate from the top edge of the CPU card before installing.

This can be easily done by removing the two screws at the top of the card, removing the plate, then replacing the screws, which continue to support the heat sink. Consult your manufacturer's user guide for more information.

6. Install the MACH Speed G3 into your system.

IMPORTANT: Handle by the edges only! Do not push down on the heat sink. Doing so may damage the card and/or computer. Excessive force is not needed to seat the card. If steady, gentle pressure does not work, pull the card out and insert again.

- The MACH Speed G3 Upgrade will face the same direction as the older card that you just removed. In most cases this is with the heat sink towards the Power Supply. The connector is designed to fit only one way.
- Holding the card by the edges (do not depress the heat sink), align the connector end of the card with the CPU card slot. Then, insert into the connector without twisting or rocking.
- You may feel the card going into the slot in two stages: the first row of contacts slides in, and then the second row. Be sure that you push the card all the way into the slot.
- When the card is properly installed, you cannot see any of the gold contacts.

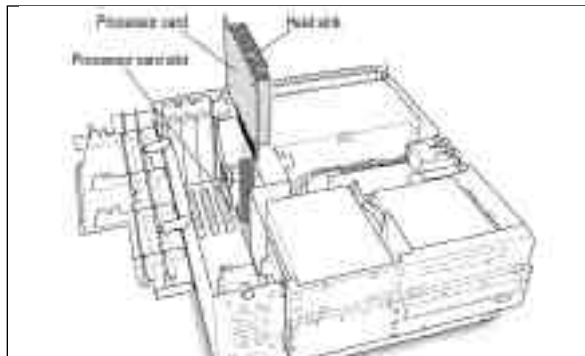

Installing the MACH Speed G3 Upgrade Card

7. Boot your Mac to test the Card/installation.

- Check that you get a successful boot up “chime”, ensuring that the card is well seated and working.
- Simply plug the power cord and keyboard into the Mac, and start up the Mac. Once you have verified the “chime”, you can disconnect power, and complete the card installation. If you do not hear a “chime”, refer to Chapter 5 - Tech Support.

8. Replace the cover on the computer

- Lower the cover all the way down onto the case. Push the cover back until it touches the back panel.

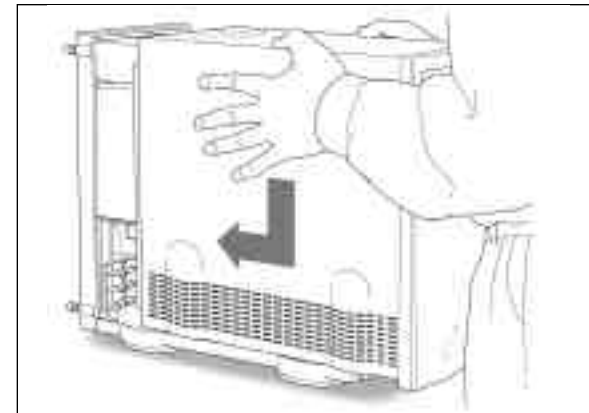

Replacing the cover

9. Tighten the screws on the back panel.

10. Reconnect all cables.

- You are now finished installing the card. You may turn on the computer and start using the new card.

3

Installing the Software

11. Package the old CPU card for later.

- Put the used card into MACH Speed anti-static bag. If you ever have a problem, it may be handy to be able to use the old card while troubleshooting the system.

12. Reboot your system and work faster than ever before!

- Proceed to Chapter 3 - Installing Software

This chapter will provide the information you need to enable the MACH Speeds incredible backside cache. It also provides information on XLR8's Processor Info Utility, which gives excellent feedback on the CPU card's current status.

This chapter will instruct you on how to:

- Install the XLR8 software
- Use the XLR8 Processor Info Utility
- Use the MACH Speed G3 Upgrade Control

Your package includes the XLR8 Software diskette. This diskette includes everything needed to enable and periodically review the G3 upgrade card.

The software controls the activation of the Backside Cache and controls the ratios it operates at. When first installed, the MACH Speed's backside cache will not be enabled. Follow the instructions below to complete the installation of the software and enable the backside cache.

1. After you have installed your MACH Speed G3

Upgrade Card... Copy the Software to your startup disk.

- After booting your Macintosh, insert the floppy disk.
- Review the readme file on the disk for any last minute changes or updates.
- Copy the MACH Speed G3 Control file to the Control Panels folder in the System of your start-up System drive.
- Copy the Processor Info file into any Non-System folder.

The Processor Info Utility

1. Open the Processor Info Utility

- Open the folder in which you copied the Processor Info utility. Double-click on the XLR8 Processor Info. Review the dialog for correct information.

Note: If the CPU speed or cache size are reading incorrectly, you may have a problem with your system. Consult Chapter 5 - Tech Support.



CPU operating clock speed is determined by the formula:
 $BUS\ Ratio \times BUS\ Speed = CPU\ speed\ in\ MHz.$

The MACH Speed G3 cards are preset at factory as follows:

Model	Bus Speed	CPU Ratio	CPU Speed
MACH Speed G3 266	41.00 MHz	6.5:1	266.5 MHz
MACH Speed G3 275	42.60 MHz	6.5:1	276.9 MHz
MACH Speed G3 300	40.00 MHz	7.5:1	300.0 MHz
MACH Speed G3 333	41.60 MHz	7.5:1	334.5 MHz
MACH Speed G3 366	46.00 MHz	8.0:1	368.0 MHz
MACH Speed G3 400	50.00 MHz	8.0:1	400.0 MHz

Information provided in the PI Utility includes:

- XLR8 Contact:** This is handy information for when you need to contact XLR8 for question or comments.
- CPU Speed:** Checks the current operating speed of the CPU.
- Bus Speed:** Provides the current speed of the bus (connection) between the CPU and the motherboard.
- CPU to Bus Ratio:** Provides the current multiplier used to run the CPU at the current speed.
- Backside Cache:** Provides the current size of the backside cache on the MACH Speed G3 Upgrade Card.
- CPU Temp:** This provides the current temperature for the CPU on the MACH Speed. the optimum temperature range is from 0° C to 85° C.

The MACH Speed G3 Control

1. Enable the MACH Speed G3 Backside Cache.

- In the Control Panels folder of your start-up drive, double-click on the MACH Speed G3 Control.
- This software control the activation of the backside cache and controls the ratio at which it operates. You are now ready to turn the backside cache on.

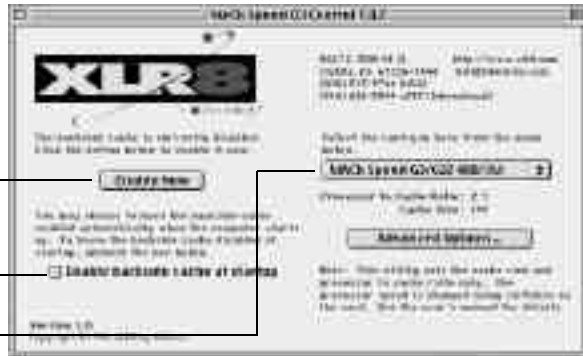

Step A. Select your MACH Speed G3 model from the pull-down menu.

Step B. Select “Enable Now” to enable the backside cache. If your system freezes at this point, you most likely selected the wrong card. Reboot and select again.

Step C. Now that your cache is enabled, you should select “Enable Backside Cache at Startup” to automatically enable the cache every time you boot your system.

About the “Advanced options”. This area is for enabling XLR8’s exclusive MVP technology. Refer to Chapter 4 - Advanced Performance Tuning for more information.

2. Close the MACH Speed G3 Control, restart your system, and enjoy working at new speeds!

NOTE: If your system hangs on boot, or displays any error messages, refer to Chapter 5 - Tech Support for more information.

Advanced Performance Tuning

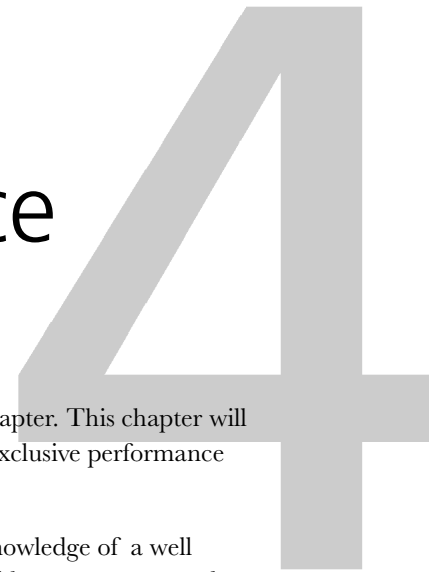

Welcome to the Advanced Performance chapter. This chapter will provide information on enabling XLR8's exclusive performance technology, MVP.

This Chapter assumes that you have the knowledge of a well versed technician, and that you understand how to remove and install various expansion cards. It also assumes that you have a good knowledge of troubleshooting procedures.

MVP, Multiple Variable Processing allows you to tap the unused performance in your MACH Speed system, by allowing you to adjust bus ratios, and CPU multiplier for the highest possible optimized settings for your system. In short, MVP will deliver up to 20% more speed for your MACH Speed System!

Current MACH Speed Settings

CPU operating clock speed is determined by the formula:
$$\text{BUS Ratio} \times \text{BUS Speed} = \text{CPU speed in MHz.}$$

The MACH Speed G3 cards are preset at factory as follows:

<u>Model</u>	<u>Bus Speed</u>	<u>CPU Ratio</u>	<u>CPU Speed</u>
MACH Speed G3 266	41.00 MHz	6.5:1	266.5 MHz
MACH Speed G3 275	42.60 MHz	6.5:1	276.9 MHz
MACH Speed G3 300	40.00 MHz	7.5:1	300.0 MHz
MACH Speed G3 333	41.60 MHz	7.5:1	334.5MHz
MACH Speed G3 366	46.00 MHz	8.0:1	368.0 MHz
MACH Speed G3 400	50.00 MHz	8.0:1	400.0 MHz

About Multiple Variable Processing™

Only XLR8's MACH Speed G3 CPU CPU cards have the advantage of Multiple Variable Processing. This unique feature allows you to fine tune your card to the hardware and software configuration of your computer model.

This fine tuning is accomplished by adjusting the CPU Card BUS Speed with switches 1-7 on the MACH Speed card.

Once the BUS speed is set, Ratios are set which determine the final operating speed of the CPU (switches 8-12 on the card) and its dedicated cache (via the control panel).

Adjusting for Maximum CPU Operating Speed

Adjusting for Maximum Speed is "hit & miss" at best. To find your maximum, you will have to find the "wall". This can only be located by adjusting to the point that the card fails, then lowering the settings.

This is not for the faint of heart. But it is very rewarding. You will reap the benefits of extreme speed and productivity.

XLR8 Utilizes a series of 12 switches on the MACH Speed G3 Upgrade card to adjust the BUS Speed (CPU to motherboard) and the CPU to BUS Ratio (CPU Multiplier) in order to set the actual CPU speed at which the card will operate.

- Switches 1-8 set the Card's BUS Speed.
- Switches 9-12 determine the Ratio (or multiplier) at which the CPU will operate.

Base Settings	Switches in the "ON" position	Bus Speed	Bus ratio
220	1,3,4,6 - 10,11	40.0	5.5 to 1
233	1,6,8 - 10,11	42.6	5.5 to 1
266	6,8 - 10,12	41.0	6.5 to 1
275	1,6,8 - 10,12	42.6	6.5 to 1
300	1,3,4,6 - 10,11,12	40.0	7.5 to 1
333	3,4,6,8 - 9,10	44.6	7.5 to 1
366	1,4,6,7 - 9,10	46.0	8.0 to 1
400	1,2,4,6,7,8 - 9,10	50.0	8.0 to 1

1. Shut down your computer and remove the cover.
 - To adjust the CPU to its maximum operating speed locate the current speed settings in the table at the left
 - Keeping a consistent Ratio setting (switches 9-12), adjust switches 1-8 to the BUS Speed at the next highest setting, (refer to the table on the following page).
 - Boot your system
2. Run your system at the new setting for at least 24 hours to determine that your system is stable at the new speed.
 - If your card is running well at the new speed, then you can again follow the earlier steps to take your card to the next speed.
 - If your card is running well at multiple BUS Speed settings above the standard BUS Speed settings, then you can also experiment with adjusting the Bus Ratio Settings (switches 9-12) on the card.
 - When you reach a speed that is unstable. You should adjust your BUS Ratio to a .5x higher. This will allow higher processor speeds without being limited by the bus speed.
 - Your system should be able to run memory tests such as TechTool Pro, DayStar's PowerControl Testing software, or MacBench overnight, consistently.

Note: To find the maximum achievable CPU speed, the following steps can also be followed with the cache disabled. This allows you to determine the maximum speed that the CPU will run on the bus. Once a comfortable speed has been achieved, the cache can be enabled. It is normal, that the CPU speed will have to be lowered slightly to compensate when the cache is enabled.

MVP CPU Frequency Chart

Switches in "ON" position		12	11	10,11	10	10,12	9,11,12	10,11,12	9,10
		Bus Ratio							
		4.5	5	5.5	6	6.5	7	7.5	8
1,3,4,6	40.0	180.0	200.0	220.0	240.0	260.0	280.0	300.0	320.0
1,2,3,6	40.6	182.7	203.0	223.3	243.6	263.9	284.2	304.5	324.8
6,8	41.0	1487.2	208.0	228.8	249.6	270.4	291.2	312.0	332.8
2,4,6,8	42.0	189.0	210.0	231.0	252.0	273.0	294.0	315.0	336.0
1,6,8	42.6	191.7	213.0	234.3	255.6	276.9	298.2	319.5	340.8
1,3,6,8	43.0	193.5	215.0	236.5	258.0	279.5	301.0	322.5	344.0
1,2,4,6,8	43.6	196.2	218.0	239.8	261.6	283.4	305.2	327.0	348.8
1,2,3,4,6,8	44.0	198.0	220.0	242.0	264.0	286.0	308.0	330.0	352.0
3,6,7	44.6	200.7	223.0	245.3	267.6	289.9	312.2	334.5	356.8
2,6,7	45.0	202.5	225.0	247.5	270.0	292.5	315.0	337.5	360.0
2,3,4,6,7	45.6	205.2	228.0	250.8	273.6	296.4	319.2	342.0	364.8
1,4,6,7	46.0	207.0	230.0	253.0	276.0	299.0	322.0	345.0	368.0
1,2,6,7	46.6	209.7	233.0	256.3	279.6	302.9	326.2	349.5	372.8
1,2,3,6,7	47.0	211.5	235.0	258.5	282.0	305.5	329.0	352.5	376.0
4,6,7,8	47.6	214.2	238.0	261.8	285.6	309.4	332.2	357.0	380.8
3,4,6,7,8	48.0	216.0	240.0	264.0	288.0	312.0	336.0	360.0	384.0
2,3,6,7,8	48.6	218.7	243.0	267.3	291.6	315.9	340.2	364.5	388.8
1,6,7,8	49.0	220.5	245.0	269.5	294.0	318.5	343.0	367.5	392.0
1,3,4,6,7,8	49.6	223.2	248.0	272.8	297.6	322.4	347.2	372.0	396.8
1,2,4,6,7,8	50.0	225.0	250.0	275.0	300.0	325.0	350.0	375.0	400.0
5	50.6	227.7	253.0	278.3	303.6	328.9	354.2	379.5	404.8
3,5	51.0	229.5	255.0	280.5	306.0	331.5	357.0	382.5	408.0
2,4,5	51.6	232.2	258.0	283.8	309.6	335.4	361.2	387.0	412.8
2,3,4,5	52.0	234.0	260.0	286.0	312.0	338.0	364.0	390.0	416.0
1,3,5	52.6	236.7	263.0	289.3	315.6	341.9	368.2	394.5	420.8
1,2,5	53.0	238.5	265.0	291.5	318.0	344.5	371.0	397.5	424.0
1,2,3,4,5	53.6	241.2	268.0	294.8	321.6	348.4	375.2	402.0	428.8
4,5,8	54.0	243.0	270.0	297.0	324.0	351.0	378.0	405.0	432.0
2,5,8	54.6	245.7	273.0	300.3	327.6	354.9	382.2	409.5	436.8
2,3,5,8	55.0	247.5	275.0	302.5	330.0	357.5	385.0	412.5	440.0
1,4,5,8	55.6	250.2	278.0	305.8	333.6	361.4	389.2	417.0	444.8
1,3,4,5,8	56.0	252.0	280.0	308.0	336.0	364.0	392.0	420.0	448.0
1,2,3,5,8	56.6	254.7	283.0	311.3	339.6	367.9	396.2	424.5	452.8
5,7	57.0	256.5	285.0	313.5	342.0	370.5	399.0	427.5	456.0
3,4,5,7	57.6	259.2	288.0	316.8	345.6	374.4	403.2	432.0	460.8
2,4,5,7	58.0	261.0	290.0	319.0	348.0	377.0	406.0	435.0	464.0
1,5,7	58.6	263.7	293.0	322.3	351.6	380.9	410.2	439.5	468.8
1,3,5,7	59.0	265.5	295.0	324.5	354.0	383.5	413.0	442.5	472.0
1,2,4,5,7	59.6	268.2	298.0	327.8	357.6	387.4	417.2	447.0	476.8
1,2,3,4,5,7	60.0	270.0	300.0	330.0	360.0	390.0	420.0	450.0	480.0

Base Settings	Switches in the "ON" position	Bus Speed	Bus ratio
220	1,3,4,6 - 10,11	40.0	5.5 to 1
233	1,6,8 - 10,11	42.6	5.5 to 1
266	6,8 - 10,12	41.0	6.5 to 1
275	1,6,8 - 10,12	42.6	6.5 to 1
300	1,3,4,6 - 10,11,12	40.0	7.5 to 1
333	3,4,6,8 - 9,10	44.6	7.5 to 1
366	1,4,6,7 - 9,10	46.0	8.0 to 1
400	1,2,4,6,7,8 - 9,10	50.0	8.0 to 1

Adjusting the Maximum Backside Cache Speed

Backside cache is the revolutionary new technology that places Level 2 cache (high speed memory) directly on the CPU card, dedicated to the G3 CPU.

Since this is a dedicated cache technology, on its own BUS, it is not limited to the slower fixed speed (± 50 MHz) of the main logic board BUS. The backside cache can run at speeds up the speed of the CPU itself.

Most often though, the backside cache operates at half the speed of the CPU. Even this speed is nearly 4 times faster than earlier in-line, and look-aside caching technologies.

The Speed of the Cache is derived from the Ratios of the set operating speed of the CPU. For example, if the CPU runs at 400 MHz, and the backside cache Ratio is 2:1, then the backside cache will run at 200 MHz

To adjust the Backside Cache Speed:

1. Open the MACH Speed G3 Control in your Control Panels folder.

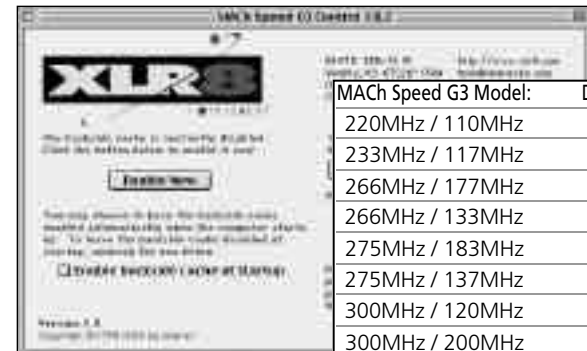

MACH Speed G3 Model:	Default Setting
220MHz / 110MHz	2:1
233MHz / 117MHz	2:1
266MHz / 177MHz	1.5:1
266MHz / 133MHz	2:1
275MHz / 183MHz	1.5:1
275MHz / 137MHz	2:1
300MHz / 120MHz	5:2
300MHz / 200MHz	2:1
333MHz / 166MHz	2:1
366MHz / 183MHz	2:1
400MHz / 200MHz	2:1

Opening the G3 Control

2. Uncheck automatic startup of the cache.

- To avoid having problems with boot-up if you select “too fast” of a setting, deselect the “Enable backside cache at startup box”. You can enable automatic start-up later once you have found the optimum setting.

3. Select “Advanced Options:

- Set the Cache control to the next highest Ratio. some settings are not available for some card as the setting would result in speeds much too high for the cache.
- Select “OK”

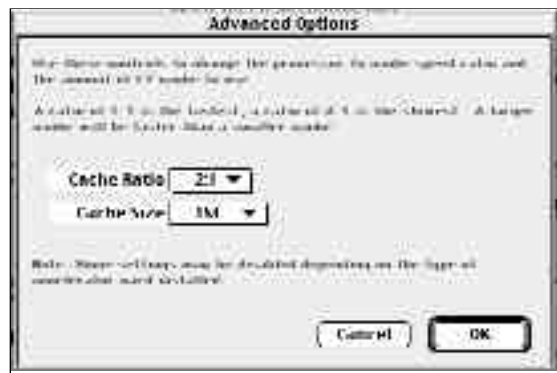

Setting the Cache Ratio for Maximum speed

4. Restart the backside cache

- In the main window, select “Enable Now”
- If you freeze at this point, then you have selected too fast of a setting for your backside cache. It is possible to adjust the CPU settings on the card to a slower setting, then using a higher ratio on the backside cache.
- Your system should be able to run memory tests such as TechTool Pro or DayStar’s PowerControl Testing software overnight consistently to operate at the higher speeds.

Miscellaneous Performance Notes

- Many factors effect the performance of the CPU card. using high quality expansion products, cables and RAM will ensure that you have a system that can perform much faster with a “tuned” MACH Speed upgrade.
- Any speed can be set for any CPU, but a CPU will generally only operate at 20% more than its manufacturer rated speed.
- Most of the logic boards supported by the MACH Speed have a maximum Bus Speed of around 50 MHz.
- The CPU operating speed and the cache operating speed are linked by the BUS speed on the card. The final operating speed of each is determined by the its Ratio to the card’s BUS speed.
- CPU operating clock speed is determined by:
$$\text{BUS Ratio} \times \text{BUS Speed} = \text{CPU speed in MHz.}$$
- Once the MACH Speed G3 Upgrade Card is installed, the Motherboard Level 2 cache becomes a Level 3 cache. Since the Motherboard cache is smaller than the Level 2 cache, it will not add to the system performance. If possible (as in the 8500/7500), you should remove the motherboard cache.

Technical Support

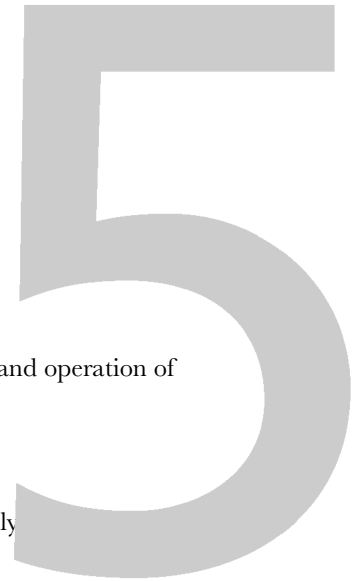

Direct questions concerning proper installation and operation of the

MACH Speed G3 Card to:

1.800.513.9744 ext. 333 (Technical Support Only)
(316) 636-5544

Technical Support E-mail Address: tech@interexinc.com

Web Address: www.xlr8.com

Troubleshooting the MACH Speed Card

1. Please view the readme file on the software disk for the latest news on your new MACH Speed G3 card.
2. If your computer does not power up:
 - Make sure the motherboard L2 Cache DIMM has been removed (if possible)
 - a) Make sure the cables, video and/or other PCI cards are properly seated.
 - b) Check the MACH Speed G3 card to see if it is properly and fully seated.
 - c) Reset the motherboard button (CUDA) located under the CPU card. This ensures that the CPU will be recognized on the next boot.

- d) If your computer still does not power up, try removing and reinstalling the MACH Speed G3 card.
- e) ZAP the P-Ram (Control, Command, P and R) or see the computer installation manual for further information on zapping the P-Ram.

3. If your computer powers up, but freezes during Startup:

- a) Make sure the MACH Speed G3 is properly seated in the processor slot.
- b) Be sure your old motherboard L2 Cache Card has been removed and try re-booting. (Many of the original and third-party L2 Cache can not operate at your new accelerated speeds.)
NOTE: 9500/9600s have the cache soldered to the motherboard, these caches are compatible with the G3 upgrades.

c) If your computer still does not power up, try removing the new MACH Speed G3 card and reinstalling it.

d) Verify that the G3 settings are at the factory defaults.

4. If your system is unstable:

- a) If you are having a problem with random errors (system freeze, Type 1 and Type 11, communications problems with the floppy drive), the BUS speed may be set too high. Set CPU BUS Speed to 40 MHz using the dip switch settings from the Frequency Chart on page 6.
- b) Install the Power PC Interrupt Extension. (Obtain from Apple's web site, <http://www.info.apple.com> (required w/system 7.5.5 only). Upgrade system to OS 8.x.

5. If your software freezes:

The clock and BUS speeds are recorded by some software packages when installed. Subsequent changes in speed can cause the software to freeze. Reinstall any software that seems unstable after installing MACH Speed G3 card.

The OS should be installed with a "clean install".

Limited Warranty

XLR8 by Interex warrants this product to be free from any defects in materials or workmanship to the initial purchaser for two full years from the date of purchase. If such a defect is discovered within this warranty's limitations, the manufacturer agrees to repair or replace, at its sole discretion, this product free of charge, subject to the following conditions:

1. The manufacturer must be notified in writing within 10 days of discovery of defect.
2. The defective unit is returned to the manufacturer, freight prepaid, within 30 days of discovery of defect. Proof of purchase must accompany return.
3. Manufacturer shall determine damage to product is not due to misuse, negligence, improper installation, repair, alteration or accident caused by parties other than manufacturer.

This warranty is in lieu of all other warranties express or implied. In no event shall the manufacturer be liable for incidental or consequential damages including personal injury. This product is intended for use in only those computer models listed in the operating instructions or on the package.

DECLARATION OF CONFORMITY

according to ISO/IEC Guide 22 and 45014

We, the Manufacturer:

XLR8 by INTEREX, Inc.
8447 E. 35th St. N.
Wichita, KS USA 67226

Declare under our sole responsibility that the Product:

Name: Apple Macintosh CPU Board Upgrade

Model: MACH Speed G3

Part No: MACH/G220/5, MACH/G233/5, MACH/G266/1,
MACH/G275/1, MACH/G300/1, MACH/333/1, MACH/366/1,
MACH/400/1

Conforms to FCC 47 CFR 15.107 & 15.109 , CLASS B
Emissions, using: Safety: EMC: EN55022: 1994, A1: 1995 Class B
and EN 50082-1: 1997 Level 2

Other: Method of Continuing Conformance: ISO9001 (4.9) regis-
tered manufacturing facility with production sampling program.

Test Report: LM-12087A
Report Date: 09 December, 1997

XLR8 By INTEREX, Inc.
8447 E. 35th St. N.
Wichita, KS USA 67226

Phone (316) 636-5544
Fax (316) 636-4616



Free Manuals Download Website

<http://myh66.com>

<http://usermanuals.us>

<http://www.somanuals.com>

<http://www.4manuals.cc>

<http://www.manual-lib.com>

<http://www.404manual.com>

<http://www.luxmanual.com>

<http://aubethermostatmanual.com>

Golf course search by state

<http://golfingnear.com>

Email search by domain

<http://emailbydomain.com>

Auto manuals search

<http://auto.somanuals.com>

TV manuals search

<http://tv.somanuals.com>