

Vig390S Motherboard Manual

Viglen[®]

**Great
Minds
Think**

Viglen[®]

COMPUTERS ♦ NETWORKS ♦ SOLUTIONS

Viglen, EMC and the 'CE' mark

CE Marking

European standards are being harmonised across borders. If products comply with the same standards in all European countries, product exporting and importing is made simple - paving our way to a common market. If you buy a product with a 'CE' mark on it (shown below), on the box, in the manual, or on the guarantee - it complies with the currently enforced directive(s).



Introduction to EMC

EMC (Electromagnetic Compatibility) is the term used to describe certain issues with RF (Radio Frequency) energy. Electrical items should be designed so they do not interfere with each other through RF emissions. E.g. If you turn on your microwave, your television shouldn't display interference if both items are CE marked to the EMC directive.

If emitted RF energy is not kept low, it can interfere with other electrical circuitry - E.g. Cars Automatic Braking Systems have been known to activate by themselves while in a strong RF field. As this has obvious repercussions ALL electrical products likely to cause RF related problems have to be 'CE' marked from 1st January 1996 onwards.

If a product conforms to the EMC directive, not only should its RF emissions be very low, but its immunity to RF energy (and other types) should be high. The apparatus has to resist many 'real world' phenomena such as static shocks and mains voltage transients.

Viglen's Environment laboratory

To gain a 'CE' mark, the Viglen computer range has had to undergo many difficult tests to ensure it is Electromagnetically Compatible. These are carried out in the in-house 'Environment lab' at Viglen Headquarters. We have made every effort to guarantee that each computer leaving our factory complies fully with the correct standards. To ensure the computer system maintains compliance throughout its functional life, it is essential you follow these guidelines.

- > Install the system according to Viglen's instructions
- > If you open up your Viglen:

 - > Keep internal cabling in place as supplied.
 - > Ensure the lid is tightly secured afterwards
 - > Do not remove drive bay shields unless installing a 'CE' marked peripheral in its place
 - > The clips or 'bumps' around the lips of the case increase conductivity - do not remove or damage.
 - > Do not remove the ferrite ring from the L.E.D cables.
 - > Only use your Viglen computer with 'CE' marked peripherals

This system has been tested in accordance with European standards for use in residential and light industrial areas-this specifies a 10 meter testing radius for emissions and immunity. If you do experience any adverse affects which you think might be related to your computer, try moving it at least 10 meters away from the affected item. If you still experience problems, contact Viglen's Technical Support department who will put you straight through to an EMC engineer - s/he will do everything possible to help. If modifications are made to your Viglen computer system, it might breach EMC regulations. Viglen take no responsibility (with regards to EMC characteristics) of equipment which has been tampered with or modified.

Copyrights and Trademarks

Please note

The material in this manual is subject to change without notice.

Trademarks

Microsoft, Windows, Windows NT, Windows 95, Windows 98, Windows ME, Windows 2000 Pro, Windows XP Pro and MS-DOS are registered trademarks of Microsoft Corporation. IBM PC, XT, AT and PS/2 are trademarks of International Business Machines Corporation. Pentium and Pentium Pro are registered trademarks of Intel Corporation. AMI BIOS is a registered trademark of American Megatrends. All other trademarks are acknowledged. JAC-UP, Genie, Contender, Dossier, Vig, Viglen, and Envy are trademarks of Viglen Limited.

Copyright and Patents

This manual and all accompanying software and documentation are copyrighted and all rights reserved. This product, including software and documentation, may not, in whole or in part, be copied, photocopied, translated or reduced to any electronic or machine-readable form, without prior written consent except for copies retained by the purchaser for backup.

© Copyright 2005 Viglen Limited
All Rights Reserved
Vig390s Manual Version 1.0
Printed in the United Kingdom

Liability

No warranty or representation, either expressed or implied, is made with respect to this documentation, its quality, performance, merchantability or fitness for a particular purpose. As a result the documentation is licensed as is, and you, the licensee, are assuming the entire risk as to its quality and performance. The vendor reserves the right to revise this operation manual and all accompanying software and documentation and to make changes in the content without obligation to notify any person or organisation of the revision or change.

In no event will the vendor be liable for direct, indirect, special, incidental or consequential damages arising out of the use or inability to use this product or documentation, even if advised of the possibility of such damages. In particular, the vendor shall not have liability for any hardware, software or data stored or used with the product, including the costs of repairing, replacing or recovering such hardware, software or data.

Contents

Chapter 1 Overview	5
System Board Components	6
Back Panel Connectors	7
Feature Summary	9
System Processor	10
System Memory	11
Memory Configurations	12
Intel® E7525 chipset (Northbridge)	15
Intel® 6300ESB I/O Controller (Southbridge)	16
Vig390s motherboard block diagram	17
USB Support	18
IDE Support	18
Parallel ATA IDE Interfaces	19
Serial ATA Support	19
Real-Time Clock, CMOS SRAM and Battery	20
I/O Controller	20
Audio Subsystem	22
Audio Connectors	23
LAN Subsystem	24
Hardware Management Subsystem	25
Power Management	26
ACPI	26
Hardware Support	28
Chapter 2 System Board Options	31
Overview of Jumper Settings	33
System Board Jumper Settings	34
Motherboard Connectors	38
Front Panel Connectors	39
Upgrading the CPU	40
Installing & Removing Dual In-Line memory Modules	46
Replacing the Clock/CMOS RAM Battery	48
Chapter 3 Solving Problems	49
Resetting the System	49
Troubleshooting Procedures	50
Problems Operating Add-in Boards	51
Problems and Suggestions	52
Error and Information Messages	54
BIOS Beep Codes	55

Chapter 4 System BIOS	56
What is the BIOS?	56
The Power-on Sequence	56
AMI BIOS	57
Plug and Play: PCI Auto-configuration	58
PCI IDE Support	58
Desktop Management Interface (DMI)	59
Advanced Power Management (APM)	59
Advanced Configuration and Power Interface (ACPI)	61
Configuring the Motherboard using BIOS Setup	63
Setting the Processor Speed	63
Clearing the Passwords	63
BIOS Setup Program	64
Main Menu	67
Advanced Menu	75
Power Menu	88
Boot Menu	94
Exit Menu	101
Upgrading the BIOS	102
Chapter 5 Technical Information	105
Enhanced IDE	105
Operating Systems and Hard Drives	106
Connector Signal Details	107
Power Supply Connector	110
Motherboard Resources	113
Other Information	115
Chapter 6 Glossary	116
Notes	120
Chapter 7 Suggestions	121

Chapter 1: Overview

Introduction

This manual describes the Viglen Vig390s motherboard inside your computer. The motherboard is the most important part of your computer. It contains all of the CPU, memory and graphics circuitry that make the computer work.

The motherboard contains the very latest CPU design, the Intel Xeon™ processor, which includes Intel NetBurst® Microarchitecture with 800 MHz system bus, Internet Streaming SIMD Extensions 3, Intel Hyper-Threading Technology hardware support for multi-threaded applications and Intel's Extended Memory 64-bit technology (EM64T). All of which are designed to vastly improve both multimedia and communications on your PC. The combination of this technology and Viglen expertise make this a formidable computer.

This manual contains technical information about the Viglen VIG390S motherboard and other hardware components inside your computer. If you are new to computers we recommend that you read the user guide first. If you are an experienced computer user this manual should provide all the information you will need to perform simple upgrades and maintenance.

We hope that this manual is both readable and informative. If you have any comments for suggestions about how we could improve the format then please fill out the form at the back of the manual and send it to us.

Above all we hope that you enjoy using your Viglen computer.

System Board Components

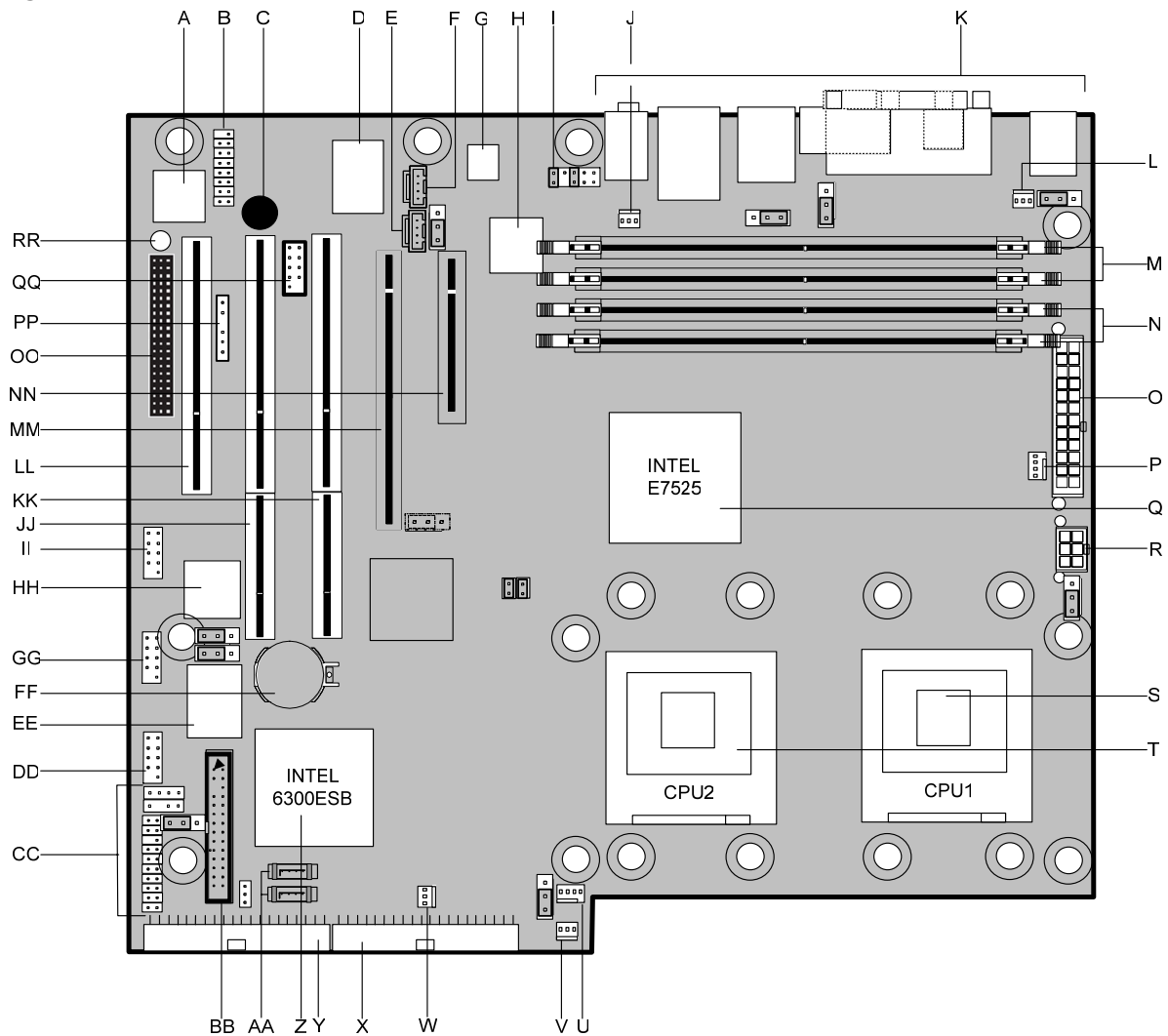


Figure 1: Motherboard Layout & Components

Table 1: Motherboard Layout Descriptions

A	8 Mbit Firmware Hub (FWH) BIOS	W	Front Chassis Fan 2
B	Game port header (optional)	X	Secondary IDE connector
C	Motherboard speaker	Y	Primary IDE connector
D	I/O controller	Z	Southbridge Intel® 6300ESB
E	Aux audio connector	AA	Serial ATA (S-ATA) connectors
F	CD audio connector	BB	Floppy drive connector
G	Audio codec AD1980	CC	Front panel audio connector
H	LAN controller Broadcom BCM5751	DD	Front panel USB connectors 5/6
I	Front panel audio connector	EE	USB controller (VIA VT6212L)
J	Rear Chassis Fan 2 connector	FF	Battery
K	Rear I/O back panel connections	GG	Front panel USB connectors 7/8
L	Rear Chassis Fan 1 connector	HH	IEE 1394a controller TiTBS43AB22A
M	Memory DIMM slots B2 A2	II	Front IEE1394a header connector
N	Memory DIMM slots B1 A1	JJ	PCI4 PCI-X connector (64bit)

O	SSI ATX Power connector 24 way	KK	PCI3 PCI-X connector (64bit)
P	CPU1 FAN connector	LL	PCI5 PCI connector (32bit 5V)
Q	Northbridge Intel © E7525	MM	PCI2 PCI-Express x 16 connector
R	ATX 12V1 connector 6 way	NN	PCI1 PCI-Express x 4 connector
S	CPU 1 socket (mPGA604 pin socket for Intel ® Xeon ™)	OO	WIFI proprietary connector (not supported)
T	CPU 2 socket (mPGA604 pin socket for Intel ® Xeon ™)	PP	SMBus connector
U	CPU 2 FAN connector	QQ	Second serial port header
V	Front Chassis Fan 1	RR	Power to motherboard LED

Note:

1. SATA 1 is to be used for Boot disk SATA 2 for data disk.
2. SATA RAID 0/1 is supported by Windows XP + SP1 and Windows 2000Pro + SP4.
3. Windows XP supports 2 CPU's with hyperthread enabled, if 2 CPU's are to be used with Windows 2000Pro hyperthread must be disabled.

Back Panel Connectors

The motherboard external IO connectors are attached to a metallic I/O shield. This shield serves several purposes:

- It protects the sensitive motherboard from any external EMC interference.
- It stops the computer from interfering with other electrical devices.
- It allows the motherboard to be easily upgraded in the future without having to resort to buying a whole new case. Simply change the I/O shield to match the motherboard.

The I/O shield provides external access to PS/2 keyboard and mouse connectors as well as one serial port, one parallel port, two USB ports, one LAN Port and the audio connectors.

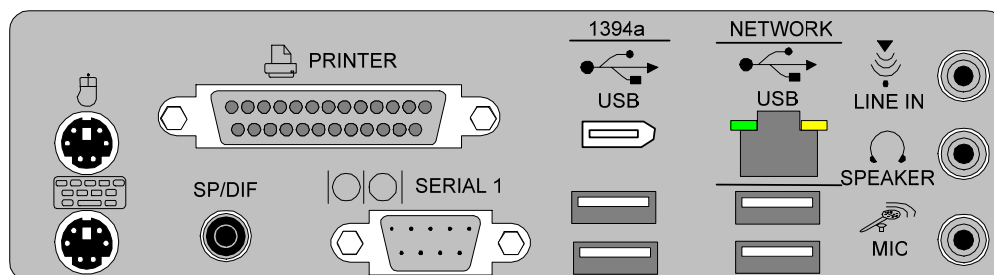


Figure 2: I/O shield

Note: Power to the computer should be turned off before a keyboard or mouse is connected or disconnected.

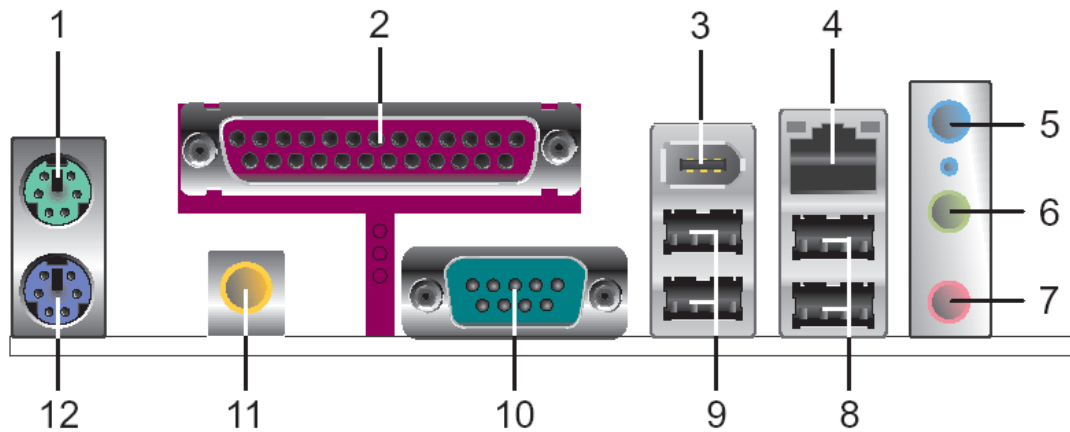


Figure 3: Back Panel Connectors

Table 2: Back Panel Connectors.

Item	Description	Item	Description
1	PS/2* mouse port (Green)	7	Mic in (Pink)
2	Parallel port (Burgundy)	8	USB ports (two) 3 and 4
3	IEE1394a	9	USB ports (two) 1 and 2
4	LAN RJ45	10	Serial port A (Teal)
5	Audio line In (Blue)	11	SP/DIF 5.1 audio out
6	Line Out (Lime green) L and R audio	12	PS/2 keyboard port (Purple)

Note: The back panel audio out connectors are designed to power headphones or amplified speakers only. Poor audio quality occurs if passive (non-amplified) speakers are connected to these outputs.

Audio 2/4/6 Channel configurations

The audio ports may be re configured via the audio control panel, default operation is 2 channel audio.

Table 3: Audio 2/4/6 Channel configurations

Port	2 channel	4 channel	6 channel
Audio line In (Blue)	Line In	Line In	Bass/Centre
Line Out (Lime green)	Line out	Front Speaker Out L & R	Front Speaker Out L & R
Mic in (Pink)	Mic In	Rear Speaker Out L & R	Rear Speaker Out L & R

Feature Summary

The VIG390S motherboard supports Intel Pentium Xeon™ processors with 1MB of third-level cache integrated in a micro PGA 604 Socket package operating at speeds up to 3.6GHz. Single or dual processors are supported but should be identical in speed and CPU stepping revision.

Table 4: Feature Summary

Form Factor	VIG390S: extended ATX (9.8 inches by 12.0 inches [250.00 millimetres by 305.00 millimetres])								
Processor	<ul style="list-style-type: none"> - Single or dual Pentium Xeon CPU - 800MHz FSB - Integrated 512MB second and 1MB third level cache - Socket micro PGA 604 connector <small>604-pin FC-µPGA4</small> 								
Supported CPU speeds	<table style="width: 100%; border-collapse: collapse;"> <thead> <tr> <th style="text-align: left;">CPU Speed</th> <th style="text-align: left;">FSB</th> <th style="text-align: left;">L2 Cache</th> <th style="text-align: left;">L3 Cache</th> </tr> </thead> <tbody> <tr> <td>3.2. to 3.6GHz</td> <td>800MHz</td> <td>512K</td> <td>1M</td> </tr> </tbody> </table>	CPU Speed	FSB	L2 Cache	L3 Cache	3.2. to 3.6GHz	800MHz	512K	1M
CPU Speed	FSB	L2 Cache	L3 Cache						
3.2. to 3.6GHz	800MHz	512K	1M						
Memory	<ul style="list-style-type: none"> - Four 204-pin DDR2 SDRAM Dual Inline DIMM sockets. - Support for up to 8GB of DDR2 400 ECC 72bit 								
Chipset	<ul style="list-style-type: none"> - Northbridge Intel® 7525 Memory Controller Hub (GMCH) - Southbridge Intel® 6300ESB I/O Controller Hub (ICH5) - 8 Mbit Firmware Hub (FWH) 								
Video	- PCI-Express connector supporting x1 ,x4, x8 and x16 lane VGA cards								
Audio	- Audio subsystem using the ADI AD1980 6 channel audio codec.								
I/O Controller	- Southbridge Intel® 6300ESB I/O Controller Hub (ICH5)								
USB	- Support for USB 2.0 devices								
Peripheral Interfaces	<ul style="list-style-type: none"> - Eight USB Ports - One Serial Port - One Parallel Port - Two Serial ATA IDE interfaces - Two Parallel ATA IDE interfaces with UDMA 33, ATA-66/100 support - One diskette drive interface - PS/2 keyboard port - PS/2 mouse port - One IEEE1394a Port 								
LAN Support	Gigabit (10/100/1000 Mbps/sec) LAN subsystem using the Broadcom BMC5751 PCI Express Gigabit LAN Controller PCI-E 1.0a interface								
BIOS	<ul style="list-style-type: none"> - AMI BIOS (resident in the 8 Mbit FWH) - Support for Advanced Configuration and Power Interface (ACPI), Plug and Play SMBIOS 2.3, WfM2.0,DMA2.0a. 								
Instantly Available PC Technology	<ul style="list-style-type: none"> - Support for PCI Local Bus Specification Revision 2.2 - Suspended to RAM support - Wake on PCI, RS-232, front panel, PS/2 devices and USB ports 								
Expansion Capabilities	<ul style="list-style-type: none"> - One PCI (32bit 5v) bus add-in card connectors - Two PCI-X (64bit) bus add-in card connector - One PCI-Express (x16 lane) add-in card connector - One PCI-Express (x4 lane) add-in card connector 								
Hardware Monitor Subsystem	<ul style="list-style-type: none"> - Hardware monitoring and fan control ASIC - Voltage sense to detect out of range power supply voltages - Thermal sense to detect out of range thermal values - Four chassis fan connectors with activity monitor(two rear and two front) - 2 x CPU Heatsink FAN speed activity monitor - Thermal Fan speed control 								

System Processor

The VIG390S motherboard supports a single or dual Pentium Xeon™ processor. The processor's VID pins automatically program the voltage regulator on the motherboard to the required processor voltage. In addition, the front side bus speed is automatically selected. The motherboard currently supports processors that run internally up to 3.6GHz and have a 512 KB second-level cache and 1MB third-level cache.

The Intel Xeon™ processor incorporates Intel NetBurst® Microarchitecture with 800 MHz system bus, Internet Streaming SIMD Extensions 3, Intel Hyper-Threading Technology hardware support for multi-threaded applications and Intel's Extended Memory 64-bit technology (EM64T).

The processor also implements MMX™ technology and maintains full backward compatibility with the 8086, 80286, Intel386™, Intel486™, Pentium, Pentium Pro, Pentium II & Pentium III processors. The processor's numeric coprocessor significantly increases the speed of floating-point operations and complies with ANSI/IEEE standard 754-1985.

Microprocessor Packaging

The Xeon™ processor comes in a micro PGA 604 package that connects to the motherboard through a socket 604 connector. The package consists of:

- Processor card including the processor core and the second-level and third level cache, burst pipelined synchronous static RAM (BSRAM) and tag RAM.
- Thermal plate.

Second Level Cache

The second-level cache is located on the die of the CPU itself. The cache includes burst pipelined synchronous static RAM (BSRAM) and tag RAM. All supported onboard memory can be cached.

Processor Upgrades

The motherboard can be upgraded with an Intel Xeon™ processor that runs at higher speeds with a maximum of 3.6GHz.

System Memory

Main Memory

The motherboard has four DDR2 SDRAM Dual Inline Memory Module (DIMM) sockets. Support for up to a maximum memory size of 8GB. The BIOS automatically detects memory type, size, and speed.

The motherboard supports the following memory features:

- 240 pin DDR2 400 MHz SDRAM DIMMs with gold-plated contacts
- Unbuffered, single-sided or double-sided DIMMs with the following restriction: Double-sided DIMMS with x16 organisation are not supported.
- 8 GB maximum total system memory total amount of addressable memory.
- Minimum total system memory: 256 MB
- 72bit registered ECC DIMMs
- Serial Presence Detect

Notes:

To be fully compliant with all applicable DDR2 SDRAM memory specifications, the board should be populated with DIMMs that support the Serial Presence Detect (SPD) data structure. This allows the BIOS to read the SPD data and program the chipset to accurately configure memory settings for optimum performance. If non-SPD memory is installed, the BIOS will attempt to correctly configure the memory settings, but performance and reliability may be impacted or the DIMMs may not function under the determined frequency.

Table 5: Supported Memory Configurations

DIMM Capacity	Configuration	SDRAM Density	SDRAM Organisation Front-side/Back-side	Number of SDRAM Devices
256 MB	SS	256 Mbit	32 M x 8/empty	8
256 MB	SS	512 Mbit	32 M x 16/empty	4
512 MB	DS	256 Mbit	32 M x 8/32 M x 8	16
512 MB	SS	512 Mbit	64 M x 8/empty	8
512 MB	SS	1 Gbit	64 M x 16/empty	4
1024 MB	DS	512 Mbit	64 M x 8/64 M x 8	16
1024 MB	SS	1 Gbit	128 M x 8/empty	8
2048 MB	DS	1 Gbit	128 M x 8/128 M x 8	16

Note: In the second column, "DS" refers to double-sided memory modules (containing two rows of DDR SDRAM) and "SS" refers to single-sided memory modules (containing one row of DDR SDRAM).

Memory Configurations

The Vig390s with Intel E7525 MCH supports Dual channel (Interleaved) mode memory organisation:

Dual channel (Interleaved) mode: This mode offers the highest throughput for real world applications. Dual channel mode is enabled when the installed memory capacities of both DIMM channels are equal. Technology and device width can vary from one channel to the other but the installed memory capacity for each channel must be equal. If different speed DIMMs are used between channels, the slowest memory timing will be used.

Single channel (Asymmetric) mode: This mode is equivalent to single channel bandwidth operation for real world applications. This mode is used when only a single DIMM is installed or the memory capacities are unequal. Technology and device width can vary from one channel to the other. If different speed DIMMs are used between channels, the slowest memory timing will be used.

NOTE:

The DIMM A2 and B2 sockets of both channels are blue. The DIMM A1 and B1 sockets of both channels are black.

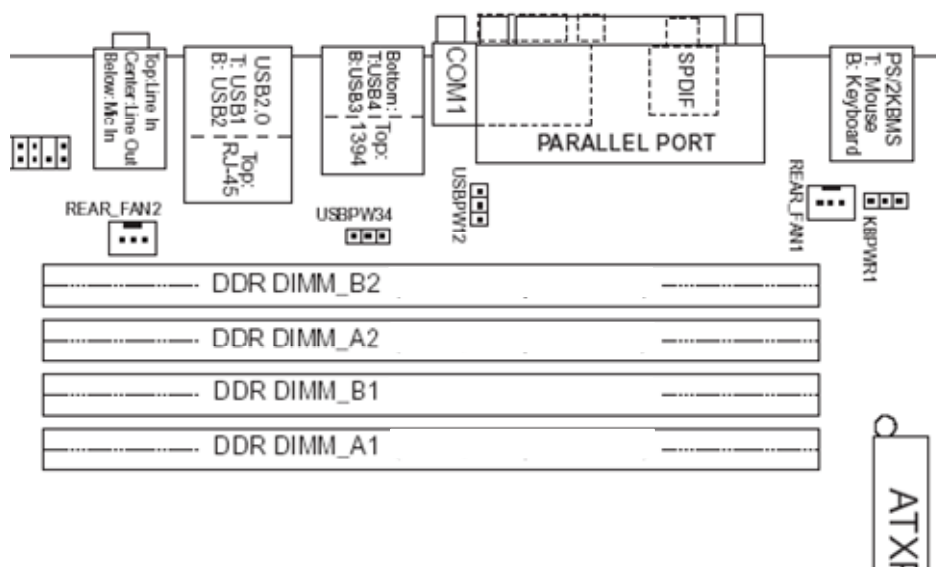


Figure 4: Memory Channel and DIMM Configuration

Dual channel mode: Installed modules must be the same therefore for 1GB total system memory two 512MB modules would be installed in sockets A1 and B1.

Dual Channel (Interleaved) Mode Configurations

Figure 5 shows a dual channel configuration using two DIMMs. In this example, the DIMM A1, B1 (black) sockets of both channels are populated with identical DIMMs.

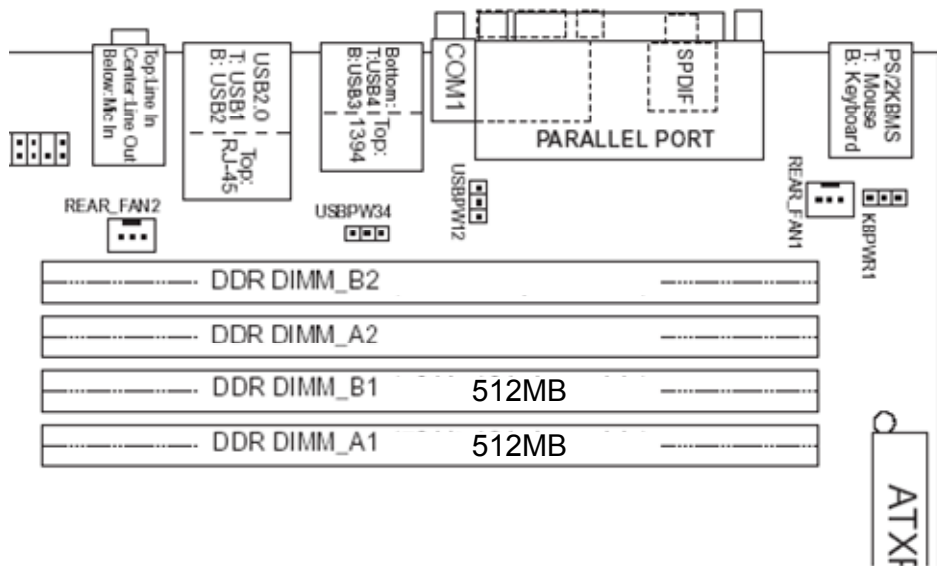


Figure 5: Dual Channel (Interleaved) Mode Configuration with Two DIMMs

Figure 6 shows a dual channel configuration using four DIMMs. In this example, the combined capacity of the two DIMMs in Channel A equal the combined capacity of the two DIMMs in Channel B. Also, the DIMMs are matched between DIMM1 and DIMM2 of both channels.

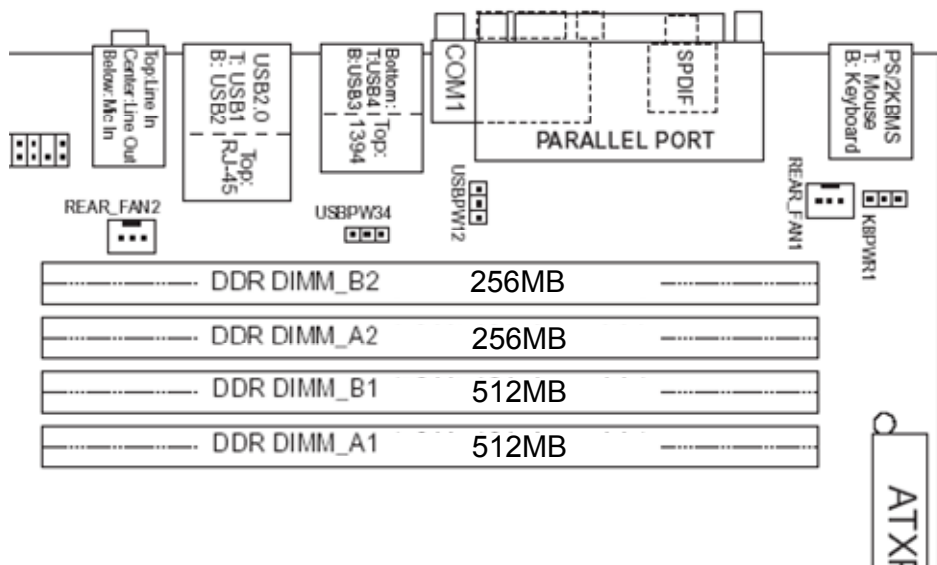


Figure 6: Dual Channel (Interleaved) Mode Configuration with Four DIMMs

Single Channel (Asymmetric) Mode Configurations (Illustration only)

Note:

Dual channel (Interleaved) mode configurations provide the highest memory throughput. Figure 7 shows a single channel configuration using one DIMM. In this example, only the DIMM1 (black) socket of Channel A is populated. Channel B is not populated.

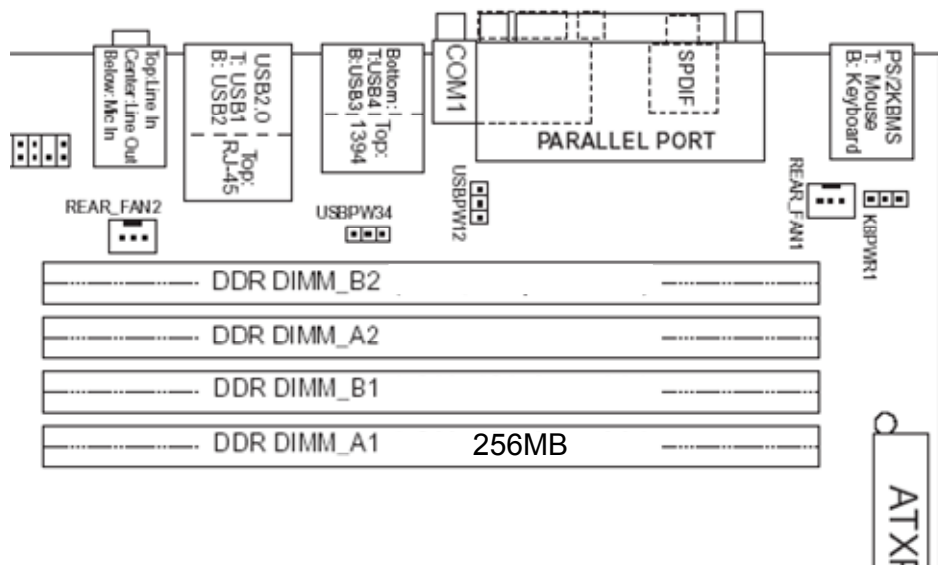


Figure 7: Single Channel (Asymmetric) Mode Configuration with One DIMM

Intel® E7525 chipset (Northbridge)

Intel® E7525 Memory Controller Hub (MCH) chipset, the next generation Intel® dual-processor (DP) workstation and server chipset technology, offers increased graphics performance, reduced power consumption, and improved platform reliability and system manageability.

The Intel® E7525 Chipset MCH is the central hub for all data passing between the core system elements: processors, memory, PCI Express x16 graphics, PCI Express I/O and legacy I/O subsystems. It supports dual Intel Xeon processors with 1MB L2 cache over the 800 MHz system bus interface, delivering bandwidth up to 6.4 GB/second. The MCH also supports all of the Intel Xeon processor features, such as Hyper Threading technology, Enhanced Intel SpeedStep Technology, Intel EM64T and Streaming SIMD Extensions 3 (SSE3) Instructions.

The PCI Express x16 interface supports a total bandwidth of 8 GB/second (4 GB/second per direction) and directly attaches the MCH to a variety of third-party graphics adapters. A variety of Intel and third-party I/O solutions communicate directly with the MCH through the PCI Express x8 interface. The Intel E7525 MCH has one PCI Express x8 interface that can be bifurcated into two x4 interfaces for additional configuration flexibility. The bandwidth of the PCI Express x8 is up to 4 GB/second.

The legacy I/O connects to the MCH through the Intel Hub Interface architecture at 256 MB/second. There are two I/O controller hub options: the Intel 82801ER I/O Controller Hub (ICH5R) and the Intel 6300ESB I/O Controller Hub.

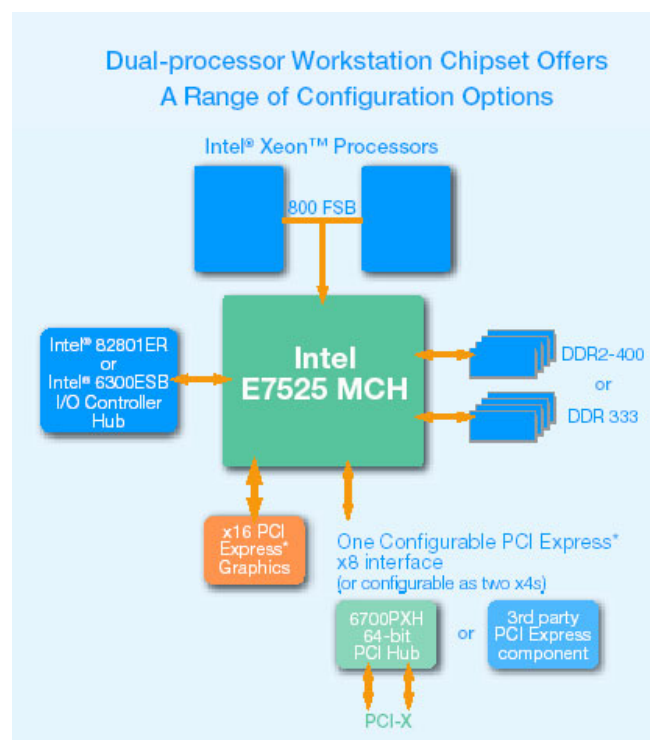


Figure 8: E7525 Block Diagram

The Intel® 6300ESB I/O Controller (Southbridge)

The Intel® 6300ESB I/O Controller Hub integrates dual independent Serial ATA controllers, each capable of up to 150 MB/second transfer rate, for the most demanding storage data transfers and support for optional third party software RAID 0, 1 technology. Four Hi-Speed USB 2.0 ports allow easy I/O connection, while offering improved bandwidth compared to USB 1.1 devices. The Intel 6300ESB I/O Controller Hub also includes one PCI-X 64/66 bus supporting up to 4 PCI-X 64/66 MHz interfaces.

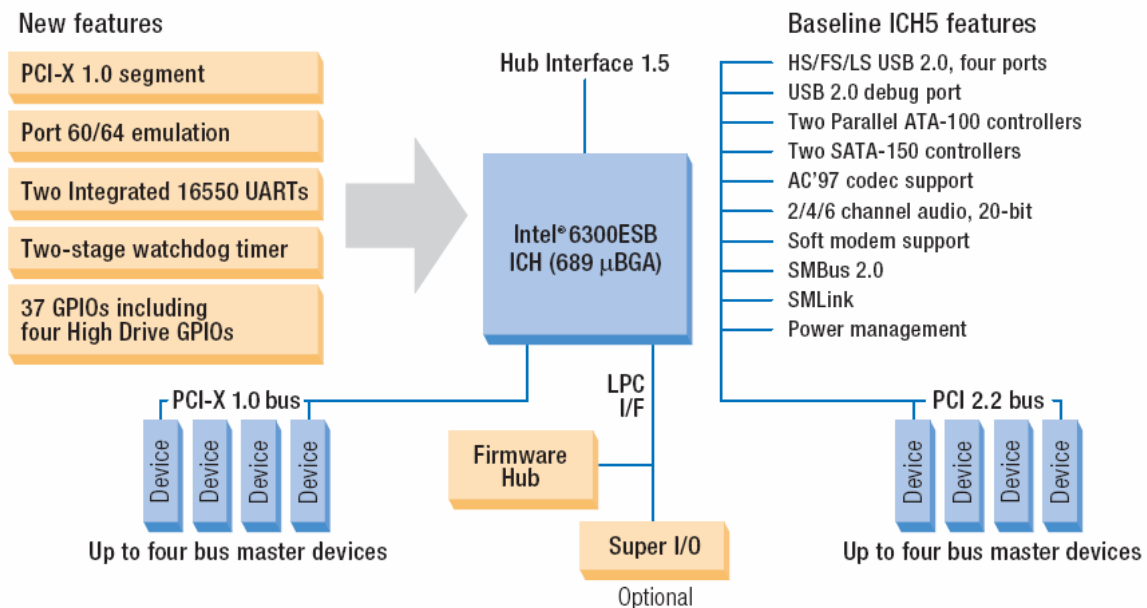


Figure 9: 6300 Block Diagram

Vig390s motherboard block diagram

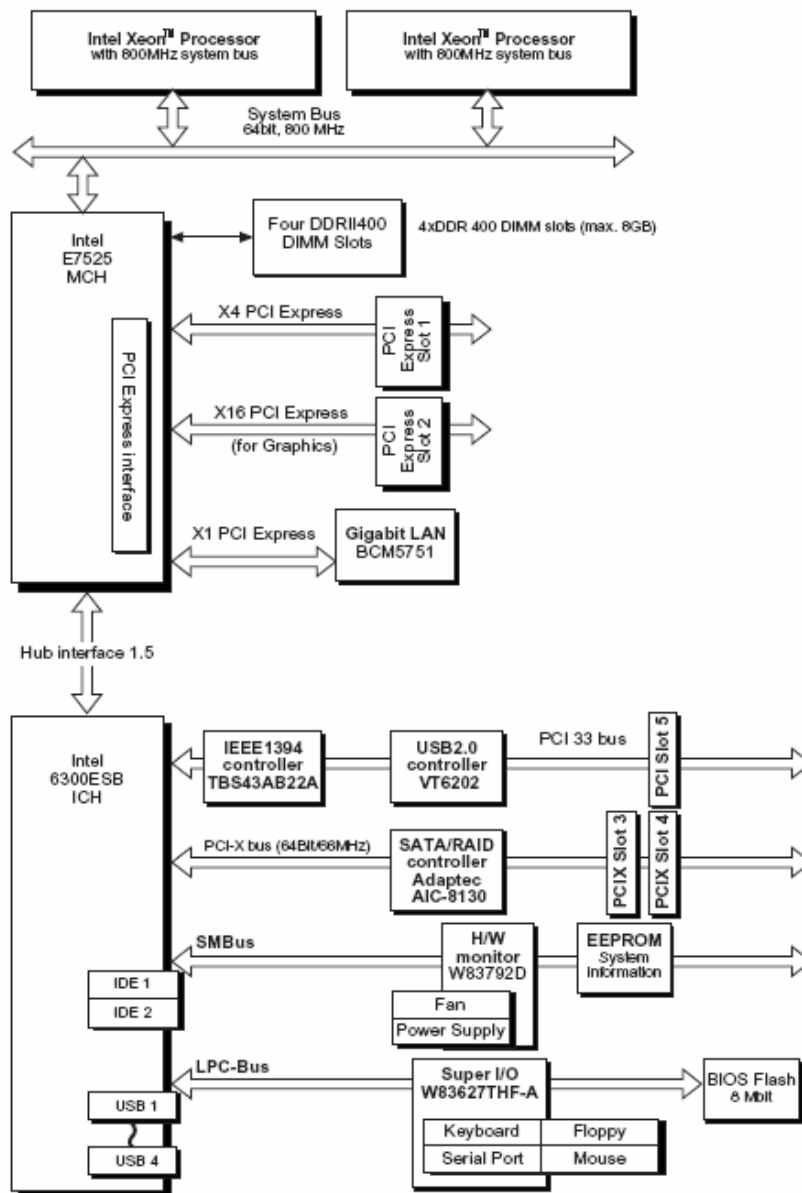


Figure 10: Vig390s Block Diagram

The Vig390s motherboard integrates both the Intel E7525 MCH and Intel 6300ESB I/O controller with the following additional components:

- Gigabit LAN BCM5751
- IEEE1394a controller TBS43AB22A
- USB 2.0 controller VT6202
- H/W monitor W83792B
- Super I/O controller W83627THF-A

Note: The Adaptec S-ATA RAID controller AIC-8130 is an option not incorporated into the Vig390s.

USB Support

The motherboard has four rear USB 2.0 ports; note optional front panel USB adaptor connector is required to use the internal USB headers to provide up to 4 more additional ports. One USB peripheral can be connected to each port. For more than four USB devices, an external hub can be connected to either port. The motherboard fully supports the universal host controller interface (UHCI) and (EHCI) and uses UHCI-and EHCI- compatible drivers. The ICH5 provides the USB controller for all ports.

The port arrangement is as follows:

- Two ports are implemented with stacked back panel connectors, adjacent to the PS/2 connectors
- Two ports are implemented with stacked back panel connectors, adjacent to the audio connectors
- Four ports are routed to two separate front panel USB connectors

Note: *USB 2.0 drivers are available for Windows 2000 Pro and Windows XP, and currently not supported by any other operating system.*

USB features include:

- Self-identifying peripherals that can be plugged in while the computer is running.
- Automatic mapping of function to driver and configuration.
- Supports isochronous and asynchronous transfer types over the same set of wires.
- Supports up to **127** physical devices.
- Guaranteed bandwidth and low latencies appropriate for telephony, audio, and other applications.
- Error-handling and fault-recovery mechanisms built into the protocol.

Note: *Computer systems that have an unshielded cable attached to a USB port may not meet FCC Class B requirements, even if no device or a low-speed (sub-channel) USB device is attached to the cable. Use shielded cable that meets the requirements for high-speed (fully rated) devices.*

IDE Support

The VIG390S motherboard provides four IDE interface connectors:

- Two Parallel ATA (P-ATA) IDE connectors, which support a total of four devices (two per connector)
- Two Serial ATA (S-ATA) IDE connectors, which support one device per connector

Parallel ATA IDE Interfaces

The ICH5's Parallel ATA IDE controller has two independent bus-mastering Parallel ATA IDE interfaces that can be independently enabled. The Parallel ATA IDE interfaces support the following modes:

- Programmed I/O (PIO): processor controls data transfer.
- 8237-style DMA: DMA offloads the processor, supporting transfer rates of up to 16 MB/sec.
- Ultra DMA: DMA protocol on IDE bus supporting host and target throttling and transfer rates of up to 33 MB/sec.
- ATA-66: DMA protocol on IDE bus supporting host and target throttling and transfer rates of up to 66 MB/sec. ATA-66 protocol is similar to Ultra DMA and is device driver compatible.
- ATA-100: DMA protocol on IDE bus allows host and target throttling. The ICH5's ATA-100 logic can achieve read transfer rates up to 100 MB/sec and write transfer rates up to 88 MB/sec.

Serial ATA Support

The ICH5's Serial ATA controller offers two independent Serial ATA ports with a theoretical maximum transfer rate of 150 MB/s per port. One device can be installed on each port for a maximum of two Serial ATA devices. A point-to-point interface is used for host to device connections, unlike Parallel ATA IDE which supports a master/slave configuration and two devices per channel.

For compatibility, the underlying Serial ATA functionality is transparent to the operating system. The Serial ATA controller can operate in both legacy and native modes. In legacy mode, standard IDE I/O and IRQ resources are assigned (IRQ 14 and 15). In Native mode, standard PCI resource steering is used. Native mode is the preferred mode for configurations using the Windows XP and Windows 2000 operating systems.

LS-120 Support

LS-120 MB Diskette technology enables you to store 120MB of data on a single, 3.5" removable diskette. LS-120 technology is backward (both read and write) compatible with 1.44MB and 720KB DOS-formatted diskette and is supported by Windows 95 and Windows NT operating system.

The VIG390S board allows connection of an LS-120 compatible drive and a standard 3½" floppy drive. The LS-120 drive can be configured as a boot device before a floppy drive, if selected in the BIOS setup utility.

Note: *If you connect an LS-120 drive to an IDE connector and configure it as the "A" drive and configure a standard 3.5" floppy as "B" drive, the standard floppy must be connected to the floppy drive cable's "A" connector (the connector at the end of the cable).*

The BIOS setup utility can be configured to boot firstly from either the LS120 or standard 3½" floppy drive.

Real-Time Clock, CMOS SRAM and Battery

A coin-cell battery (CR2032) powers the real-time clock and CMOS memory. When the computer is not plugged into a wall socket, the battery has an estimated life of three years. When the computer is plugged in, the standby current from the power supply extends the life of the battery. The clock is accurate to ± 13 minutes/year at 25 °C with 3.3 VSB applied.

Note: *If the battery and AC power fail, custom defaults, if previously saved, will be loaded into CMOS RAM at power-on.*

I/O Controller

The I/O controller (Intel® 6300ESB I-O Controller Hub) provides the following features:

- One serial port (optional second serial port).
- One parallel port with Extended Capabilities Port (ECP) and Enhanced Parallel Port (EPP) support
- Serial IRQ interface compatible with serialised IRQ support for PCI systems PS/2-style mouse and keyboard interfaces
- Interface for one 1.44 MB diskette drive
- PCI-X 64/66 ports
- PCI 32/33 ports
- Two P-ATA ports
- Two S-ATA ports with configurable Intel RAID 0 and 1 support
- Intelligent power management, including a programmable wake-up event interface
- SMBus hardware management support
- Integrated USB hub

By default, the I/O controller interfaces are automatically configured during boot up. The I/O controller can also be manually configured in the Setup program.

Serial Ports

One 9-pin D-Sub serial port connector is located on the back panel and is compatible with NS16C550 UARTs.

Parallel Port

The connector for the multimode bi-directional parallel port is a 25-pin D-Sub connector located on the back panel. In the Setup program, the parallel port can be configured for the following:

- Compatible (standard mode).
- Bi-directional (PS/2 compatible).
- Extended Parallel Port (EPP).
- Enhanced Capabilities Port (ECP).

Floppy Controller

The I/O controller is software compatible with the N82077 floppy drive controllers and supports both PC-AT and PS/2 modes. In the Setup program, the floppy interface can be configured for the following floppy drive capacities and sizes:

- 360 KB, 5.25-inch
- 1.2 MB, 5.25-inch
- 720 KB, 3.5-inch
- 1.2 MB, 3.5-inch (driver required)
- 1.25/1.44 MB, 3.5-inch (default configuration)
- 2.88 MB, 3.5-inch

PS/2 Keyboard and Mouse Interface

PS/2 keyboard and mouse connectors are located on the back panel. The +5 V lines to these connectors are protected with a PolySwitch circuit that, like a self-healing fuse, re-establishes the connection after an over-current condition is removed.

The keyboard controller contains the AMI MegaKey keyboard and mouse controller code, provides the keyboard and mouse control functions, and supports password protection for power on/reset. A power on/reset password can be specified in Setup. The keyboard controller also supports the hot-key sequence <Ctrl><Alt> for a software reset. This key sequence resets the computer's software by jumping to the beginning of the BIOS code and running the Power-On Self Test (POST).

Audio Subsystem

The VIG390S motherboard provides a Flex 6 audio subsystem based on the High Definition Audio subsystem using the ADI AD1980 6 channel audio codec.

The audio subsystem supports the following features:

- Advanced jack sense with Auto Topology Switching that enables the audio codec to recognise what device is connected to an audio port and alerts the user if the wrong type of device has been connected.
- Split digital/analog architecture for improved S/N (signal-to-noise) ratio: > 94 dB

The Flex 6 audio subsystem includes the following features:

- Intel 82801EB I/O Controller Hub (ICH5)
- Analog Devices AD1980 audio codec
- Microphone input that supports a single dynamic, condenser, or electrets microphone

The subsystem has the following connectors:

- ATAPI-style CDROM connector
- Front panel audio connector, including pins for:
 - Line In
 - Mic in

Audio 2/4/6 Channel configurations

The audio ports may be re configured via the audio control panel, default operation is 2 channel audio.

Table 6: Audio 2/4/6 Channel configurations

Port	2 channel	4 channel	6 channel
Audio line In (Light Blue)	Line In	Line In	Bass/Centre
Line Out (Lime green)	Line out	Front Speaker Out L & R	Front Speaker Out L & R
Mic in (Pink)	Mic In	Rear Speaker Out L & R	Rear Speaker Out L & R

- Back panel audio connectors that are configurable through the audio devices drivers. The available configurations are shown below:

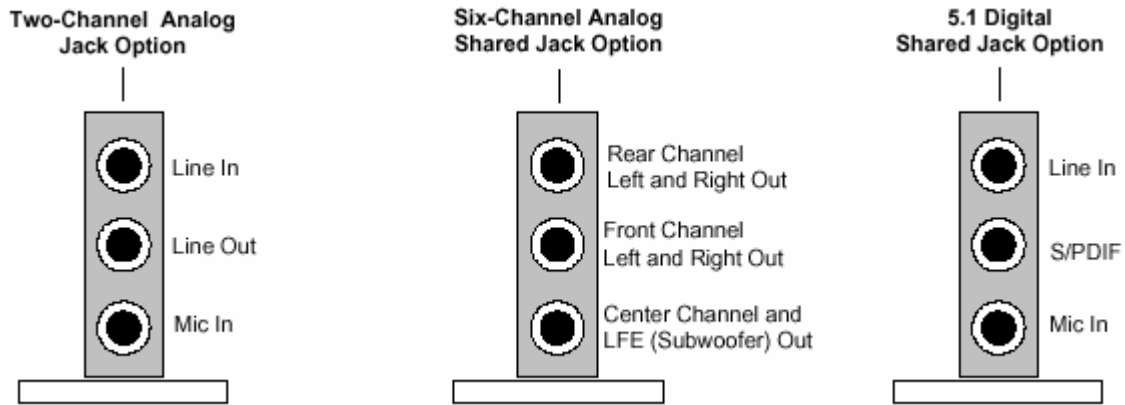


Figure 11: Back Panel Audio Connector Options

Note: To access the S/PDIF signal with the 5.1 Digital Shared Jack option, connect a 1/8-inch stereo phone plug to RCA jack adapter/splitter as shown in Figure 12.

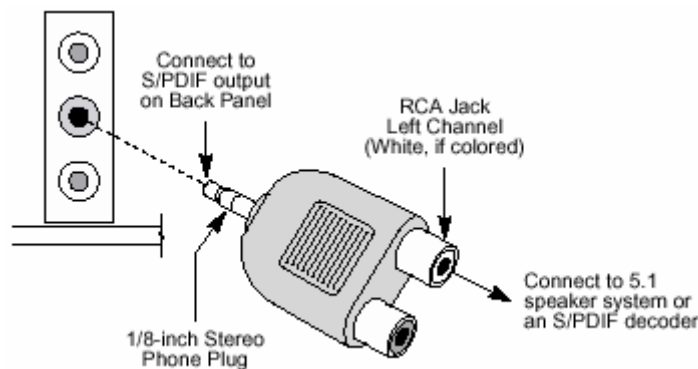


Figure 12: Adapter for S/PDIF Back Panel Connector

Audio Connectors

Front Panel Audio connector

A 2 x 5-pin connector provides mic in and line out signals for front panel audio connectors.

Auxiliary Line In Connector

A 1 x 4-pin ATAPI-style connector connects the left and right channel signals of an internal audio device to the audio subsystem.

ATAPI CDROM Audio Connector

A 1 x 4-pin ATAPI-style connector connects an internal ATAPI CD-ROM drive to the audio mixer.

LAN Subsystem

The Network Interface Controller subsystem consists of the Broadcom NetXtreme™ BMC5751 PCI Express Gigabit LAN controller Supporting PCI Express 1.0a interface.

Features

- 10/100/100BASE-T Gigabit Ethernet
- PCI-Express bus interface
- IEEE802.3 compliant media access controller (MAC)
- TCP,IP, and UDP checksum
- Microsoft® large Send Offload
- Large burst read
- Interrupt coalescing
- Standard-compliant WOL
- SMBUS 2.0 controller
- Alert Standard Format (ASF) 2.0 support
- Supports RJ-45 connector with status indicator LEDs
- Full driver compatibility
- Advanced Power Management support
- Configuration EEPROM that contains the MAC address

RJ-45 LAN Connector LEDs

Two LEDs are built into the RJ-45 LAN connector. The following table describes the LED states when the board is powered up and the LAN subsystem is operating.

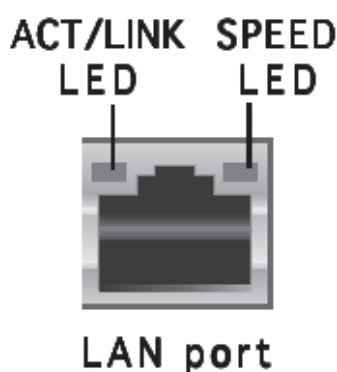


Figure 13: LAN Connector

Table 7: LAN Connector LEDs

ACT/LINK LED		SPEED LED	
OFF	No link	Off	10Mbps
Green	Linked	Orange	100Mbps
Blinking	Data activity	Green	1 Gbps

Hardware Management Subsystem

The hardware management features enable the Desktop Boards to be compatible with the Wired for Management (WfM) specification. The Desktop Board has several hardware management features, including the following:

- Fan monitoring and control (through the hardware monitoring and fan control ASIC)
- Thermal and voltage monitoring
- Chassis intrusion detection

Hardware Monitoring and Fan Control ASIC

The features of the hardware monitoring and fan control ASIC include:

- Internal ambient temperature sensor
- Two remote thermal diode sensors for direct monitoring of processor temperature and ambient temperature sensing
- Power supply monitoring of voltages (+5 V, +12 V, +3.3 V, Vbat 3.3, Vcore1 and Vcore2) to detect levels above or below acceptable values
- Thermally monitored closed-loop fan control, for all fans, that can adjust the fan speed as needed.
- SMBus interface

Thermal Monitoring

Table 8: Hardware Monitor Options

Item	Description
A	Thermal diode, located on processor die
B	Remote ambient temperature sensor
C	MB ambient temperature sensor
D	Processor fan speed
E	Rear chassis fan speed
F	Front chassis fan speed

Power Management

Power management is implemented at several levels, including:

- Software support through Advanced Configuration and Power Interface (ACPI)
- Hardware support:
 - Power connector
 - Fan connectors
 - LAN wake capabilities
 - Instantly Available PC technology
 - Resume on Ring
 - Wake from USB
 - Wake from PS/2 devices
 - Power Management Event signal (PME#) wake-up support

ACPI

ACPI gives the operating system direct control over the power management and Plug and Play functions of a computer. The use of ACPI with the VIG390S motherboard requires an operating system that provides full ACPI support. ACPI features include:

- Plug and Play (including bus and device enumeration)
- Power management control of individual devices, add-in boards (some add-in boards may require an ACPI-aware driver), video displays, and hard disk drives
- Methods for achieving less than 15-watt system operation in the power-on/standby sleeping state
- A Soft-off feature that enables the operating system to power-off the computer
- Support for multiple wake-up events
- Support for a front panel power and sleep mode switch

Table 9 lists the system states based on how long the power switch is pressed, depending on how ACPI is configured with an ACPI-aware operating system.

Table 9: Effects of Pressing the Power Switch

If the system is in this state...	...and the power switch is pressed for	...the system enters this state
Off (ACPI G2/G5 – soft off)	Less that four seconds	Power-on (ACPI G0 – working)
On (ACPI G0 – working state)	Less than four seconds	Soft off/Standby (ACPI G1 – sleeping state)
On (ACPI G0 – working state)	More than four seconds	Fail safe power-off (ACPI G2/G5 – soft-off)
Sleep (ACPI G1 – sleeping state)	Less that four seconds	Wake-up (ACPI G0 – working state)
Sleep (ACPI G1 – sleeping state)	More than fore seconds	Power-off (ACPI G2/G5 – Soft off)

System States and Power States

Under ACPI, the operating system directs all system and device power state transitions. The operating system puts devices in and out of low-power states based on user preferences and knowledge of how devices are being used by applications. Devices that are not being used can be turned off. The operating system uses information from applications and user settings to put the system as a whole into a low-power state.

Table 10 lists the power states supported by the VIG390S motherboard along with the associated system power targets. See the ACPI specification for a complete description of the various system and power states.

Table 10: Power States and Targeted System Power

Global States	Sleeping States	Processor States	Device States	Targeted System Power
G0 – working state	S0 – working	C0 – working	D0 – working state	Full Power > 30W
G1 – sleeping state	S1 – Processor stopped	C1 – stop grant	D1, D2, D3 – device specification specific	5W < power < 52.5W
G1 – sleeping state	S3 – Suspend to RAM.	No power	D3 – no power except for wake-up logic	Power < 5W
G1 – Sleeping state	S4 – Suspended to disk.	No power	D3 – no power except for wake-up logic	Power < 5W
G2/S5	S5 – Soft off. saved	No power	D3 – no power except for wake-up logic	Power < 5W
G3 – Mechanical off AC power is disconnected for the computer	No power to the system	No power	D3 – no power for wake-up logic, except when provided by battery or external source	No power to the system. Service can be performed safely.

Wake-up Devices and Events

Table 11 lists the devices or specific events that can wake the computer from specific states.

Table 11: Wake-up Devices and Events

These devices/events can wake up the computer...	...from this state
LAN	S1, S3, S4, S5
Modem (Back panel Serial Port A)	S1, S3
PME# signal	S1, S3, S4, S5
Power switch	S1, S3, S4, S5
PS/2 devices	S1, S3
RTC alarm	S1, S3, S4, S5
USB	S1, S3

Note: The use of these wake-up events from an ACPI state requires an operating system that provides full ACPI support. In addition, software, drivers, and peripherals must fully support ACPI wake events.

Hardware Support

CAUTION!

Ensure that the power supply provides adequate +5 V standby current if LAN wake capabilities and Instantly Available PC technology features are used. Failure to do so can damage the power supply. The total amount of standby current required depends on the wake devices supported and manufacturing options.

The VIG390S motherboard provides several power management hardware features, including:

- Power connector
- Fan connectors
- LAN wake capabilities
- Instantly Available PC technology
- Resume on Ring
- Wake from USB
- Wake from PS/2 keyboard
- PME# signal wake-up support

LAN wake capabilities and Instantly Available PC technology require power from the +5 V standby line. The sections discussing these features describe the incremental standby power requirements for each.

Resume on Ring enables telephony devices to access the computer when it is in a power-managed state. The method used depends on the type of telephony device (external or internal).

Note: *The use of Resume on Ring and Wake from USB technologies from an ACPI state requires an operating system that provides full ACPI support.*

Power Connector

SSI ATX 12V compliant power supplies can turn off the system power through system control. When an ACPI-enabled system receives the correct command, the power supply removes all non-standby voltages.

When resuming from an AC power failure, the computer returns to the power state it was in before power was interrupted (on or off). The computer's response can be set using the Last Power State feature in the BIOS Setup program's Boot menu.

LAN wake Capabilities

CAUTION!

For LAN wake capabilities, the +5 V standby line for the power supply must be capable of providing adequate +5 V standby current. Failure to provide adequate standby current when implementing LAN wake capabilities can damage the power supply.

LAN wake capabilities enable remote wake-up of the computer through a network. The LAN subsystem PCI bus network adapter monitors network traffic at the Media Independent Interface. Upon detecting a Magic Packet* frame, the LAN subsystem asserts a wake-up signal that powers up the computer. Depending on the LAN implementation, the VIG390S motherboard supports LAN wake capabilities with ACPI in the following ways:

- The PCI bus PME# signal for PCI 2.2 compliant LAN designs
- The onboard LAN subsystem

Instantly Available PC Technology

CAUTION!

For Instantly Available PC technology, the +5 V standby line for the power supply must be capable of providing adequate +5 V standby current. Failure to provide adequate standby current when implementing Instantly Available PC technology can damage the power supply.

Instantly Available PC technology enables the VIG390S motherboard to enter the ACPI S3 (Suspend-to-RAM) sleep-state. While in the S3 sleep-state, the computer will appear to be off (the power supply is off, and the front panel LED is amber if dual coloured, or off if single coloured.) When signalled by a wake-up device or event, the system quickly returns to its last known wake state.

The use of Instantly Available PC technology requires operating system support and PCI 2.2 compliant add-in cards and drivers.

Resume on Ring

The operation of Resume on Ring can be summarised as follows:

- Resumes operation from ACPI S1 or S3 states
- Detects incoming call similarly for external and internal modems
- Requires modem interrupt be unmasked for correct operation

Wake from USB

USB bus activity wakes the computer from ACPI S1 or S3 states.

Note: *Wake from USB requires the use of a USB peripheral that supports Wake from USB.*

Wake from PS/2 Devices

PS/2 device activity wakes the computer from an ACPI S1 or S3 state.

PME# Signal Wake-up Support

When the PME# signal on the PCI bus is asserted, the computer wakes from an ACPI S1, S3, S4, or S5 state (with Wake on PME enabled in BIOS).

Chapter 2: System Board Options

The VIG390S motherboard is capable of accepting up to two Xeon™ CPU's. RAM can be upgraded to a maximum of 8GB using DDR2 400 SDRAM DIMMs ECC Unbuffered memory.

WARNING!

Unplug the system before carrying out the procedures described in this chapter. Failure to disconnect power before you open the system can result in personal injury or equipment damage. Hazardous voltage, current, and energy levels are present in this product. Power switch terminals can have hazardous Voltages present even when the power switch is off.

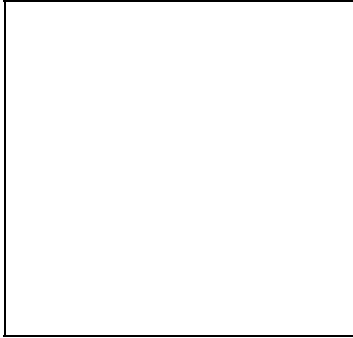
The procedures assume familiarity with the general terminology associated with personal computers and with the safety practices and regulatory compliance required for using and modifying electronic equipment. Do not operate the system with the cover removed. Always replace the cover before turning on the system.

As the colours of the wires in the mains lead of this computer may not correspond with the coloured markings identifying the terminals in your plug precede as follows:

The wire which is coloured green-and-yellow must be connected to the terminal in the plug which is marked by the letter **E** or by the safety Earth symbol **Q** or coloured green or green-and-yellow.

The wire which is coloured blue must be connected to the terminal which is marked with the letter **N** or coloured black.

The wire which is coloured brown must be connected to the terminal which is marked with the letter **L** or coloured red.



CAUTION!

The Viglen VIG390S motherboard and associated components are sensitive electronic devices. A small static shock from your body can cause expensive damage to your equipment.

Make sure you are earthed and free of static charge before you open the computer case. If you are unsure about upgrading your computer, return it to Viglen so a qualified engineer can perform the upgrade.

STEPS TO TAKE TO PREVENT STATIC DISCHARGE:

1. The best way to prevent static discharge is to buy an anti-static strap from your local electrical shop. While you are wearing the strap and it is earthed, static charge will be harmlessly bled to ground.
2. Do not remove the component from its anti-static protective packaging until you are about to install it.
3. Hold boards by the edges - try not to touch components / interface strips etc.

Note: *We recommend that you return your computer to the service department for upgrading. Any work carried out is fully guaranteed. Upgrades should only be carried out by persons who are familiar with handling IC's, as incorrect installation will invalidate the guarantee.*

Overview of Jumper Settings

The VIG390S motherboard contains the latest technology to offer an almost jumperless configuration. All Xeon™ CPUs are automatically detected and the Speed is automatically set from the information provided by the CPU.

CAUTION!

Never remove jumpers using large pliers as this can damage the pins. The best way to remove a jumper is to use a small pair of tweezers or fine needle-nosed pliers.

Never remove a jumper when the computer is switch on. Always switch the computer off first.

System Board Jumper Settings

The following figure shows the jumper locations of the motherboard. Please refer to the following tables describing each jumper's configuration.

CAUTION!

Do not move the jumper with the power on. Always turn off the power and unplug the power cord from the computer before changing a jumper, taking all necessary anti static precautions.

Note: *There is no jumper setting for configuring the processor speed or bus frequency. The feature for configuring the processor speed is in the Setup program using configure mode. See BIOS Section for information about configure mode.*

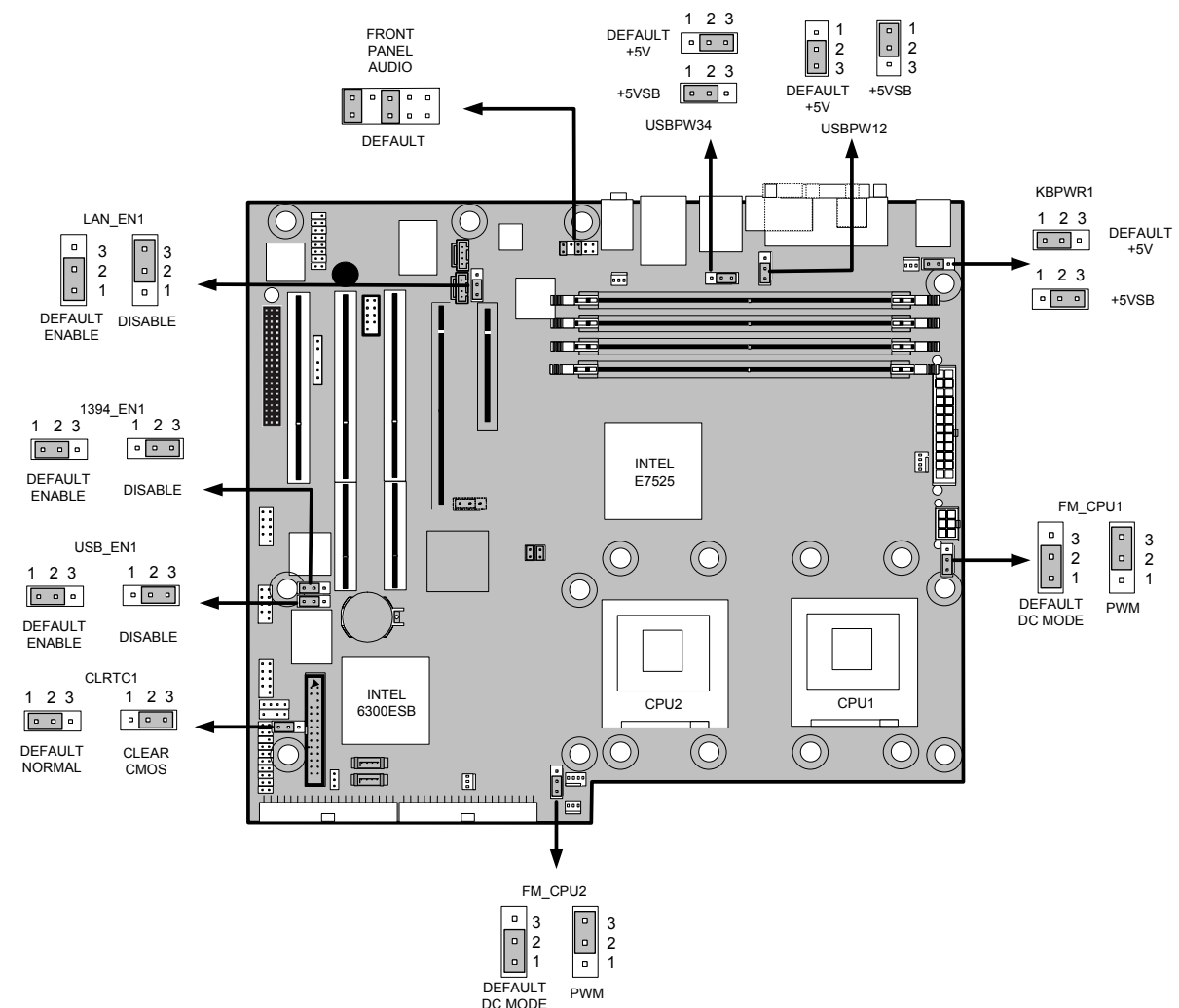




Figure 14: Jumper Configurations

CLEAR CMOS Jumper Settings (CLRTC1)

The table below describes the jumper settings; if the jumper removed and the computer is powered-up then a system boot failure will occur.



Table 12: CLEAR CMOS Jumper Settings (CLRTC1)

Function/Mode	Jumper Setting	Configuration
(Default) Normal	1-2 	CMOS data is retained when system is off
CLEAR CMOS	2-3 	With power off, mains power disconnected move jumper to pins 2 and 3 for about 5 ~ 10 seconds. This will also rest the Real Time Clock and system BIOS set passwords.

USB Jumper (USB_EN1)

The table below describes the jumper settings; if the jumper removed and the computer is powered-up then a system boot failure will occur.

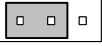
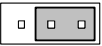
Table 13: USB Jumper (USB_EN1)

Function/Mode	Jumper Setting	Configuration
(Default) Enable	1-2 	Enables front USB 2.0 controller for USB 6/6/7 and 8.
Disable	2-3 	Disables front USB 2.0 controller.

IEEE1394a Jumper (1394_EN1)

The table below describes the jumper settings; if the jumper removed and the computer is powered-up then a system boot failure will occur.


Table 14: IEEE1394a Jumper (1394_EN1)

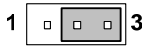
Function/Mode	Jumper Setting	Configuration
(Default) Enable	1-2 	Enables front IEEE-1394a controller for IEEE1394a 2.
Disable	2-3 	Disables front IEEE-1394a controller.

LAN Jumper (LAN_EN1)

The table below describes the jumper settings; if the jumper removed and the computer is powered-up then a system boot failure will occur.

Table 15: LAN Jumper (LAN_EN1)

Function/Mode	Jumper Setting	Configuration
(Default) Enable	1-2 	Enables onboard LAN controller., this may also be controlled via additional BIOS setting.

Disable	2-3		Disables onboard LAN controller. If set to disabled this may not be enabled via additional BIOS setting.
---------	-----	---	--

Front Panel audio Jumpers (Front panel audio)

The table below describes the jumper settings; if the jumper removed and the computer is powered-up then a system boot failure will occur.

Table 16: Front Panel audio Jumpers (Front panel audio)

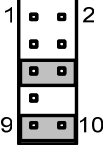
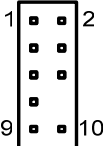
Function/Mode	Jumper Setting		Configuration
(Default)	5-6 and 9-10		Allows audio to pass to rear I/O with no front audio cable. The audio line signals are routed back to the line connector.
Front panel audio	none		Jumpers removed for front panel audio cable. Audio line out and mic in signals are available for front panel audio connectors on this connector when no jumpers are installed.

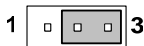

Table 17: Front panel Audio Connector

Pin	Signal name	Pin	Signal name
1	MIC_IN	2	Ground
3	MIC_BIAS	4	+5V
5	RIGHT_OUT	6	RIGHT_IN
7	Ground	8	Key
9	LEFT_OUT	10	LEFT_IN

USB power Jumper (USBPW34)

The table below describes the jumper settings; if the jumper removed and the computer is powered-up then a system boot failure will occur.

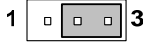

Table 18: USB power Jumper (USBPW34)

Function/Mode	Jumper Setting		Configuration
(Default) +5	2-3		Default mode +5V connection for USB ports 3 and 4.
+5VSB	1-2		Changing the jumpers to the +5VSB will enable wake up from suspend with a USB device connected to USB ports 3 or 4.

USB power Jumper (USBPW12)

The table below describes the jumper settings; if the jumper removed and the computer is powered-up then a system boot failure will occur.



Table 19: USB power Jumper (USBPW12)

Function/Mode	Jumper Setting	Configuration
(Default) +5	2-3 	Default mode +5V connection for USB ports 1 and 2.
+5VSB	1-2 	Changing the jumpers to the +5VSB will enable wake up from suspend with a USB device connected to USB ports 1 or 2.

Keyboard Power Jumper (KBPWR1)

The table below describes the jumper settings; if the jumper removed and the computer is powered-up then a system boot failure will occur.

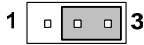

Table 20: Keyboard Power Jumper (KBPWR1)

Function/Mode	Jumper Setting	Configuration
(Default) +5V	1-2 	Default mode +5V, keyboard operation will not wake system from suspend modes.
+5VSB	2-3 	The Keyboard power jumper is set to +5VSB, this enables keyboard operation to wake the system from suspend.

CPU1 FAN power Jumper (FM_CPU1)

The table below describes the jumper settings; if the jumper removed and the computer is powered-up then a system boot failure will occur.

Table 21: CPU1 FAN power Jumper (FM_CPU1)



Function/Mode	Jumper Setting	Configuration
(Default) DC mode	2-3 	Default mode for 3 wire DC Heatsink fan control.
PWM	1-2 	Alternative mode for 4 wire PWM Heatsink fan control.

Note: this will be set at time of manufacture according to the type of Heatsink fitted.

CPU2 FAN power Jumper (FM_CPU2)

The table below describes the jumper settings; if the jumper removed and the computer is powered-up then a system boot failure will occur.

Table 22: CPU2 FAN power Jumper (FM_CPU2)

Function/Mode	Jumper Setting	Configuration
(Default) DC mode	2-3 	Default mode for 3 wire DC Heatsink fan control.
PWM	1-2 	Alternative mode for 4 wire PWM Heatsink fan control.

Note: This will be set at time of manufacture according to the type of Heatsink fitted.

Motherboard Connectors

There are connectors on the motherboard for FAN, IDE, Power supply, CD audio, Floppy, IDE, & Front Panel Connectors. The location and/or details of these connections are shown below.

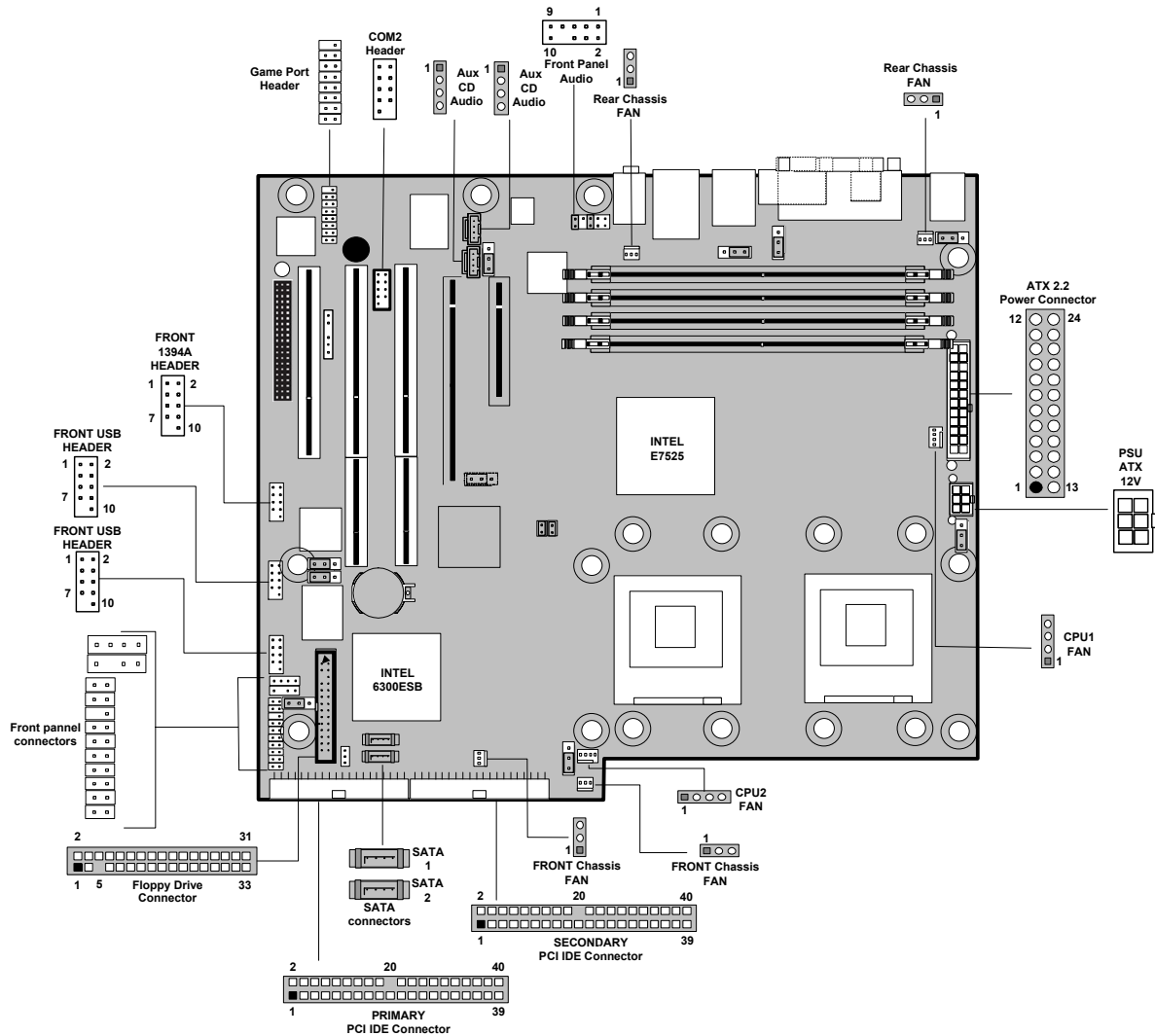


Figure 15: Motherboard Connectors

Front panel connections

The following are all connectors situated along the front edge of the motherboard. They are often connected to buttons and LED's situated on the front panel.

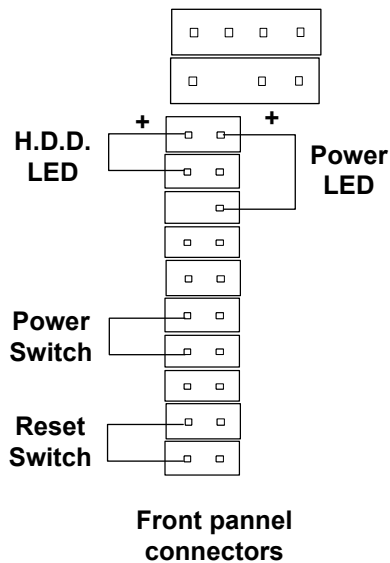


Figure 16: Front panel connectors

A - Hard Disk L.E.D. Connector

This goes to the Hard Disk L.E.D. on the front panel, which lights up when the IDE Hard Disk is in use.

B - Reset switch connector

When these pins are shorted, it will cause the computer to perform a cold reboot.

C - Power L.E.D.

This attaches to the power L.E.D on the front panel, to display if the computer is active or not.

D- Power Switch On/Off

When these pins are shorted it turns the computer on and off.

Upgrading the CPU

CAUTION!

Allow time for the processor and heatsink to cool before touching either of them.

The Intel Xeon™ processor together with Level 2 cache chips are housed in a protective package.

The design of the VIG390S computer makes it a simple job to replace or upgrade the processor. To do so please refer to the figures below follow the instructions:

1. Read the warnings at the start of this chapter and ensure a static free environment
2. Remove the lid from the computer by removing the four screws at the rear of the case
3. Locate the CPU module by referring to figure 17 if necessary
4. Locate the heat sink screws, and remove heat sink (and unplug FAN cable)
5. Lift arm on Socket to release the CPU
6. Lift the CPU Vertically upwards until it is clear of the socket

You can now fit the replacement CPU and heat sink into the socket.

- **Installing CPU's**



Figure 17: CPU Heatsink mounting holes

Note: in the figure above the circled holes are not motherboard mounting holes these hold the Heatsink clips fitted to the motherboard as shown below in figures 18 and 19.

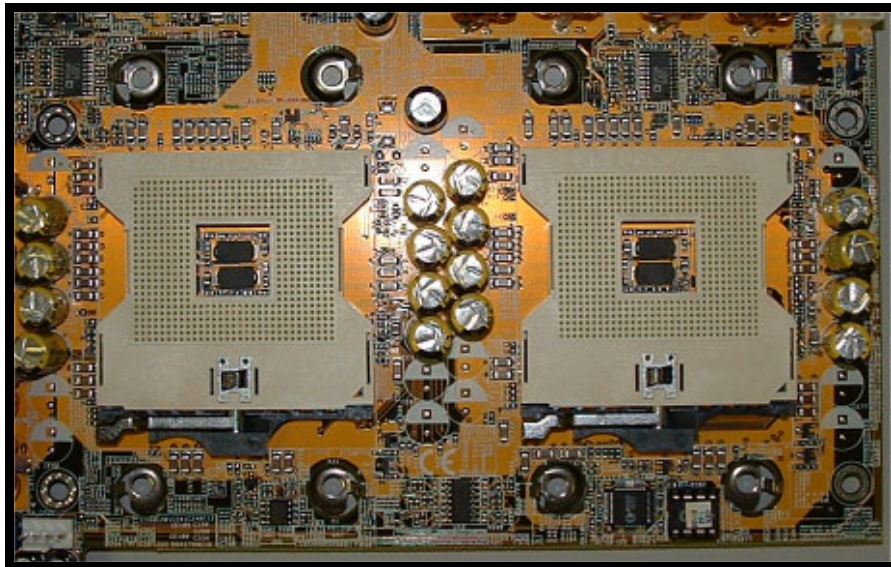


Figure 18: CPU sockets showing Heatsink clips

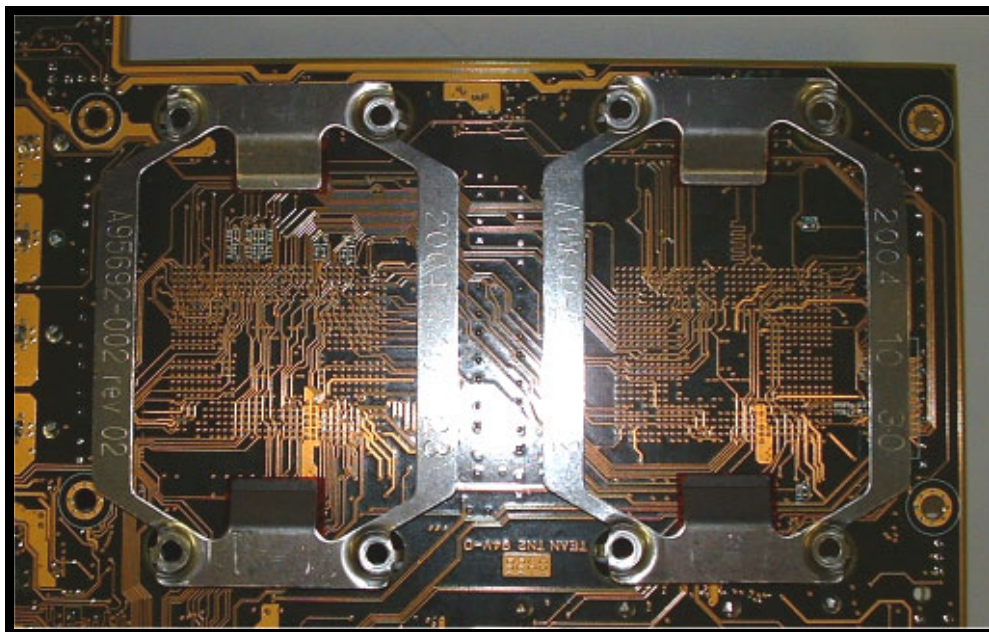
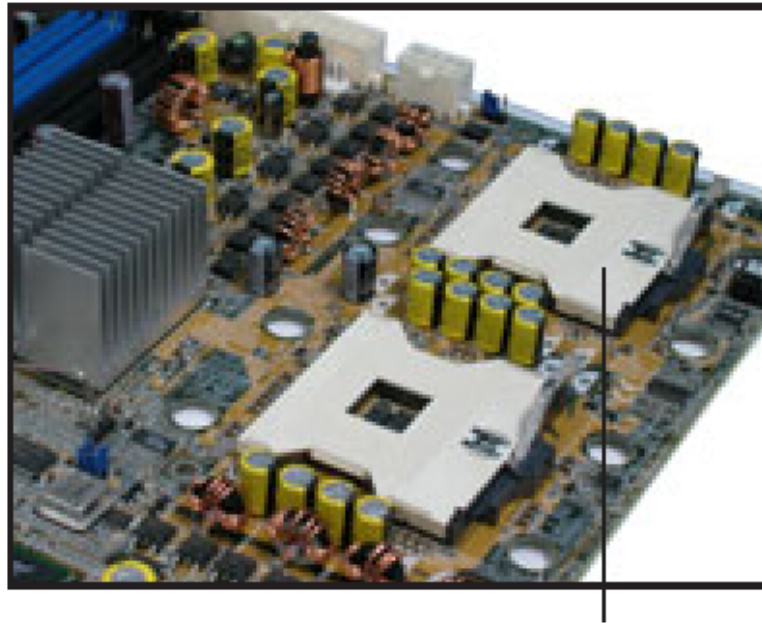


Figure 19: Back of MB showing Heatsink clips



Socket for CPU1

Figure 20: CPU sockets

If one CPU is to be installed it should be installed in socket for CPU1 as shown above. Lift the socket arm up as shown for both sockets in figure 21 install CPU noting correct orientation.

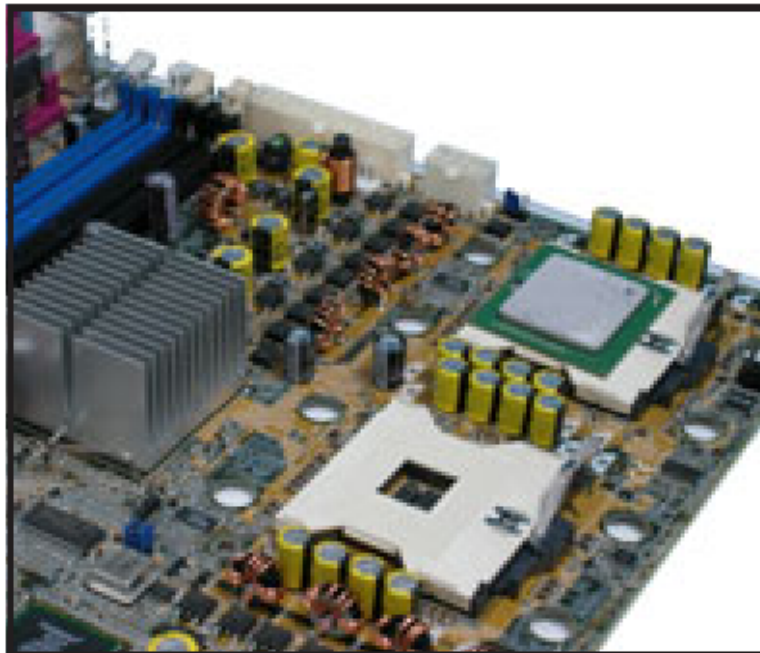
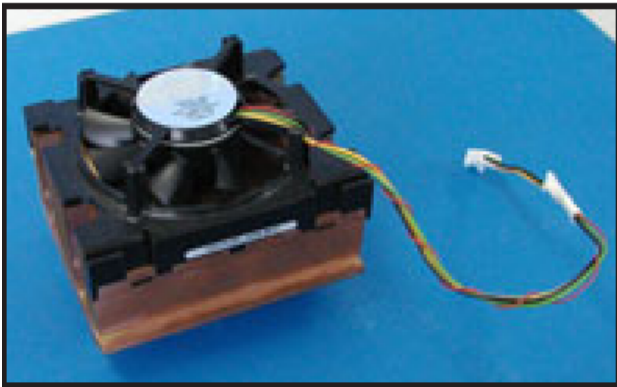


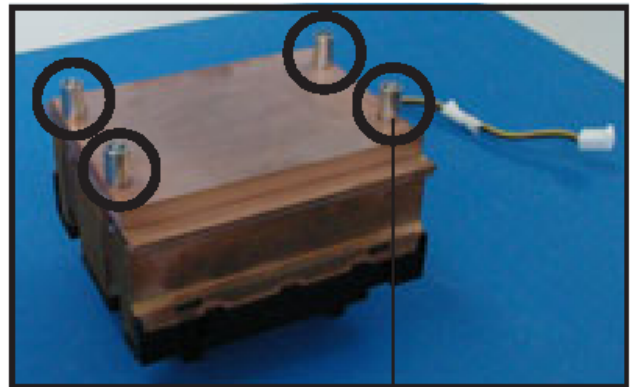
Figure 21: CPU fitted in ZIF socket

Now repeat for second CPU if required; and lock both CPU sockets with each socket locking arm.

CPU heatsink (top view)



CPU heatsink (bottom view)



Heatsink screw

Figure 22: Xeon CPU heatsink

Fitting the heatsinks the figure above shows a typical Heatsink from top and bottom; note the circled pillars that must locate through the motherboard. Note also that if Heatsink thermal paste is not already applied to heatsinks this must now be done.

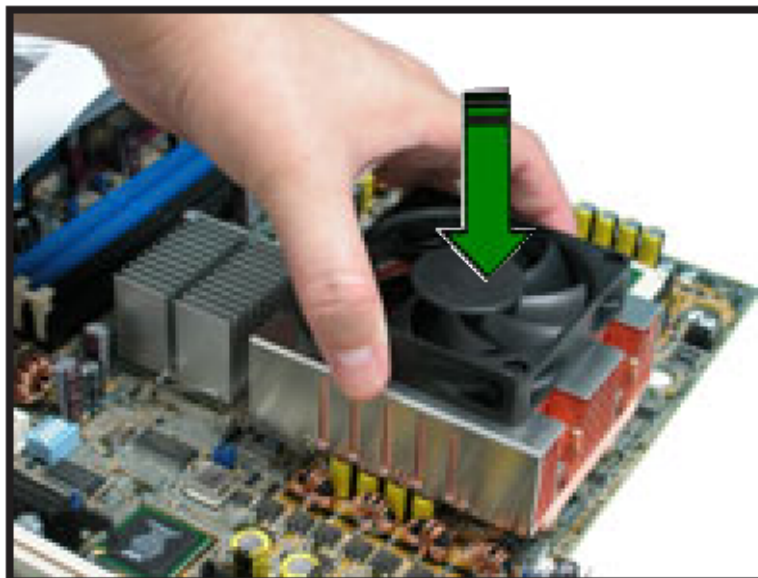


Figure 23: Mounting Heatsink to MB

Carefully locate each Heatsink over each CPU and allow the pillars to align with mounting plates and fixing points through motherboard.

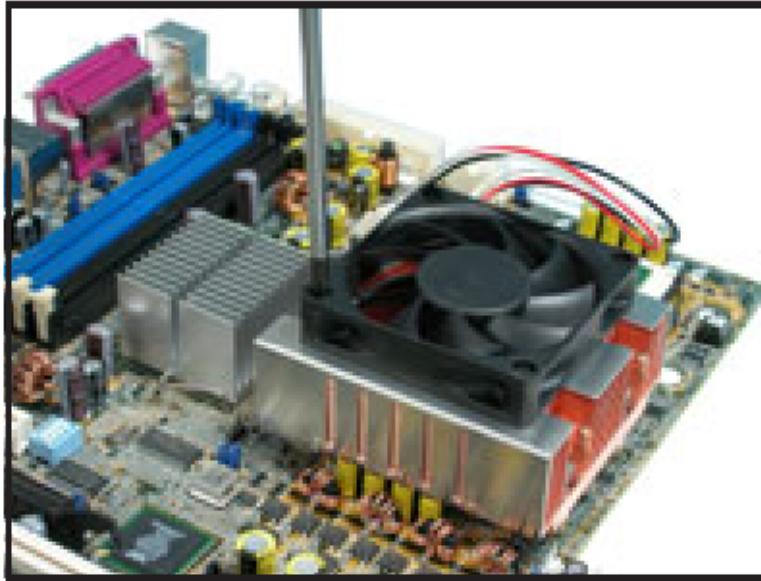


Figure 24: Securing Heatsink through MB

Now tighten all four screws diagonally to secure Heatsink in place and repeat for second Heatsink if necessary.

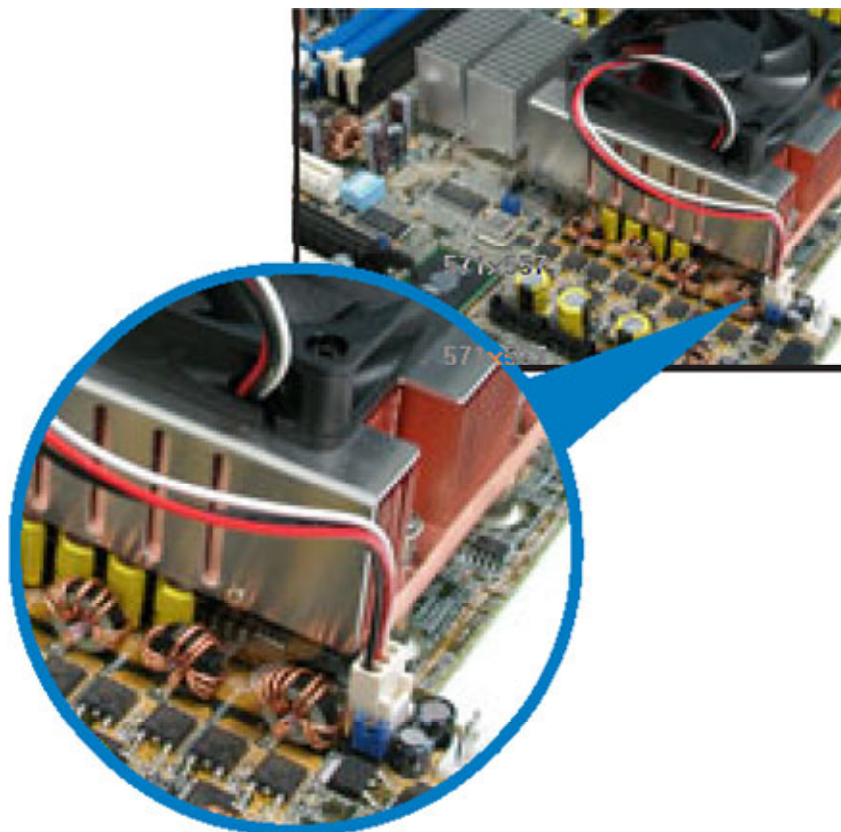


Figure 25: Heatsink fan cable points

Once both heatsinks are secured locate and connect the fan cables of each Heatsink to the appropriate CPU fan header, for CPU 1 “CPU FAN” and for CPU2 “CPU FAN 2”.

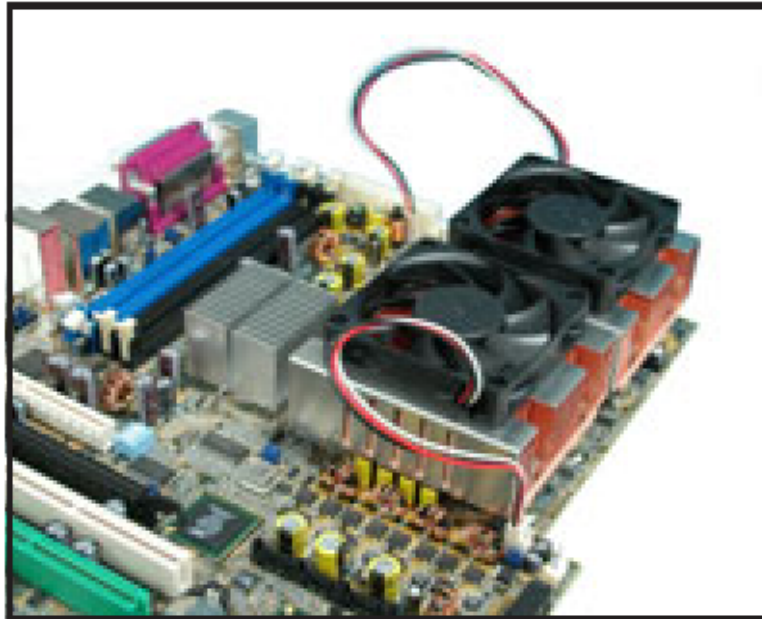


Figure 26: Two Heatsinks fitted through MB

You should now have two CPU's and Heatsink/s secured with fan cable/s connected correctly.

Installing & Removing DDR SDRAM In-line Memory Modules

Installing Memory

You can install from 256MB to 8GB of memory in the motherboard DIMM sockets. The board has four 240-pin DDR2 72bit registered ECC SDRAM DIMM sockets. The motherboard supports the following memory features:

- 240-pin DIMMs with gold-plated contacts.
- ECC (72-bit).
- 256MB, 512MB, 1GB and 2GB (in the future) modules.

When adding memory, follow these guidelines:

- The BIOS detects the size and type of installed memory.

Note:

DDR SDRAM's must meet the JEDEC Solid State Technology Association specifications.

<http://www.jedec.org/>

To install DIMMs, follow these steps:

1. Observe the precautions in "Upgrading and ESD precautions". Turn off the computer and all peripheral devices.
2. Remove the computer cover and locate the DIMM sockets.
3. Holding the DIMM by the edges, remove it from its antistatic package.
4. Make sure the clips at either end of the socket are pushed away from the socket.
5. Position the DIMM above the socket. Align the two small notches in the bottom edge of the DIMM with the keys in the socket. Insert the bottom edge of the DIMM into the socket.
6. When the DIMM is seated, push down on the top edge of the DIMM until the retaining clips at the ends of the socket snap into place. Make sure the clips are firmly in place.
7. Replace the computer cover.

Removing Memory

To remove a DIMM, follow these steps:

1. Observe the precautions in “Upgrading and ESD precautions”.
2. Turn off all peripheral devices connected to the computer. Turn off the computer.
3. Remove the computer cover.
4. Gently spread the retaining clips at each end of the socket. The DIMM pops out of the socket. Hold the DIMM by the edges, lift it away from the socket, and store it in an antistatic package.
5. Reinstall and reconnect any parts you removed or disconnected to reach the DIMM sockets.

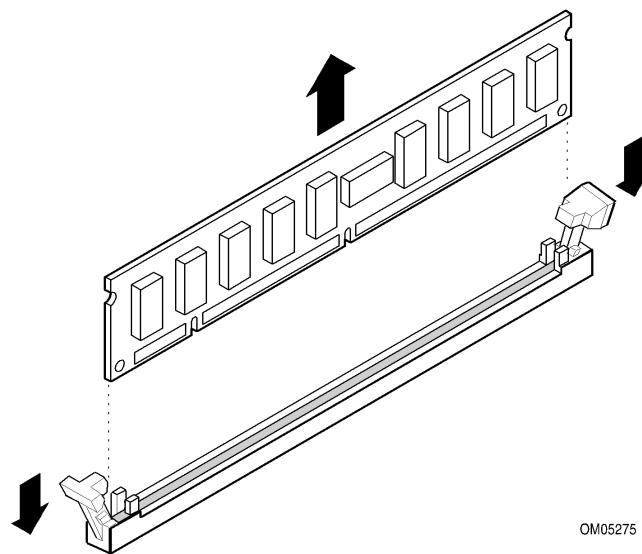


Figure 27: Removing DIMMs

Replacing the Clock/CMOS RAM Battery

A lithium battery is installed in a socket on the system board.

The battery has an estimated life expectancy of seven years. When the battery starts to weaken, it loses voltage; when the voltage drops below a certain level, the system settings stored in CMOS RAM (for example, the date and time) may be wrong.

If the battery fails, you will need to replace it with a **CR2032** battery or an equivalent. As long as local ordinance permits, you may dispose of individual batteries as normal rubbish. Do not expose batteries to excessive heat or any naked flame. Keep all batteries away from children.

CAUTION!

Danger of explosion if the battery is incorrectly replaced. Replace only with the same or equivalent type recommended by Viglen. Discard used batteries according to manufacturer's instructions.

The battery is listed as board component 'FF' on the diagram on Figure 1.

To replace the battery, carry out the following:

1. Observe the precautions in "Before You Begin."
2. Turn off all peripheral devices connected to the system.
3. Turn off the system.
4. Remove any components that are blocking access to the battery.
5. Figure 1 shows the battery location. Gently pry the battery free from its socket, taking care to note the "+" and "-" orientation of the battery (Figure 28).
6. Install the new battery in the socket.

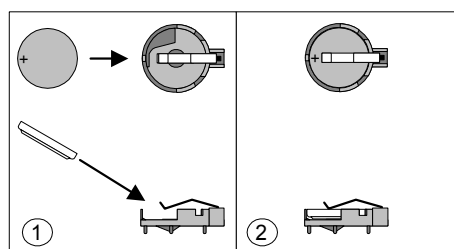


Figure 28: Removing the Battery

Chapter 3: Solving Problems

The first part of this chapter helps you identify and solve problems that might occur when the system is in use. The second part lists error code messages that might be displayed.

Please remember that if you cannot solve the problem by yourself then you should contact your suppliers Technical Support for further assistance.

Viglen Technical Support can be reached in the following ways:

Telephone: 020 8758 7000
Fax: 020 8758 7080
Email: techsupport@viglen.co.uk

You can also look for support information on our web site:

<http://www.viglen.co.uk>

Device drivers and various useful utilities can be downloaded from our ftp site:

<ftp://ftp.viglen.co.uk>

Resetting the System

Before checking your system for hardware problems, it is always a good idea to try resetting your computer and see if a re-boot can solve the problem. Most software related problems can be solved simply by re-booting your PC.

Table 23: Resetting the System

To do the following	Press
Soft boot: Clear the system memory and reload the operating system (also called warm reset).	<Ctrl + Alt + Del>
Cold boot: Clear the system memory, halt power to all peripherals, restart POST, and reload the operating system.	Power off/on or reset button (at front of the system)

Troubleshooting Procedure

This section provides a step-by-step troubleshooting procedure to identify a problem and locate its source.

CAUTION!

1. Turn off the system and any peripheral devices before you disconnect any peripheral cables from the system. Otherwise, you can permanently damage the system or the peripheral devices.
2. Make sure the system is plugged into a properly grounded power outlet.
3. Make sure your keyboard and video display are correctly connected to the system. Turn on the video display, and turn up its brightness and contrast controls to at least two-thirds of the maximum (refer to the documentation supplied with the video display).
4. If the operating system normally loads from the hard disk drive, make sure there is no diskette in the diskette drive. If the operating system normally loads from a diskette, insert the operating system diskette into the drive.
5. Turn on the system. If the power indicator does not light, but the system seems to be operating normally, the indicator is probably defective. Monitor the power-on self test (POST) execution. Each time you turn on the system, the POST checks the system board, memory, keyboard, and certain peripheral devices.

Note: If the POST does not detect any errors, the system beeps once and boots up.

Errors that do not prevent the boot process (non-fatal errors) display a message that looks similar to the following:

```
Error Message Line 1
Error Message Line 2
Press <F1> for Set-up, <F2> to Boot
You can note the error and press <F2> to resume the boot- up process, or
<F1> to enter Set-up.
```

Errors that prevent the boot process from continuing (fatal errors), are communicated by a series of audible beeps. If this type of error occurs, refer to the error codes and messages listed at the end of this chapter.

6. Confirm that the operating system has loaded.

Problems Operating Add-in Boards

Problems related to add-in boards are usually related to improper board installation or interrupt and address conflicts. Go through the checklist below to see if you can correct the problem. If the problem persists after you have checked and corrected all of these items, contact the board vendor's customer service representative.

Did you install the add-in board according to the manufacturer's instructions? Check the documentation that came with the board. Are all cables installed properly?

The following items are suggestions for troubleshooting problems related to PCI/ISA legacy (non-Plug and Play) add-in boards.

- If the PCI/ISA board uses an interrupt, run Set-up and set the interrupt that is being used by the PCI/ISA board to Used by PCI/ISA Card. Please refer to the BIOS manual for details of how to do this.
- If the PCI/ISA legacy board uses memory space between 80000H - 9FFFFH, run Set-up and set conventional memory to 256 K.
- If the PCI/ISA legacy board uses shared memory between C8000H - DFFFFH, run Set-up and enable shared memory for the appropriate memory space.

Problems and Suggestions

Table 24: Problems and Suggestions

What happens	What to do
Application software problems	<p>Try resetting the system.</p> <p>Make sure all cables are installed correctly.</p> <p>Verify that the system board jumpers are set properly.</p> <p>Verify that your system hardware configuration is set correctly. In Setup, check the values against the system settings you recorded previously. If an error is evident (wrong type of drive specified, for example), make the change in Setup and reboot the system. Record your change.</p> <p>Make sure the software is properly configured for the system. Refer to the software documentation for information.</p> <p>Try a different copy of the software to see if the problem is with the copy you are using.</p> <p>If other software runs correctly on the system, contact the vendor of the software that fails.</p> <p>If you check all of the above with no success, try clearing CMOS RAM and reconfiguring the system. Make sure you have your list of system settings available to re-enter, because clearing CMOS RAM sets the options to their default values.</p>
Characters on-screen are distorted or incorrect	<p>Make sure the brightness and contrast controls are properly adjusted on the monitor.</p> <p>Make sure the video signal cable and power cables are properly installed.</p> <p>Make sure your monitor is compatible with the video mode you have selected.</p>
Characters do not appear on screen	<p>Make sure the video display is plugged in and turned on.</p> <p>Check that the brightness and contrast controls are properly adjusted.</p> <p>Check that the video signal cable is properly installed.</p> <p>Make sure a video board is installed, enabled, and the jumpers are positioned correctly.</p> <p>Reboot the system.</p>
CMOS RAM settings are wrong	<p>If system settings stored in CMOS RAM change for no apparent reason (for example, the time of day develops an error), the backup battery may no longer have enough power to maintain the settings. Replace the battery (Chapter 2).</p>
Diskette drive light does not go on when drive is in use or is tested by POST	<p>Make sure the power and signal cables for the drive are properly installed.</p> <p>Check that the drive is properly configured and enabled in Setup.</p>

Table 24: Problems and Suggestions (Continued)

What happens	What to do
Hard drive light does not go on when drive is in use or is tested by POST	<p>Make sure the power and signal cables for the drive are properly installed.</p> <p>Make sure the front panel connector is securely attached to the system board headers.</p> <p>Check that the drive is properly configured and enabled in Setup.</p> <p>Check the drive manufacturer's manual for proper configuration for remote hard disk drive activity.</p>
Power-on light does not go on	If the system is operating normally, check the connector between the system board and the front panel. If OK, the light may be defective.
Prompt doesn't appear after system boots	<p>It's probably switched off.</p> <p>A serious fault may have occurred consult your dealer service department / Technical Support.</p>
Setup, can't enter	If you can't enter Setup to make changes, check the switch that disables entry into Setup (Chapter 2). If the switch is set to allow entry into Setup, you might need to clear CMOS RAM to the default values and reconfigure the system in Setup.
System halts before completing POST	This indicates a fatal system error that requires immediate service attention. Note the screen display and write down any beep code emitted. Provide this information to your dealer service department / Technical Support.

Error and Information Messages

The rest of this chapter describes beep codes, and error messages that you might see or hear when you start up the system:

BIOS Error Messages

Table 25: BIOS Error Messages

Error Message	Explanation
GA20 Error	An error occurred with Gate A20 when switching to protected mode during the memory test.
Pri Master HDD Error Pri Slave HDD Error Sec Master HDD Error Sec Slave HDD Error	Could not read sector from corresponding drive.
Pri Master Drive - ATAPI Incompatible Pri Slave Drive - ATAPI Incompatible Sec Master Drive - ATAPI Incompatible Sec Slave Drive - ATAPI Incompatible	Corresponding drive is not an ATAPI device. Run Setup to make sure device is selected correctly.
A: Drive Error	No response from diskette drive.
Cache Memory Bad	An error occurred when testing L2 cache. Cache memory may be bad.
CMOS Battery Low	The battery may be losing power. Replace the battery soon.
CMOS Display Type Wrong	The display type is different than what has been stored in CMOS. Check Setup to make sure type is correct.
CMOS Checksum Bad	The CMOS checksum is incorrect. CMOS memory may have been corrupted. Run Setup to reset values.
CMOS Settings Wrong	CMOS values are not the same as the last boot. These values have either been corrupted or the battery has failed.
CMOS Date/Time Not Set	The time and/or date values stored in CMOS are invalid. Run Setup to set correct values.
DMA Error	Error during read/write test of DMA controller.
FDC Failure	Error occurred trying to access diskette drive controller.
HDC Failure	Error occurred trying to access hard disk controller.
Checking NVRAM.....	NVRAM is being checked to see if it is valid.
Update OK!	NVRAM was invalid and has been updated.
Updated Failed	NVRAM was invalid but was unable to be updated.
Keyboard Error	Error in the keyboard connection. Make sure keyboard is connected properly.
KB/Interface Error	Keyboard interface test failed.
Memory Size Decreased	Memory size has decreased since the last boot. If no memory was removed then memory may be bad.
Memory Size Increased	Memory size has increased since the last boot. If no memory was added there may be a problem with the system.

Table 25: BIOS Error Messages (Continued)

Error Message	Explanation
Memory Size Changed	Memory size has changed since the last boot. If no memory was added or removed then memory may be bad.
No Boot Device Available	System did not find a device to boot.
Off Board Parity Error	A parity error occurred on an off-board card. This error is followed by an address.
On Board Parity Error	A parity error occurred in onboard memory. This error is followed by an address.
Parity Error	A parity error occurred in onboard memory at an unknown address.
NVRAM/CMOS/PASSWORD cleared by Jumper	NVRAM, CMOS, and passwords have been cleared. The system should be powered down and the jumper removed.
<CTRL_N> Pressed	CMOS is ignored and NVRAM is cleared. User must enter Setup.

BIOS Beep Codes

If an unrecoverable hardware problem occurs the computer may emit a number of beeps from the speaker. These are known as beep codes. The pitch and duration of the beep codes may vary but there will always be a set number of beeps. These beeps stem from the BIOS's initial check on the system and will normally occur in the first few seconds of power on.

Beeps codes represent a terminal error. If the BIOS detects a terminal error condition, it outputs an error beep code, halts the POST, and attempts to display a port 80h code on a POST card's LED display.

Table 26: Beep Codes

Beeps	Description
2 long + 2 short	Floppy controller
2 long + 4 short	Hardware component failure

Chapter 4: System BIOS

What is the BIOS?

The BIOS (Basic Input Output System) is an important piece of software which is stored in a ROM (Read Only Memory) chip inside the computer. It consists of the basic instructions for controlling the disk drives, hard disk, keyboard and serial/parallel ports. The BIOS also keeps a list of the specifications of the computer in battery-backed RAM (also known as the CMOS RAM) and provides a special Setup program to change this information.

The BIOS in your Viglen computer is guaranteed to be fully compatible with the IBM BIOS. It has been written by American MegaTrends Inc. (AMI), an industrial leader in the field of BIOS software.

The Power-on sequence

When the computer is first switched on, certain instructions in the BIOS are executed to test various parts of the machine. This is known as the POST (Power-On Self Test) routine. When you switch the computer on (or when you press the Reset button or press <Ctrl> + <Alt>+ <Delete> keys, which has the same effect), you can see on the monitor that it counts through the memory, testing it. The floppy disk drives are then accessed and tested, and the various interfaces are checked. If there are any errors, a message is displayed on the screen.

Having passed all the tests, and if you have activated the password facility, the BIOS then asks you to enter the boot password to continue. The following section describes how to do this. The BIOS then loads the operating system, either - MS DOS, Windows 2000 Professional or Windows XP Pro /Home, etc. - from the hard disk (or floppy disk if one is inserted in Drive A:). The computer is then ready for use.

AMI BIOS

Introduction

The motherboard uses an AMI BIOS, which is stored in flash memory and can be upgraded using a disk-based program. In addition to the BIOS, the flash memory contains the Setup program, Power-On Self Test (POST), Advanced Power Management (APM), the PCI auto-configuration utility, and is Windows Plug and Play. This motherboard supports system BIOS shadowing, allowing the BIOS to execute from 64-bit onboard write-protected DRAM.

The BIOS displays a message during POST identifying the type of BIOS and the revision code.

BIOS Upgrades

A new version of the BIOS can be upgraded from a diskette using the iFLASH.EXE utility that is available from Intel. This utility does BIOS upgrades as follows:

- Updates the flash BIOS from a file on a disk.
- Updates the language section of the BIOS.
- Makes sure that the upgrade BIOS matches the target system to prevent accidentally installing a BIOS for a different type of system.

BIOS upgrades and the AFUDOS.exe utility may be available online at www.viglen.co.uk or by request.

Note: Please review the instructions distributed with the upgrade utility before attempting a BIOS upgrade.

BIOS Flash Memory Organisation

The Intel Firmware Hub (FWH) includes a 8 Mbit flash memory device. Internally, the device is grouped into eight 64-KB blocks that are individually erasable, lockable, and unlockable.

The 8-Mbit flash component is organised as 256 KB x 8 bits and is divided into areas as described in Table 27. The table shows the addresses in the ROM image in normal mode (the addresses change in BIOS Recovery Mode).

Table 27: Typical Flash Memory Organisation

Address (Hex)	Size	Description
FFFFC000 – FFFFFFFF	16 KB	Boot Block
FFFFA000 – FFFFBFFF	8 KB	Vital Product Data (VPD) Extended System Configuration Data (ESCD) (DMI configuration data / Plug and Play data)
FFFF9000 - FFFF9FFF	4 KB	Used by BIOS (e.g., for Event Logging)
FFFF8000 - FFFF8FFF	4 KB	OEM logo or Scan Flash Area
FFFC0000 - FFFF7FFF	228 KB	Main BIOS Block

Plug and Play: PCI Auto-configuration

The BIOS automatically configures PCI devices and Plug and Play devices. PCI devices may be onboard or add-in cards. Plug and Play devices are ISA add-in cards built to meet the Plug and Play specification. Auto-configuration lets a user insert or remove PCI or Plug and Play cards without having to configure the system. When a user turns on the system after adding a PCI or Plug and Play card, the BIOS automatically configures interrupts, the I/O space, and other system resources. Any interrupts set to Available in Setup are considered to be available for use by the add-in card.

PCI interrupts are distributed to available ISA interrupts that have not been assigned to an ISA card or to system resources. The assignment of PCI interrupts to ISA IRQs is non-deterministic. PCI devices can share an interrupt, but an ISA device cannot share an interrupt allocated to PCI or to another ISA device. Auto-configuration information is stored in the extended system configuration data (ESCD) format.

PCI IDE Support

If Auto is selected as a primary or secondary IDE in Setup, the BIOS automatically sets up the two local-bus IDE connectors with independent I/O channel support. The IDE interface supports hard drives up to PIO Mode 4 and recognises any ATAPI devices, including CD-ROM drives, tape drives and Ultra DMA drives. Add-in ISA IDE controllers are not supported. The BIOS determines the capabilities of each drive and configures them so as to optimise capacity and performance. To take advantage of the high-capacity storage devices, hard drives are automatically configured for logical block addressing (LBA) and to PIO Mode 3 or 4, depending on the capability of the drive. To override the auto-configuration options, use the specific

IDE device options in Setup. The ATAPI specification recommends that ATAPI devices be configured as shown in Table 28.

Table 28: Recommendations for Configuring an ATAPI Device

Configuration	Primary Cable		Secondary Cable	
	Drive 0	Drive 1	Drive 0	Drive 1
Normal, no ATAPI	ATA			
Disk and CD-ROM for enhanced IDE systems	ATA		ATAPI	
Legacy IDE system with only one cable	ATA	ATAPI		
Enhanced IDE with CD-ROM and a tape or two CD-ROMs	ATA		ATAPI	ATAPI

Plug and Play

If Plug and Play operating system is selected in Setup, the BIOS auto-configures only ISA Plug and Play cards that are required for booting (IPL devices). If Plug and Play operating system is not selected in Setup, the BIOS auto-configures all Plug and Play ISA cards.

Desktop Management Interface (DMI)

Desktop Management Interface (DMI) is an interface for managing computers in an enterprise environment. The main component of DMI is the management information format (MIF) database, which contains information about the computing system and its components. Using DMI, a system administrator can obtain the system types, capabilities, operational status, and installation dates for system components. The MIF database defines the data and provides the method for accessing this information. The BIOS enables applications such as Intel LANDesk® Client Manager to use DMI. The BIOS stores and reports the following DMI information:

- BIOS data, such as the BIOS revision level.
- Fixed-system data, such as peripherals, serial numbers, and asset tags.
- Resource data, such as memory size, cache size, and processor speed.
- Dynamic data, such as event detection and error logging.

DMI does not work directly under non-Plug and Play operating systems (e.g., Windows NT). However, the BIOS supports a DMI table interface for such operating systems. Using this support, a DMI service-level application running on a non-Plug and Play OS can access the DMI BIOS information.

Advanced Power Management (APM)

The BIOS supports APM and standby mode. The energy saving standby mode can be initiated in the following ways:

- Time-out period specified in Setup.

- Suspend/resume switch connected to the front panel sleep connector.
- From the operating system, such as the Suspend menu item in Windows 95.

In standby mode, the motherboard reduces power consumption by using SMM capabilities, spinning down hard drives, and reducing power to or turning off VESA DPMS-compliant monitors. Power-management mode can be enabled or disabled in Setup.

While in standby mode, the system retains the ability to respond to external interrupts and service requests, such as incoming faxes or network messages. Any keyboard or mouse activity brings the system out of standby mode and immediately restores power to the monitor.

The BIOS enables APM by default, but the operating system must support an APM driver for the power-management features to work. For example, Windows 95 supports the power-management features upon detecting that APM is enabled in the BIOS.

Advanced Configuration and Power Interface (ACPI)

ACPI gives the operating system direct control over the power management and Plug and Play functions of a computer. ACPI requires an ACPI-aware operating system. ACPI features include:

- Plug and Play (including bus and device enumeration) and APM functionality normally contained in the BIOS.
- Power management control of individual devices, add-in boards, video displays, and hard disk drives.
- Methods for achieving less than 30-watt system operation in the Power On Suspended sleeping state, and less than 5-watt system operation in the Suspended to Disk sleeping state.
- A soft-off feature that enables the operating system to power off the computer.
- Support for multiple wake up events.
- Support for a front panel power and sleep mode switch. Table 29 describes the system states based on how long the power switch is pressed, depending on how ACPI is configured with an ACPI-aware operating system.

Table 29: Effects of Pressing the Power Switch

If the system is in this state...	... and the power switch is pressed for	...the system enters this state
Off	Less than 4 seconds	Power On
On	Less than 4 seconds	Soft Off/ Suspended
On	More than 4 seconds	Fail safe power off
Sleep	Less than 4 seconds	Wake up

Under ACPI, the operating system directs all system and device power state transitions. The operating system puts devices in and out of low-power state based on user preferences and knowledge of how devices are being used by applications. Devices that are not being used can be turned off. See Power Management section in Chapter 1, Page 28 for more information on ACPI.

Language Support

The Setup program and help messages can be supported in 32 languages. The default language is American English, which is present unless another language is programmed into the BIOS using the flash memory update utility.

Boot Options

In the Setup program, the user can choose to boot from a floppy drive, hard drive, CD-ROM, or the network. The default setting is for the floppy drive to be the primary boot device and the hard drive to be the secondary boot device. By default the third and fourth devices are disabled.

Booting from CD-ROM is supported in compliance to the El Torito bootable CD-ROM format specification. Under the Boot menu in the Setup program, CD-ROM is listed as a boot device. Boot devices are defined in priority order. If the CD-ROM is selected as the boot device, it must be the first device.

The network can be selected as a boot device. This selection allows booting from a network add-in card with a remote boot ROM installed.

OEM Logo or Scan Area

A 4 KB flash-memory user area at memory is for displaying a custom OEM logo during POST.

USB Support

The USB connectors allow any of several USB devices to be attached to the computer. Typically, the device driver for USB devices is managed by the operating system. However, because keyboard and mouse support may be needed in the Setup program before the operating system boots, the BIOS supports USB keyboards and mice.

BIOS Setup Access

Access to the Setup program can be restricted using passwords. User and supervisor passwords can be set using the Security menu in Setup. The default is no passwords enabled.

Configuring the Motherboard using BIOS Setup

Before You Begin

CAUTION!

- *Always follow the steps in each procedure in the correct order.*
- *Set up a log to record information about your computer, such as model, serial numbers, installed options, and configuration information.*
- *Use an anti-static wrist strap and a conductive foam pad when working on the motherboard.*

WARNINGS

The procedures in this chapter assume familiarity with the general terminology associated with personal computers and with the safety practices and regulatory compliance required for using and modifying electronic equipment.

Disconnect the computer from its power source and from any telecommunications links, networks, or modems before performing any of the procedures described in this chapter. Failure to disconnect power, telecommunications links, networks, or modems before you open the computer or perform any procedures can result in personal injury or equipment damage. Some circuitry on the motherboard may continue to operate even though the front panel power button is off.

CAUTION!

Electrostatic discharge (ESD) can damage components. Perform the procedures described in this chapter only at an ESD workstation. If such a station is not available, you can provide some ESD protection by wearing an anti-static wrist strap and attaching it to a metal part of the computer chassis.

Setting the Processor Speed

There is no need to set the processor speed as this is automatically set by the BIOS. Check the BIOS utility Advanced sub menu CPU Configuration for the correct detection for the CPU or CPU's installed in the motherboard.

Note: The BIOS does allow changing of the CPU clock ratio, we do not recommend the use of this option.

Clearing the Passwords

Note: *Passwords can be cleared individually from the normal BIOS Utility setup mode if the password to be changed is known, if no passwords have been set they can be set as described later in this section.*

BIOS Setup Program

The Setup program is for viewing and changing the BIOS settings for a computer. Setup is accessed by pressing the <Delete> key after the Power-On Self Test (POST) memory test begins and before the operating system boot begins.

Table 30 shows the menus available from the menu bar at the top of the Setup screen.

Table 30: Setup Menu Bar

Setup Menu Screen	Description
Main	Allocates resources for hardware components.
Advanced	Specifies advanced features available through the chipset.
Power	Specifies power management features.
Boot	Specifies boot options and power supply controls.
Exit	Saves or discards changes to the Setup program options.

Table 31 shows the function keys available for menu screens.

Table 31: Setup Function Keys

Setup Key	Description
<←> or <→>	Selects a different menu screen (Moves the cursor left or right)
<↑> or <↓>	Selects an item (Moves the cursor up or down)
<Tab>	Selects a field
<Enter>	Executes command or selects the submenu
<F10>	Save the current values and exits the BIOS Setup program
<Esc>	Exits the menu

BIOS Screen layout

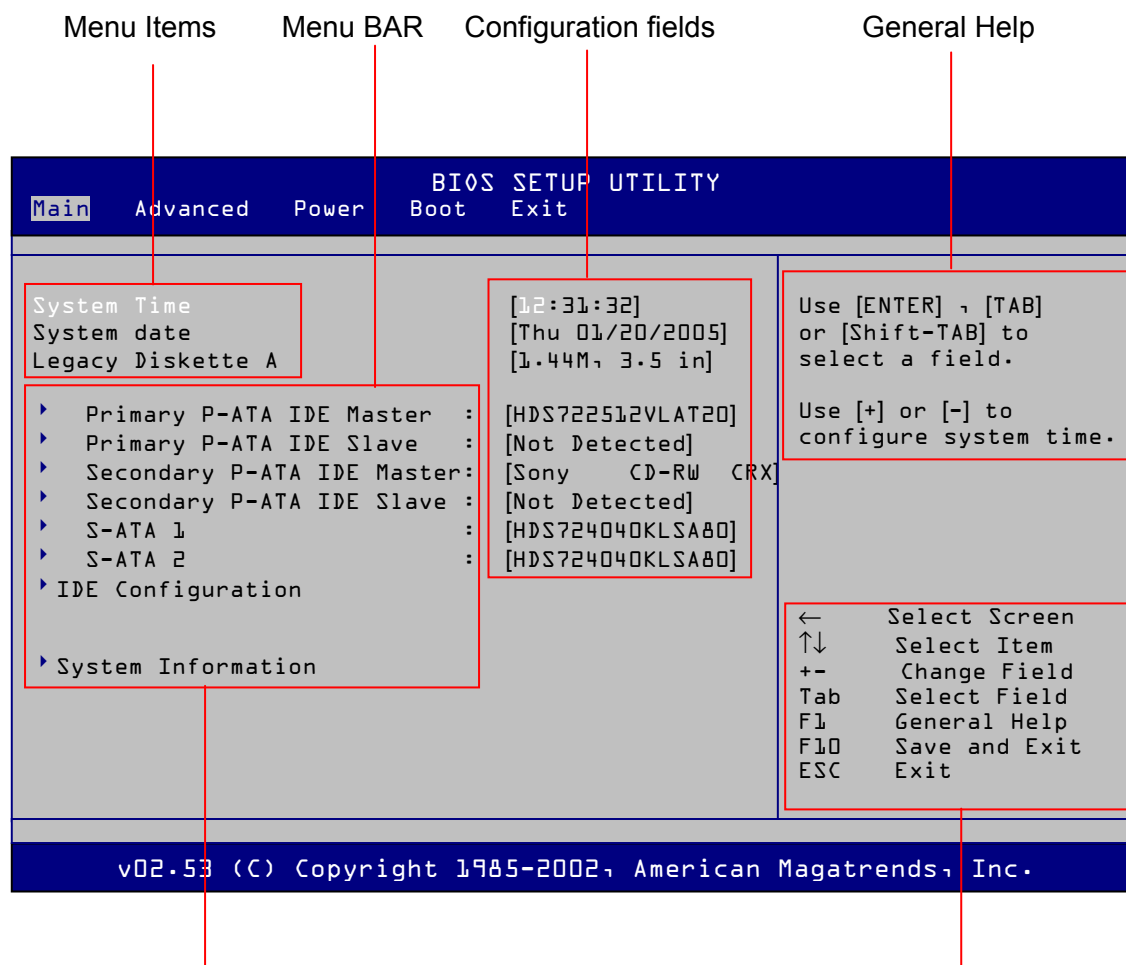


Figure 29: BIOS Screen Layout

Note: Sub-menu items indicated by “▶” Navigation Keys

Menu Bar

Shows the menu screen options available, the currently selected menu screen is high lighted. On entering the BIOS setup utility the Main screen menu is the first to be shown. Use the left and right arrow keys switch select the available screens shown in the menu bar.

Menu items

These are items relating to each menu bar heading and may have an associated configuration filed.

Configuration fields

These show the value set or automatically detected for the corresponding menu item. A configuration filed is either an indication of an automatic detection and may

not be changed or an item that may be configured and permanently changed. To change each field follow the navigation key guide either Press <ENTER> key or <-> or <+> keys to change selected filed. To save the desired change/s the “Save and Exit” option is selected by either F10 directly or via the exit menu and then selecting “Save and Exit”.

Navigation keys

The keys that are indicated are used to select items change configuration fields, save and exit the BIOS setup utility

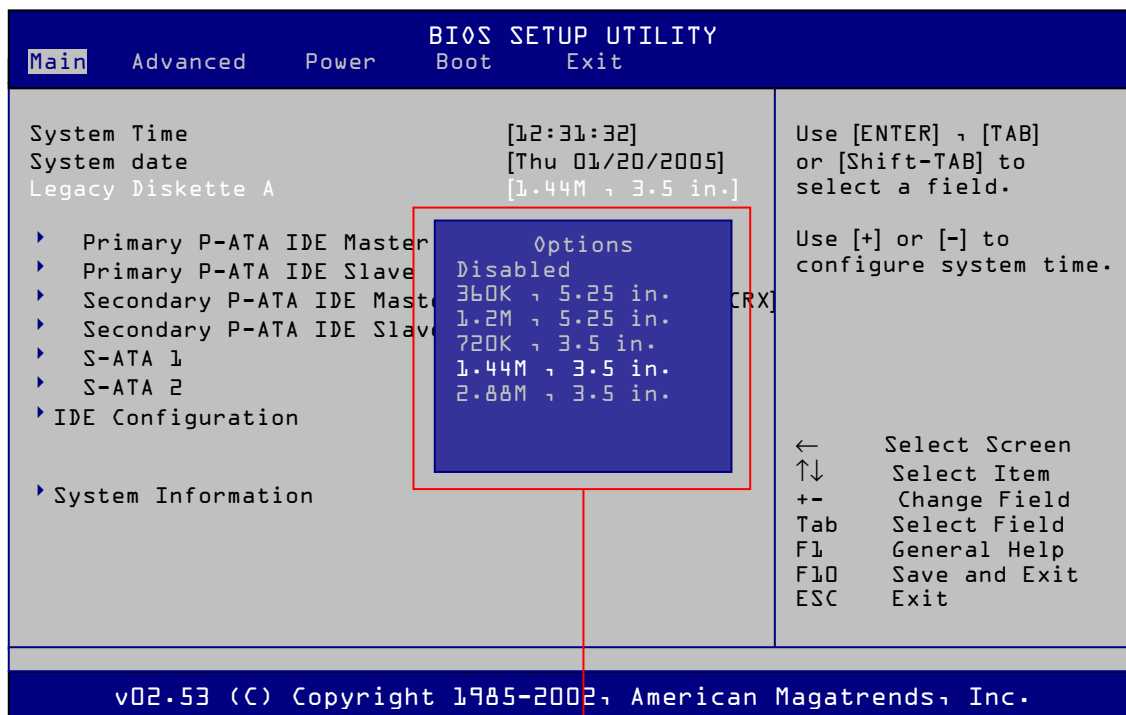


Figure 30: Pop up Windows

Pop up Window appears for options when <Enter> is pressed using the “↑” and “↓” arrows keys to select an option and enter to set the option.

Main Menu

This menu is for configuring the system date, system time, hard drives, optical drives, IDE configuration and system configuration.

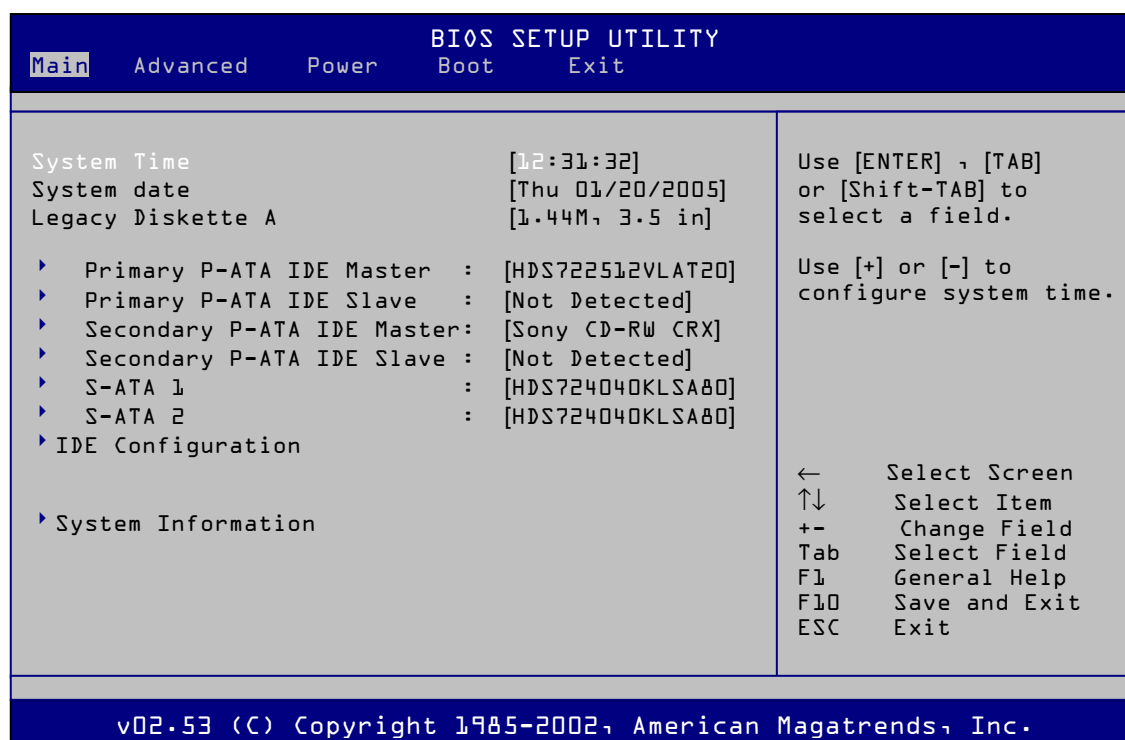


Figure 31: Main Menu

A detailed description of each of the features is given in the following table.

Table 32: Main Menu

Feature	Options	Description
System Time	Hour, minute, and second	Shows the current system time; and allows setting of system time.
System Date	Month, day, and year	Shows the current system date; and allows setting of system date.
Legacy Diskette A	<ul style="list-style-type: none"> • Disabled • 360K , 5.25 in • 1.2M , 5.25 in • 720K , 3.5 in • 1.44 , 3.5 in (default) • 2.88 , 3.5 in 	Floppy drive controller options, allows selection of correct configuration the floppy drive connected.
Primary P-ATA IDE Master	None	Displays a detected P-ATA drive. Press <Enter> to view this Sub menu A P-ATA IDE device is listed to the right otherwise not detected will be displayed. An example HDD is shown.

Primary P-ATA IDE Slave	None	Displays a detected P-ATA drive. Press <Enter> to view this Sub menu A P-ATA IDE device is listed to the right otherwise not detected will be displayed.
Secondary P-ATA IDE Master	None	Displays a detected P-ATA drive. Press <Enter> to view this Sub menu A P-ATA IDE device is listed to the right otherwise not detected will be displayed. An example CD-ROM is shown.
Secondary P-ATA IDE Slave	None	Displays a detected P-ATA drive. Press <Enter> to view this Sub menu A P-ATA IDE device is listed to the right if detected, otherwise not detected will be displayed.
S-ATA 1	None	Displays a detected S-ATA drive. Press <Enter> to view this Sub menu A S-ATA IDE device is listed to the right if detected, otherwise not detected will be displayed.
S-ATA 2	None	Displays a detected S-ATA drive. Press <Enter> to view this Sub menu A S-ATA IDE device is listed to the right if detected, otherwise not detected will be displayed.
IDE Configuration	None	IDE controller configuration Press <Enter> to view this Sub menu
System Information	None	System information sub menu Press <Enter> to view this Sub menu

Main / Primary P-ATA IDE Master or Slave Sub-menu

This menu shows a detected hard drive or CD-ROM features and allows configuration settings to be made. The example is of a hard drive.

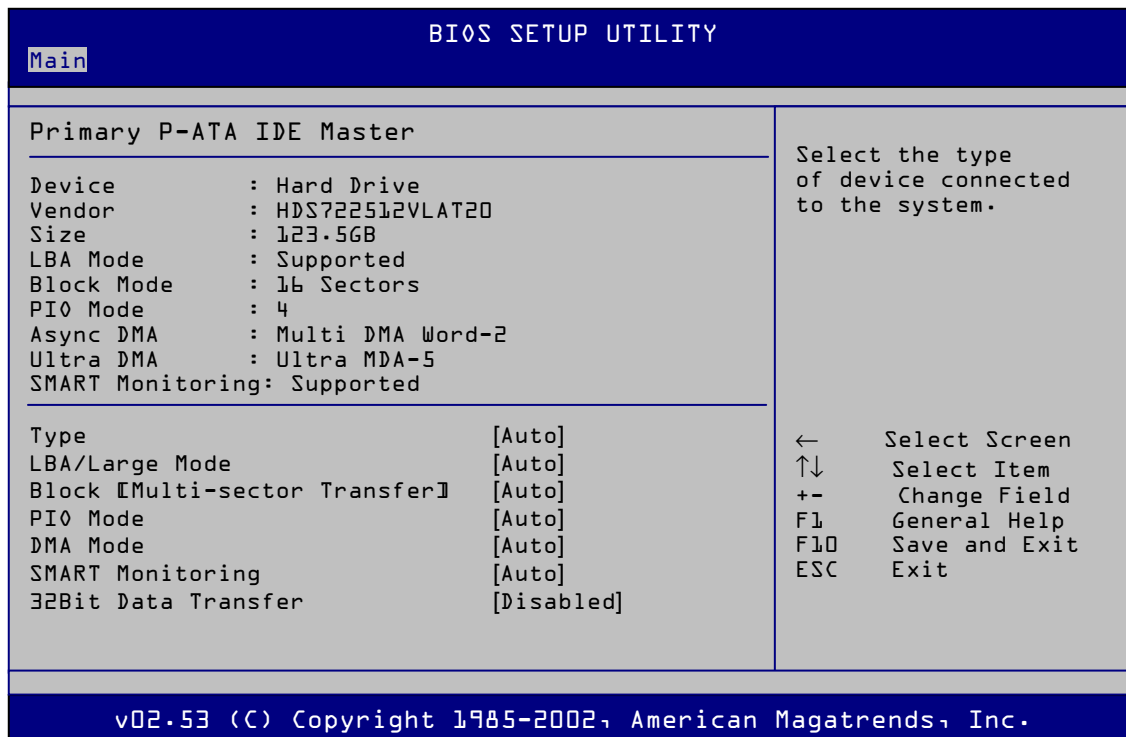


Figure 32: Main / Primary P-ATA IDE Master or Slave Sub-menu

A detailed description of each of the features is given in the following table.

Table 33: Main/Primary P-ATA IDE Master or Slave Sub-menu

Feature	Options	Description
Device	none	Displays detected device connected
Vendor	none	Displays the detected vendor name and model of device
LBA Mode	none	Displays the detected translation mode or set by user
Block Mode	none	Displays the detected Block mode or set by user
PIO Mode	none	Displays the detected PIO mode or set by user
Async DMA	none	Displays the detected asynchronous DMA mode or set by user
Ultra DMA	none	Displays the detected Ultra DMA mode or set by user
SMART Monitoring	none	Displays SMART monitoring support
Type	<ul style="list-style-type: none"> • Not Installed • Auto [Default] • CDROM • ARMD 	Specifies the IDE configuration mode for IDE devices <i>User</i> allows capabilities to be changed <i>Auto</i> fills-in capabilities from ATA/ATAPI devices

LBA/ Large Mode	<ul style="list-style-type: none"> • Disabled • Auto [Default] 	Displays whether automatic translation mode is enabled from the hard disk (This item is read only unless Type is set to <i>User</i>)
Block [Multi-sector Transfer]	<ul style="list-style-type: none"> • Disabled • Auto [Default] 	Displays whether automatic multiple sector data transfers are enabled (This item is read-only unless Type is set to <i>User</i>)
PIO Mode	<ul style="list-style-type: none"> • Auto [Default] • 0 • 1 • 2 • 3 • 4 	Sets the PIO mode (This item is read-only unless Type is set to <i>User</i>)
DMA Mode	<ul style="list-style-type: none"> • Auto [Default] • SWDMA0 • SWDMA1 • SWDMA2 • MWDMA0 • MWDMA0 • MWDMA1 • MWDMA2 • UDMA 0 • UDMA 1 • UDMA 2 • UDMA 3 • UDMA 4 • UDMA 5 	Specifies the DMA mode for the drive <i>Auto</i> = Auto-detected <i>SWDMA_n</i> = Single Word DMA _n <i>SWDMA_n</i> = Multi Word DMA _n <i>UDMA_n</i> = Ultra DMA _n (This item is read-only unless Type is set to <i>User</i>)
SMART Monitoring	<ul style="list-style-type: none"> • Auto [Default] • Disabled • Enabled 	Enables/disables S.M.A.R.T. (Self Monitoring Analysis and Reporting Technologies) (This Item is read-only unless Type is set to <i>User</i>)
32Bit Data Transfer	<ul style="list-style-type: none"> • Disabled [Default] • Enabled 	Enables/disables 32Bit data transfer (This Item is read-only unless Type is set to <i>User</i>)

Main / Secondary P-ATA IDE Master or Slave Sub-menu

This menu shows a detected hard drive or CD-ROM drive features and allows configuration settings to be made. The example is of a CD-ROM drive.

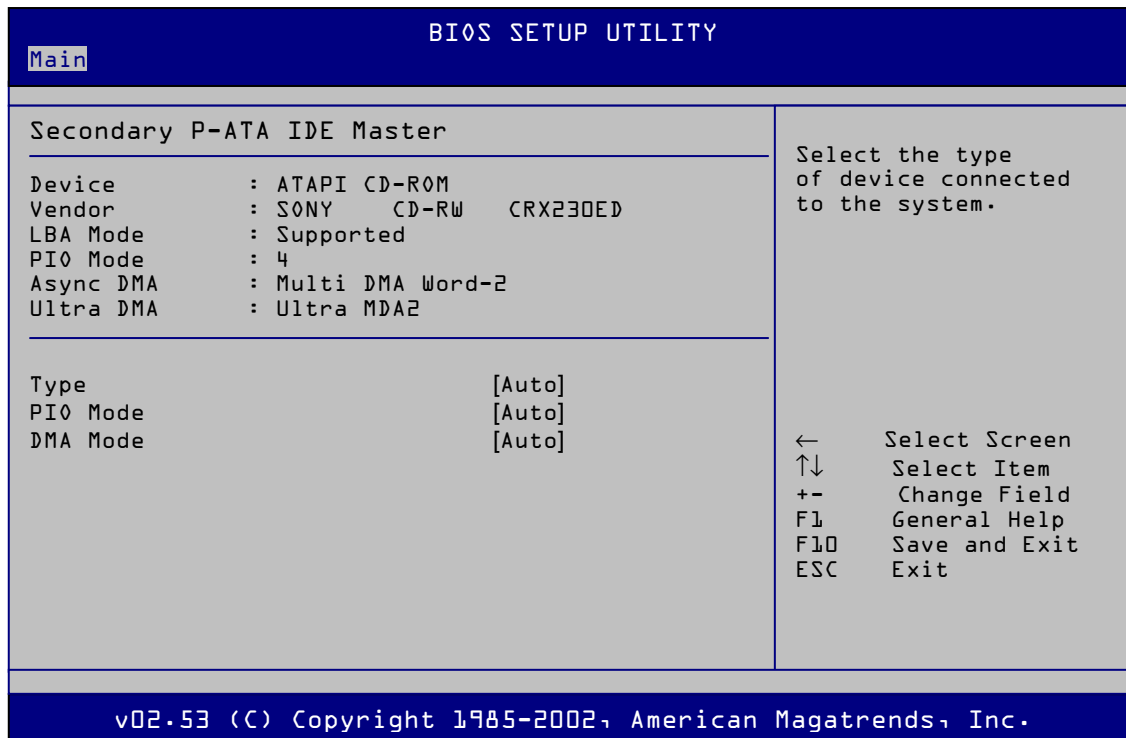


Figure 33: Main / Secondary P-ATA IDE Master or Slave sub menu

A detailed description of each of the features is given in the following table.

Table 34: Main / Secondary P-ATA IDE Master or Slave Sub-menu

Feature	Options	Description
Device	none	Displays detected device connected
Vendor	none	Displays the detected vendor name and model of device
LBA Mode	none	Displays the detected translation mode or set by user
Block Mode	none	Displays the detected Block mode or set by user
PIO Mode	none	Displays the detected PIO mode or set by user
Async DMA	none	Displays the detected asynchronous DMA mode or set by user
Ultra DMA	none	Displays the detected asynchronous Ultra DMA mode or set by user
Type	<ul style="list-style-type: none"> • Not Installed • Auto [Default] • CDROM • ARMD 	<p>Specifies the IDE configuration mode for IDE devices</p> <p><i>User</i> allows capabilities to be changed</p> <p><i>Auto</i> fills-in capabilities from ATA/ATAPI devices</p>

PIO Mode	<ul style="list-style-type: none"> • Auto [Default] • 0 • 1 • 2 • 3 • 4 	<p>Sets the PIO mode (This item is read-only unless Type is set to <i>User</i>)</p>
DMA Mode	<ul style="list-style-type: none"> • Auto [Default] • SWDMA0 • SWDMA1 • SWDMA2 • MWDMA0 • MWDMA0 • MWDMA1 • MWDMA2 • UDMA 0 • UDMA 1 • UDMA 2 	<p>Specifies the DMA mode for the drive</p> <p><i>Auto</i> = Auto-detected <i>SWDMA_n</i> = Single Word DMA_n <i>SWDMA_n</i> = Multi Word DMA_n <i>UDMA_n</i> = Ultra DMA_n</p> <p>(This item is read-only unless Type is set to <i>User</i>)</p>

Main menu / IDE Configuration Sub-menu

This menu shows the IDE controller configuration.

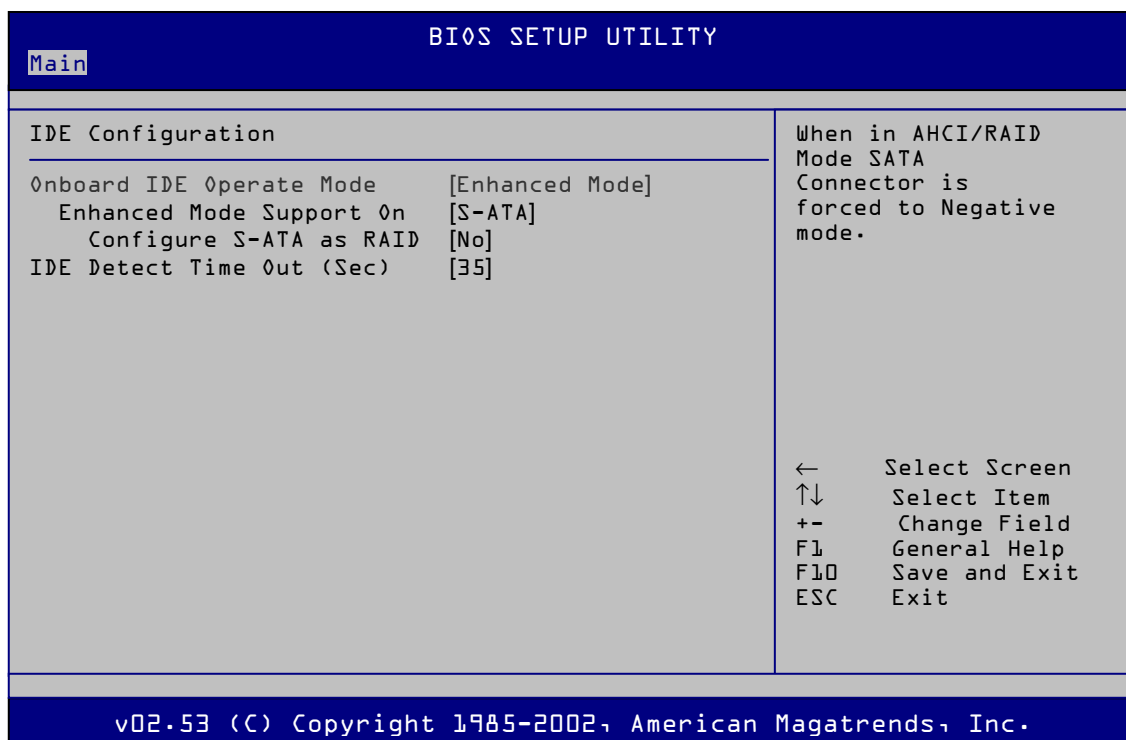


Figure 34: IDE Configuration Sub-menu

A detailed description of each of the features is given in the following table.

Table 35: IDE Configuration Sub-menu

Feature	Options	Description
Device	<ul style="list-style-type: none"> • Enhance Mode [Default] • Compatibly Mode 	Enhanced mode allows the translation of all P-ATA and S-ATA port devices under Windows 2000 Pro and Windows XP. Compatibility is required for S-ATA devices under DOS.
Enhanced mode support On	<ul style="list-style-type: none"> • S-ATA [Default] • P-ATA + S-ATA • P-ATA 	Defines the S-ATA and P-ATA ports translated under enhanced mode as required.
Configure S-ATA as RAID	<ul style="list-style-type: none"> • Yes • No [Default] 	RAID enable option for S-ATA devices. Once enabled devices are configured under controller boot option during BIOS POST boot. Press <ctrl> + A during BIOS post boot to configure RAID.
IDE Detect Time Out (Sec)	<ul style="list-style-type: none"> • 0 • 5 • 10 • 15 • 20 • 25 • 30 • 35 [Default] 	Hard drive pre delay time.

Main / System Information Sub-menu

This menu displays system information.

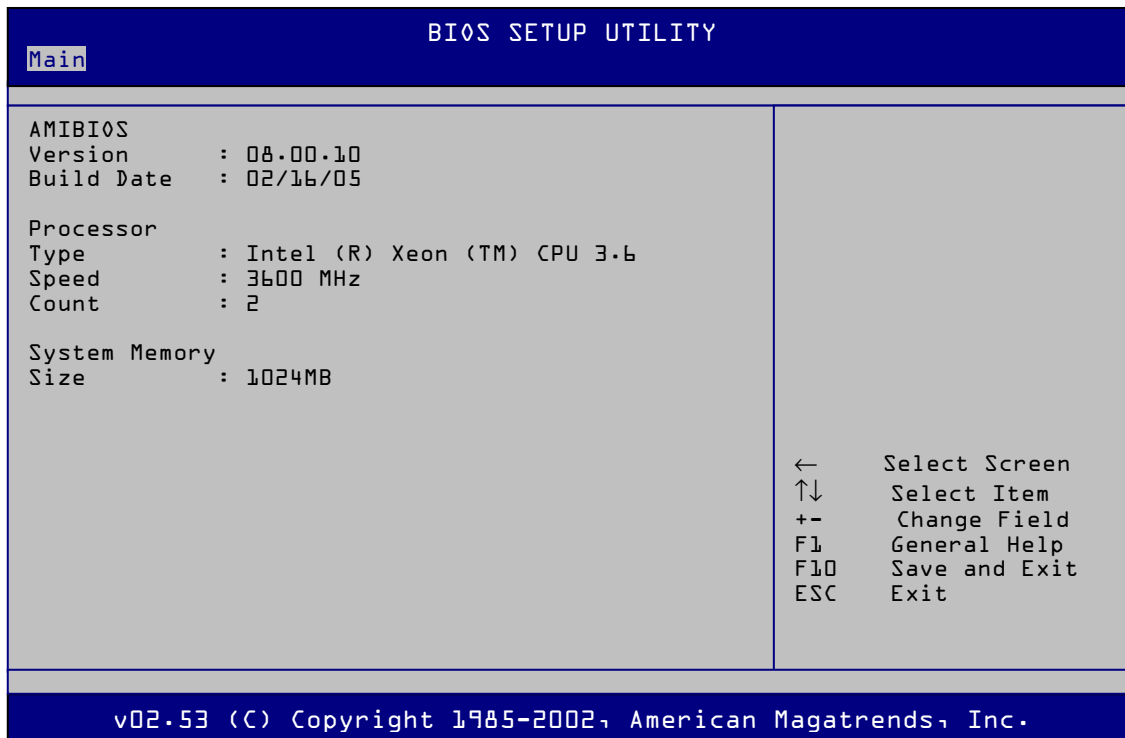


Figure 35: Main / System Information Sub-menu

A detailed description of each of the features is given in the following table.

Table 36: Main / System Information Sub-menu

Feature	Options	Description
Version	None	Note this is the BIOS Utility version not the BIOS version that is displayed during BIOS POST boot
Build Date	None	Note this is the BIOS Utility build date not the BIOS build date that is displayed during BIOS POST boot
Type	None	Displays CPU type installed
Speed	None	Displays CPU speed
Count	None	Displays the number of CPU's installed
Size	None	Displays the total system memory

Advanced menu

This menu is for access to configure advanced features.

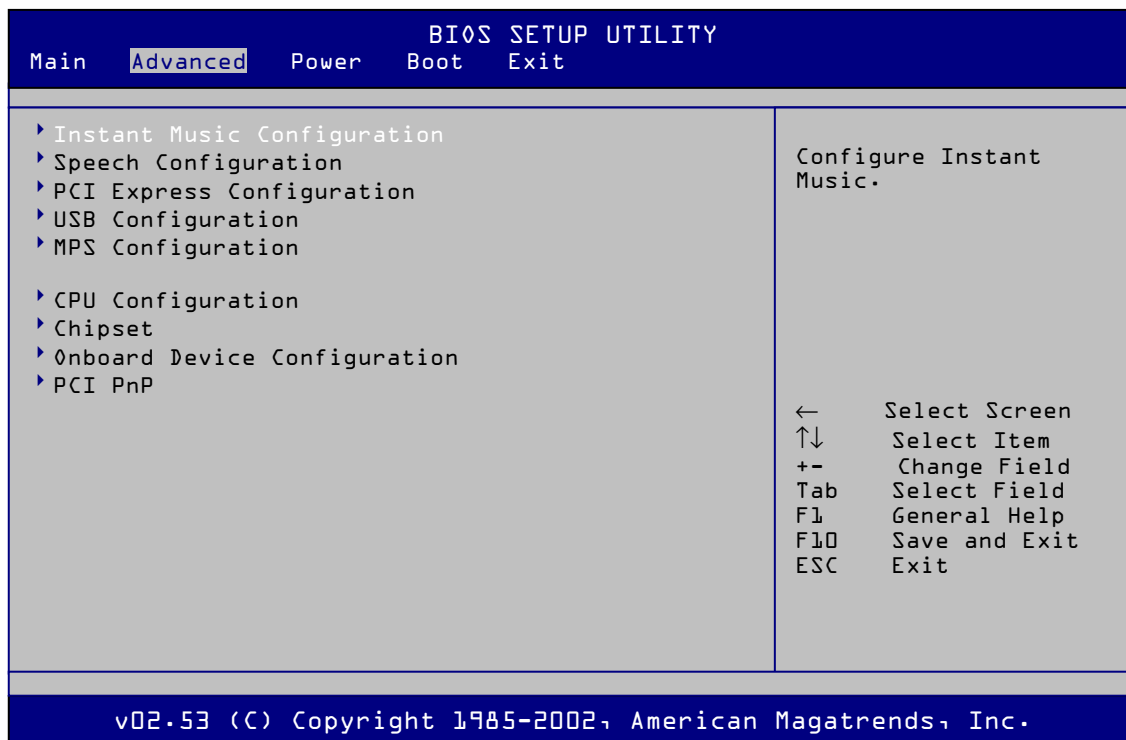


Figure 36: Advanced Menu

A detailed description of each of the features is given in the following table.

Table 37: Advanced menu

Feature	Options	Description
Instant Music Configuration	None	Not supported.
Speech Configuration	None	Sub menu for speech configuration Press <Enter> to view this Sub menu
PCI Express Configuration	None	Sub menu for PCI Express configuration Press <Enter> to view this Sub menu
USB Configuration	None	Sub menu for USB configuration Press <Enter> to view this Sub menu
MPS Configuration	None	Sub menu for MPS configuration Press <Enter> to view this Sub menu
CPU Configuration	None	Sub menu for CPU configuration Press <Enter> to view this Sub menu
Chipset	None	Sub menu for chipset configuration Press <Enter> to view this Sub menu
Onboard Device Configuration	None	Sub menu for onboard device configuration Press <Enter> to view this Sub menu
PCI PnP	None	Sub menu for PCI PnP Press <Enter> to view this Sub menu

Advanced / Speech Configuration Sub-menu

This menu allows configuration of speech options.

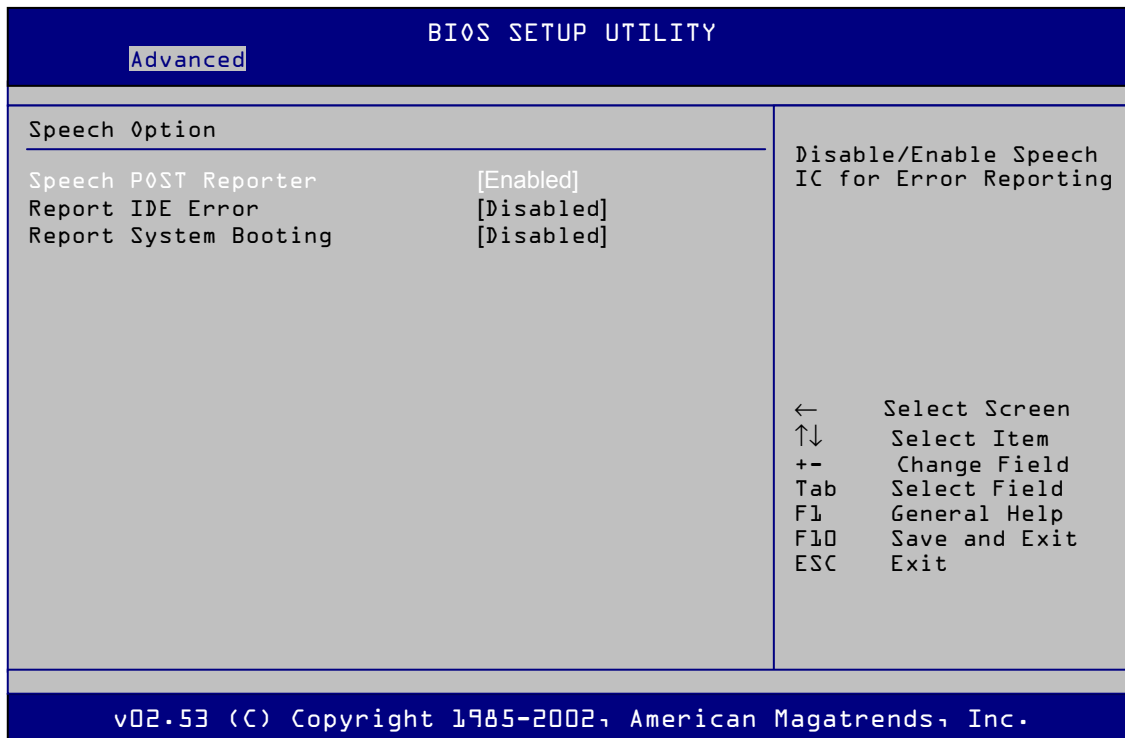


Figure 37: Advanced / Speech Configuration Sub-menu

A detailed description of each of the features is given in the following table.

Table 38: Advanced / Speech Configuration sub menu

Feature	Options	Description
Speech Post Reporter	<ul style="list-style-type: none"> Disabled Enabled [Default] 	.BIOS post error audio speech enabled, via onboard audio.
Report IDE Error	<ul style="list-style-type: none"> Disabled [Default] Enabled 	Reports IDE error via onboard audio
Report System Booting	<ul style="list-style-type: none"> Disabled [Default] Enabled 	Reports system booting error via onboard audio

Note: for all the options above Speakers must be connected to onboard sound during BIOS POST boot.

Advanced / PCI Express Configuration Sub-menu

The menu below allows the configuration of the PCI-Express LAN

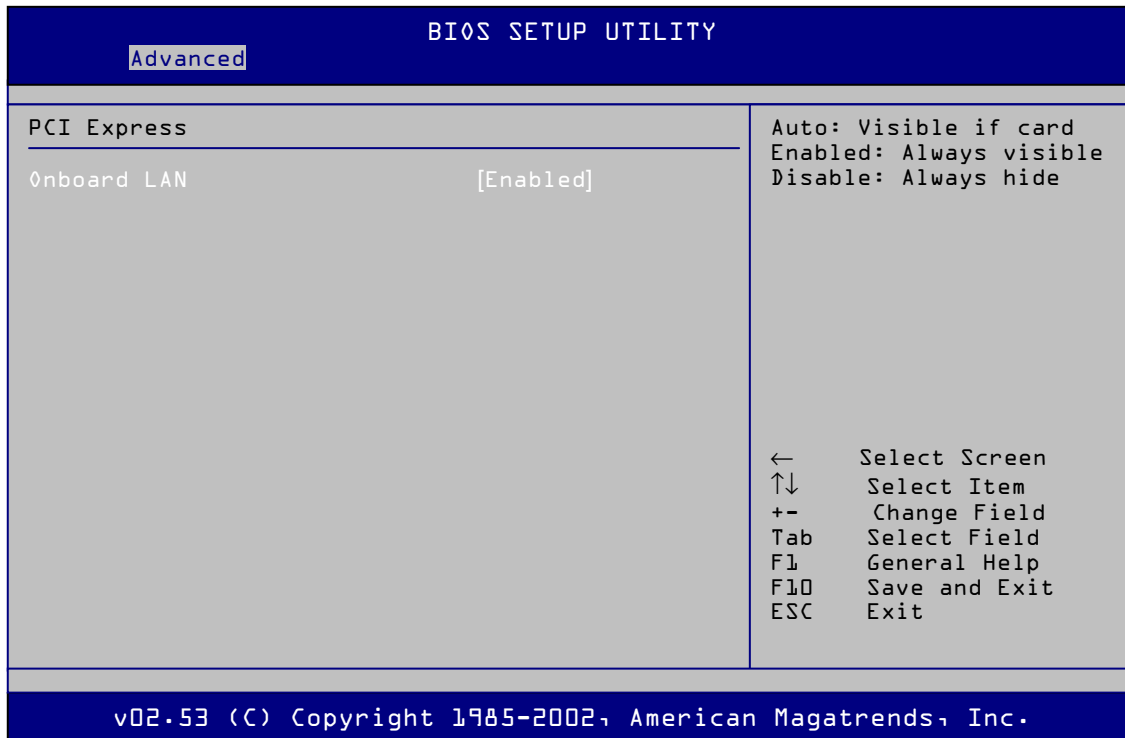


Figure 38: Advanced / PCI Express Configuration sub menu

A detailed description of each of the features is given in the following table.

Table 39: Advanced / PCI Express Configuration sub menu

Feature	Options	Description
Onboard LAN	<ul style="list-style-type: none"> Disabled Enabled [Default] 	. Enables or disables onboard LAN

Advanced / USB Configuration Sub-menu

This menu allows USB controller configuration

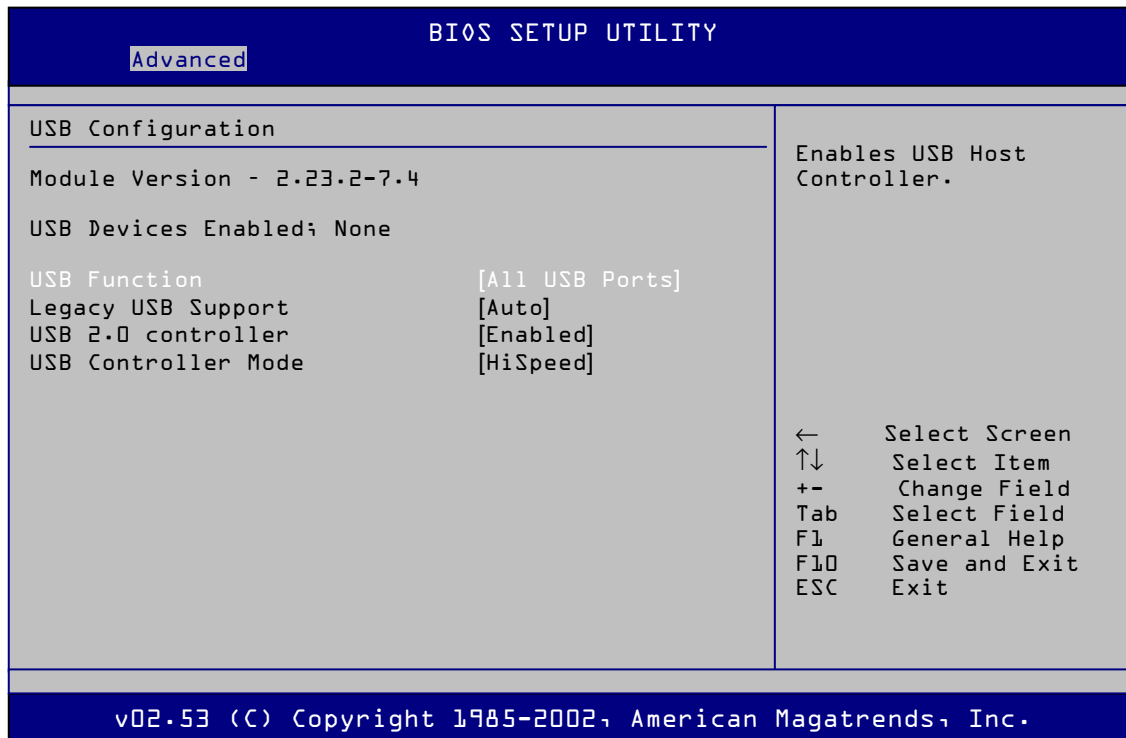


Figure 39: Advanced / USB Configuration sub menu

A detailed description of each of the features is given in the following table.

Table 40: Advanced / USB Configuration sub menu

Feature	Options	Description
USB Function	<ul style="list-style-type: none"> Disabled All USB Ports [Default] 2 USB Ports 	Allows enable or disable the USB function.
Legacy USB Support	<ul style="list-style-type: none"> Disabled Enabled Auto [Default] 	Allows the system to detect the presence of USB devices at start up. If detected, the USB controller legacy mode is enabled. If no USB device is detected, the legacy USB support is disabled.
USB 2.0 controller	<ul style="list-style-type: none"> Enabled [Default] Auto Disabled 	Allows you to enable or disable the USB 2.0 controller.
USB Controller Mode	<ul style="list-style-type: none"> Hi Speed [Default] Full Speed 	Allows the USB 2.0 controller mode to HiSpeed (480 Mbps) or FullSpeed (12 Mbps).

Advanced / MPS Configuration Sub-menu

This menu allows the Multi-Processor Table to be configured.

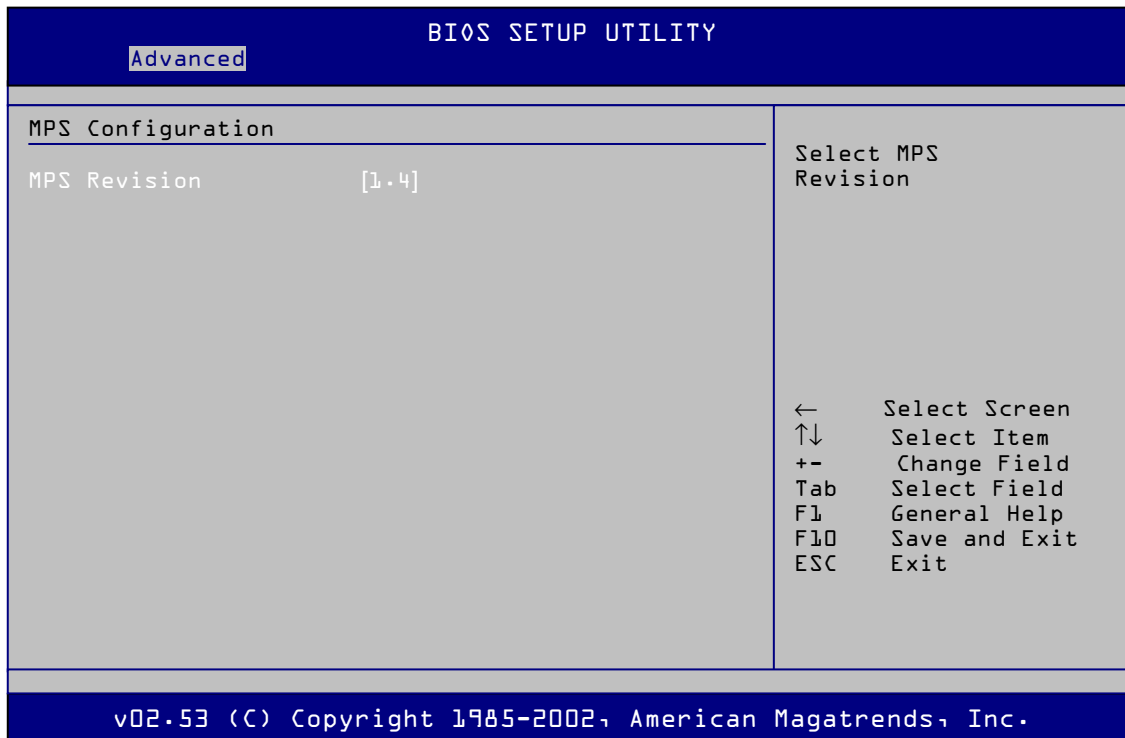


Figure 40: Advanced / MPS Configuration sub menu

A detailed description of each of the features is given in the following table.

Table 41: Advanced / MPS Configuration sub menu

Feature	Options	Description
MPS Revision	<ul style="list-style-type: none"> • 1.4 [Default] • 1.1 	Allows selection of the multi-processor system revision.

Advanced / CPU Configuration Sub-menu

This menu configures the CPU settings

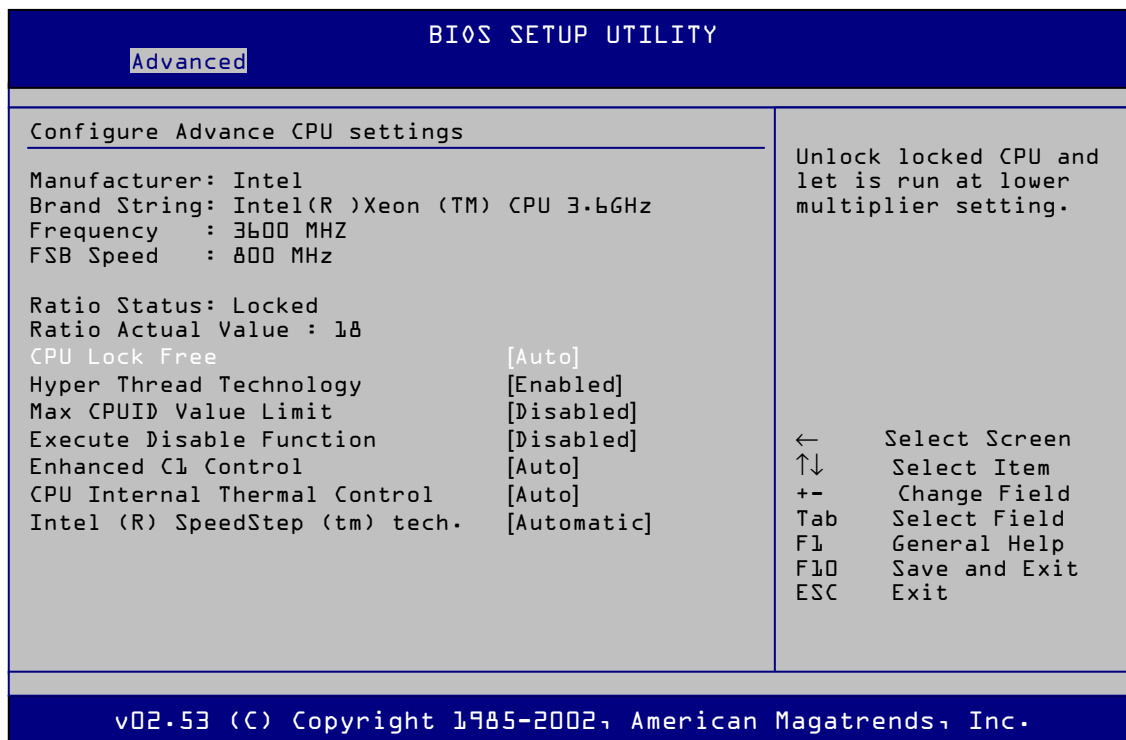


Figure 41: Advanced / CPU Configuration Sub-Menu

A detailed description of each of the features is given in the following table.

Table 42: Advanced / CPU Configuration Sub-menu

Feature	Options	Description
CPU Lock Free	<ul style="list-style-type: none"> • Auto [Default] • Disabled • Enabled 	Not supported, allows setting CPU clock to lower than fixed value not recommended.
Hyper Thread Technology	<ul style="list-style-type: none"> • Disabled • Enable [Default] 	Allows enable or disable the processor Hyper-Threading Technology.
Max CPUID Value Limit	<ul style="list-style-type: none"> • Disabled [Default] • Enable 	Enabled allows legacy operating systems to boot even without support for CPUs with extended CPUID functions.
Execute Disable Function	<ul style="list-style-type: none"> • Disabled [Default] • Enable 	Allows enable or disable the processor execute disable function.
Enhanced C1 Control	<ul style="list-style-type: none"> • Auto [Default] • Disabled 	Allows enable or disable the processor Enhanced C1 control function.
CPU Internal Thermal Control	<ul style="list-style-type: none"> • Auto [Default] • Disabled 	CPU Internal Thermal Control. It is not recommended to disable this feature.

Intel (R) SpeedStep (tm) tech.	<ul style="list-style-type: none"> • Maximum Speed • Minimum Speed • Automatic [Default] • Disabled 	CPU Intel (R) SpeedStep (tm) tech Control. <i>It is not recommended to disable this feature.</i>
--------------------------------	--	--

Advanced / Chipset Sub-menu

This menu allows the configuration of chipset features

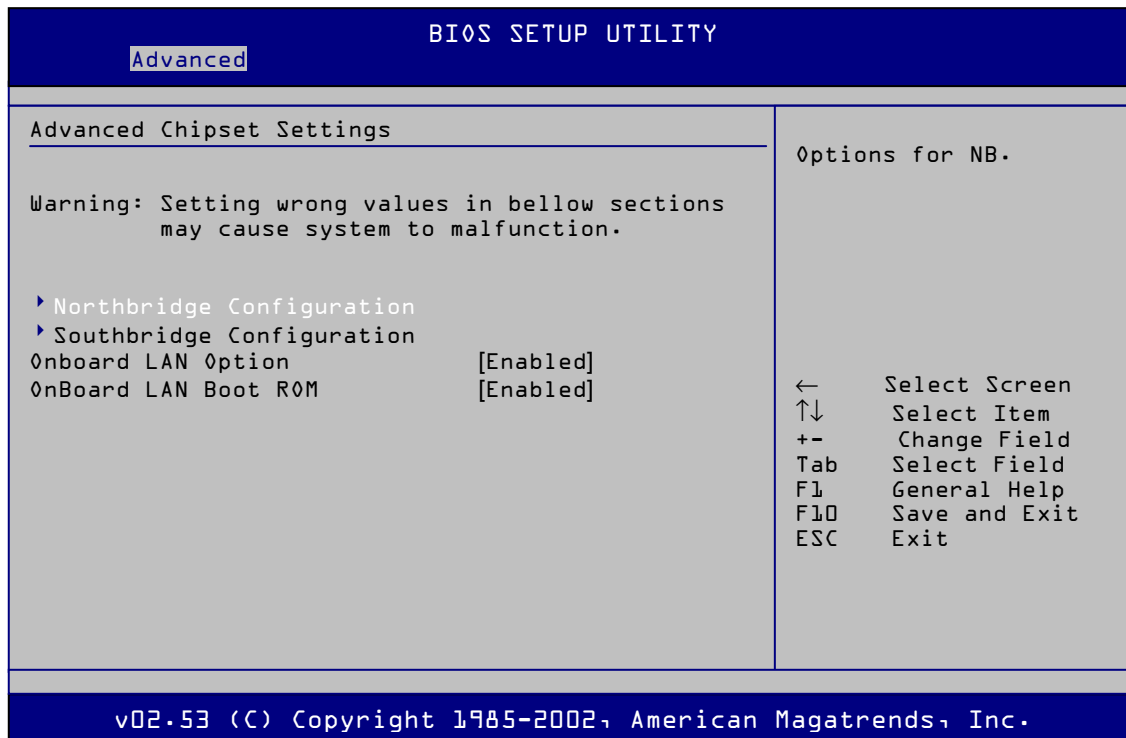


Figure 42: Advanced / Chipset Sub-menu

A detailed description of each of the features is given in the following table.

Table 43: Advanced / Chipset Sub-menu

Feature	Options	Description
Northbridge Configuration	None	Press <Enter> to view this Sub menu
Southbridge Configuration	None	Press <Enter> to view this Sub menu
Onboard LAN Option	<ul style="list-style-type: none"> • Enable [Default] • Disable 	Onboard LAN enable disable
Onboard LAN Boot ROM	<ul style="list-style-type: none"> • Enable [Default] • Disabled 	Onboard LAN boot ROM enable disable <i>Note: if disabled LAN will not function under DOS or other none PnP OS.</i>

Advanced / Northbridge Configuration Sub-menu

This menu configures Northbridge options

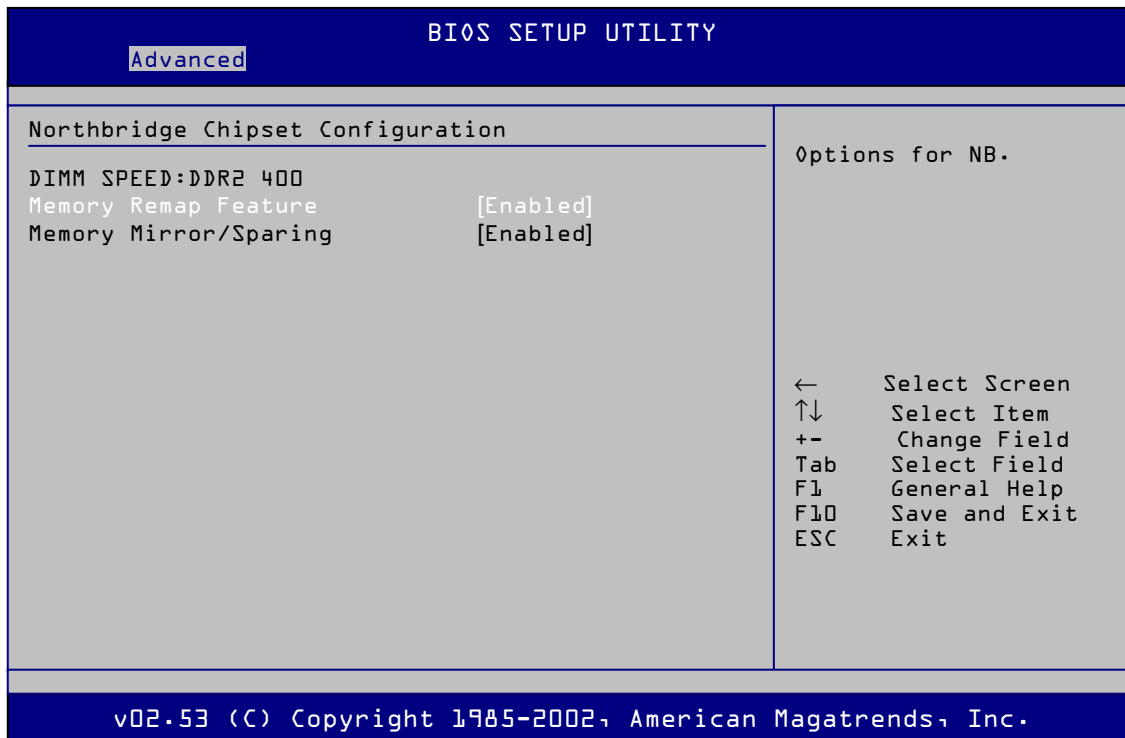


Figure 43: Advanced / Northbridge Configuration Sub-menu

A detailed description of each of the features is given in the following table.

Table 44: Advanced / Northbridge Configuration Sub-menu

Feature	Options	Description
DIMM Speed	None	Displays DDR2 DIMM speed detected
Memory Remap Feature	<ul style="list-style-type: none"> • Enabled [Default] • Disable 	Allows remapping the overlap PCI memory over the total physical memory.
Memory Mirror/Sparing	<ul style="list-style-type: none"> • Disabled Default] • Mirroring • Sparing 	Allows memory RAS mirroring or sparing.

Advanced / Southbridge configuration Sub-menu

This menu allows the configuration of Southbridge options

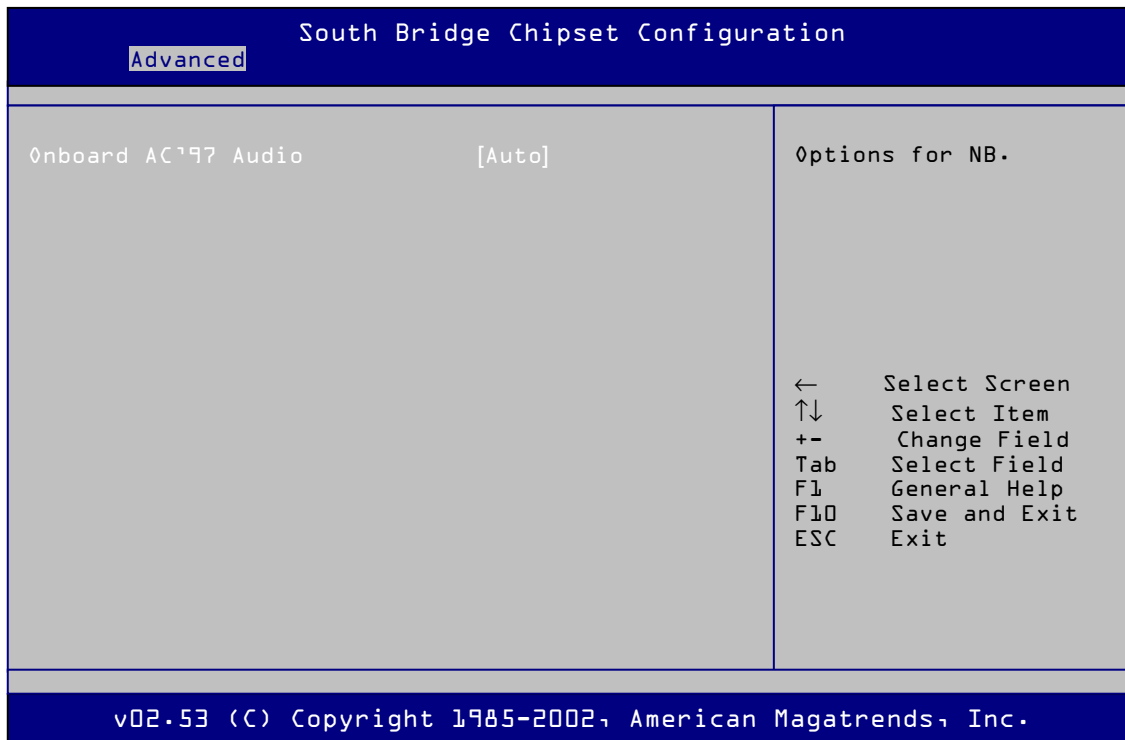


Figure 44: Advanced / Southbridge configuration Sub-menu

A detailed description of each of the features is given in the following table.

Table 45: Advanced / Southbridge configuration Sub-menu

Feature	Options	Description
Onboard AC'97 Audio	<ul style="list-style-type: none">• Auto Default]• Disabled	Onboard audio configuration

Advanced / Onboard Device Configuration Sub-menu

This menu configures the serial, parallel and game port.

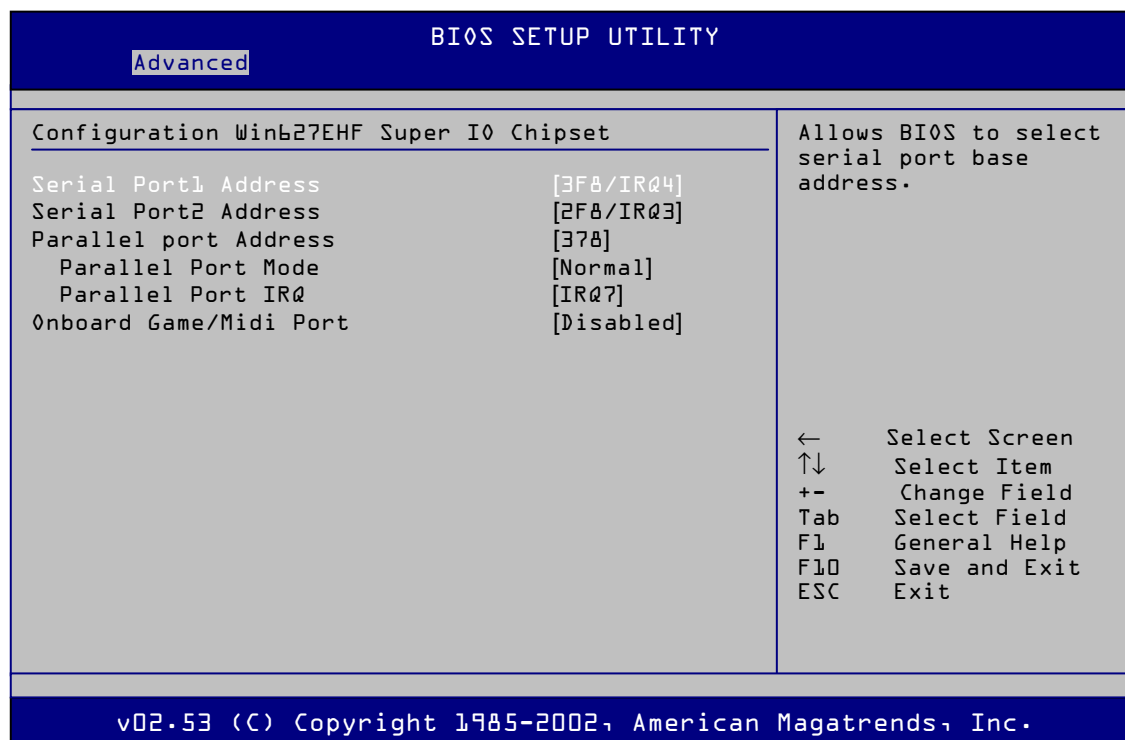


Figure 45: Advanced / Onboard Device Configuration Sub-menu

A detailed description of each of the features is given in the following table.

Table 46: Advanced / Onboard Device Configuration Sub-menu

Feature	Options	Description
Serial Port1 Address	<ul style="list-style-type: none"> • Disabled • 3F8/IRQ4 [Default] • 3F8/IRQ4 • 2F8/IRQ3 	Serial port system resource setting or disable
Serial Port2 Address	<ul style="list-style-type: none"> • Disabled • 2F8/IRQ3 [Default] • 3E8/IRQ4 • 2E8/IRQ3 	Serial port system resource setting or disable
Parallel Port Address	<ul style="list-style-type: none"> • Disabled • 378 [Default] • 278 • 3BC 	Parallel port system resource setting or disable

Parallel Port Mode	<ul style="list-style-type: none"> • Normal [Default] • Bi-Directional • EPP • ECP 	Additional Parallel port system resource setting <i>IF Parallel Port Address is set to "Disabled" this option will not be shown</i>
Parallel Port IRQ	<ul style="list-style-type: none"> • IRQ5 • IRQ7 [Default] 	Additional Parallel port system resource setting <i>IF Parallel Port Address is set to "Disabled" this option will not be shown</i>
Onboard Game/Midi Port	<ul style="list-style-type: none"> • Disabled [Default] • 200/300 • 200/330 • 208/300 • 208/330 	Onboard Game/Midi Port system resource setting or disable

Advanced / PCI PnP Sub-menu

This menu allows advanced configuration of PCI BUS

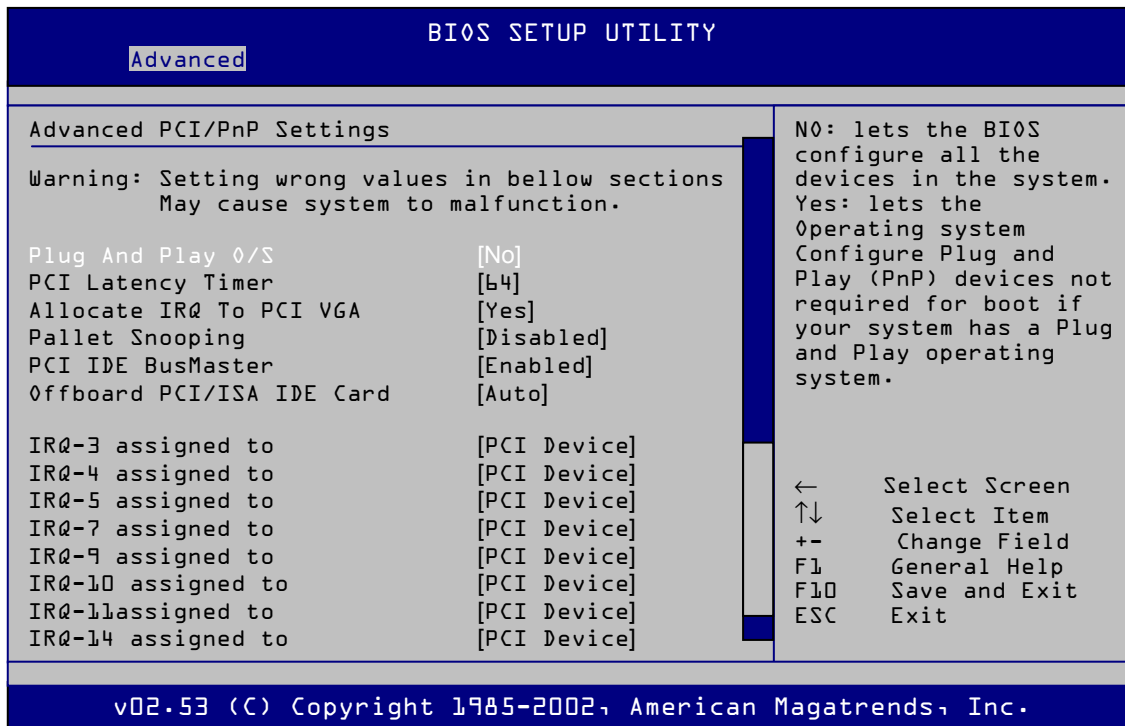


Figure 46a: Advanced / PCI PnP Sub-Menu

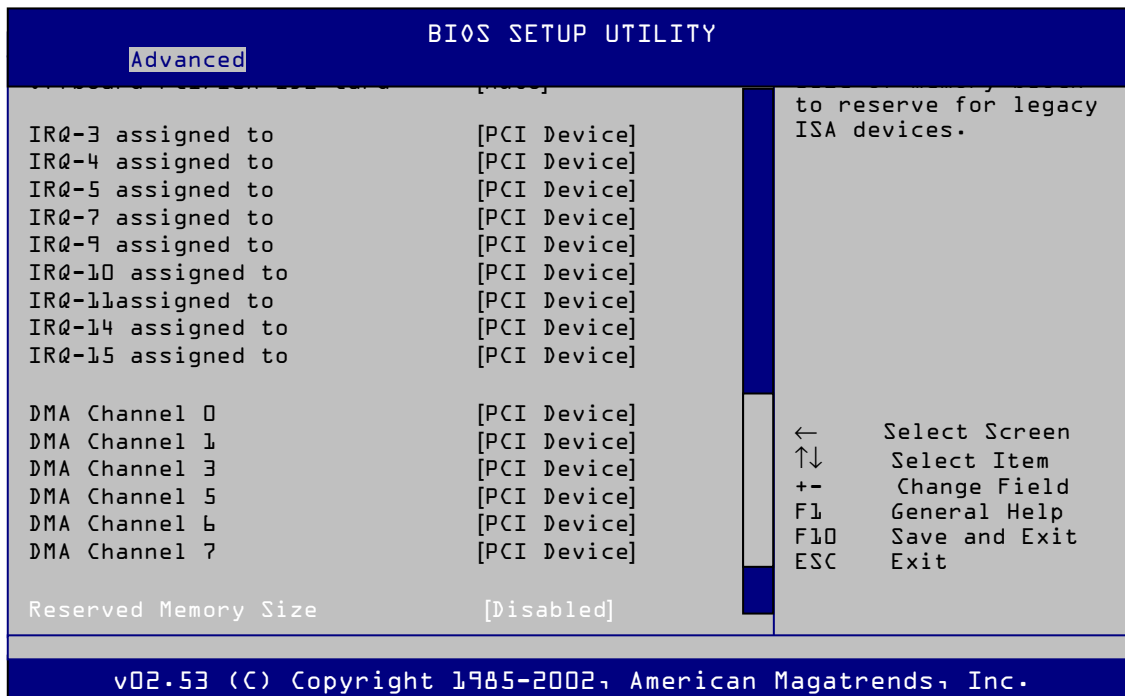


Figure 46b: Advanced / PCI PnP Sub-menu (use arrow keys to view all of menu items as above)

A detailed description of each of the features is given in the following table.

Table 47: Advanced / PCI PnP Sub-menu

Feature	Options	Description
Plug And Play O/S	<ul style="list-style-type: none"> • NO [Default] • Yes 	PnP play OS setting if set to “NO” the BIOS configures system resources, otherwise resources are set by PnP OS.
PCI Latency Timer	<ul style="list-style-type: none"> • 32 • 64 [Default] • 96 • 128 • 160 • 192 • 224 • 248 	Allows the value in units of PCI clocks for the PCI device latency timer register.
Allocate IRQ To PCI VGA	<ul style="list-style-type: none"> • Yes [Default] • No 	When set to [Yes], BIOS assigns an IRQ to PCI VGA card if the card requests for an IRQ. When set to [No]. <i>It is not recommended this is set to “NO”</i>
Pallet Snooping	<ul style="list-style-type: none"> • Disabled [Default] • Enabled 	Support for legacy Video capture cards. <i>It is not recommended this is set to “Enabled”</i>
PCI IDE BusMaster	<ul style="list-style-type: none"> • Disabled • Enabled [Default] 	PCI bus master control. <i>It is not recommended this is set to “Disabled”</i>
Offboard PCI/ISA IDE Card	<ul style="list-style-type: none"> • Auto [Default] • PCI Slot1 • PCI Slot2 • PCI Slot3 • PCI Slot4 • PCI Slot5 • PCI Slot6 	Allows assignment of a PCI slot to a PCI IDE card, when required.
IRQ-3 assigned to To IRQ-15 assigned to	<ul style="list-style-type: none"> • PCI Device [Default] • Reserved 	When set to [PCI Device], the specific IRQ is free for use of PCI/PnP devices. When set to [Reserved], the IRQ is reserved for legacy ISA devices.
DMA Channel 0 to DMA Channel 7	<ul style="list-style-type: none"> • PCI Device [Default] • Reserved 	When set to [PCI Device], the specific DMA channel is free for use of PCI/PnP devices. When set to [Reserved], the DMA channel is reserved for Legacy ISA devices.
Reserved Memory Size	<ul style="list-style-type: none"> • Disabled [Default] • 16k • 32k • 64k 	Allows you to set the reserved memory size. Some adaptors with ROM options may require memory to be reserved.

Power Menu

This menu configures power management

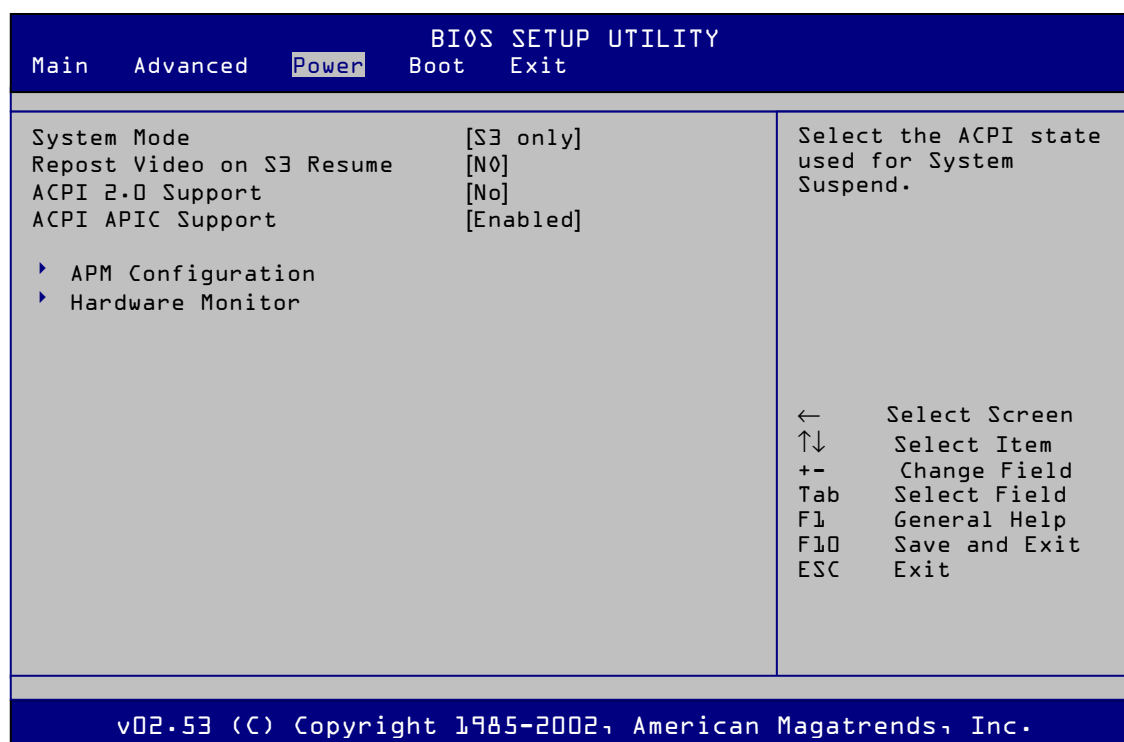


Figure 47: Power Menu

A detailed description of each of the features is given in the following table.

Table 48: Power Menu

Feature	Options	Description
System Mode	<ul style="list-style-type: none"> S1 (POS) only S3 only [Default] 	Configures standby power mode, S1 suspend or S3 suspend to RAM. Note: Windows 2000 Pro does not support S1
Repost Video on S3 Resume	<ul style="list-style-type: none"> No [Default] Yes 	Some VGA cards may require "Repost Video on S3 Resume" signal after suspend.
ACPI 2.0 Support	<ul style="list-style-type: none"> No [Default] Yes 	Enables Advanced Configuration and Power Interface (ACPI) 2.0 specifications.
ACPI APIC Support	<ul style="list-style-type: none"> Enabled [Default] Disabled 	Enable or disable the Advanced Configuration and Power Interface (ACPI) support
APM Configuration	None	Power management device configuration Press <Enter> to view this Sub menu
Hardware Monitor	None	Hardware monitor device configuration Press <Enter> to view this Sub menu

Power / APM Configuration Sub-menu

This menu allows the configuration of APM features

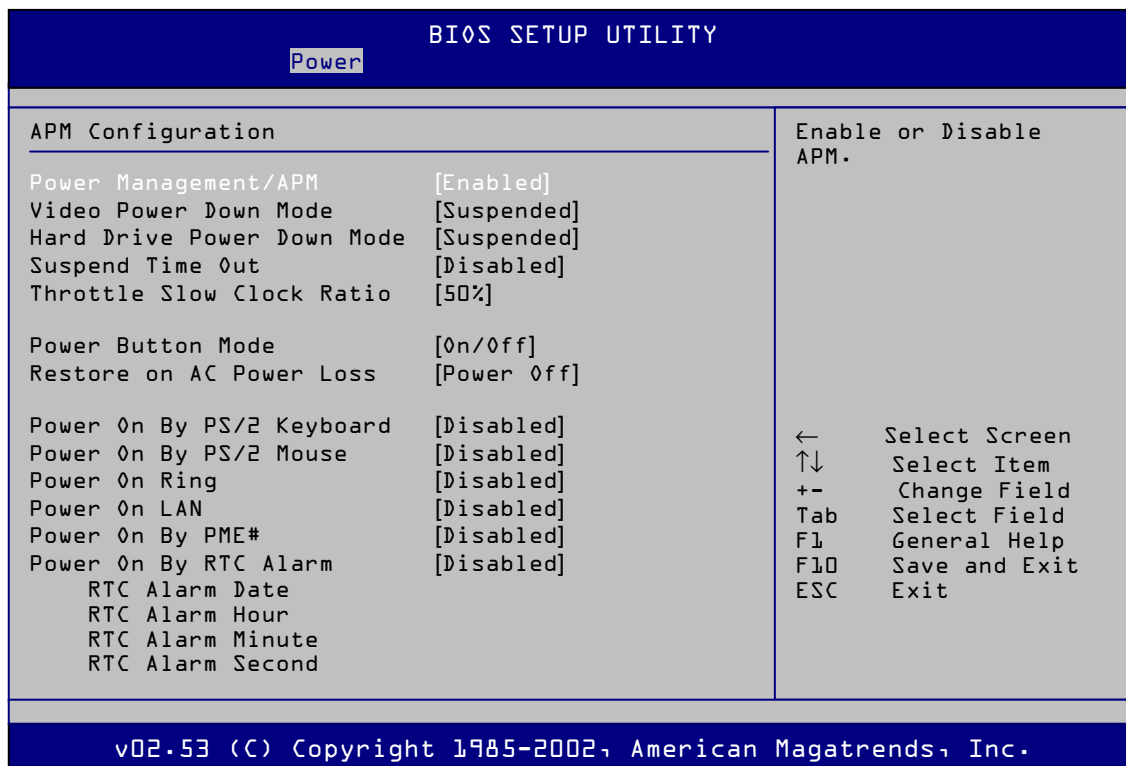


Figure 48: Power / APM Configuration Sub-menu

A detailed description of each of the features is given in the following table.

Table 49: Power / APM Configuration Sub-menu

Feature	Options	Description
Power Management/APM	<ul style="list-style-type: none"> Disabled Enabled [Default] 	Enables or disables advanced power management
Video Power Down Mode	<ul style="list-style-type: none"> Disabled Standby Suspended [Default] 	Defines video power down state
Hard Drive Power Down Mode	<ul style="list-style-type: none"> Disabled Standby Suspended [Default] 	Defines hard drive power down state in standby or suspend.

Suspend Time Out	<ul style="list-style-type: none"> • Disabled [Default] • 1 min • 2 min • 4 min • 8 min • 10 min • 20 min • 30 min • 40 min • 50 min • 60 min 	Defines suspend time controlled by motherboard
Throttle Slow Clock Ratio	<ul style="list-style-type: none"> • 87.5% • 75% • 62.5% • 50% [Default] • 37.5% • 25% • 12.5% 	Defines CPU throttle speed under power control state
Power Button Mode	<ul style="list-style-type: none"> • On/Off [Default] • Suspend 	Defines power button function
Restore on AC Power Loss	<ul style="list-style-type: none"> • Power Off [Default] • Power On • Last State 	Defines how motherboard will respond after power failure has been restored
Power On By PS/2 Keyboard	<ul style="list-style-type: none"> • Disabled [Default] • Enabled 	Power on by key board option
Power On By PS/2 Mouse	<ul style="list-style-type: none"> • Disabled [Default] • Enabled 	Power on by PS/2 Mouse option
Power On Ring	<ul style="list-style-type: none"> • Disabled [Default] • Enabled 	Power on by Modem Ring option
Power On LAN	<ul style="list-style-type: none"> • Disabled [Default] • Enabled 	Power on by LAN option
Power On By PME#	<ul style="list-style-type: none"> • Disabled [Default] • Enabled 	Power on by LAN PME# event option in soft off mode.
Power On By RTC Alarm	<ul style="list-style-type: none"> • Disabled [Default] • Enabled 	Power on by real time clock option
RTC Alarm Date	1 to 31 and Every day	Set on date option Note this will only be displayed if "Power On By RTC Alarm" is set to "Enabled"

RTC Alarm Hour	00 to 23	Set on hour option Note this will only be displayed if "Power On By RTC Alarm" is set to "Enabled"
RTC Alarm Minute	00 to 59	Set on minute option Note this will only be displayed if "Power On By RTC Alarm" is set to "Enabled"
RTC Alarm Second	00 to 60	Set on second option Note this will only be displayed if "Power On By RTC Alarm" is set to "Enabled"

Power / Hardware Monitor Sub-menu

This menu configures and shows hardware monitor features

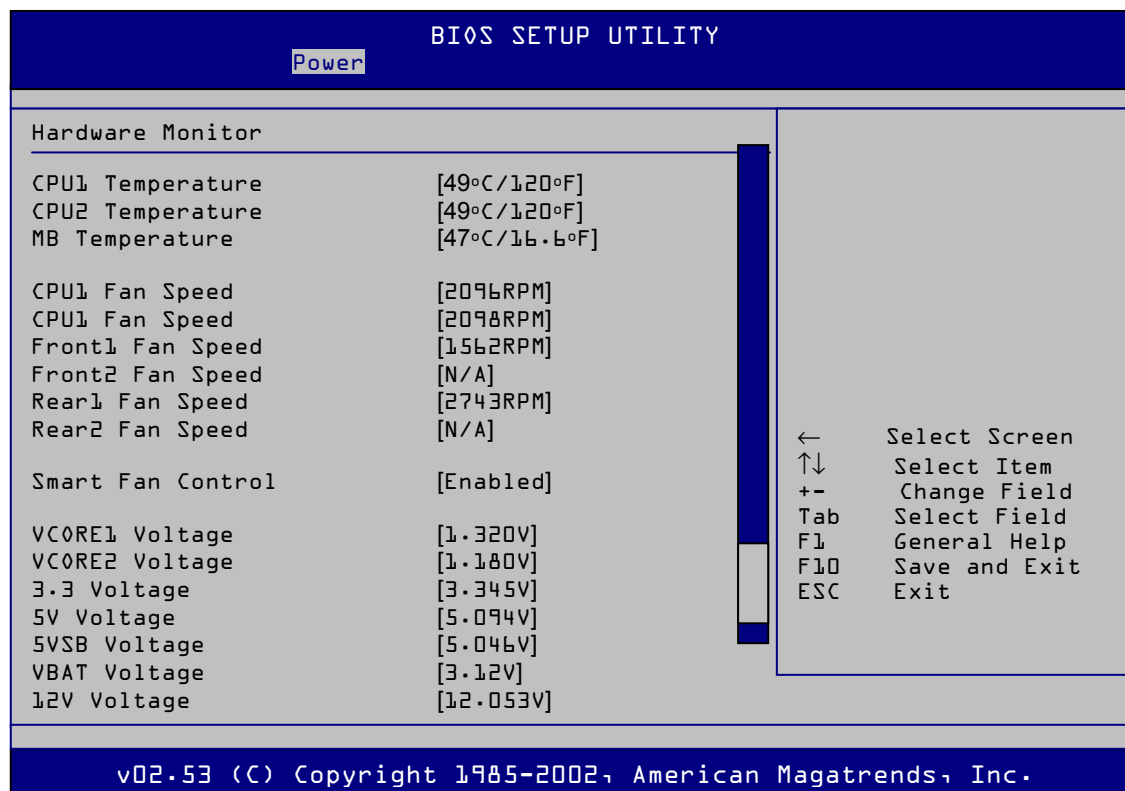


Figure 49: Power / Hardware Monitor Sub-menu

A detailed description of each of the features is given in the following table.

Table 50: Power / Hardware Monitor Sub-menu

Feature	Options	Description
CPU1 Temperature	<ul style="list-style-type: none"> • ??°C/???°F [Default] • Ignored 	Displays monitored CPU temperature or can be set to ignore
CPU2 Temperature	<ul style="list-style-type: none"> • ??°C/???°F [Default] • Ignored 	Displays monitored CPU temperature or can be set to ignore
MB Temperature	<ul style="list-style-type: none"> • ??°C/???°F [Default] • Ignored 	Displays monitored MB temperature or can be set to ignore
CPU1 Fan Speed	<ul style="list-style-type: none"> • ???RPM [Default] • Ignored 	Displays monitored CPU fan speed or can be set to ignore Note if a FAN is not detected "N/A" will be displayed instead of the "fan speed" RPM
CPU2 Fan Speed	<ul style="list-style-type: none"> • ???RPM [Default] • Ignored 	Displays monitored CPU fan speed or can be set to ignore Note if a FAN is not detected "N/A" will be displayed instead of the "fan speed" RPM

Front1 Fan Speed	<ul style="list-style-type: none"> • ????RPM [Default] • Ignored 	Displays monitored front1 fan speed or can be set to ignore Note if a FAN is not detected " N/A " will be displayed instead of the "fan speed" RPM
Front2 Fan Speed	<ul style="list-style-type: none"> • ????RPM [Default] • Ignored 	Displays monitored front2 fan speed or can be set to ignore Note if a FAN is not detected " N/A " will be displayed instead of the "fan speed" RPM
Rear1 Fan Speed	<ul style="list-style-type: none"> • ????RPM [Default] • Ignored 	Displays monitored rear1 fan speed or can be set to ignore Note if a FAN is not detected " N/A " will be displayed instead of the "fan speed" RPM
Rear2 Fan Speed	<ul style="list-style-type: none"> • ????RPM [Default] • Ignored 	Displays monitored rear2 fan speed or can be set to ignore Note if a FAN is not detected " N/A " will be displayed instead of the "fan speed" RPM
Smart Fan Control	<ul style="list-style-type: none"> • Enabled [Default] • Disabled 	Motherboard thermal control enable, this controls fan speeds according to CPU/s and MB temperature. This means the system runs at low noise level automatically
VCORE1 Voltage	<ul style="list-style-type: none"> • Ignored • ?..??V [Default] 	Displays monitored voltage or can be set to ignore
VCORE2 Voltage Loss	<ul style="list-style-type: none"> • Ignored • ?..??V [Default] 	Displays monitored voltage or can be set to ignore
3.3 Voltage	<ul style="list-style-type: none"> • Ignored • ?..??V [Default] 	Displays monitored voltage or can be set to ignore
5V Voltage	<ul style="list-style-type: none"> • Ignored • ?..??V [Default] 	Displays monitored voltage or can be set to ignore
5VSB Voltage	<ul style="list-style-type: none"> • Ignored • ?..??V [Default] 	Displays monitored voltage or can be set to ignore
VBAT Voltage	<ul style="list-style-type: none"> • Ignored • ?..??V [Default] 	Displays monitored voltage or can be set to ignore
12V Voltage	<ul style="list-style-type: none"> • Ignored • ?..??V [Default] 	Displays monitored voltage or can be set to ignore

Boot Menu

This menu configures boot options

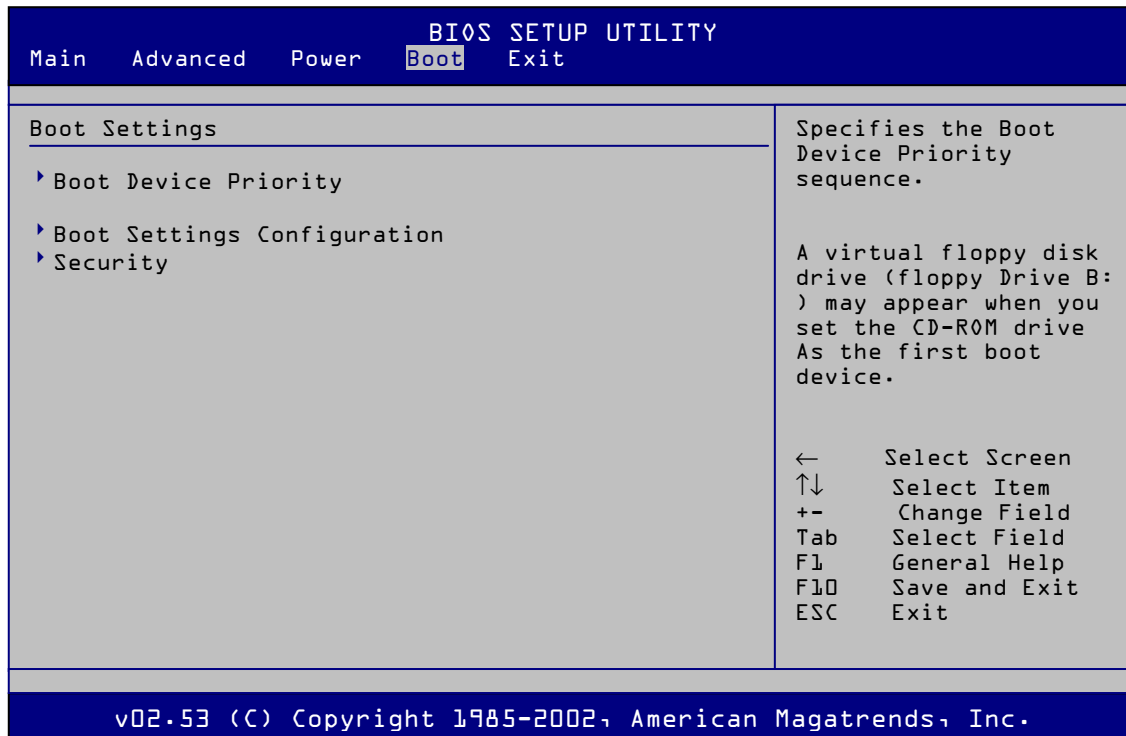


Figure 50: Boot Menu

A detailed description of each of the features is given in the following table.

Table 51: Boot Menu

Feature	Options	Description
Boot Device Priority	None	Boot device priority select sub menu Press <Enter> to view this Sub menu
Boot Settings Configuration	None	Boot Settings Configuration sub menu Press <Enter> to view this Sub menu
Security	None	Security sub menu Press <Enter> to view this Sub menu

Boot / Boot device Priority Sub-menu

This menu configures boot device priority

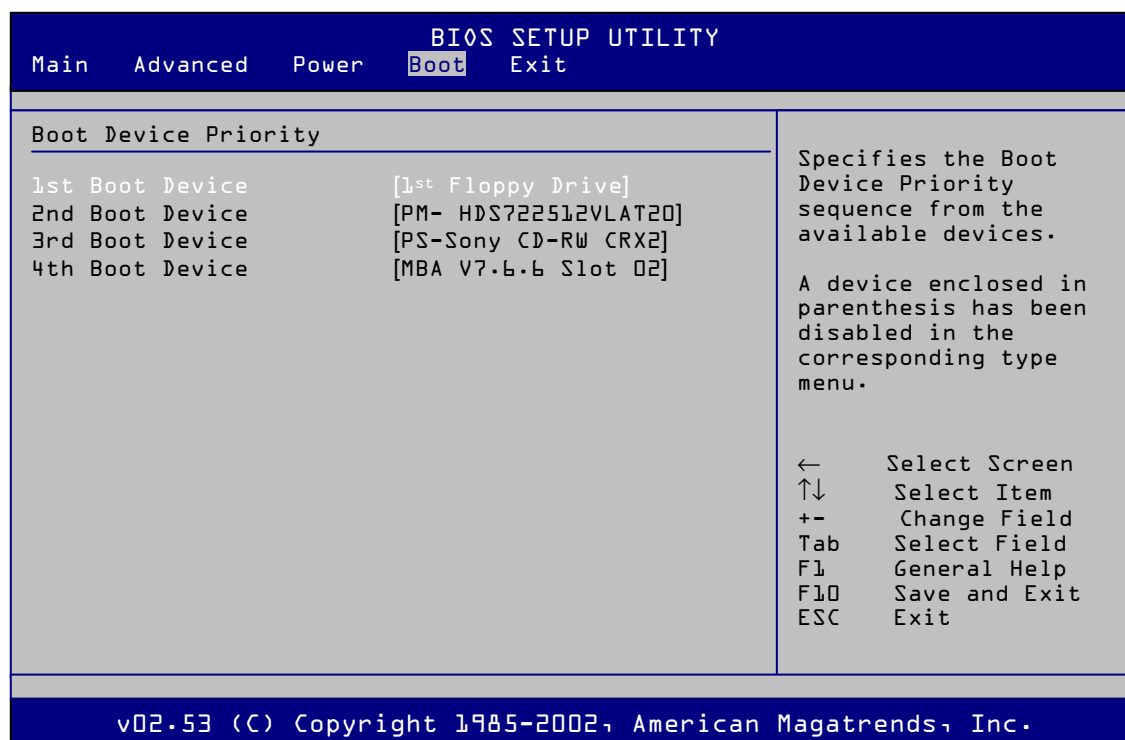


Figure 51: Boot / Boot device Priority Sub-menu

A detailed description of each of the features is given in the following table.

Table 52: Boot / Boot device Priority Sub-menu

Feature	Options	Description
1st Boot Device	<ul style="list-style-type: none"> • 1st Floppy drive[Default] • 1st HDD detected • 1st CD-ROM optical drive detected • MBA V7.6.6 Slot 0200 • Disabled 	<p>1st boot device selection</p> <p>Allows the 1st boot device to be changed to another as desired</p>
2 nd Boot Device	<ul style="list-style-type: none"> • 1st Floppy drive • 1st HDD detected[Default] • 1st CD-ROM optical drive detected • MBA V7.6.6 Slot 0200 • Disabled 	<p>2nd boot device selection</p> <p>Allows the 2nd boot device to be changed to another as desired</p>

3 rd Boot Device	<ul style="list-style-type: none"> • 1st Floppy drive • 1st HDD detected • 1st CD-ROM optical drive detected[Default] • MBA V7.6.6 Slot 0200 • Disabled 	<p>3rd boot device selection</p> <p>Allows the 3rd boot device to be changed to another as desired</p>
4 th Boot Device	<ul style="list-style-type: none"> • 1st Floppy drive[Default] • 1st HDD detected • 1st CD-ROM optical drive detected • MBA V7.6.6 Slot 0200[Default] • Disabled 	<p>4th boot device selection</p> <p>Allows the 4th boot device to be changed to another as desired</p>

Boot / Hard Drives Sub-menu

This menu allows the HDD boot order to be configured

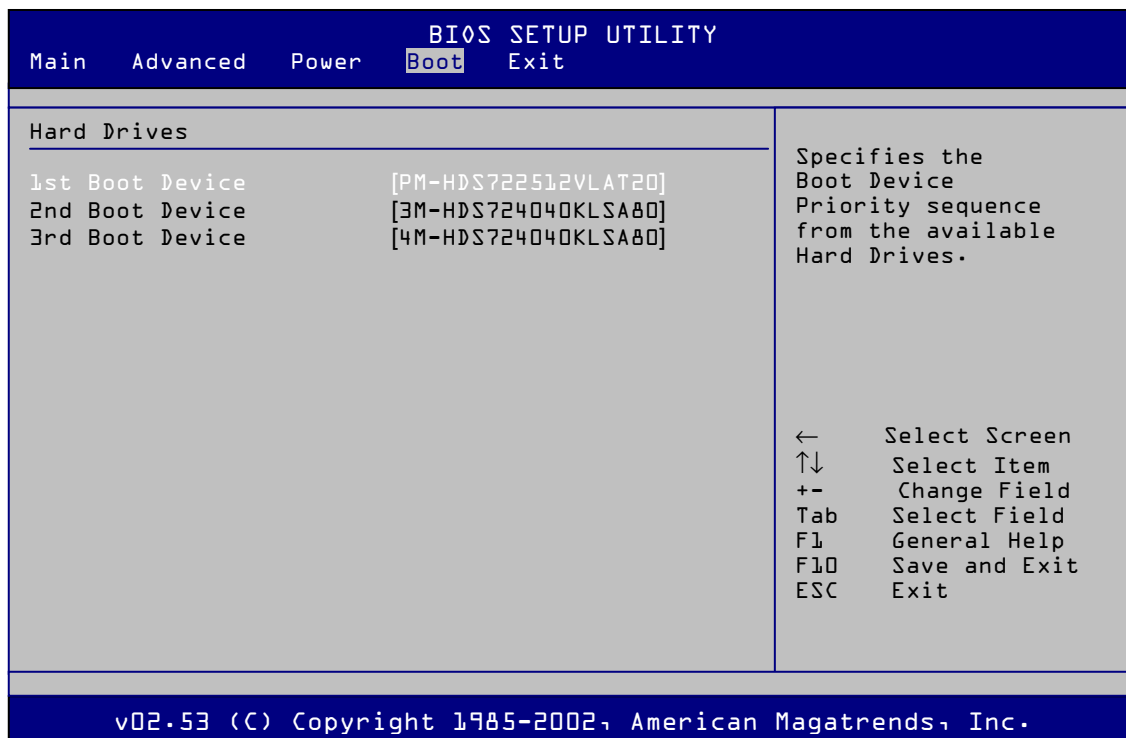


Figure 52: Boot / Hard Drives sub menu

A detailed description of each of the features is given in the following table.

Table 53: Boot / Hard Drives Sub-menu

Feature	Options	Description
1st Boot Device	<ul style="list-style-type: none"> • 1st HDD detected[Default] • 2nd HDD detected • 3rd HDD detected • Disabled 	<p>The first boot HDD.</p> <p>Allows the 1st boot device to be changed to another detected HDD as desired</p>
2 nd Boot Device	<ul style="list-style-type: none"> • 1st HDD detected • 2nd HDD detected[Default] • 3rd HDD detected • Disabled 	<p>The second boot HDD.</p> <p>Allows the 2nd boot device to be changed to another detected HDD as desired</p>
3 rd Boot Device	<ul style="list-style-type: none"> • 1st HDD detected • 2nd HDD detected • 3rd HDD detected[default] • Disabled 	<p>The third boot HDD.</p> <p>Allows the third boot device to be changed to another detected HDD as desired</p>

Note: if less HDD's are installed then a 3rd or 2nd boot device will not be shown; if more HDD's are installed then a 4th etc. boot devices will be shown.

Boot / Boot Setting Configuration Sub-menu

This menu sets BIOS boot options

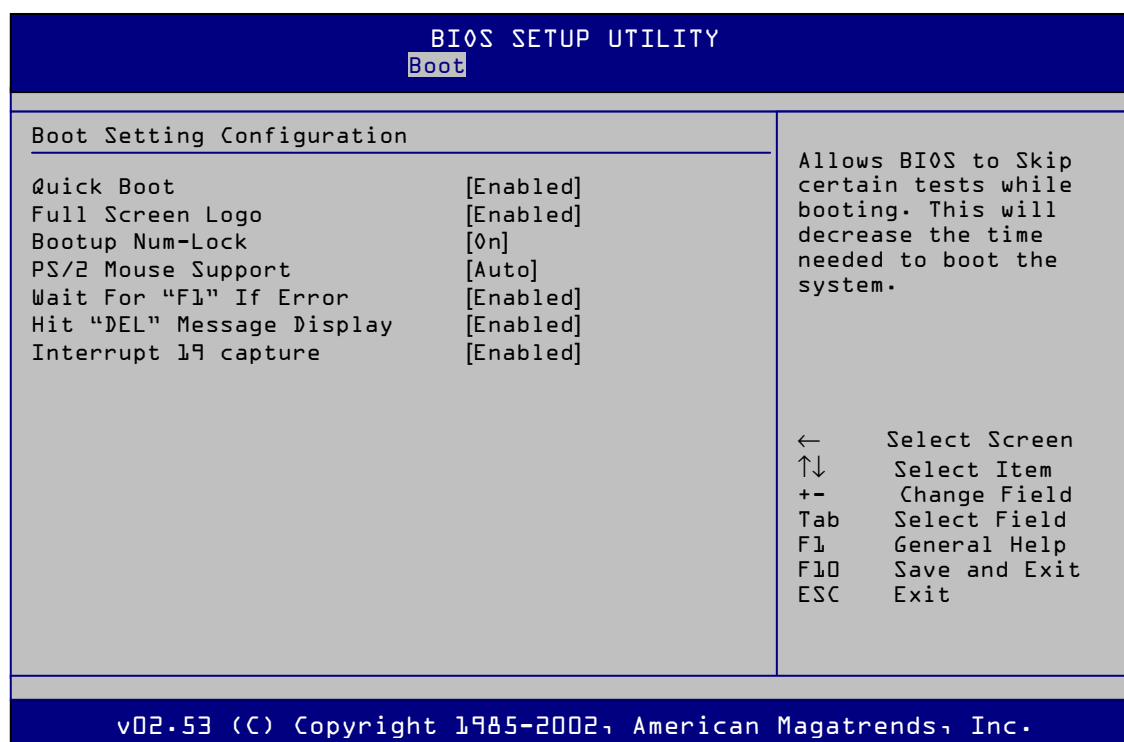


Figure 53: Boot / Boot Setting Configuration Sub-menu

A detailed description of each of the features is given in the following table.

Table 54: Boot / Boot Setting Configuration Sub-menu

Feature	Options	Description
Quick Boot	<ul style="list-style-type: none"> • Enabled [default] • Disabled 	Quick boot performs a limited BIOS POST boot check for a faster boot time
Full Screen Logo	<ul style="list-style-type: none"> • Enabled [default] • Disabled 	Enables or disables the BIOS boot logo screen from being displayed
Bootup Num-Lock	<ul style="list-style-type: none"> • On [Default] • Off 	Num lock on boot enable or disable
PS/2 Mouse Support	<ul style="list-style-type: none"> • Auto [Default] • Enabled • Disabled 	PS/2 mouse detection on boot option
Wait For "F1" If Error	<ul style="list-style-type: none"> • Enabled [default] • Disabled 	On error pause after BIOS POST with error message and F1 to resume
Hit "DEL" Message Display	<ul style="list-style-type: none"> • Enabled [default] • Disabled 	Display Hit "Del" to enter BIOS Util on power up
Interrupt 19 capture	<ul style="list-style-type: none"> • Enabled [default] • Disabled 	When set to [Enabled], this function allows the option ROMs to trap Interrupt 19. This is required by some PCI cards that provide a ROM based setup utility.

Boot / Security Settings Sub-menu

This menu configures the system supervisor and user passwords

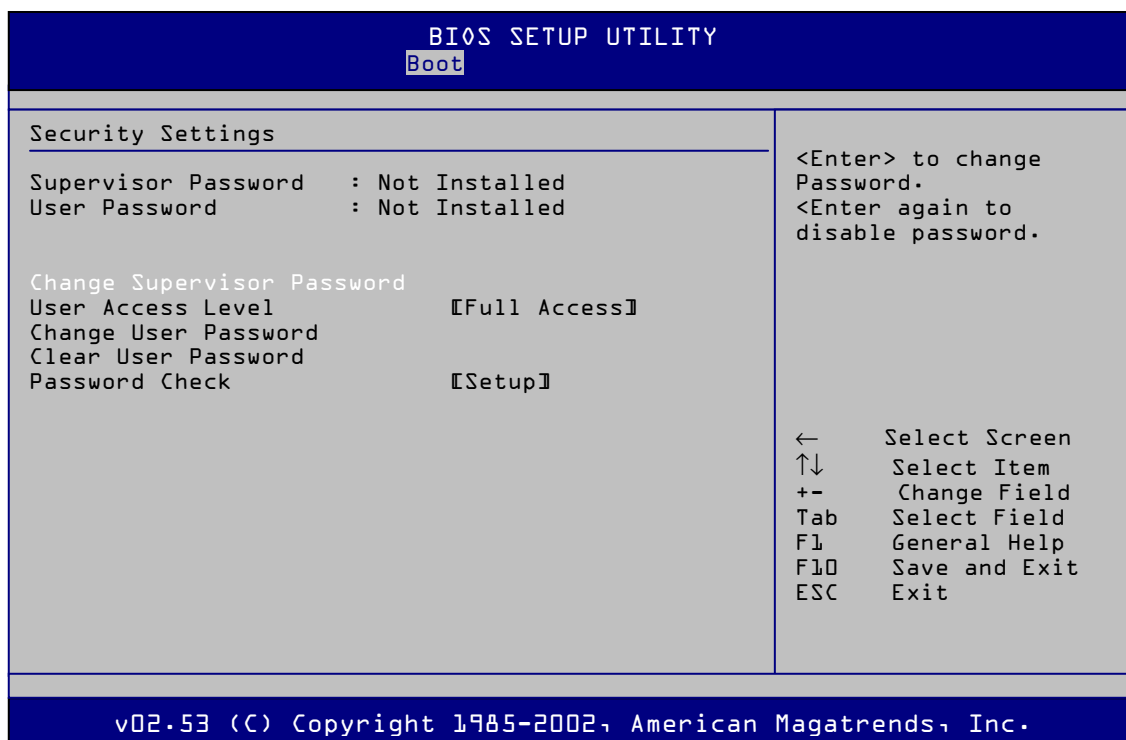


Figure 54: Boot / Security Settings Sub-menu

A detailed description of each of the features is given in the following table.

Table 55: Boot / Security Settings Sub-menu

Feature	Options	Description
Supervisor Password	Not Installed [Default]	Not installed is displayed when a "Supervisor Password" has not been set.
User Password	Not installed [Default]	Not installed is displayed when a "User Password" has not been set.
Change Supervisor Password	None	Press <Enter> to set Supervisor password. The password will need to be set twice with a conformation windows and <Enter> to confirm.
User Access Level	<ul style="list-style-type: none"> • Full Access [Default] • No Access • View only • Limited 	Will not be displayed unless a "Supervisor Password" has been set.
Change User Password	None	Will not be displayed unless a "Supervisor Password" has been set. Press <Enter> to set user password. The password will need to be set twice with a conformation windows and <Enter> to confirm.

Clear User Password	None	Will not be displayed unless a "Supervisor Password" has been set. Press <Enter> to display Clear User password select "Ok" or "Cancel" with "←" or "→" arrow keys and <Enter> to confirm.
Password Check	<ul style="list-style-type: none"> • Setup [default] • Always 	Will not be displayed unless a "Supervisor Password" has been set.

Exit menu

This menu gives the BIOS utility exit options

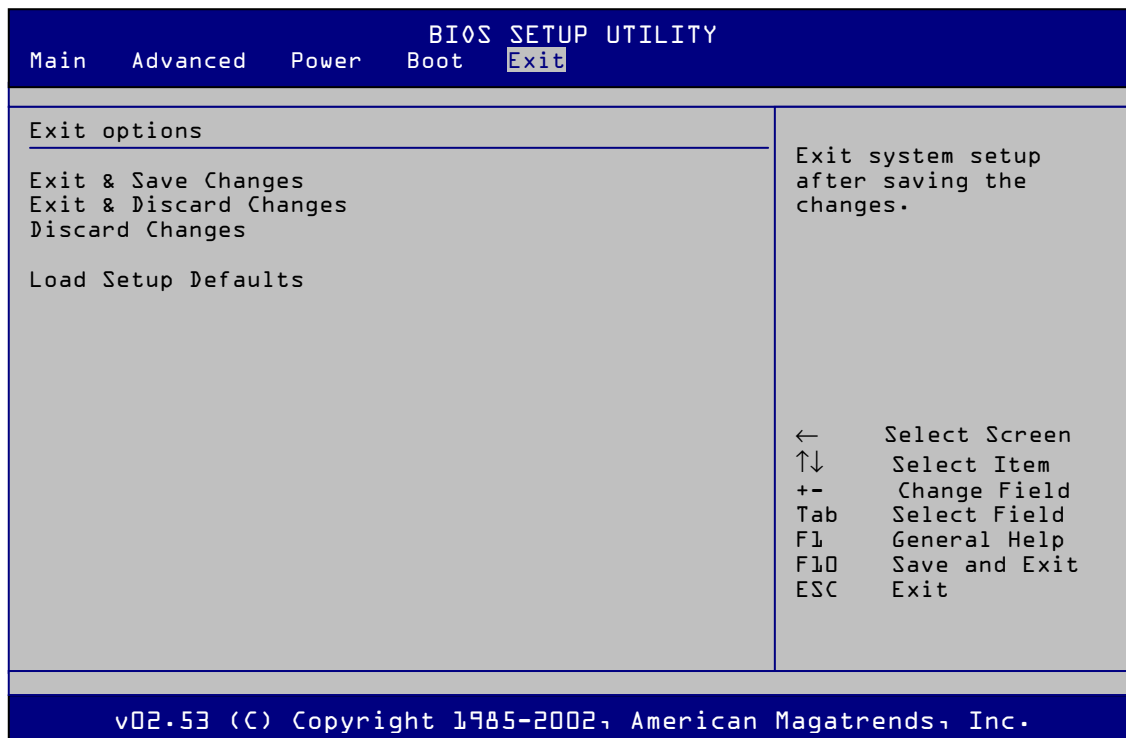


Figure 55: Exit Menu

A detailed description of each of the features is given in the following table.

Table 56: Exit Menu

Feature	Options	Description
Exit & Save Changes	None	Press <Enter> to exit setup utility and save changes
Exit & Discard Changes	None	Press <Enter> to exit setup utility and discard changes
Discard Changes	None	Press <Enter> to discard changes
Load Setup Defaults	None	Press <Enter> to Load Setup Defaults. These are the set of BIOS default values.

Upgrading the BIOS

This chapter describes how to upgrade the BIOS.

Preparing for the Upgrade

Before you upgrade the BIOS, prepare for the upgrade by recording the current BIOS settings, obtaining the upgrade utility, and making a copy of the current BIOS.

Obtaining the Upgrade Utility

You can upgrade to a new version of the BIOS using the new BIOS files and the BIOS upgrade utility, iFLASH.EXE. You can obtain the BIOS upgrade file and the iFLASH.EXE utility through your computer supplier or from the Intel World Wide Web site:

<http://www.viglen.co.uk>

Note: Please review the instructions distributed with the upgrade utility before attempting a BIOS upgrade.

This upgrade utility allows you to:

- Upgrade the BIOS in flash memory.
- Update the language section of the BIOS.

The following steps explain how to upgrade the BIOS.

STEP ONE: Recording the Current BIOS Settings

1. Boot the computer and press when you see the message:

Press Key to run BIOS SETUP UTILITY

Note: Do not skip step 2. You will need these settings to configure your computer at the end of the procedure.

2. Write down the current settings in the BIOS Setup program.

STEP TWO: Creating a Bootable Floppy Diskette

1. Use a DOS or Windows 95/98 system to create the floppy disk.
2. Insert a floppy disk in floppy drive A.
3. At the C:\ prompt, for an unformatted floppy disk, type:

```
format a:/s
```

Or, for a formatted floppy disk, type:

```
sys a:
```

4. Press <Enter>

STEP THREE: Creating the BIOS Upgrade Floppy Diskette

The BIOS upgrade file is a compressed self-extracting archive that contains the files you need to upgrade the BIOS.

1. Copy the BIOS upgrade file to a temporary directory on your hard disk.
2. From the C:\ prompt, change to the temporary directory.
3. To extract the file, type the name of the BIOS upgrade file, for example:

```
Vig390s-BIOS.zip
```

4. Press <Enter>. The extracted file contains the following files:

```
README.TXT  
afdos.exe  
vig390-0123.rom (example)
```

5. Read the README.TXT file, which contains the instructions for the BIOS upgrade.
6. Insert the bootable floppy disk into drive A.
7. Extract the three files and copy to the floppy disk.
8. The floppy disk now holds the BIOS upgrade and recovery files.

Upgrading the BIOS

1. Boot the computer with the floppy disk in drive A.
2. At the DOS prompt type:
Afudos /i (biosfilename) /pbnc
e.g. A:\afudos /l vig390s-0123.rom /pbnc
3. Now press <Enter> .
4. The utility will verify the BIOS file and start updating the BIOS.

5. An example is shown below of BIOS upgrade utility running.

Warning: DO NOT SWITCH OFF THE SYSTEM WHILE THE BIOS IS BEING UPGRADED.

```
A:\>afudos /iNCTD.ROM /pbnc
AMI Firmware Update Utility - Version 1.19 (ASUS V2.07 (03.11.24BB))
Copyright (C) 2002 American Megatrends, Inc. All rights reserved.

WARNING!! Do not turn off power during flash BIOS
Reading file ..... done
Reading flash ..... done

Advance Check .....
Erasing flash ..... done
Writing flash ..... 0x0008CC00 (9%)
```

Figure 56: BIOS Upgrading

6. Once the utility has finished as shown bellow shut down the system.

```
A:\>afudos /iNCTD.ROM /pbnc
AMI Firmware Update Utility - Version 1.19 (ASUS V2.07 (03.11.24BB))
Copyright (C) 2002 American Megatrends, Inc. All rights reserved.

WARNING!! Do not turn off power during flash BIOS
Reading file ..... done
Reading flash ..... done

Advance Check .....
Erasing flash ..... done
Writing flash ..... done
Verifying flash .... done

Please restart your computer.

A:\>
```

Figure 57: BIOS Update Complete

7. Power on the system an press to enter the BIOS setup utility.
8. Load BIOS defaults from the exit menu and set any options required as noted before upgrading the BIOS.
9. Now "Save and Exit the BIOS Setup Utility.
10. The BIOS has now been upgraded.

Chapter 5: Technical Information

Note: *This chapter is indented for experienced users only, and only to be used as a reference. Changes to or modify any of the components/ connectors listed herein can and will seriously damage your system, including the motherboard, CPU and/or any other hardware.*

You do not need to read this chapter to configure your motherboard. If you are not sure about the details listed herein, please skip and disregard them.

Enhanced IDE

IDE has been used in computer systems for some time, and has been a cheap solution to data storage. It has now been realised that traditional IDE has its limitations and thus needed to be improved. This was where Enhanced IDE came from. The main developments to the IDE interface are:

- Support hard drives of capacity greater than 528MB. This is achieved through BIOS changes.
- Improved data transfer rates. Transfer rates of 1-3MB/sec were the best to be expected from older IDE drives. With local bus technology this increased to about 6MB/sec. Now with multimedia applications, requiring vast amounts of information, even faster transfers rates were needed. Now drives with Enhanced IDE controllers can deliver up to 13MB/sec which is in the region of SCSI-2 performance.
- Dual-IDE channels have now been added which allows up to four IDE drives to be supported by the system. Each channel supporting two IDE devices.
- Non disk IDE peripherals have been developed (IDE CD-ROMs, IDE tape streamers) which can be simply attached to the one channel requiring no special hardware (requiring the use of an ISA slot) or complicated drivers. This is a standard interface meaning that any IDE CD-ROM or tape streamer can be attached.

Operating Systems and Hard Drives

Standard CHS is the translation that has been used for years. Its use limits IDE capacity to maximum of 528MB regardless of the size of the drive used.

Logical Block mode overcomes the 528MB maximum size limitation imposed by the Standard CHS mode. It should be used only when the drive supports LBA (Logical Block Addressing), and the OS supports LBA, or uses the BIOS to access the disk.

Extended CHS mode also overcomes the 528MB maximum size limitation imposed by Standard CHS mode. It can be used with drives which are larger than 528MB that do not support LBA.

Auto Detected allows the BIOS to examine the drive and determine the optimal mode. The first choice is to utilise Logical Block mode if it is supported by the drive. The second choice is to utilise Extended CHS mode if the drive topology allows. If neither of the above methods is possible, the Standard CHS mode is used.

Different operating systems have different abilities regarding IDE translation mode.

UNIX operating systems (as currently implemented) do not support either LBA or ECHS and must utilise the standard CHS method. UNIX can support drives larger than 528MB, but does so in its own way.

OS/2 2.1 and OS/2 Warp can support LBA, ECHS or standard CHS methods. Note that LBA support may require a switch setting on an OS/2 driver in order to operate in that mode.

OS/2 2.0 & Novel NetWare can support either ECHS or standard CHS methods. In order to use LBA with NetWare a driver that supports current parameters must be used. OS/2 2.0 does not support LBA.

DOS & Windows can use LBA, ECHS or standard CHS methods. The '32-bit Disk Access' driver built into Windows WDCTRL.386 can only be used with the standard CHS method, To use either LBA or ECHS method and '32-bit Disk Access' an alternative .386 driver must be installed, this combination will also provide the best performance. If this driver is not installed and the drive fitted to the system supports Type F DMA on the ISA interface or Mode 3 on the PCI interface then higher performance will be achieved by NOT using '32-bit Disk Access'.

Connector Signal Details

Table 57: Wake on Ring Connector

Pin	Signal Name
1	Ground
2	RINGA#

Table 58: Wake on LAN Connector

Pin	Signal Name
1	+5 VSB
2	Ground
3	WOL

Table 59: Fan 3 Connector

Pin	Signal Name
1	Ground
2	FAN_CTRL (+12 V)
3	FAN_SEN*

Table 60: Auxiliary Line In Connector

Pin	Signal Name
1	Left Line In
2	Ground
3	Ground
4	Right Line In (monaural)

Table 61: Telephony Connector

Pin	Signal Name
1	Audio in (monaural)
2	Ground
3	Ground
4	Mic pre-amp out (to modem)

Table 62: CD Audio Connector

Pin	Signal Name
1	CD_IN-Left
2	Ground
3	Ground
4	CD_IN-Right

Table 63: Chassis Intrusion Connector

Pin	Signal Name
1	Ground
2	CHS_SEC

Table 64: Fan 2 Connector

Pin	Signal Name
1	Ground
2	FAN_CTRL (+12 V)
3	FAN_SEN*

* If the optional management extension hardware is not available, pin 3 is ground.

Table 65: Fan Connector (Front 1,Front 2,Rear1 and Rear2)

Pin	Signal Name
1	Ground
2	FAN_CTRL (+12 V)
3	FAN_SEN*

Table 66: Serial ATA Connector

Pin	Signal Name
1	Ground
2	TXP
3	TXN
4	Ground
5	RXN
6	RXP
7	Ground

Table 67: Floppy Drive Connector

Pin	Signal Name	Pin	Signal Name
1	Ground	2	DENSEL
3	Ground	4	Reserved
5	Key	6	FDEDIN
7	Ground	8	FDINDX# (Index)
9	Ground	10	FDM00# (Motor Enable A)
11	Ground	12	No connect
13	Ground	14	FDSD0# (Drive Select A)
15	Ground	16	No connect
17	No Connect	18	FDDIR# (Stepper Motor Direction)
19	Ground	20	FDSTEP# (Step Pulse)
21	Ground	22	FDWD# (Write Data)
23	Ground	24	FDWE# (Write Enable)
25	Ground	26	FDTRK0# (Track 0)
27	Connect	28	FDWPD# (Write Protect)
29	Ground	30	FDRDATA# (Read Data)
31	Ground	32	FDHEAD# (Side 1 Select)
33	Ground	34	DSKCHG# (Diskette Change)

Table 68: PCI IDE Connectors

Pin	Signal Name	Pin	Signal Name
1	Reset IDE	2	Ground
3	Data 7	4	Data 8
5	Data 6	6	Data 9
7	Data 5	8	Data 10
9	Data 4	10	Data 11
11	Data 3	12	Data 12
13	Data 2	14	Data 13
15	Data 1	16	Data 14
17	Data 0	18	Data 15
19	Ground	20	Key
21	DDRQ0 [DDRQ1]	22	Ground
23	I/O Write#	24	Ground
25	I/O Read#	26	Ground
27	IOCHRDY	28	P_ALE (Cable Select pullup)
29	DDACK0# [DDACK1#]	30	Ground
31	IRQ 14 [IRQ 15]	32	Reserved
33	Address 1	34	Reserved

35	Address 0	36	Address 2
37	Chip Select 1P# [Chip Select 1S#]	38	Chip Select 3P# [Chip Select 3S#]
39	Activity#	40	Ground

NOTE: Signal names in brackets ([]) are for the secondary IDE connector.

Table 69: Accelerated Graphics Port

Pin	Signal Name	Pin	Signal Name	Pin	Signal Name	Pin	Signal Name
A1	+12V	B1	No Connect	A34	Vcc3.3	B34	Vcc3.3
A2	No Connect	B2	Vcc	A35	AD22	B35	AD21
A3	Reserved	B3	Vcc	A36	AD20	B36	AD19
A4	No Connect	B4	No Connect	A37	Ground	B37	Ground
A5	Ground	B5	Ground	A38	AD18	B38	AD17
A6	INTA#	B6	INTB#	A39	AD16	B39	C/BE2#
A7	RST#	B7	CLK	A40	Vcc3.3	B40	Vcc3.3
A8	GNT1#	B8	REQ#	A41	FRAME#	B41	IRDY#
A9	Vcc3.3	B9	Vcc3.3	A42	Reserved	B42	+3.3 V aux
A10	ST1	B10	ST0	A43	Ground	B43	Ground
A11	Reserved	B11	ST2	A44	Reserved	B44	Reserved
A12	PIPE#	B12	RBF#	A45	Vcc3.3	B45	Vcc3.3
A13	Ground	B13	Ground	A46	TRDY#	B46	DEVSEL#
A14	No Connect	B14	No Connect	A47	STOP#	B47	Vcc3.3
A15	SBA1	B15	SBA0	A48	PME#	B48	PERR#
A16	Vcc3.3	B16	Vcc3.3	A49	Ground	B49	Ground
A17	SBA3	B17	SBA2	A50	PAR	B50	SERR#
A18	Reserved	B18	SB_STB	A51	AD15	B51	C/BE1#
A19	Ground	B19	Ground	A52	Vcc3.3	B52	Vcc3.3
A20	SBA5	B20	SBA4	A53	AD13	B53	AD14
A21	SBA7	B21	SBA6	A54	AD11	B54	AD12
A22	Key	B22	Key	A55	Ground	B55	Ground
A23	Key	B23	Key	A56	AD9	B56	AD10
A24	Key	B24	Key	A57	C/BE0#	B57	AD8
A25	Key	B25	Key	A58	Vcc3.3	B58	Vcc3.3
A26	AD30	B26	AD31	A59	Reserved	B59	AD_STB0
A27	AD28	B27	AD29	A60	AD6	B60	AD7
A28	Vcc3.3	B28	Vcc3.3	A61	Ground	B61	Ground
A29	AD26	B29	AD27	A62	AD4	B62	AD5
A30	AD24	B30	AD25	A63	AD2	B63	AD3
A31	Ground	B31	Ground	A64	Vcc3.3	B64	Vcc3.3
A32	Reserved	B32	AD_STB1	A65	AD0	B65	AD1
A33	C/BE3#	B33	AD23	A66	SMB0	B66	SMB1

Power Supply Connector

When used with an SSI ATX-compliant power supply that supports remote power on/off, the motherboard can turn off the system power through software control.

To enable soft-off control in software, advanced power management must be enabled in the Setup program and in the operating system. When the system BIOS receives the correct APM command from the operating system, the BIOS turns off power to the computer.

With soft-off enabled, if power to the computer is interrupted by a power outage or a disconnected power cord, when power resumes, the computer returns to the power state it was in before power was interrupted (on or off).

Table 70: Power Supply Connector

Pin	Signal Name
1	+3.3 V
2	+3.3 V
3	Ground
4	+5 V
5	Ground
6	+5 V
7	Ground
8	PWRGD (Power Good)
9	+5 VSB (Standby)
10	+12 V
11	+3.3 V
12	-12 V
13	Ground
14	PS-ON# (power supply remote on/off control)
15	Ground
16	Ground
17	Ground
18	-5 V
19	Ground
20	Not connected
21	+5
22	+5
23	+5
24	Ground

Table 71: PS/2 Keyboard/Mouse Connectors

Pin	Signal Name
1	Data
2	No connect
3	Ground
4	+5 V (fused)
5	Clock
6	No connect

Table 72: Stacked USB Connectors

Pin	Signal Name
1	+5 V (fused)

2	USBP0# [USBP1#]
3	USBP0 [USBP1]
4	Ground

Table 73: Serial Port Connectors

Pin	Signal Name
1	DCD
2	Serial In #
3	Serial Out #
4	DTR#
5	Ground
6	DSR
7	RTS
8	CTS
9	RI

Table 74: Audio Line Out Connector

Pin	Signal Name
Sleeve	Ground
Tip	Audio Left Out
Ring	Audio Right Out

Table 75: Audio Line In Connector

Pin	Signal Name
Sleeve	Ground
Tip	Audio Left In
Ring	Audio Right In

Table 76: Audio Mic In Connector

Pin	Signal Name
Sleeve	Ground
Tip	Mono In
Ring	Electret Bias Voltage

Table 77: Parallel Port Connector

Pin	Signal Name	Pin	Signal Name
1	Strobe#	14	Auto Feed#
2	Data bit 0	15	Fault#
3	Data bit 1	16	INIT#
4	Data bit 2	17	SLCT IN#
5	Data bit 3	18	Ground
6	Data bit 4	19	Ground
7	Data bit 5	20	Ground
8	Data bit 6	21	Ground
9	Data bit 7	22	Ground
10	ACK#	23	Ground
11	Busy	24	Ground
12	Error	25	Ground
13	Select		

Table 78: MIDI / Game Port Connector

Pin	Signal Name	Pin	Signal Name
1	+5 V (fused)	9	+5 V (fused)
2	GP4 (JSBUTO)	10	GP6 (JSBUT2)
3	GP0 (JSX1)	11	GP2 (JSX2)
4	Ground	12	MIDI-OUTR
5	Ground	13	GP3 (JSY2)
6	GP1 (JSY1)	14	GP7 (JSBUT3)
7	GP5 (JSBUT1)	15	MIDI-IN
8	+5 V (fused)		

Table 79: PCI Bus Connectors

Pin	Signal Name	Pin	Signal Name	Pin	Signal Name	Pin	Signal Name
A1	Ground (TRST#)*	B1	-12 V	A32	AD16	B32	AD17
A2	+12 V	B2	Ground (TCK)*	A33	+3.3 V	B33	C/BE2#
A3	+5 V (TMS)*	B3	Ground	A34	FRAME#	B34	Ground
A4	+5 V (TDI)*	B4	no connect (TDO)*	A35	Ground	B35	IRDY#
A5	+5 V	B5	+5 V	A36	TRDY#	B36	+3.3 V
A6	INTA#	B6	+5 V	A37	Ground	B37	DEVSEL#
A7	INTC#	B7	INTB#	A38	STOP#	B38	Ground
A8	+5 V	B8	INTD#	A39	+3.3 V	B39	LOCK#
A9	Reserved	B9	no connect (PRSNT1#)*	A40	+5 V (SDONE)*	B40	PERR#
A10	+5 V (I/O)	B10	Reserved	A41	+5 V (SBO#)*	B41	+3.3 V
A11	Reserved	B11	no connect (PRSNT2#)*	A42	Ground	B42	SERR#
A12	Ground	B12	Ground	A43	PAR	B43	+3.3 V
A13	Ground	B13	Ground	A44	AD15	B44	C/BE1#
A14	+3.3 V aux	B14	Reserved	A45	+3.3 V	B45	AD14
A15	RST#	B15	Ground	A46	AD13	B46	Ground
A16	+5 V (I/O)	B16	CLK	A47	AD11	B47	AD12
A17	GNT#	B17	Ground	A48	Ground	B48	AD10
A18	Ground	B18	REQ#	A49	AD09	B49	Ground
A19	PME#	B19	+5 V (I/O)	A50	Key	B50	Key
A20	AD30	B20	AD31	A51	Key	B51	Key
A21	+3.3 V	B21	AD29	A52	C/BE0#	B52	AD08
A22	AD28	B22	Ground	A53	+3.3 V	B53	AD07
A23	AD26	B23	AD27	A54	AD06	B54	+3.3 V
A24	Ground	B24	AD25	A55	AD04	B55	AD05
A25	AD24	B25	+3.3 V	A56	Ground	B56	AD03
A26	IDSEL	B26	C/BE3#	A57	AD02	B57	Ground
A27	+3.3 V	B27	AD23	A58	AD00	B58	AD01
A28	AD22	B28	Ground	A59	+5 V (I/O)	B59	+5 V (I/O)
A29	AD20	B29	AD21	A60	REQ64C#	B60	ACK64C#
A30	Ground	B30	AD19	A61	+5 V	B61	+5 V
A31	AD18	B31	+3.3 V	A62	+5 V	B62	+5 V

* These signals (in parentheses) are optional in the PCI specification and are not currently implemented.

Motherboard Resources

Table 80: Typical Memory Map

Address Range (decimal)	Address Range (hex)	Size	Description
1024 K - 393216 K	100000 - 18000000	383 MB	Extended memory
928 K - 1024 K	E8000 - FFFFF	96 KB	System BIOS
896 K - 928 K	E0000 - E7FFF	32 KB	System BIOS (Available as UMB)
800 - 896 K	C8000 - DFFFF	96 KB	Available high DOS memory (open to ISA and PCI bus)
640 K - 800 K	A0000 - C7FFF	160 KB	Video memory and BIOS
0 K - 512 K	00000 - 7FFFF	512 KB	Conventional memory

Table 81: DMA Channels

DMA Channel Number	Data Width	System Resource
0	8- or 16-bits	Open
1	8- or 16-bits	Parallel port
2	8- or 16-bits	Floppy drive
3	8- or 16-bits	Parallel port (for ECP)/audio
4	8- or 16-bits	Reserved - cascade channel
5	16-bits	Open
6	16-bits	Open
7	16-bits	Open

Table 82: I/O Map

Address (hex)	Size	Description
0000 - 000F	16 bytes	DMA 1 controller 1
0020 - 0021	2 bytes	Interrupt controller 1
002E - 002F	2 bytes	Super I/O controller configuration registers
0040 - 0043	4 bytes	Counter/Timer 1
0048 - 004B	4 bytes	Counter/Timer 2
0060	1 byte	Keyboard Controller Byte
0061	1 byte	NMI, Speaker Control
0064	1 byte	Keyboard controller
0070 - 0071	2 bit	Real time clock controller
0080 - 008F	16 bytes	DMA page registers
00A0 - 00A1	2 bytes	Interrupt controller 2
00B2 - 00B3	2 bytes	APM control
00C0 - 00DE	31 bytes	DMA 2
00F0 - 00FF	16 byte	Numeric processor
0170 - 0177	8 bytes	Secondary IDE controller
01F0 - 01F7	8 bytes	Primary IDE controller
0200 - 0207	8 bytes	Audio/ game port/ joystick
0220 - 022F	16 bytes	Audio (Sound Blaster compatible)
0228 - 022F	8 bytes	LPT3
0278 - 027F	8 bytes	LPT2
02E8 - 02EF	8 bytes	COM4/Video (8514A)
02F8 - 02FF	8 bytes	COM2
0330 - 0331	2 bytes	MPU-401 (MIDI)
0376 - 0377	2 byte	Secondary IDE channel command port
0120 - 0127	8 byte	Audio controller
0274 - 0277	4 bit	I/O read data port for ISA Plug and Play enumerator
0378 - 037F	8 bytes	LPT1
0388 - 038D	6 bytes	AdLib (FM synthesizer)

03B0 - 03BB	12 bytes	Video (monochrome)
03C0 - 03DF	32 bytes	Video (VGA)
03E8 - 03EF	8 bytes	COM3
03F0 - 03F5, 03F7	7 bytes	Floppy Controller
03F6	1 byte	Primary IDE controller
03F8 - 03FF	8 bytes	COM1
04D0 - 04D1	2 bytes	Edge/level triggered PIC
0530 - 0537	8 bytes	Windows Sound System
LPT n + 400h	8 bytes	ECP port, LPT n base address + 400h
0CF8 - 0CFF*	8 bytes	PCI configuration registers
0CF9**	1 byte	Turbo and reset control register

* DWORD access only

** Byte access only

Table 83: Typical PCI Configuration Space Map

Bus Number (hex)	Device Number (hex)	Function Number (hex)	Description
00	00	00	Intel 82440BX (PAC)
00	01	00	Intel 82440BX (PAC) AGP bus
00	07	00	Intel 82371AB (PIIX4E) PCI/ISA bridge
00	07	01	Intel 82371AB (PIIX4E) IDE bus master
00	07	02	Intel 82371AB (PIIX4E) USB
00	07	03	Intel 82371AB (PIIX4E) power management
00	0D	00	PCI expansion slot 1 (J4D2)
00	0E	00	PCI expansion slot 2 (J4D1)
00	0F	00	PCI expansion slot 3 (J4C1)
00	10	00	PCI expansion slot 4 (J4B1)

Table 84: Standard interrupt assignments

IRQ	Priority	Standard Function
0	1	System Timer
1	2	Keyboard Controller
2	-	Re-direct to IRQ#9
3	11	Communications Port (COM2)*
4	12	Communications Port (COM1)*
5	13	IRQ holder for PCI steering*
6	14	Floppy Disk Controller
7	15	Printer Port (LPT1)*
8	3	System CMOS/Real Time Clock
9	4	IRQ holder for PCI steering*
10	5	IRQ holder for PCI steering*
11	6	IRQ holder for PCI steering*
12	7	PS/2 Compatible Mouse Port*
13	8	Numeric Data Processor
14	9	Primary IDE Channel
15	10	Secondary IDE Channel

Note: * These IRQs are usually available for ISA or PCI devices.

Other Information

Reliability

The mean time between failures (MTBF) prediction is calculated using component and subassembly random failure rates. The calculation is based on the Bellcore Reliability Prediction Procedure, TR-NWT-000332, Issue 4, September 1991.

The MTBF prediction is for:

- Redesigning the motherboard for alternate components if failure rates exceed reliability expectations.
- Estimating repair rates and spare parts requirements.

MTBF data is calculated from predicted data @ 55 °C.

The MTBF prediction for the motherboard is 112,977. 7547 hours.

Temperature

Table 85: Temperature

Temperature	Specification
Non-operating	-40°C to +70°C
Operating	0°C to +55°C

Chapter 6: Glossary

Advanced Dynamic Execution

Part of the Pentium® 4 processor's Intel® NetBurst® micro-architecture. Improved branch prediction algorithm accelerates the flow of work to the processor and helps overcome the deeper pipeline. Very deep, out-of-order speculative execution allows the processor to view 126 instructions in flight and handle up to 48 loads and 24 stores in the pipeline. A 4 KB branch target buffer stores more detail on the history of past branches, reducing inaccurate branch predictions by roughly 33% (when compared to P6 micro-architecture).

Advance Transfer Cache (Level 2 Advance Transfer Cache)

The 256 KB Level 2 Advance Transfer Cache (ATC) delivers a much higher data throughput channel between the Level 2 cache and the processor core. 512 KB L2 Advance Transfer Cache is available on 0.13 micron technology Pentium® 4 processors, while 0.18 micron technology Pentium 4 processors utilise a 256 KB L2 Advance Transfer Cache. Features of the ATC include: Non-Blocking, full speed, on-die level 2 cache, 8-way set association, 512-bit or 256-bit data bus to the level 2 cache, data clocked into and out of the cache every clock cycle.

BIOS

(Basic Input Output System) This is software stored on a chip and consists of the instructions necessary for the computer to function. The System BIOS contains the instructions for the keyboard, disk drives etc., and the VGA BIOS controls the VGA graphics card.

CPU

Central Processing Unit. This is the main piece of equipment on the motherboard. The CPU processes data, tells memory what to store and the video card what to display.

Default

The configuration of the system when it is switched on or the standard settings before any changes are made.

DIMM

Dual In-Line Memory Module, a type of memory module used for the systems main memory.

Driver

A piece of software which is used by application software to control some special features. Each graphics board and printer requires its own driver.

D-Type

A common type of connector used for connecting printers, serial ports, game port, and many other types of interface.

DRAM

Dynamic Ram used for main system memory, providing a moderately fast but cheap storage solution.

Enhanced Floating Point and Multimedia Unit

Part of the Pentium® 4 processor's Intel® NetBurst® micro-architecture. An expanded 128-bit floating point register and an additional register for data movement improves performance on floating-point and multimedia applications.

Execution Trace Cache (Level 1 Execution Trace Cache)

Part of the Pentium® 4 processor's Intel® NetBurst® micro-architecture. In addition to the 8 KB data cache, the Pentium 4 processor includes an Execution Trace Cache that stores up to 12 K decoded micro-ops in the order of program execution. This increases performance by removing the decoder from the main execution loop and makes more efficient usage of the cache storage space since instructions that are branched around are not stored. As a result, a high volume of instructions are delivered to the processor's execution units and the overall time required to recover from erroneous branch predictions is decreased.

FDC

Floppy Disk Controller - the interface for connecting floppy disk drives to the computer.

Hercules

A monochrome graphics video mode which first appeared in the Hercules graphics card. Provides a resolution of 720 by 348 pixels.

Hyper-Pipelined Technology

Part of the Pentium® 4 processor's Intel® NetBurst® micro-architecture. Hyper-pipelined technology doubles the pipeline depth of the Pentium® III processor's P6 micro-architecture, increasing the branch prediction and recovery pipeline to 20 stages. The deeper pipeline enables instructions to be queued and executed at the fastest-possible rate, increasing performance, frequency, and scalability.

IDE

Integrated Drive Electronics - currently the most popular type of interface for hard disk drives. Much of the circuitry previously required on hard disk controller cards is now integrated on the hard disk itself.

Interface

The electronics providing a connection between two pieces of equipment. For example, a printer interface connects a computer to a printer.

Interlace

The mode the graphics card uses to refresh a monitor screen. When the graphics is in interlace mode, the frequency of the display update is lower than in non-interlace mode. This causes a slight flicker, so generally non-interlaced mode is better if the monitor supports it.

Internet Streaming SIMD Extensions

Consists of 70 instructions and includes single instruction, multiple data for floating-point, additional SIMD-integer and cache ability control instructions. Benefits include higher resolution image viewing and manipulation, high quality audio, MPEG2 video, and simultaneous MPEG2 encoding and decoding, reduced CPU utilisation for speech recognition, and higher accuracy and faster response times

L.E.D.

Light Emitting Diode - a light which indicates activity - for example hard disk access.

PCI (Peripheral Component Interconnect)

Developed by Intel, PCI is a local bus standard. A bus is a channel used to transfer data to (input) and from (output) a computer and to or from a peripheral device. Most PCs have a PCI bus usually implemented at 32-bits providing a 33 MHz clock speed with a throughput rate of 133 MBps.

NetBurst® micro-architecture (Intel NetBurst® micro-architecture)

The NetBurst® micro-architecture delivers a number of new and innovative features including Hyper Pipelined Technology, 400 MHz System Bus, Execution Trace Cache, and Rapid Execution Engine. It also delivers a number of enhanced features, including Advanced Transfer Cache, Advanced Dynamic Execution, Enhanced Floating Point and Multimedia Unit, and Streaming SIMD Extensions 2. Intel NetBurst® Microarchitecture provides higher throughput within the processor and out to memory and I/O for improved headroom.

PCI

Peripheral Component Interface. It became apparent to manufacturers that the 8MHz AT ISA BUS on the standard PC was just not fast enough for today's applications, and so PCI was invented. It is a high speed data bus that carries information to and from components - known as 'Local Bus'.

PCI-X

The 64-bit PCI-X interface (PCI-X 1.0a) can be operated at 133 MHz, (or at 100 MHz and 66 MHz) which achieves a greater than two-fold boost in performance over PCI 2.2 bus technology. The 133 MHz PCI-X interface achieves up to 1 GB/s throughput, a two-fold increase over 66 MHz PCI 2.2.

PCI-Express

PCI Express is a 3rd generation I/O architecture where ISA and PCI were respectively the 1st and 2nd generations. A high-speed, general-purpose serial I/O interconnect, PCI Express will initially offers speeds of 2.5 Gigabits per second, support multiple widths ("lanes" of data that range from 1 to 32), and scale to the limits of copper. PCI Express will unify I/O architecture for desktop, mobile, server, communications platforms, workstations and embedded devices while also coexisting with PCI and USB connection types

RAM

Random Access Memory - the memory used by the computer for running programs and storing data.

ROM

Read Only Memory - a memory chip which doesn't lose its data when the system is switched off. It is used to store the System BIOS and VGA BIOS instructions. It is slower than RAM.

Rapid Execution Engine

Part of the Pentium® 4 processor's Intel® NetBurst® micro-architecture. Two Arithmetic Logic Units (ALUs) are clocked at twice the core processor frequency, allowing basic integer instructions such as Add, Subtract, Logical AND, and Logical OR to execute in half of a clock cycle. For example, the Rapid Execution Engine on a 1.50 GHz Pentium 4 processor runs at 3 GHz.

S-ATA (Serial ATA)

Serial ATA is the next-generation internal storage interconnect designed to replace Parallel ATA technology. Serial ATA is the proactive evolution of the ATA interface from a parallel bus to a serial bus architecture. This architecture overcomes many design and usage constraints that are increasing the difficulty of continued speed enhancements for the classic parallel ATA bus. Serial ATA will be introduced at 150Mbytes/sec, with a roadmap already planned through 600Mbytes/sec.

Shadow Memory

The BIOS is normally stored in ROM. On certain systems it can be copied to RAM on power up to make it go faster. This RAM is known as shadow memory. The System BIOS is responsible for this copying.

SSE (Streaming SIMD Extensions)

Internet Streaming SIMD (Single Instruction Multiple Data) Extensions are instructions that reduce the overall number of instructions required to execute a particular program task. As a result, they can boost performance by accelerating a broad range of applications, including video, speech, and image, photo processing, encryption, financial, engineering and scientific applications. NetBurst® micro-architecture adds 144 new SSE instructions, which are known as SSE2.

Streaming SIMD Extensions 3

Better multimedia and encryption/decryption processing than previous generations, along with support for more computationally intensive graphics.

Super VGA

Additional screen modes and capabilities provided over and above the standard VGA defined by IBM.

VGA

Video Graphics Array - the graphics standard defined by IBM and provided on IBM's PS/2 machines.

Chapter 7: Suggestions

Viglen is interested in continuing to improve the quality and information provided in their manuals. Viglen has listed some questions that you may like to answer and return to Viglen. This will help Viglen help to keep and improve the standard of their manuals.

1. Is the information provided in this and other manuals clear enough?

2. What could be added to the manual to improve it?

3. Does the manual go into enough detail?

4. Would you like an on-line version of this manual?

5. How do you rate the Viglen Technical support and Service Departments?

6. Are there any technological improvements that could be made to the system?

7. Other points you would like to mention?

Please return this slip to: Product Development Dept.
Viglen Ltd.
Viglen House
Alperton Lane
Alperton
Middlesex
HA0 IDX

Free Manuals Download Website

<http://myh66.com>

<http://usermanuals.us>

<http://www.somanuals.com>

<http://www.4manuals.cc>

<http://www.manual-lib.com>

<http://www.404manual.com>

<http://www.luxmanual.com>

<http://aubethermostatmanual.com>

Golf course search by state

<http://golfingnear.com>

Email search by domain

<http://emailbydomain.com>

Auto manuals search

<http://auto.somanuals.com>

TV manuals search

<http://tv.somanuals.com>