

Intel[®] Core[™] 2 Duo Processor and Intel[®] Q35 Express Chipset Development Kit

User's Manual

October 2007

Order Number: 318476-001US



INFORMATION IN THIS DOCUMENT IS PROVIDED IN CONNECTION WITH INTEL® PRODUCTS. NO LICENSE, EXPRESS OR IMPLIED, BY ESTOPPEL OR OTHERWISE, TO ANY INTELLECTUAL PROPERTY RIGHTS IS GRANTED BY THIS DOCUMENT. EXCEPT AS PROVIDED IN INTEL'S TERMS AND CONDITIONS OF SALE FOR SUCH PRODUCTS, INTEL ASSUMES NO LIABILITY WHATSOEVER, AND INTEL DISCLAIMS ANY EXPRESS OR IMPLIED WARRANTY, RELATING TO SALE AND/OR USE OF INTEL PRODUCTS INCLUDING LIABILITY OR WARRANTIES RELATING TO FITNESS FOR A PARTICULAR PURPOSE, MERCHANTABILITY, OR INFRINGEMENT OF ANY PATENT, COPYRIGHT OR OTHER INTELLECTUAL PROPERTY RIGHT. Intel products are not intended for use in medical, life saving, life sustaining, critical control or safety systems, or in nuclear facility applications.

Intel may make changes to specifications and product descriptions at any time, without notice.

Intel Corporation may have patents or pending patent applications, trademarks, copyrights, or other intellectual property rights that relate to the presented subject matter. The furnishing of documents and other materials and information does not provide any license, express or implied, by estoppel or otherwise, to any such patents, trademarks, copyrights, or other intellectual property rights.

Designers must not rely on the absence or characteristics of any features or instructions marked "reserved" or "undefined." Intel reserves these for future definition and shall have no responsibility whatsoever for conflicts or incompatibilities arising from future changes to them.

Intel processor numbers are not a measure of performance. Processor numbers differentiate features within each processor family, not across different processor families. See http://www.intel.com/products/processor_number for details.

The Intel® Core™ 2 Duo Processor and Intel® Q35 Express Chipset Development Kit may contain design defects or errors known as errata which may cause the product to deviate from published specifications. Current characterized errata are available on request.

Hyper-Threading Technology requires a computer system with an Intel® Pentium® 4 processor supporting HT Technology and a HT Technology enabled chipset, BIOS and operating system. Performance will vary depending on the specific hardware and software you use. See http://www.intel.com/products/ht/Hyperthreading_more.htm for additional information.

Contact your local Intel sales office or your distributor to obtain the latest specifications and before placing your product order.

Copies of documents which have an order number and are referenced in this document, or other Intel literature may be obtained by calling 1-800-548-4725 or by visiting Intel's website at <http://www.intel.com>.

BunnyPeople, Celeron, Celeron Inside, Centrino, Centrino logo, Core Inside, FlashFile, i960, InstantIP, Intel, Intel logo, Intel386, Intel486, Intel740, IntelDX2, IntelDX4, IntelSX2, Intel Core, Intel Inside, Intel Inside logo, Intel. Leap ahead., Intel. Leap ahead. logo, Intel NetBurst, Intel NetMerge, Intel NetStructure, Intel SingleDriver, Intel SpeedStep, Intel StrataFlash, Intel Viiv, Intel vPro, Intel XScale, IPLink, Itanium, Itanium Inside, MCS, MMX, Oplus, OverDrive, PDCharm, Pentium, Pentium Inside, skool, Sound Mark, The Journey Inside, VTune, Xeon, and Xeon Inside are trademarks or registered trademarks of Intel Corporation or its subsidiaries in the United States and other countries.

*Other names and brands may be claimed as the property of others.

Copyright © 2007, Intel Corporation. All Rights Reserved.



Contents

| | | |
|------------|---|----|
| 1.0 | About This Manual | 6 |
| 1.1 | Content Overview | 6 |
| 1.2 | Text Conventions | 6 |
| 1.3 | Glossary of Terms and Acronyms | 7 |
| 1.4 | Support Options | 8 |
| 1.4.1 | Electronic Support Systems | 8 |
| 1.4.2 | Additional Technical Support | 8 |
| 1.5 | Product Literature | 8 |
| 2.0 | Development Kit Hardware Features | 10 |
| 2.1 | Intel® Q35 Express Chipset Development Kit Overview | 10 |
| 2.2 | System Block Diagram | 11 |
| 2.3 | Development Kit Inventory Checklists | 12 |
| 2.4 | Processor Support | 14 |
| 2.5 | System Memory | 14 |
| 2.5.1 | Dual Channel (Interleaved) Mode Configurations | 15 |
| 2.5.2 | Single Channel (Asymmetric) Mode Configurations | 17 |
| 2.6 | Back-Panel Connectors | 18 |
| 2.6.1 | Audio-Connectors | 18 |
| 2.6.2 | RJ-45 LAN Connector with Integrated LEDs | 19 |
| 2.6.3 | USB Port | 19 |
| 2.6.4 | Coaxial S/PDIF In/Out Connector | 19 |
| 2.6.5 | eSATA Port | 19 |
| 2.7 | Debug Features | 20 |
| 2.7.1 | Extended Debug Probe (XDP) | 20 |
| 2.7.2 | Power LEDs | 20 |
| 2.7.3 | Port 80 POST Code LEDs | 20 |
| 2.7.4 | Voltage Reference | 21 |
| 2.8 | Development Kit Major Connectors and Jumpers | 21 |
| 2.8.1 | Jumper Functions | 22 |
| 2.8.2 | USB 2.0 Front Panel | 22 |
| 2.8.3 | 1394a Header | 22 |
| 2.9 | SPI Removal / Installation Technique | 23 |
| 2.9.1 | SPI Device Removal | 24 |
| 2.9.2 | SPI Device Installation | 24 |
| 3.0 | Setting Up and Configuring the Development Kit | 26 |
| 3.1 | Overview | 26 |
| 3.2 | Installing Board Standoffs | 26 |
| 3.3 | BTX Heatsink Setup with SRM | 28 |
| 3.3.1 | SRM Alignment on any BTX Board | 28 |
| 3.4 | Board Setup and Configuration before Boot | 30 |
| 3.5 | Post Codes Definitions | 32 |
| 3.5.1 | Normal Post Codes | 32 |

Figures

| | | |
|---|---|----|
| 1 | Board Features | 11 |
| 2 | Intel® Q35 Express Chipset Development Kit block diagram | 12 |
| 3 | Memory Channel and DIMM Configuration | 15 |
| 4 | Dual Channel (Interleaved) Mode Configuration with 2x DIMMs | 16 |
| 5 | Dual Channel (Interleaved) Mode Configuration with 3x DIMMs | 16 |



| | | |
|----|---|----|
| 6 | Dual Channel (Interleaved) Mode Configuration with 4x DIMMs..... | 17 |
| 7 | Single Channel (Asymmetric) Mode Configuration with 1x DIMM | 17 |
| 8 | Single Channel (Asymmetric) Mode Configuration with 3x DIMMs..... | 18 |
| 9 | Back-panel Connectors..... | 18 |
| 10 | LAN Connector LED locations..... | 19 |
| 11 | ITP-XDP Connector location (J2BC) | 20 |
| 12 | Major Jumper and Header Locations..... | 21 |
| 13 | Location for 1394a Header and USB Front Panel | 23 |
| 14 | SPI Socket with Retaining Clip..... | 24 |
| 15 | SPI Device Installation | 25 |
| 16 | Intel® Q35 Development Kits | 26 |
| 17 | Mounting Hole Locations..... | 27 |
| 18 | Mounting the Standoff for BTX Heatsink..... | 28 |
| 19 | Casing with “Support and Retention Module” | 28 |
| 20 | BTX board alignment on SRM | 29 |
| 21 | Heatsink Alignment..... | 29 |
| 22 | Tightening Heatsink on the SRM and Board | 30 |
| 23 | CPU Fan location | 31 |
| 24 | 2x12 Standard power supply and 2x2 power supply | 32 |

Tables

| | | |
|----|--|----|
| 1 | Definition | 7 |
| 2 | Intel Literature Centers | 9 |
| 3 | Development Kit Hardware Items | 12 |
| 4 | Development Kit Board Specification | 13 |
| 5 | Internal I/O headers | 13 |
| 6 | Supported Intel Technologies | 13 |
| 7 | Additional Features..... | 14 |
| 8 | LAN Connector LED status | 19 |
| 9 | Voltage Reference detail..... | 21 |
| 10 | Intel® Core™ 2 Duo Processor and Intel® Q35 Express Chipset Development Kit Board Jumpers Description | 22 |
| 11 | USB Front Panel | 22 |
| 12 | 1394a Header | 23 |



Revision History

| Date | Revision | Description |
|--------------|----------|-----------------|
| October 2007 | 001 | Initial release |



1.0 About This Manual

This user's manual describes the use of the Intel® Q35 Express Chipset Development Kit. This manual has been written for OEMs, system evaluators, and embedded system developers. All jumpers, headers, LED functions, and their locations on the board, along with subsystem features and POST codes, are defined in this document.

For the latest information about the Intel® Q35 Express Chipset Development Kit reference platform, visit:

http://developer.intel.com/design/intarch/devkits/index.htm?iid=embed_body+devkits

For design documents related to this platform, such as schematics and layout, please contact your Intel Representative.

1.1 Content Overview

Chapter 1.0, "About This Manual"

This chapter contains a description of conventions used in this manual. The last few sections explain how to obtain literature and contact customer support.

Chapter 2.0, "Development Kit Hardware Features"

This chapter provides information on the development kit features and the board capability. This includes the information on board component features, jumper settings, pin-out information for connectors and overall development kit board capability.

Chapter 3.0, "Setting Up and Configuring the Development Kit"

This chapter provides instructions on how to configure the evaluation board and processor assembly by setting BTX heatsink, jumpers, connecting peripherals, providing power, and configuring the BIOS.

1.2 Text Conventions

The following notations may be used throughout this manual.

| | |
|--------------|--|
| # | The pound symbol (#) appended to a signal name indicates that the signal is active low. |
| Variables | Variables are shown in italics. Variables must be replaced with correct values. |
| Instructions | Instruction mnemonics are shown in uppercase. When you are programming, instructions are not case-sensitive. You may use either upper-case or lower-case. |
| Numbers | Hexadecimal numbers are represented by a string of hexadecimal digits followed by the character <i>H</i> . A zero prefix is added to numbers that begin with <i>A</i> through <i>F</i> . (For example, <i>FF</i> |



is shown as *OFFH*.) Decimal and binary numbers are represented by their customary notations (That is, 255 is a decimal number and 1111 1111 is a binary number). In some cases, the letter *B* is added for clarity.

| | |
|------------------|---|
| Units of Measure | The following abbreviations are used to represent units of measure: GByte gigabytes KByte kilobytes MByte megabytes MHz megahertz W watts V volts |
| Signal Names | Signal names are shown in uppercase. When several signals share a common name, an individual signal is represented by the signal name followed by a number, while the group is represented by the signal name followed by a variable (<i>n</i>). For example, the lower chip-select signals are named CS0#, CS1#, CS2#, and so on; they are collectively called CS <i>n</i> #. A pound symbol (#) appended to a signal name identifies an active-low signal. Port pins are represented by the port abbreviation, a period, and the pin number (e.g., P1.0). |

1.3 Glossary of Terms and Acronyms

This section defines conventions and terminology used throughout this document.

Table 1. Definition (Sheet 1 of 2)

| Term | Description |
|-------------------------|--|
| ADD2 Card | Advanced Digital Display Card – 2 nd Generation. This card provides digital display options for an Intel Graphics Controller that supports ADD2+ cards. It plugs into a x16 PCI Express* connector but uses the multiplexed SDVO interface. The card adds Video In capabilities to platform. This Advanced Digital Display Card will not work with an Intel Graphics Controller that supports DVO and ADD cards. It will function as an ADD2 card in an ADD2 supported system, but video in capabilities will not work. |
| ACPI | Advanced Configuration and Power Interface |
| Core | The internal base logic in the (G)MCH |
| DDR2 | A second generation Double Data Rate SDRAM memory technology |
| DMI | (G)MCH-Intel [®] ICH9 Direct Media Interface |
| DVI | Digital Video Interface. Specification that defines the connector and interface for digital displays. |
| FSB | Front Side Bus. FSB is synonymous with Host or processor bus |
| GMA 3100 | Intel [®] Graphic Media Accelerator 3100 |
| Intel [®] ICH9 | Eighth generation I/O Controller Hub component that contains additional functionality compared to previous ICHs. The I/O Controller Hub component contains the primary PCI interface, LPC interface, USB2, ATA-100, and other I/O functions. It communicates with the (G)MCH over a proprietary interconnect called DMI. |
| IGD | Internal Graphics Device. |
| LVDS | Low Voltage Differential Signaling. A high speed, low power data transmission standard used for display connections to LCD panels. |



Table 1. Definition (Sheet 2 of 2)

| Term | Description |
|--------------|--|
| ADD2 Card | Advanced Digital Display Card – 2 nd Generation. This card provides digital display options for an Intel Graphics Controller that supports ADD2+ cards. It plugs into a x16 PCI Express* connector but uses the multiplexed SDVO interface. The card adds Video In capabilities to platform. This Advanced Digital Display Card will not work with an Intel Graphics Controller that supports DVO and ADD cards. It will function as an ADD2 card in an ADD2 supported system, but video in capabilities will not work. |
| MCH | Memory Controller Hub component that contains the processor interface, DRAM controller, and x16 PCI Express* port (typically, the external graphics interface). It communicates with the I/O controller hub (Intel ICH9) and other I/O controller hubs over the DMI interconnect. In this document MCH refers to the Intel® Q35 MCH component. |
| MEC | Media Expansion Card, also known as ADD2+ card. Refer to ADD2+ term for description. |
| PCI Express* | Third Generation input/output graphics attach called PCI Express* Graphics. PCI Express* is a high-speed serial interface whose configuration is software compatible with the existing PCI specifications. The specific PCI Express* implementation intended for connecting the (G)MCH to an external Graphics Controller is a x16 link and replaces AGP. |
| Primary PCI | The Primary PCI is the physical PCI bus that is driven directly by the ICH9 component. Communication between Primary PCI and the (G)MCH occurs over DMI. Note that the Primary PCI bus is not PCI Bus 0 from a configuration standpoint. |
| SDVO | Serial Digital Video Out (SDVO). SDVO is a digital display channel that serially transmits digital display data to an external SDVO device. The SDVO device accepts this serialized format and then translates the data into the appropriate display format (i.e., TMDS, LVDS, TV-Out). This interface is not electrically compatible with the previous digital display channel - DVO. For the 82Q965 GMCH, it will be multiplexed on a portion of the x16 graphics PCI Express* interface. |
| SDVO Device | Third party codec that uses SDVO as an input. May have a variety of output formats, including DVI, LVDS, HDMI, TV-out, etc. |
| SMI | System Management Interrupt. SMI is used to indicate any of several system conditions (such as, thermal sensor events, throttling activated, access to System Management RAM, chassis open, or other system state related activity). |
| Rank | A unit of DRAM corresponding to eight x8 SDRAM devices in parallel or four x16 SDRAM devices in parallel, ignoring ECC. These devices are usually, but not always, mounted on a single side of a DIMM. |

1.4 Support Options

1.4.1 Electronic Support Systems

Intel's site on the World Wide Web (<http://www.intel.com/>) provides up-to-date technical information and product support. This information is available 24 hours per day, 7 days per week, providing technical information whenever you need it.

Product documentation is provided online in a variety of web-friendly formats at:

[\(http://developer.intel.com/\)](http://developer.intel.com/)

1.4.2 Additional Technical Support

If you require additional technical support, please contact your field sales representative or local distributor.

1.5 Product Literature

Product literature can be ordered from the following Intel literature centers:



Table 2. Intel Literature Centers

| Location | Telephone Number |
|----------------------|-------------------|
| U.S. and Canada | 1-800-548-4725 |
| U.S. (from overseas) | 708-296-9333 |
| Europe (U.K.) | 44(0)1793-431155 |
| Germany | 44(0)1793-421333 |
| France | 44(0)1793-421777 |
| Japan (fax only) | 81(0)120-47-88-32 |



2.0 Development Kit Hardware Features

This chapter describes the features of the Intel® Q35 Development Kit. These recommendations would largely apply to other designs incorporating Intel® Q35 chipset. This documentation should be used in conjunction with the datasheets, specification updates and platform design guides for the Intel® I/O Controller Hub 9 (ICH9) Family and the Intel® Q35 Express Chipset. Contact your Intel representative for the availability of these documents.

2.1 Intel® Q35 Express Chipset Development Kit Overview

Figure 1 shows overview of the major features present on the development kit board. Refer to next page for system block diagram of the development kit's motherboard.

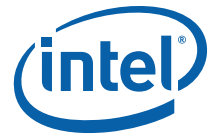
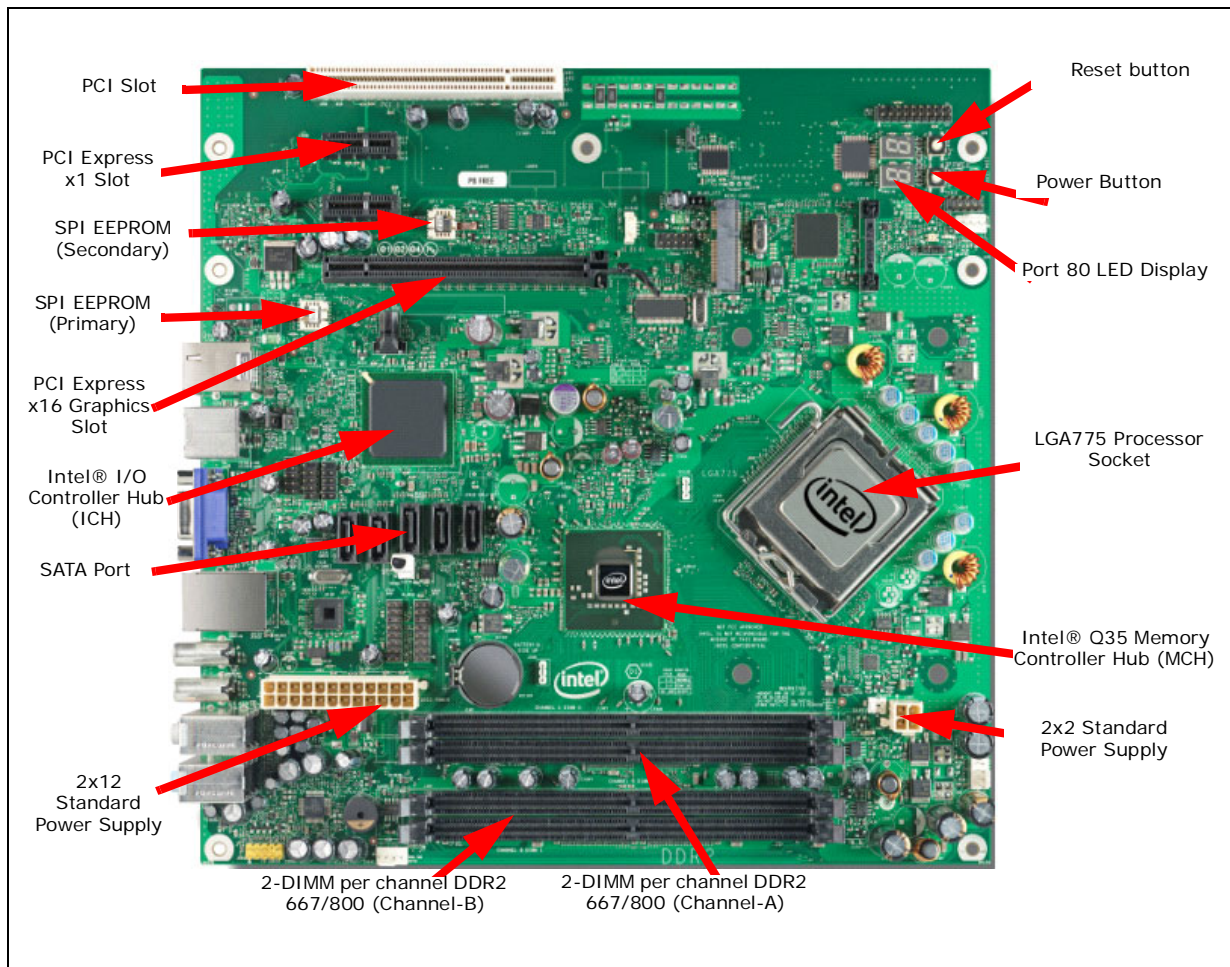

Figure 1. Board Features



2.2 System Block Diagram

This section will document the common features that are applicable to the Intel[®] Core[™] 2 Duo Processor and Intel[®] Q35 Express Chipset Development Kit. [Figure 2](#) shows a simple block diagram of the development kit.

Figure 2. Intel® Q35 Express Chipset Development Kit block diagram

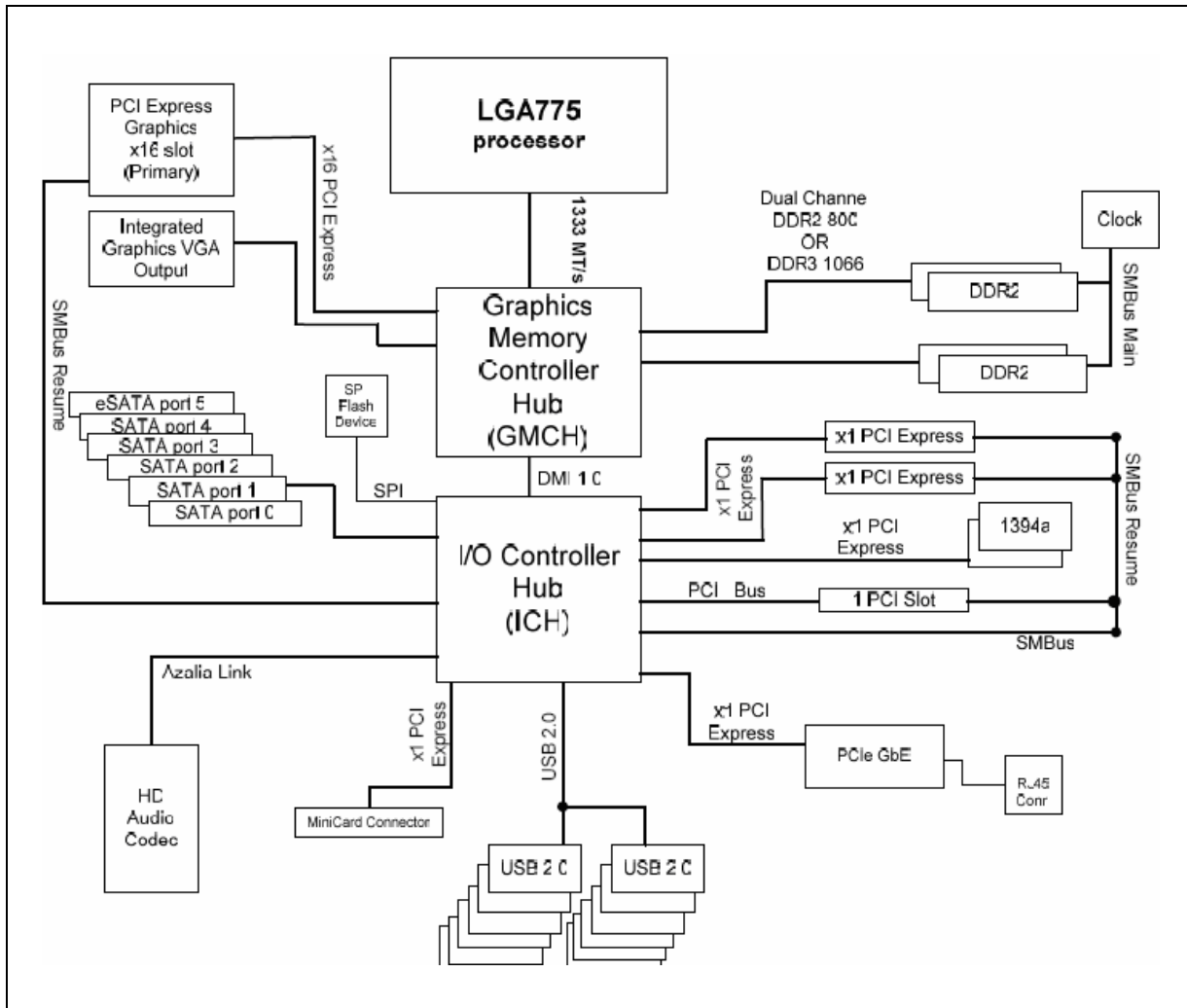

2.3 Development Kit Inventory Checklists

This section describes major hardware items which should be available on this development kit.

Table 3. Development Kit Hardware Items

| |
|---|
| 1x 4-Layer Micro-BTX form factor (targeted dimensions: 10.5" x 10.4") motherboard |
| 1x Intel® Core™ 2 Duo E6400 Processors in the LGA775 Socket |
| 2x 1 GBytes DDR2 800 DIMM |
| 1x BTX Heatsink with fan |
| 1x CD-ROM contain chipset drivers (this include Intel® GMA3100 driver) |
| 8x hex standoffs and 4x screws for bench top usage |

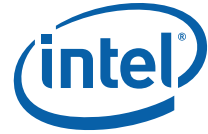
**Table 4. Development Kit Board Specification**

| |
|--|
| 1 PCI Express x16, 2 PCIe x1, 1 PCI expansion slots |
| 1394a |
| <ul style="list-style-type: none"> • 1 front panel headers for support of 1 port • 1 back panel port |
| Universal Serial Bus 2.0 |
| <ul style="list-style-type: none"> • 2 front panel headers for support of 4 ports • 1 internal header for support of 2 ports • 6 back panel ports |
| 6 SATA 3 Gb/sec ports (1 port used for eSATA) |

Table 5. Internal I/O headers

| |
|----------------------------------|
| 2x5 Front Panel I/O header |
| 2x7 Front Panel audio header |
| 1x2 Chassis intrusion header |
| 3 four-wire fan headers |
| 2x8 High Definition audio header |

Table 6. Supported Intel Technologies (Sheet 1 of 2)

| Technology | Features/support | Reference Documentation |
|---|--|---|
| Intel® Active Management Technology with System Defense feature (Intel® ICH8 DO only) | <ul style="list-style-type: none"> • Enables remote, down-the-wire management of out-of-band networked systems regardless of system state, helping improve efficiency, asset management and system security and availability. • System Defense Feature can help block incoming software attacks, isolate a device from the network if infected, and proactively alert embedded system vendors if critical software agents are missing. | http://www.intel.com/technology/platform-technology/intel-amt/ |
| Intel® Graphics Media Accelerator 3000 | <ul style="list-style-type: none"> • Dual independent display expands viewable workspace for devices such as point-of-sale terminals with two monitors. • Provides next-generation graphics performance for advanced embedded operating systems. • Delivers richer visual color and picture clarity without the need for additional discrete graphics cards. | http://www.intel.com/products/chipsets/gma3000/demo/demo.html |



Table 6. Supported Intel Technologies (Sheet 2 of 2)

| Technology | Features/support | Reference Documentation |
|--|---|---|
| Intel® Fast Memory Access | <ul style="list-style-type: none"> Helps improve system performance by optimizing use of available memory bandwidth and reducing latency of memory access by monitoring all pending read/write requests; allows safe and efficient overlapping of commands on all system bus interfaces. | http://www.intel.com/products/chipsets/q965_q963/demo/demo.html |
| Intel® Matrix Storage Technology (Intel® ICH8 DO only) | <ul style="list-style-type: none"> With a second hard drive added, provides quicker access to digital photo, video and data files with RAID 0, 5 and 10, and greater data protection against a hard disk drive failure with RAID 1, 5 and 10. | http://www.intel.com/design/chipsets/matrixstorage_sb.htm |
| Intel® High Definition Audio | <ul style="list-style-type: none"> Enables premium digital sound and delivers advanced features such as multiple audio streams and jack re-tasking. Support for microphone array enables enhanced voice capture for high-quality input to voice-driven activities. | http://www.intel.com/design/chipsets/hdaudio.htm |

Table 7. Additional Features

| |
|--|
| 6 Analog audio connectors and 2 digital audio connectors |
| Piezo speaker for BIOS POST codes |
| BIOS configuration jumper |
| Clear CMOS jumper |
| Power Button |
| Reset Button |
| XDP connector |

2.4 Processor Support

The Intel® Q35 Development Kit supports the following processors in the LGA775 Socket with FSB of 800/1067/1333 MHz.

These processors, with long-life support are also supported by this development kit:

- Intel® Core™ 2 Duo E6400 (Included in the development kit)
- Intel® Core™ 2 Duo E4300
- Intel® Pentium® Dual-Core Processor E2160
- Intel® Celeron® 440

Refer to this link for other processors which is also supported by Intel® Q35 Express Chipset.

http://developer.intel.com/products/chipsets/Q35_Q33/index.htm

2.5 System Memory

The Intel® Q35 Express Chipset supports two types of memory organization. These are interleaved mode and asymmetric mode. The Q35 supports:

Listed here are the summary of the system memory supported.



- Non-ECC DDR2 (667/800)
- 512Mb, 1Gb and 2Gb technology
- 4 DIMMs, 4GB maximum per channel, 8GB total memory
- *Dual channel (Interleaved) mode.* This mode offers the highest throughput for real world applications. Dual channel mode is enabled when the installed memory capacities of both DIMM channels are equal. Technology and device width can vary from one channel to the other but the installed memory capacity for each channel must be equal. If different speed DIMMs is used between channels, the slowest memory timing will be used.
- *Single channel (Asymmetric) mode.* This mode is equivalent to single channel bandwidth operation for real world applications. This mode is used when only a single DIMM is installed or the memory capacities are unequal. Technology and device width can vary from one channel to the other. If different speed DIMMs is used between channels, the slowest memory timing will be used.

Figure 3 illustrates the memory channel and DIMM configuration.

Figure 3. Memory Channel and DIMM Configuration

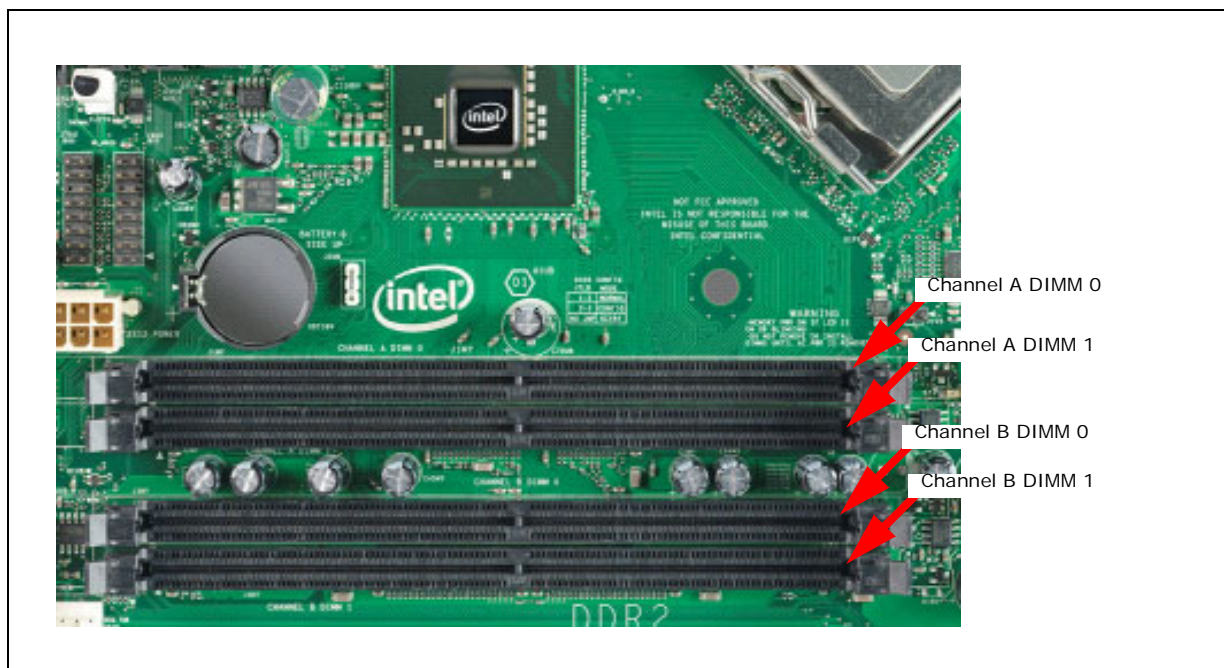

2.5.1 Dual Channel (Interleaved) Mode Configurations

Figure 4 shows a dual channel configuration using two DIMMs. In this example, the DIMM 0 sockets of both channels are populated with identical DIMMs.

Figure 4. Dual Channel (Interleaved) Mode Configuration with 2x DIMMs

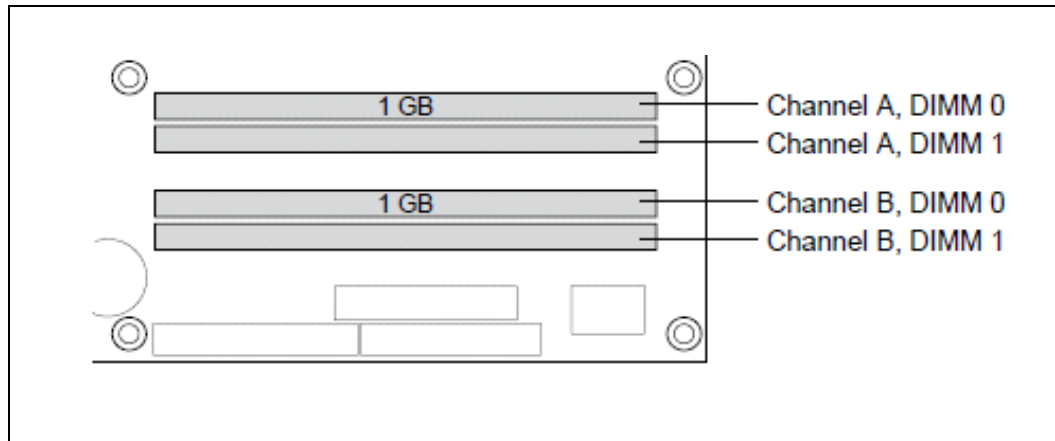

Figure 5 shows a dual channel configuration using 3 DIMMs. In this example, the combined capacity of the two DIMMs in Channel A equal the capacity of the single DIMM in the DIMM 0 socket of Channel B.

Figure 5. Dual Channel (Interleaved) Mode Configuration with 3x DIMMs

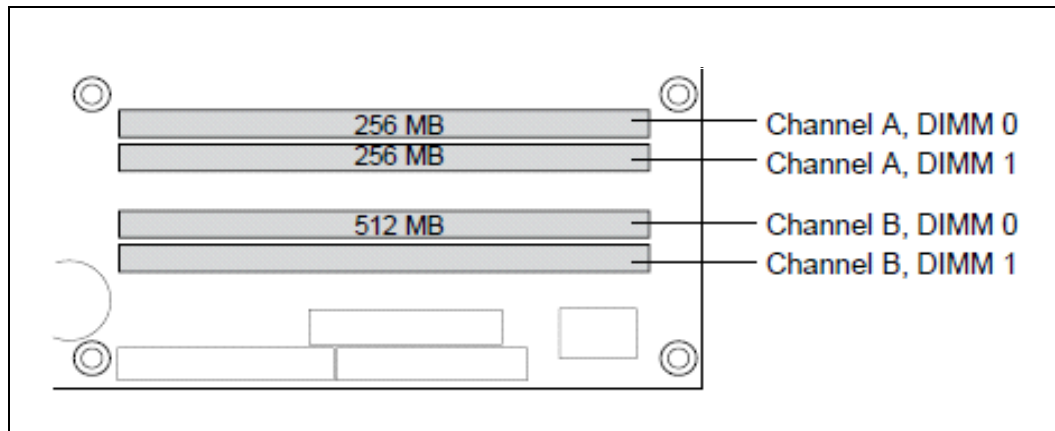
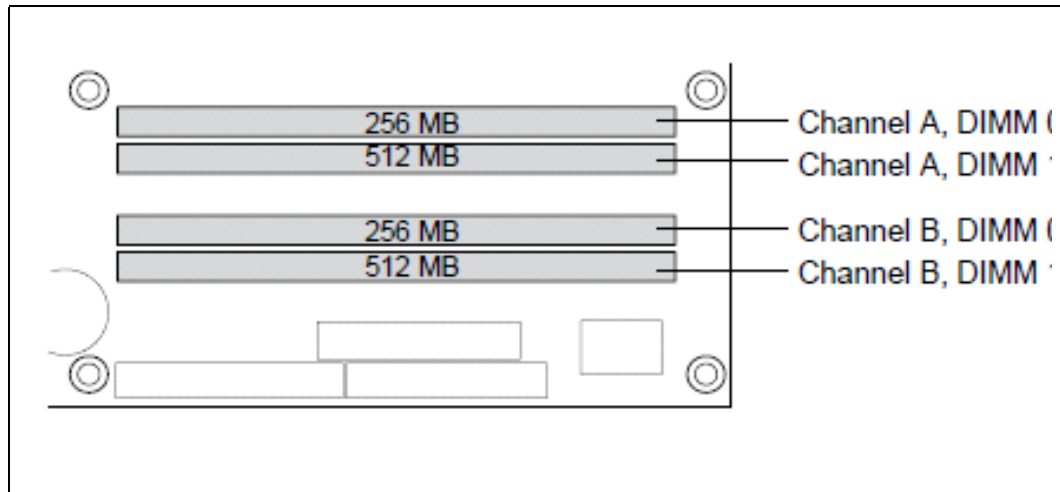

Figure 6 shows a dual channel configuration using 4 DIMMs. In this example, the combined capacity of the 2x DIMMs in Channel A equals the combined capacity of the 2x DIMMs in Channel B. Also, the DIMMs are matched between DIMM 0 and DIMM 1 of both channels.



Figure 6. Dual Channel (Interleaved) Mode Configuration with 4x DIMMs



2.5.2 Single Channel (Asymmetric) Mode Configurations

Figure 7 shows a single channel configuration using 1x DIMM. In this example, only the DIMM 0 socket of Channel A is populated. Channel B is not populated.

Figure 7. Single Channel (Asymmetric) Mode Configuration with 1x DIMM

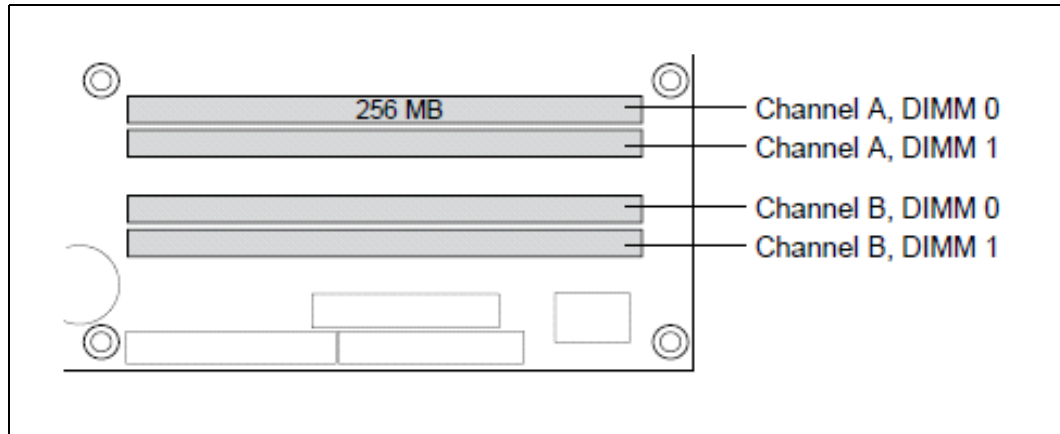
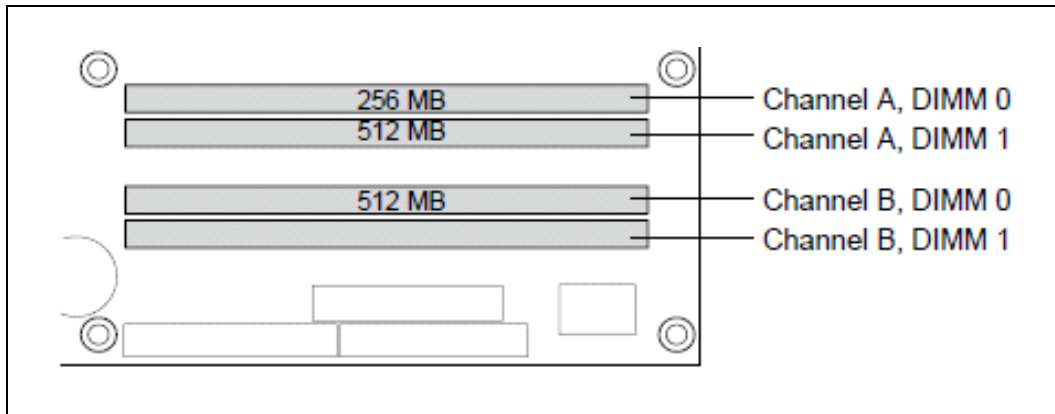

Figure 8 shows a single channel configuration using 3x DIMMs. In this example, the combined capacity of the 2x DIMMs in Channel A does not equal the capacity of the single DIMM in the DIMM 0 socket of Channel B.

Figure 8. Single Channel (Asymmetric) Mode Configuration with 3x DIMMs



2.6 Back-Panel Connectors

Figure 9 shows back-panel connectors for the development kit.

Figure 9. Back-panel Connectors

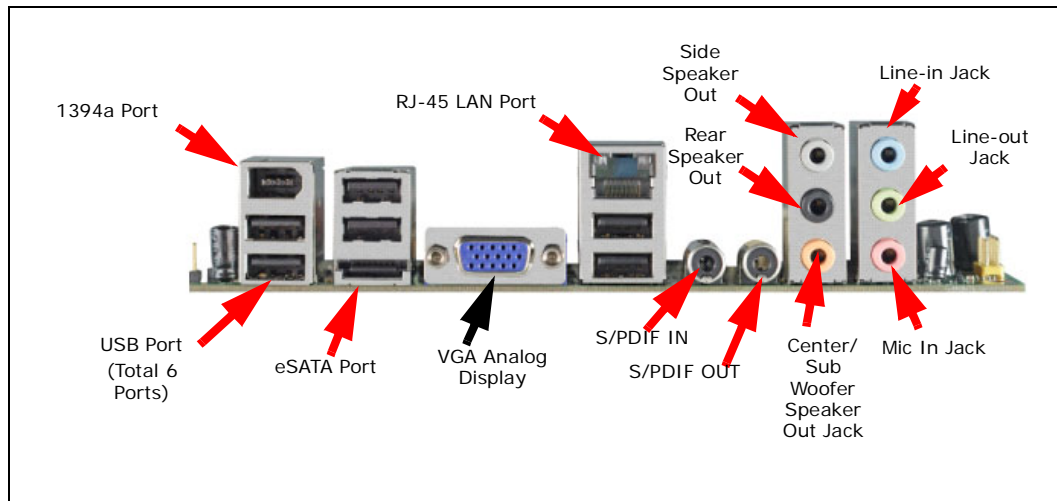

2.6.1 Audio-Connectors

This development kit board supports up to 7.1-channel audio configuration. It is backward compatible with 5.1, 2.1 and stereo (2-channel) audio configuration as well.

Line In Jack (Light Blue)

This audio jack is used to for line in devices, including some optical devices.

Line Out Jack (Light Green)

This audio jack is used for line out devices. It's used in 2.1, 5.1 and 7.1 channel- audio configuration. It can be used for headphone and stereo speaker as well.

Mic In Jack (Pink)

This audio jack is use for microphone input.



Center/Subwoofer Speaker Out Jack (Orange)

This audio jack is used to connect to center/subwoofer speakers in a 5.1 and 7.1-channel audio configuration.

Rear Speaker Out (Black)

This audio jack is used to connect to rear speakers in a 5.1 and 7.1-channel audio configuration.

Side Speaker Out (Gray)

This audio jack is used to connect to side speakers for 7.1-channel audio configuration only.

2.6.2 RJ-45 LAN Connector with Integrated LEDs

Two LEDs are built into the RJ-45 LAN connector (as shown in [Figure 10](#)). [Table 8](#) describes the LED states when the board is powered up and the Gigabit LAN subsystem is operating.

Figure 10. LAN Connector LED locations

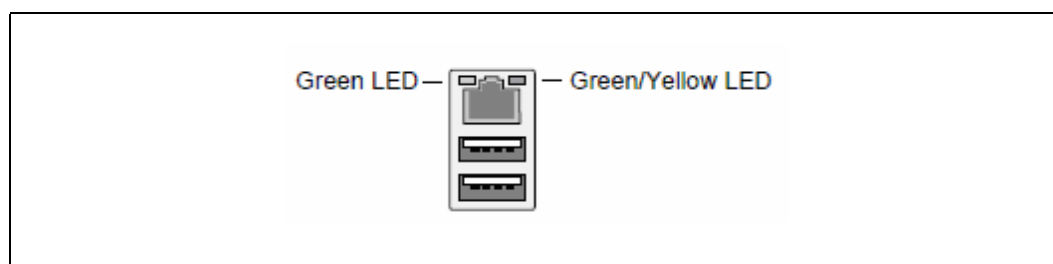

Table 8. LAN Connector LED status

| LED | Color | LED State | Condition |
|-------|--------|-----------|--------------------------------------|
| Left | Green | Off | LAN link is not established |
| | | On | LAN link is established |
| | | Blinking | LAN activity is occurring |
| Right | N/A | Off | 10 Mbits/sec data rate is selected |
| | Green | On | 100 Mbits/sec data rate is selected |
| | Yellow | On | 1000 Mbits/sec data rate is selected |

2.6.3 USB Port

The USB port supports the USB 1.1/2.0 specification.

2.6.4 Coaxial S/PDIF In/Out Connector

This connector provides digital audio input and output from external audio system that supports digital coaxial audio. Ensure that the audio system provides a coaxial digital-in/out connector.

2.6.5 eSATA Port

This development kits support the first generation eSATA port.

2.7 Debug Features

2.7.1 Extended Debug Probe (XDP)

The reference board provides a JTAG-compliant test access port (TAP) for attachment of an XDP connector. The XDP connector and associated circuitry enable the use of the ITP for the particular processor to interrupt the boot sequence and view processor status.

The XDP connector is located on the backside of the board at location J2BC. Refer to [Figure 11](#) to the XDP connector location. Take notes that ITP-XDP SSA connector is needed. Refer to diagram below for the ITP-XDP SSA connector.

Figure 11. ITP-XDP Connector location (J2BC)

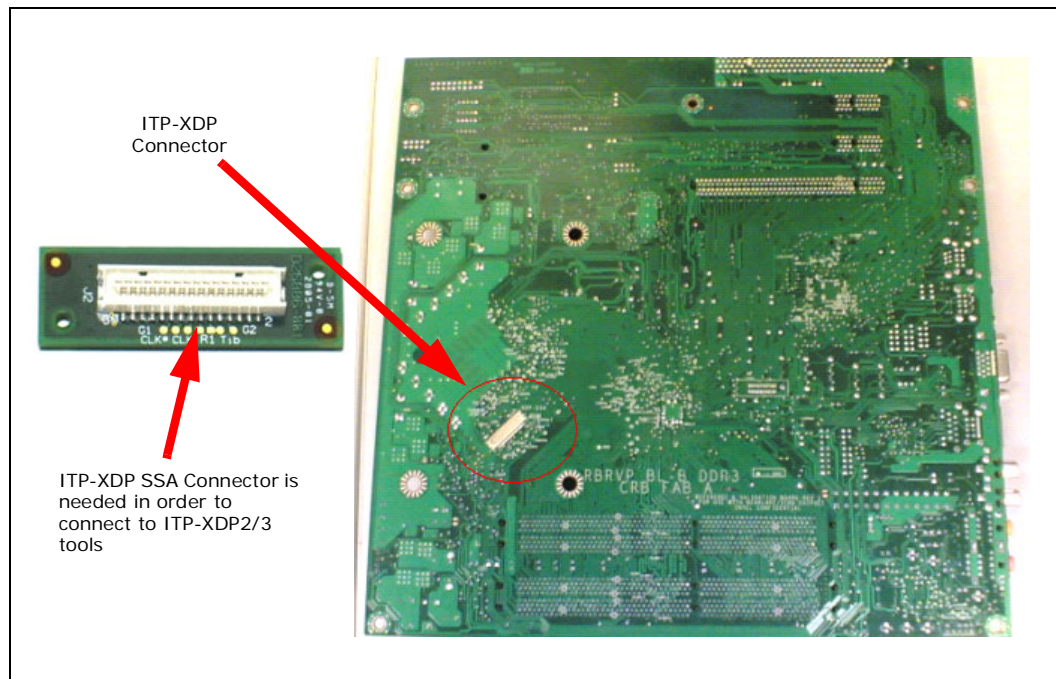

2.7.2 Power LEDs

Power LEDs on the board indicate when standby power is being applied to the standby planes. When lit they indicate that no DIMM modules should be inserted or removed. To install or replace DIMM modules insure that AC power to the power supply is removed by unplugging the AC power cord from the power supply or placing the switch on the power supply to the open position.

Caution: Removing DIMM modules when the standby power LEDs is lit could result in damage to the memory devices on those modules.

2.7.3 Port 80 POST Code LEDs

Two LEDs display the POST codes output from Port 80 to indicate the progress of the boot sequence or display the POST code of the last operation successfully completed during the boot sequence. Please refer to [Section 3.4](#) for more information on Port 80 code reference.



2.7.4 Voltage Reference

See Table 9 for details of the expected voltage levels for each voltage rail on the CRB.

Table 9. Voltage Reference detail

| Voltage Rail | Expected Voltage | Voltage Rail | Expected Voltage |
|-----------------|------------------|--------------------|------------------|
| VCC | 5.0 | V_1P25_CORE | 1.25 |
| VCC3 | 3.3 | V_1P25_CL_MCH | 1.25 |
| +12V | 12 | V_1P25_PCIEEXPRESS | 1.25 |
| -12V | -12 | V_SM | 1.8 |
| V_5P0_STBY\G | 5.0 | V_SM_VTT | 0.9 |
| V_3P3_STBY\G | 3.3 | V_3P3_CL | 3.3 |
| V_1P5_ICH | 1.5 | V_3P3_PCIVAUX | 3.3 |
| V_1P05_ICH_CORE | 1.05 | VDD_CLK | 3.3 |
| V_FSB_VTT | 1.2 | VCC_CLK_IO | 0.8 |
| VCCP | Varies | | |

2.8 Development Kit Major Connectors and Jumpers

Figure 12 shows major jumpers and headers used on the development kit.

Figure 12. Major Jumper and Header Locations

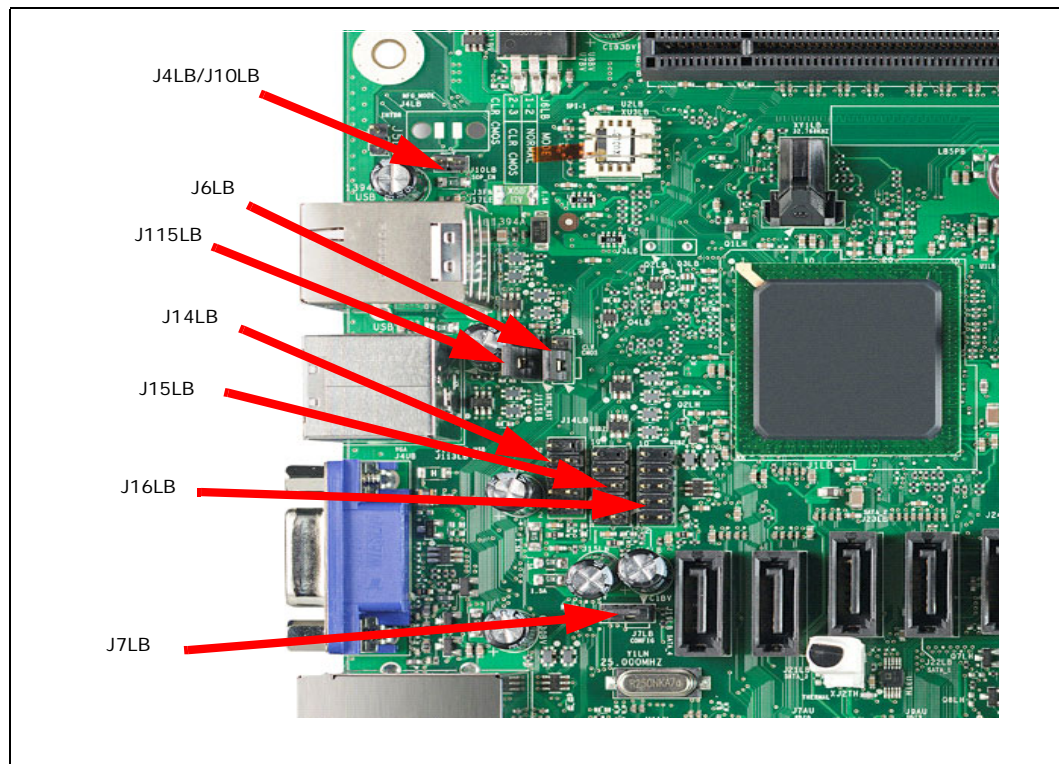



2.8.1 Jumper Functions

Table 10 provides a list of the setting definitions for the Intel® Core™ 2 Duo Processor and Intel® Q35 Express Chipset Development Kit.

Table 10. Intel® Core™ 2 Duo Processor and Intel® Q35 Express Chipset Development Kit Board Jumpers Description

| Jumper | Description | Default Position |
|------------|--|------------------|
| J6LB | Clear CMOS (1-2: Normal, 2-3: Clear CMOS) | 1-2 |
| J115LB | RTC Reset (1-2: Normal, 2-3: Clear) | 1-2 |
| J7LB | Config /Recovery (1-2: Normal, 2-3: Configure, jumper removed – recovery) | 1-2 |
| J4LB/J10LB | Manufacturing mode (enable if jumper plug-in) | Empty |

2.8.2 USB 2.0 Front Panel

There are 4 USB 2.0 Front Panel can be found in the development kits board. Front panel USB header thermistor protection is required. USB front panel is label as U14LB, U15LB, U16LB and U1FW on the boards. Refer to Figure 12 for header location of U14LB, U15LB and U16LB. Refer to Figure 13 for U1FW.

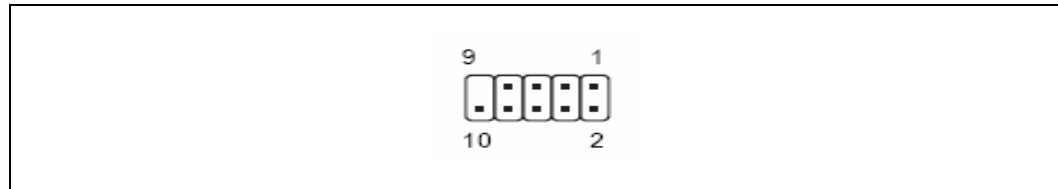

Table 11. USB Front Panel

| Pin Number | Definition |
|------------|------------|
| 1 | 5V |
| 2 | 5V |
| 3 | USB Dx- |
| 4 | USB Dy- |
| 5 | USB Dx+ |
| 6 | USB Dy+ |
| 7 | GND |
| 8 | GND |
| 9 | No pin |
| 10 | No connect |

2.8.3 1394a Header

The development kit board supports a 1394a solution on the PCIe bus with a single 1394a port on the back panel (see Figure 9) and another header supporting a 1394a port (see Figure 13). Front panel 1394a header thermistor protection is required.

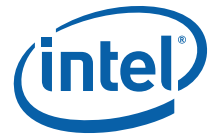

Figure 13. Location for 1394a Header and USB Front Panel

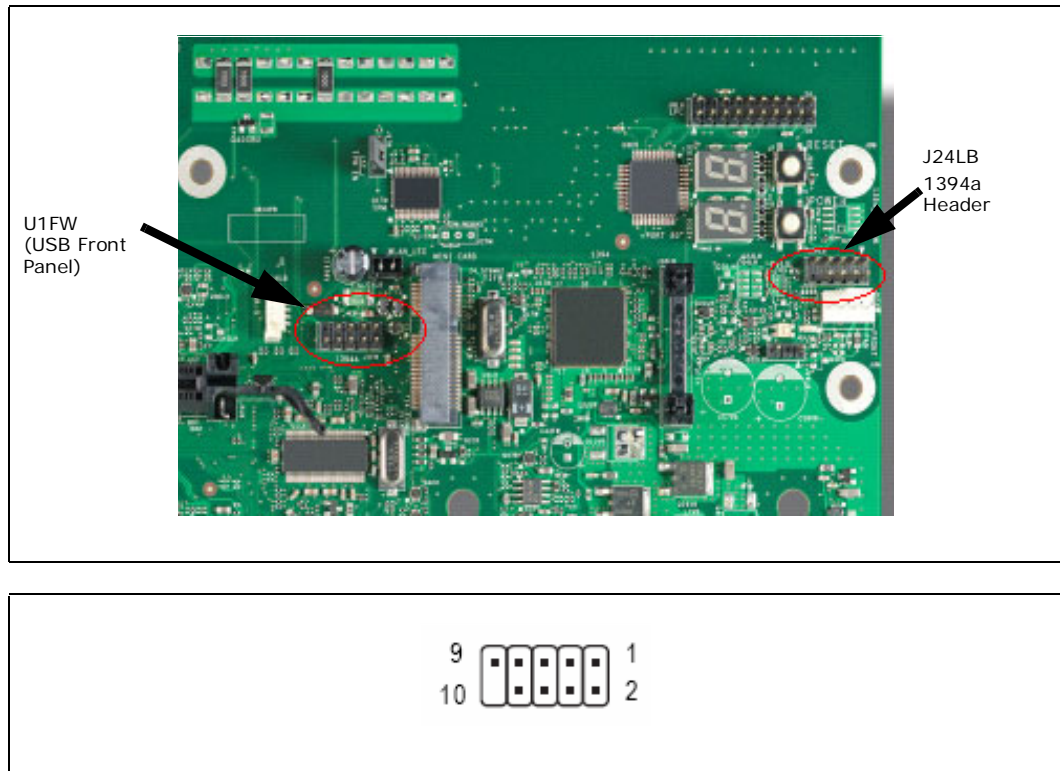

Table 12. 1394a Header

| Pin Number | Definition |
|------------|------------|
| 1 | NDCD A- |
| 2 | NSIN A |
| 3 | NSOUT A |
| 4 | NDTR A- |
| 5 | GND |
| 6 | NDSR A- |
| 7 | NRTS A- |
| 8 | NCTS A- |
| 9 | NRI A- |
| 10 | No Pin |

2.9 SPI Removal / Installation Technique

When removing or installing the SPI device, care must be taken to avoid damage to the SPI socket. The cap is constructed of plastic and can easily be damaged.

2.9.1 SPI Device Removal

To remove the SPI device from the socket, use a tweezer tip to gently pry one leg of the cap away from the socket. There is a small latch on the bottom of the leg of the cap. Once the cap latch is disengaged, the cap may be removed without causing damage to the latches on the ends.

With the SPI device exposed, move the small retaining clip to release the SPI device from the socket (see Figure 14). The SPI device should now spring up to allow removal from the socket.

Figure 14. SPI Socket with Retaining Clip

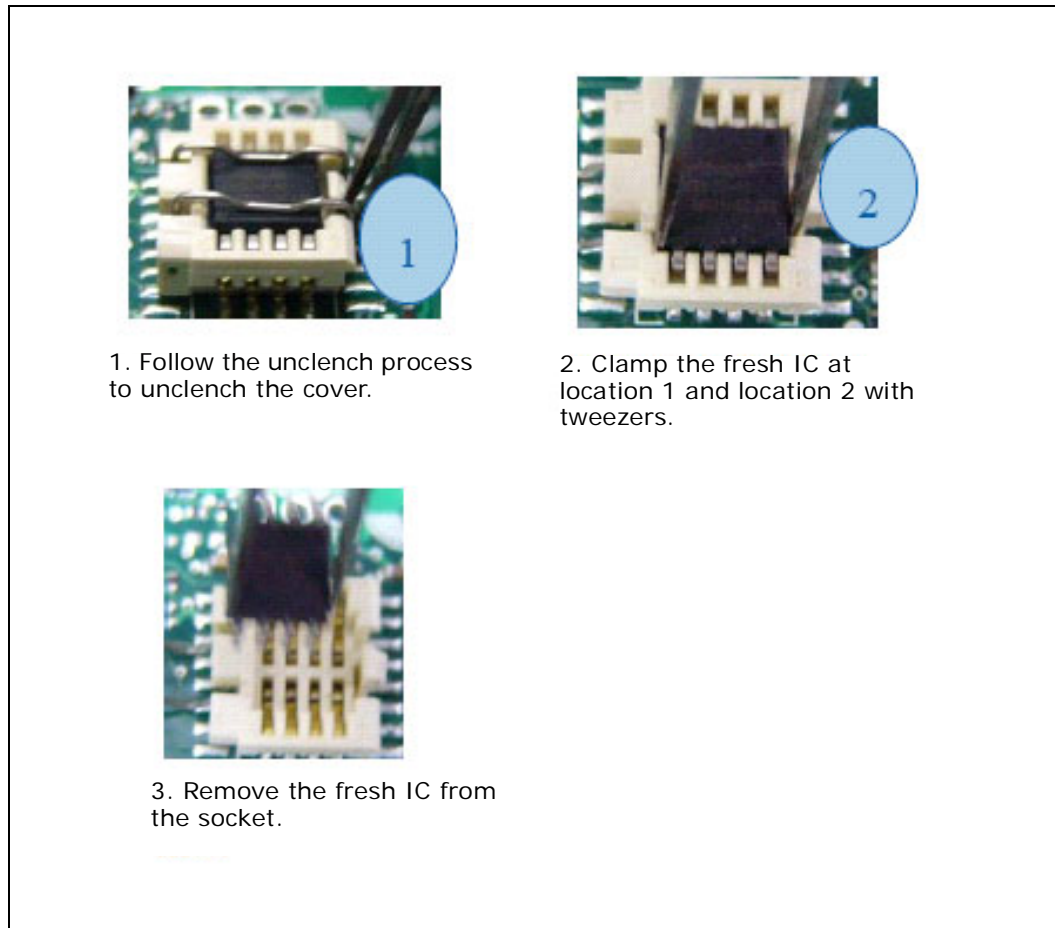

2.9.2 SPI Device Installation

To Install an SPI device in a socket, first place the side opposite from the retaining clip into the socket at an angle of approximately 15 degrees. Continue to gently insert the device into the socket until the metal retaining clip latches the device in place, as shown in Figure 15. Carefully place the cap straight down over the device until both ends latch into the socket. The installation is now complete.



Figure 15. SPI Device Installation

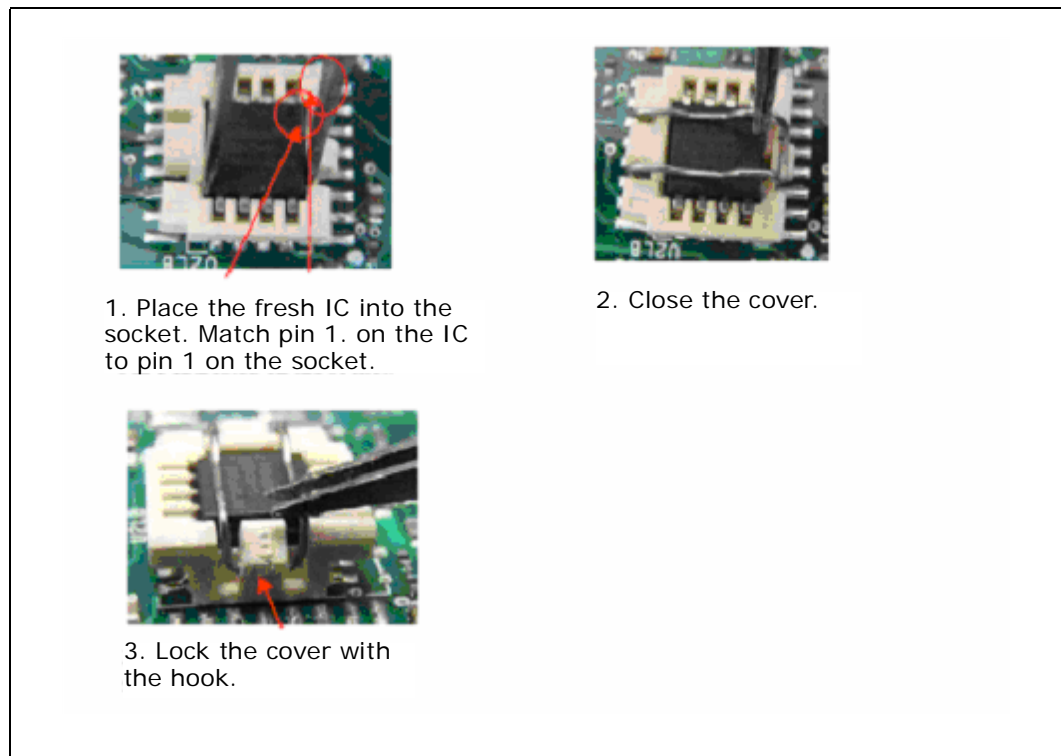

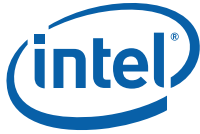

3.0 Setting Up and Configuring the Development Kit

This chapter discusses basic board set up and operation. Please refer to [Chapter 2.0](#) for the board layout, jumper setting location and the component reference designator.

3.1 Overview

The board consists of a baseboard populated with one Intel® Core™ 2 Duo processor E6400, the Intel® Q35 Express chipset, and other system board components and peripheral connectors.

Note: This board is shipped as an open system allowing for maximum flexibility in changing hardware configuration and peripherals. Since the board is not in a protective chassis, take extra precaution when handling and operating the system.

Figure 16. Intel® Q35 Development Kits

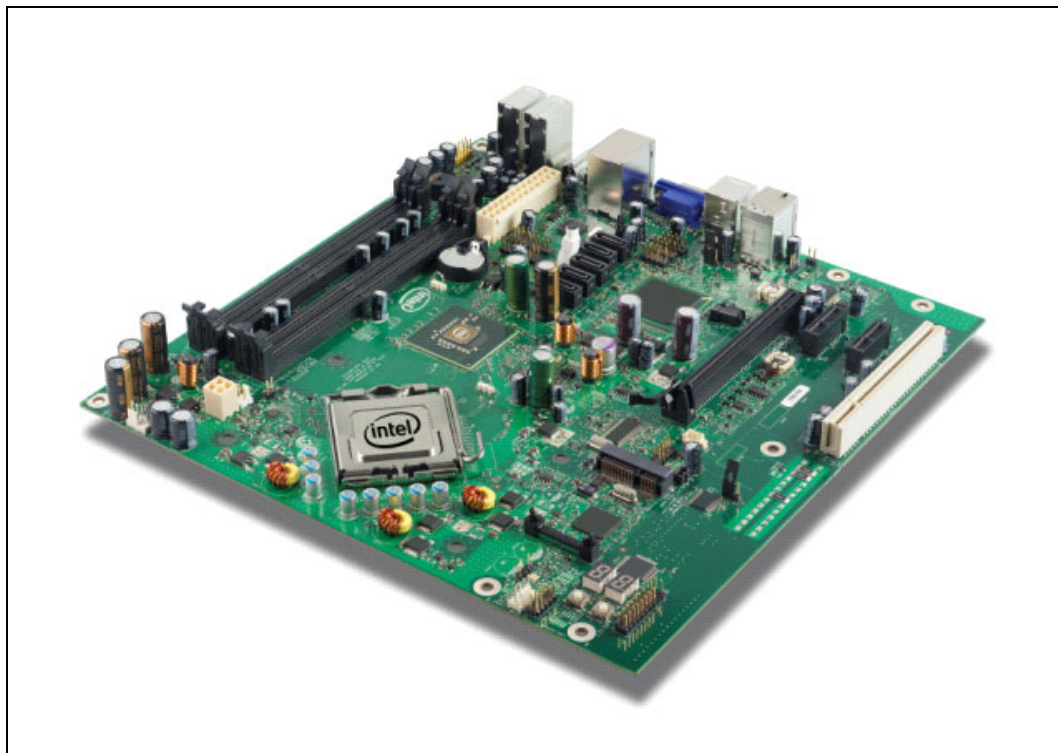

3.2 Installing Board Standoffs

Caution: The evaluation board in this development kit is shipped as an open system allowing for maximum flexibility in changing hardware configuration and peripherals in the lab

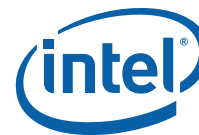

environment. Since the board is not in a protective chassis, the user is required to observe extra precautions when handling and operating the system.

The board is a standard uBTX form factor and provides non-plated mounting holes with top and bottom ground rings. If the board is not going to be used in a chassis, standoffs are included for bench top use in the lab environment.

The development kit includes eight hex standoffs and four screws to attach to the board for bench top use. Four of the standoffs are used to mount the heatsink (refer to [Section 3.3](#) for heatsink installation). Attach standoffs to the screws to the board at the following mounting hole locations.

1. Insert screw through top mounting hole for the BTX Heatsink. Refer to [Figure 17](#) for the mounting hole location.
2. Place standoff on backside of board and hand tighten to screw. Refer to [Figure 18](#) for guide.
3. Repeat for additional standoffs on the board until all standoffs are installed. Refer to [Figure 17](#) for recommended mounting hole locations.

Figure 17. Mounting Hole Locations

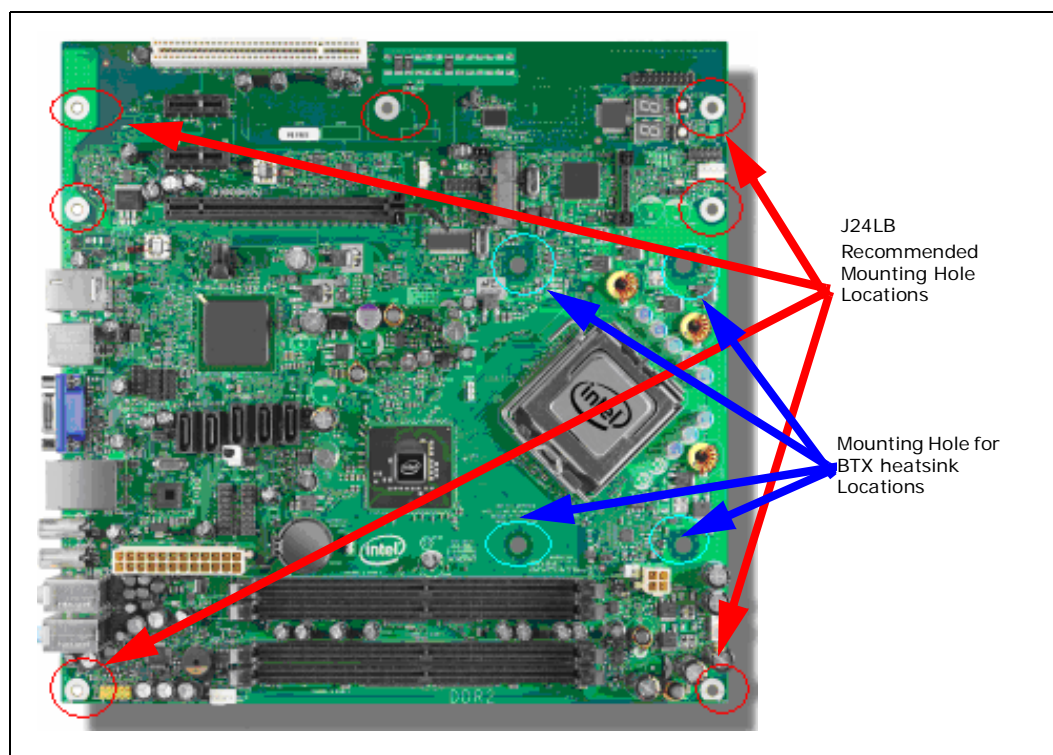

Figure 18. Mounting the Standoff for BTX Heatsink



3.3 BTX Heatsink Setup with SRM

This section describes BTX casing which uses “Support and Retention Module (SRM)” as shown in Figure 19.

Note: SRM is not included in this development kits.

Figure 19. Casing with “Support and Retention Module”

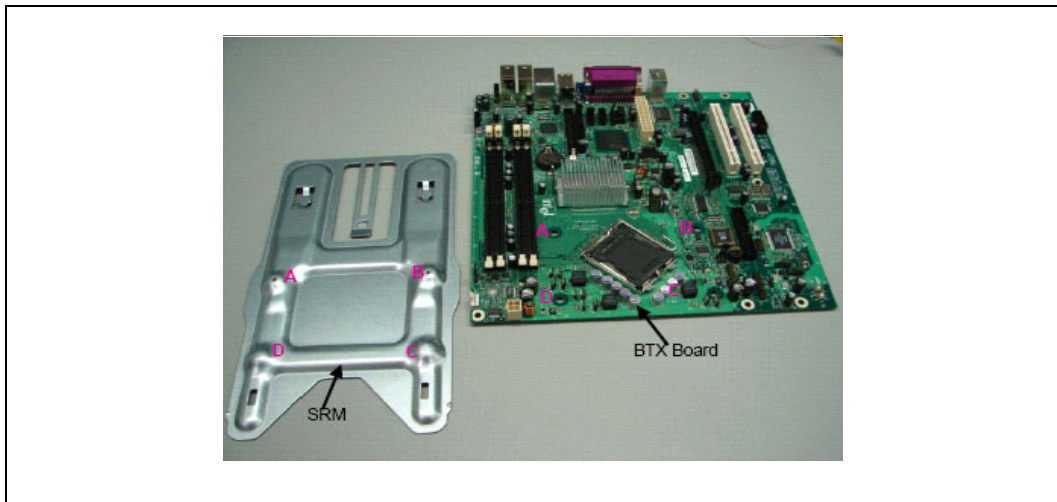

3.3.1 SRM Alignment on any BTX Board

Attach the BTX Thermal Module Assembly (TMA) over the processor to the Support and Retention Module (SRM) by following procedures described below.

1. Place the uBTX board on the Support and Retention Module (SRM) so that the holes A, B, C and D on the PCB line up with the corresponding locations on the SRM (see [Figure 19](#)). The board and SRM assembly should look like [Figure 20](#).

Figure 20. BTX board alignment on SRM



2. Place the heatsink on top of the processor. The heatsink should align with the holes on the SRM and board as shown below [Figure 21](#). Clean the surface of the processor with isopropyl alcohol before attaching the heatsink.

Figure 21. Heatsink Alignment

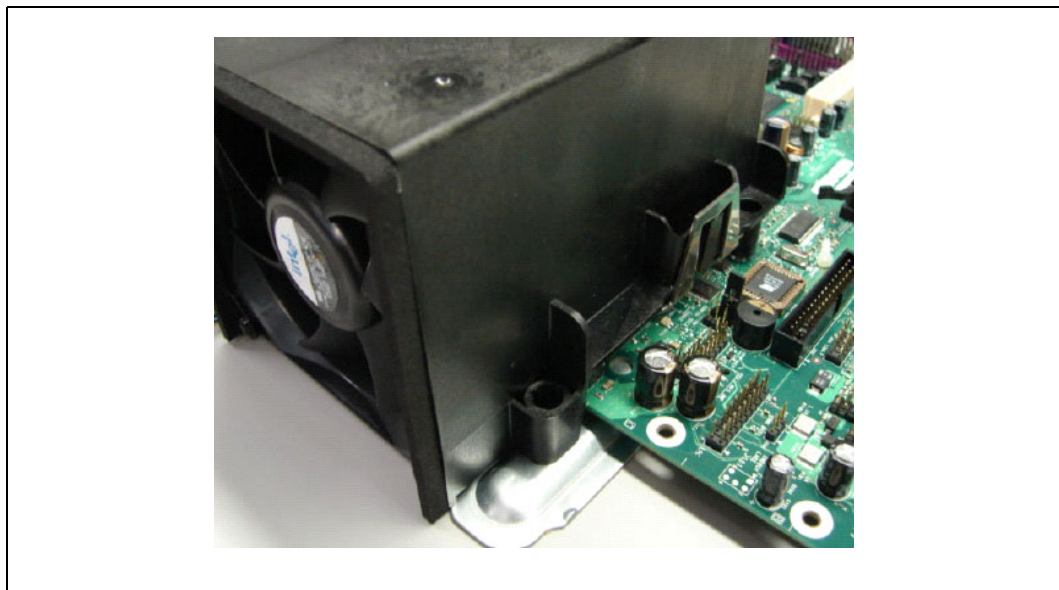

3. Use two 6-32 screws to partially tighten the rear end of the heatsink to the board and the SRM as shown in [Figure 22](#). The screw uses the threaded holes of the SRM for retention.

Figure 22. Tightening Heatsink on the SRM and Board

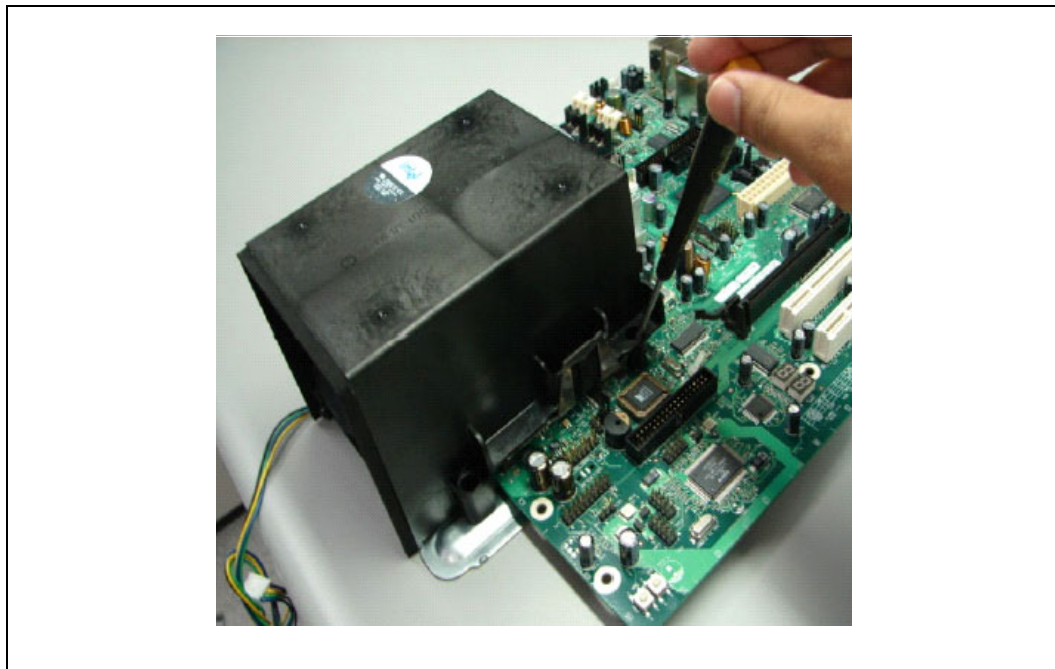

3.4 Board Setup and Configuration before Boot

Follow the steps below to operate the board.

Warning: Before starting, ensure the power supply is *not* connected to the board.

Ensure a safe and static-free work environment before removing any components from their anti-static packaging. The Development Platform is susceptible to electrostatic discharge, which may cause failure or unpredictable operation.

The Development Platform must be operated on a flame retardant surface because a chassis is not included with the platform.

Caution: Connecting the wrong cable or reversing a cable may damage the board and may damage the device being connected. Since the board is not in a protective chassis, use caution when connecting cables to the board.

Caution: The power supply cord is the main disconnect device to main power (AC power). The socket outlet should be installed near the equipment and should be readily accessible. To avoid shock, ensure that the power cord is connected to a properly wired and grounded receptacle. Do not connect/disconnect any cables or perform installation/maintenance of the boards in this product during an electrical storm. Ensure that any equipment to which this product will be attached is also connected to properly wired and grounded receptacles.

Note: Ensure that setting up the ATX power supply is the final step performed in the process of assembly.

1. Physically inspect the motherboard for obvious defects. Note that each reference board has been tested prior to distribution, but a visual check should be performed to ensure no damage has occurred during shipping.

2. Set jumpers to default positions. Refer to [Section 2.8.1](#) for default positions.
3. Install the processor and ensure the 4-pin CPU fan power connector is installed on header shown in [Figure 23](#).

Figure 23. CPU Fan location

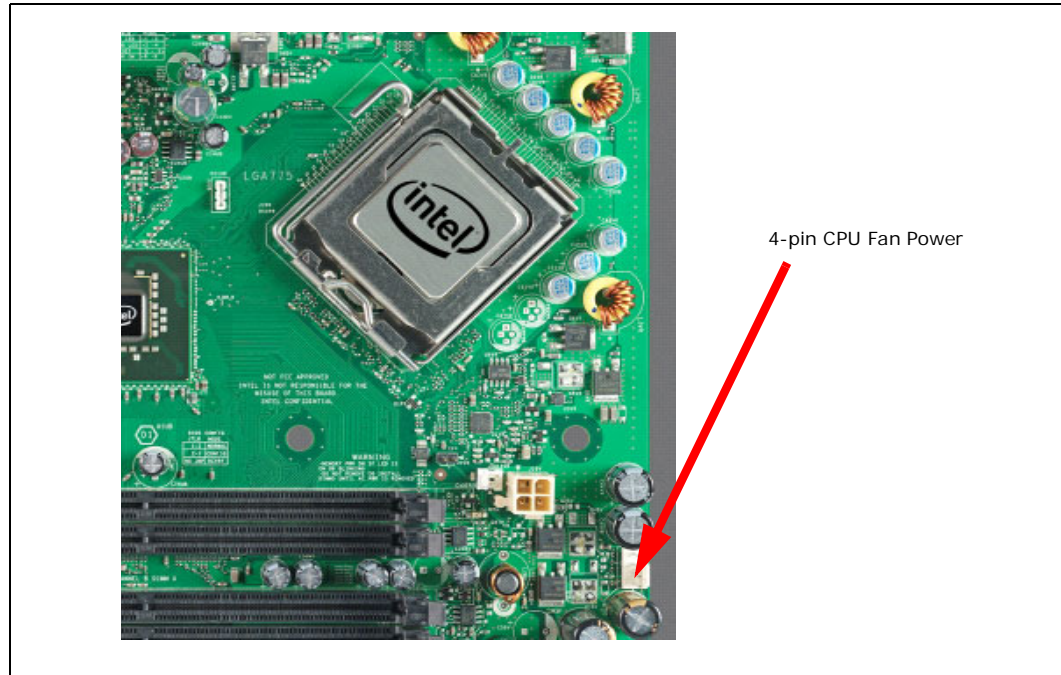

4. Install the DDR2 DIMM in the Channel A Slot 0 connector. DIMMs should never be inserted or removed unless the power supply is disconnected from the AC power source. Refer to [Section 2.5](#) for system memory configuration.
5. Connect a SATA hard drive, USB keyboard, USB mouse, and VGA monitor (video card is optional).
6. Connect a 2x12 standard power supply and 2x2 standard power supply as well. Refer to [Figure 24](#) for the location.
7. Plug the power cable into the back of the power supply, leaving the switch in the OFF position.
8. Once the board is set up, plug the cord into the power source. Switch on the power supply.
9. Press the power button. Refer to [Figure 24](#) or [Figure 1](#) for power-on button location.

Figure 24. 2x12 Standard power supply and 2x2 power supply

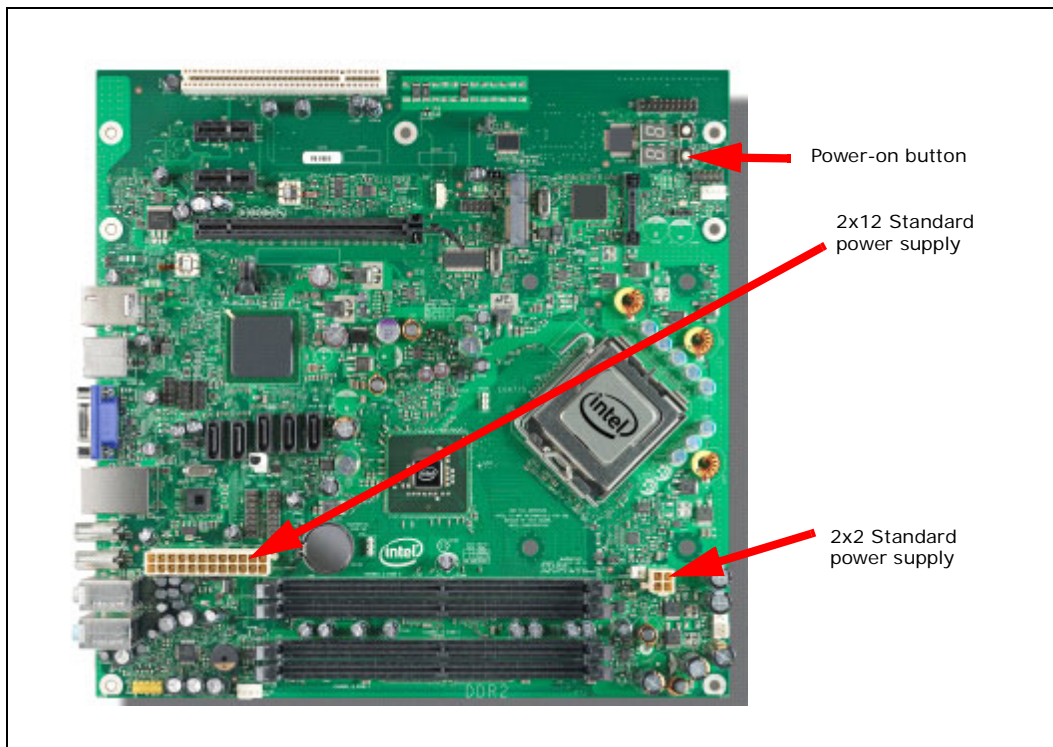

3.5 Post Codes Definitions

The CRB BIOS writes progress and error codes to Port 80 during POST. These codes are defined below.

3.5.1 Normal Post Codes

Uncompressed INIT code checkpoints

Before D1 – Early chipset and SIO initialization. NMI disabled.

| | |
|----|--|
| D1 | Perform keyboard controller BAT test. Save power-on CPUID to scratch CMOS. |
| D0 | Go to flat mode with 4GB limit. Start checksum verification. |
| D2 | Disable cache and begin sizing full memory array. |
| D3 | Additional chipset initialization, re-enable cache. |
| D4 | Test base 512 MB of memory, adjust policies and cache first 8 MB. |
| D5 | Bootblock code copied from ROM to lower system memory. BIOS now executes out of RAM. |
| D6 | Check for recovery mode and verify main BIOS checksum. |

If either in recovery mode or main BIOS checksum is bad, go to check point E0 else goto checkpoint D7.

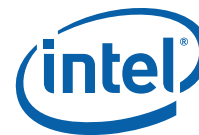

| | |
|-------|---|
| D7 | Restore CPUID value to register. Bootblock runtime module transferred to system memory. |
| D8 | Main BIOS runtime code is to be decompressed. |
| D9 | Copy main BIOS into system memory. |
| E1-E8 | OEM memory detection/configuration error. Range reserved for chipset vendors/OEMs. |
| EC-EE | |

Boot Block Recovery Code Checkpoints

| | |
|----|---|
| E0 | Initialize Floppy Controller, DMA controller and interrupt controller. |
| E9 | Set up floppy controller and data. Attempt to read from floppy. |
| EA | Enable ATAPI hardware. Attempt to read from ARMD and ATAPI CDROM. |
| EB | Disable ATAPI hardware. Jump back to checkpoint E9. |
| EF | Read error occurred on media. Jump back to checkpoint EB. |
| EF | Floppy read error. |
| F0 | Search for pre-defined recovery file in root directory. |
| F1 | Recovery file not found. |
| F2 | Start reading FAT table and analyze FAT to find the clusters occupied by the recovery file. |
| F3 | Start reading recovery file cluster by cluster. |
| F5 | Disable L1 cache. |
| FA | Check validity of recovery file configuration against configuration of FLASH part. |
| FB | Enable FLASH write through POEM and chipset specific method. Detect FLASH type. |
| F4 | Recovery file size does not match FLASH part size. |
| FC | Erase FLASH. |
| FD | Program FLASH. |
| FF | Flash program successful. Disable FLASH write. Restore CPUID into register. |

Runtime POST Code Checkpoints

| | |
|----|--|
| 03 | Disable NMI, Parity, EGA video and DMA controllers. Initialize BIOS, POST and runtime data area. |
| 04 | Verify CMOS checksum. Initialize status register A. |
| 05 | Initialize interrupt hardware and interrupt vector table. |
| 06 | Do R/W to CH-2 count reg. Initialize CH-0 as system timer. Install POSTINTCH handler. Enable IRQ0 in PIC for system timer interrupt. |



| | |
|----|---|
| 08 | Initialize CPU. The BAT test performed on KBC. Auto detection of KB and MS. |
| C0 | Early CPU Init Start. Disable cache and init local APIC. |
| C1 | Set up boot strap processor information. |
| C2 | Set up boot strap processor for POST. |
| C5 | Enumerate and set up application processors. |
| C6 | Re-enable cache for boot strap processor. |
| C7 | Early CPU Init Exit. |
| 0A | Initialize 8042 compatible keyboard controller. |
| 0B | Detect PS/2 mouse. |
| 0C | Detect keyboard in KBC port. |
| 0E | Test and initialization of different input devices. Uncompress all language, BIOS logo and Silent logo. |
| 13 | Early POST initialization of chipset registers. |
| 11 | Going to check pressing of <INS>, <END> key during power-on. |
| 12 | To init CMOS if "Init CMOS in every boot" is set or <END> key is pressed. Going to disable DMA and Interrupt controllers. |
| 13 | Video display is disabled and port-B is initialized. Chipset init about to begin. |
| 24 | Uncompress and initialize platform specific BIOS modules. |
| 30 | Initialize System Management Interrupt. |
| 2A | Initialize different devices through Device Initialization Manager (DIM). |
| 2C | Detect and initialize video adapter with optional ROM. |
| 2E | Initialize all output devices. |
| 31 | Allocate memory for ADM module. Uncompress and initialize ADM module. |
| 33 | Initialize silent boot mode. Set window to display text information. |
| 37 | Display sign-on message, CPU information, setup message and OEM specific information. |
| 38 | Initialize different devices through DIM. |
| 39 | Initialize DMAC-1 and DMAC-2. |
| 3A | Initialize RTC date/time. |
| 3B | Test and display total memory in system. |
| 3C | Mid POST initialization of chipset registers. |
| 40 | Detect peripheral devices. |
| 50 | Program memory hole or implementation specific adjustments to system memory. |
| 52 | Update CMOS memory size. Allocate memory for extended BIOS data area. |



| | |
|-------|--|
| 60 | Initialize NUM-LOCK status and program typematic rate. |
| 75 | Initialize INT-13 and prepare for IPL detection. |
| 78 | Initialize IPL devices controlled by BIOS and option ROMs. |
| 7A | Initialize option RMs. |
| 7C | Generate and write contents of ESCD in NVRAM. |
| 84 | Log errors encountered during POST. |
| 85 | Display errors and prompt for user response. |
| 87 | Execute BIOS setup if requested. |
| 8C | Late POST chipset register initialization. |
| 8D | Build ACPI tables if supported. |
| 8E | Program peripheral parameters. Enable/Disable NMI as selected. |
| 90 | Late POST initialization of system management interrupt. |
| A0 | Check for boot password. |
| A1 | Clean-up work needed before boot to OS. |
| A2 | Prepare runtime image for different BIOS modules. Initialize MS IRQ Routing Table. |
| A4 | Initialize runtime language module. |
| A7 | Display system configuration screen. Initialize CPU for boot, program MTRRs. |
| A8 | Prepare CPU for boot including final MTRR values. |
| A9 | Wait for user input at configuration display if needed. |
| AA | Uninstall POST INT1CH vector and INT09 vector. De-initialize ADM module. |
| AB | Prepare BBS for INT19 boot. |
| AC | End of POST initialization of chipset registers. |
| B1 | Save system context for ACPI. |
| 00 | Pass control to OS loader via INT19. |
| 61-70 | OEM POST error. Reserved for chipset vendors and system manufacturers. |

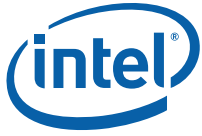

Free Manuals Download Website

<http://myh66.com>

<http://usermanuals.us>

<http://www.somanuals.com>

<http://www.4manuals.cc>

<http://www.manual-lib.com>

<http://www.404manual.com>

<http://www.luxmanual.com>

<http://aubethermostatmanual.com>

Golf course search by state

<http://golfingnear.com>

Email search by domain

<http://emailbydomain.com>

Auto manuals search

<http://auto.somanuals.com>

TV manuals search

<http://tv.somanuals.com>