

Mother Board

PT800DB / PT800DBP

PT800DBZ

User's Manual

Intel Socket 478 Processor Motherboard

VIA PT800 + VIA 8237

Revision 1.0

P / N: G03 –PT800DB

Table of Content

Manual Revision History.....	ii
Copyright Announcement.....	ii
Trademarks Notice	ii
Safety Instructions	ii
Packing Item Checklist.....	iv
Intel Pentium 4 Socket 478 Processor Thermal Solutions.....	iv
CHAPTER 1 INTRODUCTION OF PT800DB/PT800DBP/PT800DBZ MOTHERBOARD	
1-1 FEATURE OF MOTHERBOARD	1
1-2 SPECIFICATION.....	2
1-3 PERFORMANCE LIST	3
1-4 LAYOUT DIAGRAM & JUMPER SETTING	4
CHAPTER 2 HARDWARE INSTALLATION	
2-1 PRE-HARDWARE INSTALLATION.....	6
2-2 TO VERIFY THE JUMPER SETTINGS OF THE MOTHERBOARD	6
2-3 TO INSTALL THE CPU.....	8
2-3-1 GLOSSARY.....	8
2-3-2 ABOUT INTEL PENTIUM 4 478-PIN CPU	9
2-4 TO INSTALL THE SYSTEM MEMORY	9
2-5 TO INSTALL THE EXPANSION CARDS.....	10
2-5-1 PROCEDURE FOR EXPANSION CARD INSTALLATION	10
2-5-2 ASSIGNING IRQS FOR EXPANSION CARD.....	11
2-5-3 INTERRUPT REQUEST TABLE FOR THIS MOTHERBOARD.....	11
2-6 CONNECTORS AND PIN HEADERS.....	12
2-6-1 CONNECTORS.....	12
2-6-2 PIN HEADERS.....	16
2-7 STARTING UP YOUR COMPUTER	19
CHAPTER 3 INTRODUCING BIOS SETTINGS	
3-1 ENTERING SETUP	20
3-2 GETTING HELP	21
3-3 THE MAIN MENU.....	21
3-4 STANDARD CMOS FEATURES	23
3-5 ADVANCED BIOS FEATURES.....	24
3-6 ADVANCED CHIPSET FEATURES	26
3-6-1 DRAM TIMING SETTINGS.....	27
3-6-2 AGP TIMING SETTINGS.....	28
3-6-3 PCI TIMING SETTINGS.....	28
3-7 INTEGRATED PERIPHERALS	29
3-7-1 ONCHIP IDE FUNCTION.....	31
3-7-2 ONCHIP DEVICE FUNCTION	31
3-7-3 ONCHIP SUPER IO FUNCTION.....	32
3-8 POWER MANAGEMENT SETUP	33
3-8-1 WAKE UP EVENTS.....	34
3-8-1.1 IRQS ACTIVITIES.....	35
3-9 PNP/PCI CONFIGURATION SETUP	35
3-9-1 IRQ RESOURCES	37
3-10 PC HEALTH STATUS.....	37
3-11 MISCELLANEOUS CONTROL	38
3-12 LOAD STANDARD/OPTIMIZED DEFAULTS	39
3-13 SET SUPERVISOR/USER PASSWORD.....	39
CHAPTER 4 DRIVER & FREE PROGRAM INSTALLATION	
MAGIC INSTALL SUPPORTS WINDOWS 9X/NT/2K/XP	40
4-1 VIA 4 IN 1 INSTALL VIA SERVICE PACK 4 IN 1 DRIVER	41
4-2 SOUND INSTALL ALC AUDIO CODEC DRIVER.....	43
4-3 LAN INSTALL VIA 10/100MB LAN CONTROLLER DRIVER	44
4-4 PC-HEALTH WINBOND HARDWARE DOCTOR MONITORING SOFTWARE	45
4-5 MAGIC BIOS INSTALL BIOS LIVE UPDATE UTILITY	46
4-6 PC-CILLIN INSTALL PC-CILLIN2002 ANTI-VIRUS PROGRAM.....	47
4-7 USB 2.0 INSTALL VIA USB 2.0 DEVICE DRIVER	48
4-8 SATA INSTALL VIA SERIAL ATA DRIVER	49
4-9 HOW TO DISABLE ON-BOARD SOUND	50
4-10 HOW TO UPDATE BIOS.....	50

Manual Revision History

Revision	Manual Revision History	Date of Release
Rev 1.0	First edition copy of Mother Boards adopts VIA Chipsets: VIA PT800 and VIA 8237	11/24/2003

Copyright Announcement

COPYRIGHT OF THIS MANUAL BELONGS TO THE MANUFACTURER. NO PART OF THIS MANUAL, INCLUDING THE PRODUCTS AND SOFTWARE DESCRIBED IN IT MAY BE REPRODUCED, TRANSMITTED OR TRANSLATED INTO ANY LANGUAGE IN ANY FORM OR BY ANY MEANS WITHOUT WRITTEN PERMISSION OF THE MANUFACTURER.

THIS MANUAL CONTAINS ALL INFORMATION REQUIRED TO USE PT800DB/ PT800DBP MOTHER-BOARD AND WE DO ASSURE THIS MANUAL MEETS USER'S REQUIREMENT BUT WILL CHANGE, CORRECT AT ANY TIME WITHOUT NOTICE. MANUFACTURER PROVIDES THIS MANUAL "AS IS" WITHOUT WARRANTY OF ANY KIND, AND WILL NOT BE LIABLE FOR ANY INDIRECT, SPECIAL, INCIDENTAL OR CONSEQUENTIAL DAMAGES (INCLUDING DAMAGES FOR LOSS OF PROFIT, LOSS OF BUSINESS, LOSS OF USE OF DATA, INTERRUPTION OF BUSINESS AND THE LIKE).

Trademarks Notice

All brands, products, logos, trademarks, and companies are trademarks or registered trademarks of their respective companies.

AMD, Athlon™, Athlon™ XP, Thoroughbred™, and Duron™ are registered trademarks of AMD Corporation.

Award® is a registered trademark of Phoenix Technologies Ltd.

Intel® and Pentium® are registered trademarks of Intel Corporation.

Kensington and MicroSaver are registered trademarks of the Kensington Technology Group.

Microsoft is a registered trademark of Microsoft Corporation.

Netware® is a registered trademark of Novell, Inc.

NVIDIA, the NVIDIA logo, DualNet, and nForce are registered trademarks

or trademarks of NVIDIA Corporation in the United States and/or other countries.

PS/2 and OS®/2 are registered trademarks of International Business Machines Corporation.

PCMCIA and CardBus are registered trademarks of the Personal Computer Memory Card International Association.

Windows® 98/2000/NT/XP are registered trademarks of Microsoft Corporation.

****The ranking above is by the sequence of alphabets.****

Safety Instructions

1. Please read these safety instructions carefully.
2. Please keep this User's Manual for later reference.
3. Please place the equipment on a reliable flat surface before installation.
4. Make sure the voltage of the power source when you try to connect the equipment to the power outlet.
5. All cautions and warnings on the equipment should be noted.
6. Disconnect this equipment from connector before inserting add-on interfaces or modules.
7. Never pour any liquid into the opening, this could cause fire or electrical shock.
8. Explosion may occur if the battery is replaced incorrectly. Replace only with the type recommended by the manufacturer.
9. If one of the following situations arises, get the equipment checked by a service personnel:
 - a. Liquid has penetrated into the equipment.
 - b. The equipment has been exposed to moisture.
 - c. The equipment has not work well or you can not get it work according to user's manual.
 - d. The equipment has dropped and damaged.
 - e. If the equipment has obvious sign of breakage.
10. Do not leave the equipment in an humidity or unconditional environment, storage temperature above 60°C(140°C), it may damage the equipment.

Precaution: It may void the warranty if any label on the equipment been removed.

Packing Item Checklist

-
-
- ☑ PT800DB/PT800DBP/PT800DBZ Motherboard
 - ☑ Cable for IDE/Floppy
 - ☑ Cable for Serial ATA IDE Port
 - ☑ CD for motherboard utilities
 - ☑ Cable for USB Port 3/4 (Option)
 - ☑ PT800DB/PT800DBP/PT800DBZ User's Manual

Intel Pentium 4 Socket478 Processor Thermal Solutions

As processor technology pushes to faster speeds and higher performance, thermal management becomes increasingly crucial when building computer systems. Maintaining the proper thermal environment is key to reliable, long-term system operation. The overall goal in providing the proper thermal environment is keeping the processor below its specified maximum case temperature. Heatsinks induce improved processor heat dissipation through increased surface area and concentrated airflow from attached fans. In addition, interface materials allow effective transfers of heat from the processor to the heatsink. For optimum heat transfer, Intel recommends the use of thermal grease and mounting clips to attach the heatsink to the processor.

When selecting a thermal solution for your system, please refer to the website below for collection of heatsinks evaluated and recommended by Intel for use with Intel processors. Note, those heatsinks are recommended for maintaining the specified Maximum T case requirement. In addition, this collection is not intended to be a comprehensive listing of all heatsinks that support Intel processors.

For vendor list of heatsink and fan, please visit :

<http://developer.intel.com/design/Pentium4/components/index>

Chapter 1

Introduction of PT800DB/PT800DBP/PT800DBZ Motherboard

Thank you for purchasing the PT800 series which provide extremely performance and meet future specification demand.

PT800 series motherboards are adopted with advanced technologies to deliver the extremely performance for Intel Pentium 4 socket 478 processors. PT800 series motherboards also feature AGP 8X, Serial ATA RAID0, 1, USB 2.0 as well as 6-channel audio which are based on the advanced VIA PT800 chipset with FSB 800MHz and DDR 400 MHz support. Now we could know more details by reading the features of motherboards below.

1-1 Feature of motherboard

PT800 series motherboards are designed for Intel Pentium 4 Socket-478 400MHz/533MHz/800MHz Front Side Bus Frequency CPUs and the memory size expandable to 3.0GB.

By using VIA PT800 chipset which provides 800/533/400MHz Front Side Bus frequency and DDR266/333/400 SDRAM support as a obvious further step to the next generation of 400/533/800MHz processors. PT800 series motherboards also offer **ULTRA ATA 133** and **Serial ATA RAID 0, 1** functions to provide speedier HDD throughout that boosts overall system performance.

Integrated AC'97 CODEC audio on system supports 6 channel speaker for 3D Surround Effect which is fully compatible with Sound Blaster Pro® that gives you the best sound quality and compatibility. AGP 8X slot enables more complex models and detailed textures with AGP 8X graphic accelerators which creates richer and more lifelike virtual environments. VIA VT6103 LAN PHY supports 10/100Mbps data transfer rate full duplex, half duplex operation. USB control as well as capability of expanding to 8 USB function ports support USB2.0/1.1 Devices.

Built-in hardware monitor function will monitor and protect your computer which is the special design in hardware for protecting Pentium 4 CPU from burned, and will shutdown power supply automatically when CPU is overheated or the CPU cooling fan is not working.

Minor adjustable DDR memory 2.5V Voltage, AGP 1.5V Voltage, and other special functions allows user to increase CPU Host clock step by step by setting up BIOS to approach over clocking and increasing stability of the system.

1-2 Specification

Spec	Description
Design	* ATX form factor 4 layers PCB size: 30.5x21.0cm
Chipset	* VIA PT800 North Bridge Chipset * VIA VT8237 South Bridge
CPU Socket	* Support Intel Pentium 4 478-Pin package utilizes Flip-Chip Pin Grid Array (FC-PGA2) package processor * Support 1.5G~3.2G 478 Pin Pentium 4 processor * Reserves support for future Intel Pentium 4 processors
Memory Socket	* 184-pin DDR module socket x3 * Support 3 pcs DDR266/DDR333/DDR400 DDR Modules Expandable to 3.0GB
Expansion Slot & Headers	* AGP slot x1 support AGP 2.0 & 3.0 for 4X/8X mode * 32-bit PCI slot x5
Integrate IDE and Serial ATA RAID	* Two PCI IDE controllers support PCI Bus Mastering, ATA PIO/DMA and the ULTRA DMA 33/66/100/133 functions that deliver the data transfer rate up to 133 MB/s; Two Serial ATA ports provide 150 MB/sec data transfer rate for two Serial ATA Devices and offer RAID 0, 1 functions
On board LAN (for PT800DBP/ PT800DBZ)	* VIA VT6103 LAN PHY support 10/100Mbps full duplex, half duplex operation * Support Boot On LAN function
1394 (for PT800DBZ)	* VIA VT6307 1394 Controller chip * Support 2 ports Standard 1394A devices provide 400Mbps/s bandwidth
Audio	* AC'97 Digital Audio controller integrated * AC'97 Audio CODEC on board * Audio driver and utility included * Support 6 channel Speaker for 3D surround effect
BIOS	* Award 2MBit Flash ROM
Multi I/O	* PS/2 keyboard and PS/2 mouse connectors * Floppy disk drive connector x1 * Parallel port x1 * Serial port x2 * USB2.0 connector x4 * USB2.0 headers x4 (connecting cable option) * Audio connector (Line-in, Line-out, MIC & Game Port)

1-3 Performance List

The following performance data list is the testing result of some popular benchmark testing programs. These data are just referred by users, and there is no responsibility for different testing data values gotten by users (the different Hardware & Software configuration will result in different benchmark testing results.)

Performance Test Report

CPU: Intel Pentium4 Socket478
DRAM: 512MB DDR400 X1 (Kingston D328DW)
VGA Expansion Card: ATi RADEON 9700 PRO (1024x768x32BIT color)
Hard Disk Driver: IBM IC35L040AVVN07-0 (ATA-100 7200RPM)
BIOS: Award Optimal default
OS: Windows XP Professional

		200/200
3D Mark 2001SE		14900
3D Mark 2003		4666
3D Winbench 2000 (32/32bit)		438
PC Mark 2002		
CPU/Memory/HDD		6639/5309/861
Content Creation Winstone 2002		48.1
Content Creation Winstone 2003		39.8
Business Winstone2002		37.5
Winbench 99 V1.2:		
Business Disk Winmark99		10100
Hi-end Disk Winmark99		33000
Business Graphic Winmark		854
Hi-end Graphic Winmark		1870
SYS Mark 2001/2002 : SISMark 2001/2002 Rating (Internet Content Creation / Office Productivity)		
SISMark 2001		248 (255/241)
SISMark 2002		252 (326/195)
SISOFT Sandra 2003 :		
Dhrystone ALU	MIPS	8230
Whetstone FPU	MFLOPS	3306
RAM Int Buffered iSSE2	MFLOPS	2631
RAM Float Buffered iSSE2	MFLOPS	2453
Integer SSE2	IT/S	12175
Floating- Point SSE2	MB/S	12948
QUAKE3 DEMO1	FPS	236.2
DEMO2	FPS	233.3
Return to Castle Wolfenstein	FPS	128.7
WCPUID System/CPU Clock		199.98/2199.75

1-4 Layout Diagram & Jumper Setting

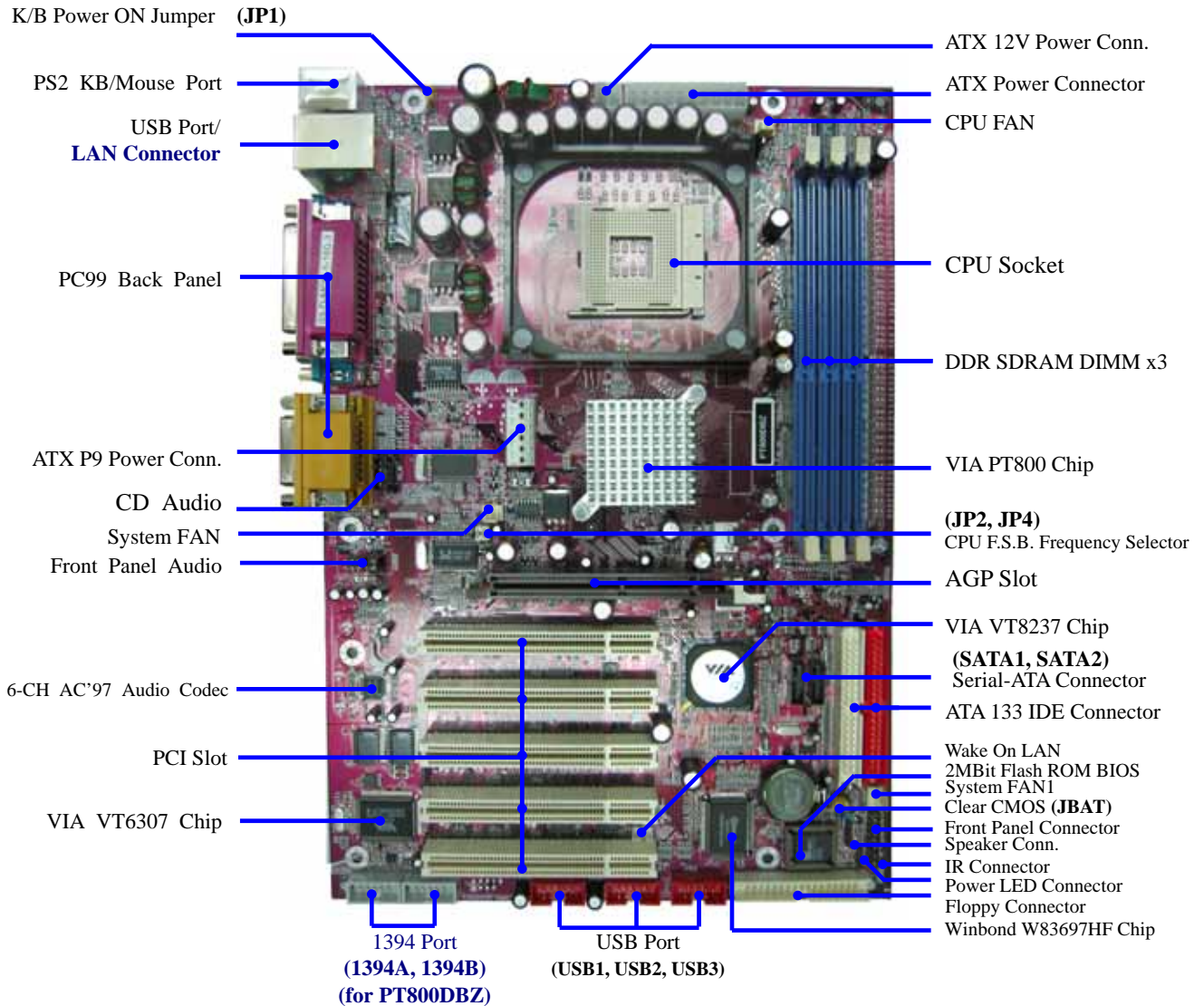
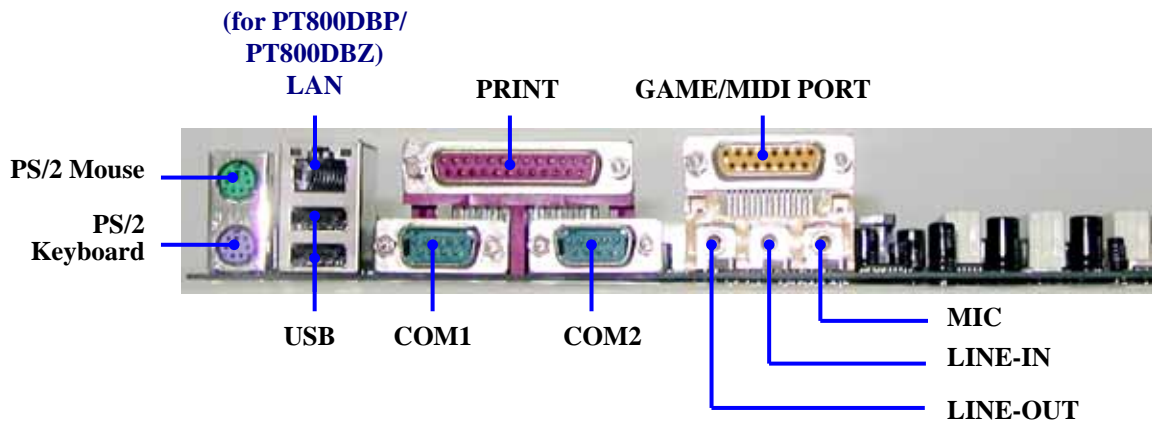

Jumpers

Jumper	Name	Description	Page
JBAT	CMOS RAM Clear	3-pin Block	P.6
JP1	Keyboard Power On Enable/Disabled	3-pin Block	P.7
JP2, JP4	CPU Front Side Bus Frequency Select	6-pin Block	P.7

Connectors

Connector	Name	Description	Page
ATXPWR	ATX Power Connector	20-pin Block	P.12
ATX12V	ATX 12V Power Connector	4-pin Block	P.12
ATXP1	ATX P9 Power Connector	6-pin Block	P.12
PS2KBM	PS/2 Mouse & PS/2 Keyboard Connector	6-pin Female	P.13
USB	USB Port Connector	4-pin Connector	P.13
LAN (P4X400DBP/ P4X400DBZ)	LAN Port Connector	RJ-45 Connector	P.13
LPT	Parallel Port Connector	25-pin Female	P.13
AUDIO_GAME	Audio/Game Connector	3 phone jack+ 15-pin Connector	P.13
COM1/COM2	Serial Port COM1/2 Connector	9-pin Connector	P.14
FDD	Floppy Driver Connector	34-pin Block	P.14
IDE1/IDE2	Primary/Secondary IDE Connector	40-pin Block	P.14
SATA1, SATA2	Serial ATA Port Connector	7-pin Block	P.15

Headers

Header	Name	Description	Page
1394A/1394B (for P4X400DBZ)	IEEE1394A Port headers	9-pin Block	P.16
AUDIO	SPEAKER, MIC header	9-pin Block	P.16
USB1/USB2/USB3	USB Port Headers	9-pin Block	P.16
HD LED	IDE activity LED	2-pin Block	P.16
RESET	Reset switch lead	2-pin Block	P.17
SPEAK	PC Speaker connector	4-pin Block	P.17
PWR LED	Power LED	2-pin Block	P.17
PWR BTN	Power switch	2-pin Block	P.17
WOL	Wake On-LAN Headers	3-pin Block	P.17
SFAN1, SYSFAN, CPUFAN	FAN Headers	3-pin Block	P.18
IR	IR infrared module Headers	5-pin Block	P.18
CD_IN	CD Audio-In Headers	4-pin Block	P.18

Expansion Sockets

Socket/Slot	Name	Description	Page
ZIF Socket 478 Pin	CPU Socket	478-pin mPGA CPU Socket	P.9
DDR1, DDR2, DDR3	DDR Module Socket	184-pin DDR Module expansion Socket	P.9
PCI1 ~ PCI5	PCI Slot	32-bit PCI Local Bus Expansion slots	P.10
AGP	AGP 8X Mode Slot	AGP Expansion Slot	P.12

Chapter 2

Hardware installation

2-1 Pre-Hardware installation

Before starting to use the computer with the motherboard installed the components on it, please make sure complete the following steps:

1. To verify the jumper settings of your motherboard
2. To install the CPU and Cooling Kits
3. To install the system memory
4. To install the expansion cards
5. To connect with ribbon cables, panel wires, and power supply
6. To setup BIOS
7. To install software driver & utility

2-2 To verify the jumper settings of the motherboard

(1) CMOS RAM Clear (3-pin) : JBAT

A battery must be used to retain the motherboard configuration in CMOS RAM short 1-2 pins of JBAT to store the CMOS data.

To clear the CMOS, follow the procedure below:

1. Turn off the system and unplug the AC power
2. Remove ATX power cable from ATX power connector
3. Locate JBAT and short pins 2-3 for a few seconds
4. Return JBAT to its normal setting by shorting pins 1-2
5. Connect ATX power cable back to ATX power connector

Note: When should clear CMOS

1. *Troubleshooting*
2. *Forget password*
3. *After over clocking system boot fail*

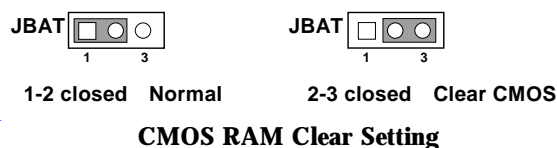

(2) Keyboard Power On function Enabled/Disabled: JP1

When setting Enabled you can use keyboard by key in password to power on system.

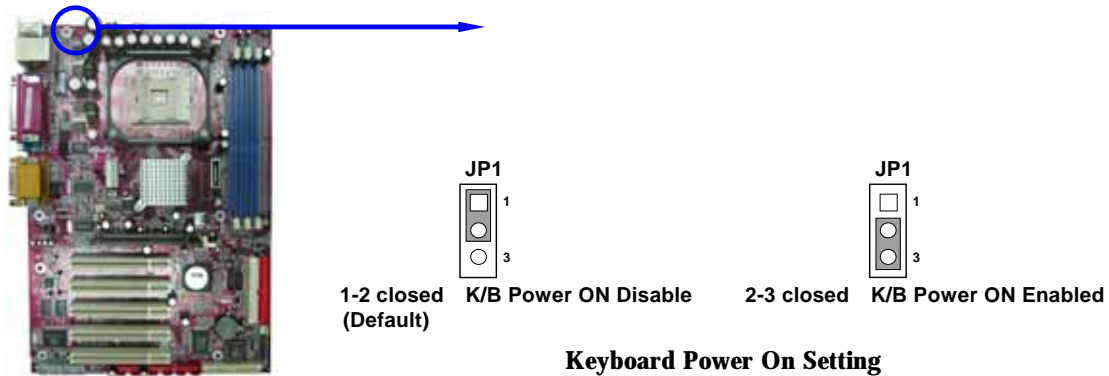

(3) CPU Front Side Bus Frequency Select Jumper : JP2, JP4 (2x3-pin)

JP2	JP4	CPU CLK	(Default)
1-2	1-2	AUTO	
2-3	2-3	100MHz	
OFF	2-3	133MHz	
2-3	OFF	200MHz	

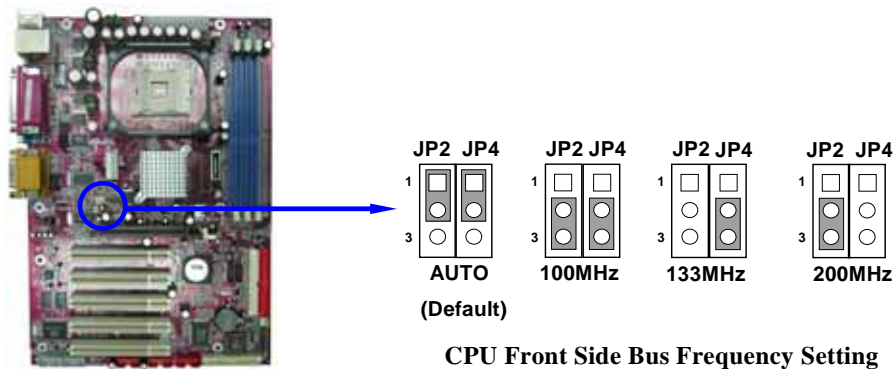

2-3 To install the CPU

2-3-1 Glossary

Chipset (or core logic) - two or more integrated circuits which control the interfaces between the system processor, RAM, I/O devices, and adapter cards.

Processor socket - the socket used to mount the system processor on the motherboard.

Slot (AGP, PCI, ISA, RAM DIMMs) - the slots used to mount adapter cards and system RAM.

AGP - Accelerated Graphics Port - the high speed interface for video cards which runs at 1X (66MHz), 2X (133MHz), 4X (266MHz), and 8X (533MHz).

PCI - Peripheral Component Interconnect - the high speed interface for video cards, sound cards, network interface cards, and modems which runs at 33MHz.

ISA - Industry Standard Architecture - the relatively low speed interface primarily used for sound cards and modems which runs at approx. 8MHz.

Serial Port - the low speed interface typically used for mouse and external modems.

Parallel Port - the low speed interface typically used for printers.

PS/2 - the low speed interface used for mouse and keyboards.

USB - Universal Serial Bus - the medium speed interface typically used for mouse, keyboards, scanners, and some digital cameras.

Sound (interface) - the interface between the sound card or integrated sound connectors and speakers, MIC, game controllers, and MIDI sound devices.

LAN (interface) - **Local Area Network** - the interface links to local area network.

BIOS (Basic Input/Output System) - the program logic used to boot up a computer and establish the relationship between various components.

Driver - software, which defines the characteristics of a device for use by another device or other software.

Processor - the "central processing unit" (CPU); the principal integrated circuit used for doing the "computing" in "personal computer"

Front Side Bus Frequency - the working frequency of the motherboard, which is generated by the clock generator for CPU, DRAM and PCI BUS.

CPU L2 Cache - the flash memory inside the CPU, normally Athlon serial CPU has 256K or above, and Duron has 64K.

2-3-2 About INTEL PENTIUM 4 478-PIN CPU

This motherboard provides a 478-pin surface mount, Zero Insertion Force (ZIF) socket, referred to as the mPGA478B socket supports Intel Pentium 4 processor in the 478 Pin package utilizes Flip-Chip Pin Grid Array (FC-PGA2) package technology.

The CPU that comes with the motherboard should have a cooling FAN attached to prevent overheating. If this is not the case, then purchase a correct cooling FAN before you turn on your system.

WARNING! Be sure that there is sufficient air circulation across the processor's heatsink and CPU cooling FAN is working correctly, otherwise it may cause the processor and motherboard overheat and damage, you may install an auxiliary cooling FAN, if necessary.

To install a CPU, first turn off your system and remove its cover. To locate the ZIF socket and open it by first pulling the level sideways away from the socket then upward to 90-degree. Insert the CPU with the correct orientation as shown below. The notched corner should point toward the end of the level. Because the CPU has a corner pin for two of the four corners, the CPU will only fit in the orientation as shown.

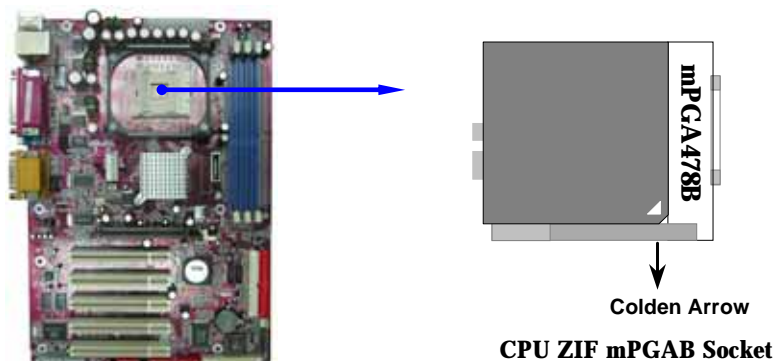

When you put the CPU into the ZIF socket. No force needed to insert of the CPU, then press the level to Locate position slightly without any extra force.

2-4 To install the system memory

This motherboard provides three 184-pin DUAL INLINE MEMORY MODULES (DIMM) sites for memory expansion available from minimum memory size of 64MB to maximum memory size of 3.0GB DDR SDRAM.

Valid Memory Configurations

Bank	184-Pin DIMM	PCS	Total Memory
Bank 0, 1 (DDR1)	PC2100/PC2700/PC3200 DDR SDRAM	X1	64MB~1.0GB
Bank 2, 3 (DDR2)	PC2100/PC2700/PC3200 DDR SDRAM	X1	64MB~1.0GB
Bank 4, 5 (DDR3)	PC2100/PC2700/PC3200 DDR SDRAM	X1	64MB~1.0GB
Total	System Memory (Max. 3.0GB)	3	64MB~3.0GB

NOTE! Make sure the total installed memory does not exceed 3.0GB, otherwise the system may hang during startup.

Generally speaking, installing DDR SDRAM modules to your motherboard is very easy, you can refer to figure 2-4 to see what a 184-Pin PC2100/PC2700/PC3200 DDR SDRAM module looks like.

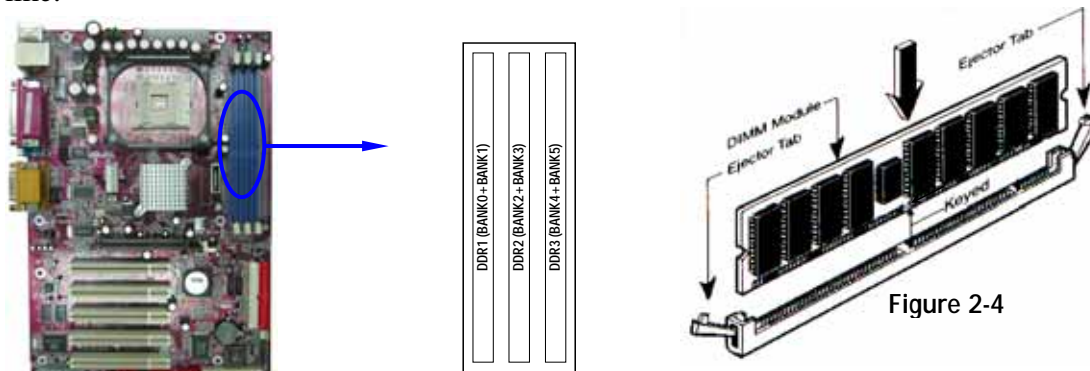

Figure 2-4

NOTE! When you install DIMM modules fully into the DIMM sockets the eject tab should be locked into the DIMM modules firmly and fit to its indentation on both sides.

WARNING! For the DDR SDRAM CLOCK is set at 166MHz, use only PC2700- compliant DDR Modules. When this motherboard operate at 133Mhz, most system will not even boot if non-compliant modules are used because of the strict timing issues, if your DDR Modules are not PC2100-compliant, set the DDR SDRAM clock to 100MHz to ensure system stability.

2-5 To install the Expansion Cards

WARNING! Turn off your power when adding or removing expansion cards or other system components. Failure to do so may cause severe damage to both your motherboard and expansion cards.

2-5-1 Procedure For Expansion Card Installation

1. To read documentations or manuals for your expansion cards and make any necessary hardware or software settings for your expansion card such as jumpers.
2. To remove your computer's cover and the bracket plate on the slot you intend to use.
3. To align the card's connectors and press firmly.
4. To secure the card on the slot with the screen you remove above.
5. To replace the computer system's cover.
6. To set up the BIOS if it's necessary.
7. To install the necessary software drivers for your expansion cards.

2-5-2 Assigning IRQs For Expansion Card

Some expansion cards need to assign an IRQ address to operate. Generally speaking, an IRQ address must exclusively assign to one use only. With standard factory design, there are 16 IRQs available, but most of them are already in use.

Standard Interrupt Assignments

IRQ	Priority	Standard function
0	N/A	System Timer
1	N/A	Keyboard Controller
2	N/A	Programmable Interrupt
3 *	8	Communications Port (COM2)
4 *	9	Communications Port (COM1)
5 *	6	Sound Card (sometimes LPT2)
6 *	11	Floppy Disk Controller
7 *	7	Printer Port (LPT1)
8	N/A	System CMOS/Real Time Clock
9 *	10	ACPI Mode when enabled
10 *	3	IRQ Holder for PCI Steering
11 *	2	IRQ Holder for PCI Steering
12 *	4	PS/2 Compatible Mouse Port
13	N/A	Numeric Data Processor
14 *	5	Primary IDE Channel
15 *	1	Secondary IDE Channel

* These IRQs are usually available for ISA or PCI devices.

2-5-3 Interrupt Request Table For This Motherboard

Interrupt requests are shared as shown the table below:

	INT A	INT B	INT C	INT D
PCI slot 1	Shared	—	—	—
PCI slot 2	—	Shared	—	—
PCI slot 3	—	—	Shared	—
PCI slot 4	—	—	—	Shared
PCI slot 5	Shared	—	—	—
AGP slot	Shared	—	—	—
AC97/MC97	—	—	Shared	—
Onboard USB	—	—	—	Shared
Onboard USB 1	—	—	—	Shared
Onboard USB 2	—	—	—	Shared

IMPORTANT! While using PCI cards on shared slots, make sure that the drivers support “Shared IRQ” or that the cards don’t need IRQ assignments. Conflicts will arise between the two PCI groups that will make the system unstable or cards inoperable.

This motherboard provides an AGP Slot, support the 4X/8X AGP VGA card.

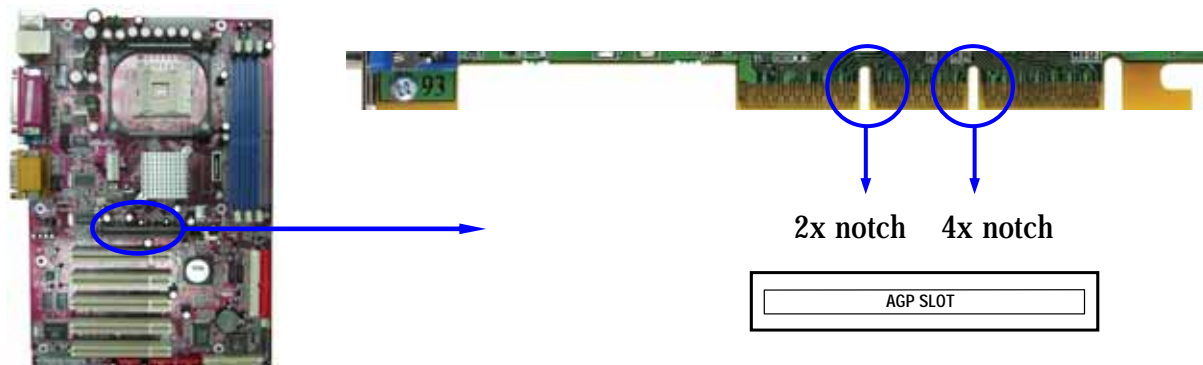

2-6 Connectors and pin headers

2-6-1 Connectors

(1) Power Connector (20-pin block) : ATXPWR

ATX Power Supply connector. This is a new defined 20-pins connector that usually comes with ATX case. The ATX Power Supply allows to use soft power on momentary switch that connect from the front panel switch to 2-pins Power On jumper pole on the motherboard. When the power switch on the back of the ATX power supply turns on, the full power will not come into the system board until the front panel switch is momentarily pressed. Press this switch again will turn off the power to the system board.

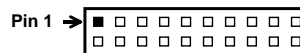
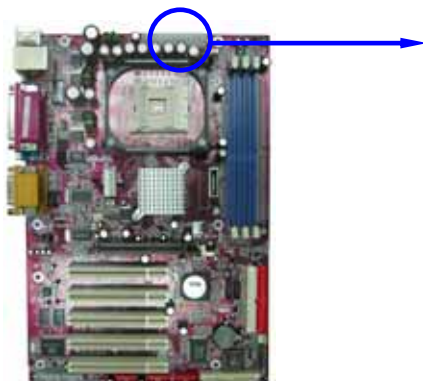

PIN	ROW2	ROW1
1	3.3V	3.3V
2	-12V	3.3V
3	GND	GND
4	Soft Power On	5V
5	GND	GND
6	GND	5V
7	GND	GND
8	-5V	Power OK
9	+5V	+5V (for Soft Logic)
10	+5V	+12V

(2) ATX 12V Power Connector (4-pin block) : ATX12V

This is a new defined 4-pins connector that usually comes with ATX Power Supply. The ATX Power Supply which fully support Pentium 4 processor must including this connector for support extra 12V voltage to maintain system power consumption. Without this connector might cause system unstable because the power supply can not provide sufficient current for system.

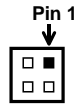
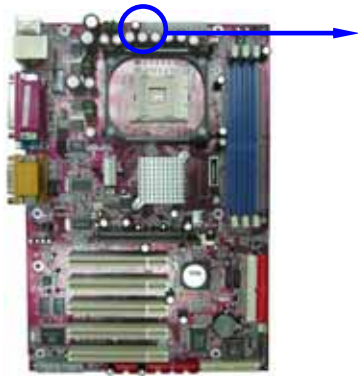

(3) ATX P9 Power Connector (6-pin block) : ATXP1

This is a new defined 6-pins connector that usually comes with ATX Power Supply. The ATX Power Supply which fully support Pentium 4 processor must including this connector for support extra 3.3V and 5V voltage to maintain system power consumption. Without this connector might cause system unstable because the power supply can not provide sufficient current for system.

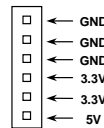
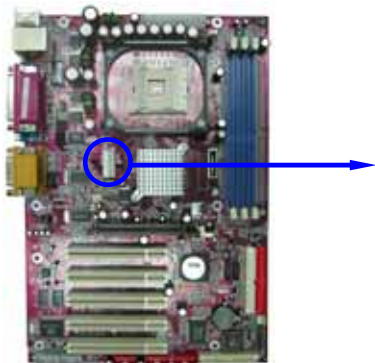

Power Connector on Motherboard

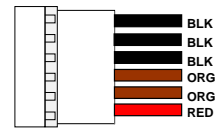

Power Plugs from Power Supply

(4) PS/2 Mouse & PS/2 Keyboard Connector: PS2KBM

The connectors for PS/2 keyboard and PS/2 Mouse.

(5) USB Port connector: USB

The connectors are 4-pin connector that connect USB devices to the system board.

(6) LAN Port connector: LAN (only for PT800DBP/PT800DBZ)

This connector is standard RJ45 connector for Network

(7) Parallel Port Connector (25-pin female): PARALLEL

Parallel Port connector is a 25-pin D-Subminiature Receptacle connector. The On-board Parallel Port can be disabled through the BIOS SETUP. Please refer to Chapter 3 “INTEGRATED PERIPHERALS SETUP” section for more detail information.

(8) Audio Connector : AUDIO_GAME

This Connector are 3 phone Jack for LINE-OUT, LINE-IN, MIC and a 15-pin D-Subminiature Receptacle Connector for joystick/MIDI Device.

Line-out : Audio output to speaker

Line-in : Audio input to sound chip

MIC : Microphone Connector

Game/MIDI : For joystick or MIDI Device

(9) Serial Port COM1, COM2 : COM1, COM2

COM1, COM2 are the 9-pin D-Subminiature mail connector. The On-board serial port can be disabled through BIOS SETUP. Please refer to Chapter 3 “INTEGRATED PERIPHERALS SETUP” section for more detail information.

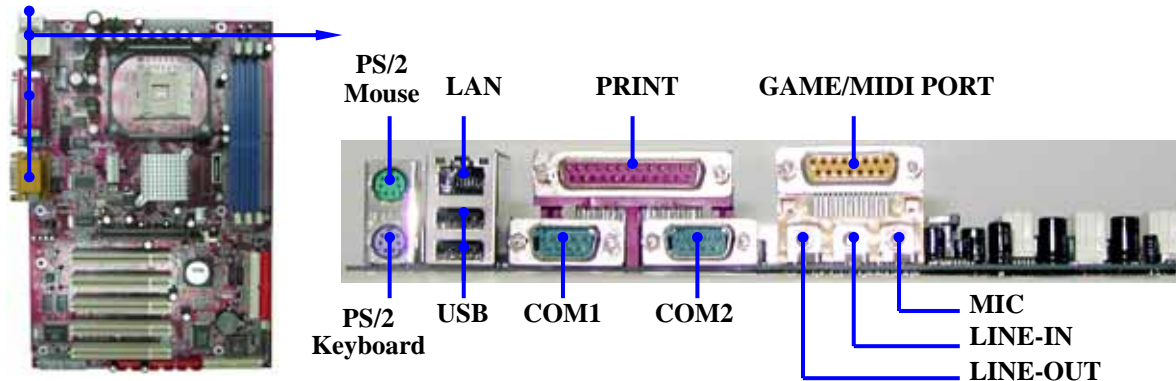

(10) Floppy drive Connector (34-pin block): FDD

This connector supports the provided floppy drive ribbon cable. After connecting the single plug end to motherboard, connect the two plugs at other end to the floppy drives.

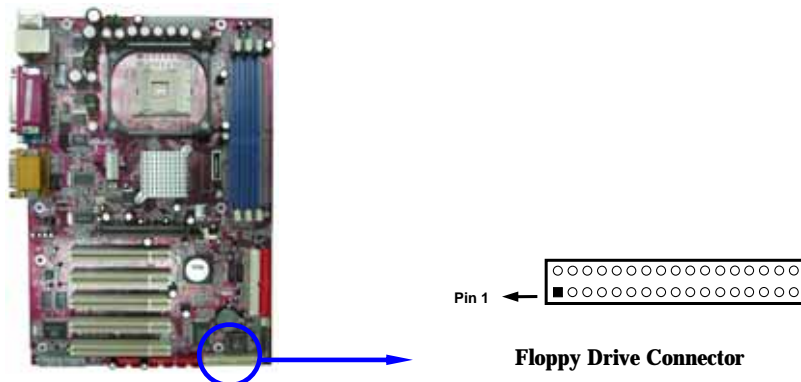

(11) Primary IDE Connector (40-pin block): IDE1

This connector supports the provided IDE hard disk ribbon cable. After connecting the single plug end to motherboard, connect the two plugs at other end to your hard disk(s). If you install two hard disks, you must configure the second drive to Slave mode by setting its jumpers accordingly. Please refer to the documentation of your hard disk for the jumper settings.

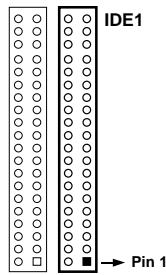

Primary IDE Connector

(12) Secondary IDE Connector (40-pin block): IDE2

This connector connects to the next set of Master and Slave hard disks. Follow the same procedure described for the primary IDE connector. You may also configure two hard disks to be both Masters using one ribbon cable on the primary IDE connector and another ribbon cable on the secondary IDE connector.

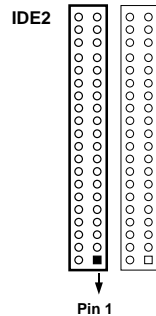

Secondary IDE Connector

- Two hard disks can be connected to each connector. The first HDD is referred to as the “Master” and the second HDD is referred to as the “Slave”.
- For performance issues, we strongly suggest you don’t install a CD-ROM or DVD-ROM drive on the same IDE channel as a hard disk. Otherwise, the system performance on this channel may drop.

(13) Serial-ATA Port connector: SATA1/SATA2

This connector support the provided Serial ATA IDE hard disk cable to connecting the motherboard and serial ATA hard disk.

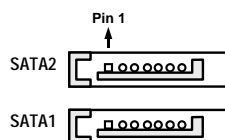

Serial-ATA Port Connector

2-6-2 Pin headers

(1) IEEE 1394A Port Header (9-pin) : 1394A/1394B (For PT800DBZ only)



Note: Orient the read marking on the 1394 ribbon cable to pin 1

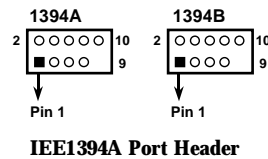

(2) Line-Out, MIC Header (9-pin): AUDIO

This header connect to Front Panel Line-out, MIC connector with cable.

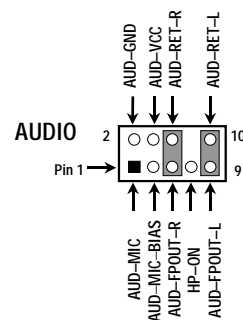
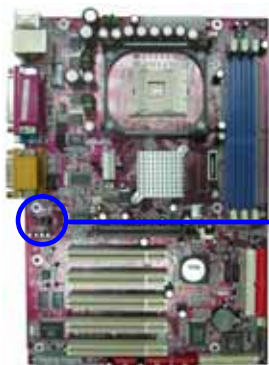

Line-Out, MIC Headers

(3) USB Port Headers (9-pin) : USB1, USB2

These headers are used for connecting the additional USB port plug. By attaching an option USB cable, your can be provided with two additional USB plugs affixed to the back panel.

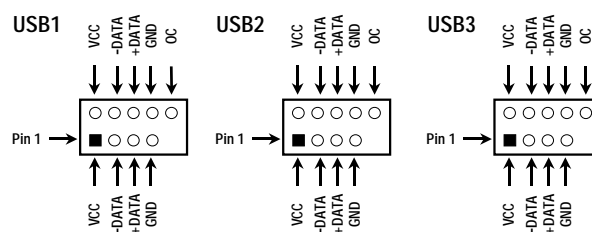

USB Port Headers

(4) IDE Activity LED: HD LED

This connector connects to the hard disk activity indicator light on the case.

(5) Reset switch lead: RESET

This 2-pin connector connects to the case-mounted reset switch for rebooting your computer without having to turn off your power switch. This is a preferred method of rebooting in order to prolong the life of the system's power supply. See the figure below.

(6) Speaker connector: SPEAK

This 4-pin connector connects to the case-mounted speaker. See the figure below.

(7) Power LED: PWR LED

The Power LED is light on while the system power is on. Connect the Power LED from the system case to this pin.

(8) Power switch: PWR BTN

This 2-pin connector connects to the case-mounted power switch to power ON/OFF the system.

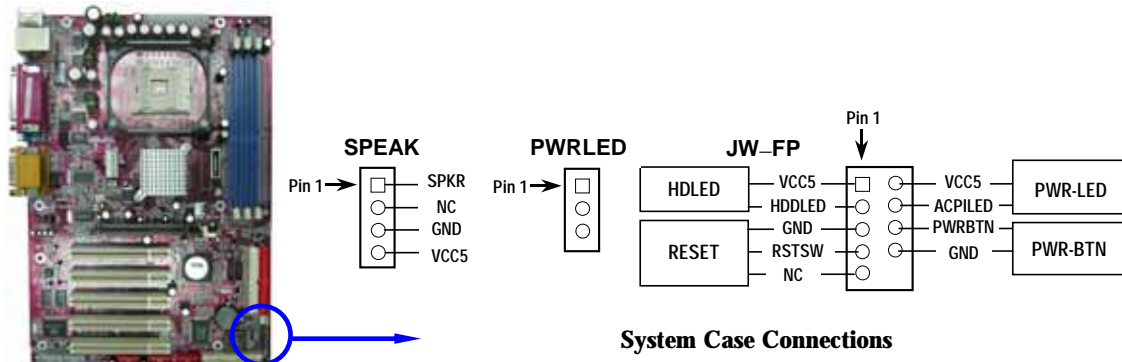

(9) Wake On-LAN Headers (3-pin) : WOL

This connector connects to a LAN card with a WAKE ON-LAN output. This connector power up the system when a wake up signal is received through the LAN card.

NOTE: This feature requires that Wake On LAN or Ring In Wake up is enabled.

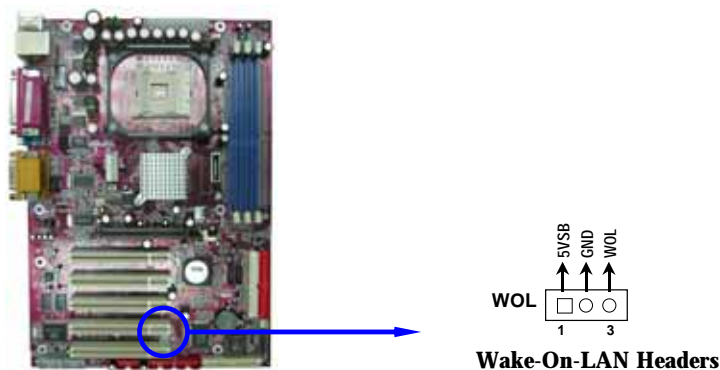

(10) FAN Speed Headers (3-pin) : SFAN1, SYSFAN, CPUFAN

These connectors support cooling fans of 350mA (4.2 Watts) or less, depending on the fan manufacturer, the wire and plug may be different. The red wire should be positive, while the black should be ground. Connect the fan's plug to the board taking into consideration the polarity of connector.

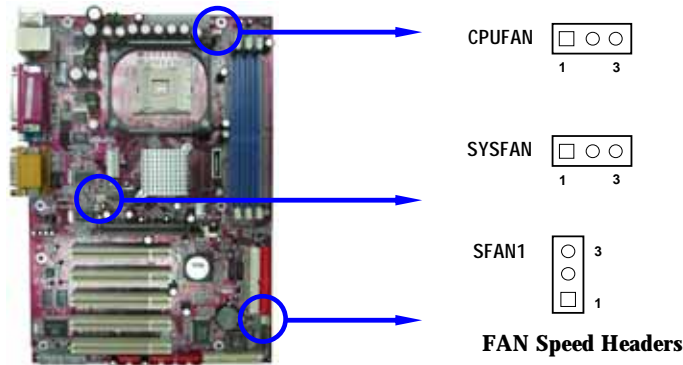

(11) IR infrared module Headers (9-pin) : IR

This connector supports the optional wireless transmitting and receiving infrared module. You must configure the setting through the BIOS setup to use the IR function.

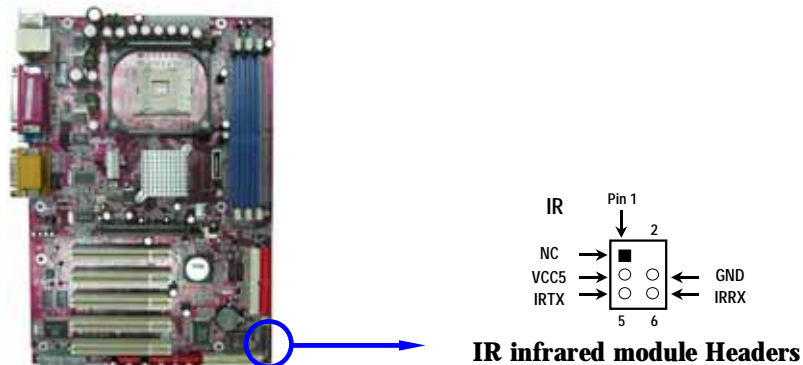

(12) CD Audio-In Headers (4-pin) : CD_IN

CD_IN is the connector for CD-Audio Input signal. Please connect it to CD-ROM CD-Audio output connector.

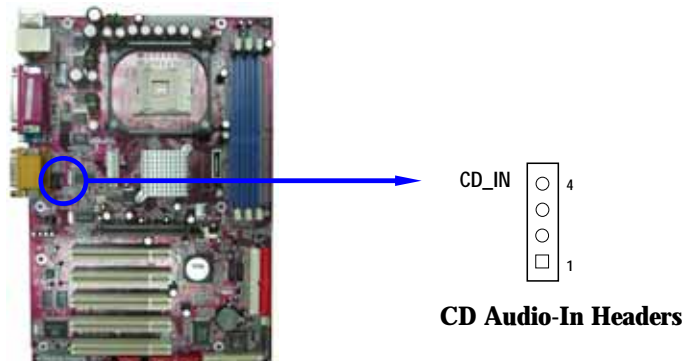

2-7 Starting up your computer

1. After all connection are ready, close your computer case cover.
2. Be sure all the switches are off, and check that the power supply input voltage is set to proper position, usually in-put voltage is 220V~240V or 110V~120V depending on your country's voltage used.
3. Connect the power supply cord into the power supply located on the back of your system case according to your system user's manual.
4. Turn on your peripherals as following order:
 - a. Your monitor.
 - b. Other external peripherals (Printer, Scanner, External Modem etc...)
 - c. Your system power. For ATX power supplies, you need to turn on the power supply and press the ATX power switch on the front side of the case.
5. The power LED on the front panel of the system case will light. The LED on the monitor may light up or switch between orange and green after the system is on. If it complies with green standards or if it is has a power standby feature. The system will then run power-on test. While the test are running, the BIOS will alarm beeps or additional message will appear on the screen.

If you do not see any thing within 30 seconds from the time you turn on the power. The system may have failed on power-on test. Recheck your jumper settings and connections or call your retailer for assistance.

Beep	Meaning
One short beep when displaying logo	No error during POST
Long beeps in an endless loop	No DRAM install or detected
One long beep followed by three short beeps	Video card not found or video card memory bad
High frequency beeps when system is working	CPU overheated System running at a lower frequency

6. During power-on, press <Delete> key to enter BIOS setup. Follow the instructions in BIOS SETUP.
7. **Power off your computer:** You must first exit or shut down your operating system before switch off the power switch. For ATX power supply, you can press ATX power switching after exiting or shutting down your operating system. If you use Windows 9X, click "**Start**" button, click "**Shut down**" and then click "**Shut down the computer?**" The power supply should turn off after windows shut down.

Chapter 3

Introducing BIOS Settings

The BIOS is a program located on a Flash Memory of the motherboard. Using this program as a bridge between motherboard and operating system. When the computer starting to work, the BIOS program gain control. The BIOS first operates an auto-diagnostic test called POST (power on self test) for all the necessary hardware, it detects the entire hardware device and configures the parameters of the hardware synchronization. Only when these tasks are completed done it gives up control of the computer to operating system (OS). Since the BIOS is the only channel for hardware and software to communicate, it is the key factor for system stability, and in ensuring that your system performance as its best.

In the BIOS Setup main menu of Figure 3-1, you can see several options. We will explain these options step by step in the following pages of this chapter, but let us first see a short description of the function keys you may use here:

- Press <Esc> to quit the BIOS Setup.
- Press ↑↓←→ (up, down, left, right) to choose, in the main menu, the option you want to confirm or to modify.
- Press <F10> when you have completed the setup of BIOS parameters to save these parameters and to exit the BIOS Setup menu.
- Press Page Up/Page Down or +/- keys when you want to modify the BIOS parameters for the active option.

3-1 Entering Setup

Power on the computer and by pressing immediately allows you to enter BIOS Setup. If the message disappears before your respond and you still wish to enter BIOS Setup, restart the system to try again by turning it OFF then ON or pressing the “RESET” button on the system case. You may also restart by simultaneously pressing <Ctrl>, <Alt> and <Delete> keys. If you do not press the keys at the correct time and the system does not boot, an error message will be displayed and you will again be asked to

Press <F1> to continue, <Ctrl-Alt-Esc> or to enter Setup

3-2 Getting Help

Main Menu

The on-line description of the highlighted setup function is displayed at the bottom of the screen.

Status Page Setup Menu/Option Page Setup Menu

Press F1 to pop up a small help window that describes the appropriate keys to use and the possible selections for the highlighted item. To exit the Help Window, press <Esc>.

3-3 The Main Menu

Once you enter Award® BIOS CMOS Setup Utility, the Main Menu (Figure 3-1) will appear on the screen. The Main Menu allows you to select from fourteen setup functions and two exit choices. Use arrow keys to select among the items and press <Enter> to accept or enter the sub-menu.

CMOS Setup Utility - Copyright(C) 1984-2003 Award Software

Standard CMOS Features	Miscellaneous Control
Advanced BIOS Features	Load optimized Defaults
Advanced Chipset Features	Load Standard Defaults
Integrated Peripherals	Set Supervisor Password
Power Management Setup	Set User Password
PnP/PCI Configurations	Save & Exit Setup
PC Health Status	Exit Without Saving
Esc : Quit	↑↓→← : Select Item
F10 : Save & Exit Setup	
Time, Date, Hard Disk Type...	

Figure 3-1

Standard CMOS Features

Use this Menu for basic system configurations.

Advanced BIOS Features

Use this menu to set the Advanced Features available on your system.

Advanced Chipset Features

Use this menu to change the values in the chipset registers and optimize your system's performance.

Integrated Peripherals

Use this menu to specify your settings for integrated peripherals.

Power Management Setup

Use this menu to specify your settings for power management.

PnP/PCI configurations

This entry appears if your system supports PnP/PCI.

PC Health Status

This entry shows your PC health status.

Miscellaneous Control

Use this menu to specify your settings for Miscellaneous control.

Load Optimized Defaults

Use this menu to load the BIOS default values that are factory settings for optimal performances system operations.

Load Standard Defaults

Use this menu to load the BIOS default values for the minimal/stable performance system operation.

Set Supervisor/User Password

Use this menu to set User and Supervisor Passwords.

Save & Exit Setup

Save CMOS value changes to CMOS and exit setup.

Exit Without Saving

Abandon all CMOS value changes and exit setup.

3-4 Standard CMOS Features

The items in Standard CMOS Setup Menu are divided into several categories. Each category includes no, one or more than one setup items. Use the arrow keys to highlight the item and then use the <PgUp> or <PgDn> keys to select the value you want in each item.

CMOS Setup Utility - Copyright(C) 1984-2003 Award Software

Standard CMOS Features

Date (mm:dd:yy)	Mon, Nov, 24 2003	Item Help	
Time (hh:mm:ss)	16 : 45 : 35		
> IDE Primary Master	Press Enter None	Menu Level > Change the day, month, year and century	
> IDE Primary Slave	Press Enter None		
> IDE Secondary Master	Press Enter None		
> IDE Secondary Slave	Press Enter None		
Drive A	1.44M, 3.25 in.		
Drive B	None		
Video	EGA/VGA		
Halt On	All,But Keyboard		
Base Memory	640K		
Extended Memory	56320K		
Total Memory	57344K		
↑↓←→ Move Enter:Select +/-/PU/PD:Value F10:Save ESC:Exit F1:General Help F5:Previous Values F6:Optimized Defaults F7:Standard Defaults			

Date

The date format is <day><month><date><year>.

Day Day of the week, from Sun to Sat, determined by BIOS. Read-only.

Month The month from Jan. through Dec.

Date The date from 1 to 31 can be keyed by numeric function keys.

Year The year depends on the year of the BIOS.

Time

The time format is <hour><minute><second>.

Primary Master/Primary Slave

Secondary Master/Secondary Slave

Press PgUp/<+> or PgDn/<-> to select Manual, None, Auto type. Note that the specifications of your drive must match with the drive table. The hard disk will not work properly if you enter improper information for this category. If your hard disk drive type is not matched or listed, you can use Manual to define your own drive type manually.

If you select Manual, related information is asked to be entered to the following items. Enter the information directly from the keyboard. This information should be provided in the documentation from your hard disk vendor or the system manufacturer.

If the controller of HDD interface is SCSI, the selection shall be "None".

If the controller of HDD interface is CD-ROM, the selection shall be "None"

Access Mode The settings are Auto Normal, Large, and LBA.

Cylinder number of cylinders

Head number of heads

Precomp write precomp

Landing Zone landing zone

Sector number of sectors

3-5 Advanced BIOS Features

CMOS Setup Utility - Copyright(C) 1984-2003 Award Software

Advanced BIOS Features

		Item Help
Anti-Virus Protection	Disabled	
CPU L1 Cache	Enabled	
CPU L2 Cache	Enabled	
Quick Power On Self Test	Enabled	
First Boot Device	Floppy	Menu Level >
Second Boot Device	HDD-0	
Third Boot Device	CDROM	
Boot other Device	Enabled	
Swap Floppy Drive	Disabled	
Boot Up Floppy Seek	Enabled	
Boot Up NumLock Status	On	
Typematic Rate Setting	Disabled	
Typematic Rate (Chars/Sec)	6	
Typematic Delay (Msec)	250	
Security Option	Setup	
APIC Mode	Enabled	
MPS Version Control For OS	1.4	
OS Select for DRAM > 64MB	Non-OS2	
OS Select for System	MS Windows	
HDD S.M.A.R.T. Capability	Disabled	
Report No FDD For Windows	Yes	
Video BIOS Shadow	Enabled	

Move Enter:Select +/-/PU/PD:Value F10:Save ESC:Exit F1:General Help
F5:Previous Values F6:Optimized Defaults F7:Standard Defaults

Anti-Virus Protection

Allows you to choose the VIRUS Warning feature for IDE Hard Disk boot sector protection. If this function is enabled and someone attempt to write data into this area, BIOS will show a warning message on screen and alarm beep.

Disabled (default) No warning message to appear when anything attempts to access the boot sector or hard disk partition table.

Enabled Activates automatically when the system boots up causing a warning message to appear when anything attempts to access the boot sector of hard disk partition table.

CPU Internal Cache

The default value is Enabled.

Enabled (default) Enable cache

Disabled Disable cache

Note: *The internal cache is built in the processor.*

External Cache

Choose Enabled or Disabled. This option enables the Level 2 cache memory.

CPU L2 Cache

Choose Enabled or Disabled. This option enables the Level 2 cache memory.

Quick Power On Self-Test

This category speeds up Power On Self Test (POST) after you power on the computer. If this is set to Enabled, BIOS will shorten or skip some check items during POST.

Enabled (default) Enable quick POST

Disabled Normal POST

First/Second/Third/Fourth Boot Device

The BIOS attempts to load the operating system from the devices in the sequence selected in these items. The settings are Floppy, LS/ZIP, HDD-0/HDD-1/HDD-3, SCSI, CDROM, LAD and Disabled.

Swap Floppy Drive

Switches the floppy disk drives between being designated as A and B. Default is Disabled.

Boot Up Floppy Seek

During POST, BIOS will determine if the floppy disk drive installed is 40 or 80 tracks. 360K type is 40 tracks while 760K, 1.2M and 1.44M are all 80 tracks.

Boot Up NumLock Status

The default value is On.

On (default) Keypad is numeric keys.

Off Keypad is arrow keys.

Typematic Rate Setting

Keystrokes repeat at a rate determined by the keyboard controller. When enabled, the typematic rate and typematic delay can be selected. The settings are: Enabled/Disabled.

Typematic Rate (Chars/Sec)

Sets the number of times a second to repeat a keystroke when you hold the key down. The settings are: 6, 8, 10, 12, 15, 20, 24, and 30.

Typematic Delay (Msec)

Sets the delay time after the key is held down before it begins to repeat the keystroke. The settings are 250, 500, 750, and 1000.

Security Option

This category allows you to limit access to the system and Setup, or just to Setup.

- System** The system will not boot and access to Setup will be denied if the correct password is not entered at the prompt.
- Setup (default)** The system will boot, but access to Setup will be denied if the correct password is not entered at the prompt.

OS Select For DRAM > 64MB

Allows OS2[®] to be used with >64MB of DRAM. Settings are Non-OS/2 (default) and OS2. Set to OS/2 if using more than 64MB and running OS/2[®].

3-6 Advanced Chipset Features

The Advanced Chipset Features Setup option is used to change the values of the chipset registers. These registers control most of the system options in the computer.

CMOS Setup Utility - Copyright(C) 1984-2003 Award Software		
Advanced Chipset Features		
> DRAM Timing Settings	Press Enter	Item Help
> AGP Timing Settings	Press Enter	
> PCI Timing Settings	Press Enter	Menu Level >
System BIOS Cacheable	Disabled	
Video RAM Cacheable	Disabled	
Memory Hole	Disabled	
↑↓→← Move Enter:Select +/-/PU/PD:Value F10:Save ESC:Exit F1:General Help F5:Previous Values F6:Optimized Defaults F7:Standard Defaults		

DRAM Timing Settings

Please refer to section 3-6-1

AGP Timing Settings

Please refer to section 3-6-2

PCI Timing Settings

Please refer to section 3-6-3

System BIOS Cacheable

Selecting Enabled allows caching of the system BIOS ROM at F0000h-FFFFFh, resulting in better system performance. However, if any program writes to this memory area, a system error may result. The settings are: Enabled and Disabled.

Video RAM Cacheable

Select Enabled allows caching of the video BIOS, resulting in better system performance. However, if any program writes to this memory area, a system error may result. The settings are: Enabled and Disabled.

Memory Hole

You can reserve this area of system memory for ISA adapter ROM. When this area is reserved, it cannot be cached. The user information of peripherals that need to use this area of system memory usually discusses their memory requirements. The settings are: Enabled and Disabled.

3-6-1 DRAM Timing Settings

CMOS Setup Utility - Copyright(C) 1984-2003 Award Software

DRAM Timing Settings

System Performance	By SPD	Item Help
RAS Active Time	7T	
RAS Precharge Time	3T	
RAS to CAS Delay	3T	
DRAM CAS Latency	2.5	Menu Level >>
Bank Interleave	Enabled	
DRAM Command Rate	2T Command	
DRAM Burst Length	8	
Write Recovery Time	2T	
Write to Read Command Delay	3T	
↑↓→← Move Enter:Select +/-/PU/PD:Value F10:Save ESC:Exit F1:General Help F5:Previous Values F6:Optimized Defaults F7:Standard Defaults		

RAS Active Time

This field let's you insert a timing delay between the CAS and RAS strobe signals, used when DRAM is written to, read from, or refreshed. *Fast* gives faster performance; and *Slow* gives more stable performance. This field applies only when synchronous DRAM is installed in the system. The settings are: 2T and 3T.

RAS Precharge Time

If an insufficient number of cycles is allowed for the RAS to accumulate its charge before DRAM refresh, the refresh may be incomplete and the DRAM may fail to retain date. *Fast* gives faster performance; and *Slow* gives more stable performance. This field applies only when synchronous DRAM is installed in the system. The settings are: 2T and 3T.

CAS Latency

When synchronous DRAM is installed, the number of clock cycles of CAS latency depends on the DRAM timing. The settings are: 2T and 2.5T.

3-6-2 AGP Timing Settings

CMOS Setup Utility - Copyright(C) 1984-2003 Award Software

AGP Timing Settings

AGP Transfer Aperture Size	64M	Item Help
AGP Transfer Mode	4X	
AGP Driving Control	Auto	
* AGP Driving Value	DA	Menu Level >>
AGP Fast Write	Disabled	
AGP Master 1 WS Write	Enabled	
AGP Master 1 WS Read	Enabled	
CPU to AGP Post Write	Disabled	
AGP Delay Transaction	Disabled	
AGP Delay Transaction	Disabled	

↑↓→← Move Enter:Select +/-/PU/PD:Value F10:Save ESC:Exit F1:General Help
F5:Previous Values F6:Optimized Defaults F7:Standard Defaults

Note: *Change these settings only if you are familiar with the chipset.*

3-6-3 PCI Timing Settings

CMOS Setup Utility - Copyright(C) 1984-2003 Award Software

PCI Timing Settings

PCI Master 1 WS Write	Disabled	Item Help
PCI Master 1 WS Read	Disabled	
CPU to AGP Post Write	Enabled	
PCI Delay Transaction	Disabled	Menu Level >>

↑↓→← Move Enter:Select +/-/PU/PD:Value F10:Save ESC:Exit F1:General Help
F5:Previous Values F6:Optimized Defaults F7:Standard Defaults

PCI Delay Transaction

The chipset has an embedded 32-bit posted write buffer to support delay transactions cycles. Select Enabled to support compliance with PCI specification version 2.1. The settings are: Enabled and Disabled.

3-7 Integrated Peripherals

CMOS Setup Utility - Copyright(C) 1984-2003 Award Software

Integrated Peripherals

> OnChip IDE Function	Press Enter	Item Help
> OnChip Device Function	Press Enter	
> Onboard Super IO Function	Press Enter	
Init Display First	PCI Slot	Menu Level >
↑↓→← Move Enter:Select +/-/PU/PD:Value F10:Save ESC:Exit F1:General Help F5:Previous Values F6:Optimized Defaults F7:Standard Defaults		

OnChip IDE Function

Please refer to section 3-7-1

OnChip Device Function

Please refer to section 3-7-2

Onboard Super IO Function

Please refer to section 3-7-3

Init Display First

This item allows you to decide to activate whether PCI Slot or AGP VGA first. The settings are: PCI Slot, AGP Slot.

3-7-1 OnChip IDE Function

CMOS Setup Utility - Copyright(C) 1984-2003 Award Software

OnChip IDE Function

OnChip IDE Channel0	Enabled	Item Help	
OnChip IDE Channel1	Enabled		
Primary Master PIO	Auto	Menu Level >>	
Primary Slave PIO	Auto		
Secondary Master PIO	Auto		
Secondary Slave PIO	Auto		
Primary Master UDMA	Auto		
Primary Slave UDMA	Auto		
Secondary Master UDMA	Auto		
Secondary Slave UDMA	Auto		
IDE 32-bit Transfer Mode	Enabled		
IDE Prefetch Mode	Enabled		
IDE HDD Block Mode	Enabled		
Delay For HDD (Secs)	0		
Move Enter:Select +/-/PU/PD:Value F10:Save ESC:Exit F1:General Help			
F5:Previous Values F6:Optimized Defaults F7:Standard Defaults			

OnChip IDE Channel0/Channel1

The integrated peripheral controller contains an IDE interface with support for two IDE channels. Select *Enabled* to activate each channel separately. The settings are: Enabled and Disabled.

Primary/Secondary Master/Slave PIO

The four IDE PIO (Programmed Input/Output) fields let you set a PIO mode (0-4) for each of the four IDE devices that the onboard IDE interface supports. Modes 0 through 4 provide successively increased performance. In Auto mode, the system automatically determines the best mode for each device. The settings are: Auto, Mode 0, Mode 1, Mode 2, Mode 3, Mode 4.

Primary/Secondary Master/Slave UDMA

Ultra DMA/33 implementation is possible only if your IDE hard drive supports it and the operating environment includes a DMA driver (Windows 95 OSR2 or a third-party IDE bus master driver). If your hard drive and your system software both support Ultra DMA/33 and Ultra DMA/66, select Auto to enable BIOS support. The settings are: Auto, Disabled.

IDE HDD Block Mode

Block mode is also called block transfer, multiple commands, or multiple sector read/write. If your IDE hard drive supports block mode (most new drives do), select Enabled for automatic detection of the optimal number of block read/writes per sector the drive can support. The settings are: Enabled, Disabled.

3-7-2 OnChip Device Function

CMOS Setup Utility - Copyright(C) 1984-2003 Award Software

OnChip Device Function

VIA 1394 Function	Enabled →(for PT800DBZ)	Item Help
VIA SATA Function	Enabled →(for PT800DBP/	
VIA LAN Function	Enabled PT800DBZ)	
VIA LAN Boot ROM	Disabled	
VIA LAN BootROM Boot option	Hook INT19	Menu Level >>
VIA LAN BootROM PXERPL Option	PXE	
Current VIA MAC Address is	003018-XXXXXX	
VIA MAC Address Input	Press Enter	
AC97 Sound Device	Auto	
Game Port Address	201	
Midi Port Address	Disabled	
Midi Port IRQ	10	
USB Host Controller	Enabled	
USB 2.0 Support	Enabled	
USB Keyboard Legacy Support	Disabled	
Move Enter:Select +/-/PU/PD:Value F10:Save ESC:Exit F1:General Help		
F5:Previous Values F6:Optimized Defaults F7:Standard Defaults		

AC97 Sound Device

This item allows you to decide to enable/disable the chipset family to support AC97 Audio. The settings are: Enabled, Disabled.

Game Port Address/Midi Port Address

This will determine which Address the Game Port/Midi Port will use.

USB Host Controller

Select *Enabled* if your system contains a Universal Serial Bus (USB) controller and you have a USB peripherals. The settings are: Enabled, Disabled.

USB Keyboard Support

Select *Enabled* if your system contains a Universal Serial Bus (USB) controller and you have a USB keyboard. The settings are: Enabled, Disabled.

3-7-3 Onboard Super IO Function

CMOS Setup Utility - Copyright(C) 1984-2003 Award Software

Onboard Super IO Function

Onboard FDD Controller	<u>Enabled</u>	Item Help
Onboard Serial Port 1	3F8/IRQ4	Menu Level >>
Onboard Serial Port 2	2F8/IRQ3	
UART2 Mode	Normal	
RxD, TxD Active	Hi, Lo	
IR Duplex Mode	Half	
Use IR Pins	IRRX/IRTX	
Onboard Parallel Port	378/IRQ7	
Parallel Mode	SPP	
EPP Mode Select	EPP1.7	
ECP Mode Use DMA	3	
↑↓←→ Move Enter:Select +/-/PU/PD:Value F10:Save ESC:Exit F1:General Help F5:Previous Values F6:Optimized Defaults F7:Standard Defaults		

Onboard FDD Controller

Select Enabled if your system has a floppy disk controller (FDD) installed on the system board and you wish to use it. If you install add-on FDC or the system has no floppy drive, select Disabled in this field. The settings are: Enabled and Disabled.

Onboard Serial Port 1/Port 2

Select an address and corresponding interrupt for the first and the second serial ports. The settings are: 3F8/IRQ4, 2E8/IRQ3, 3E8/IRQ4, 2F8/IRQ3, Disabled, Auto.

UART2 Mode

This item allows you to determine which InfraRed(IR) function of the onboard I/O chip, this functions uses.

Onboard Parallel Port

There is a built-in parallel port on the on-board Super I/O chipset that Provides Standard, ECP, and EPP features. It has the following option:

Disabled

(3BCH/IRQ7)/ Line Printer port 0

(278H/IRQ5)/ Line Printer port 2

(378H/IRQ7) Line Printer port 1

Parallel Port Mode

SPP : Standard Parallel Port

EPP : Enhanced Parallel Port

ECP : Extended Capability Port

SPP/EPP/ECP/ECP+EPP

To operate the onboard parallel port as Standard Parallel Port only, choose “SPP.” To operate the onboard parallel port in the EPP modes simultaneously, choose “EPP.” By choosing “ECP”, the onboard parallel port will operate in ECP mode only. Choosing “ECP+EPP” will allow the onboard parallel port to support both the ECP and EPP modes simultaneously. The ECP mode has to use the DMA channel, so choose the onboard parallel port with the ECP feature. After selecting it, the following message will appear: “ECP Mode Use DMA” at this time, the user can choose between DMA channels 3 to 1. The onboard parallel port is EPP Spec. compliant, so after the user chooses the onboard parallel port with the EPP function, the following message will be displayed on the screen: “EPP Mode Select.” At this time either EPP 1.7 spec. or EPP 1.9 spec. can be chosen.

3-8 Power Management Setup

The Power Management Setup allows you to configure your system to most effectively save energy saving while operating in a manner consistent with your own style of computer use.

CMOS Setup Utility - Copyright(C) 1984-2003 Award Software

Power Management Setup

ACPI Function	<u>Enabled</u>	Item Help
Video Off Option	Suspend -> off	
Video off Method	V/H SYNC+Blank	
MODEM Use IRQ	3	Menu Level >
Power Button Function	Instant-Off	
State After Power Failure	Auto	
> Wake Up Events	Press Enter	
↑↓←→ Move Enter:Select +/-/PU/PD:Value F10:Save ESC:Exit F1:General Help F5:Previous Values F6:Optimized Defaults F7:Standard Defaults		

ACPI Function

This item allows you to Enabled/Disabled the Advanced Configuration and Power Management (ACPI). The settings are Enabled and Disabled.

Video Off Option

This determines the manner in which the monitor is blanked. The choice are Suspend → off, All Modes → Off, and Always On.

Video Off Method

This determines the manner in which the monitor is blanked.

- DPMS (default)** Initial display power management signaling.
- Blank Screen** This option only writes blanks to the video buffer.
- V/H SYNC+Blank** This selection will cause the system to turn off the vertical and horizontal synchronization ports and write blanks to the video buffer.

Modem Use IRQ

This determines the IRQ in which the MODEM can use.

The settings are: 3, 4, 5, 7, 9, 10, 11, NA.

Power Button Function

Pressing the power button for more than 4 seconds forces the system to enter the Soft-Off state.

The settings are: Delay 4 Sec, Instant-Off.

State After Power Failure

This item allows the system power ON/OFF automatic when power loss and recovery again, you can choose Auto for recovery pre-state, or always ON/OFF after power recovery.

Wake Up Events

Please refer to section 3-8-1

3-8-1 Wake up Events

CMOS Setup Utility - Copyright(C) 1984-2003 Award Software

Wake Up Events

VGA	OFF	Item Help
LPT & COM	LPT/COM	
HDD & FDD	ON	
PCI Master	OFF	
Wake-Up on Ring/LAN	Disabled	Menu Level >>
Wake-Up on PCI PME	Disabled	
Wake-Up on RTC Alarm	Disabled	
x Date of Month Alarm	0	
x Time (hh:mm:ss) Alarm	0 : 0 : 0	
> IRQs Activities	Press Enter	
Move Enter:Select +/-/PU/PD:Value F10:Save ESC:Exit F1:General Help F5:Previous Values F6:Optimized Defaults F7:Standard Defaults		

Wake Up On Ring/PME

During Disabled, the system will ignore any incoming call from the modem. During Enabled, the system will boot up if there's an incoming call from the modem.

Wake-Up on RTC Alarm

This function is for setting date and time for your computer to boot up. During Disabled, you cannot use this function. During Enabled, choose the Date and Time Alarm:

Date(of month) Alarm

You can choose which month the system will boot up. Set to 0, to boot every day.

Time(hh:mm:ss) Alarm

You can choose what hour, minute and second the system will boot up.

Note: If you have change the setting, you must let the system boot up until it goes to the operating system, before this function will work.

IRQs Activities

Please refer to section 3-8-1.1

3-8-1.1 IRQs Activities

CMOS Setup Utility - Copyright(C) 1984-2003 Award Software

IRQs Activities

Primary INTR	ON	Item Help
IRQ3 (COM 2)	Enabled	Menu Level >>>
IRQ4 (COM 1)	Enabled	
IRQ5 (LPT 2)	Enabled	
IRQ6 (Floppy Disk)	Enabled	
IRQ7 (LPT 1)	Enabled	
IRQ8 (RTC Alarm)	Disabled	
IRQ9 (IRQ2 Redir)	Disabled	
IRQ10 (Reserved)	Disabled	
IRQ11 (Reserved)	Disabled	
IRQ12 (PS/2 Mouse)	Enabled	
IRQ13 (Coprocessor)	Disabled	
IRQ14 (Hard Disk)	Enabled	
IRQ15 (Reserved)	Disabled	

↑↓←→ Move Enter:Select +/-/PU/PD:Value F10:Save ESC:Exit F1:General Help
F5:Previous Values F6:Optimized Defaults F7:Standard Defaults

3-9 PnP/ PCI Configuration Setup

This section describes configuring the PCI bus system. PCI, or **P**ersonal **C**omputer **I**nterconnect, is a system which allows I/O devices to operate at speeds nearing the speed the CPU itself uses when communicating with its own special components. This section covers some very technical items and it is strongly recommended that only experienced users should make any changes to the default settings.

PnP/PCI Configurations

PnP OS Installed	No	Item Help
Reset Configuration Data	Disabled	
Resources Controlled By	Manual	Menu Level >
x IRQ Resources	Press Enter	
PCI/VGA Palette Snoop	Disabled	
Assign IRQ For VGA	Enabled	
Assign IRQ For USB	Enabled	
Move Enter:Select +/-/PU/PD:Value F10:Save ESC:Exit F1:General Help F5:Previous Values F6:Optimized Defaults F7:Standard Defaults		

Reset Configuration Data

Normally, you leave this field Disabled. Select Enabled to reset Extended System Configuration Data (ESCD) when you exit Setup if you have installed a new add-on and the system reconfiguration has caused such a serious conflict that the operating system can not boot. The settings are: Enabled and Disabled.

Resource Controlled By

The Award Plug and Play BIOS has the capacity to automatically configure all of the boot and Plug and Play compatible devices. However, this capability means absolutely nothing unless you are using a Plug and Play operating system such as Windows®95/98. If you set this field to "manual" choose specific resources by going into each of the sub menu that follows this field (a sub menu is preceded by a ">").

The settings are: Auto(ESCD), Manual.

IRQ Resources

When resources are controlled manually, assign each system interrupt a type, depending on the type of device using the interrupt.

Please refer to section 3-9-1

PCI/VGA Palette Snoop

Leave this field at *Disabled*. The settings are Enabled, Disabled.

3-9-1 IRQ Resources

CMOS Setup Utility - Copyright(C) 1984-2003 Award Software

IRQ Resources

IRQ3	assigned to	PCI Device	Item Help
IRQ4	assigned to	PCI Device	Menu Level >>
IRQ5	assigned to	PCI Device	
IRQ7	assigned to	PCI Device	
IRQ9	assigned to	PCI Device	
IRQ10	assigned to	PCI Device	
IRQ11	assigned to	PCI Device	
IRQ12	assigned to	PCI Device	
IRQ14	assigned to	PCI Device	
IRQ15	assigned to	PCI Device	

↑↓→← Move Enter:Select +/-/PU/PD:Value F10:Save ESC:Exit F1:General Help
F5:Previous Values F6:Optimized Defaults F7:Standard Defaults

3-10 PC Health Status

This section shows the Status of you CPU, Fan, Warning for overall system status. This is only available if there is Hardware Monitor onboard.

CMOS Setup Utility - Copyright(C) 1984-2003 Award Software

PC Health Status

Shutdown Temperature	Disabled	Item Help
CPU Warning Temperature	Disabled	Menu Level >
Show PC Health in Post	Enabled	
Current System Temperature	25°C	
Current CPU Temperature	38°C	
CPUFAN	5000 rpm	
SYSFAN	5000 rpm	
Vcore	1.78V	
Vcc3.3	3.31V	
+ 5V	4.98V	
+12V	12.22V	
-12V	-12.36V	
-5V	-5.09V	
VBAT(V)	3.21V	
5VSB(V)	5.02V	

Move Enter:Select +/-/PU/PD:Value F10:Save ESC:Exit F1:General Help
F5:Previous Values F6:Optimized Defaults F7:Standard Defaults

Shutdown Temperature

This item can let users setting the Shutdown temperature, when CPU temperature over this setting the system will auto shutdown to protect CPU.

Show PC Health in Post

During Enabled, it displays information list below. The choice is either Enabled or Disabled.

Current CPU Temperature/Current System Temp/Current FAN1, FAN2 Speed/Vcore/ Vdd/ 3.3V/+5V/+12V/-12V/VBAT(V)/5VSB(V)

This will show the CPU/FAN/System voltage chart and FAN Speed.

Detect CPUFAN in Post

During Enabled, system will warn the user if CPU Fan is not functioning.

3-11 Miscellaneous Control

This section is for setting CPU Frequency/Voltage Control.

CMOS Setup Utility - Copyright(C) 1984-2003 Award Software

Miscellaneous Control

CPU Clock Ratio	8X	Item Help
Auto Detect DIMM/PCI Clk	Enabled	Menu Level >
Spread Spectrum	Disabled	
** Current Host/PCI Clock is 100/33MHz **		
Host/PCI Clock at Next Boot is	100/33MHz	
** Current DRAM Clock is 133MHz **		
DRAM Clock at next Boot is	133MHz	
VCCQ Select	1.5V(Default)	
+2.5V Select	2.5V(Default)	
VDIMM Select	2.6V(Default)	
Move Enter:Select +/-/PU/PD:Value F10:Save ESC:Exit F1:General Help		
F5:Previous Values F6:Optimized Defaults F7:Standard Defaults		

Auto Detect DIMM/PCI Clk

This item allows you to enable/disable auto detect DIMM/PCI Clock.

Spread Spectrum

This item allows you to set the CPU Host/PCI clock and Spread Spectrum.

The settings are: Enabled, Disabled.

Host Clock at next Boot is

This item allows you to select CPU frequency step by step increasing

The choice are: 100MHz~132MHz, 133MHz~165MHz, 166MHz~255MHz.

DRAM Clock at next Boot is

This field displays the capability of the memory modules that you can use

The choice is either 100MHz or 133MHz or 166MHz or 200MHz.

VCCQ Select

This item allows you to select 1.5V of the AGP 4X/8X VGA card. The choice are: 1.5V, 1.6V.

VDIMM Select

This item allows you to select 2.5V of the DDR Module. The choice are: 2.5V, 2.6V, 2.7V, 2.8V.

3-12 Load Standard/Optimized Defaults

Load Standard Defaults

When you press <Enter> on this item, you get confirmation dialog box with a message similar to:

Load Standard Defaults (Y/N)? N

Pressing <Y> loads the BIOS default values for the most stable, minimal-performance system operations.

Load Optimized Defaults

When you press <Enter> on this item, you get a confirmation dialog box with a message similar to:

Load Optimized Defaults (Y/N)? N

Pressing <Y> loads the default values that are factory settings for optimal performance system operations.

3-13 Set Supervisor/User Password

You can set either supervisor or user password, or both of them. The differences are:

Supervisor password: Can enter and change the options of the setup menus.

User password: Can only enter but do not have the right to change the options of the setup menus. When you select this function, the following message will appear at the center of the screen to assist you in creating a password.

ENTER PASSWORD:

Type the password, up to eight characters in length, and press <Enter>. The password typed now will clear any previously entered password from CMOS memory. You will be asked to confirm the password. Type the password again and press <Enter>. You may also press <Esc> to abort the selection and not enter a password.

To disable a password, just press <Enter> when you are prompted to enter the password. A message will confirm that the password will be disabled. Once the password is disabled, the system will boot and you can enter Setup freely.

PASSWORD DISABLED.

When a password has been enabled, you will be prompted to enter it every time you try to enter Setup. This prevents an unauthorized person from changing any part of your system configuration.

Additionally, when a password is enabled, you can also require the BIOS to request a password every time your system is rebooted. This would prevent unauthorized use of your computer. You determine when the password is required within the BIOS Features Setup Menu and its Security option. If the Security option is set to "System", the password will be required both at boot and at entry to Setup. If set to "Setup", prompting only occurs when trying to enter Setup.

Chapter 4

DRIVER & FREE PROGRAM INSTALLATION

Check your package and there is A MAGIC INSTALL CD included. This CD consists of all DRIVERS you need and some free application programs and utility programs. In addition, this CD also include an auto detect software which can tell you which hardware is installed, and which DRIVERS needed so that your system can function properly. We call this auto detect software MAGIC INSTALL.

MAGIC INSTALL supports WINDOWS 9X/NT/2K/XP

Insert CD into your CD-ROM drive and the MAGIC INSTALL Menu should appear as below. If the menu does not appear, double-click MY COMPUTER / double-click CD-ROM drive or click START / click RUN / type X:\SETUP.EXE (assuming X is your CD-ROM drive).

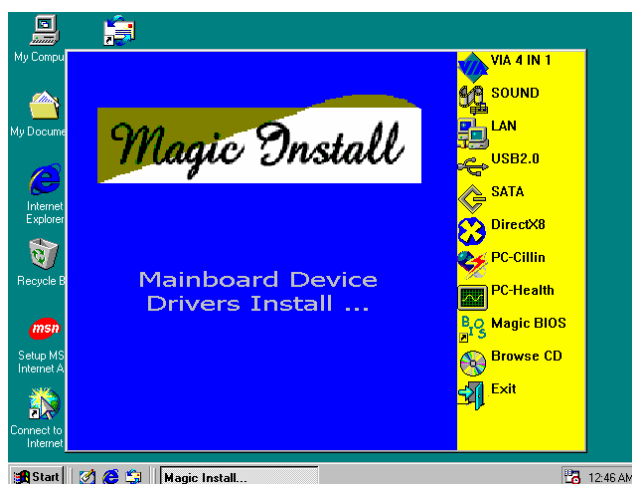

From MAGIC INSTALL MENU you may make 11 selections:

1. VIA 4 IN 1 install VIA Service Pack 4 IN 1 driver
2. SOUND install AC97 Audio Codec Installing driver
3. LAN install VIA LAN Controller driver (**for PT800DBP/PT800DBZ**)
4. USB2.0 install USB 2.0 driver
5. SATA install VIA Serial ATA driver
6. DIRECTX8 install Microsoft DirectX 8.1 driver
7. PC-CILLIN install PC-CILLIN2002 anti-virus program
8. PC-HEALTH install Winbond PC-HEALTH hardware monitor Software
9. MAGIC BIOS install BIOS Live Update Utility
10. BROWSE CD to browse the contents of the CD
11. EXIT to exit from MAGIC INSTALL menu

4-1 VIA 4IN1 Install VIA Service Pack 4 IN 1 Driver

* **The path of the file is X:\VIA\DRIVER\SETUP.EXE**

IDE : VIA ATAPI VENDOR SUPPORT DRIVER IS USED TO FIXED COMPATIBILITY ISSUE FOR IDE DEVICES

AGPVXD : VIA AGPVXD DRIVER IS TO BE INSTALLED, IF YOU ARE USING AN AGP VGA CARD, VIAGART.VXD WILL PROVIDE SERVICE ROUTINES TO YOUR VGA DRIVER AND INTERFACE DIRECTLY TO HARDWARE, PROVIDING FAST GRAPHIC ACCESS

IRQ ROUTING : VIA PCI IRQ MINIPORT DRIVER IS TO BE INSTALLED UNDER WIN98 ONLY, IT WILL FIX PCI IRQ ROUTING SEQUENCE

INF : VIA REGISTRY DRIVER IS TO BE INSTALLED UNDER WINDOWS THE DRIVER WILL ENABLE VIA POWER MANAGERMENT CONTROLLER



1. Click IDE when MAGIC INSTALL MENU appears

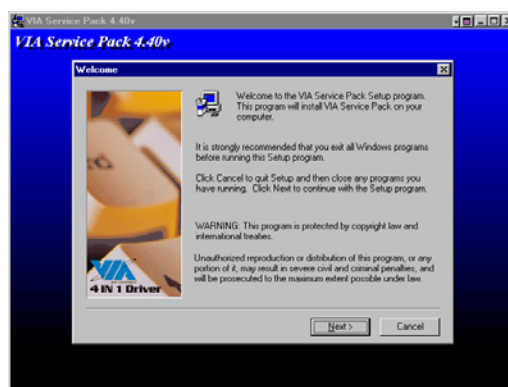

2. Click NEXT when VIA Service Pack Wizard appears



3. This is to announce the Copy Write, click Yes

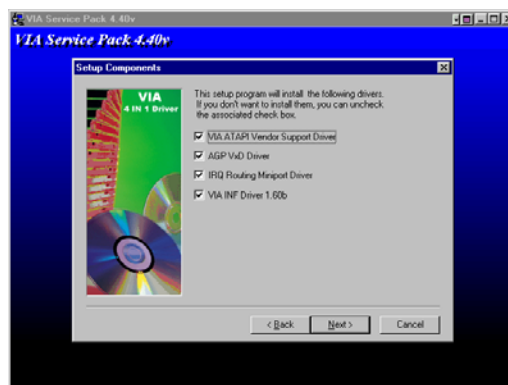

4. Click NEXT to choose all driver

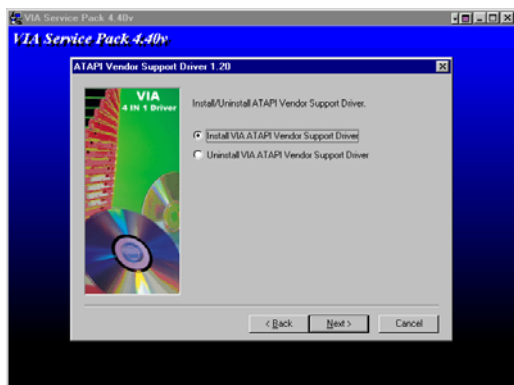

5. Click NEXT to Install ATAPI Vender Support Driver

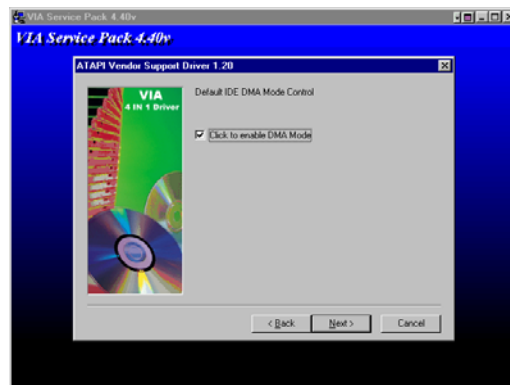

6. Click NEXT to choose enabled DMA Mode



7. Click NEXT to Install VIA AGP VXD Driver

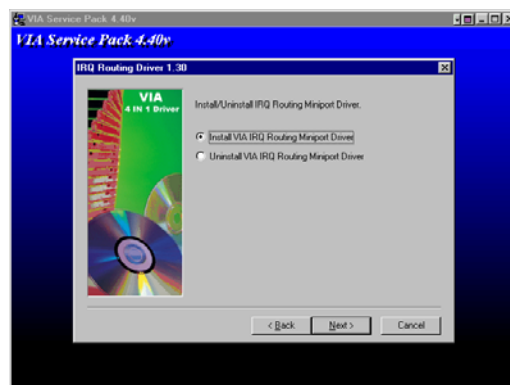

8. Click NEXT to Install VIA IRQ Routing Mini port Driver

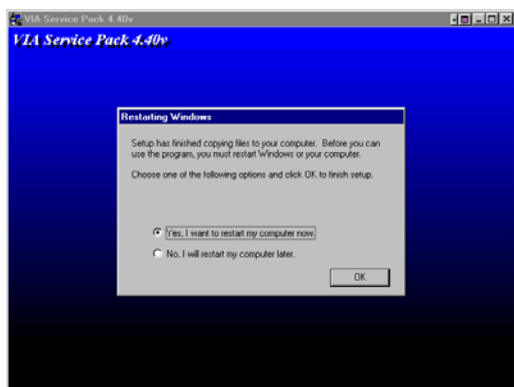

9. Click Finish to restart computer

4-2 SOUND install ALC AC97' Codec Audio Driver



1. Click SOUND when MAGIC INSTALL MENU appears

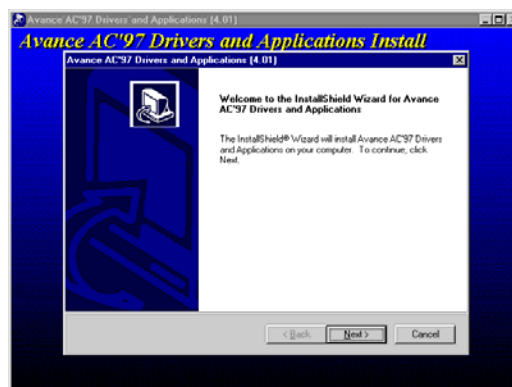

2. Then auto detect operation system language edition, click OK, start to install DRIVER



3. Click Finish and Restart Windows

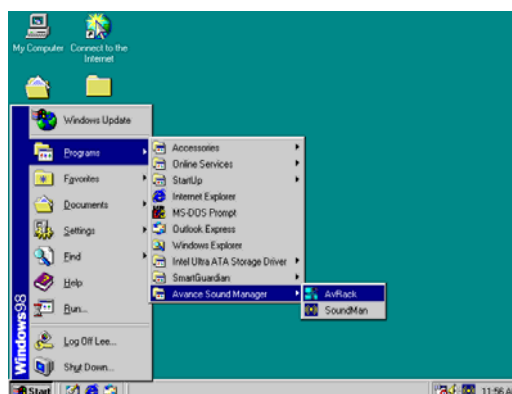

4. Click Start→Program→Avance Sound Manager→AvRack. Then AVRACK Windows appears

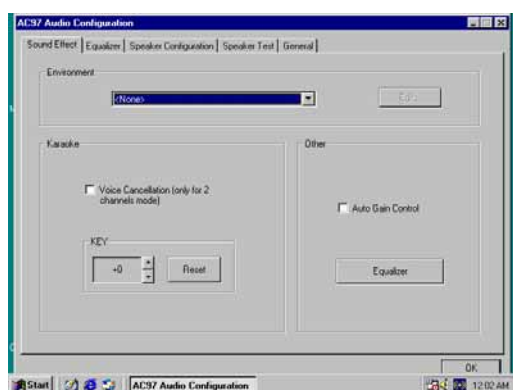

5. Sound Effect select and KaraOK Mode Function



6. Manual Sound Effect Setting



7. 2/4/6 channel speaker configuration setting 8. 6 channel speaker place test

Note: The path of the file

For WIN98/NT4.0/WIN2K/XP is X:\CODEC\ALC\SETUP.EXE

Note: In Win2K/WinME users have to click Control Panel\System\Device Manager\DVD\CD-ROM drives to Enabled digital CD Audio for the CD-ROM Device when use the SPDIF-Out digital signal.

4-3 LAN Install VIA LAN Controller Driver (PT800DBP/PT800DBZ)

The VIA 10/100Mb PCI Ethernet Adapter Driver path is X:\VIA\LANDRV



1. Click LAN when Magic Install Menu appear 2. Setup VIA 10/100Mb PCI Ethernet Driver



3. Driver install Finish, Click Yes and Restart Computer 4. When windows ask VIA 10/100Mb PCI Ethernet Adapter driver path, Change directory to X:\VIA\LANDRV and click OK, then finish installation

4-4 PC-HEALTH Winbond Hardware Doctor Monitoring Software

The path of the file is X:\VIA\HEALTH-W\SETUP.EXE
(Only support WINDOWS 95/98/98SE/ME)

In Windows 95/98 Winbond Hardware Doctor Monitoring Software needs some system files to copy in Utility that's why it needs install PC-HEALTH twice to complete setup.



1. Click PC-Health when Magic Install Menu appears



2. Click OK when Winbond Hardware Doctor Setup Window appears



3. Click the Button to start installation



4. Select Program Group name or enter a new group name, click continue to setup and click OK after setup complete



5. Click Program → Winbond Hardware Doctor → Hardware Doctor the Winbond Hardware Doctor will appear
You can remove the Utility in Control Panel → Add/Remove Program icon

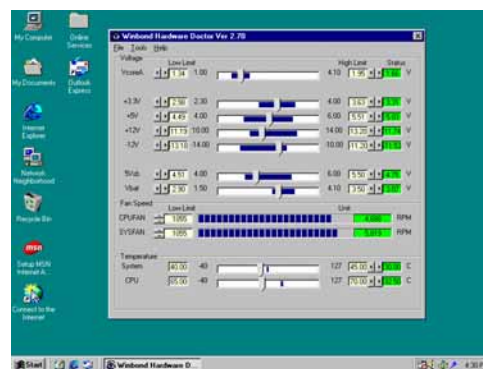

6. After executing Winbond Hardware Doctor it supports system voltage, Fan speed and CPU/SYSTEM Temperature. Because this is a On-time Monitoring program therefore the value will change after it detected, if the value is over default setting the system will have warning picture and beeps

4-5 MAGIC BIOS Install BIOS Live Update Utility



1. Click Magic BIOS when Magic Install MENU appears



2. Click Next to install the Magic BIOS in Destination Folder



3. After finish Setup you will have a Magic BIOS icon in your screen

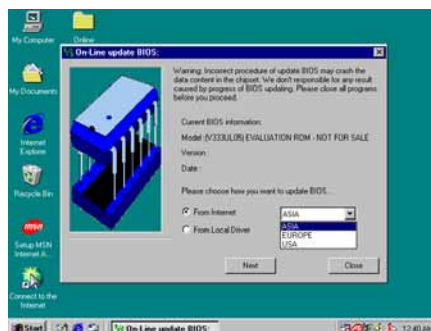

4. Double click the Magic BIOS icon you will have this picture, choose from internet you can upgrade BIOS On-line

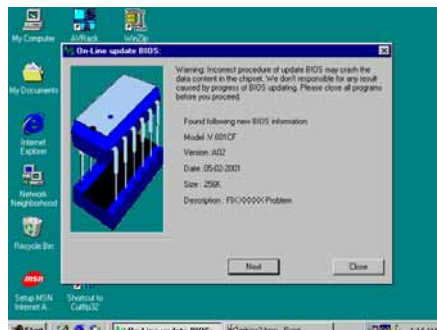

5. When On-line update BIOS the program will auto-check your BIOS version

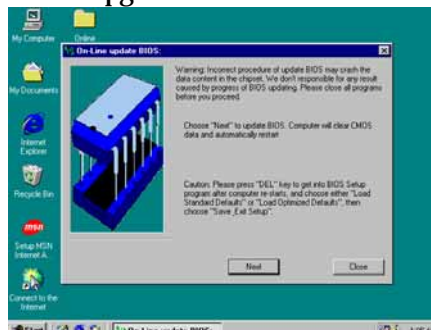

6. Click Next if you need update BIOS, after upgrade BIOS, the system will clear CMOS and automatically restart

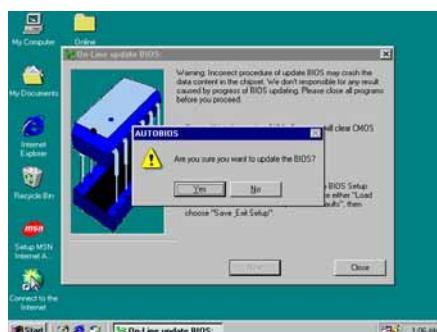

7. Click Yes if you want to update the BIOS otherwise choose No to exit

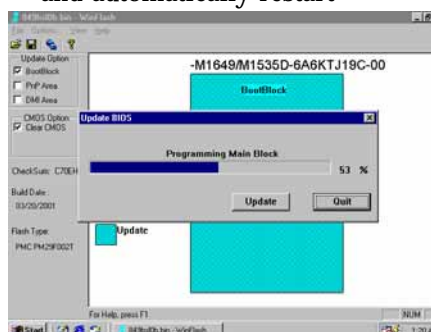

8. When System programming BIOS don't turn off power, after finish update BIOS, the system will clear CMOS and automatically Restart

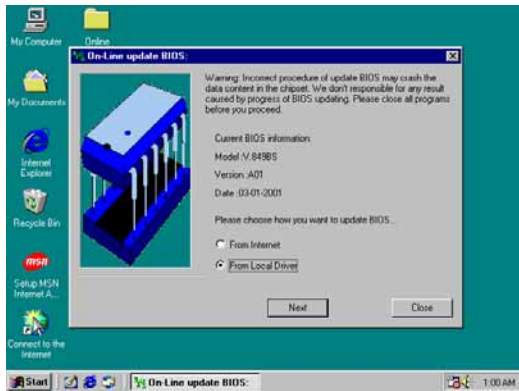

9. When choose From Local Driver to update BIOS, you must have the correct BIOS file in your Local Driver
10. Choose the correct BIOS file to update BIOS

4-6 PC-CILLIN Install PC-CILLIN 2002 Anti-virus program

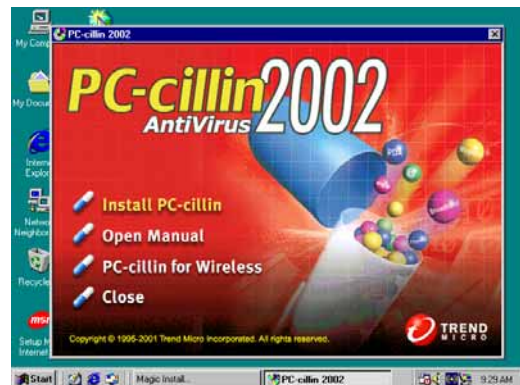
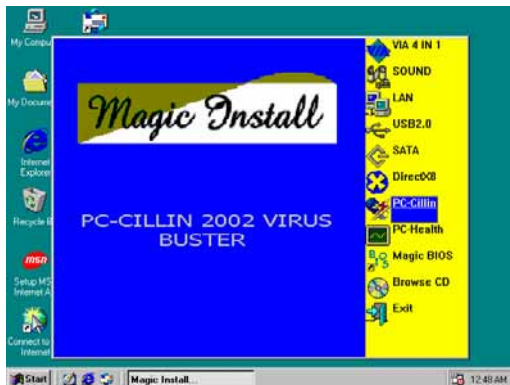

1. Click PC-CILLIN when MAGIC INSTALL MENU appear
2. (1) Click "Install PC-CILLIN" when PC-CILLIN 2002 main menu appears, and Click NEXT when "Install Shield Wizard For PC-CILLIN 2002"
(2) Click Open Manual. you can learn PC-CILLIN 2002 how to use

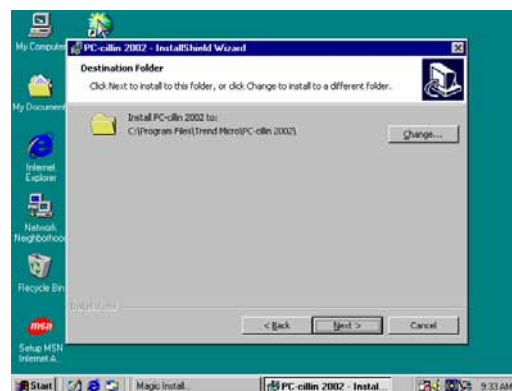

3. This is license agreement, select "I Accept the terms" and Click NEXT
4. Click NEXT and Enter your Customer Information, Click NEXT or choose Change to change the path for the file to be stored

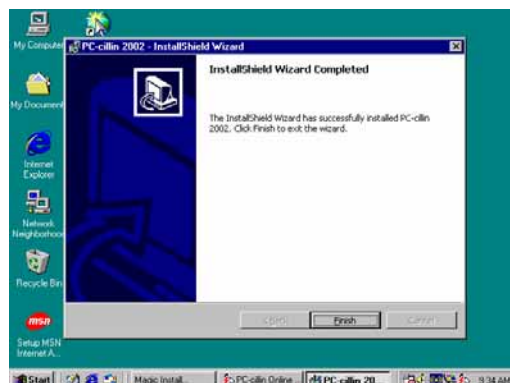
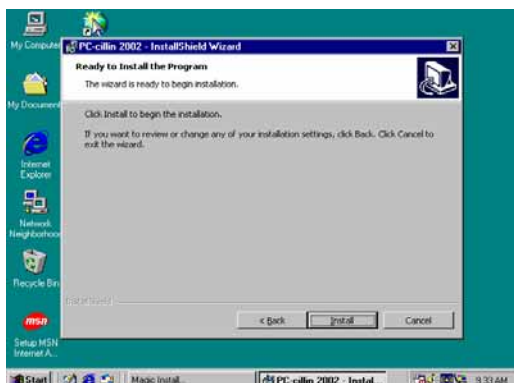

5. Click INSTALL, Start to install the software 6. Setup Complete and click FINISH



7. After PC-CILLIN 2002 complete, Please register your information and get LICENSE KEY from TREND MICRO web site, enter your license key and click FINISH 8. finish register process, we recommend select update item to download newest engine code and virus code

Note : Please install ACROBAT READER, Before you read PC-CILLIN 2002 User Manual, the path at X:\acrobat\ar500eng.exe

4-7 USB2.0 Install VIA USB2.0 DEVICE DRIVER

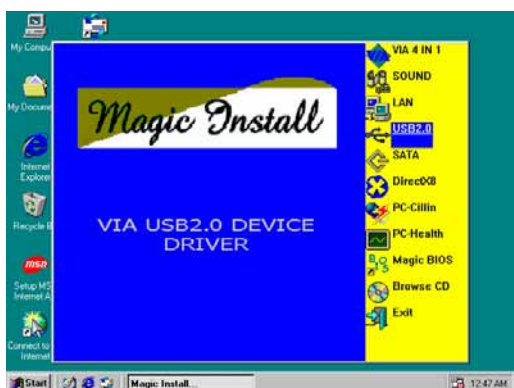

1. Click USB2.0 when MAGIC INSTALL MENU Appear 2. When USB2.0 Setup Program Appear, Click NEXT

Note: Please Install Microsoft Service Pack 1 in Windows XP OS Before you Install VIA USB2.0 Device Driver.



3. Select Install USB Driver and Click NEXT



4. Select FINISH and Restart your Computer



5. Check device working properly in Device Manager

The Path of the file is X:\VIA\VIAUSB20\SETUP.EXE

4-8 SATA Install VIA Serial ATA



1. Click SATA when MAGIC INSTALL MENU appears

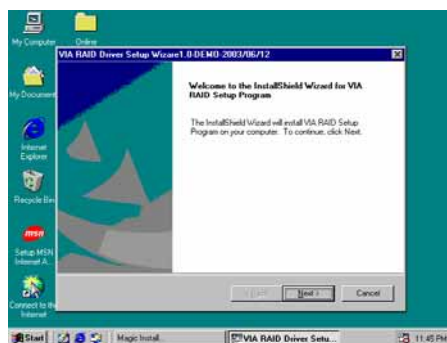

2. Start install VIA serial ATA driver , then click NEXT

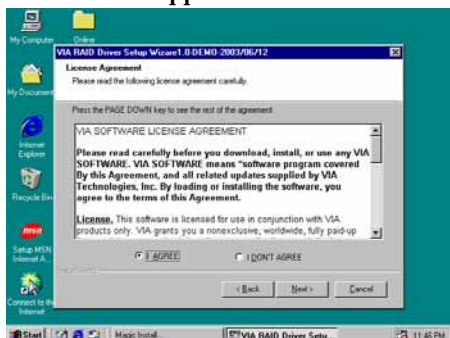

3. When license agreement appear, choose I agree and click NEXT

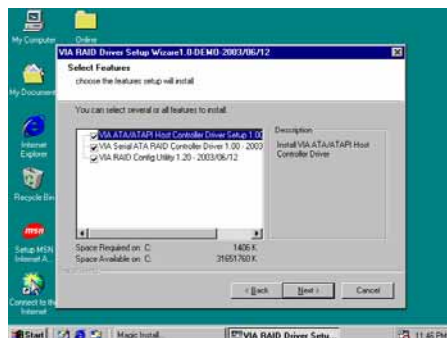

4. Select you want to install driver

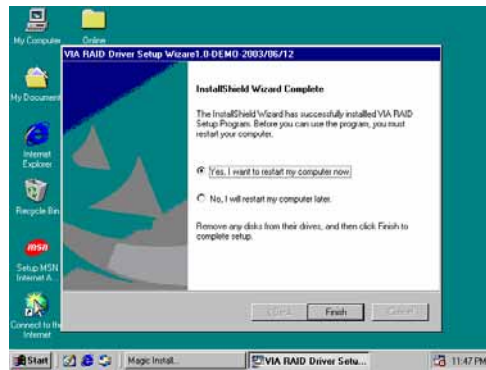
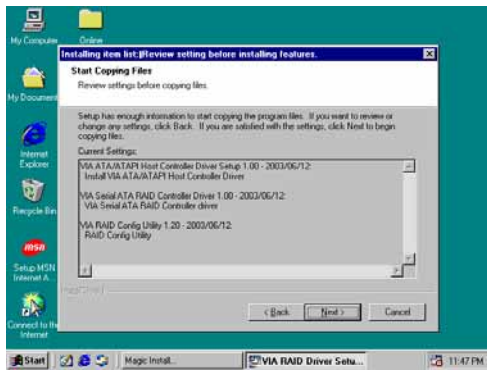

5. Review install driver and utility component, then click NEXT
6. Click FINISH and restart your computer

4-9 HOW TO DISABLE ON-BOARD SOUND

Enter BIOS SETUP choose INTEGRATE PERIPHERALS choose ON-CHIP DEVICE FUNCTION choose AC97 SOUND DEVICE

Disable on-board sound function by press PAGE DOWN KEY to Disable

4-10 HOW TO UPDATE BIOS

Method 1. Use "Magic BIOS" update BIOS in Windows 98 (refer [page 46](#))

Method 2. In DOS Mode

STEP 1. Prepare a boot disc. (you may make one by click START click RUN type SYS A: click OK)

STEP 2. Copy utility program to your boot disc. You may copy from DRIVER CD X:\FLASH\AWDFLASH.EXE or download from our web site.

STEP 3. Copy latest BIOS for PT800DB/PT800DBP from our web site to your boot disc.

STEP 4. Insert your boot disc into A:,

start the computer, type "Awdflash A:\ PT800DBPAxxx.BIN /SN/PY/CC/R"

PT800DBPAxxx.BIN is the file name of latest BIOS it can be PT800DBPA3.BIN or PT800DBPB2.BIN

SN means don't save existing BIOS data

PY means renew existing BIOS data

CC means clear existing CMOS data

R means restart computer

STEP 5. Push ENTER and the BIOS will be updated, computer will be restarted automatically.

Free Manuals Download Website

<http://myh66.com>

<http://usermanuals.us>

<http://www.somanuals.com>

<http://www.4manuals.cc>

<http://www.manual-lib.com>

<http://www.404manual.com>

<http://www.luxmanual.com>

<http://aubethermostatmanual.com>

Golf course search by state

<http://golfingnear.com>

Email search by domain

<http://emailbydomain.com>

Auto manuals search

<http://auto.somanuals.com>

TV manuals search

<http://tv.somanuals.com>