

IWILL P4D/P4D-N Motherboard User's Manual

Federal Communications Commission (FCC) Statement

This equipment has been tested and found to comply with the limits for a Class B digital device, pursuant to Part 15 of the FCC Rules. These limits are designed to provide reasonable protection against harmful interference in a residential installation. This equipment generates, uses, and can radiate radio frequency energy and, if not installed and used in accordance with the instructions, may cause harmful interference to radio communications. However, there is no guarantee that interference will not occur in a particular installation. If this equipment does cause harmful interference to radio or television reception, which can be determined by turning the equipment off and on, the user is encouraged to try to correct the interference by one or more of the following measures:

- Reorient or relocate the receiving antenna.
- Increase the separation between the equipment and the receiver.
- Connect the equipment onto an outlet on a circuit different from that to which the receiver is connected.
- Consult the dealer or an experienced radio/TV technician for help.

Shielded interconnect cables and shielded AC power cable must be employed with this equipment to insure compliance with the pertinent RF emission limits governing this device. Changes or modifications not expressly approved by the system's manufacturer could void the user's authority to operate the equipment.

Declaration of Conformity

This device complies with part 15 of the FCC rules. Operation is subject to the following conditions:

- This device may not cause harmful interference, and

This device must accept any interference received, including interference that may cause undesired operation.

Disclaimer

The information in this document is subject to change without notice. The manufacturer makes no representations or warranties with respect to the contents hereof and specifically disclaims any implied warranties of merchantability or fitness for any particular purpose. Furthermore, the manufacturer reserves the right to revise this publication and to make changes from time to time in the content hereof without obligation of the manufacturer to notify any person of such revision or changes.

Trademark Recognition

Microsoft and Windows are registered trademarks of Microsoft Corp.

Intel and Xeon are registered trademarks of Intel Corporation.

Other product names used in this manual are the properties of their respective owners and are acknowledged.

Copyright

- Portions © Intel Corporation

This publication, including all photographs, illustrations and software, is protected under international copyright laws, with all rights reserved. Neither this manual, nor any of the material contained herein, may be reproduced without the express written consent of the copyright holders.

© February 2002

Contents

1: Introduction	1.1
Manual Structure	1.1
Manual Features	1.2
If The Motherboard Is Already Installed	1.2
If You Need To Install This Motherboard	1.2
Critical Topics	1.3
Packing List	1.4
Pre-Use Checklist	1.4
2: Key Features & Components	2.1
Motherboard Layout	2.2
Key Features & Components	2.4
<i>Intel 845 Chipset</i>	2.5
CPU Sockets	2.5
System Memory Sockets	2.6
The AGP Slot	2.7
PCI Expansion Slots	2.7
Drive Connectors	2.9
<i>IDE Drive Connectors</i>	2.9
<i>Floppy Disk Drive Connector</i>	2.9
Other Internal Connectors	2.10
<i>ATX Power Connectors</i>	2.10
<i>CPU & System Cooling Fan Connectors J39, 40, 41</i>	2.10
<i>WOL: Wake On LAN Connector J75</i>	2.11
<i>CD-In & AUX Audio Connectors J69 & J70</i>	2.12
<i>IR Connector J45</i>	2.12
<i>6-Channel Audio Option Connector J66/67</i>	2.13
<i>Chassis Intrusion Switch Connector JP12</i>	2.13
<i>USB Ports 3/4 Connector J65</i>	2.14
<i>Smartcard Reader Connector J78</i>	2.14
<i>System Management Bus Connector SMB1</i>	2.15
<i>Front Panel Connectors</i>	2.15
<i>Battery Connector BT</i>	2.16
External I/O Ports	2.16
<i>PS/2 Ports</i>	2.16
<i>USB Ports</i>	2.17

.....

<i>LAN Port (Optional by Model)</i>	2.17
<i>Parallel Port</i>	2.17
<i>Serial (COM) Ports</i>	2.18
<i>Audio Jacks & Connectors</i>	2.18
Jumpers	2.19
<i>JP1 Clear CMOS</i>	2.19
<i>JP6 Keyboard Power On</i>	2.19
<i>JP10 Audio Chip</i>	2.19
<i>JP16 Flash Protect</i>	2.19
<i>JP17 LAN Chip</i>	2.19
Software Features	2.20
Using the Power Installer Disc	2.20
Driver Software	2.21
Utility Software	2.22
3: Motherboard Configuration	3.1
The Default Configuration	3.1
Hardware Configuration: Jumper Settings	3.1
<i>Jumper JP6: Clear CMOS Memory</i>	3.2
<i>Jumper JP4: BIOS Flash Protect</i>	3.4
<i>Jumper JP6: Keyboard Power On</i>	3.6
<i>Jumper JP10: Audio Chip</i>	3.6
<i>Jumper JP17: LAN Chip</i>	3.6
Firmware Configuration: The CMOS Setup Utility	3.7
<i>Using the CMOS Setup Utility</i>	3.7
Reconfiguring the Motherboard	3.9
Hardware Reconfiguration	3.9
Firmware Reconfiguration	3.9
4: Installing the Motherboard	4.1
Pre-installation Preparation	4.1
Installing A CPU	4.2
<i>Processor Selection</i>	4.2
<i>Installing The Processor</i>	4.3
<i>Installing the Heatsink</i>	4.5
Installing System Memory	4.8
<i>Memory Specifications</i>	4.8
<i>Memory Configuration Options</i>	4.8
<i>Installing Memory Modules</i>	4.9
<i>System Memory Recognition</i>	4.10
Installing the Motherboard in a System Housing	4.10

<i>Motherboard Installation Procedure</i>	4.10
<i>Connecting Front Panel Components</i>	4.12
Completing System Configuration	4.12
5: System Configuration	5.1
Installing or Connecting Internal Peripherals	5.1
Installing an AGP Card	5.2
<i>AGP Configuration</i>	5.2
<i>Display Drivers</i>	5.2
Connecting Internal Devices	5.3
<i>Connecting IDE Devices</i>	5.3
<i>Connecting a Floppy Disk Drive</i>	5.4
Connecting External System Peripherals	5.6
Connecting a Display Monitor	5.6
Connecting a Keyboard & Mouse.....	5.6
Configuring the CMOS Setup Utility	5.8
The CMOS Setup Utility User Interface	5.8
<i>Running the CMOS Setup Utility</i>	5.8
CMOS Setup Utility Program Sections	5.10
<i>Standard CMOS Features</i>	5.12
<i>Advanced Boot Options</i>	5.13
<i>Advanced Chipset Features</i>	5.14
<i>Integrated Peripherals</i>	5.15
<i>Power Management Setup</i>	5.16
<i>PnP/PCI Configurations</i>	5.17
<i>PC Health Status</i>	5.18
<i>CPU Smart Setting</i>	5.19
<i>PC Health Status</i>	5.20
<i>Load Fail-Safe Defaults</i>	5.21
<i>Load Optimized Defaults</i>	5.21
<i>Set Supervisor/User Password</i>	5.22
<i>Save & Exit Setup</i>	5.22
<i>Exit Without Saving</i>	5.22
Installing an OS & Support Software	5.24
Installing an Operating System	5.24
Installing the Support Software	5.24
<i>Installing Windows Drivers</i>	5.25
<i>The Make Driver Utility</i>	5.27
<i>Making & Installing Linux Drivers</i>	5.27
Installing the Utility Software	5.28

.....

6: Using the Motherboard	6.1
Using System Features	6.1
Front Panel System Controls & Indicators	6.1
<i>System Controls</i>	6.1
<i>Indicator LEDs</i>	6.3
Additional System Features	6.3
<i>Wake-on LAN (WOL)</i>	6.3
Installing & Configuring An IR Port	6.4
Performance Optimization	6.6
System Memory	6.6
Disk Subsystems	6.6
Processor Upgrades & Adjustments	6.6
Troubleshooting	6.7
Hardware Problems	6.7
General Hardware Troubleshooting	6.7
Hardware Configuration Problems	6.8
<i>Plug and Play Problems</i>	6.9
Replacing the System Configuration Record	6.9
Loading Optimized Defaults	6.9
7: Technical Specifications	7.1

What's In This Chapter:

Introduction
Manual Structure
Manual Features
Critical Topics
Packing List
Pre-Use Checklist

1: Introduction

This is the User's Manual is for the P4D-N motherboard. Please read this chapter before you use your motherboard and identify which parts of the manual you will need to refer to, if any. Please pay particular attention to the Critical Topics section.

Manual Structure

This manual has seven chapters covering the following topics:

Chapter 1: Introduction

Explains the manual structure and conventions and indicates the most important topics in the manual. In addition, there is a list of what you should find in the motherboard package and some pointers on things to do before you configure or install the board.

Chapter 2: Key Features & Components

Details the motherboard's hardware features and important components and indicates their locations. Describes the support software that comes with the board on the Power Installer support CD-ROM disc.

Chapter 3: Motherboard Configuration

Lists the motherboard's default configuration and configuration options.

Chapter 4: Installing The Motherboard

Has information on how to prepare and install the motherboard. Includes installing a CPU and system memory and housing installation considerations.

Chapter 5: System Configuration

Covers connecting system peripherals to the motherboard, initial BIOS configuration using the CMOS Setup utility, OS options and software installation.

Chapter 6: Using The Motherboard

Explains system operation features that derive from the motherboard. Has information on performance optimization and troubleshooting.

Chapter 7: Technical Information

Lists the motherboard's technical specifications.

Manual Features

This User's Manual is intended to be useful and informative while also making it easy to quickly find specific information or specifications. The manual has icons and notes in the sidebar to note important topics, indicate warnings or further explain and illustrate points. We suggest that most users review the manual to become familiar with the motherboard. Expert users may want to review topics selectively, as needed.

If The Motherboard Is Already Installed

You may receive the motherboard installed in a working system. If this is the case, you should still probably review the sections on configuring and using the board, especially if an Operating System is not installed yet.

If You Need To Install This Motherboard

We recommend that only experienced users and technicians install this motherboard. Otherwise, we suggest having a qualified computer technician install and configure the system. This service is usually provided at a nominal fee by better computer stores and service companies.

Critical Topics

Many users do not read through the entire User's Manual. While this may not be necessary for experienced users or if the motherboard is already installed, there are some topics which are particularly important and deserve your specific attention. Some topics cover information critical to the proper installation and use of the motherboard.

For this motherboard, please review the sections on the following topics:

- CPU installation
Please see Chapter 4.
- System memory installation
Please see Chapter 4.
- AGP card installation
Please see Chapter 5.
- Required BIOS configuration
Please see Chapter 5.
- Support software installation
Please see Chapter 5.

Packing List

The P4D-N motherboard package includes the following items:

- P4D-N motherboard
- ATA-66/100 IDE connector cable
Connects IDE devices to one of the onboard IDE connectors.
- Floppy Disk Drive connector cable
Connects floppy disk drives to the onboard floppy disk connector.
- 3 Jumper Caps
Extra caps in case original caps are lost.
- Power Installer support CD-ROM disc
Includes support software, drivers and bundled software utilities.
- User's Manual
- Quick Installation Guide

Pre-Use Checklist

Before you install and use the motherboard, please do the following:

- Check Package Contents
Please compare the package contents to the Packing List on the previous page and confirm that all items are present and undamaged.
- Missing or Damaged Accessories
If anything is missing, please contact your vendor.
- Motherboard Damage
If the motherboard has been visibly damaged, return the complete package to your vendor with proof of purchase.

- Prepare Minimum System Components

If you are installing the board in a new system, you'll need at least the following internal components;

- Intel Pentium 4 processor
- At least one DDR SDRAM memory module
- 1.5V AGP video display card
- Desired storage devices (hard disk, CD-ROM, etc.)

You will also need whatever external system peripherals you intend to use, which will normally include at least a keyboard, a pointing device and a video display monitor.

Chapter Topics:

Hardware Features

Motherboard Layout

Key Features & Components

Software Features

Driver Software

Utility Software

2: Key Features & Components

This chapter explains the location and function of this motherboard's key features and components. In addition, it details the software that comes on the Power Installer support CD-ROM disc. Please review this chapter if you are installing the motherboard. It is also useful for reference regarding feature functions after the board is installed in a working system.

Motherboard Layout

The diagram and key on these two pages shows the location of key components on the motherboard.

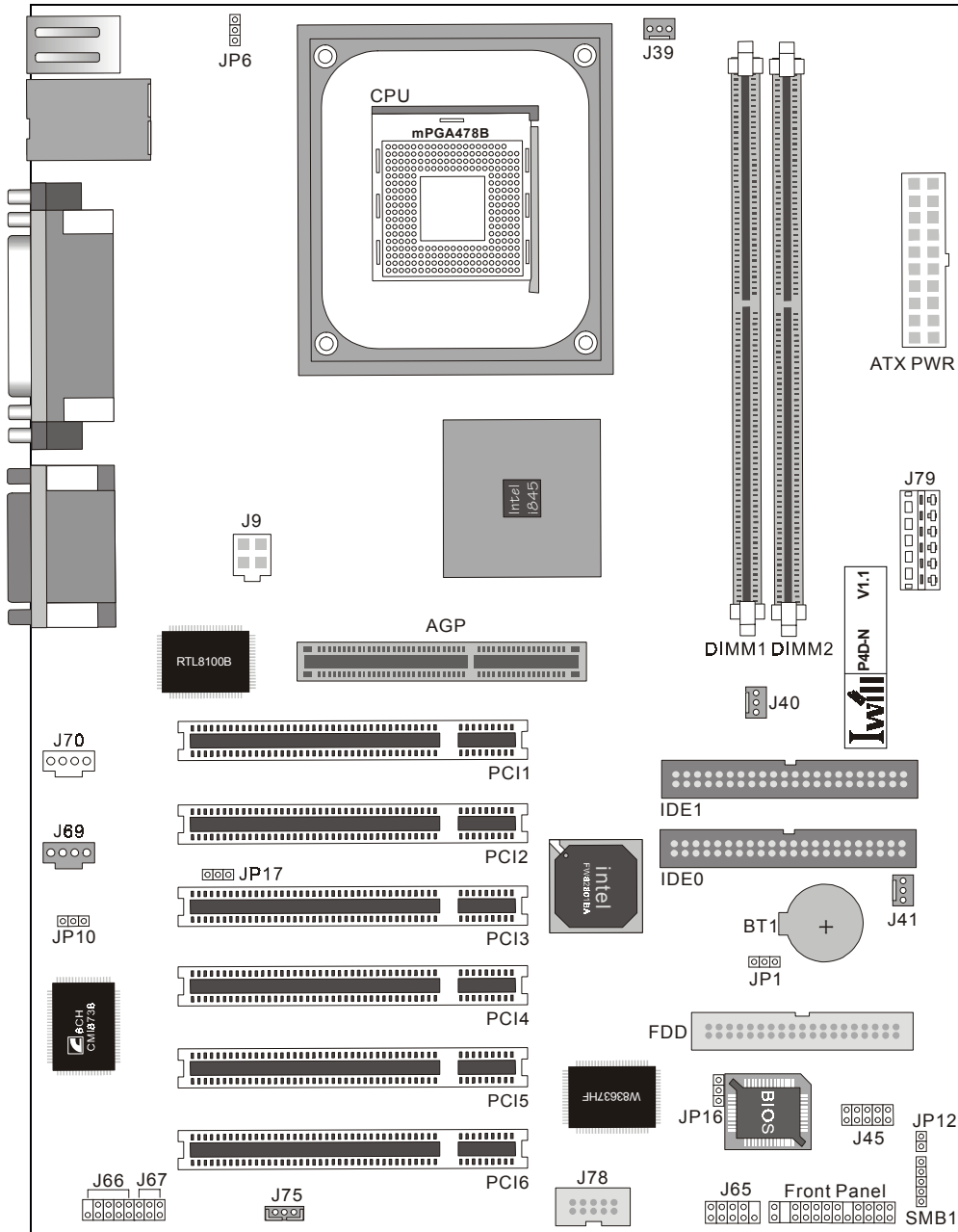

Motherboard Layout Key

Component	Function
CPU	Socket 603 CPU sockets
J39	CPU cooling fan power connectors
ATX PWR, J0, J79	Power connectors for ATX power supply
DIMM 1, 2	DIMM memory sockets for DDR SDRAM modules
AGP	AGP connector for 1.5V AGP 4X display card
PCI 1 – 6	32-bit PCI expansion slots
Connectors	
IDE1, IDE2	IDE drive connectors
FDD	Floppy disk drive connector
J39	CPU cooling fan connector
J40, J41	Housing cooling fan connectors
J45	IR port module connector
J65	USB 3/4 port bracket connector
J66/67	Optional 6-channel audio port bracket connector
J69	CD-In CD-ROM drive audio-in connector
J70	AUX Auxiliary audio-in connector
J75	WOL- Wake-On-LAN connector
J78	Smart Card Reader connector
SMB1	System Management Bus connector
JP12	Case Intrusion connector
Front Panel	Housing front panel feature connector
Jumpers	
JP1	Clear CMOS jumper
JP6	Keyboard Power On jumper
JP10	Audio chip jumper
JP16	BIOS Flash Protection jumper
JP17	LAN chip jumper
Rear panel I/O ports	See figure on next page

Rear I/O Panel Ports:

This figure show the ports on the rear I/O panel. The ports include, from top to bottom:

PS/2 ports

Two USB ports & LAN port

Parallel & Serial ports

Audio & Game/MIDI ports

The ports have standard color-coding as follows:

PS/2 Keyboard: Purple

PS/2 Mouse: Green

USB Ports: Black

LAN jack: None

Serial Ports: Teal

Parallel Port: Burgundy

Line-In jack: Light Blue

Line Out jack: Lime

Mic In jack: Pink

Game/MIDI: Gold

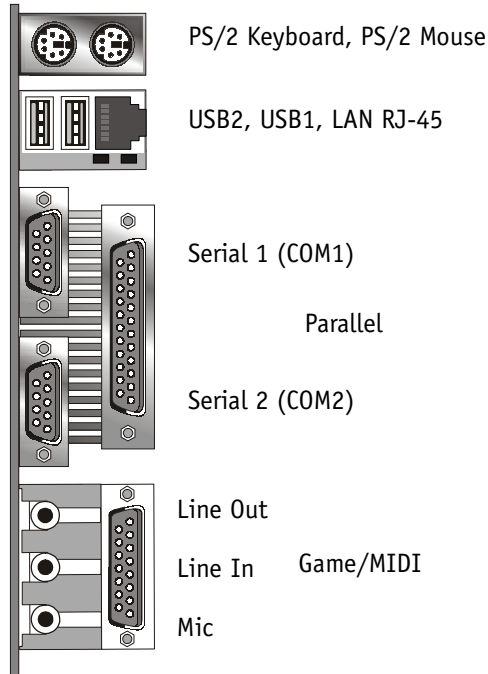

Key Features & Components

This section explains the function and use of key features and components on the motherboard. It also indicates where to look in the manual for additional information on configuring and using them.

This motherboard uses an ATX form factor PCB in a design that integrates many features onto the board including several external ports.

Intel 845 Chipset

This motherboard uses the Intel 845 Chipset. It is a multi-function chipset for higher-end performance and main-stream systems. The components of the Intel 845 Chipset include the following devices mounted on the board:

- 82845 Memory Controller Hub (MCH)
- 82801BA I/O Controller Hub (ICH2)
- 82802 AB Firmware Hub (FWH)

The chipset provides host bus, memory, AGP, and I/O interfaces.

CPU Sockets

Function: The System CPUs install in these sockets. You can install either one or two CPUs, as needed.

Description: The mPGA478B CPU socket supports all 478-pin Intel Pentium 4 CPUs that use this socket. The motherboard comes with a mounting frame mounted on the board to attach the heatsink and cooling fan assembly required by the Pentium 4 CPU.

More Information: See the section in Chapter 4 on “Installing CPUs” for information supported CPUs and their installation procedure. Technical specifications are listed in Chapter 7.

mPGA478B Socket:

This socket is for 478-pin Pentium 4 CPUs only.

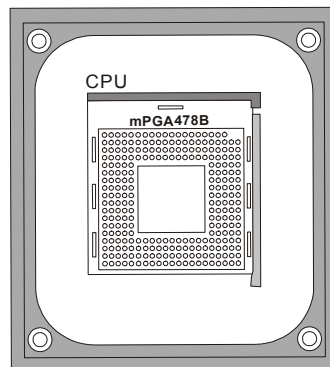

Heatsink/fan assembly mounting frame

System Memory Sockets

Function: The DIMM system memory sockets are for installing DDR SDRAM system memory modules.

Description: There are two DIMM memory module sockets on the motherboard. These sockets are for 200MHz (PC1600) or 266MHz (PC2100) DDR SDRAM memory modules. The sockets function independently, allowing a variety of memory configurations up to a total of 1GB (two 512MB DDR DIMMs).

More Information: See the section on Installing System Memory in Chapter 4 for configuration specifications and installation instructions. Technical specifications are listed in Chapter 7.

DIMM Sockets:

System memory sockets for either 200MHz (PC1600) or 266MHz (PC2100) DDR SDRAM modules.

See Chapter 4 for important installation information.

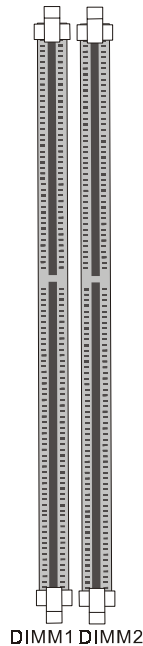

The AGP Slot

Function: The AGP slot is for installing an AGP interface video display card.

Description: The AGP slot is a high-speed slot exclusively designed for an AGP video display card. The AGP slot supports the following type of AGP card:

- AGP 4X – 266MHz data transfer, maximum 1064MB/second data throughput

The slot only supports 1.5V devices. Do not use a 3.3V AGP card with this motherboard.

More Information: See the section “Connecting & Installing Internal Peripherals” in Chapter 4. Technical specifications are listed in Chapter 7. Also, see the Advanced Chipset Features section of “Configuring the CMOS Setup Utility” in Chapter 5 for information on setting the AGP memory aperture size.

PCI Expansion Slots

AGP Slot:

For AGP 2X & 4X 1.5V cards only. Do not use 3.3V cards.

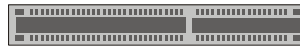

AGP slot is for AGP 2X & 4X cards

Function: The PCI expansion slots are for installing system expansion or “add-on” cards to add additional system hardware.

Description: This motherboard has six Bus Master capable PCI expansion slots. The slots are 32-bit, 33MHz slots and are PCI 2.2-compliant. The slots provide a fast high-bandwidth pathway between the motherboard and expansion cards.

More Information: See the section “Connecting & Installing Internal Peripherals” in Chapter 4. Technical specifications are listed in Chapter 7.

PCI Expansion Slots

All slots are Bus Master capable and PCI 2.2 compliant

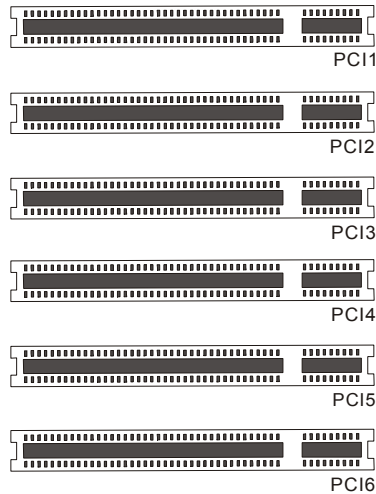

Drive Connectors

There are three drive connectors on the motherboard for connecting IDE and floppy disk drives.

IDE Drive Connectors

Function: The two IDE connectors, marked ‘Primary’ and ‘Secondary’, are for connecting IDE drives to the motherboard.

Description: The IDE controller on the motherboard supports IDE devices running in all modes up through ATA-100. There are two IDE drive connectors. Each connector supports two drives, a ‘Master’ and a ‘Slave’ which connect to the motherboard with a ribbon cable. The supplied cable supports transfer modes through ATA-100.

More Information: See the section on “Connecting Internal Peripherals” in Chapter 5 for instructions on connecting IDE drives. Technical specifications are listed in Chapter 7.

IDE Drive Connectors

The channels are labeled on the board.

Secondary



Primary

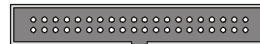

Floppy Disk Drive Connector

Function: The floppy disk drive connector, marked ‘Floppy’, is for connecting one floppy disk drive to the motherboard.

Description: The floppy disk drive connector supports connecting one floppy disk drive to the motherboard. The ‘Floppy’ drive connector uses a standard FDD ribbon cable. The floppy disk drive connected to the end of the cable will function as Drive A:. A second drive can be added as Drive B: if required.

More Information: See the section on “Connecting Internal Peripherals” in Chapter 4 for instructions on connecting a floppy disk drive. Technical specifications are listed in Chapter 7.

Floppy Drive Connector



Other Internal Connectors

There are several other connectors on the motherboard.

ATX Power Connectors

Function: Connectors for leads from a system ATX power supply.

Description: There are three power connectors on the motherboard for leads from an ATX power supply. The power supply leads plug into the connectors. The connector design prevents incorrect orientation. There are two additional connectors in addition to the standard 20-pin ATX connector. The extra 4-pin connector supplies 12-volt current and the 6-pin auxiliary power connector provides additional 3.3 and 5-volt power.

More Information: Please refer to Chapter 4, “Installing the Board in a System Housing”. Chapter 7 lists technical specifications.

ATX Power Connectors:

An ATX power supply with three power leads is required for this board.

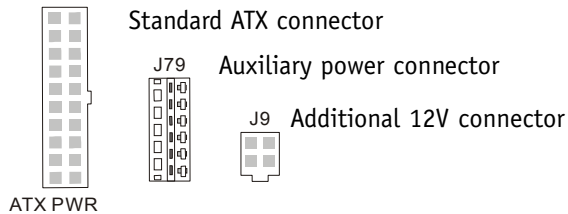

CPU & System Cooling Fan Connectors J39, 40, 41

Function: Power connectors for CPU and system housing cooling fans.

Description: There are one CPU cooling fan connector and two system housing cooling fan connectors on the motherboard. All the connectors are 3-pin headers. The system housing fan connectors support fan tachometer monitoring. The processor heat sink fan is not speed controlled.

The system fans use the motherboard fan speed control, which consists of three states: Off, Normal speed, and High speed. In Normal speed mode, the system fans run at normal speed until the thermal sensor senses the temperature exceeds the High speed fan threshold temperature. The system fans then run at High speed when the temperature threshold is exceeded. You can set the fan threshold temperature in the PC Health section of the CMOS Setup Utility. You can set the threshold to 40°C to force continuous operation of the system fans in high-speed mode in the S0 and S1 sleep states.

More Information: Please see the PC Health Status section of “Configuring the CMOS Setup Utility” in Chapter 5 for information.

Cooling Fan Connectors:

The cooling fan power connectors all use the same 3-pin connector. The System Fan connectors are speed controlled, the CPU Fan connector is not.



Fan power connectors
(orientation varies)



WOL: Wake On LAN Connector J75

Function: A connector for the lead from a Network Interface Card that supports the Wake On LAN feature.

Description: This feature enables the system to “wake up” from Suspend mode when it receives a signal over a LAN it is connected to. It works with the optional onboard LAN port and will also work with an additional PCI NIC that supports this feature by connecting the card to the WOL connector on the motherboard.

The motherboard supports Wake on LAN through the PCI bus PME# signal and the onboard Intel 82550 LAN controller. This signal will wake up the computer only when it is plugged into an AC power source and the system is in a supported sleep state.

More Information: Please see the Power Management Setup section of “Configuring the CMOS Setup Utility” in Chapter 5 for information.

Wake On LAN Connector:

This connector is for an additional NIC. The optional onboard LAN port supports WOL without using this connector.



Wake On LAN connector

CD-In & AUX Audio Connectors J69 & J70

Function: Connectors for audio-in cables from internal peripherals.

Description: The two audio-in connectors on the motherboard are for audio cables from optical drives such as a CD-ROM or DVD-ROM drive or a modem/telephony device. The connectors provide an audio input connection between a device and the integrated audio subsystem.

More Information: Please see the Connecting internal peripherals section in Chapter 5.

Audio-In Connectors:

The J69 CD-In connector is for CD-ROM or other optical drives. Use the J70 AUX connector for an additional drive or a modem/telephony device.



J69 CD-In audio-in connector



J70 AUX audio-in connector

IR Connector J45

Function: Connector for an Infrared (IR) port module.

Description: The IR connector supports both IrDA and ASKIR infrared port modules. Follow the module's instructions to install it.

More Information: Please see the Integrated Peripherals section of "Configuring the CMOS Setup Utility" in Chapter 5 for information.:

IR Connector J45:

The IR connector is for both IrDA and ASKIR port modules. You must use the CMOS Setup Utility to configure the board to use the IR feature.

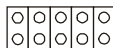

IR connector J45

J45

6-Channel Audio Option Connector J66/67

Function: Connector for the optional 6-channel audio port bracket.

Description: The 6-channel audio connector supports either of the two optional 6-channel audio port brackets. The port bracket provides additional audio connections for a 5.1 speaker system.

More Information: Please see “Connecting Internal Peripherals” section in Chapter 5 and the “System Features” section in Chapter 6.

6-Channel Audio:

This combined connector is for either of the optional audio port brackets which provide additional audio connections for a 5.1 speaker system.

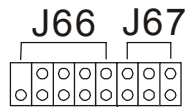

J66/67 Connector:
 J66 S/PDIF
 J67 Sub-Woofer & Rear Speaker

Chassis Intrusion Switch Connector JP12

Function: Connector for Chassis intrusion switch.

Description: The hardware monitor subsystem supports a chassis security feature that detects if the chassis (system housing) cover is removed. When the cover is removed, a signal is sent to the hardware monitor component. The chassis intrusion circuit is powered by the system power supply when the computer is connected to AC power or by the onboard battery when it is not.

This feature uses a mechanical switch on the chassis that connects to the chassis intrusion connector on the motherboard. When the chassis cover is removed the motherboard circuitry will detect the intrusion.

More Information: See the “System Features” section in Chapter 6.

Chassis Intrusion:

This 2-pin connector connects to the lead from a chassis-mounted chassis intrusion switch.

JP12 Chassis Intrusion Switch connector



USB Ports 3/4 Connector J65

Function: Connector for the additional two USB ports port bracket.

Description: Connecting an external 2-port USB port bracket to this connector provides two additional USB ports that function independently from the two external USB ports and have their own Root Hub.

More Information: See the “Connecting Internal Peripherals” section of Chapter 5.

USB Ports 3/4:

Connecting a port bracket to this connector provides two additional USB ports.

J65

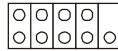

J65 USB port bracket pin-header connector

Smartcard Reader Connector J78

Function: Connector for a Smartcard reader module.

Description: A housing mounted Smartcard reader module plugs into to this connector.

More Information: See the “Connecting Internal Peripherals” and “Configuring the CMOS Setup Utility” sections in Chapter 5.

Smartcard Reader:

The connector cable from a Smartcard Reader module plugs into J78.

J78

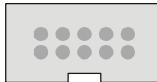

J78 Smartcard Reader connector

System Management Bus Connector SMB1

Function: SMBus connector.

Description: A System Management Bus (SMBus) lead connects to this connector.

More Information: See the “Connecting Internal Peripherals” section of Chapter 5.

SMBus:

This connector is for a System Management Bus connection.



SMB1 System Management Bus pin-header connector

SMB1

Front Panel Connectors

Function: Multifunction pin header connector for system housing front panel features.

Description: This connector supports the following front panel features:

- Reset Switch
- IDE device activity LED
- System ACPI Suspend switch
- System Power LED
- Keyboard lock
- Housing-mounted speaker

More Information: See Chapter 4 “Installing the Board In A System Housing” and Chapter 6, “System Features”.

Front Panel Connector:

Leads from the front panel features connect to this header.

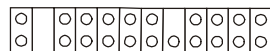

Front Panel feature connector

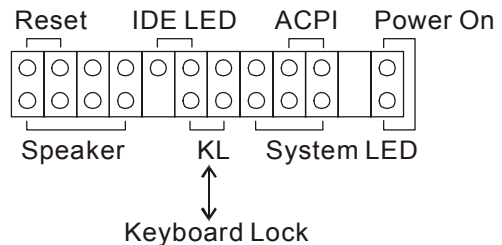

Battery Connector BT

Function: Housing for system support battery.

Description: An external lithium coin-cell battery powers the real-time clock and CMOS memory. When the computer is not plugged into a wall socket, the battery has an estimated life of three years. When the computer is plugged in, the standby current from the power supply extends the life of the battery.

More Information: See the Standard CMOS Features section of “Configuring the CMOS Setup Utility” in Chapter 5 to adjust the real-time clock settings.

Battery & Housing:

The battery is a CR2032 Lithium coin cell.

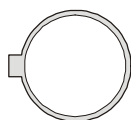

System support battery

External I/O Ports

There are several external Input/Output ports on the rear edge of the motherboard and connectors for more on the board. Please refer to the Rear I/O Panel Ports illustration for the port locations. The ports are color-coded for easy identification.

PS/2 Ports

Function: Connecting PS/2 devices to the system.

Description: The PS/2 ports are for a system keyboard and mouse or other pointing device. Do not connect or disconnect PS/2 devices when the system is turned on.

More Information: See the Advanced Boot Options section of “Configuring the CMOS Setup Utility” in Chapter 5 for information on adjusting related settings.

PS/2 Ports:

Do not plug or unplug devices when the system is turned on.



PS/2 Mouse

PS/2 Keyboard

USB Ports

Function: Connecting USB 1.1 devices to the system.

Description: These two ports are for USB 1.1 devices. The ports are for “Type A” USB cable connectors. You can connect or disconnect USB cables when the system is turned on.

More Information: See the Integrated Peripherals section of “Configuring the CMOS Setup Utility” in Chapter 5 for information on adjusting port settings.

USB Ports:

There are two USB ports on the rear panel. The J65 connector on the board is for a port bracket with two more USB ports. Ports 3/4 have a separate root hub.



USB ports 1/2 (no LAN option)

LAN Port (Optional by Model)

Function: Connecting a CAT 5 LAN cable to the system.

Description: This is an RJ-45 connector for standard Cat 5 LAN cabling with RJ-45 jacks. The connector is for the optional onboard LAN controller. You can connect or disconnect a LAN cable when the system is turned on.

More Information: See the System Features section of Chapter 6 for information LED modes.

LAN RJ-45 Jack:

Upper LED = Activity
Lower LED = Link



RJ-45 LAN jack
(on top of USB1/2 ports)

Parallel Port

Function: Connecting a device with a parallel interface to the system.

Description: The parallel port is generally used to connect a printer to the system. The port supports common parallel port modes and allows bidirectional communication. Use an IEEE 1284 compliant cable with the default ECP mode configuration.

More Information: See the Integrated Peripherals section of “Configuring the CMOS Setup Utility” in Chapter 5 for information on adjusting port settings.

Parallel port:

The default mode is ECP, configured as EPP 1.9, DMA 3. 1284 compliant.



Front Panel feature connector

Serial (COM) Ports

Function: Connecting Serial devices.

The two serial ports have 9-pin connectors. They can operate at speeds up to 115,200bps. You can configure the port speed in the computer's Operating System. Do not connect or disconnect a serial cable when the system is turned on.

More Information: See the Integrated Peripherals section of "Configuring the CMOS Setup Utility" in Chapter 5 for information on adjusting port settings.

Serial Ports:

The default configuration is Serial 1 = COM1 and Serial 2 = COM2. Installing an IR port requires disabling COM2.



Serials ports 1 & 2

Audio Jacks & Connectors

Function: Jacks for connecting external audio devices to the onboard audio subsystem.

Description: There are three audio jacks:

- Line Out
For the two stereo speakers.
- Line In
Audio input connector for an external audio source.
- Mic
Microphone connector for a computer microphone.

More Information: See the Integrated Peripherals section of "Configuring the CMOS Setup Utility" in Chapter 5 for information on audio settings.

External Audio Jacks:

The onboard audio supports stereo speakers, audio input and a microphone.

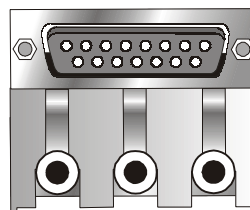

Game/MIDI
(Pink)

Line Out
(Lime)

Mic
(Pink)

Line In
(Light Blue)

Jumpers

There are five jumper switches on this motherboard. Jumpers function like switches to establish a hardware configuration setting.



JP1

JP1 Clear CMOS

Function: Clears the CMOS Setup Utility configuration record stored in the real-time clock's CMOS memory.

Description: A 3-pin jumper.

More Information: See Chapter 3 for configuration information and the Troubleshooting section in Chapter 6.



JP6

JP6 Keyboard Power On

Function: Enables or Disables the firmware keyboard Power on feature.

Description: A 3-pin jumper.

More Information: See Chapter 3 for configuration information and the Integrated Peripherals section of “Configuring the CMOS Setup Utility” in Chapter 5 for information on configuring the firmware features.



JP10

JP10 Audio Chip

Function: Enables or Disables the onboard audio chip.

Description: A 3-pin jumper.

More Information: See Chapter 3 for configuration information and “System Features” in Chapter 6.

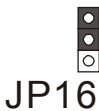

JP16

JP16 Flash Protect

Function: Sets protection method to prevent accidental overwriting of installed system BIOS.

Description: A 3-pin jumper.

More Information: See Chapter 3 for configuration information and the “Performance Optimization” section in Chapter 6.



JP17

JP17 LAN Chip

Function: Enables or Disables the onboard LAN feature.

Description: A 3-pin jumper.

More Information: See Chapter 3 for configuration information and “System Features” in Chapter 6.

Software Features

This motherboard comes with driver software and bundled utility software on the supplied Power Installer CD-ROM disc. The Installing OS & Support Software section in Chapter 5 explains how to install the software required to support this motherboard and profiles the bundled utilities.

Using the Power Installer Disc

You can run the Power Installer CD-ROM install interface under Microsoft Windows 9X, NT 4.0, 2000 or XP. The disc's install interface should load automatically and you then click on the model name of this motherboard.

Power Installer:
P4D/P4D-N section
Main installation screen

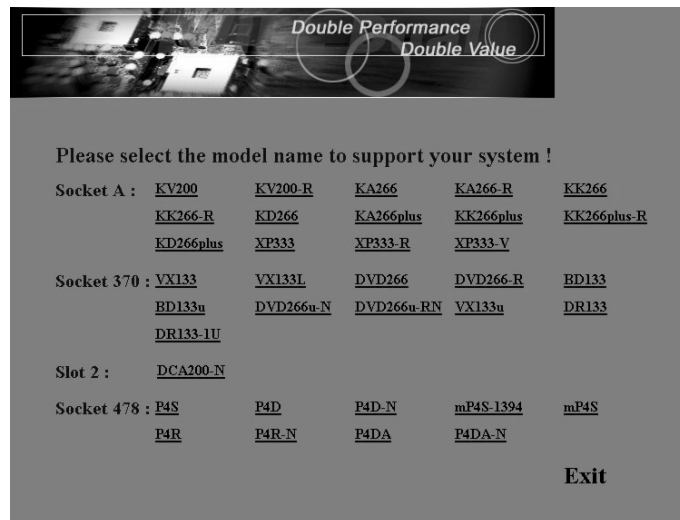

Driver Software

This motherboard requires that you install driver software to support the onboard hardware. You will need to install the following:

- Intel 845 chipset support software
Driver that supports the chipset and the Intel Application Accelerator that enhances system performance.
- LAN driver software
Driver software for the onboard LAN (P4D-N)
- Audio driver software
Audio driver and utilities for the onboard CMedia audio chip.

Please see “Installing OS & Support Software” in Chapter 5 for more information.

Power Installer:

P4D/P4D-N section

Driver installation screen

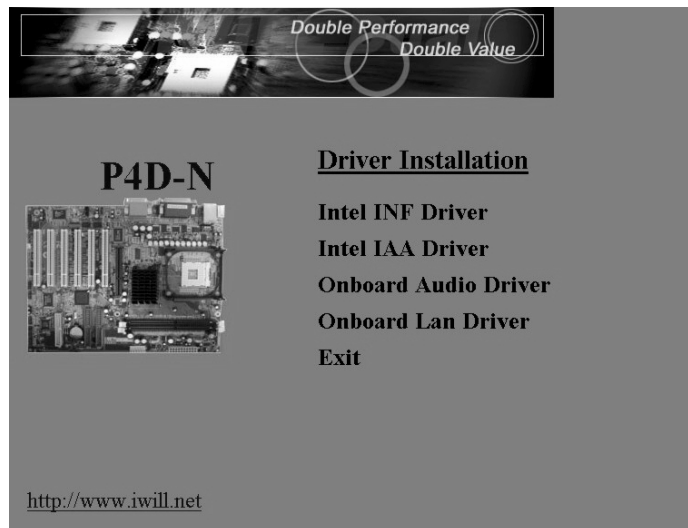

Utility Software

The Power Installer disc also has two utility programs on it, Adobe Acrobat Reader and McAfee Anti-Virus.

- Acrobat Reader

Acrobat Reader allows you to read documents in the Adobe PDF format, including online documents on the Power Installer 2 disc and a wide range of other content. The reader is free and can be upgraded at the Adobe web site – www.adobe.com – when new versions become available.

- McAfee Anti-Virus

This is anti-virus software from one of the leading vendors.

Power Installer :
P4D/P4D-N section
Utility installation screen

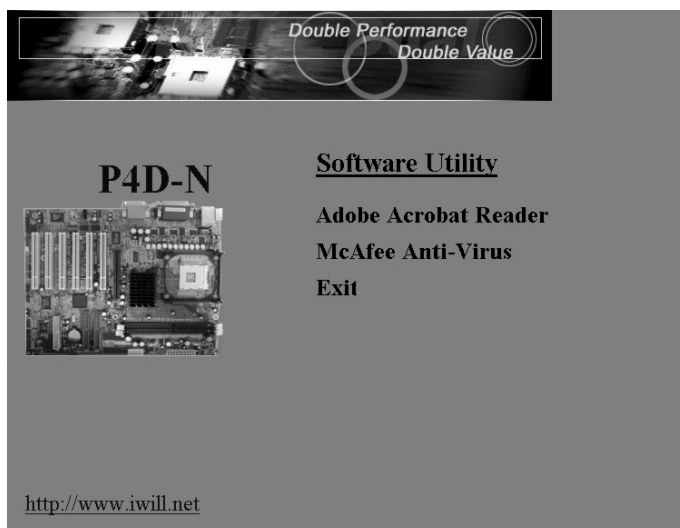

In This Chapter:

The Default Configuration

Hardware Configuration: Jumper Settings

Firmware Configuration: The BIOS CMOS Setup Utility

Reconfiguring the Motherboard

Hardware Reconfiguration

Firmware Reconfiguration

3: Motherboard Configuration

This chapter details the motherboard's default configuration and configuration options. Please review the contents of this chapter to find out information on the default configuration or alternative configuration options to change the default configuration.

The motherboard will operate properly in the default configuration. Please make certain that any configuration changes you make will not adversely affect system operation.

The Default Configuration

The default configuration is set at the time of manufacture. The configuration is comprised of the hardware configuration settings and the default firmware settings in the BIOS CMOS Setup Utility.

Hardware Configuration: Jumper Settings

This motherboard is mainly configured in firmware, which simplifies configuration. There are also a few hardware settings. The hardware settings are configured using standard jumper switches. The motherboard has five jumper switches. The first section is about the two BIOS-related jumpers and the second about the three hardware configuration jumpers.

BIOS-Related Jumpers

Jumper JP6: Clear CMOS Memory



JP6 is a jumper switch, but it does not set a hardware configuration setting. The BIOS CMOS Setup Utility creates a system configuration record that is stored in CMOS memory in the real-time clock chip. If the configuration record data becomes corrupted or is destroyed, or if the CMOS Setup Utility settings are changed to an unusable configuration, the motherboard may not run properly or at all. JP6 provides a means to delete the configuration data stored in CMOS memory and reset the configuration to the CMOS Setup Utility's Optimized Defaults.

Follow this procedure to clear CMOS memory. The jumper is beside the coin battery. If necessary, refer to the board diagram and key in Chapter 2 for the location of the JP6 jumper.

1. Turn off and unplug the system. Remove the system housing cover (see documentation if necessary).
2. Set JP6 to the Clear CMOS position by placing the jumper cap over pins 2 and 3 for one minute.
3. Return the jumper cap to the Normal position.
4. Replace the system housing cover, plug in the system and turn it on.
5. Run the CMOS Setup utility and load the Optimized Defaults. You can then enter any custom settings you require.
6. Save the settings as you exit the program and restart the computer.

The system should now operate normally.

JP6: Clear CMOS Memory

Setting	Function
Short 1-2 	Normal operation [Default]
Short 2-3 	Clear CMOS memory – see instructions

BIOS CMOS Setup Utility – Main Screen

The main screen of the CMOS Setup Utility has a Load Optimized Defaults item that loads the default operation settings. After you perform the Clear CMOS procedure, load the defaults as follows:

1. Select Load Optimized Defaults and press the Enter key.
2. A message will appear asking you to confirm.
3. Type a Y to confirm and press the Enter key again.
4. Make other settings you require.
5. Select Save & Exit Setup and press the Enter key.

The system will restart and use the new settings.

See the section on “Configuring the CMOS Setup Utility in Chapter 5 for information on how to use this program.

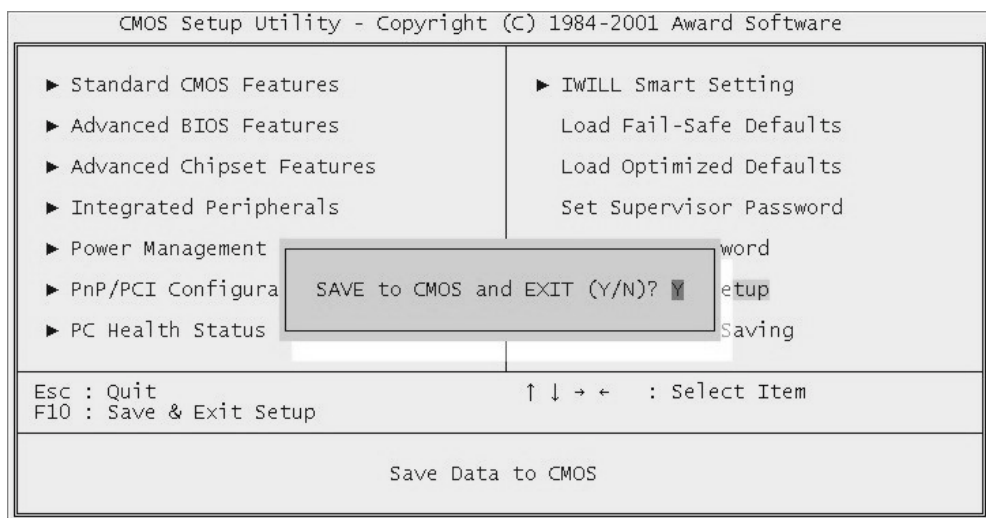
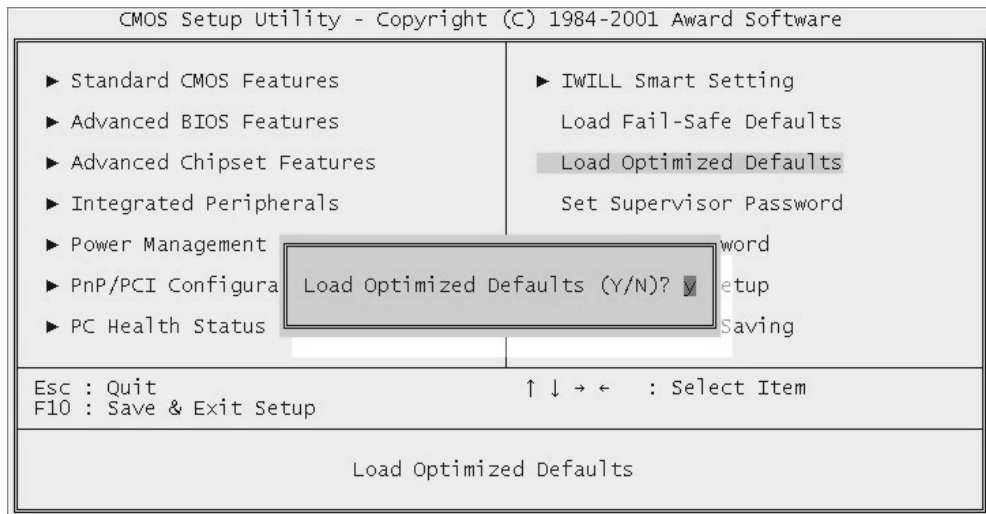



Jumper JP4: BIOS Flash Protect

The system BIOS and CMOS Setup Utility are stored in Flash memory on the motherboard, which provides permanent storage, but is rewritable, allowing for BIOS updates. Jumper JP4 controls the protection scheme that prevents accidental damage to or rewriting of the data stored in Flash memory.

JP4 has three setting options which allow the BIOS to be protected either by a firmware setting in the “IWILL Smart Setting” section of the CMOS Setup Utility or by the jumper’s hardware setting. The firmware setting option is more convenient, so it is the default setting for this jumper. The setting options are listed in the table below.

JP4: BIOS Flash Protect

Setting	Function
Short 1-2 	Protection mode selected in BIOS CMOS Setup Utility [Default]
Short 2-3 	Protection enabled in hardware
Open [Remove Cap]	No BIOS Flash Protection

BIOS CMOS Setup Utility – IWILL Smart Setting

The IWILL Smart Setting section of the CMOS Setup Utility has a BIOS Flash Protect item that controls BIOS flash protection. The default setting is “Non-Flash”. The optional setting is “Flashable”. See the section on “Configuring the CMOS Setup Utility in Chapter 5 for information on how to use this program.

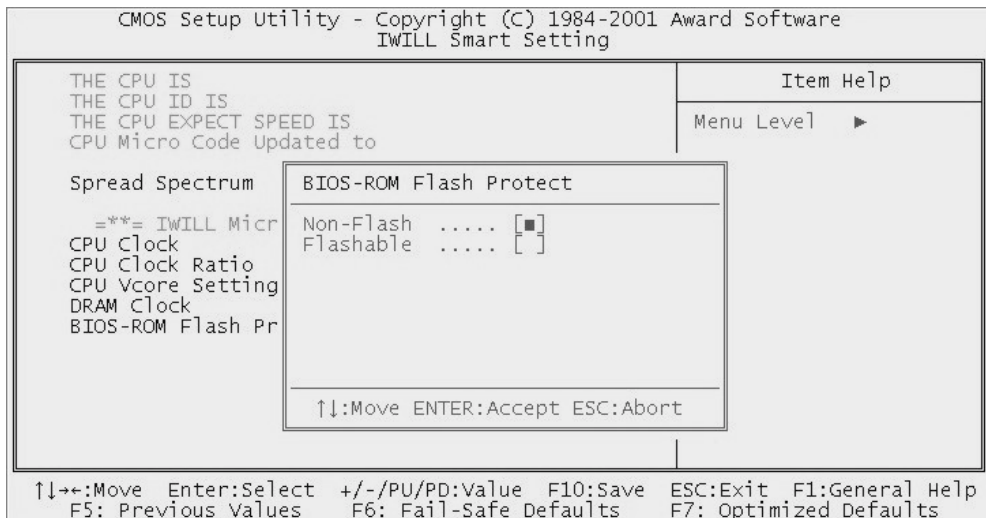
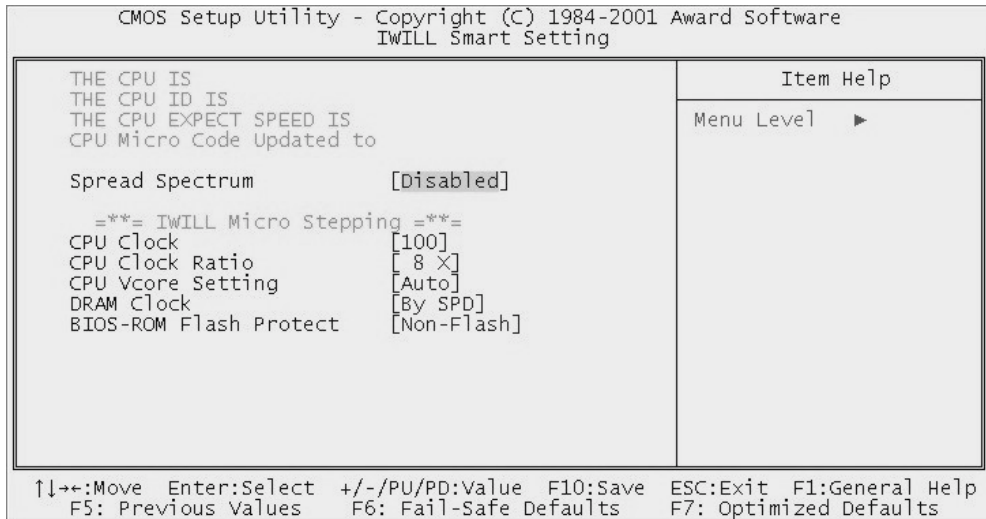



Hardware Configuration Jumpers

Jumper JP6: Keyboard Power On

This jumper controls the Keyboard Power On feature. If this is disabled, the firmware Keyboard Power On features controlled by the CMOS Setup Utility will not work. You must set this jumper to the Enabled setting to use this feature.



JP6: Keyboard Power On

Setting	Function
Short 1-2 	Disabled [Default]
Short 2-3 	Enabled

Jumper JP10: Audio Chip

This jumper controls the onboard CMedia audio chip. If this is disabled, the onboard audio will not work and its system resources are released for other use.



JP10: Audio Chip

Setting	Function
Short 1-2 	Enabled [Default]
Short 2-3 	Disabled

Jumper JP17: LAN Chip

This jumper controls the onboard LAN feature on the P4D-N. If this is disabled, the onboard LAN will not work and its system resources are released for other use.

JP17: LAN Chip

Setting	Function
Short 1-2 	Enabled [Default]
Short 2-3 	Disabled

Firmware Configuration: The CMOS Setup Utility

The BIOS CMOS Setup Utility a configuration record of system settings. This record is based on the “Optimized Defaults that are stored with the utility in Flash memory and can be reloaded at any time.

Many of these settings are either recommended or required for the motherboard to operate properly. Other settings are customizable and can be changed to suit your specific system configuration and operation requirements.

A number of the variable settings, such as CPU and IDE device settings are set to be automatically detected in the default configuration. While these settings can also be established manually, automatic detection is more convenient, safe and reliable. We strongly recommend that you leave all auto-detection settings undisturbed unless you have a specific reason not to and you are certain of what you are doing. Incorrect configuration of the CMOS Setup Utility can result in unreliable operation or a failure of the motherboard to work at all.

Using the CMOS Setup Utility

Please refer to the “Configuring the CMOS Setup Utility” section in Chapter 5 for information on using the utility and some settings you might want to customize. The utility does not run under an Operating System. You must load it during the Power On Self Test (POST) while the computer is starting up by press the Delete key or the Del key on the system keyboard’s numeric keypad.

BIOS CMOS Setup Utility – Main Screen

Load the CMOS Setup Utility during the POST by pressing the Delete or Del key. The utility interface commands are explained at the bottom of each screen and “General Help” is available by pressing the F1 key. See the section on “Configuring the CMOS Setup Utility in Chapter 5 for information on how to use this program.

The main screen has a basic list command instructions at the bottom of the screen and displays a function description of the highlighted item.

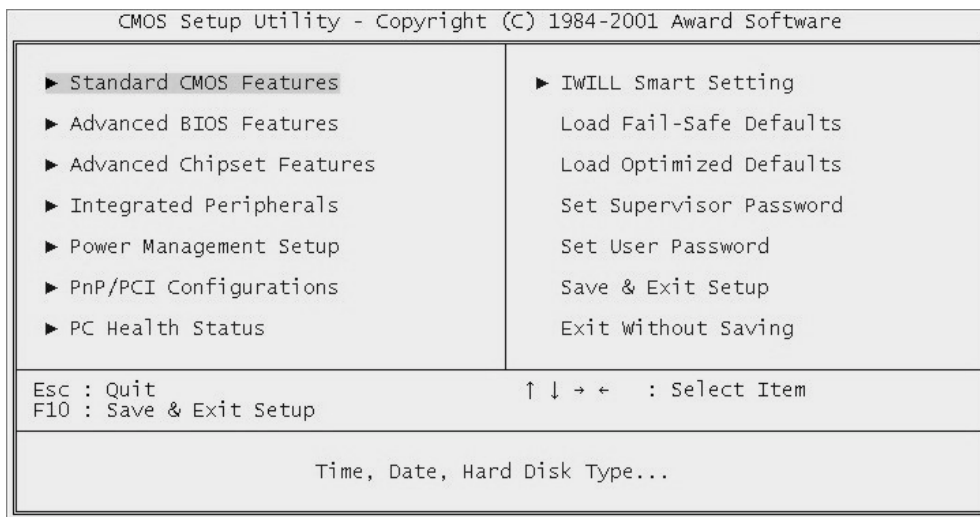

Sections marked by an arrow on the main screen list command instructions at the bottom of the screen.

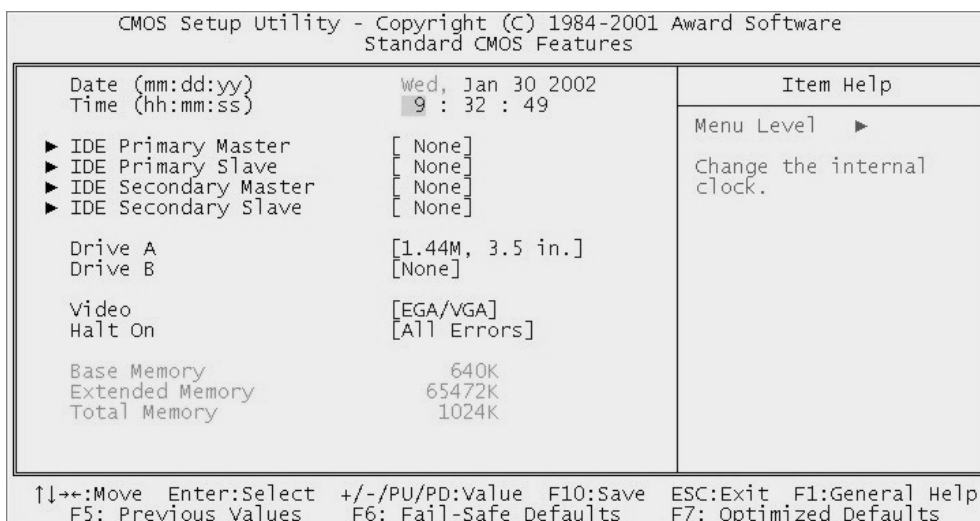

Reconfiguring the Motherboard

You can change the default configuration (as shipped) of this motherboard as needed. However, since this motherboard has only a few hard configuration options and the CMOS Setup Utility is configuration is mostly either required, recommended or automatic, there will probably be little reason to do so.

Hardware Reconfiguration

We recommend leaving the jumper settings at the default settings unless you need to perform the Clear CMOS procedure. It is much more convenient to control the BIOS Flash Protection feature using the CMOS Setup Utility.

If you want to use a sound card instead of the onboard audio, you should Disable the onboard audio.

You can also Disable the onboard LAN on the P4D-N if the need arises, though you don't need to do this to add another LAN card to the system.

Firmware Reconfiguration

You can initially specify or customize the CMOS Setup Utility settings when you first configure the system (as covered in Chapter 5) to meet your requirements. Other than doing this, there should be no need to reconfigure the CMOS Setup Utility unless the system configuration changes or the configuration record stored in CMOS memory becomes corrupted and unusable, which is not common. If you need to completely recreate the system configuration record, follow the Clear CMOS procedure described in this chapter.

In This Chapter:

Pre-Installation Preparation

Installing CPUs

Installing System Memory

Installing the Motherboard in a System Housing

Motherboard Installation Procedure

Completing System Configuration

4: Installing the Motherboard

This chapter covers preparing the motherboard for installation, installing the board in a system housing or “chassis” and installing or connecting other internal system components.

There are a number of important topics in this chapter and we strongly urge that you review it before attempting to install the motherboard.

Pre-installation Preparation

Before you install the motherboard you will need to do the following:

- Install a 478-pin Intel Pentium 4 CPU
- Install DDR DIMM system memory modules

Both of these require specific procedures that you must follow precisely to insure that the components are successfully installed and work properly. Please review the instructions in this section in detail and follow them carefully. The procedures are not complex.

Installing A CPU

This motherboard uses the 478-pin Intel Pentium 4 processor. To install an Intel Pentium 4 CPU on the motherboard it is very important to precisely and entirely follow the procedure for installing both the CPU and its cooling assembly. Failure to do so can result in either improper operation or damage to the CPU and possibly the motherboard.

To install an Intel Pentium 4 processor on this motherboard you will need to do the following:

- Install a Pentium 4 processor in the mPGA478 socket
- Install the Heatsink/Retention Mechanism

Please follow the procedure detailed below to install the Pentium 4 processor on the board. Intel boxed Pentium 4 processors come with full installation instructions. If you have these, please also read and follow those instructions carefully.

Processor Selection

This motherboard supports all 478-pin Pentium 4 processors and the BIOS automatically detects the required settings and configures the CMOS Setup Utility accordingly.

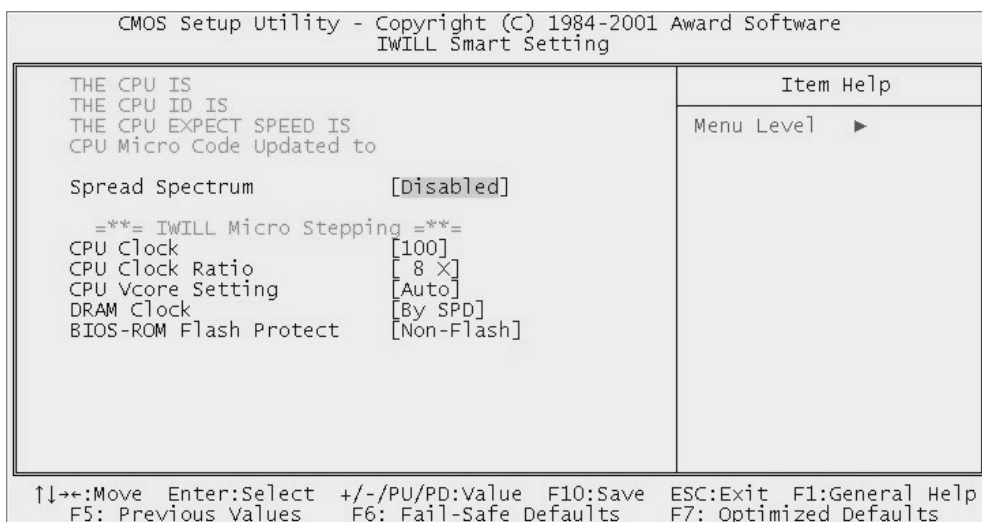

Installing The Processor

Installing a Pentium 4 processor in the mPGA478 Socket is the simplest part of the procedure. It is very important, however, to carefully handle the processor by the side edges and always fully observe precautions against electrostatic discharge. We assume here that you are installing an Intel Pentium 4 boxed processor that comes with a heatsink and Thermal Interface Material applicator. The illustrations show these. If you are installing a non-boxed processor, the procedure is the same, but the accessory items may have a different appearance.

Please follow the installation procedure as illustrated on the next two pages. The illustrations are generic and do not specifically represent this motherboard.

The processor installation procedure is as follows:

1. Raise the locking lever of the processor locking mechanism to a perpendicular position.

Step 1:

Raise the retaining lever

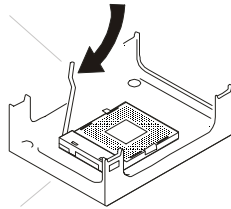

Raise the socket lever to the vertical position

2. Align the processor to the socket by matching the Pin 1 corner of the socket to the Pin 1 corner on the socket, which is located at the corner where the locking arm attaches to the socket.

Step 2:

Align the Pin 1 corners

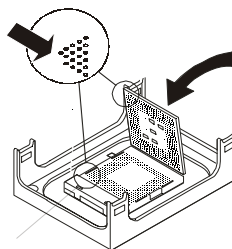

Match the Pin 1 positions on the socket and the processor

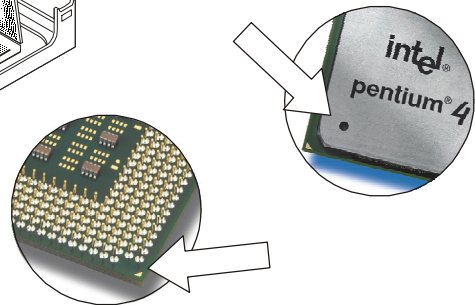

- Carefully insert the Pentium 4 processor in the socket receptacles, taking care not to bend any pins.

Step 3:
Insert the processor

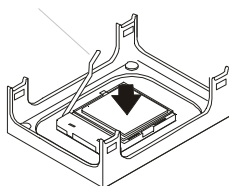

Gently press the processor into the socket.

- Lower the locking mechanism's retaining lever and secure it in place to secure the processor in the socket. Grasp the processor by the edges and gently pull upwards to insure it is properly inserted. The processor shouldn't move.

Step 4:
Secure the retaining lever

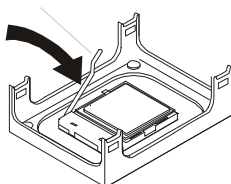

Press the retaining lever back down into the horizontal position and make sure it latches in place.

Installing the Heatsink

Once you have installed the CPU, you must install a Fan/Heatsink. The Fan/Heatsink clips into to the Retention Mechanism attached to the board via its integrated retaining clip assembly.

Apply Thermal Interface Material

Before you install the Fan/Heatsink you must apply the Thermal Interface Material (TIM) that is supplied in an applicator with boxed Intel Pentium 4 processors (or an exact equivalent) to the top of the installed CPU. If the Fan/Heatsink already has a patch of TIM on its underside, you don't need to apply any additional TIM to the CPU. We assume here that you have TIM in an Intel-supplied applicator. To apply TIM to the CPU do as follows:

1. Apply all of the TIM in the applicator to the center of the CPU's top plate.



Step 1:

Apply TIM if needed.

2. Do not spread the TIM around. When you place the Heatsink on top of the CPU the material will disperse evenly.

Align and place on top of the CPU

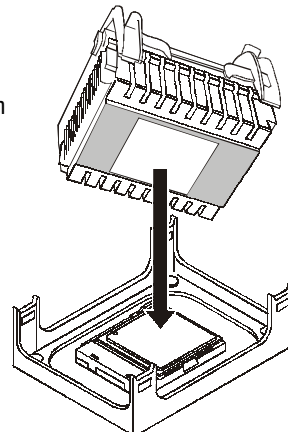

Next, install the processor Fan/Heatsink assembly as detailed below.

Install the Fan/Heatsink

To install the processor Fan/Heatsink assembly do as follows:

1. Place the Fan/Heatsink on top of the Pentium 4 CPU so that it's retaining clip frame snaps into the recesses in the Retaining Mechanism. The Fan/Heatsink will only fit into the mechanism frame in the correct orientation.

Step 1:

Clip Fan/Heatsink assembly into the Retention Mechanism

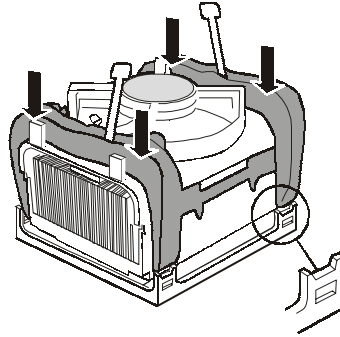

2. Hold the Fan/Heatsink steady and press one of the clip assembly's locking levers down into the locked position.

Step 2:

Hold the assembly steady and press one of the retaining clip locking arms into the locked position

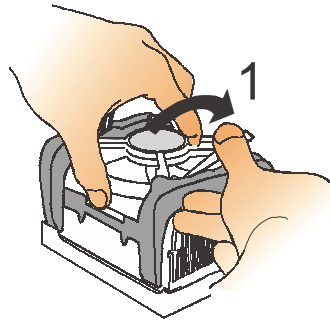

3. Repeat the process for the second clip. Keep holding the Fan/Heatsink steady so that you don't damage the TIM. The locking levers should now hold the heatsink securely in the Retention Mechanism.

Step 3:

Hold the assembly steady and press the other retaining clip's locking arm into the locked position

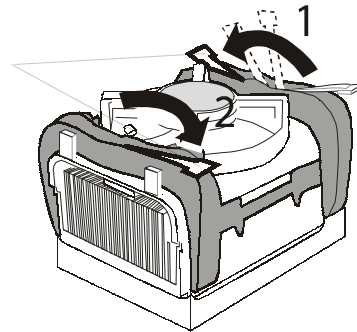
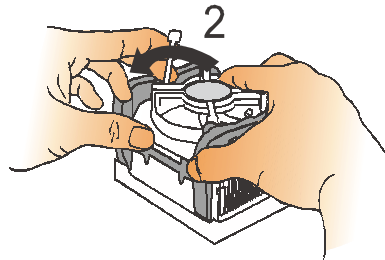
**Connect Fan/Heatsink Power Lead**

Plug the fan power lead onto the CPU Fan power connector near the CPU socket. The entire CPU installation is then complete.

Step 4:

Plug the Fan power lead onto the CPU fan power connector

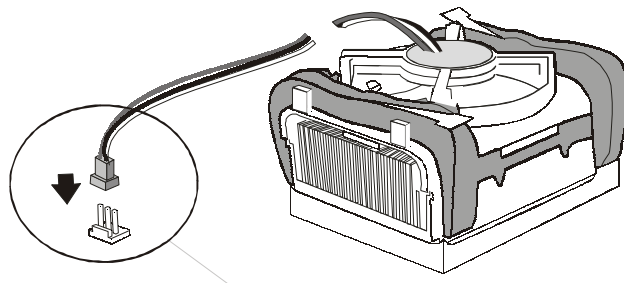

Installing System Memory

This section details the procedure for installing system memory on the motherboard. Correct memory configuration is critical for proper system operation. Please review this section carefully and follow the configuration guidelines precisely.

Memory Specifications

The motherboard has two DIMM module sockets. This motherboard uses DDR SDRAM DIMM modules for system memory. The system memory specification are:

- DDR SDRAM DIMM modules
- 200MHz PC1600 or 266MHz PC2100 DDR SDRAM
- Maximum 2GB total system memory

Memory Configuration Options

This motherboard has flexible memory configuration options. These include:

- Supports 16MB, 64MB, 128MB, 256MB & 512MB modules
- Any capacity DIMM may be used in either socket as long as total memory does not exceed 2GB.
- Modules should be the same speed for best system performance.

Module Types

There are two DDR memory types:

- DDR
- ECC DDR

DDR is standard DDR SDRAM memory. ECC DDR is Error Correcting Code DDR which provides additional data security.

Installing Memory Modules

Installing DIMM modules is simple. The modules insert in the sockets and are held in place by the socket retaining arms. The edge connectors on the modules are of different widths and there are key notches in each module. These ensure that you can not insert a module incorrectly.

Before you install any modules, you should choose a configuration. You should then prepare the required number and type of DDR modules.

To install either type of module follow this procedure:

1. Align the module to the socket so that the edge connectors on the module match the socket sections.
2. Hold the module perpendicular to the motherboard and press the edge connector into the socket.
3. Press the module fully into the socket so that the socket retaining arms swing up and engage the retention notches at each end of the module.

Following the configuration you have chosen, repeat this procedure if necessary so that all modules are installed. Once the modules are installed, system memory installation is complete.

Module Installation:

All modules insert in the DIMM sockets in the same way. The socket retaining arms should rotate up and engage the module's retaining notches as you press it into the socket. They must engage for the module to be properly installed.

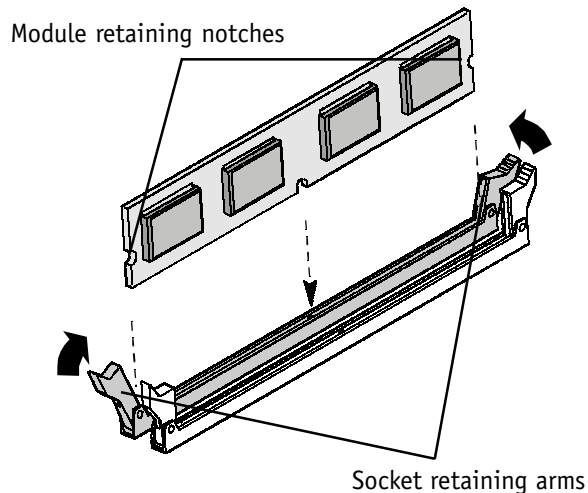

System Memory Recognition

The BIOS will automatically recognize the installed memory and configure the CMOS Setup Utility. No other action is required to complete system memory installation.

Installing the Motherboard in a System Housing

This section explains the basic requirements for installing this motherboard in a system housing or “chassis”. Since housing designs vary widely, you will need to consult the housing documentation for specific information. This motherboard can be installed in any housing that supports the ATX form factor.

To install the motherboard in a system housing you will need to do the following:

- Install a rear I/O panel shield
- Attach the board to the housing
- Connect leads from the housing’s front panel

You can then connect other internal system components as described later in this chapter.

Motherboard Installation Procedure

This section assumes you are installing the board in a suitable ATX housing. We also assume you have prepared the board for installation as previously described in this manual. If the housing you are using normally stands vertically, place the open housing on it’s side before you start.

Please follow this procedure to install this motherboard:

1. Review any instructions that came with the system housing and prepare the necessary mounting hardware that came with it.
2. Identify the mounting holes on the board and confirm that the housing has standoffs that match them.
3. Install the rear I/O panel shield that came with the housing in the housing’s I/O panel opening. This should match the ports on the board.
4. Insert the board in the housing and align the mounting holes to the standoffs on the housing’s motherboard mounting plate. Make sure all of the rear I/O ports are properly aligned with the openings in the I/O panel shield.

Required Tool:

- Philips-head screw driver (Crosshead)

- Attach the board to the housing by inserting mounting screws in all the holes and tightening them snugly.

Mounting Holes

All modules insert in the There are 9 mounting holes on the motherboard that should correspond to mounting standoffs on the system housing's motherboard mounting plate.

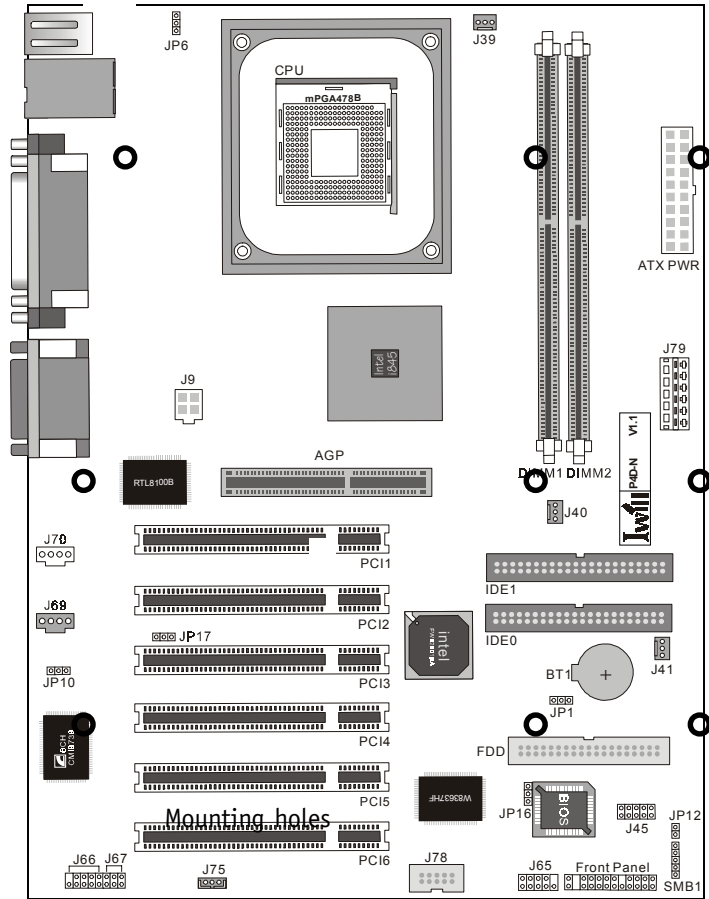

Connecting Front Panel Components

After the motherboard is installed in the system housing, you should connect whatever front panel components the housing has to the Front Panel feature connector on the motherboard.

The figure below indicates the pin assignments of the connector for your reference.

Front Panel Connector:

Leads from the front panel features connect to this header.

Front Panel feature connector

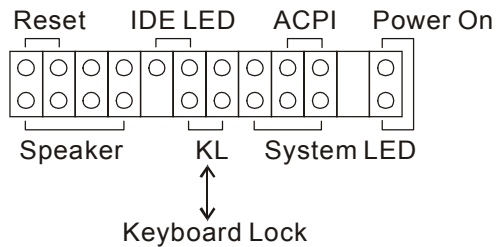

Completing System Configuration

Once the motherboard is installed in the system housing, you can proceed to connect or install whatever internal devices you will use to complete the system. These will at least include an AGP display card and disk drives and connecting the housing power supply leads.

After that, having replaced the system housing cover, you can connect external peripherals to complete the process of preparing the system for use. These will include at least a video display and a keyboard and probably a pointing device. Please see the next chapter for information on completing these final hardware installation steps and installing Operating System and support software.

In This Chapter:

Installing or Connecting Internal Peripherals

Installing an AGP Card

Connecting Internal Devices

Connecting External System Peripherals

Configuring the CMOS Setup Utility

Installing an OS & Support Software

5: System Configuration

This chapter explains what you need to do to assemble a complete system after you have installed the motherboard in a system housing. This will include installing or connecting internal devices, connecting external system components. Once the system is assembled, you'll need to check and possibly configure the motherboard's CMOS Setup Utility, install an Operating System and install the support software supplied on the Power Installer support CD-ROM disc.

Installing or Connecting Internal Peripherals

To complete the assembly of a working system you will need to at least install an AGP video display card and connect whatever disk drives you will use in the system. This section covers what you need to know on the motherboard side to do this. You will also need to consult the documentation that comes with your internal system peripherals for additional installation instructions and information. This section covers the minimum components you will need to connect to the motherboard to create a functioning system. You may plan to add other devices as well.

Installing an AGP Card

The AGP connector on the board supports AGP 4X 1.5-volt display cards. Follow the instructions that come with the display card for installing the card hardware in the AGP slot.

AGP Configuration

You can configure the amount of system memory the AGP card will use as auxiliary memory by adjusting the AGP Aperture Size setting in the Advanced Chipset Features section of the CMOS Setup Utility. The default aperture setting is 64MB the maximum is 256MB.

Display Drivers

You should install the display card's display driver software according to the instructions that come with the card after you have completed system assembly and have installed an OS and the support software for this motherboard.

AGP Aperture Setting

You can set the AGP aperture size in the Advanced Chipset Features section of the CMOS Setup Utility

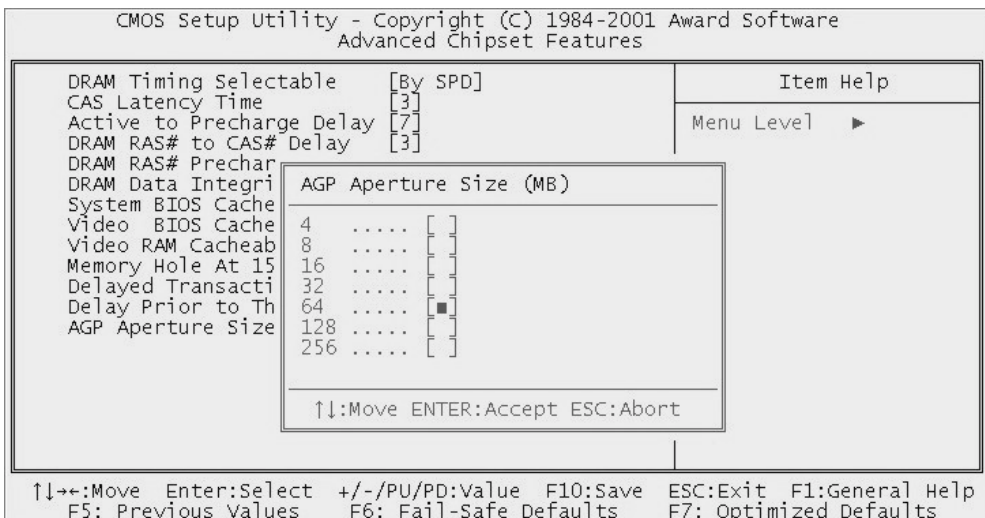

Connecting Internal Devices

To assemble a complete system capable of completing the installation of this motherboard you will need to install and connect the following internal devices:

- Hard Disk Drive
- CD-ROM or other optical drive
- Floppy disk drive

The floppy disk drive is not strictly necessary, but is a standard system component and is needed if you will create driver floppy disks from the Power Installer 2.

We assume here, in the absence of an alternative drive controller that any hard disk or optical drives will be IDE devices connected to the motherboard's IDE channels.

Connecting IDE Devices

This motherboard supports two IDE channels, Primary and Secondary. It has two IDE device connectors onboard which support IDE devices running in any data transfer mode up to ATA-100. Each IDE connector supports two drives, a Master and a Slave. The drives connect to the motherboard with an IDE ribbon cable. IDE cables have three connectors on them, one that plugs into a drive connector on the board and the other two that connect to IDE devices. The connector at the end of the cable is for the Master drive. The connector in the middle of the cable is for the Slave drive.

There are three types of IDE ribbon cable, supporting transfer modes up through ATA-33, ATA-66 or ATA-100. You must use a cable that supports the transfer mode of the fastest device connected to it. For example, if both an ATA-66 mode and an ATA-100 mode device are connected to the same cable, the cable must support ATA-100 mode to achieve maximum performance.

To install an IDE drive, connect the drive to one of the drive connectors on a suitable ribbon cable. Plug the board end of the cable into one of the IDE connectors on the motherboard.

IDE Drive Positioning

Normally the system's primary hard disk drive should be in the Primary Master position. If you will use only the supplied ribbon cable, connect a CD-ROM drive to the Primary Slave position.

If you obtain an additional IDE ribbon cable, you can install a second hard disk drive in the Primary Slave position and install the CD-ROM as the Secondary Master. This is a good idea if the CD-ROM drive uses a slower data transfer mode than the hard disk drive.

Follow any instructions that come with the drives to configure and install them. IDE devices generally can be set to one of three operation modes:

- Master
- Slave
- Cable Select

Many drives come set to the Master setting. If you will use the drive in a Slave position, you must reconfigure it as either Slave or use the Cable Select setting to allow the drives position on the cable to define the mode.

Connecting a Floppy Disk Drive

This motherboard has one Floppy Drive connector for connecting one or two floppy disk drives. Most computer systems use one 3.5-inch 1.44MB floppy disk drive. The drive connector is for a standard floppy drive ribbon cable.

To install a floppy disk drive, connect the drive to the end of the cable, which is the Drive A: position. Plug the other end of the cable into the floppy disk drive connector on the motherboard.

Onboard IDE Connectors

Each channel connector supports one IDE channel with two drives, a Master and a Slave. The Master drive connects to the connector on the end of the ribbon cable. The Slave drive connects to the connector in the middle of the ribbon cable.

Note:

The ribbon cable used must support the transfer mode of the fastest device connected to it to avoid degraded performance.

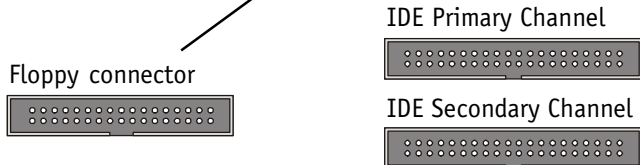
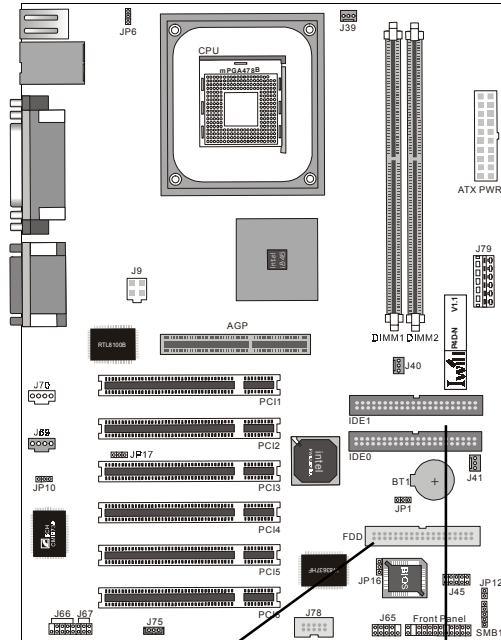

Floppy Drive Connector

The floppy drive connector supports two floppy disk drives. The first drive, Drive A:, connects to the connector on the end of the floppy drive connector cable. A second drive, Drive B:, would connect to the middle connector on the cable although systems now commonly only have one floppy disk drive.

Connecting External System Peripherals

To complete the assembly of functioning system you will need at minimum to connect the following external system components to the system housing:

- Video Display Monitor
- Keyboard
- Mouse or other Pointing Device

Connecting a Display Monitor

You can connect any display monitor supported by the AGP display card you installed in the system. This may include either a CRT or LCD monitor, depending on the card's specifications.

Connect the display monitor cable to the appropriate display connector on the AGP card according to the instructions that come with the card and monitor.

Connecting a Keyboard & Mouse

You can use either PS/2 or USB input devices with this motherboard.

Connecting PS/2 Devices

Connect a PS/2 keyboard and mouse to the Keyboard and Mouse PS/2 ports on the rear I/O port panel. Don't connect or disconnect a device while the system is turned on. Doing so can damage the board.

Connecting USB Devices

You can use a USB keyboard and mouse with this motherboard. They plug into two of the USB ports. The Operating System you use must support USB to use any USB devices. You can plug and unplug USB devices when the system is turned on.

CMOS Setup Utility – Integrated Peripherals

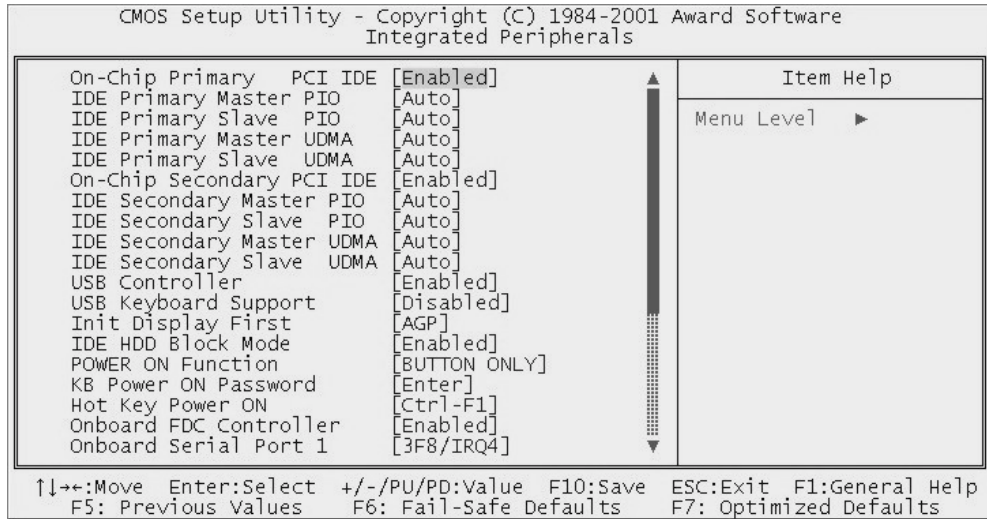

Enable “USB Keyboard Support” if you will use a USB keyboard.

Configuring the CMOS Setup Utility

The motherboard Award BIOS includes the CMOS Setup Utility that creates a system configuration record that is stored in CMOS memory on the board and is required by the system to operate properly.

Most of the configuration settings are either predefined by the BIOS Optimized Default settings which are stored with the BIOS or are automatically detected and configured without requiring User action. There are a few settings that you may need to change depending on your system configuration.

This section gives a brief profiles of the several sections of the CMOS Setup Utility and indicates settings you might need to change and those which you should not.

The CMOS Setup Utility User Interface

The CMOS Setup Utility user interface is simple and largely self evident. The utility can only be operated from the keyboard and all commands are keyboard commands. The utility does not support mouse use. The commands are straightforward and those available for the program section you are in are listed at the bottom of the screen. The main screen has few commands, other sections have more. General Help, which lists the commands and their functions is available at any time by pressing the F1 key.

Running the CMOS Setup Utility

The CMOS Setup Utility does not require an operating system to run. You run the utility by typing the Del or Delete key when the computer is starting to boot up. The utility's main screen will then appear.

CMOS Setup Utility – Interface commands

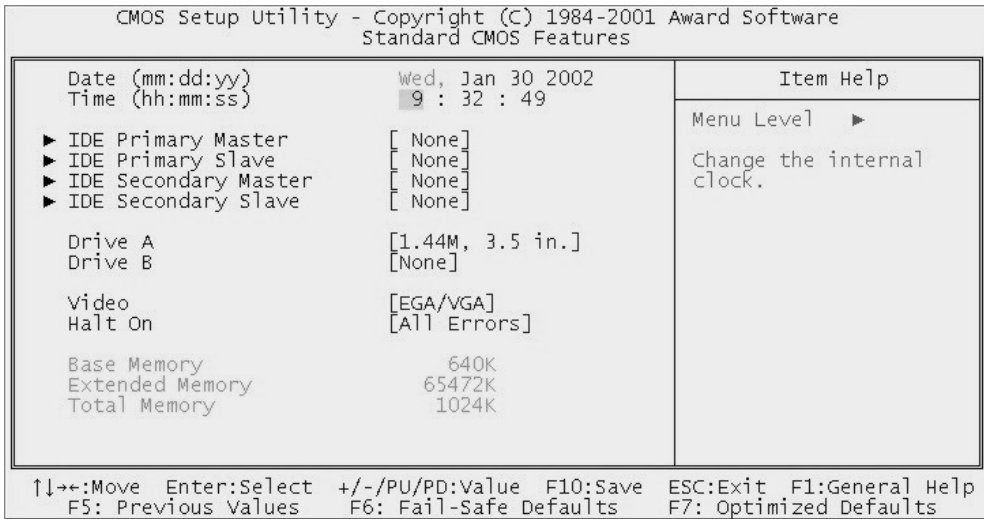
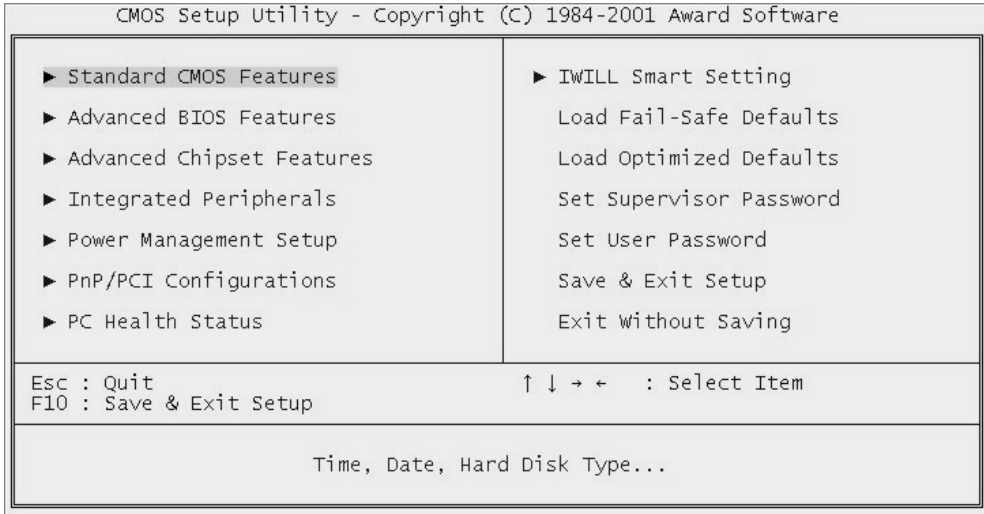

CMOS Setup Utility Program Sections

The CMOS Setup Utility is divided into several subsections and some top level commands including the following sections:

- Standard CMOS Features
- Advanced BIOS Features
- Advanced Chipset features
- Integrated Peripherals
- Power Management Setup
- PnP/PCI Configurations
- PC Health Status
- IWILL Smart Setting

The main screen also has these command options:

- Load Fail-Safe Defaults
- Load Optimized Defaults
- Set Supervisor Password
- Set User Password
- Save & Exit Setup
- Exit Without Saving

Please see the following sections for a brief profile of what each section does, information on settings you might want to change and things to leave alone.

To open one of the program sections, highlight the item you want and press the Enter key. To change a setting, highlight an item and use the “Value” keys indicated to change the setting. Alternatively, press the Enter key and all options for that item will display and you can choose from those listed.

CMOS Setup Utility – Main Screen

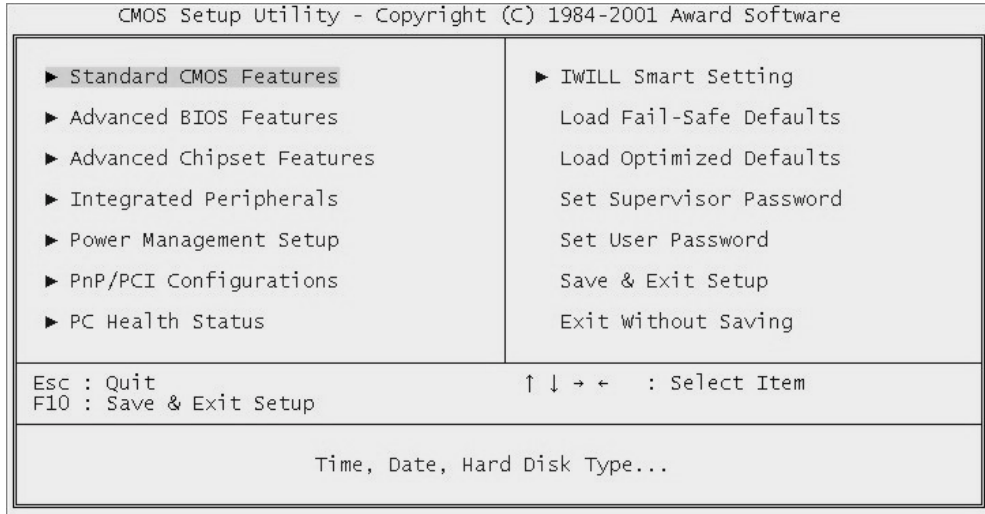

Standard CMOS Features

Main Section Functions

This section has the real time clock settings, the IDE and floppy device settings.

Default & Autodetected Settings

The IDE device settings are autodetected. You shouldn't need to change this. The floppy and other settings are standard defaults.

Setting Options & Constraints

You can reset the time and date settings if they are not correct for your location.

CMOS Setup Utility – Standard CMOS Features

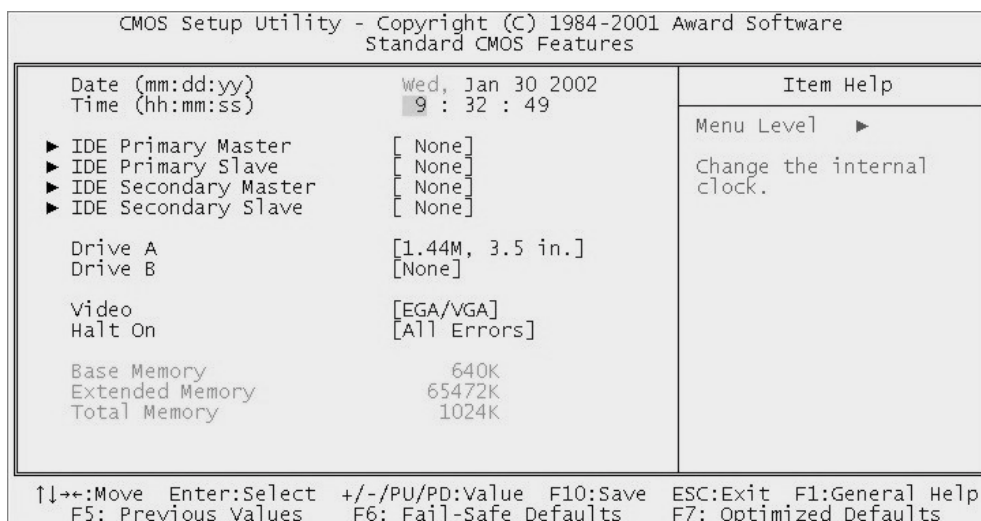

In operation, the screen will display the detected IDE devices

Advanced Boot Options

Main Section Functions

This section mainly configures boot options including boot devices and their boot order and some power functions. There are also some miscellaneous boot configuration settings.

Default & Autodetected Settings

The screen illustration shows the default settings. These do not need to be changed. You can customize the settings to suit your purposes if necessary and you know what you're doing.

Setting Options & Constraints

You can change the boot device assignments and order, the boot options and the power on settings as you like. You can enter a Keyboard Power On password.

CMOS Setup Utility – Advanced Boot Options

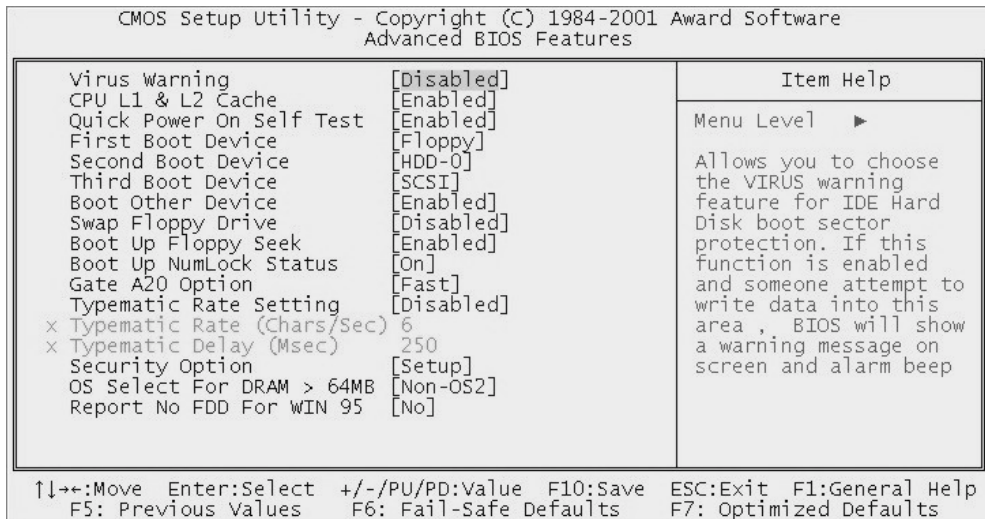

Advanced Chipset Features

Main Section Functions

Configures the chipset, BIOS caching and the AGP Aperture size.

Default & Autodetected Settings

Everything on this screen is an optimized default or is autodetected.

Setting Options & Constraints

Don't change anything in this section except the AGP Aperture, which you can adjust if needed, and the Memory Hole setting if you need to for OS/2. The default AGP setting will work.

CMOS Setup Utility – Advanced Chipset Features

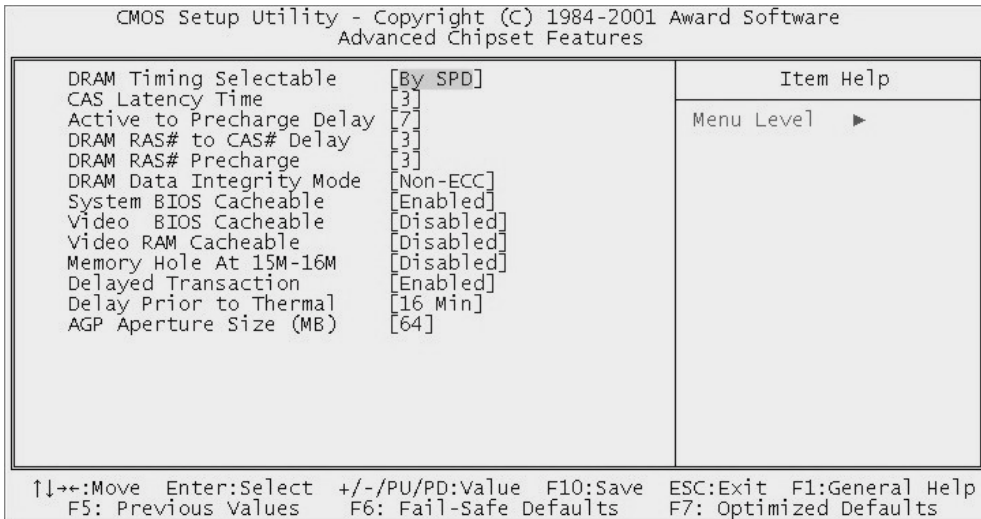

Integrated Peripherals

Main Section Functions

Configures the peripheral features integrated onto the motherboard.

Default & Autodetected Settings

Everything on this screen is an optimized default. The IDE transfer mode settings are autodetected. The system will work with these defaults. The port settings are standard PC settings.

Setting Options & Constraints

You can disable onboard devices and change port settings. If you install an IR port module, you have to set the "COM2 Mode Select" line to the appropriate IR setting. The last two lines configure a Smartcard reader.

CMOS Setup Utility – Integrated Peripherals

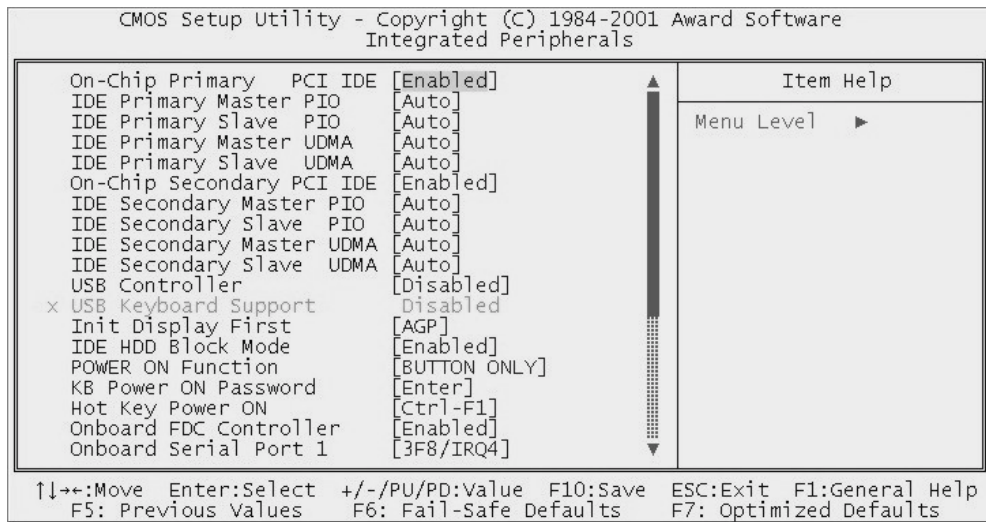

Power Management Setup

Main Section Functions

Configures power management settings. These are overridden by ACPI power management in Windows.

Default & Autodetected Settings

Everything on this screen is an optimized default.

Setting Options & Constraints

You can select the Minimum or Maximum configurations rather than the User Defined defaults. You can customize all settings in User Defined mode. If your OS supports power management, configure it there. You can also set a date and time for the system to turn on or wake up.

CMOS Setup Utility – Power Management Setup

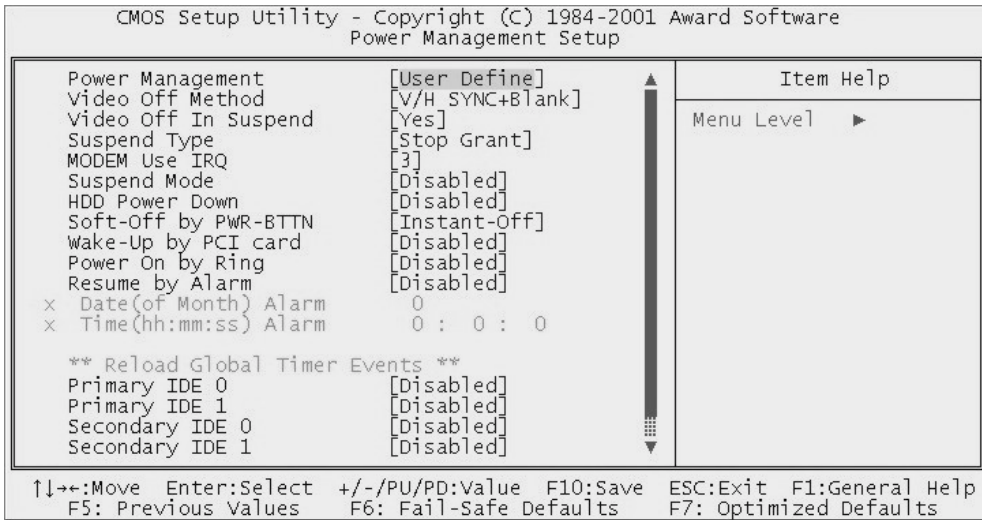

PnP/PCI Configurations

Section Function

Configures Plug and Play and other PCI bus settings.

Default & Autodetected Settings

The default is for the BIOS to control these functions.

Setting Options & Constraints

Don't change the resource settings, they're set to be handled automatically by the BIOS. If you have a problem after you install an expansion card, set "Reset Configuration Data" to Enabled to rewrite the ESCD.

CMOS Setup Utility – PnP/PCI Configurations

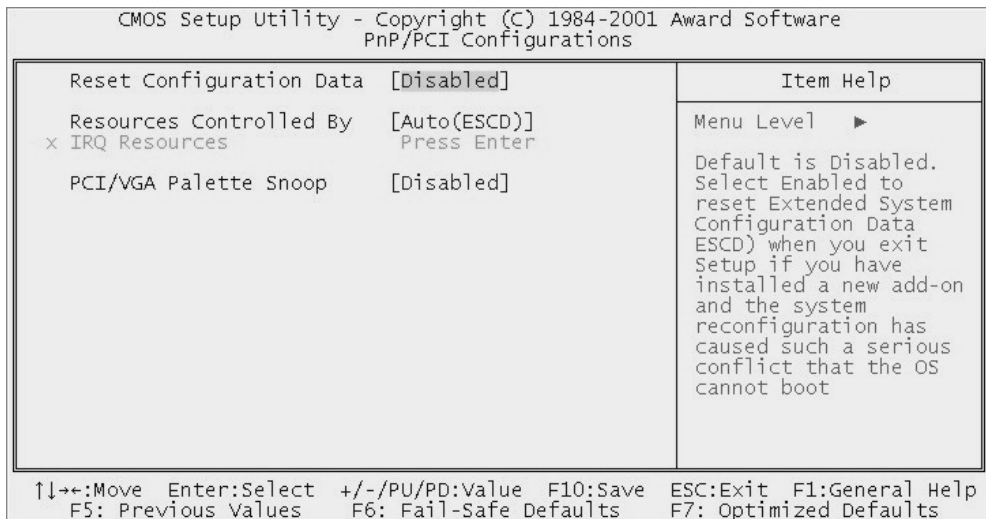

PC Health Status

Section Function

Configures the Shutdown Temperature and displays detected system information.

Default & Autodetected Settings

The Shutdown Temperature settings is an optimized default. The list of system information is autodetected and displayed.

Setting Options & Constraints

You can select a the Shutdown Temperature setting. If the detected CPU temperature reaches that point, the system will automatically shut down to protect the CPU.

CMOS Setup Utility – PC Health Status

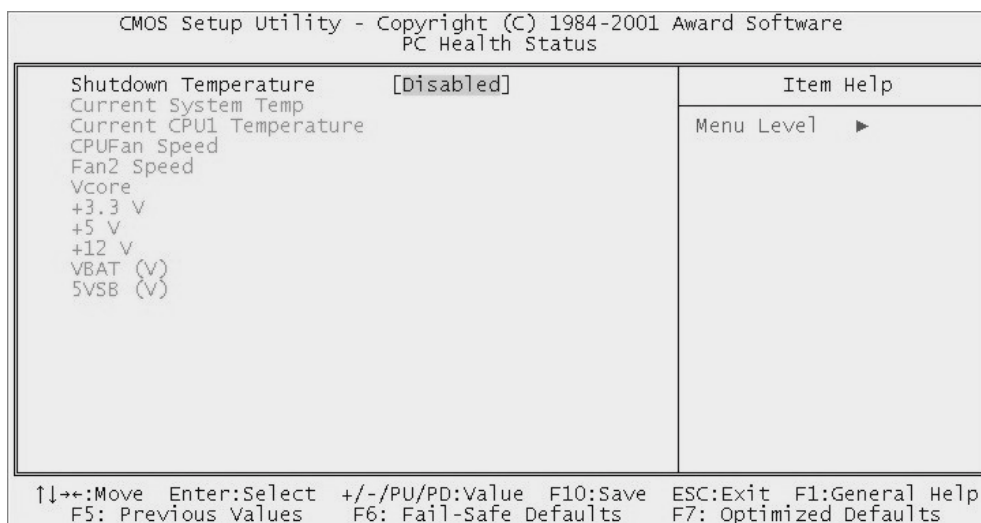

CPU Smart Setting

Section Function

Configures CPU settings.

Default & Autodetected Settings

The default setting is to autodetect CPU and DRAM settings. Don't change the "Spread Spectrum" setting.

Setting Options & Constraints

Don't change the auto-detected settings unless you really know what you are doing. You can use the IWILL Micro Stepping section to configure the CPU settings yourself, but we do not recommend this. Configuring CPU settings at variance with Intel's specifications may damage the CPU and void the warranty.

Change the "BIOS-ROM Flash Protect" line to Flashable setting if you need to update the BIOS.

CMOS Setup Utility – CPU Smart Setting

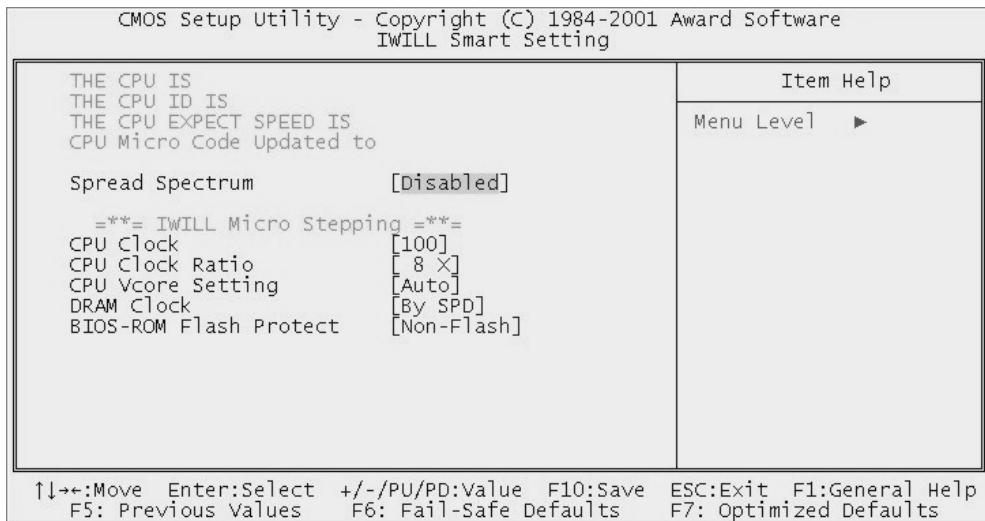

PC Health Status

Section Function

Configures cooling fan settings and displays detected system information.

Default & Autodetected Settings

The Fan start-up temperature settings are optimized defaults. The list of system information is autodetected and displayed.

Setting Options & Constraints

You can change the Fan start-up temperature settings and range though we don't recommend this unless you know what you're doing.

CMOS Setup Utility – PC Health Status

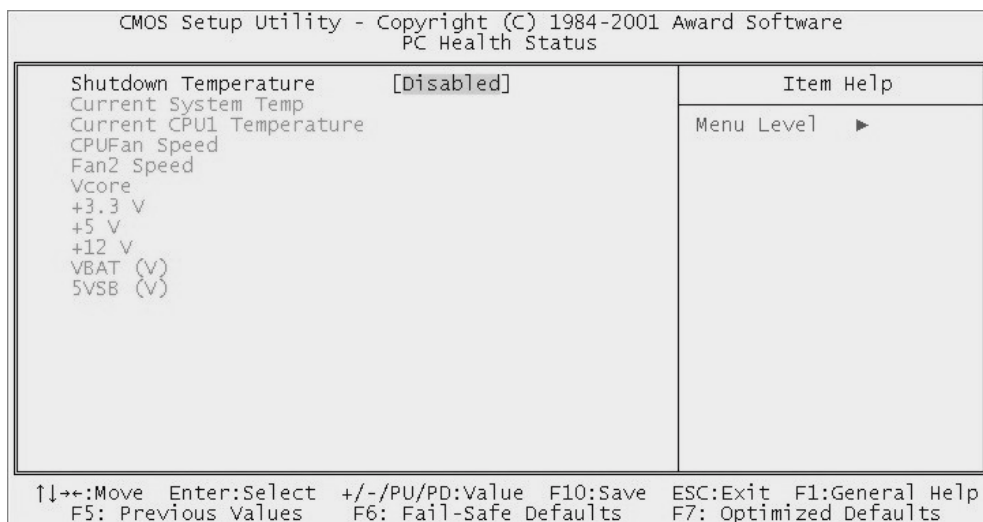

Load Fail-Safe Defaults

This loads a set of minimum configuration defaults. It is used to allow the system to start and then troubleshoot hardware problems. You shouldn't need to use this, it's mainly for technicians.

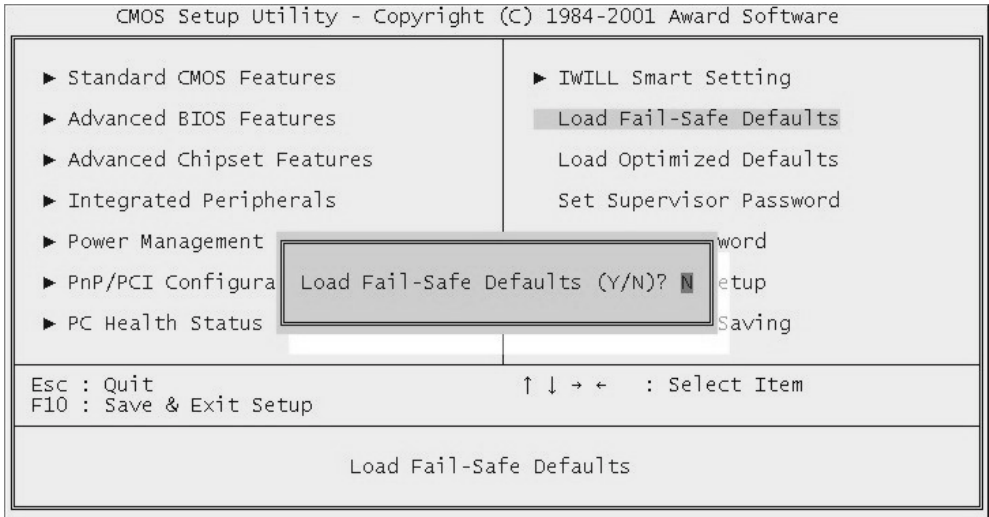

Load Optimized Defaults

This loads the Optimized Defaults. Do this if the configuration record has been corrupted or mistakenly configured or after the Clear CMOS procedure has been performed. See Chapter 3 for more information on this procedure. To load the defaults, select this item, press the Enter key, type a Y and press Enter again.

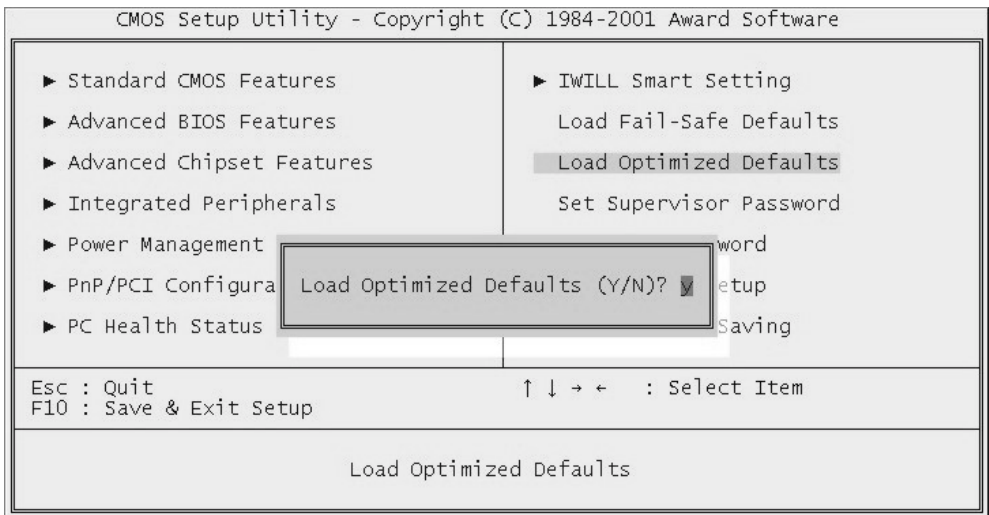

Set Supervisor/User Password

These two items set passwords for system access.

Setting a Password

You can install a Supervisor or User Password. The password prevents access to the CMOS Setup Utility (Supervisor) or the entire system (User).

To install a password, follow these steps:

1. Highlight either Set Password item in the main menu and press Enter.
2. The password dialog box will appear.
3. If you are entering a new password, carefully type in the password. You cannot use more than eight characters or numbers. Passwords are case-sensitive. Press Enter after you have typed in the password. If you are deleting a password that is already installed just press Enter when the password dialog box appears.
4. The system will ask you to confirm the new password by asking you to type it in a second time. Carefully type the password again and press Enter, or just press Enter if you are deleting a password that is already installed.
5. If you have used the correct format, the password will be installed.

If you decide not to set a password after bringing up the password entry window, press the Enter key, not Esc to exit the password entry window.

Save & Exit Setup

This saves the current utility configuration as a new configuration record, exits the utility and restarts the system using the saved configuration record.

Exit Without Saving

Exits the utility and restarts the system without changing the saved configuration record.

In general, it should not be necessary to use the CMOS Setup Utility once you have fully configured it. In the event you do need to change or re-establish the settings, always make sure to save the settings when you exit the utility or the new settings will not be stored.

Installing an OS & Support Software

This section covers installing Operating System software and the support software on the Power Installer support CD-ROM disc. Once you have configured the CMOS Setup Utility, you should install an OS. If you install a supported Microsoft OS, you should also install the driver software on the Power Installer disc.

Installing an Operating System

This motherboard is intended to use the following Operating Systems:

- Microsoft Windows 9X
- Microsoft Windows NT
- Microsoft Windows 2000
- Microsoft Windows XP
- Linux
- Novell Netware
- Unix

Prepare the hard disk drive and install an OS according to the instructions that come with the OS you will use.

Installing the Support Software

The Power Installer CD-ROM disc comes with required hardware drivers for Microsoft Windows and some additional utility software, as noted in Chapter 2. If you have installed a supported Microsoft OS, you must install the required drivers. If you have installed Linux, you can create Linux support disks.

Installing Windows Drivers

This section assumes you have installed one of the supported Microsoft Operating Systems on the system hard disk drive.

To install Windows drivers, insert the Power Installer support CD-ROM disc in the system's CD-ROM (or other optical drive) and wait for the Power Installer interface to automatically load. If it doesn't start, run the Power Installer interface directly from the disc by running Setup.

The Power Installer main screen will appear. Click on this motherboard's model number to open the section for this board.

Power Installer: Main Screen

Click on the model name for this board in the Socket 478 section.

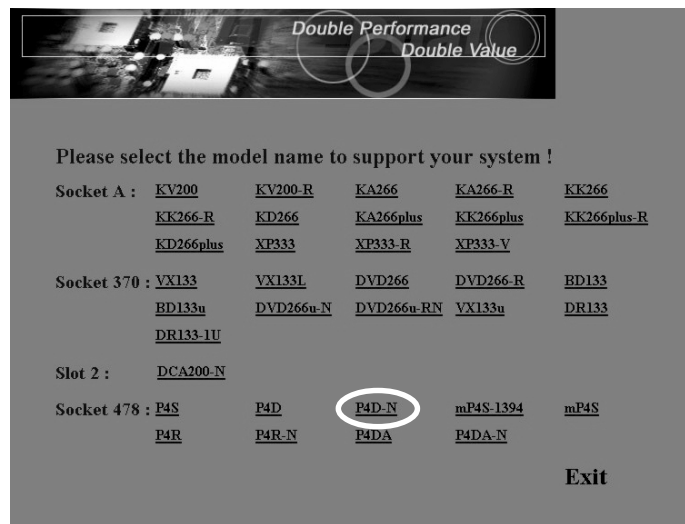

Power Installer: P4D-N Main Screen

You can automatically install the required Intel chipset support by choosing "Auto Installation" or you can do all installations manually by choosing Manual Installation. Either way, you must install the Intel chipset support before you install anything else.

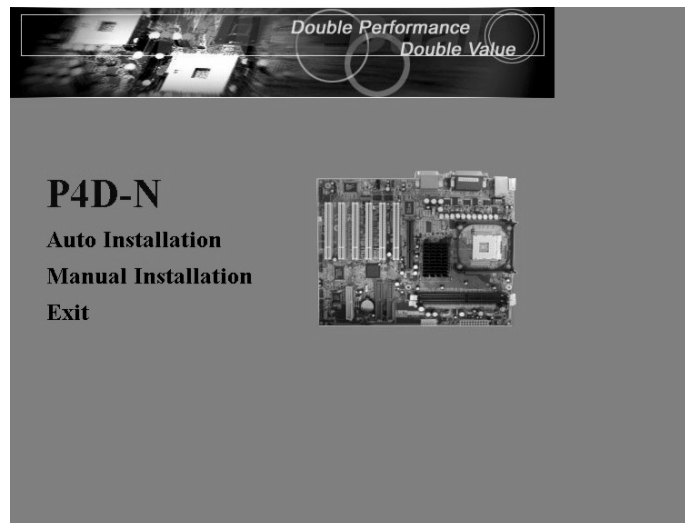

The “Driver and Utilities” screen will appear when you click on Manual Installation. Click on “Driver Installation” and the Driver Installation screen will appear.

Power Installer: Drivers and Utilities

Click on Driver Installation to access the driver install programs.

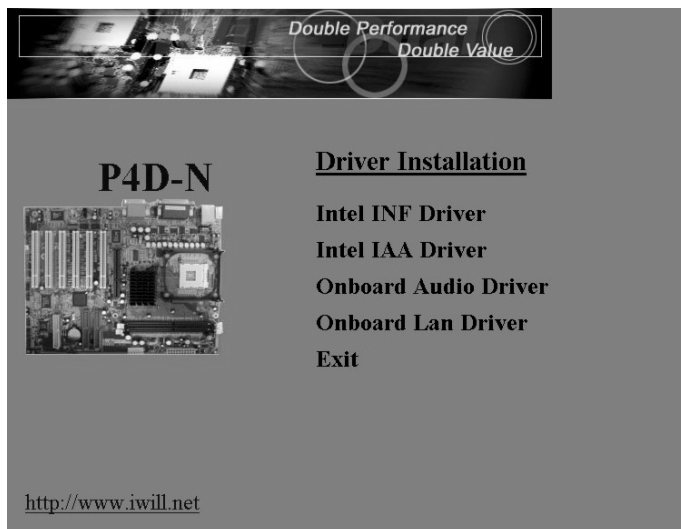
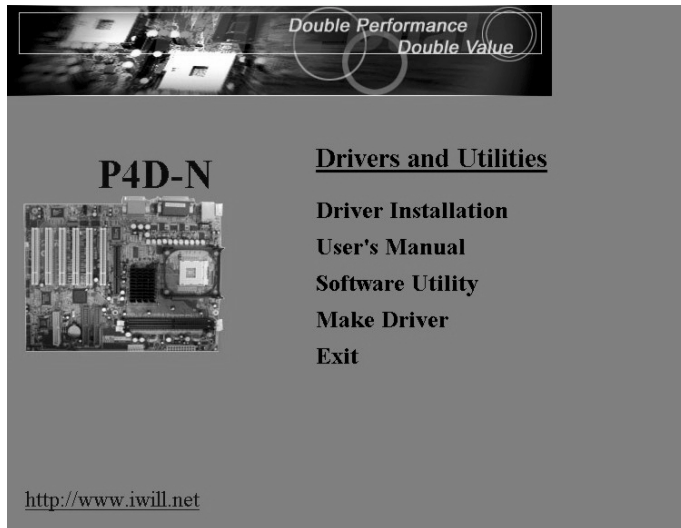

Install the first two items for the Intel Chipset in sequence by clicking on them and following the install program instructions.

Next install the “Onboard Audio Driver” in the same way. Finally, review the “Lan Driver Installation Guide” for the OS you have installed by clicking on “Onboard Lan Driver” and install the appropriate LAN driver for the OS you are using.

The Adobe Acrobat reader install program will run when you try to view the Lan Driver Installation Guide if you have not already installed it. Install the program and then repeat the procedure to read the guide information.

The Make Driver Utility

The “Make Driver” utility makes driver floppy disks. There aren’t any disks you need for this board in the program list, so you don’t need to use this program.

Making & Installing Linux Drivers

You can boot the system from the Power Installer disc. The system will boot from the Linux kernel on the disc and you can use the disk creator that loads to create Linux support disks. You can then use these to install any necessary modules according to your Linux distribution’s instructions for module installation.

Installing the Utility Software

To install the utility software bundled on the Power Installer disc, click on “Software Utility” in the Drivers and Utilities screen to open the Software Utility window.

To install the Adobe Acrobat reader or McAfee Anti-Virus software packages, click on the item you want to install and follow the install program’s instructions.

Power Installer: Software Utility

and follow the install program instructions.



In This Chapter:

Using System Features

Front Panel Controls & Indicators

Additional System Features

Installing & Configuring An IR Port

Performance Optimization

Troubleshooting

6: Using the Motherboard

This chapter covers several topics related to using this motherboard once it is installed in a working system. These include external system features that connect to the motherboard, things you can do to optimize the performance of a system based on this board and some troubleshooting tips you can review in the event any problems arise.

Using System Features

This section explains the system controls and indicators that connect to the motherboard. It also explains how the other system level features on the board work.

Front Panel System Controls & Indicators

The front panel of the system housing will have some or all of the front panel features that connect to the motherboard. These enable the User to determine some information on the systems operational status and provide some system controls.

System Controls

The front panel connector on the motherboard supports several system controls that mount on the front panel of the system housing.

Power Button

Function: Turns the system On and Off.

Use: This button is configured by the CMOS Setup Utility by the “Soft-Off Mode by PWR-BTTN” line in the Power Management section. Depending on the setting, the power button will function in one of two modes, instant on/off or instant on/4 second delay off. In the delay mode, when you push the power button for less than 4 seconds when the system is turned, the system goes into the Suspend power conservation mode. In this mode, you have to push the button for more than 4 seconds to turn the system power off.

Reset Switch

Function: Restarts the system to cold boot.

Use: Press the button to restart the system. This forces a restart under all conditions. Don't use the Reset button if you can shut the system down from within the Operating System.

Note On Reset & Rebooting:

You should always restart or shut down the system by using the OS command for this. This procedure allows the OS to shut down properly, minimizing the possibility of hard disk drive problems or data loss. If the system crashes or “hangs”, you may have to restart the system at the hardware level. There are two hardware reboot options, a keyboard command and the Reset button.

You can effect a “warm” reboot with a key command if the OS supports it. For example, all versions of Microsoft Windows support restarting the computer with the Ctrl-Alt-Del (Delete) command. You can try this command first if it is supported. Otherwise, you will need to use the Reset button.

Suspend Button

Function: Toggles system in and out of Suspend mode.

Use: Press the button to cause the system to enter or resume from Suspend mode.

Note: The front panel feature connector supports a system Suspend button (the ACPI connector) but not all system housings have this button. The same function can be performed at the Operating System level if the OS supports the feature.

Indicator LEDs

The motherboard front panel features connector supports three system status indicator LEDs:

- Power Status LED Indicator
Lights when the system is turned on.
- Hard Disk Drive Activity LED Indicator
Flashes during hard disk drive access.
- Power Conservation Mode LED Indicator
Lights to indicate the system is in a Suspend state power conservation mode.

Most system housings will have all of these LEDs mounted in the housing's front panel.

Additional System Features

This motherboard supports a system “Wake Up” feature that allows the system to resume from a Suspend state in response to a hardware event.

Wake-on LAN (WOL)

Function: The system wakes up in response to a signal arriving over a LAN that it is connected to.

Use: The P4D-N's onboard LAN interface supports the WOL feature. In addition, the onboard WOL connector supports connection to an additional PCI Network Interface Card. The WOL cable from the card connects to the WOL connector on the board.

The feature is not enabled by default in the Power Management section of the CMOS Setup Utility. If you want to use it, set the “Wake-Up by PCI card” line to Enabled.

Installing & Configuring An IR Port

There is a pin header connector for an Infrared communications port module on the motherboard. An IR port enable wireless communication between the system and another device with IR capability. Common examples of such devices are a PDA or notebook computer. Installing an IR port module requires disabling the COM2 serial port on the rear I/O panel and reconfiguring it for IR use in the CMOS Setup Utility.

Installing an IR port module requires an expansion slot opening unless the system housing has a built-in IR port with a cable to connect to the motherboard.

Follow the instructions that come that come with the port module you want to install. The basic installation procedure is as follows if the module installs in an expansion slot opening:

1. Turn off and unplug the system if necessary.
2. Remove the system housing cover.
3. Locate the J45 IR pin header connector on the motherboard. It is below the FDD connector.
4. Remove the expansion slot cover in the system housing that corresponds to an open PCI slot. There may be a slot cover retaining screw to remove and put aside for later use.
5. Insert the port module in the open expansion slot cover and align the module's mounting bracket with the screw hole for the retaining screw (if there is one). Insert the screw and tighten it to secure the port module in place.
6. Plug the module's connector cable on to the IR connector on the motherboard.
7. Replace the system housing cover.
8. Plug in and turn on the computer.
9. Run the CMOS Setup Utility and pen the Integrated Peripherals section. Set the "COM2 Mode Select" to the required mode, IrDA or ASKIR, and configure the port settings below it if necessary. Save the settings and reboot.

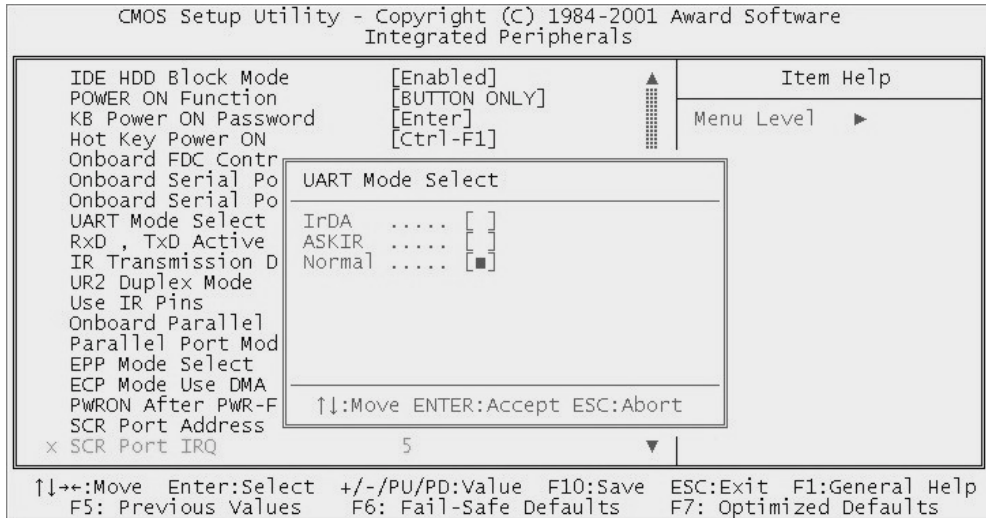
CMOS Setup Utility – Integrated Peripherals**COM2 Mode Select – IR mode selection**

The supported Microsoft Operating Systems should automatically detect and configure the port module after you restart the system. Consult the OS documentation or online Help for more information if necessary. You may also need to install support software that came with the IR port module in order to use it. Consult the installation instructions that came with the module for additional instructions.

Performance Optimization

This section covers things you can do to increase the performance of a system based on this motherboard. The topics covered include system memory, disk subsystems and processor upgrades or adjustments.

System Memory

Adding system memory will increase system performance and capability under any of the supported Operating System. This motherboard supports a total of 2GB of system memory. If you have not installed the maximum, you can consider increasing the amount of installed system memory. Additional system memory speeds up system operation and in some cases produces additional stability in the Operating System.

Disk Subsystems

This motherboard supports IDE drives using data transfer modes up through ATA-100. If you use IDE drives as the primary disk subsystem, selecting drives that support ATA-100 and have a high rotation speed (at least 7,200rpm) will maximize performance.

If you need even better performance from a disk subsystem, you can consider adding a SCSI controller card and SCSI disk drive. A SCSI disk controller with high-speed SCSI hard disk drives will provide a substantial performance enhancement.

Processor Upgrades & Adjustments

Processor speed has a significant effect on overall system performance. To increase system performance, you can consider using or upgrading to a faster processor.

The Intel Pentium 4 processor used by this motherboard comes in a variety of clock speeds. To maximize performance, select a processor with the fastest clock speed the system budget or specification allows.

The CMOS Setup Utility's IWILL Smart Setting feature will automatically detect and configure whatever processors are installed. Manual configuration using the "IWILL Micro Stepping" settings is also available, but setting the Intel Pentium 4 processor to operating parameters outside those specified can damage the CPU and void the warranty.

Troubleshooting

This section details some things you can do to evaluate problems that could possibly occur in the course of using this motherboard. The topics covered include possible hardware problems and problems with the CMOS Setup Utility's system configuration record.

Hardware Problems

A hardware problem may occur either after you install additional hardware or because some existing hardware has failed or has a disconnected or loose connection. This section has some pointers on things you can check before seeking assistance.

General Hardware Troubleshooting

If the motherboard does not operate properly when you first try to use it in the system, it is likely that it is either configured incorrectly, there are problems with external connections. It is also possible the board or some other system component is defective. Always check the most obvious possibilities first.

First check the external components:

- Make sure the system, the monitor and any other external peripherals are plugged in and turned on. Confirm that the system and the power LEDs on any external peripherals are on.
- Check that the monitor, keyboard and mouse are properly connected.

Next check the CMOS Setup Utility:

- Run the CMOS Setup Utility and load the Optimized Defaults. Reset any other custom settings. Remember to "Save & Exit Setup" to restart the computer.

If there is still a problem, check the internal components. Turn off and unplug the system before you remove the system housing cover.

- Press all installed DIMMs into the module sockets to make sure they're fully inserted.
- Make sure you used the correct cables to connect the internal peripherals and that the peripherals are properly connected to the motherboard. Check the Master/Slave positions on all IDE cables. If you installed a device that uses ATA-100 mode, make sure it is connected to the motherboard with an ATA-100 cable to ensure maximum performance.
- Check that all expansion cards are correctly installed and fully inserted in the expansion slots. Pay particular attention to the AGP display card.
- Make sure the processor and its cooling assembly are properly installed.
- Check all the hardware settings on the motherboard and make sure they are correct.

When you're done, reassemble the system and try again. If the problem persists after you have checked all of the above, there may be a hardware conflict or bug. See the next section for additional information.

Hardware Configuration Problems

It is possible for system hardware components to conflict with each other. While all the components and subsystems on the motherboard are designed and tested to work together, expansion cards and peripheral devices can be a problem.

Assuming you have gone through the general troubleshooting procedures and the system still will not start, if you have just added new hardware to your system, there may be a hardware conflict or bug or a problem with a device driver. Try removing the new hardware and see if the system will start. If it does, consult with the device manufacturer for information on solving the problem. In some cases, a firmware or driver upgrade may resolve the problem.

Plug and Play Problems

This motherboard supports the automatic recognition and configuration of expansion cards that support the Plug and Play (PnP) specification. Most currently available expansion cards support PnP. PnP simplifies card installation by allowing the system to handle system resource allocation. If you install an expansion card that is not PnP compliant, you may still need to configure the card manually. Consult the card's documentation for instructions or other information.

Replacing the System Configuration Record

As noted previously, the CMOS Setup Utility creates a system configuration record and stores it in CMOS memory on the motherboard. This record must be correct and uncorrupted for the system to operate properly. It is possible for the system configuration record can become corrupted or lost. If this occurs, the system will not operate properly or at all. This is not a serious problem. You can restore a working configuration using the CMOS Setup Utility to create a new configuration record by loading the Optimized Defaults and reentering any other settings you had made.

Loading Optimized Defaults

The CMOS Setup Utility does not require an operating system to run. You run the utility by typing the Del or Delete key while the system is starting up to brings up the utility's main screen.

There are two sets of defaults listed, Optimized and Fail-Safe. The Fail-Safe Defaults are a minimum configuration set for use by technicians when troubleshooting system problems. The Optimized Defaults are what the system normally operates on. If a corrupted system configuration record caused the problem you experienced, once you load the Optimized Defaults and reboot, the system should function normally. The instructions on the next page illustrate this procedure.

You can easily restore a working system configuration record from the main screen of the CMOS Setup Utility. To do so, do as follows:

1. Select the “Load Optimized Defaults” item.
2. Press the Enter Key. A confirmation message will appear on the screen. Type a “Y” to accept loading the Optimized Default settings. Now make any other settings you need to.

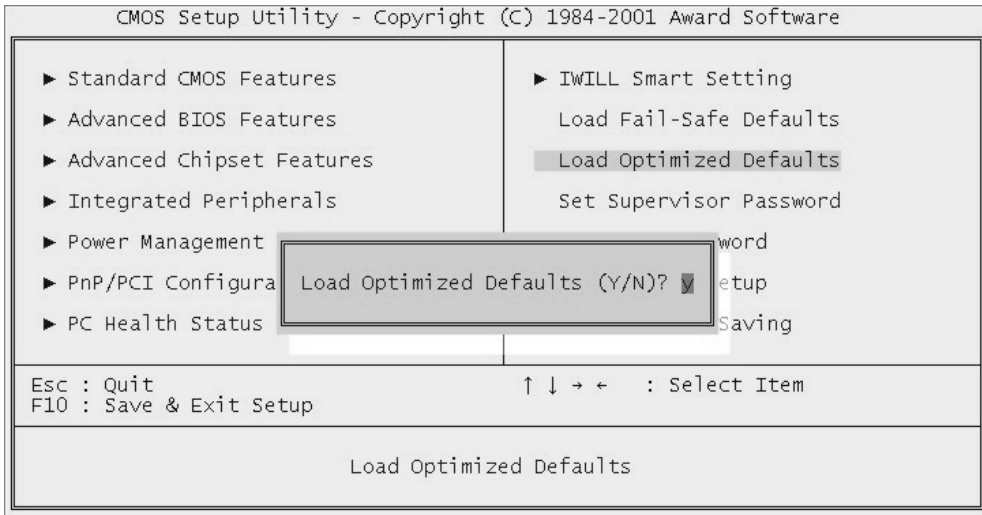

3. Select “Save & Exit Setup” and press the Enter key. A confirmation message will appear. Press the Enter key again to confirm.

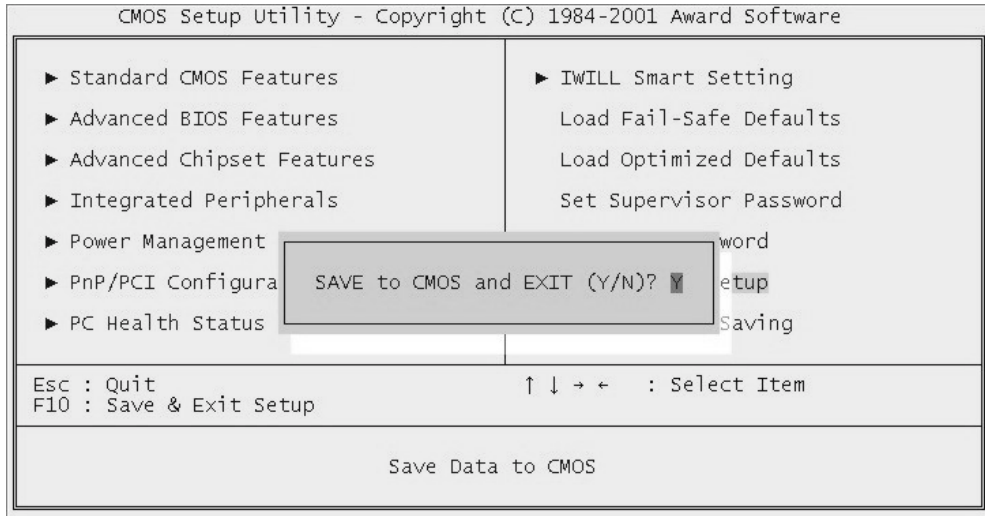

The CMOS Setup Utility will close and the system will reboot. The system should then start properly and run normally.

In This Chapter:
Technical Specifications

7: Technical Specifications

This chapter lists some technical information about this motherboard.

Processor I/F (Socket 478)

Supports 1 478-pin Pentium 4 “Northwood” processor
Supports 400M FSB (Front Side Bus)
Supports Intel Pentium 4 CPU from 1.5 to 2.2 GHz and up

CPU Frequency/Voltage Select

Supports Vcore selection by BIOS
Supports CPU Multiplier selection by BIOS (from 8X to 23X)
Supports CPU External Frequency selection by BIOS (up to 200 MHz)

ChipSet (Marking, Packing)

Intel 845 “Brookdale” FCBGA 593
ICH2
FWH

Memory

Supports 200 / 266 MHz DDR devices
Supports ECC DDR SDRAM (Single bit error Correction, Multiple bit error Detection)
Supports 16MB/64MB/128MB/256MB/512MB DDR SDRAM technology
Supports up to 1GB when using 512MB technology

Graphics

Supports AGP 4X 1.5V Only

General I/O

PCI 2.1/2.2 compliance
Supports 32-bit/33MHz PCI interface
Supports LPC interface
Supports ATA33/ATA66/ATA100 IDE interface
Supports Floppy interface
Supports 16550A UART interface
Supports ECP/EPP interface
Supports PS/2 interface
Supports SIR/FIR/CIR interface
Supports USB interface

Discrete IDE

Supports two independent ATA channels
Supports ATA66/ATA100 and PIO mode
Supports Win9X/WinNT/Win2K/WinXP/Linux/NetWare/Solaris/UnixWare/OpenServer/SCO ODT

LAN Support

Supports HomePNA interface

Supports 10/100M BaseT (IEEE 802.3u Auto-Negotiation) Ethernet interface

Supports Full-Duplex Flow Control (IEEE 802.3x)

Supports Remote Power-up using Wake-on-LAN technology (card only)

Supports Wake-Up on Magic packet through PME#

Supports Wake-Up on LinkChg through PME#

Supports Wake-Up on Microsoft wake-up frame through PME#

Supports Wake-Up on "Interesting" packet through PME#

Supports WfM

Supports Alert-on-LAN

Supports Win9X/WinNT/Win2K/WinXP//Linux/NetWare/Solaris/UnixWare/OpenServer/SCO ODT

Audio Support

CMedia audio controller on board

Supports Creative SB-Link protocol

Supports Game/MIDI interface

Supports Audio interface

Supports Win9X/WinNT/Win2K/WinXP/Linux/NetWare/Solaris/UnixWare/OpenServer/SCO ODT

Management

Supports voltage monitoring (+12V/-12V/+5V/-5V/Vcore/Vcore2/VTT/VIO/Vbat/Vsb)

Supports fan control signal (CPU/SYS)

Supports temperature sensor (CPU/AUX/SYS)

Supports Chassis Intrusion

Supports Power on by LAN/Ext. Modem/Int. Modem/PS2 Keyboard/PS2 Mouse/RTC/PME

Supports Resume by LAN/Ext. Modem/Int. Modem/PS2 Keyboard/PS2 Mouse/RTC/PME

Supports AOL

Supports Intel LDCM/LDSM

Supports AMI ADCM

Supports ACPI

Supports APM

Supports DMI

Supports SMBUS

Supports PnP

Supports BIOS ROM Flash Control

Supports "AC-Loss Recovery"

Supports Suspend to RAM (DRAM should not have power during S4/S5 state)

Supports Manually Assigned PCI IRQ

Supports Auto-reboot function through TCO Timer when system hang

Supports ICH Safe-Mode function through jumper

Supports PS2 mouse and PS2 keyboard auto swapping

Power Requirements

Onboard DC/DC switching voltage regulator supports Vcore up to 60A current

Onboard DC/DC switching voltage regulator supports VIO up to 10A current

Discrete voltage regulator for AGP port

Supports adjustable Vcore (By BIOS)

Supports 150A/us Icc slew rate

Expansion Slot, Sockets and Connectors

One mPGA478 CPU socket

Two DDR DIMM sockets

One AGP 1.5V AGP slot

Six 32bit/33MHz Bus Master PCI slots

Two IDE connectors

One FDC connector

Two External Serial Port connectors

One External Parallel Port connector

One External PS/2 Mouse connector

One External PS/2 Keyboard connector

One External Game/MIDI/AUDIO connector

One Internal CD-in connector

One Onboard USBx2 connector

One External USBx2 & RJ45 connectors (RJ-45 on P4D-N only)

One Internal IR connector

One Internal WOL connector

One CPU temperature sensor header

One AUX temperature sensor header

One System temperature sensor header

One CPU fan connector with PWM control

One AUX fan connector

One System fan connector with fan control

One Chassis Intrusion header

One Smart Card Reader connector

One Internal SMBus connector

One ATX 20-pin power connector

One ATX 12V 4-pin power connector (ATX 12V for Vcore)

Driver & Utility Support

Power Installer CD-ROM Disc

845 Chipset Support

Audio Driver Supporting Win98/ME/NT/2K/XP

LAN Driver Supporting Win98/ME/NT/2K/XP

Software Utilities

Accessories

One Operation Manual

One 34-pin floppy cable (4 heads, 38+13+5cm)

One 40-pin ATA66/100 IDE cable (3 heads, 30+15cm, w/ tab)

One IWILL Power Installer CD

Form Factor

ATX, 305mm x 190mm

4 Layer design

Free Manuals Download Website

<http://myh66.com>

<http://usermanuals.us>

<http://www.somanuals.com>

<http://www.4manuals.cc>

<http://www.manual-lib.com>

<http://www.404manual.com>

<http://www.luxmanual.com>

<http://aubethermostatmanual.com>

Golf course search by state

<http://golfingnear.com>

Email search by domain

<http://emailbydomain.com>

Auto manuals search

<http://auto.somanuals.com>

TV manuals search

<http://tv.somanuals.com>