

# MX945GM2

Intel® 945GME  $\mu$ FC-PGA 478 Core™ 2 Duo / Core™ Duo /  
Core™ 2 Solo / Core™ Solo mobile CPU Mini ITX Main  
Board

## User's Manual



Ver. 1.00

# Contents

<b>Safety Information</b> .....	<b>4</b>
<b>Technical Support</b> .....	<b>5</b>
<b>Conventions Used in This Guide</b> .....	<b>5</b>
<b>Packing List</b> .....	<b>6</b>
<b>Revision History</b> .....	<b>7</b>
<b>Specifications Summary</b> .....	<b>8</b>
<b>Block Diagram</b> .....	<b>11</b>
<b>Production Introduction</b> .....	<b>13</b>
1.1 Before you Proceed .....	13
1.2 Motherboard Overview .....	14
1.2.1 Placement Direction .....	14
1.2.2 Screw Holes .....	14
1.3 Motherboard Layout .....	15
1.3.1 Layout Content List .....	16
1.4 Central Processing Unit (CPU) .....	18
1.4.1 Installing the CPU .....	19
1.4.2 Installing the CPU Heatsink and Fan .....	21
1.4.3 Uninstalling the CPU Heatsink and Fan .....	23
1.5 System Memory .....	24
1.5.1 DIMM Sockets Location .....	24
1.5.2 Memory Configurations .....	25
1.5.3 Installing a DDR2 DIMM .....	26
1.5.4 Removing a DDR2 DIMM .....	26
1.6 Expansion Slots .....	27
1.6.1 Installing an Expansion Card .....	27
1.6.2 Configuring an Expansion Card .....	27
1.6.3 Standard Interrupt Assignments .....	28
1.6.4 PCI Slots .....	29
1.6.5 PCI Express X16 Slot .....	29
1.6.6 Mini PCI .....	29
1.7 Jumpers .....	30
1.7.1 Clear CMOS (J4) .....	30
1.7.2 Watchdog Timer Output Select (J6) .....	31
1.7.3 AT/ATX Power Select (J7) .....	31
1.7.4 LVDS Extended Setting (J14) .....	32
1.7.5 COM1, COM2 RI/+5V/+12v Selection (JP14, JP15) .....	32

# Contents

<b>1.8</b>	<b>Connectors</b> .....	<b>33</b>
1.8.1	Rear Panel Connectors.....	33
1.8.2	ATX Power Connector (ATX_PWR1).....	35
1.8.3	USB 2.0 Connector (CN4, CN5).....	36
1.8.4	Serial Port 2 Connector (CN6).....	37
1.8.5	Serial Port 3 Connector (CN7).....	37
1.8.6	Serial Port 4 Connector (CN8).....	38
1.8.7	Front Panel Audio Connector (CN16).....	38
1.8.8	Case Open Connector (CN19).....	39
1.8.9	CPU Fan Connector (C_FAN1).....	39
1.8.10	System Panel Connector (F_PANEL1).....	40
1.8.11	Primary IDE Connector (IDE1).....	41
1.8.12	IrDA Connector (IR_CON1).....	41
1.8.13	Amplifier Connector (JAMP1).....	42
1.8.14	Optical Drive Audio Connector (JCD1).....	42
1.8.15	LCD Inverter Connector (JBKL1).....	43
1.8.16	Digital I/O Connector (JGPIO1).....	44
1.8.17	Digital I/O Connector (JGPIO2).....	44
1.8.18	LVDS Connector (JLVDS1).....	45
1.8.19	Serial ATA Connector [Black] (SA1, SA2).....	45
1.8.20	SM Bus Connector (SM_BUS1).....	46
1.8.21	Digital Audio Connector (SPDIF_OUT1).....	46
1.8.22	Chassis Fan Connector (S_FAN1).....	47

# Safety Information

## Electrical safety

- To prevent electrical shock hazard, disconnect the power cable from the electrical outlet before relocating the system.
- When adding or removing devices to or from the system, ensure that the power cables for the devices are unplugged before the signal cables are connected. If possible, disconnect all power cables from the existing system before you add a device.
- Before connecting or removing signal cables from the motherboard, ensure that all power cables are unplugged.
- Seek professional assistance before using an adapter or extension cord. These devices could interrupt the grounding circuit.
- Make sure that your power supply is set to the correct voltage in your area. If you are not sure about the voltage of the electrical outlet you are using, contact your local power company.
- If the power supply is broken, do not try to fix it by yourself. Contact a qualified service technician or your retailer.

## Operation safety

- Before installing the motherboard and adding devices on it, carefully read all the manuals that came with the package.
- Before using the product, make sure all cables are correctly connected and the power cables are not damaged. If you detect any damage, contact your dealer immediately.
- To avoid short circuits, keep paper clips, screws, and staples away from connectors, slots, sockets and circuitry.
- Avoid dust, humidity, and temperature extremes. Do not place the product in any area where it may become wet.
- Place the product on a stable surface.
- If you encounter technical problems with the product, contact a qualified service technician or your retailer.



---

The symbol of the crossed out wheeled bin indicates that the product (electrical and electronic equipment) should not be placed in municipal waste. Check local regulations for disposal of electronic products.

---

## Technical Support

If a problem arises with your system and no solution can be obtained from the user's manual, please contact your place of purchase or local distributor. Alternatively, please try the following help resources for further guidance. Visit the Advansus website for FAQ, technical guide, BIOS updates, driver updates, and other information:

<http://www.advansus.com.tw/Support/Support.asp>

## Conventions Used in This Guide

To make sure that you perform certain tasks properly, take note of the following symbols used throughout this manual.



**DANGER/WARNING:** Information to prevent injury to yourself when trying to complete a task.



**CAUTION:** Information to prevent damage to the components when trying to complete a task.



**IMPORTANT:** Instructions that you **MUST** follow to complete a task.



**NOTE:** Tips and additional information to help you complete a task.

## Packing List

Before you begin installing your single board, please make sure that the following materials have been shipped:

- ✓ 1 x i945GME Mini ITX Main board
- ✓ 1 x CD-ROM contains the followings:
  - User's manual (this manual in PDF file)
  - Drivers
- ✓ 2 x COM cable
- ✓ 1 x IDE HDD cable (40-pin, pitch 2.54mm)
- ✓ 2 x SATA cable kit (SATA/Power)
- ✓ 1 x Startup Manual



---

If any of the above items is damaged or missing, please contact your retailer.

---

## Revision History

Revision	Revision History	Date
V 1.0	First release for PCB 1.00	January 10, 2008

## Specifications Summary

<b>Features</b>	<b>CPU</b>	Supports Intel $\mu$ FC-PGA 478 Core 2 Duo / Core Duo / Core 2 Solo / Core Solo mobile CPU with 65nm process technology
	<b>Chipset</b>	Intel 82945GME Express Chipset
	<b>Memory</b>	Two 240-pin DIMMs up to 4GB Dual Channel DDR2 533/667 SDRAM
	<b>Graphic</b>	Intel Graphics Media Accelerator 950
	<b>Panel</b>	Dual 18/24*-bit LVDS
	<b>Audio</b>	Realtek ALC888 Audio Code 5.1 CH. with Two independent audio stream
	<b>LAN</b>	Dual Marvell 88E8053 Gigabit LAN Controller
	<b>Expansion</b>	1 x PCI-E X16, 1 x PCI, 1 x Mini PCI, 1 x Type I/II CF
	<b>I/O</b>	4 x COM, 8 x USB 2.0, 2 x SATA, 1 x 8-bit Digital I/O

### System

<b>CPU</b>	Supports Intel $\mu$ FC-PGA 478 Core 2 Duo / Core Duo / Core Solo CPU with 65nm process technology
<b>FSB</b>	533/667 MHz
<b>BIOS</b>	Award 8 Mb Flash ROM BIOS
<b>System Chipset</b>	Intel 82945GME GMCH/82801GM ICH7-M DH
<b>I/O Chipset</b>	Winbond W83627EHG-A
<b>Memory</b>	Two 240-pin DIMM sockets support up to 4 GB Dual Channel DDR2 533/667 SDRAM
<b>SSD</b>	One CompactFlash Type I/II socket
<b>Watchdog Timer</b>	Reset: 1 sec.~255 min. and 1 sec. or 1 min./step
<b>H/W Status Monitor</b>	Monitoring CPU temperature, voltage, and cooling fan status. Auto throttling control when CPU overheats
<b>Expansion Slots</b>	One PCI Express X16, One PCI slot (PCI Rev. 2.2 compliant), One Mini PCI
<b>S3</b>	S3 Support
<b>Smart Fan Control</b>	Yes

### I/O

<b>MIO</b>	1 x EIDE (Ultra DMA 100), 4 x RS-232, 2 x SATA, 1 x K/B, 1 x Mouse (COM1, COM2 with power output)
<b>IrDA</b>	115k bps, IrDA connector (1.0 compliant)
<b>USB</b>	8 x USB 2.0 ports
<b>DIO</b>	8-bit General Purpose I/O for DI and DO (Smbus)



## Specifications Summary

Display	
Chipset	Intel® 82945GME GMCH integrated Graphics Media Accelerator 950
Display Memory	Intel® DVMT 3.0 supports 224 MB video memory
Resolution	2048 x 1536 @ 32 bpp (85 Hz)
Dual Display	CRT + LVDS
LVDS	Intel® 945GME Dual 18-bit/24-bit LVDS
2nd LVDS	Through ADD2 LVDS Card
DVI / Onboard DVI Chips	Through ADD2 DVI Card
Secondary VGA	Through ADD2 VGA Card
Audio	
AC97 Codec	Realtek ALC888 supports 5.1-CH with two independent audio stream
Audio Interface	Mic. in, Line in, CD Audio in, Line out
Ethernet	
LAN1	Marvell 88E8053 PCI-E Gigabit Ethernet Controller
LAN2	Marvell 88E8053 PCI-E Gigabit Ethernet Controller
Back I/O Port	
Back Panel	1 x PS/2 Keyboard 1 x PS/2 Mouse 1 x RS-232 Serial Port 1 x VGA port 2 x LAN RJ45 port 4 x USB 2.0/1.1 5.1 CH Audio I/O (3 jacks)

# Specifications Summary

## Internal I/O Connector

<b>Internal I/O</b>	2 x USB connectors support additional 4 USB ports 1 x 20-pin ATX Power connector 1 x 40-pin IDE connector for two devices 3 x COM connector 2 x SATA connectors 1 x System panel connector 1 x CD-In connector 1 x SPDIF out connector 1 x SMBus management connector 1 x LVDS connector 1 x CPU Fan connector 2 x 6pin connector support 8Bit GPIO via SMBus PCA9554 Controller (Optional)
---------------------	--

## Mechanical & Environmental

<b>Power Type</b>	ATX
<b>Operating Temperature</b>	0~60°C (32~140°F)
<b>Operating Humidity</b>	0%~90% relative humidity, non-condensing
<b>Size (L x W)</b>	6.69" x 6.69" (170 mm x 170 mm)
<b>Weight</b>	0.88 lbs (0.4 Kg)

\* Specifications are subject to change without notice.

# Block Diagram

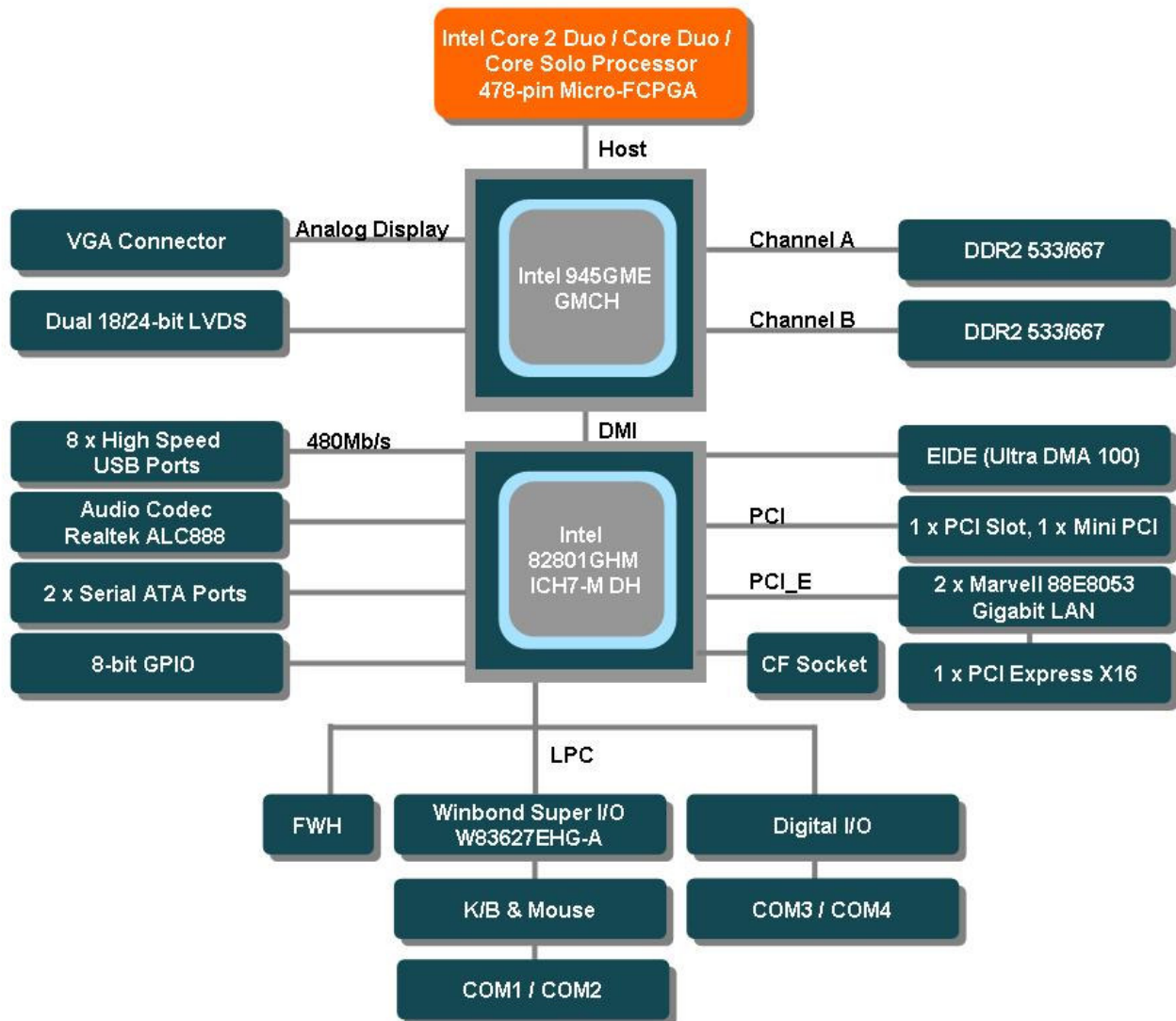

This chapter describes the main board features and the new technologies it supports.

# 1 Product introduction

# Production Introduction

## 1.1 Before you Proceed

Take note of the following precautions before you install motherboard components or change any motherboard settings.



- 
- Unplug the power cord from the wall socket before touching any component.
  - Use a grounded wrist strap or touch a safely grounded object or a metal object, such as the power supply case, before handling components to avoid damaging them due to static electricity
  - Hold components by the edges to avoid touching the ICs on them.
  - Whenever you uninstall any component, place it on a grounded antistatic pad or in the bag that came with the component.
  - Before you install or remove any component, ensure that the ATX power supply is switched off or the power cord is detached from the power supply. Failure to do so may cause severe damage to the motherboard, peripherals, and/or components.
-

## 1.2 Motherboard Overview

Before you install the motherboard, study the configuration of your chassis to ensure that the motherboard fits into it. Refer to the chassis documentation before installing the motherboard.



---

Make sure to unplug the power cord before installing or removing the motherboard. Failure to do so can cause you physical injury and damage motherboard components.

---

### 1.2.1 Placement Direction

When installing the motherboard, make sure that you place it into the chassis in the correct orientation. The edge with external ports goes to the rear part of the chassis as indicated in the image below.

### 1.2.2 Screw Holes

Place four (4) screws into the holes indicated by circles to secure the motherboard to the chassis.



---

Do not over tighten the screws! Doing so can damage the motherboard.

---

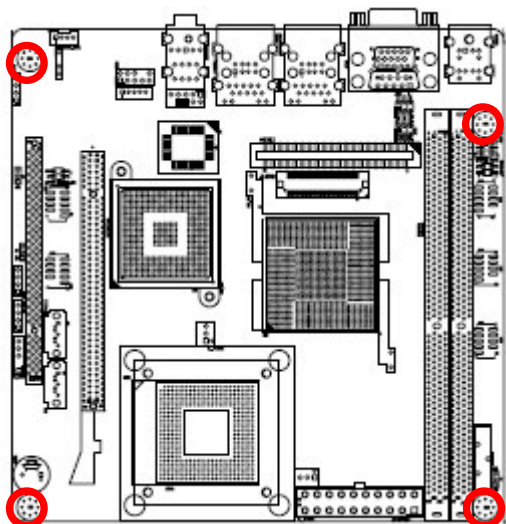

Place this side towards the rear of the chassis

### 1.3 Motherboard Layout

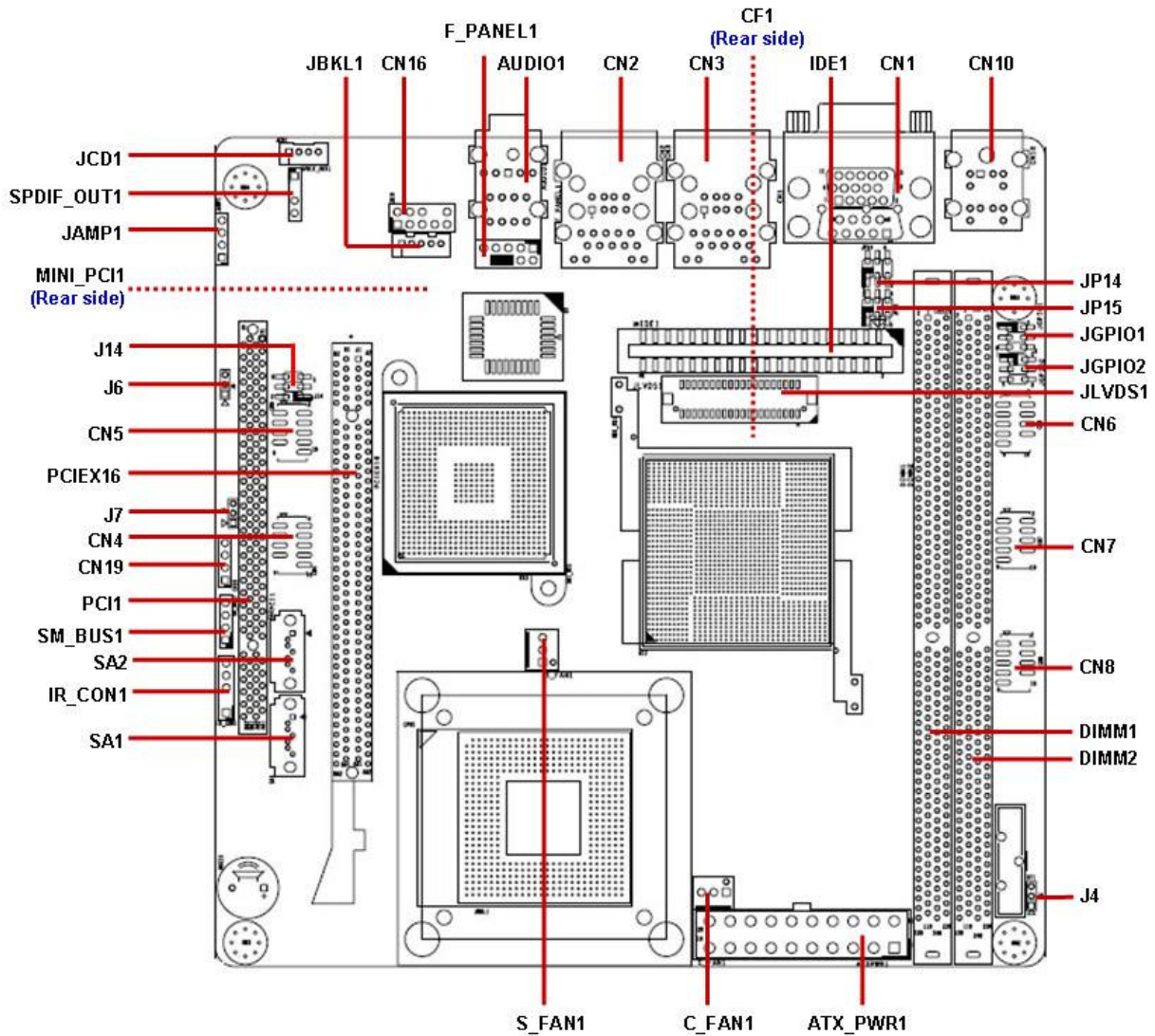

### 1.3.1 Layout Content List

Slots			
Label	Function	Note	Page
CF1	Compact Flash Connector	(Rear side)	N/A
DIMM1	240-pin DDR2 DIMM slot		N/A
DIMM2	240-pin DDR2 DIMM slot		N/A
MINI_PCI1	Mini PCI Slot		N/A
PCIEX16	PCI Express X16 Slot		N/A
PCI1	PCI Slot		N/A

Jumpers			
Label	Function	Note	Page
J4	Clear CMOS	3 x 1 header, pitch 2.00mm	30
J6	Watchdog Timer Output Select	3 x 1 header, pitch 2.00mm	31
J7	AT/ATX Power Select	3 x 1 header, pitch 2.00mm	31
J14	LVDS Extended Setting	3 x 2 header, pitch 2.00mm	32
JP14, JP15	COM1, COM2 RI/+5V/+12V Selection	3 x 2 header, pitch 2.00mm	32

Rear Panel Connector			
Label	Function	Note	Page
CN10	PS/2 keyboard and mouse	6-pin Mini-Din	33,34
CN1	Serial port connector VGA connector	D-sub 9-pin, male D-sub 15-pin, female	33,34
CN3	RJ-45 Ethernet connector x 1 USB connector x 2		33,34
CN2	RJ-45 Ethernet connector x 1 USB connector x 2		33,34
AUDIO1	Line-in port, Line-out port, Microphone port,	5.1 Channel Audio I/O (3 jacks)	34



<b>Internal Connector</b>			
<b>Label</b>	<b>Function</b>	<b>Note</b>	<b>Page</b>
ATX_PWR1	ATX Power Connector	10 x 2 header	35
CN4	USB 2.0 Connector	5 x 2 header, pitch 2.00mm	36
CN5	USB 2.0 Connector	5 x 2 header, pitch 2.00mm	36
CN6	Serial Port 2 Connector	5 x 2 header, pitch 2.00mm	37
CN7	Serial Port 3 Connector	5 x 2 header, pitch 2.00mm	37
CN8	Serial Port 4 Connector	5 x 2 header, pitch 2.00mm	38
CN16	Front Panel Audio Connector	5 x 2 header, pitch 2.00mm	38
CN19	Case Open and Speaker Out Connector	4 x 1 header, pitch 2.00mm	39
C_FAN1	CPU Fan Connector	3 x 1 wafer, pitch 2.54mm	39
F_PANEL1	System Panel Connector	5 x 2 header, pitch 2.54mm	40
IDE1	Primary IDE Connector	20 x 2 header, pitch 2.54mm	41
IR_CON1	IrDA Connector	5 x 1 header, pitch 2.00mm	41
JAMP1	Amplifier connector	4 x 1 header, pitch 2.54mm	42
JBKL1	LCD Inverter Connector	5 x 1 header, pitch 2.00mm	43
JCD1	Optical Drive Audio Connector	4 x 1 header, pitch 2.00mm	42
JGPIO1	Digital I/O Connector	3 x 2 header, pitch 2.00mm	44
JGPIO2	Digital I/O Connector	3 x 2 header, pitch 2.00mm	44
JLVDS1	LVDS connector	HIROSE DF13S-40DP-1.25V	45
SA1, SA2	Serial ATA connectors [Black]	7-pin header	45
SM_BUS1	SM Bus Connector	4 x 1 header, pitch 2.00mm	46
SPDIF_OUT1	Digital Audio connector	4 x 1 header, pitch 2.54mm	46
S_FAN1	Chassis Fan Connector	3 x 1 wafer, pitch 2.54mm	47

## 1.4 Central Processing Unit (CPU)

The motherboard comes with a surface mount 478-pin socket designed for the Intel® Core 2 Duo / Core Duo / Core 2 Solo / Core Solo CPU with 65nm process.

Take one of the marked corner (with gold triangle) on the CPU. This mark should match a specific corner on the socket to ensure correct installation.



- 
- Make sure the AC power is off before you install the CPU.
  - If installing a dual-core CPU, connect the CPU fan cable to the **C\_FAN1** connector to ensure system stability.
- 



- 
- Your boxed Intel® socket 478P Core Duo / Core Solo / Core 2 Duo CPU with 65nm process package should come with installation instructions for the CPU, heatsink, and the retention mechanism. If the instructions in this section do not match the CPU documentation, follow the latter.
  - Upon purchase of the motherboard, make sure that the PnP cap is on the socket and the socket contacts are not bent. Contact your retailer immediately if the PnP cap is missing, or if you see any damage to the PnP cap/socket contacts/motherboard components. Your place of purchase or local distributor will shoulder the cost of repair only if the damage is shipment/transit-related.
  - Keep the cap after installing the motherboard. Your place of purchase or local distributor will process Return Merchandise Authorization (RMA) requests only if the motherboard comes with the cap on the socket.
  - The product warranty does not cover damage to the socket contacts resulting from incorrect CPU installation/removal, or misplacement/loss/ incorrect removal of the PnP cap.
-

### 1.4.1 Installing the CPU

1. Locate the CPU socket on the motherboard.



Before installing the CPU, make sure that the socket box is facing towards you.

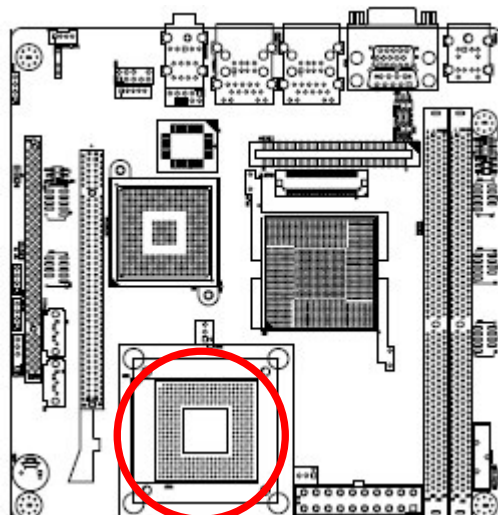

2. The processor socket comes with a screw to secure the processor, please unlock the screw first.

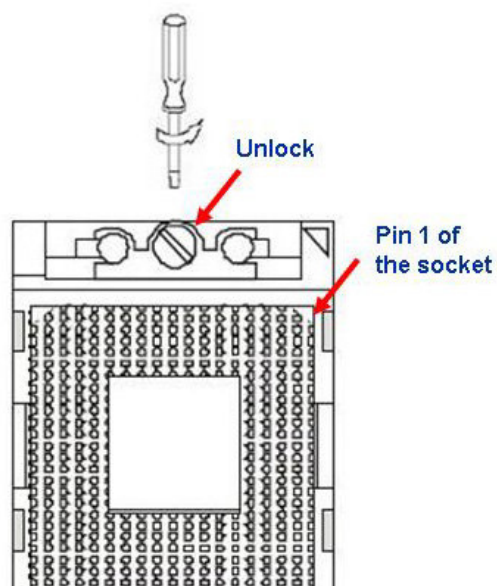

## MX945GM2

3. Position the CPU above the socket and the gold triangular mark on the CPU must align with pin 1 of the CPU socket.
4. Carefully insert the CPU into the socket until it fits in place 'Gold mark'.
5. Turn the screw to the lock position.



---

The CPU fits in only one correct orientation. DO NOT force the CPU into the socket to prevent bending the connectors on the socket and damaging the CPU.

---

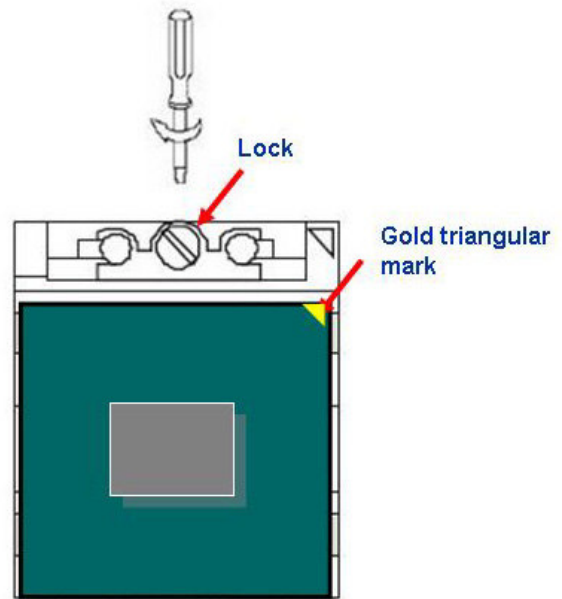

---

After installation, make sure to plug-in the ATX power cable to the motherboard.

---

### 1.4.2 Installing the CPU Heatsink and Fan

The Intel® socket 478P Core Duo / Core Solo / Core 2 Duo CPU processor requires a specially designed heatsink and fan assembly to ensure optimum thermal condition and performance.



- 
- Install the motherboard to the chassis before you install the CPU fan and heatsink assembly.
  - When you buy a boxed Intel® processor, the package includes the CPU fan and heatsink assembly. If you buy a CPU separately, make sure that you use only Intel®-certified multi-directional heatsink and fan.
- 



---

If you purchased a separate CPU heatsink and fan assembly, make sure that you have properly applied Thermal Interface Material to the CPU heatsink or CPU before you install the heatsink and fan assembly.

---

1. Place the heatsink on top of the installed CPU, making sure that the four fasteners match the holes on the motherboard.



---

Orient the heatsink and fan assembly such that the CPU fan cable is closest to the CPU fan connector.

---

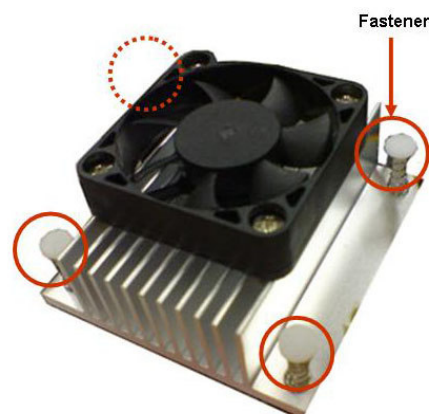
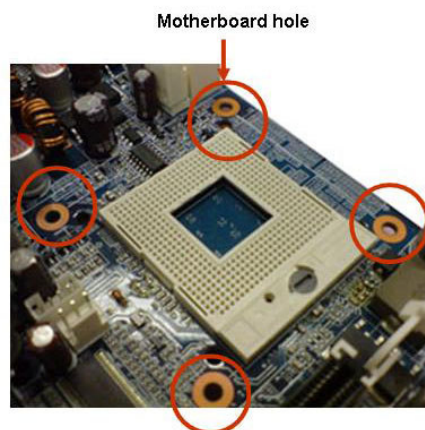



---

Make sure each fastener is oriented as shown, with the narrow groove directed outward.

---

## MX945GM2

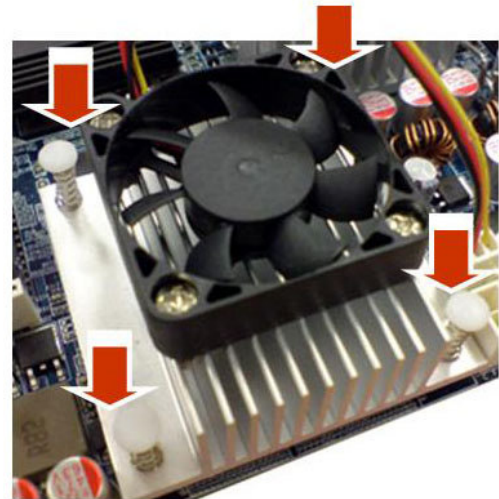
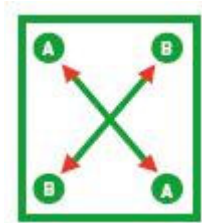
2. Push down two fasteners at a time in a diagonal sequence to secure the heatsink and fan assembly in place.



3. Connect the CPU fan cable to the connector on the motherboard labelled **C\_FAN1**.

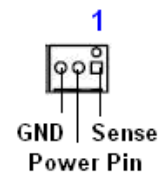
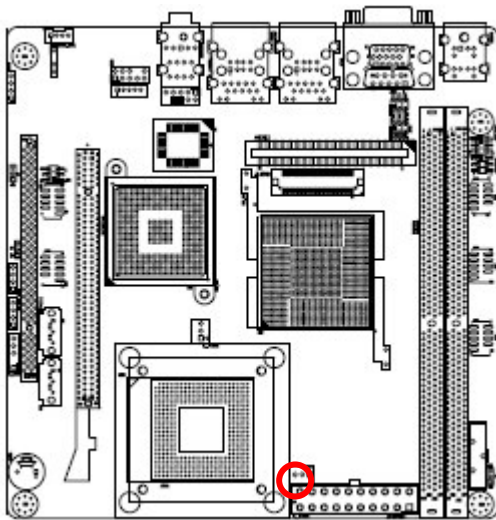

- Do not forget to connect the fan cables to the fan connectors. Insufficient air flow inside the system may damage the motherboard components, and hardware monitoring errors can occur if you fail to plug this connector.
- These are not jumpers! DO NOT place jumper caps on the fan connectors.



### 1.4.3 Uninstalling the CPU Heatsink and Fan

1. Disconnect the CPU fan cable from the connector on the motherboard.
2. Rotate each fastener counterclockwise.

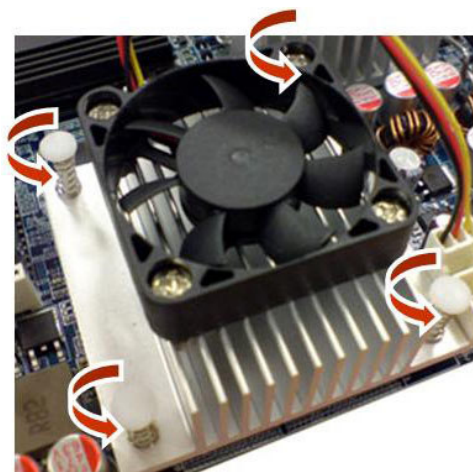

3. Pull up two fasteners at a time in a diagonal sequence to disengage the heatsink and fan assembly from the motherboard

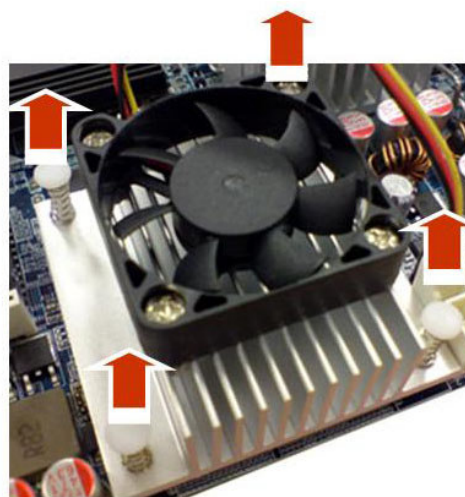
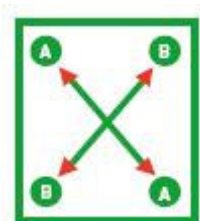

4. Carefully remove the heatsink and fan assembly from the motherboard.

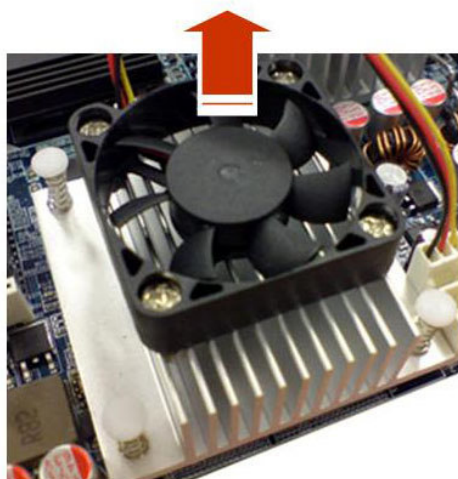

---

Refer to the documentation in the boxed or stand-alone CPU fan package for detailed information on CPU fan installation.

---

## 1.5 System Memory

### 1.5.1 DIMM Sockets Location

The motherboard comes with four 240-pin Double Data Rate 2 (DDR2) Dual Inline Memory Modules (DIMM) sockets.

A DDR2 module has the same physical dimensions as a DDR DIMM but has a 240-pin footprint compared to the 184-pin DDR DIMM. DDR2 DIMMs are notched differently to prevent installation on a DDR DIMM socket. The following figure illustrates the location of the sockets:

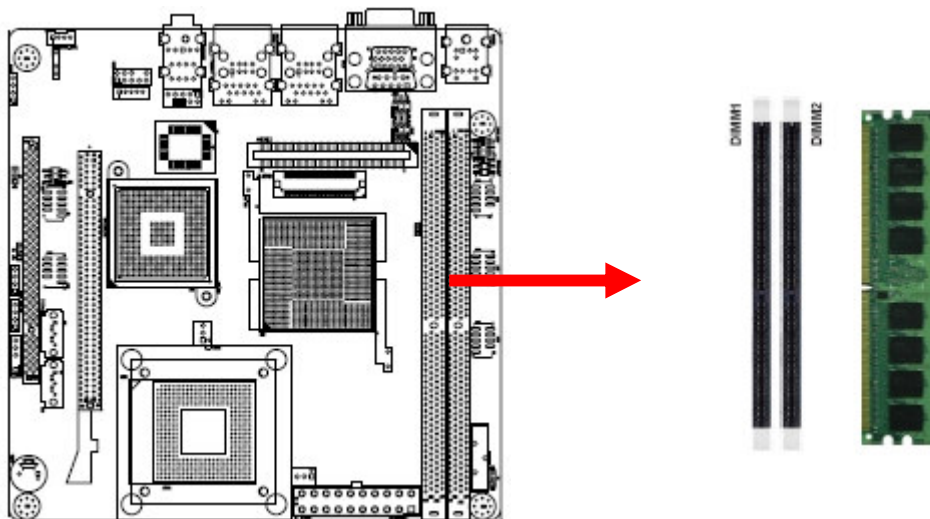



## 1.5.2 Memory Configurations

You can install 128 MB, 256 MB, 512 MB, 1GB and 2GB DDR2 SDRAM DIMMs into the SODIMM sockets using the memory configurations in this section.



- Installing DDR2 DIMM other than the recommended configurations may cause memory sizing error or system boot failure. Use any of the recommended configurations.
- For dual-channel configuration, the total size of memory module(s) installed per channel must be the same (DIMM1 = DIMM2).
- Always install DIMMs with the same CAS latency. For optimum compatibility, it is recommended that you obtain memory modules from the same vendor.
- Due to chipset resource allocation, the system may detect less than 1 GB system memory when you installed one 1 GB DDR2 memory modules.
- This motherboard does not support memory modules made up of 128 Mb chips or double-sided x16 memory modules. Make sure that the memory frequency matches the CPU FSB (Front Side Bus). Refer to the Memory frequency/CPU FSB synchronization table.



- Recommended memory configuration

Channel	Socket
Channel A	DIMM1
Channel B	DIMM2

- Memory frequency/CPU FSB synchronization

CPU FSB	DDR2 DIMM Type	Memory Frequency
533/667MHz	DDR2 533	Max clock Freq: 266MHZ; 533Mb/s
	DDR2 667	Max clock Freq: 333MHZ; 667Mb/s

### 1.5.3 Installing a DDR2 DIMM



Make sure to unplug the power supply before adding or removing DIMMs or other system components. Failure to do so may cause severe damage to both the motherboard and the components.

1. Unlock a DIMM socket by pressing the retaining clips outward
2. Align a DIMM on the socket such that the notch on the DIMM matches the break on the socket.
3. Firmly insert the DIMM into the socket until the retaining clips snap back in place and the DIMM.

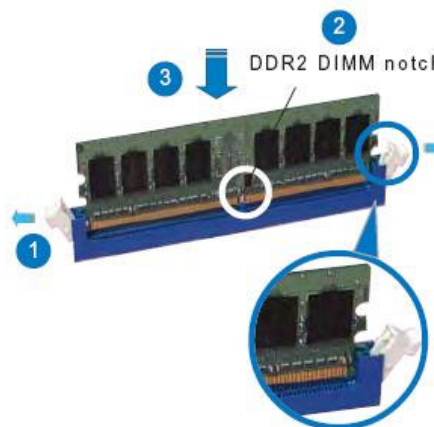

Unlocked retaining clip



- A DDR2 DIMM is keyed with a notch so that it fits in only one direction. DO NOT force a DIMM into a socket to avoid damaging the DIMM.
- The DDR2 DIMM sockets do not support DDR DIMMs. DO NOT install DDR DIMMs to the DDR2 DIMM socket.

### 1.5.4 Removing a DDR2 DIMM

1. Simultaneously press the retaining clips outward to unlock the DIMM.
2. Remove the DIMM from the socket.

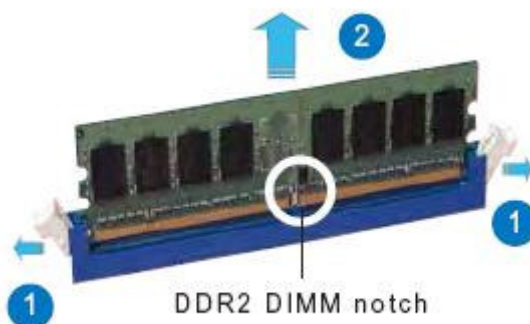

Support the DIMM lightly with your fingers when pressing the retaining clips. The DIMM might get damaged when it flips out with extra force.

## 1.6 Expansion Slots

In the future, you may need to install expansion cards. The following sub-sections describe the slots and the expansion cards that they support.



---

Make sure to unplug the power cord before adding or removing expansion cards. Failure to do so may cause you physical injury and damage motherboard components.

---

### 1.6.1 Installing an Expansion Card

1. Before installing the expansion card, read the documentation that came with it and make the necessary hardware settings for the card.
2. Remove the system unit cover (if your motherboard is already installed in a chassis).
3. Remove the bracket opposite the slot that you intend to use. Keep the screw for later use.
4. Align the card connector with the slot and press firmly until the card is completely seated on the slot.
5. Secure the card to the chassis with the screw you removed earlier.
6. Replace the system cover.

### 1.6.2 Configuring an Expansion Card

After installing the expansion card, configure it by adjusting the software settings.

1. Turn on the system and change the necessary BIOS settings if any.
2. Assign an IRQ to the card if needed. Refer to the tables on the next page.
3. Install the software drivers for the expansion card.

### 1.6.3 Standard Interrupt Assignments

IRQ	Priority	Standard Function
0	1	System Timer
1	2	Keyboard Controller
2	-	Redirect to IRQ#9
3	11	IRQ holder for PCI steering*
4	12	Communications Port (COM1)*
5	13	IRQ holder for PCI steering*
6	14	Floppy Disk Controller
7	15	Printer Port (LPT)*
8	3	System CMOS/Rear Time
9	4	IRQ holder for PCI steering*
10	5	IRQ holder for PCI steering*
11	6	IRQ holder for PCI steering*
12	7	PS/2 Compatible Mouse Port*
13	8	Numeric Data Processor
14	9	Primary IDE Channel
15	10	Secondary IDE Channel

\* These IRQs are usually available for ISA or PCI device.

#### 1.6.4 PCI Slots

MX945GM2 has one PCI slots. The PCI slots support cards such as a LAN card, SCSI card, USB card, and other cards that comply with PCI specifications. The figure shows a LAN card installed on a PCI slot.

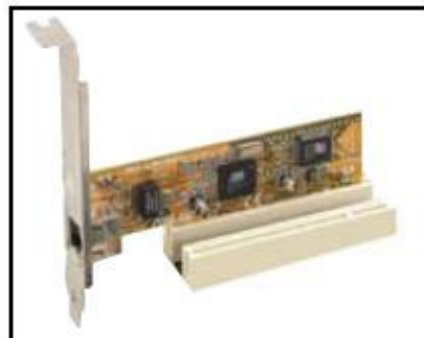

#### 1.6.5 PCI Express X16 Slot

This motherboard supports one PCI Express x16 graphic cards that comply with the PCI Express specifications. The following figure shows a graphics card installed on the PCI Express x16 slot.



#### 1.6.6 Mini PCI

This motherboard supports one Mini PCI slot. The Mini PCI was developed specifically for integrated communications peripherals such as modems and Network Interface Card.

## 1.7 Jumpers

### 1.7.1 Clear CMOS (J4)

This jumper allows you to clear the Real Time Clock (RTC) RAM in CMOS. You can clear the CMOS memory of date, time, and system setup parameters by erasing the CMOS RTC RAM data. The onboard button cell battery powers the RAM data in CMOS, which include system setup information such as system passwords. To erase the RTC RAM:

1. Turn OFF the computer and unplug the power cord.
2. Remove the onboard battery.
3. Move the jumper cap from pins 1-2 (default) to pins 2-3. Keep the cap on pins 2-3 for about 5~10 seconds, then move the cap back to pins 1-2.
4. Re-install the battery.
5. Plug the power cord and turn ON the computer.
6. Hold down the <Del> key during the boot process and enter BIOS setup to re-enter data.



Except when clearing the CMOS, never remove the cap on CLRRTC jumper default position. Removing the cap will cause system boot failure!

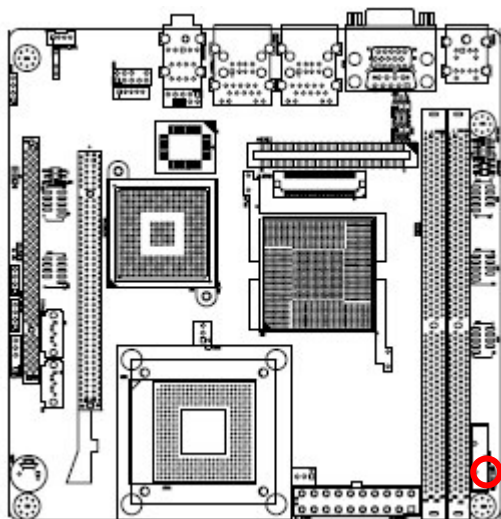

Normal (Default)



Clear CMOS



### 1.7.2 Watchdog Timer Output Select (J6)

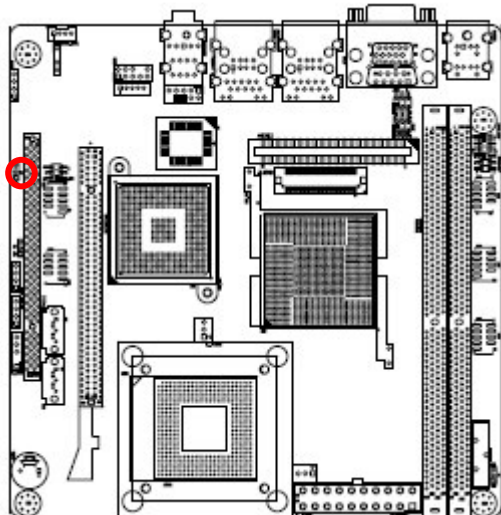

Enable



Disable



### 1.7.3 AT/ATX Power Select (J7)

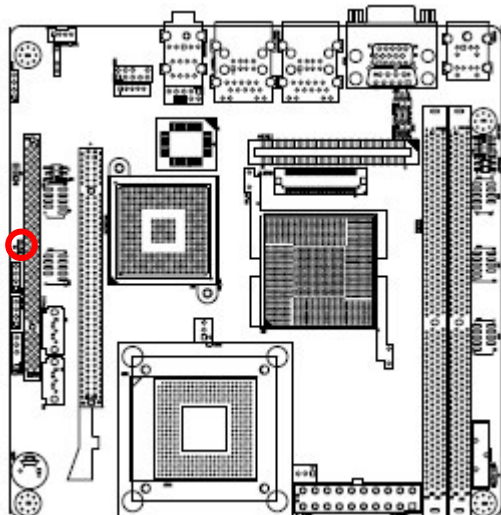

ATX \*



AT



1.7.4 LVDS Extended Setting (J14)

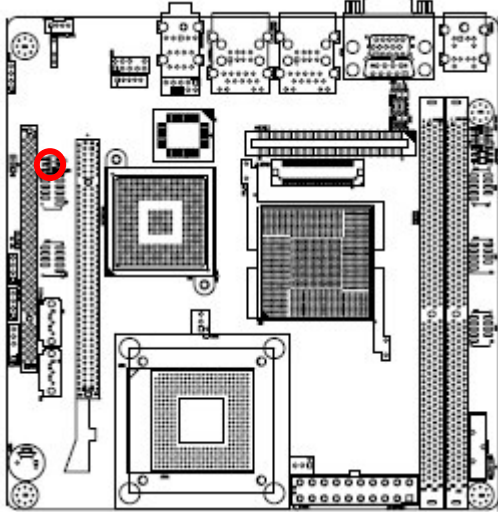

Enable \*

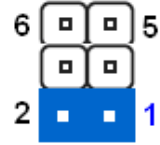

Disable

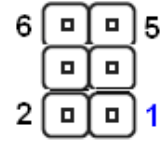

1.7.5 COM1, COM2 RI/+5V/+12v Selection (JP14, JP15)

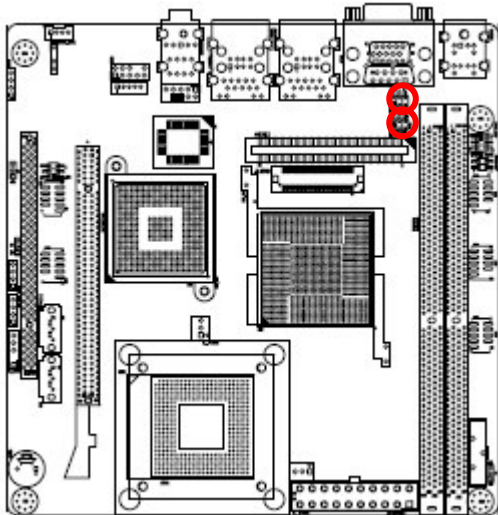

+12V \*

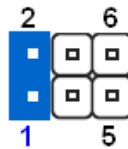

Ring

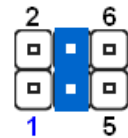

+5V

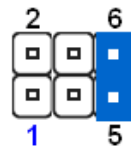



## 1.8 Connectors

### 1.8.1 Rear Panel Connectors

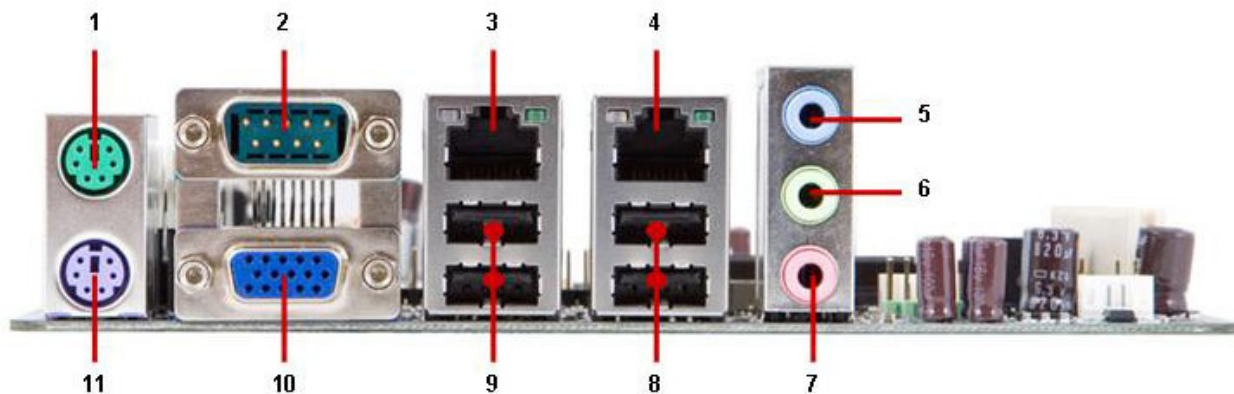

No	Label	Function	Description
1	CN10	PS/2 mouse connector	The standard PS/2 mouse DIN connector is for a PS/2 mouse.
2	CN1	Serial port connector	D-sub 9-pin, male
3, 4	CN3, CN2	LAN (RJ-45) connector	This port allows Gigabit connection to a Local Area Network (LAN) through a network hub. Refer to the table below for the LAN port LED indications. The optional 10/100 Mbps LAN controller allows 10/100 Mbps connection to a Local Area Network (LAN) through a network hub.

ACT/LINK LED      SPEED LED

LAN port

ACT / LINK LED		SPEED LED	
Status	Description	Status	Description
OFF	No link	OFF	10Mbps connection
Orange	Linked	ORANGE	100Mbps connection
Blinking	Data activity	GREEN	1Gbps connection

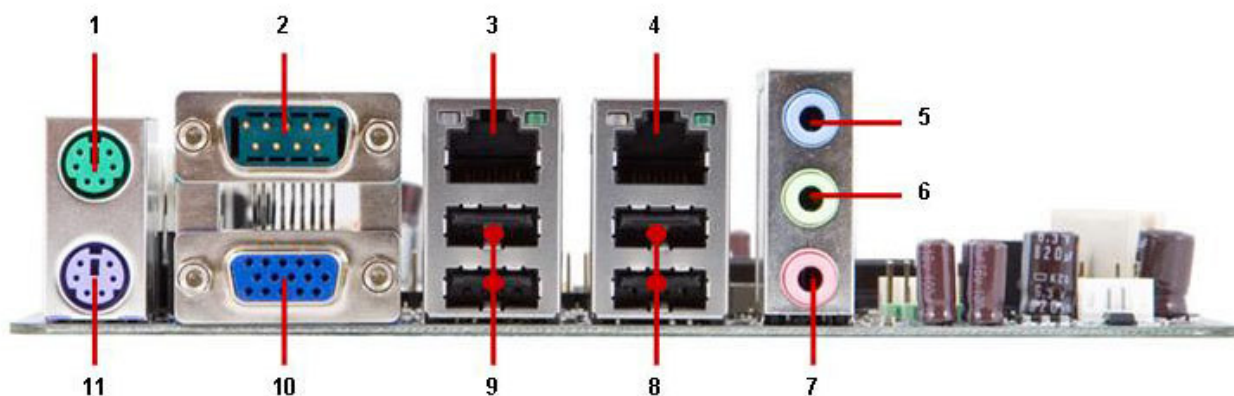

No	Label	Function	Description
5	AUDIO1	Line-In port (Light Blue).	This port connects a tape, CD, DVD player, or other audio sources.
6	AUDIO1	Line-Out port (Lime)	This port connects a headphone or a speaker. In 4-channel, 6-channel, and 8-channel configuration, the function of this port becomes Front Speaker Out.
7	AUDIO1	Microphone port (Pink)	This port connects a microphone.
8	CN2	USB 2.0 connector	These four 4-pin Universal Serial Bus (USB) ports are available for connecting USB 2.0 devices.
9	CN3	USB 2.0 connector	These four 4-pin Universal Serial Bus (USB) ports are available for connecting USB 2.0 devices.
10	CN1	VGA port	This 15-pin port is for a VGA monitor or other VGA-compatible devices.
11	CN10	PS/2 KB connector	This port is for a PS/2 keyboard

### 1.8.2 ATX Power Connector (ATX\_PWR1)

This connector is for an ATX Micro-Fit power supply. The plugs from the power supply are designed to fit these connectors in only one orientation. Find the proper orientation and push down firmly until the connectors completely fit.

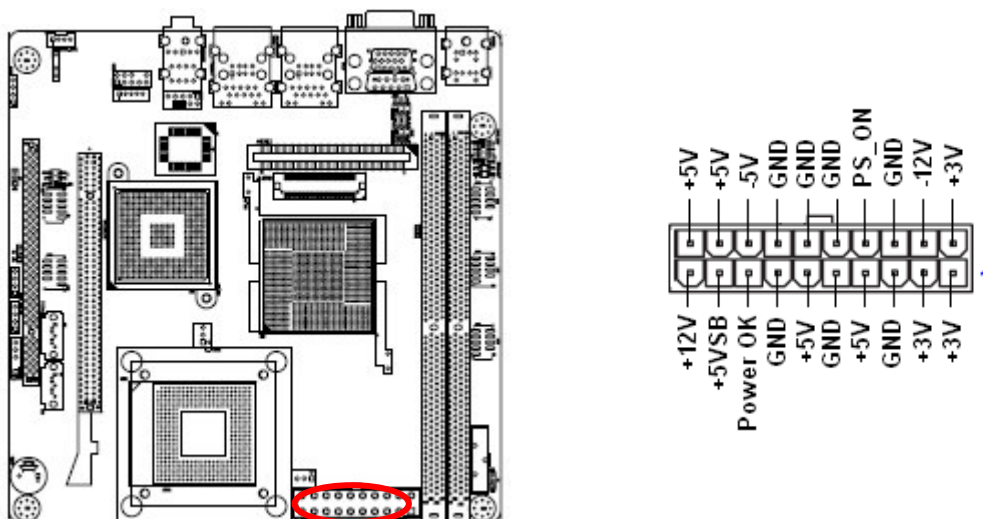

#### Important notes on the Motherboard Power Requirements



- Make sure that your ATX 12V power supply can provide 8A on the +12V lead and at least 1A on the +5-volt standby lead (+5VSB). The minimum recommended wattage is 230W, or 300W for a fully configured system. The system can become unstable and might experience difficulty powering up if the power supply is inadequate.
- You must install a PSU with a higher power rating if you intend to install additional devices.

### 1.8.3 USB 2.0 Connector (CN4, CN5)

These connectors are for USB 2.0 ports. Connect the USB/GAME module cable to any of these connectors, then install the module to a slot opening at the back of the system chassis. These USB connectors comply with USB 2.0 specification that supports up to 480 Mbps connection speed.

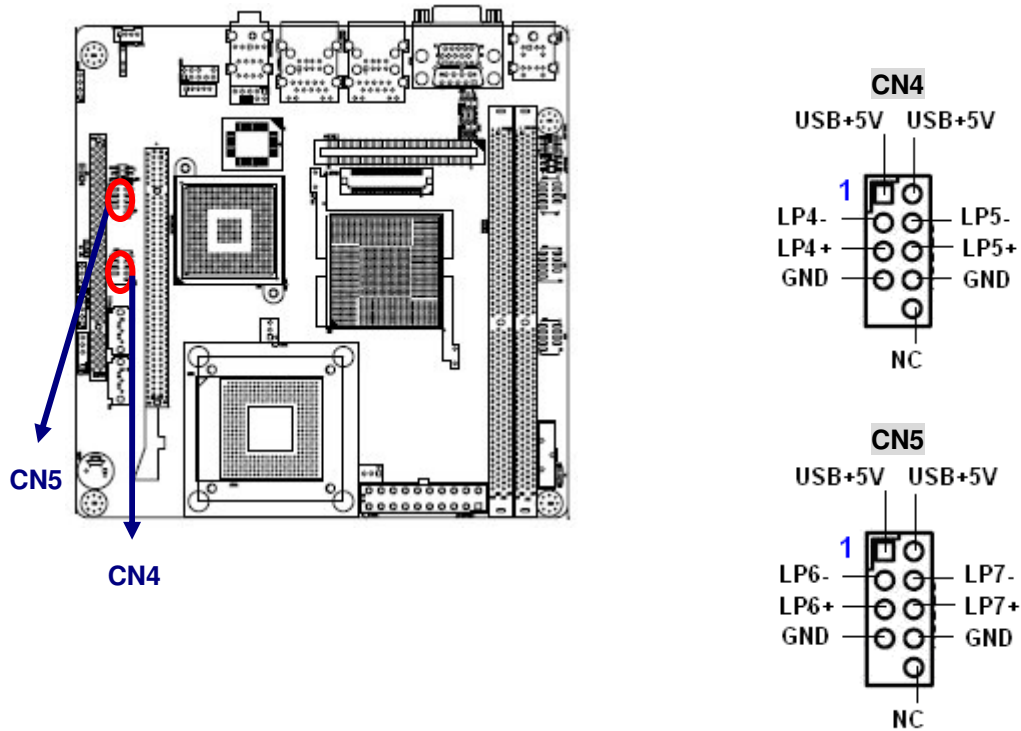

---

Never connect a **1394 cable** to the USB connectors. Doing so will damage the motherboard!

---



---

The USB module is purchased separately.

---

### 1.8.4 Serial Port 2 Connector (CN6)

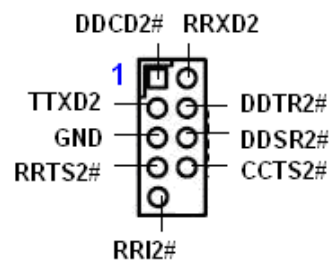
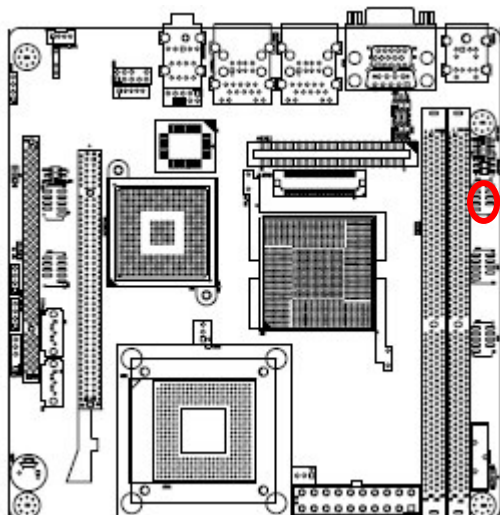

### 1.8.5 Serial Port 3 Connector (CN7)

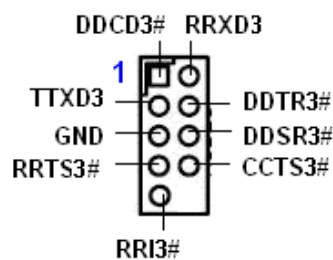
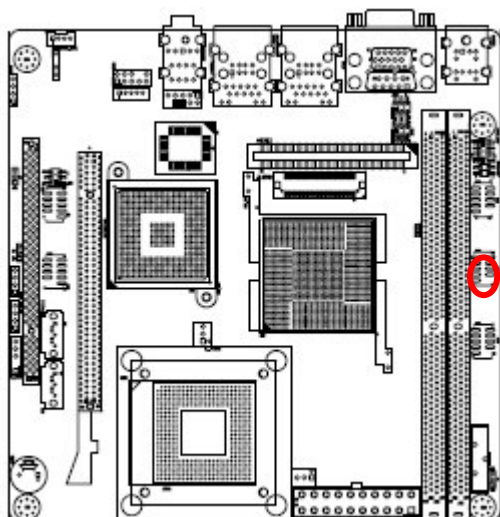

**1.8.6 Serial Port 4 Connector (CN8)**

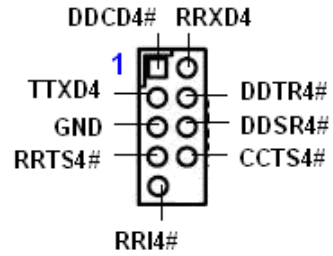
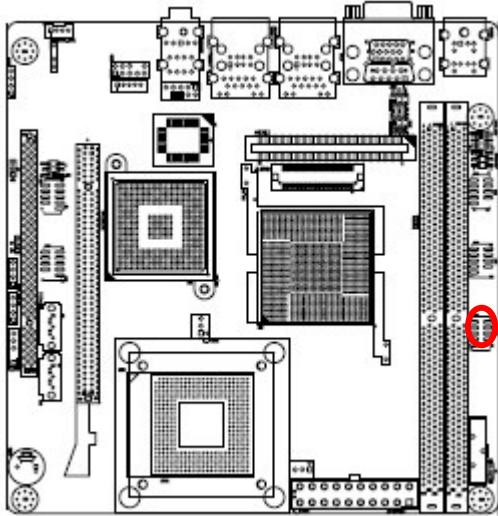

**1.8.7 Front Panel Audio Connector (CN16)**

This connector is for a chassis-mounted front panel audio I/O module that supports either HD Audio or legacy AC '97 (optional) audio standard. Connect one end of the front panel audio I/O module cable to this connector.

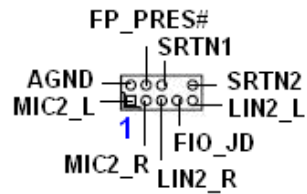
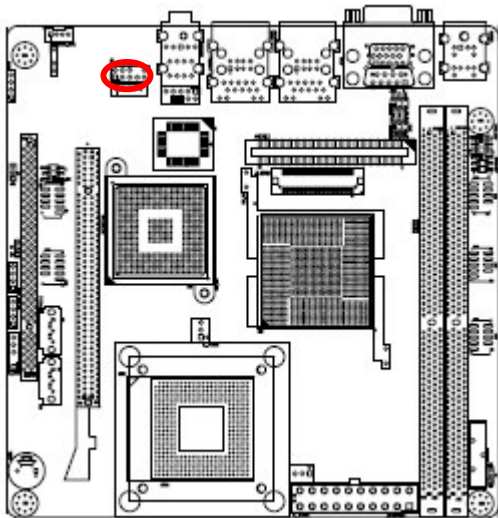

For motherboards with the optional HD Audio feature, we recommend that you connect a high-definition front panel audio module to this connector to avail of the motherboard's high-definition audio capability.



### 1.8.8 Case Open and Speaker Out Connector (CN19)

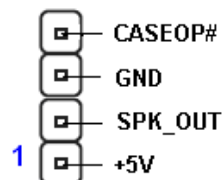
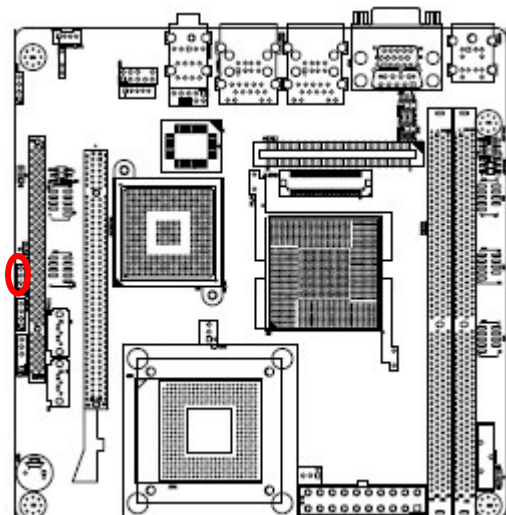

### 1.8.9 CPU Fan Connector (C\_FAN1)

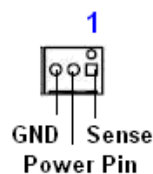
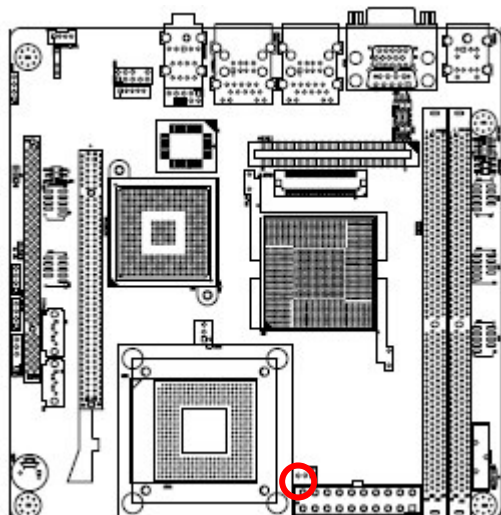

- Do not forget to connect the fan cables to the fan connectors. Insufficient air flow inside the system may damage the motherboard components, and hardware monitoring errors can occur if you fail to plug this connector.
- These are not jumpers! DO NOT place jumper caps on the fan connectors.

### 1.8.10 System Panel Connector (F\_PANEL1)

This connector supports several chassis-mounted functions.

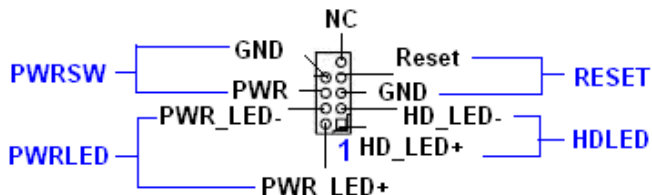
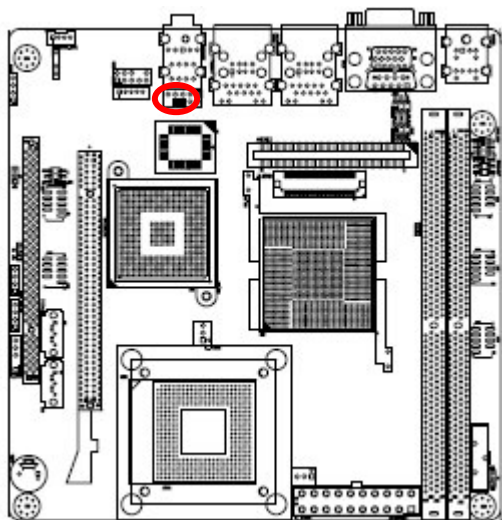

- **System Power LED (2-pin PWRLED)**  
This 2-pin connector is for the system power LED. Connect the chassis power LED cable to this connector. The system power LED lights up when you turn on the system power, and blinks when the system is in sleep mode.
- **ATX Power Button/Soft-off Button (2-pin PWRSW)**  
This connector is for the system power button. Pressing the power button turns the system on or puts the system in sleep or soft-off mode depending on the BIOS settings. Pressing the power switch for more than four seconds while the system is ON turns the system OFF.
- **Hard Disk Drive Activity LED (2-pin HDLED)**  
This 2-pin connector is for the HDD Activity LED. Connect the HDD Activity LED cable to this connector. The IDE LED lights up or flashes when data is read from or written to the HDD.
- **Reset Button (2-pin RESET)**  
This 2-pin connector is for the chassis-mounted reset button for system reboot without turning off the system power.



### 1.8.11 Primary IDE Connector (IDE1)

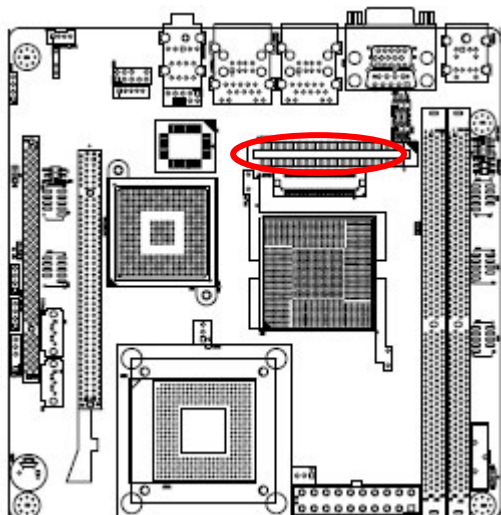

- Orient the red markings (usually zigzag) on the IDE cable to Pin 1.

### 1.8.12 IrDA Connector (IR\_CON1)

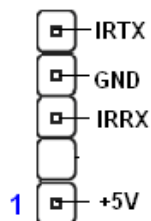
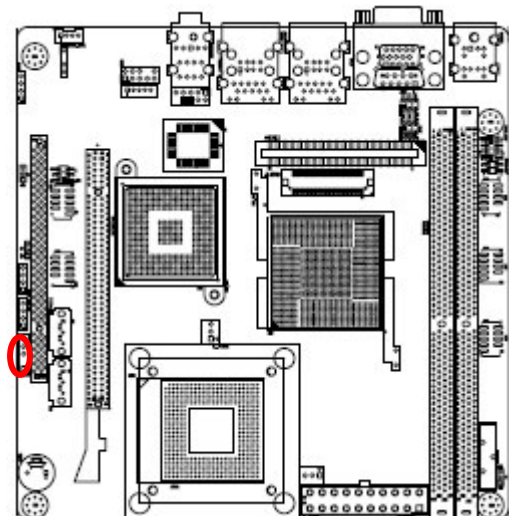

- **Signal Description**

Signal	Signal Description
IRRX	Infrared Receiver Input
IRTX	Infrared Transmitter Output

### 1.8.13 Amplifier Connector (JAMP1)

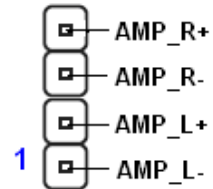
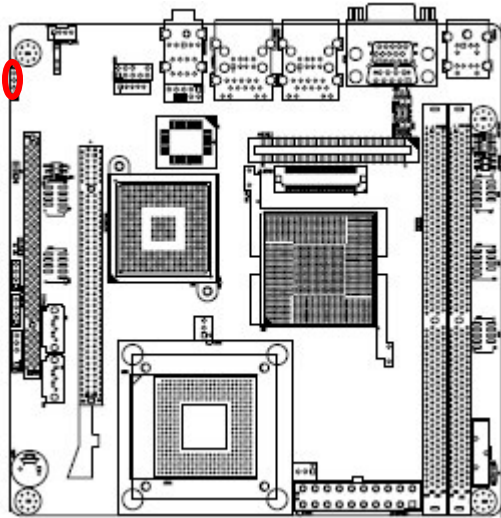

### 1.8.14 Optical Drive Audio Connector (JCD1)

This connector is for the 4-pin audio cable that connects to the audio connector at the back of the optical drive

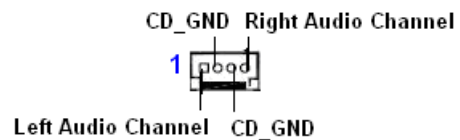
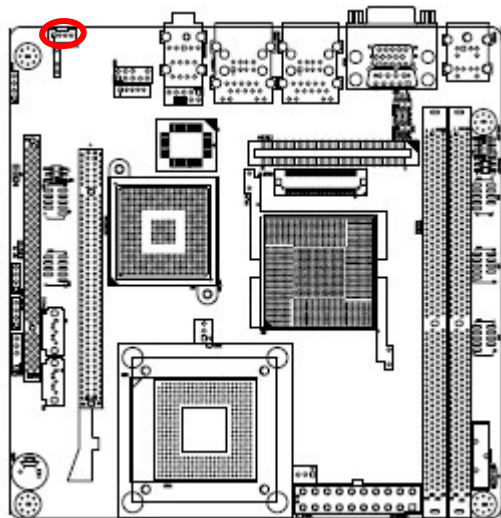



---

Enable the CD-IN function in the audio utility when using this connector.

---

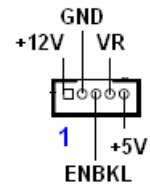
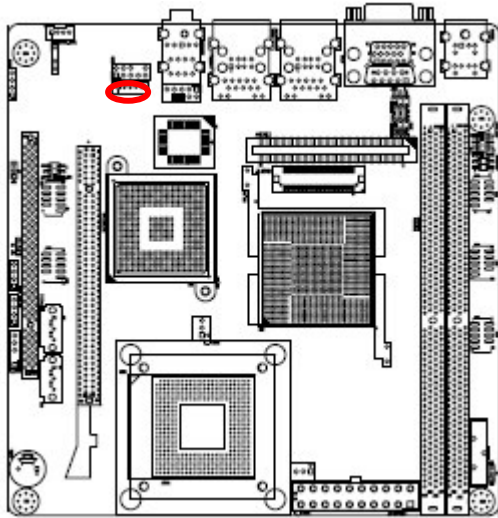
### 1.8.15 LCD Inverter Connector (JBKL1)



● **Signal Description**

Signal	Signal Description
VR	<p>For inverter with adjustable Backlight function, it is possible to control the LCD brightness through the <b>VR</b> signal.</p> <div style="text-align: center;"> </div> <p><math>V_{adj}=0.75V \sim 4.25V</math> (Recommended: <math>4.7K\Omega</math>, <math>&gt; 1/16W</math>)</p>
ENBKl	LCD backlight ON/OFF control signal

### 1.8.16 Digital I/O Connector (JGPIO1)

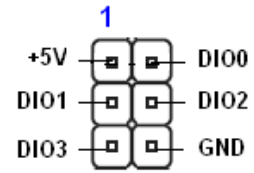
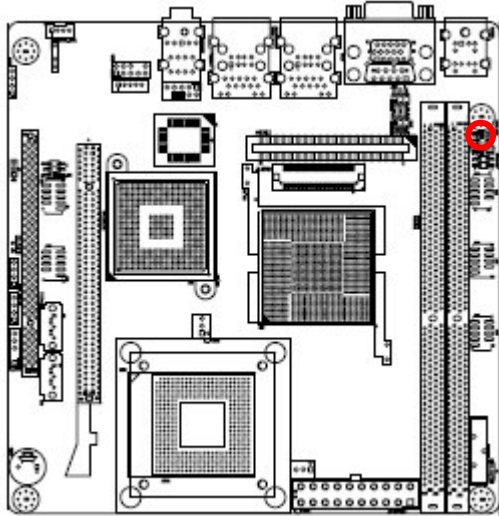

### 1.8.17 Digital I/O Connector (JGPIO2)

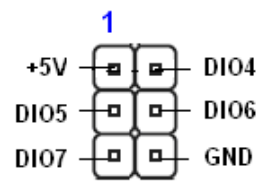
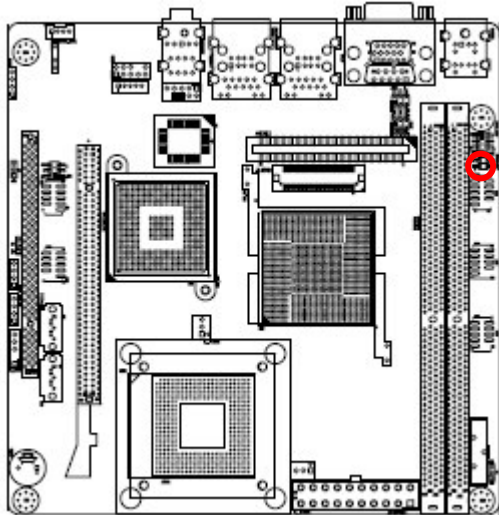

### 1.8.18 LVDS Connector (JLVDS1)

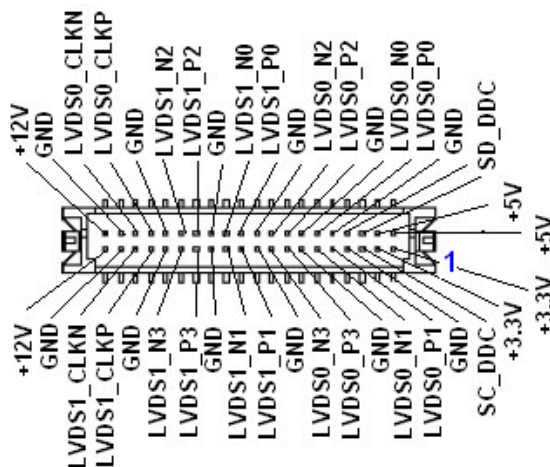
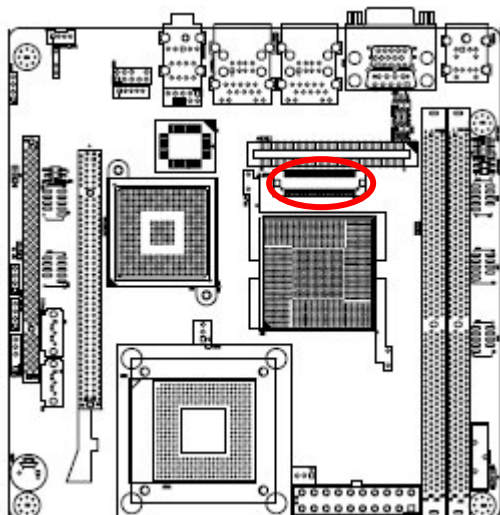

### 1.8.19 Serial ATA Connector [Black] (SA1, SA2)

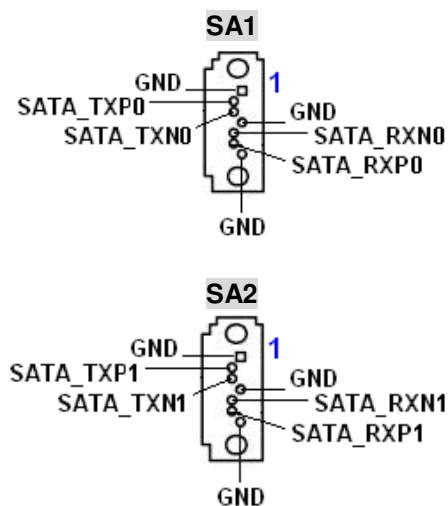
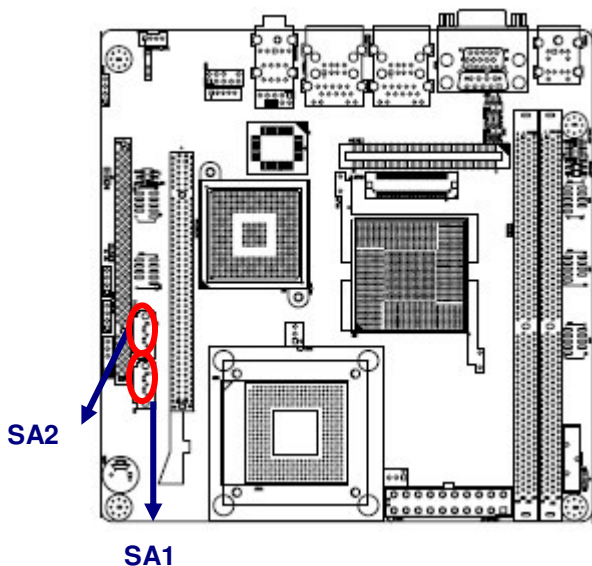

- Install the Windows® 2000 Service Pack 4 or the Windows® XP Service Pack1 before using Serial ATA.
- When using the connectors in Standard IDE mode, connect the primary (boot) hard disk drive to the SATA1 connector.



### 1.8.20 SM Bus Connector (SM\_BUS1)

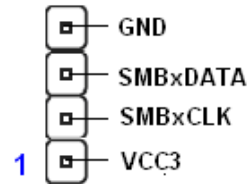
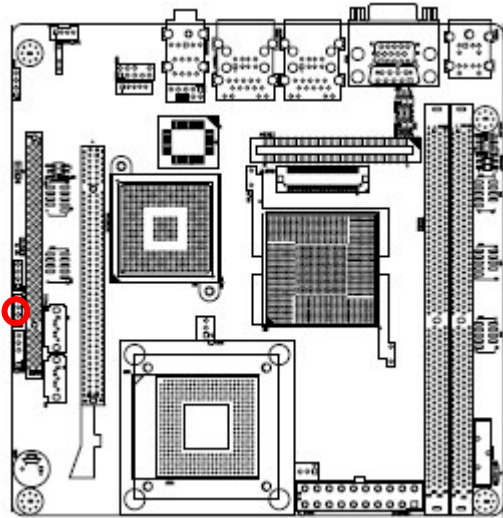

### 1.8.21 Digital Audio Connector (SPDIF\_OUT1)

This connector is for an additional Sony/Philips Digital Interface (S/PDIF) port(s). Connect the S/PDIF module cable to this connector, then install the module to a slot opening at the back of the system chassis.

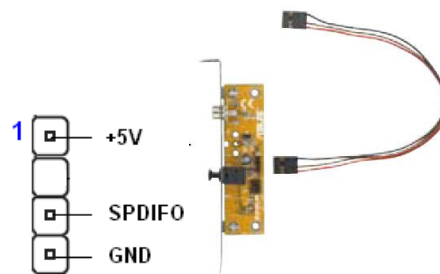
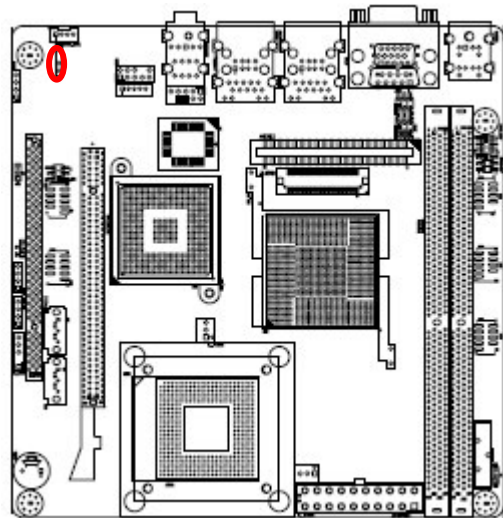



---

The S/PDIF module is purchased separately.

---

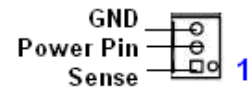
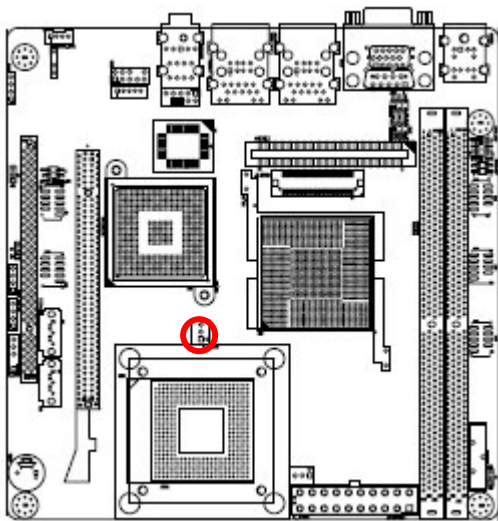
### 1.8.22 Chassis Fan Connector (S\_FAN1)



## Free Manuals Download Website

<http://myh66.com>

<http://usermanuals.us>

<http://www.somanuals.com>

<http://www.4manuals.cc>

<http://www.manual-lib.com>

<http://www.404manual.com>

<http://www.luxmanual.com>

<http://aubethermostatmanual.com>

Golf course search by state

<http://golfingnear.com>

Email search by domain

<http://emailbydomain.com>

Auto manuals search

<http://auto.somanuals.com>

TV manuals search

<http://tv.somanuals.com>