

LV-671

Mini-ITX Motherboard

User's Manual

Edition: 1.41

2005/03/24





DECLARATION OF CONFORMITY

We herewith confirm the following designated product

Single Board Computer Model No.: LV-671

(Product Identification)

has been tested and found to comply with the requirements set up in the council directive on the approximation of the law of member states relating to the EMC Directive 89/336/EEC, amended by 92/31/EEC & 93/68/EEC. For the evaluation regarding to the electromagnetic compatibility, the following standards were applied:

- | | |
|--|------------------------------------|
| * EN 55022:1998+A1:2000+A2:2003, Class B | * EN 55024:1998+A1:2001+A2:2003 |
| * EN 61000-3-2 edition 2:2000 | IEC 61000-4-2:1995+A1:1998+A2:2001 |
| * EN 61000-3-3:1995+A1:2001 | IEC 61000-4-3:2002+A1:2002 |
| | IEC 61000-4-4:1995+A1:2001+A2:2001 |
| | IEC 61000-4-5:1995+A1:2001 |
| | IEC 61000-4-6:1996+A1:2001 |
| | IEC 61000-4-8:1993+A1:2001 |
| | IEC 61000-4-11:1994+A1:2001 |

(Identification of regulations / standards)

This declaration is the responsibility of the manufacturer / importer

TAIWAN COMMATE COMPUTER INC.
8F, NO. 94, SEC. 1, SHIN TAI WU RD.,
HSI CHIH, TAIPEI HSIEN,
TAIWAN, R.O.C.

(Name / Address)

MANUFACTURER / IMPORTER

TEST LABORATORY

This declaration is based on the test report (Ref. No. AD4061507) issued by SRT Lab., Inc. on July 05, 2004. The Declaration of Conformity has not yet included the test standard, EN 60950 which is applied to the product and required by Low Voltage Directive 73/23/EEC.

(Name)

James Lee
(Johnson Ho, Director)

(Date)

July 05, 2004

(Date)

SPECTRUM RESEARCH & TESTING LABORATORY, INC.

NO. 101-10, LING 8, SHAN-TONG LI, CHUNG-LI CITY, TAOYUAN, TAIWAN, R.O.C. TEL: (03)498-7884 FAX: (03)498-0328



DECLARATION OF CONFORMITY

We herewith confirm the following designated product

Single Board Computer Model No.: LV-671

(Product Identification)

has been tested and found to comply with the requirements of 47 CFR PART 15 regulation & ANSI C63.4 for the evaluation of Class B of electromagnetic compatibility.

This device complies with Part 15 of the FCC rules, operation is subject to the following two conditions.

- (1) This device may not cause harmful interference and,
- (2) This device must accept any interference received,
including interference that may cause undesired operation .

(Identification of regulations / standards)

This declaration is the responsibility of the manufacturer / importer

**TAIWAN COMMATE COMPUTER INC.
8F, NO. 94, SEC. 1, SHIN TAI WU RD.,
HSI CHIH, TAIPEI HSIEN,
TAIWAN, R.O.C.**

(Name / Address)

MANUFACTURER / IMPORTER

TEST LABORATORY

This declaration is based on the test report (Ref. No. A04061507) issued by SRT Lab., Inc. on July 05, 2004.

(Name)

(Johnson Ho, Director)

(Date)

July 05, 2004

(Date)

SPECTRUM RESEARCH & TESTING LABORATORY, INC.

NO. 101-10, LING 8, SHAN-TONG LI CHUNG-LI CITY, TAOYUAN, TAIWAN, R.O.C. TEL: (03)498-7884 FAX: (03)498-6528

Copyright

Copyright© 2003 - 2004. All rights reserved. This document is copyrighted and all rights are reserved. The information in this document is subject to change without prior notice to make improvements to the products.

This document contains proprietary information and protected by copyright. No part of this document may be reproduced, copied, or translated in any form or any means without prior written permission of the manufacturer.

All trademarks and/or registered trademarks contains in this document are property of their respective owners.

Disclaimer

The company shall not be liable for any incidental or consequential damages resulting from the performance or use of this product.

The company does not issue a warranty of any kind, express or implied, including without limitation implied warranties of merchantability or fitness for a particular purpose.

The company has the right to revise the manual or include changes in the specifications of the product described within it at any time without notice and without obligation to notify any person of such revision or changes.

Trademark

All trademarks are the property of their respective holders.

Any questions please visit our website at <http://www.commell.com.tw>.

Packing List

Please check the package before you use this product

Hardware:

LV-671 Mini-ITX motherboard x 1

Cable Kit:



40-pin ATA100 IDE Cable x 1



26-pin Slim Type Floppy Cable x 1



4-pin to 4-pin Power Cable x 1

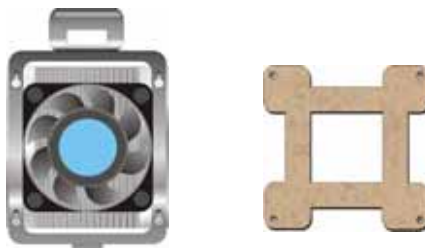

CPU Cooler x 1

Other Accessories

Driver CD x 1

User's Manual x 1

Index

Chapter 1 <Introduction>	9
1.1 <Product Overview>.....	9
1.2 <Product Specification>	10
1.3 <Component Placement>	13
1.4 <Block Diagram>.....	14
Chapter 2 <Hardware Setup>	15
2.1 <Connector Location>.....	15
2.2 <Jumper Reference>	16
2.3 <Connector Reference>.....	17
2.3.1 <Internal Connector>.....	17
2.3.2 <External I/O connector>	17
2.4 <System Setup>.....	18
2.4.1 <CPU Installation>.....	18
2.4.2 <Memory Installation>	19
2.4.3 <CPU Cooler Installation>	20
2.5 <CMOS Setup>	21
2.6 <IDE Interface>	22
2.7 Compact Flash Interface	23
2.8 <Display Interface>	24
2.8.1 <Analog display interface>	24
2.8.2 <Digital display interface>	24
2.9 <Audio Interface>.....	28
2.10 <Ethernet Interface>	30
2.11 <Power and Fan connector>	31
2.12 <GPIO Interface>	33
2.13 <Expansive Interface>	34
2.14 <Switch and Indicator>.....	35

Chapter 3 <System Setup>	37
3.1 <Watchdog Timer Setting>.....	37
3.2 <Audio Setting>.....	38
3.3 <Display Device Setup>.....	39
Chapter 4 <BIOS Setup>	43
Appendix A <I/O Port Pin Assignment>	45
A.1 <IDE Port>	45
A.2 <Floppy Port>	47
A.3 < USB Interface >	47
A.4 <IrDA Port>	48
A.5 < VGA Port >.....	48
A.6 < LAN Port >	48
A.7 < Serial Port >	49
Appendix B <Flash BIOS>	51
B.1 <Flash Tool>	51
B.2 <Flash BIOS Procedure>.....	51
Appendix C <System Resource>	53
C.1 <I/O Address Map>.....	53
C.2 <Memory Address Map>	55
C.3 <System IRQ and DMA Resource>.....	56
Contact Information	58

(This Page is Left for Blank)

Chapter 1 <Introduction>

1.1 <Product Overview>

LV-671 is an all-in-one industrial compact Pentium-M level motherboard based on Mini-ITX form factor at 170 x 170 mm of dimension. Based on Intel **855GME** and **ICH4** chipset, **LV-671** offers the compact, embedded, value and high performance solution with Intel Pentium-M CPU, 400MHz of FSB, 1GBytes DDR200/266/333 SDRAM with ECC, Intel 855GME GMCH built-in Intel Extreme Graphics 2, Intel PRO/1000+ LAN, Hi-Speed USB 2.0, 5.1 channel and S/P DIF 3D audio, **18/24-bit** dual channel LVDS, GPIO and embedded flash disk interfaces.

Low Power Consumption Solution

Based on Intel 855GME chipset and Intel Pentium M/Celeron M processor, the board requires lower power consumption than Pentium 4 –M processors. The Intel Pentium M integrates 512KB/1MB/2MB of L2 cache, so it provides better performance than before.

Dual Display Architecture

Intel 855GME supports two DAC for display interface; users can apply two display devices for dual display clone or extended desktop display. With this feature, system integrator can use this board for Kiosk, ATM, or industrial control machines.

5.1 Channel AC97 Audio

LV-671 integrates a REALTEK 5.1 channel AC97 codec; users can enjoy the live surround sound through 5.1 channel speakers. **LV-671** also has an S/PDIF jack for digital sound outputting.

Hi-Speed USB 2.0 Interface

Intel ICH4 built-in Hi-Speed USB 2.0 controller let **LV-671** offer up to 480Mbps of transferring rate.

Card Bus and Embedded Flash Disk

The **LV-671** support PCMCIA Type I/II enable you can simply use the wireless LAN module or other extended devices, the Compact Flash interface and IDE1 with DOM support can let you port any embedded system onboard.

Mini-PCI and Mini-AGP interface

With Mini-PCI interface, users can add a wireless LAN module or video capture module for powerful communication solutions. With Mini-AGP interface, users can apply the AGP graphic card or additional video output module such as HDTV or DVI.

1.2 <Product Specification>

General Specification

Form Factor	Mini-ITX motherboard at 170 x 170 mm (L x W)
CPU	Package: 478 pin PGA/ 479 pin BGA L2 Cache: 512KB/1MB/2MB FSB: 400MHz (The Intel® Celeron® M Processor 4xx series have been designed to work with the Mobile Intel® 945 Express Chipset Family only .)
Memory	1GBytes DDR200/266/333 SDRAM on one 184-pin DIMM socket ECC memory is supported
Chipset	Intel 82855GME GMCH and 82801DB ICH4
BIOS	Phoenix-Award v6.00PG 4Mb PnP flash BIOS
Green Function	Power saving mode includes doze, standby and suspend modes. ACPI version 1.0 and APM version 1.2 compliant
Watchdog Timer	System reset programmable watchdog timer with 1 ~ 255 sec./min. of timeout value
Real Time Clock	Intel ICH4 built-in RTC with lithium battery
Enhanced IDE	PCI enhanced IDE interface supports dual channels and up to 4 ATAPI devices at UltraATA/100 One 40-pin and one 44-pin IDE port DiskOnModule (DOM) embedded flash disk up to 1GBytes

Multi-I/O Port

Chipset	Intel 82801DB ICH4 (USB) and Winbond W83627HF-AW LPC Super I/O controller
Serial Port	Two external RS-232 serial port with 16C550 compatible UART and 16 bytes FIFO
USB Port	Six Hi-Speed USB 2.0 ports with 480 Mbps of transfer rate Two external and four internal USB ports
Parallel Port	One external bi-direction parallel port with SPP/ECP/EPP mode
Floppy Port	One slim-type FDD port supports up to two FDD
IrDA Port	One IrDA compliant Infrared interface supports SIR
K/B & Mouse	External PS/2 keyboard and mouse ports on rear I/O panel
GPIO	One 20-pin Digital I/O connector with 15-bit programmable I/O interface

Card Bus

PCMCIA	One PCMCIA Type I/II slot
--------	---------------------------

VGA Display Interface

Chipset	Intel 855GME GMCH built-in Intel Extreme Graphics 2 With 266 MHz VGA core and 256-bit 3D engine
---------	--

Frame Buffer	Intel DVMT (Dynamic Video Memory Technology) 2.0 up to 64Mbytes shared with system*
Display Type	CRT and LCD monitors for analog display 24-bit single/dual channel LCD panel for digital display
Connector	External DB15 female connector on rear I/O panel Internal 40-pin LVDS connector

*Under Windows 98/ME/2000/XP/Server2003 or Linux kernel 2.4 later

Ethernet Interface

Chipset	Intel PRO/1000+ LAN interface with Intel 82540EM
Type	10Base-T / 100Base-TX/1000Base-T, auto-switching Fast Ethernet Full duplex, IEEE802.3U compliant
Connector	External RJ45 connector with LED on rear I/O panel

Audio Interface

Chipset	Intel ICH4 with REALTEK ALC655 AC97 3D audio codec
Interface	5.1 channel 3D audio with front (R/L), rear (R/L), center and bass Optical Fiber digital audio encoding signal output
Connector	Optional external three phone jack for 5.1 channel audio onboard External Amplified Speaker output jack on rear panel External SPDIF connector on rear panel Internal 10-pin header for line-in/-out, MIC-out, 4-pin header for CD-in

Solid State Disk Interface

Flash Type	Compact Flash Type-I for Compact Flash Card or IBM Micro Drive
Capacity	Up to 1GB flash memory

Expansion Interface

Slim PCI Slot	One slim type PCI slot supports up to 2 bus master PCI 32-bit, 33MHz
Mini-PCI	One Mini-PCI type B socket with 32-bit, 33MHz for LV-671MP series
Mini-AGP	One Mini-AGP socket with 4x AGP bus for LV-671MA series

Power and Environment

Power Requirement	One external 19V/12V (auto switching) DC Adapter connector on rear panel 4-pin onboard 12V P4 4-pin power connector (Two power resources selectable for each)
Input Voltage Range	11V ~ 13V for 12V power supply 16V ~ 20V for 19V power supply
Input Current	12V/60W (with one 5.25" CDROM and 3.5" HDD) 19V/60W (with one 5.25" CDROM and 3.5" HDD)
Dimension	170 (L) x 170 (H) mm, Mini-ITX form factor
Temperature	Operating within 0 ~ 60°C (32 ~ 140°F) Storage within -20 ~ 85°C (-4 ~ 185°F)

Ordering Code

LV-671-MA	Mini-ITX Socket 479 Pentium-M processor Motherboard with Intel Extreme VGA, LAN, 5.1-CH/SPDIF Audio, Hi-Speed USB 2.0, mini-AGP socket and LVDS interface.
LV-671-MP	Mini-ITX Socket 479 Pentium-M processor Motherboard with Intel Extreme VGA, LAN, 5.1-CH/SPDIF Audio, Hi-Speed USB 2.0, mini-PCI socket and LVDS interface.
LV-671-MAPM11	Same as LV-671-MA and with onboard Intel Pentium M 1.1GHz processor for ULV/LV version.
LV-671-MPPM11	Same as LV-671-MP and with onboard Intel Pentium M 1.1GHz processor for ULV/LV version.
LV-671-MACM6	Same as LV-671-MA and with onboard Intel Celeron M 600MHz processor for ULV/LV version.
LV-671-MPCM6	Same as LV-671-MP and with onboard Intel Celeron M 600MHz processor for ULV/LV version.

For further product information please visit the website at <http://www.comnell.com.tw>

1.3 <Component Placement>

1 x 184-pin DDR266/333 DIMM up to 1GB

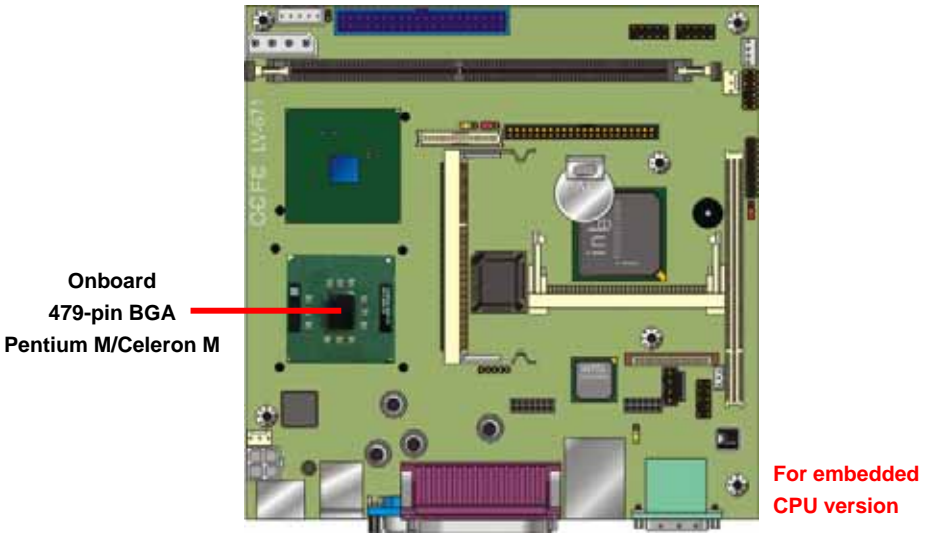
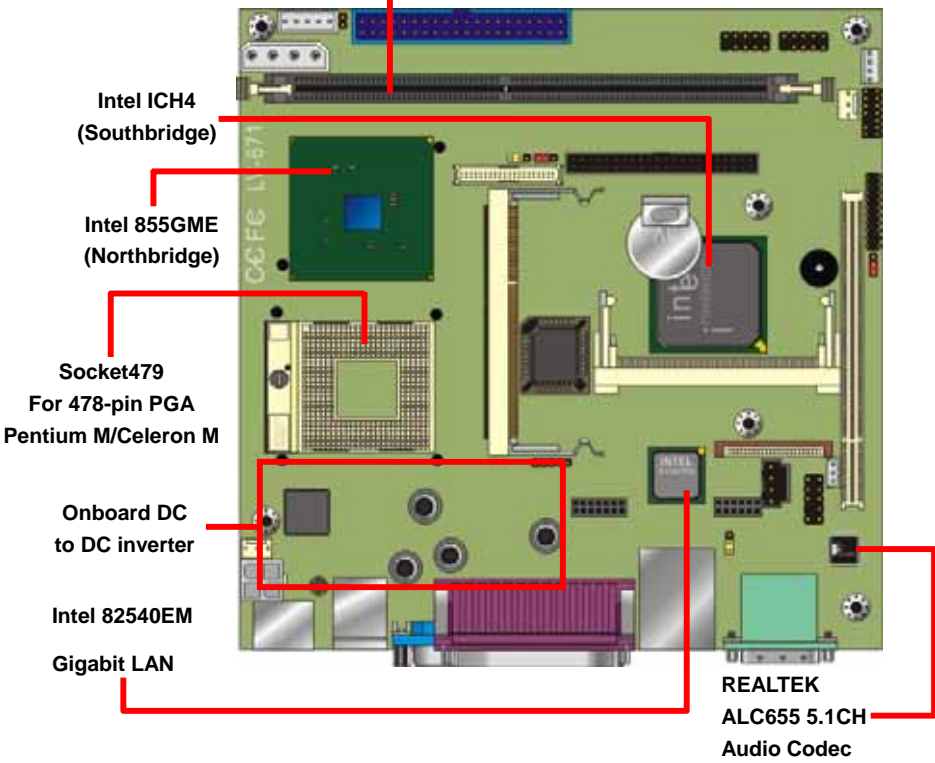

1.4 <Block Diagram>

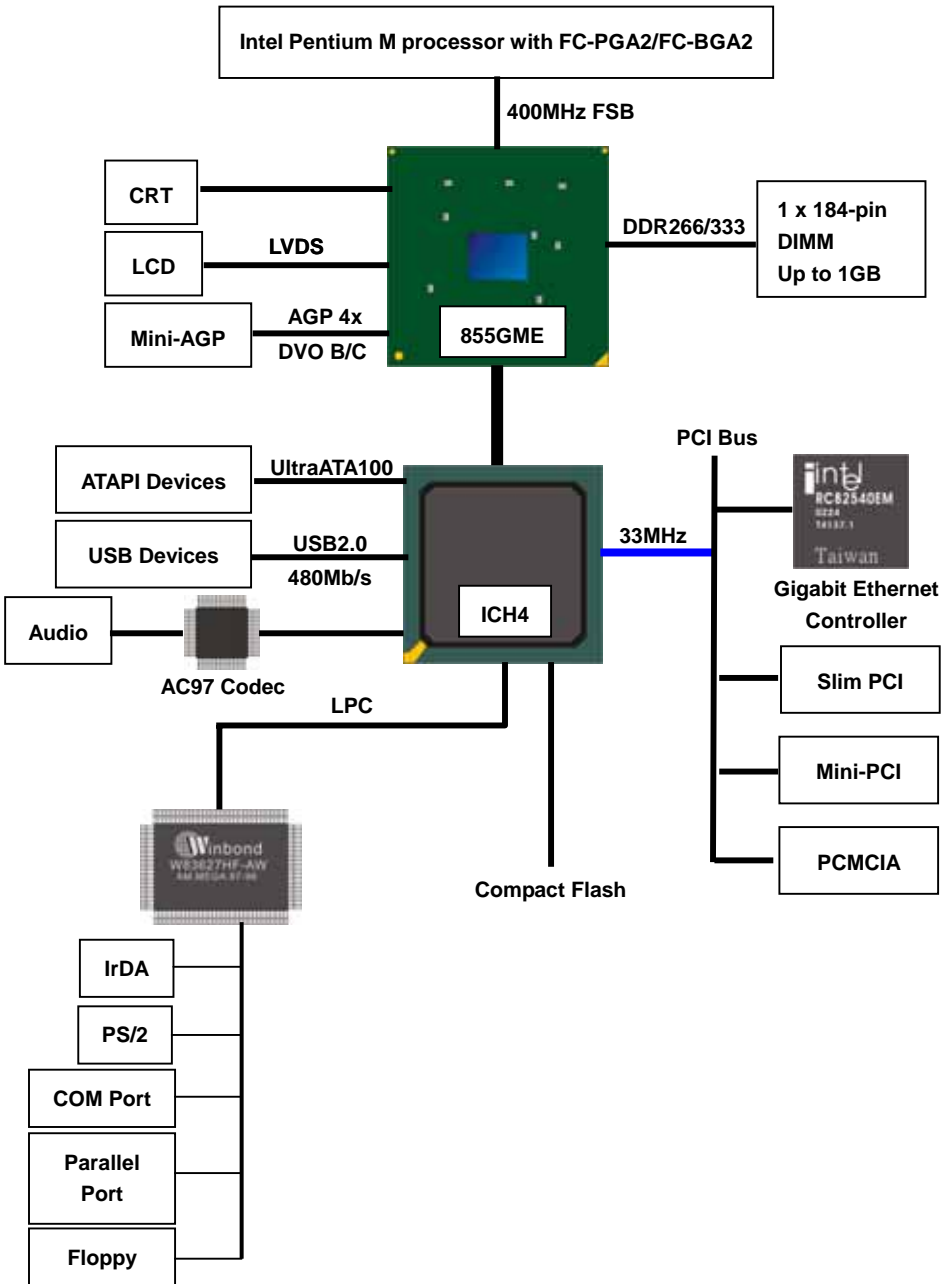

Chapter 2 <Hardware Setup>

This chapter contains the information for installation of hardware. The install procedure includes jumper settings, CPU and memory installation, fan, I/O and panel connections.

2.1 <Connector Location>

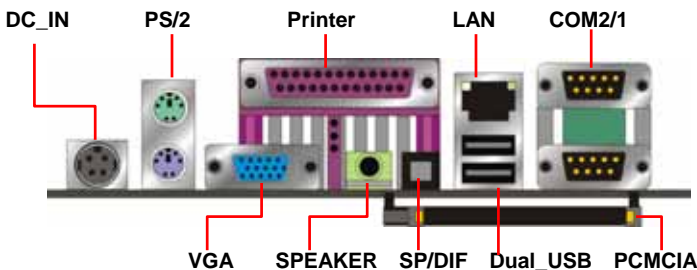
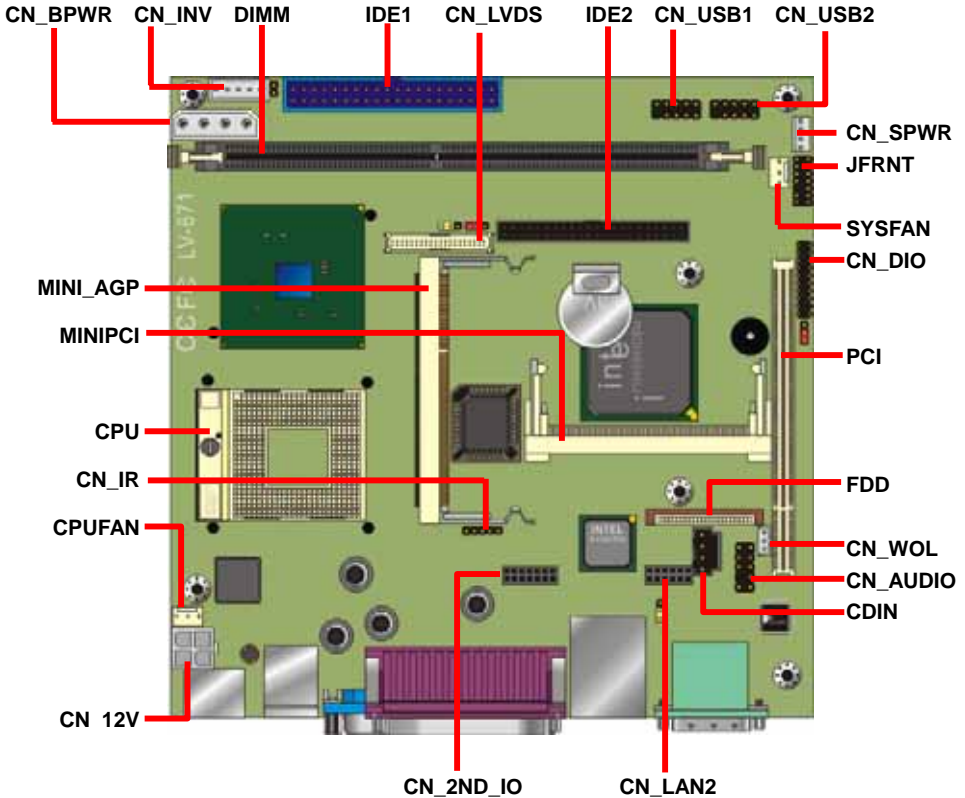

2.2 <Jumper Reference>

Jumper	Function
JRTC	COMS Operate / Clear Setting
JLAN	LAN1 Enable/Disable
JVLCD	LCD Panel Voltage Setting
JCFSEL	Compact Flash Address Setting
JDOM	IDE1 5V Voltage Enable/Disable

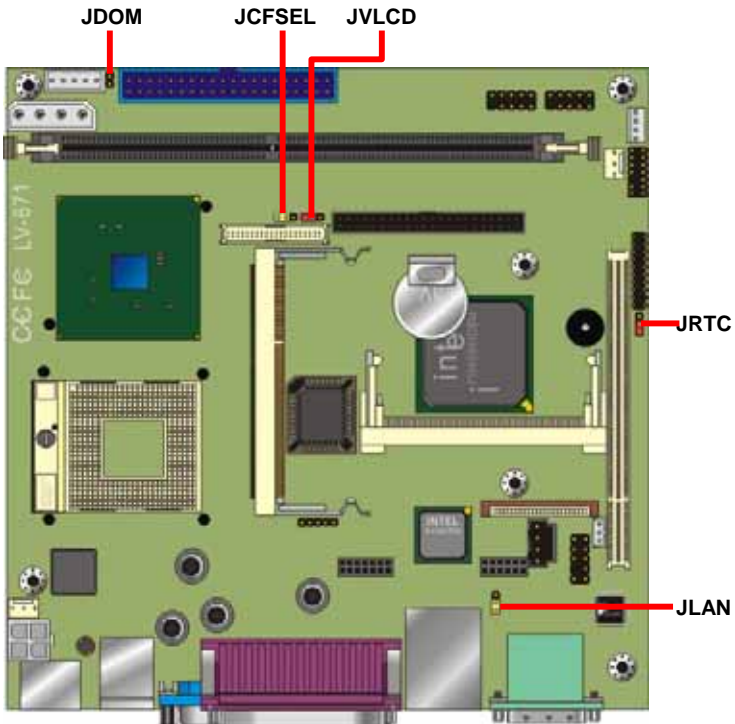

2.3 <Connector Reference>

2.3.1 <Internal Connector>

Connector	Function	Remark
CPU	MicroPGA479 CPU Socket	Standard
DIMM	184-pin DIMM Socket	Standard
IDE1	40-pin Primary IDE Port	Standard
IDE2	44-pin Secondary IDE Port	Standard
FDD	26-pin slim type FDD Port	Standard
CN_USB1	10-pin 3 rd / 4 th Hi-Speed USB 2.0 Port	Standard
CN_USB2	10-pin 5 th / 6 th Hi-Speed USB 2.0 Port	Standard
CN_IR	5-pin SIR IrDA Port	Standard
CN_12V	4-pin AT Power Connector	Standard
CN_BPWR	4-pin 5V&12V output connector	Standard
CN_SPWR	4-pin 5V&12V output connector	Standard
JFRNT	14-pin Switch and Indicator Connector	Standard
CPUFAN	3-pin +12V CPU Fan Connector	Standard
SYSFAN	3-pin +12V System Fan Connector	Standard
CN_AUDIO	10-pin Audio Port	Standard
CDIN	4-pin CD-in Interface	Standard
CN_WOL	3-pin Wake-On-LAN Interface	Standard
CN_LVDS	40-pin LVDS connector	Standard
CN_INV	5-pin LCD Inverter Power Connector	Standard
CN_DIO	20-pin programmable I/O connector	Standard
CN_LAN2	Additional Ethernet Controller Interface	Standard
CN_2ND_IO	Additional I/O module interface	Standard
CF	Compact Flash Card Interface	Standard
PCMCIA	PCMCIA Card bus interface	Standard

2.3.2 <External I/O connector>

Connector	Function	Remark
DC_IN	4-pin 12V/19V auto-switching input	Standard
PS2	PS/2 type keyboard and mouse port	Standard
Printer	DB26 parallel port	Standard
VGA	DB15 VGA port	Standard
SPEAKER	Amplified speaker out	Standard
SPDIF	Digital audio output	Standard
LAN	RJ45 LAN port	Standard
DUAL_USB	USB connectors	Standard
COM1/2	RS232 DB9 serial port	Standard
PCMCIA	Car bus slot	Standard

2.4 <System Setup>

2.4.1 <CPU Installation>

The board supports Intel Pentium M/ Celeron M processor with 400MHz of front side bus, 512KB/1MB/2MB of L2 cache, there are two package type of the processor, 478-pin PGA for socket479 onboard version; 479-pin BGA for embedded processor version. Please check installation steps below for onboard socket479 version.

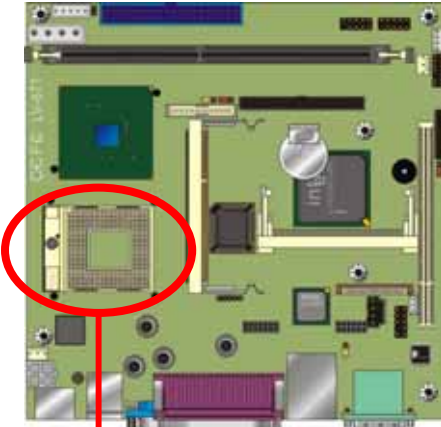

**Socket479 for Intel Pentium M/Celeron M
With 478-pin PGA**

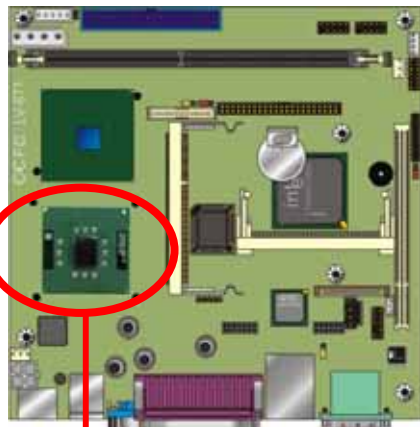

**Embedded Intel Pentium M/Celeron M
With 479-pin LV/ULV**



**1. Use the flat-type
screw drive to unlock
the CPU socket**

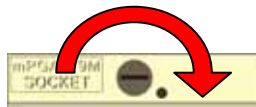

Unlock way

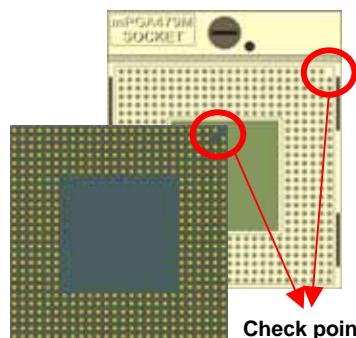

**2. Follow the pin direction to install
the processor on the socket**

Check point



3. Lock the socket

2.4.2 <Memory Installation>

The board supports one 184-pin DDR266/333 (PC2100/PC2700) SDRAM up to 1GB of capacity, and supports ECC (Error Correcting Code), unbuffered memory modules.

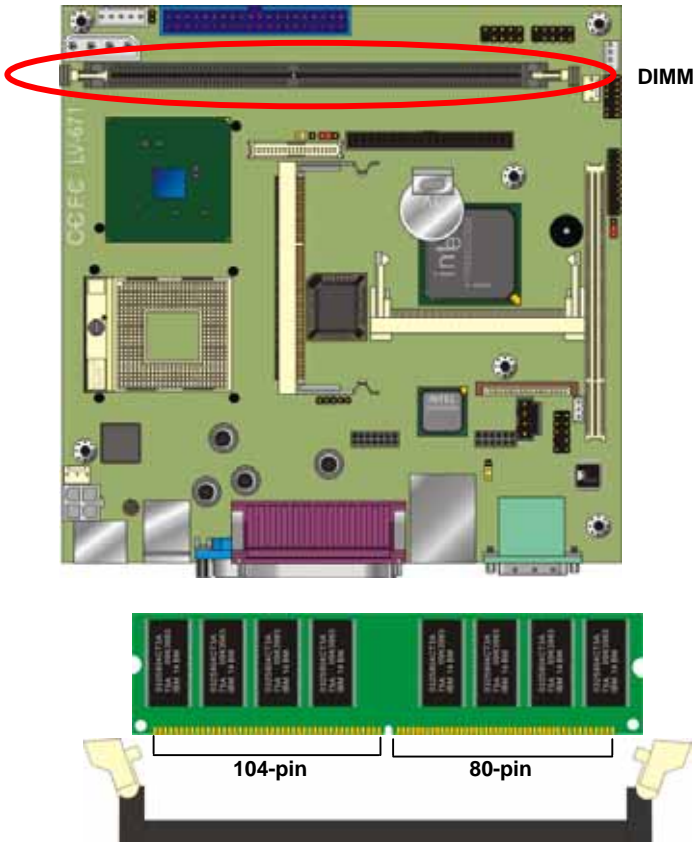

Please check the pin number to match the socket side well before installing memory module.

2.4.3 <CPU Cooler Installation>

The board accessories come with one CPU cooler, the cooler's specification is listed below, please check the installation steps before you start.

Notice: Installing the cooler improperly may cause the system unstable, if you face system rebooting or other issue, please check this point.

Cooler Specification:

Rated Voltage	Consumption	Sound Level	Rated Speed	Air Flow
12V	Max 0.12Amp	Max 27dB	5000rpm	Max 4.73CFM

The Cooler can compete with up to 2.0GHz of Intel Pentium M processor, if user needs to use more upper frequency, please replace other coolers.

Cooler Installation Guide:



1. Remove the sticker on the base



2. Put the base through the fixing holes



3. Put the cooler through the four pills on the base

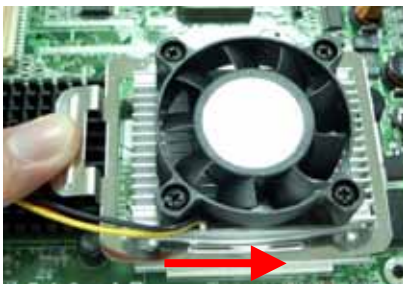

4. Press the plate and move forward



4. Connect the fan connector on CPU_FAN

2.5 <CMOS Setup>

The board's data of CMOS can be setting in BIOS. If the board refuses to boot due to inappropriate CMOS settings, here is how to proceed to clear (reset) the CMOS to its default values.

Jumper: **JRTC**

Type: Onboard 3-pin Header

JRTC	Mode
1-2	Clear CMOS
2-3	Normal Operation

Default setting

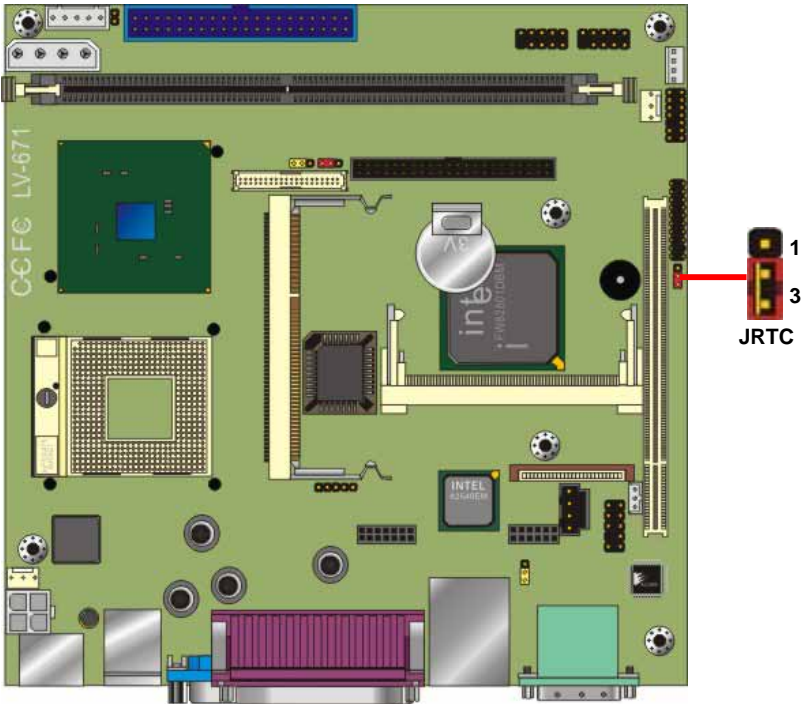

2.6 <IDE Interface>

The board supports two IDE interface up to 4 ATAPI devices, base on Intel ICH4, the IDE interface supports ATA66/100 ATAPI drives. The IDE1 supports +5V on pin-20 for DOM (Disk on Module), the jumper JDOM can let you select enable/disable this support.

Jumper: **JDOM**

Type: onboard 3-pin header

JDOM	Mode
ON	IDE1 pin-20 5V power supply enable
OFF	No 5V power supply on IDE1 pin-20
Default setting	

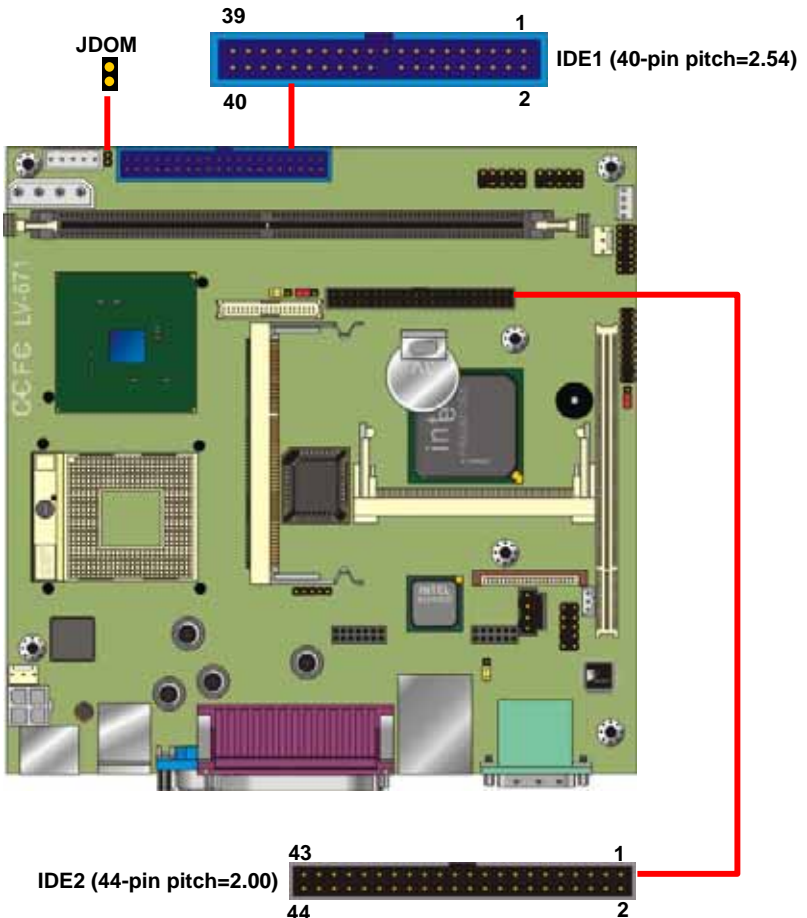

2.7 Compact Flash Interface

The board supports Compact Flash Type I socket for storage flash disk only, the jumper **JCFSEL** can let you to setup the flash card operate on secondary master or slave mode.

Jumper: **JCFSEL**

Type: onboard 3-pin header

JCFSEL	Mode
1-2	Master
2-3	Slave
Default setting	

Tested Compact Flash Disk

Manufacture	Capacity
LEXAR	16MB
DigitFab	32MB
RiDATA	256MB
HAGIWARA SYS-COM	512MB
Sandisk	2GB



2.8 <Display Interface>

2.8.1 <Analog display interface>

The board is integrated with Intel 855GM GMCH chipset built-in Intel Extreme Graphics 2 with 266 MHz VGA core, 256-bit 3D engine and Intel Dynamic Video Memory up to 64MBytes shared with system memory. The CRT / analog VGA interface includes one external DB15 female connector on bracket on board.

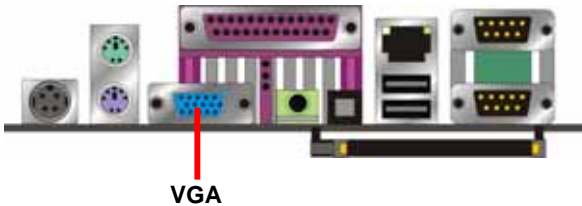

2.8.2 <Digital display interface>

The board's digital video interface provides LVDS flat panel support. The built-in 18/24-bit dual channel LVDS interface offers the economical solution for LVDS-based LCD display.

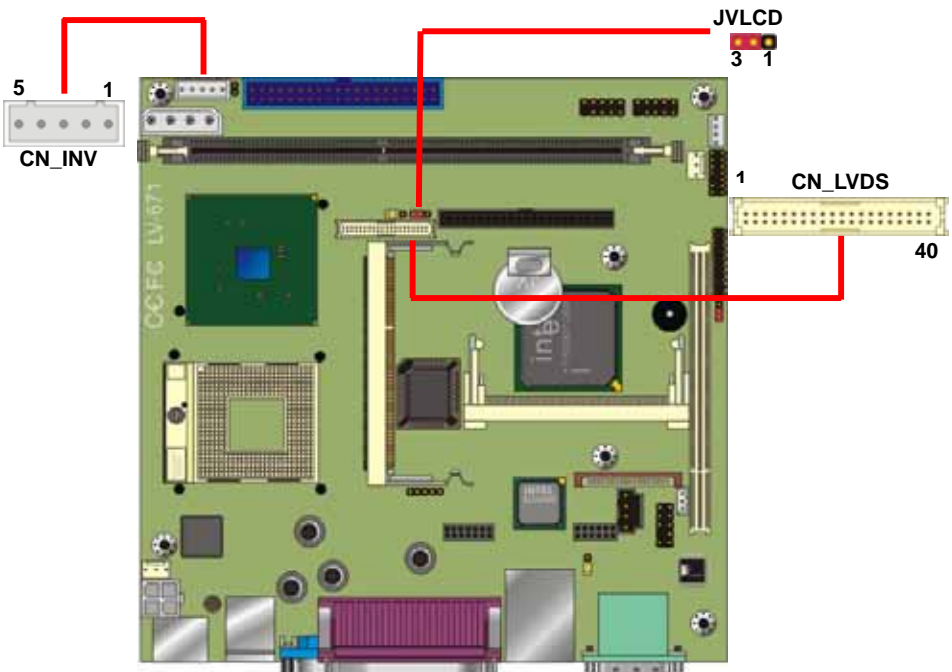

Connector: **CN_INV**

Type: 5-pin LVDS Power Header

Pin	Description
1	+12V
2	GND
3	GND
4	GND
5	ENABKL

Connector: **JVLCD**

Type: 3-pin Power select Header

Pin	Description
1	VCC
2	LCDVCC
3	VCC3

Connector: **CN_LVDS**

Type: onboard 40-pin connector for LVDS connector

Connector model: **HIROSE DF13-40DP-1.25V**

Pin	Signal	Pin	Signal
2	LCDVCC	1	LCDVCC
4	GND	3	GND
6	ATX0-	5	BTX0-
8	ATX0+	7	BTX0+
10	GND	9	GND
12	ATX1-	11	BTX1-
14	ATX1+	13	BTX1+
16	GND	15	GND
18	ATX2-	17	BTX2-
20	ATX2+	19	BTX2+
22	GND	21	GND
24	ATXCK-	23	BTX3-
26	ATXCK+	25	BTX3+
28	GND	27	GND
30	ATX3-	29	BTXCK-
32	ATX3+	31	BTXCK+
34	GND	33	GND
36	PANELCLK	35	N/C
38	PANELDATA	37	N/C
40	N/C	39	N/C

To setup the LCD, you need the components below:

1. A panel (support up to 24-bit dual channel) with LVDS interfaces.
2. An inverter for panel's backlight power.
3. A LCD cable and an inverter cable.

For the cables, please follow the pin assignment of the connector to make a cable, because every panel has its own pin assignment, so we do not provide a standard cable; please find a local cable manufacture to make cables.

LCD installing guide:

1. Prepare a panel, inverter and **LV-671**.

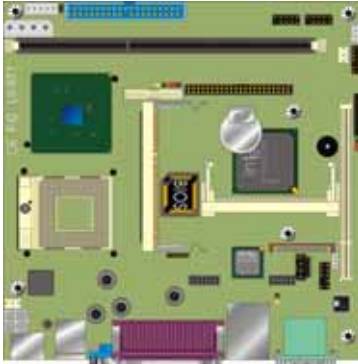

2. Please check the datasheet of the panel to see the voltage of the panel, and set the jumper **JVLCD** to +5V or +3.3V.
3. Prepare a LVDS type LCD cable



4. Connect all the devices well.

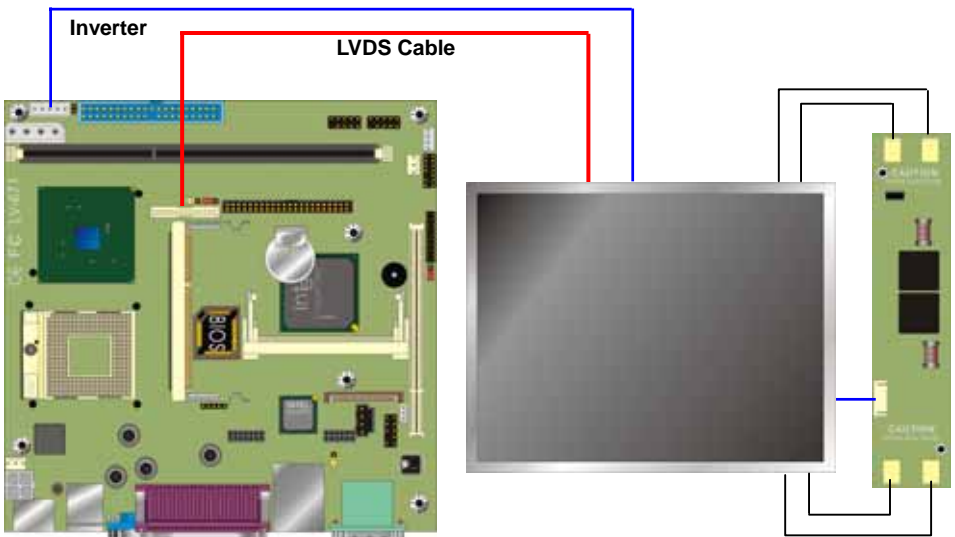

After setup the devices well, you need to select the LCD panel type in the BIOS.

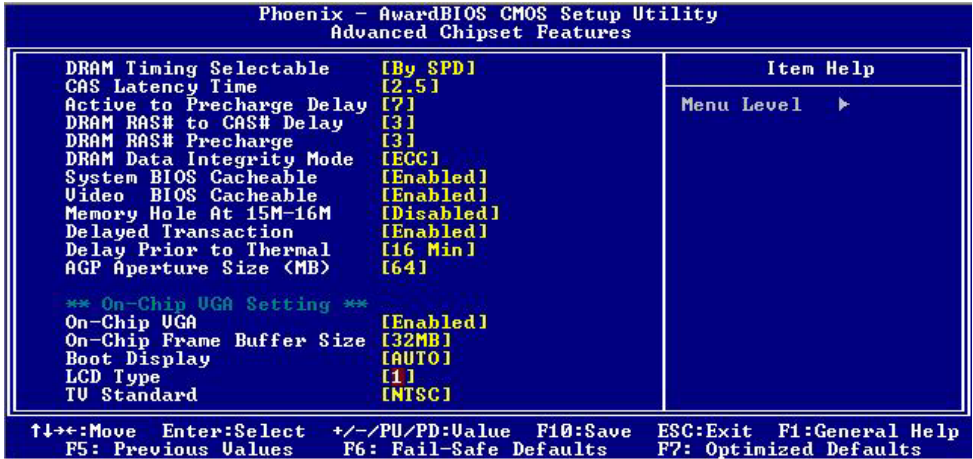

The panel type mapping is list below:

BIOS panel type selection form			
For 18-bit color		For 24-bit color	
NO.	Output format	NO.	Output format
1	640 x 480	8	1024 x 768
2	800 x 600	9	1280 x 1024 Dual Channel
3	1024 x 768	10	1400 x 1050 Dual Channel
4	1280 x 1024	11	1600 x 1200 Dual Channel
5	1400 x 1050 Dual Channel @ 108Mhz	13	1024 x 768 Dual Channel
6	1400 x 1050 Dual Channel @ 122Mhz	14	
7	1600 x 1200 Dual Channel	15	1280 x 768Dual Channel
12	1024 x 768 Dual Channel		

2.9 <Audio Interface>

The board integrates Intel ICH4 with REALTEK ALC655 codec for AC97 Rev 2.3; it comes with the features below:

- Microsoft WHQL/WLP 2.0 audio compliance
- Software selectable for 2-channel/5.1-channel sound
- 16-bit Stereo full-duplex CODEC with 48KHz sampling rate
- Two software selectable MIC inputs
- Supports 20-bit 48KHz S/PDIF output, complying with AC'97 Rev 2.3 specifications
- EAX™ 1.0 & 2.0, Direct Sound 3D™, A3D™ compatible

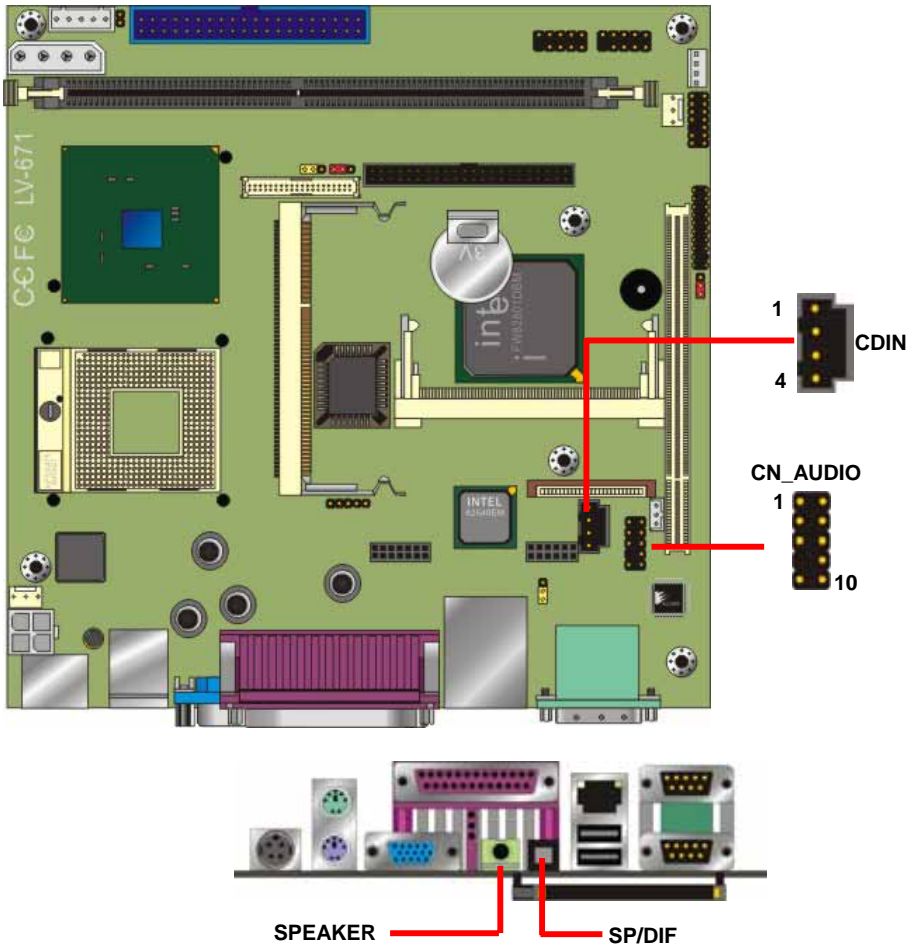

Connector: CN_AUDIO

Type: 10-pin (2 x 5) 2.54-pitch header

Pin	Description	Pin	Description
1	Line – Right	2	Ground
3	Line – Left	4	MIC
5	MIC	6	Ground
7	N/C	8	Line Out – Left
9	Line Out – Right	10	Ground

Connector: CDIN

Type: 4-pin header

Pin	Description
1	CD – Left
2	Ground
3	Ground
4	CD – Right

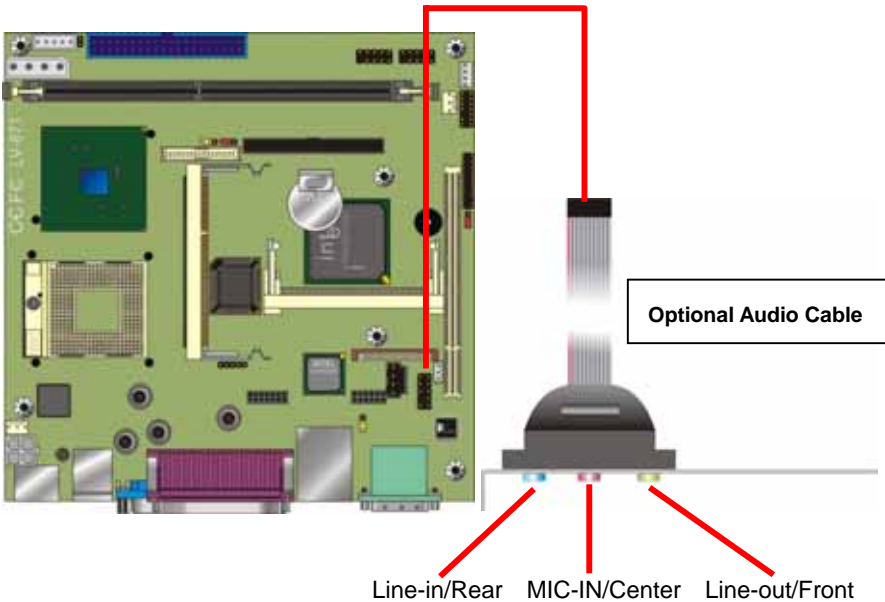

2.10 <Ethernet Interface>

The board integrates with Intel 82540EM Gigabit controller at the type of 10Base-T/100Base-TX/1000Base-T auto-switching Ethernet with full duplex and IEEE 802.3U compliant. The LAN function comes with a RJ45 jack on the rear I/O panel. The **CN_WOL** is for the Wake-Up-On-LAN function link with PCI LAN Card.

Connector: **CN_WOL**

Type: onboard 3-pin (1 x 3) wafer connector

Pin	1	2	3
Description	WOL-Ctrl	Ground	+5V Standby

Jumper: **JLAN**

Type: onboard 3-pin header

JRTC	Mode
1-2	Enable Onboard LAN controller
2-3	Disable Onboard LAN controller

Default setting

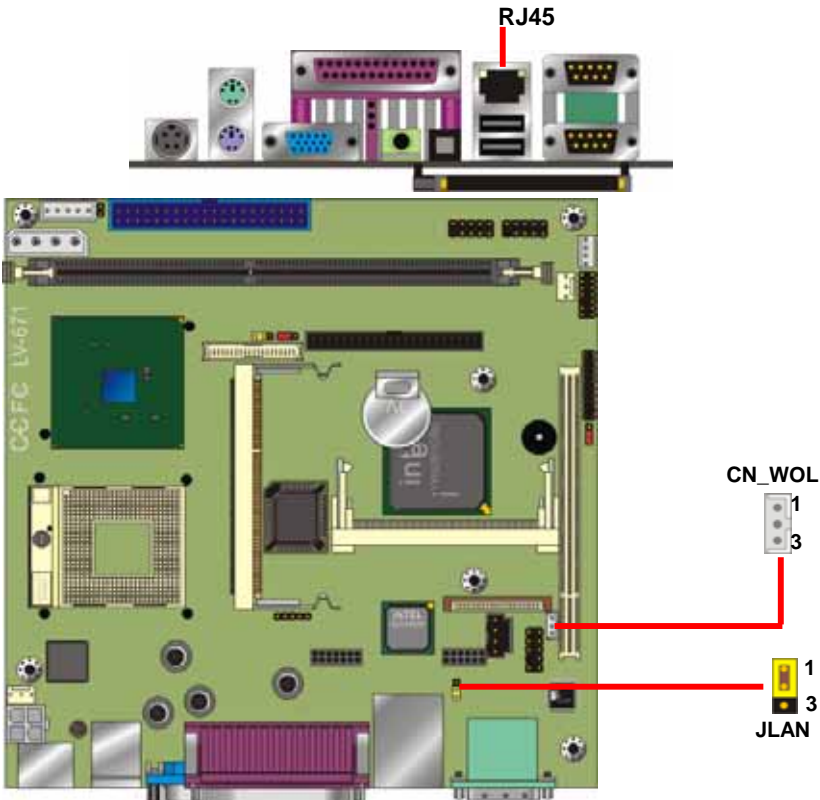

2.11 <Power and Fan connector>

The board comes with a 4-pin Mini-DIN power connector for DC 12V/19V auto-switching input, it also has one 4-pin P4 additional use power connector for internal power supply, you can choose one of them to meet your application.

The board has two power connectors for 5V/12V output to powering your ATAPI drives directly, and it has two fan connectors for CPU and system cooling.

How to power the board

Type 1: Use DC 12V/19V adapter with 4-pin MINI-DIN connector for DC_IN



Type 2: Use standard internal P4 power supply for CN_12V

We strongly recommend users to use type 1 for powering the board.

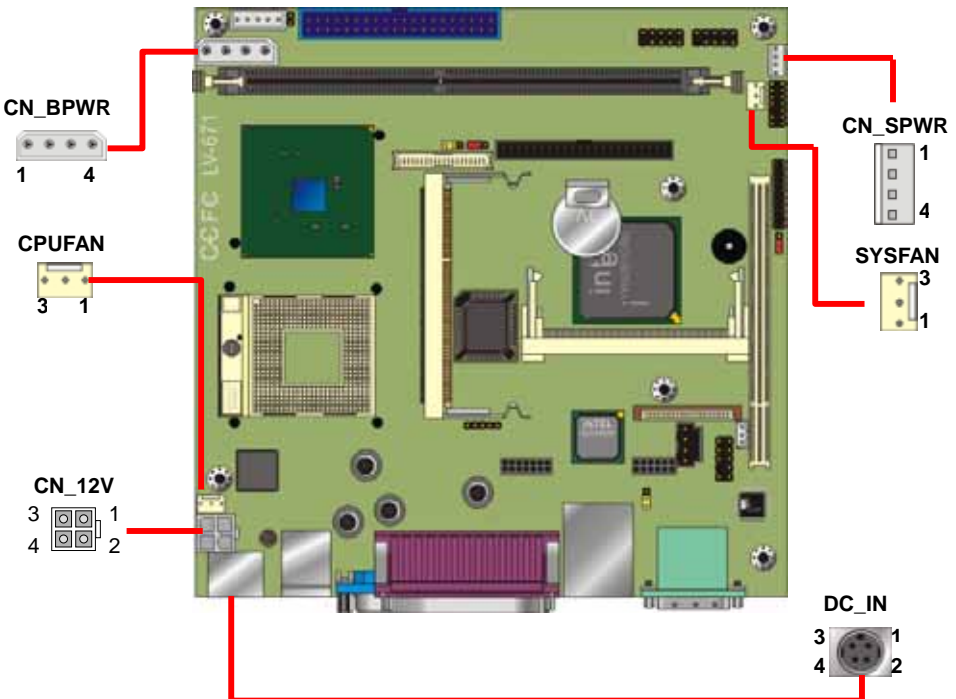

Connector: **CN_12V**

Type: 4-pin standard Pentium 4 +12V power connector

Pin	Description	Pin	Description
1	+12V	2	+12V
3	Ground	4	Ground

Connector: **DC_IN**

Type: 4-pin DC power connector

Pin	Description	Pin	Description
1	+12V	2	Ground
3	+12V	4	Ground

Connector: **CPUFAN, SYSFAN**

Type: 3-pin fan wafer connector

Pin	Description	Pin	Description	Pin	Description
1	Ground	2	+12V	3	Fan Control

Connector: **CN_BPWR**

Type: 4-pin P-type connector for +5V/+12V **output**

Pin	Description	Pin	Description	Pin	Description	Pin	Description
1	+5V	2	Ground	3	Ground	4	+12V

Note: Maximum output voltage: 12V/5A & 5V/3A

Connector: **CN_SPWR**

Type: 4-pin connector for +5V/+12V **output**

Pin	Description	Pin	Description	Pin	Description	Pin	Description
1	+12V	2	Ground	3	Ground	4	+5V

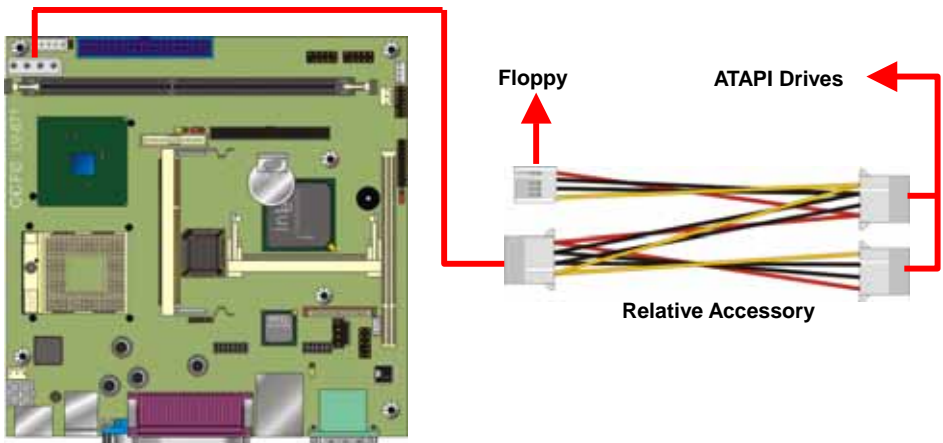

2.12 <GPIO Interface>

The board offers 16-bit digital I/O to customize its configuration to your control needs. For example, you may configure the digital I/O to control the opening and closing of the cash drawer or to sense the warning signal from a tripped UPS.

Connector: **CN_DIO**

Type: 20-pin (10 x 2) header

Pin	Description	Pin	Description
1	GP10	2	GP20
3	GP11	4	GP21
5	GP12	6	GP22
7	GP13	8	GP23
9	Ground	10	Ground
11	GP14	12	GP24
13	GP15	14	GP25
15	GP16	16	GP26
17	GP17	18	N/C
19	12VDU	20	5VDU

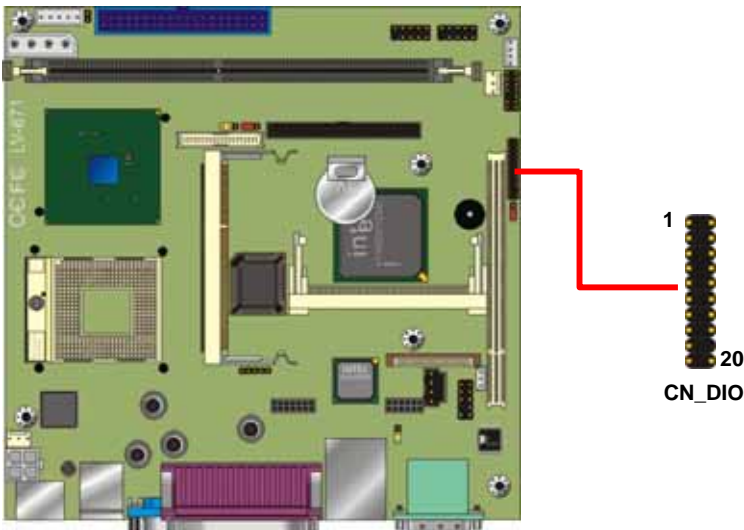

2.13 <Expansive Interface>

The board comes with one slim type PCI slot and one optional Mini-AGP or Mini-PCI interface. The slim PCI slot supports up to 2 PCI devices through an optional riser card. For Mini-PCI interface, you can obtain a wireless LAN card for portable system. For Mini-AGP interface, you can obtain an extended graphic card to improve the onboard graphics performance.

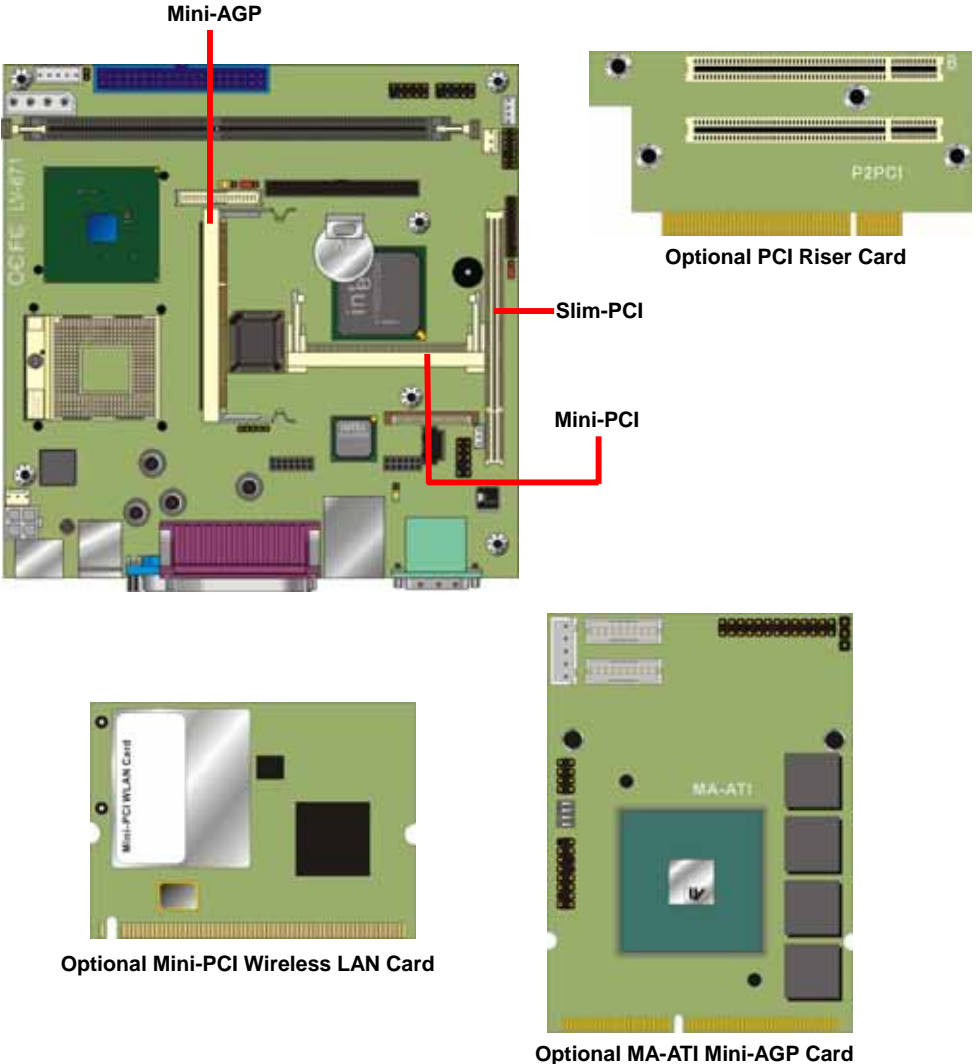

2.14 <Switch and Indicator>

Connector: **JFRNT**

Type: onboard 14-pin (2 x 7) 2.54-pitch header

Function	Signal	PIN		Signal	Function
IDE LED	Vcc (+)	1	2	(+) Vcc	Power LED
	Active	3	4	N/C	
Reset	Reset	5	6	GND	
	GND	7	8	Vcc	
N/C		9	10	N/C	Speaker
Power	PWRBT	11	12	N/C	
Button	5VSB	13	14	SPKIN	

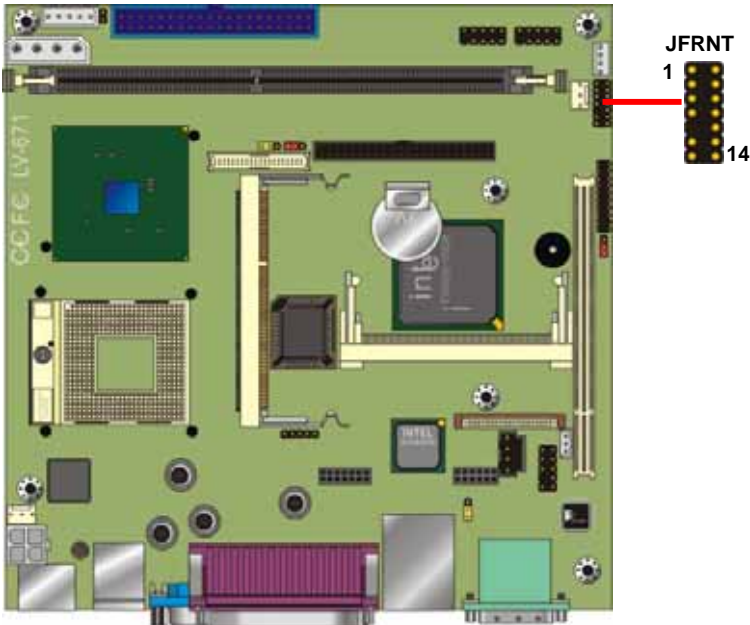

(This Page is Left for Blank)

Chapter 3 <System Setup>

3.1 <Watchdog Timer Setting>

The watchdog timer makes the system auto-reset while it stops to work for a period. The integrated watchdog timer can be setup as system reset mode by program.

Timeout Value Range

- 1 to 255
- Second or Minute

Program Sample

Watchdog timer setup as system reset with 5 second of timeout

```

2E, 87
2E, 87
2E, 07
2F, 08      Logical Device 8
2E, 30      Activate
2F, 01
2E, F5      Set as Second*
2F, 00
2E, F6      Set as 5
2F, 05
  
```

* Minute: bit 3 = 0; Second: bit 3 = 1

You can select Timer setting in the BIOS, after setting the time options, the system will reset according to the period of your selection.

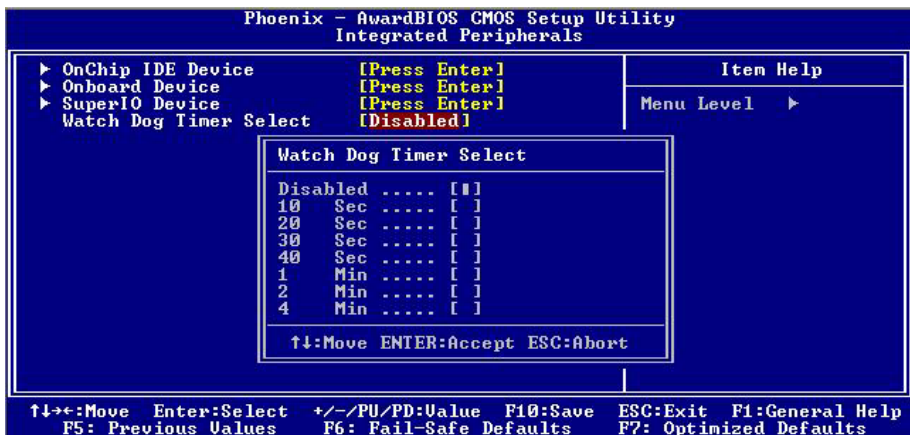

3.2 <Audio Setting>

The board integrates Intel® ICH4 with REALTEK® ALC655 codec. It can support 2-channel or 5.1 channel sound under system configuration. Please follow the steps below to setup your sound system.

1. Install REALTEK AC97 Audio driver.



2. Launch the control panel and Sound Effect Manager.
3. Select Speaker Configuration



4. Select the sound mode to meet your speaker system.

3.3 <Display Device Setup>

This chapter shows you how to setup the display device under Windows OS.

Before you using your display device:

1. Check your software

Before you can use the display device properly, please install the VGA driver.

2. Check your hardware

Please setup the display device properly before you boot up the system.

For configure your Display device, please follow the instructions below:

1. Please lunch Display Properties.

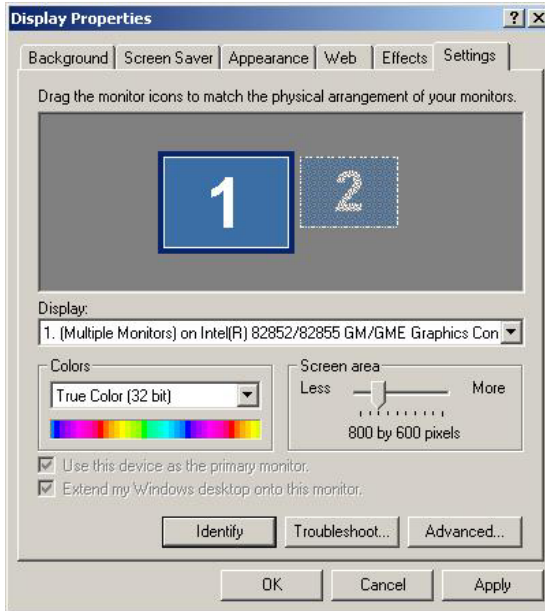

You would see two Graphics Controllers. If you connect two display devices, you would be able to setup each device for color bit and resolution.



This item can let you configure which device would be the primary if you connect two display devices.



This item can let you extend your Windows Desktop to second display device.

If you click the identify button, the screen will pop up the number sequence of your device.

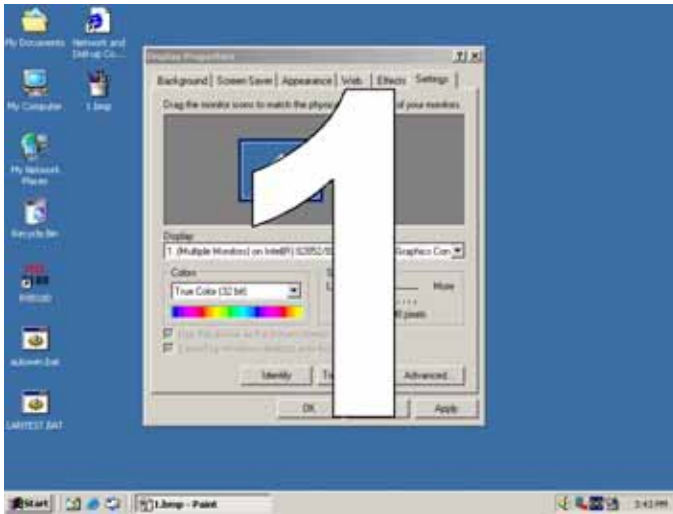

For advanced display settings, please click Advanced... button and choose Intel(R) Extreme Graphics.

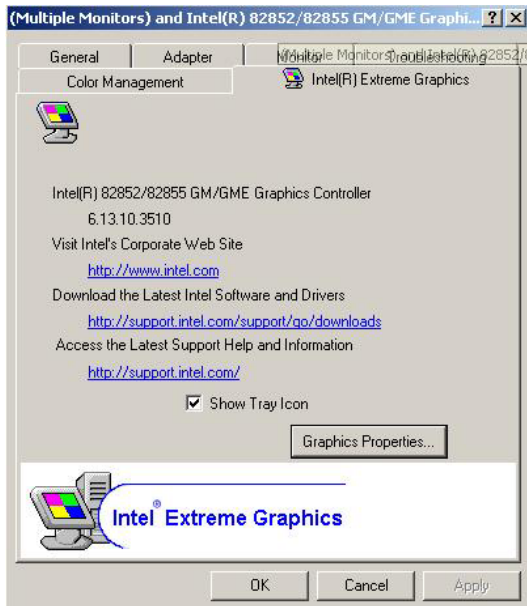

Please click Graphics Properties button to enter the advanced setup.

While you entering the Graphics Properties, you will see the options below:

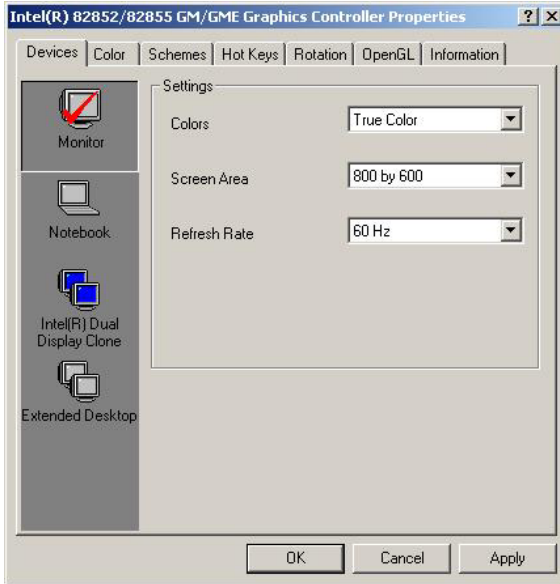

This option can let you configure the CRT monitors for Colors, Screen Area (Resolution) and Refresh Rate.

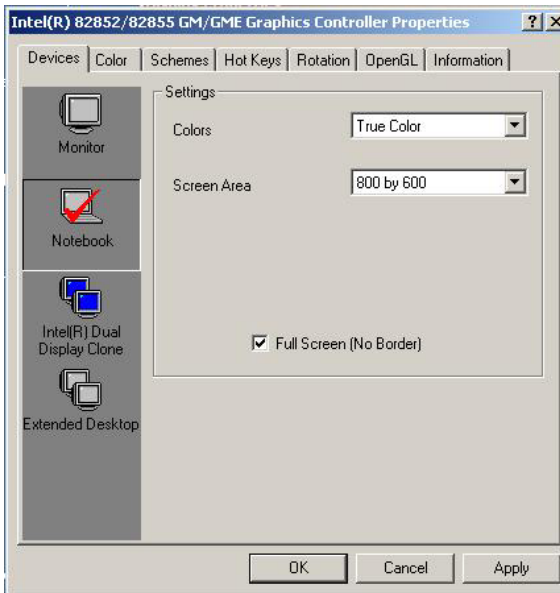

This option can let you configure the LCD panel for Colors, Screen Area (Resolution) and Full Screen option.

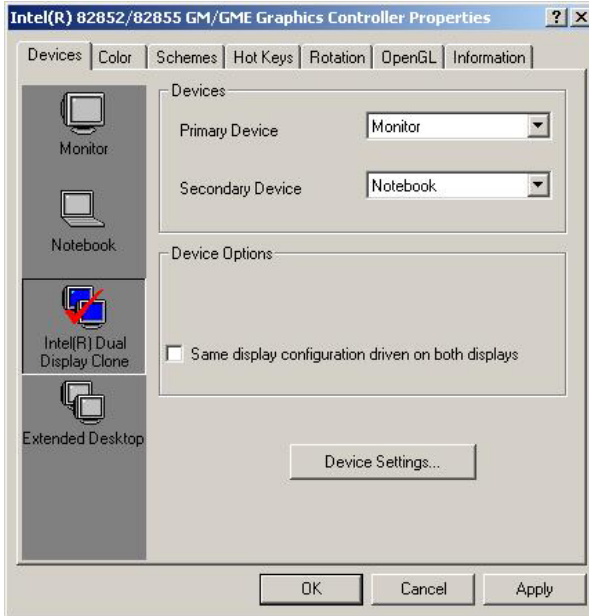

This option can let you configure the Dual Display for clone mode (same display on two devices)

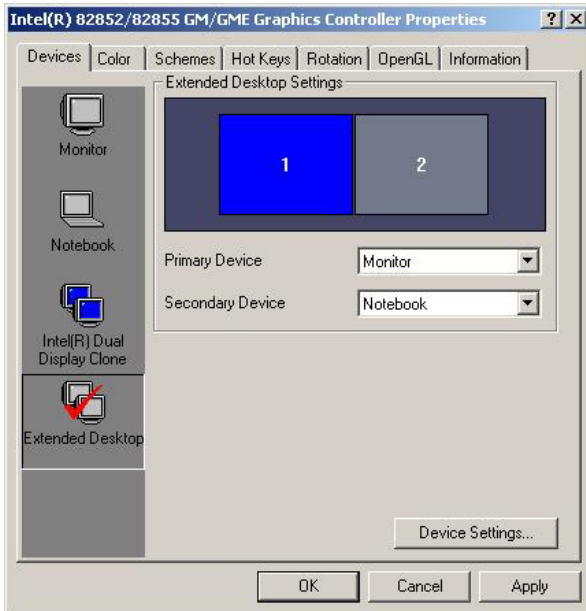

This option can let you configure the Dual Display for Extended Desktop mode

Chapter 4 <BIOS Setup>

The single board computer uses the Award BIOS for the system configuration. The Award BIOS in the single board computer is a customized version of the industrial standard BIOS for IBM PC AT-compatible computers. It supports Intel x86 and compatible CPU architecture based processors and computers. The BIOS provides critical low-level support for the system central processing, memory and I/O sub-systems.

The BIOS setup program of the single board computer let the customers modify the basic configuration setting. The settings are stored in a dedicated battery-backed memory, NVRAM, retains the information when the power is turned off. If the battery runs out of the power, then the settings of BIOS will come back to the default setting.

The BIOS section of the manual is subject to change without notice and is provided here for reference purpose only. The settings and configurations of the BIOS are current at the time of print, and therefore they may not be exactly the same as that displayed on your screen.

To activate CMOS Setup program, press key immediately after you turn on the system. The following message "Press DEL to enter SETUP" should appear in the lower left hand corner of your screen. When you enter the CMOS Setup Utility, the Main Menu will be displayed as **Figure 5-1**. You can use arrow keys to select your function, press <Enter> key to accept the selection and enter the sub-menu.

Figure 5-1 CMOS Setup Utility Main Screen

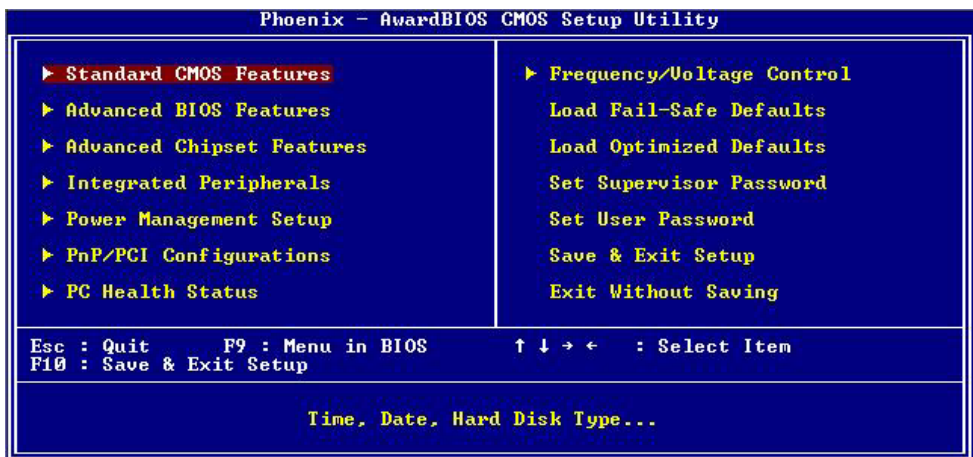

For more BIOS information please visit Phoenix-Award:

<http://www.phoenix.com/en/customer+services/bios/awardbios/default1.htm>

(This Page is Left for Blank)

Appendix A <I/O Port Pin Assignment>

A.1 <IDE Port>

Connector: **IDE1**

Type: 40-pin (20 x 2) box header



Pin	Description	Pin	Description
1	Reset	2	Ground
3	D7	4	D8
5	D6	6	D9
7	D5	8	D10
9	D4	10	D11
11	D3	12	D12
13	D2	14	D13
15	D1	16	D14
17	D0	18	D15
19	Ground	20	VCC (JDOM)
21	REQ	22	Ground
23	IOW-/STOP	24	Ground
25	IOR-/HDMARDY	26	Ground
27	IRDY/DDMARDY	28	IDESEL
29	DACK-	30	Ground
31	IRQ	32	N/C
33	A1	34	CBLID
35	A0	36	A2
37	CS1 (MASTER CS)	38	CS3 (SLAVE CS)
39	LED ACT-	40	Ground

Connector: **IDE2**

Type: 44-pin (22 x 2) box header



Pin	Description	Pin	Description
1	Reset	2	Ground
3	D7	4	D8
5	D6	6	D9
7	D5	8	D10
9	D4	10	D11
11	D3	12	D12
13	D2	14	D13
15	D1	16	D14
17	D0	18	D15
19	Ground	20	N/C
21	REQ	22	Ground
23	IOW-/STOP	24	Ground
25	IOR-/HDMARDY	26	Ground
27	IRDY/DDMARDY	28	IDESEL
29	DACK-	30	Ground
31	IRQ	32	N/C
33	A1	34	CBLID
35	A0	36	A2
37	CS1	38	CS3
39	IDEACT-	40	Ground
41	VCC	42	VCC
43	Ground	44	Ground

A.2 <Floppy Port>

Connector: **FDD**

Type: 26-pin connector



Pin	Description	Pin	Description
1	VCC	2	INDEX
3	VCC	4	DRV0
5	VCC	6	DSKCHG
7	DRV1	8	N/C
9	MTR1	10	MTR0
11	RPM	12	DIR
13	N/C	14	STEP
15	Ground	16	WRITE DATA
17	Ground	18	WRITE GATE
19	N/C	20	TRACK 0
21	N/C	22	WRPTR
23	Ground	24	RDATA-
25	Ground	26	SEL

A.3 < USB Interface >

Connector: **CN_USB1, CN_USB2**

Type: 10-pin (5 x 2) header for dual USB Ports



Pin	Description	Pin	Description
1	VCC	2	VCC
3	Data0-	4	Data1-
5	Data0+	6	Data1+
7	Ground	8	Ground
9	N/C	10	N/C

PS. You can obtain an optional USB cable on bracket for to 2 USB ports.

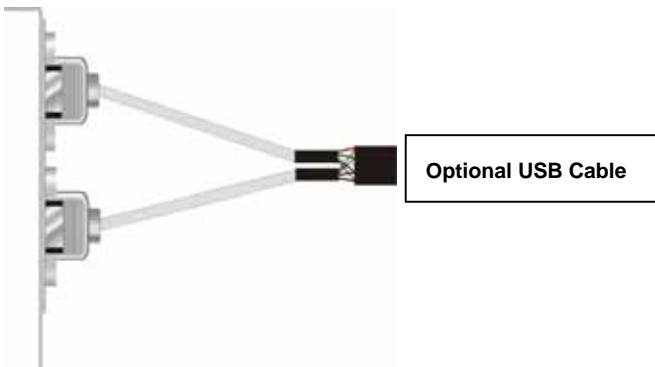

A.4 <IrDA Port>

Connector: **CN_IR**

Type: 5-pin header for SIR Ports



Pin	Description
1	VCC
2	N/C
3	IRRX
4	Ground
5	IRTX

A.5 < VGA Port >

Connector: **VGA**

Type: 15-pin D-sub female connector on bracket

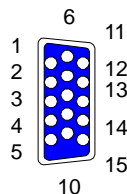

Pin	Description	Pin	Description	Pin	Description
1	RED	6	Ground	11	N/C
2	GREEN	7	Ground	12	5VCDA
3	BLUE	8	Ground	13	HSYNC
4	N/C	9	LVGA5V	14	VSYNC
5	Ground	10	Ground	15	5VCLK

A.6 < LAN Port >

Connector: **RJ45**

Type: RJ45 connector with LED on bracket



Pin	1	2	3	4	5	6	7	8
Description	MIO+	MIO-	MI1+	MI2+	MI2-	MI1-	MI3+	MI3-

A.7 < Serial Port >

Connector: **COM1**

Type: 9-pin D-sub male connector on bracket

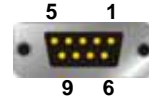

Pin	Description	Pin	Description
1	MDCD1-	6	MDSR1-
2	MSIN1-	7	MRTS1-
3	MSO1-	8	MCTS1-
4	MDTR1-	9	MRI1-
5	Ground		

Connector: **COM2**

Type: 9-pin D-sub male connector on bracket

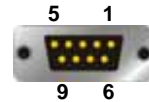

Pin	Description	Pin	Description
1	MDCD2-	6	MDSR2-
2	MSIN2-	7	MRTS2-
3	MSO2-	8	MCTS2-
4	MDTR2-	9	MRI2-
5	Ground		

Output Voltage: +/- 9V.

(This Page is Left for Blank)

Appendix B <Flash BIOS>

B.1 <Flash Tool>

The board is based on Award BIOS and can be updated easily by the BIOS auto flash tool. You can download the tool online at the address below:

<http://www.phoenix.com/en/home/>

http://www.commell.com.tw/Support/Support_SBC.htm

File name of the tool is "awdfash.exe", it's the utility that can write the data into the BIOS flash ship and update the BIOS.

B.2 <Flash BIOS Procedure>

1. Please make a bootable floppy disk.
2. Get the last .bin files you want to update and copy it into the disk.
3. Copy awardflash.exe to the disk.
4. Power on the system and flash the BIOS. (Example: C:/ awardflash XXX.bin)
5. Restart the system.

Any question about the BIOS re-flash please contact your distributors or visit the web-site at below:

<http://www.commell.com.tw/support/support.htm>

(This Page is Left for Blank)

Appendix C <System Resource>

C.1 <I/O Address Map>

Address Range	Device
x0000 - x000F	Direct Memory Access Controller
x0010 - x001F	Motherboard Resource
x0020 - x0021	Programmable Interrupt Controller
x0022 - x003F	Motherboard Resource
x0040 - x0043	System Clock
x0044 - x005F	Motherboard Resource
x0060 - x0060	Standard 101/102-Key or Microsoft Natural Keyboard
x0061 - x0061	System Speaker
x0062 - x0063	Motherboard Resource
x0064 - x0064	Standard 101/102-Key or Microsoft Natural Keyboard
x0065 - x006F	Motherboard Resource
x0070 - x0073	System CMOS/ Real Time Clock
x0074 - x007F	Motherboard Resource
x0080 - x0090	Direct Memory Access Controller
x0091 - x0093	Motherboard Resource
x0094 - x009F	Direct Memory Access Controller
x00A0 - x00A1	Programmable Interrupt Controller
x00A2 - x00BF	Motherboard Resource
x00C0 - x00DF	Direct Memory Access Controller
x00E0 - x00EF	Motherboard Resource
x00F0 - x00FF	Numeric Data Processor
x0170 - x0177	Intel(R) 82801DB Ultra ATA Storage Controller - 24CB
x0170 - x0177	Secondary IDE controller (dual fifo)
x01F0 - x01F7	Intel(R) 82801DB Ultra ATA Storage Controller - 24CB
x01F0 - x01F7	Primary IDE controller (dual fifo)
x0294 - x0297	Motherboard Resource
x02F8 - x02FF	Communication Port (COM2)
x0376 - x0376	Intel(R) 82801DB Ultra ATA Storage Controller - 24CB
x0376 - x0376	Secondary IDE controller (dual fifo)
x0378 - x037F	Printer Port (LPT1)
x03B0 - x03BB	Intel(R) 82852/82855 GM/GME Graphics Controller
x03C0 - x03DF	Intel(R) 82852/82855 GM/GME Graphics Controller
x03F0 - x03F5	Standard Floppy Controller
x03F6 - x03F6	Intel(R) 82801DB Ultra ATA Storage Controller - 24CB
x03F6 - x03F6	Primary IDE controller (dual fifo)
x03F7 - x03F7	Standard Floppy Controller

x03F8 - x03FF	Communication Port (COM1)
x0400 - x04BF	Motherboard Resource
x04D0 - x04D1	Motherboard Resource
x0500 - x051F	Intel(R) 82801DB/DBM SMBus Controller - 24C3
x0778 - x077B	Printer Port (LPT1)
x0A78 - x0A7B	Motherboard Resource
x0B78 - x0B7B	Motherboard Resource
x0BBC - x0BBF	Motherboard Resource
x0CF8 - x0CFF	PCI Bus
x0E78 - x0E7B	Motherboard Resource
x0F78 - x0F7B	Motherboard Resource
x0FBC - x0FBF	Motherboard Resource
xA000 - xBFFF	Intel(R) 82801DB PCI Bridge - 244E
xB000 - xB03F	Intel(R) PRO/1000 MT Network Connection
xC000 - xC01F	Intel(R) 82801DB/DBM USB Universal Host Controller
xC400 - xC41F	Intel(R) 82801DB/DBM USB Universal Host Controller
xC800 - xC81F	Intel(R) 82801DB/DBM USB Universal Host Controller
xCC00 - xCC07	Intel(R) 82852/82855 GM/GME Graphics Controller
xD400 - xD4FF	Realtek AC'97 Audio
xD800 - xD83F	Realtek AC'97 Audio
xF000 - xF007	Primary IDE controller (dual fifo)
xF008 - xF00F	Intel(R) 82801DB Ultra ATA Storage Controller - 24CB
xF010 - xF01F	Secondary IDE controller (dual fifo)

C.2 <Memory Address Map>

Range	Device
x00000000 - x0009FFFF	System board extension for ACPI BIOS
x000A0000 - x000AFFFF	Intel(R) 82852/82855 GM/GME Graphics Controller
x000B0000 - x000BFFFF	Intel(R) 82852/82855 GM/GME Graphics Controller
x000C0000 - x000CC7FF	Intel(R) 82852/82855 GM/GME Graphics Controller
x000CC800 - x000CFFFF	System board extension for ACPI BIOS
x000E0000 - x000EFFFF	System board extension for ACPI BIOS
x000F0000 - x000F7FFF	System board extension for ACPI BIOS
x000F8000 - x000FBFFF	System board extension for ACPI BIOS
x000FC000 - x000FFFFF	System board extension for ACPI BIOS
x00100000 - x1DFEFFFF	System board extension for ACPI BIOS
x1DFF0000 - x1DFFFFFFF	System board extension for ACPI BIOS
xD0000000 - xD7FFFFFFF	Intel(R) 82852/82855 GM/GME Graphics Controller
xD8000000 - xDFFFFFFF	Intel(R) 82852/82855 GM/GME Graphics Controller
xE0000000 - xE0000FFF	Ricoh RL5C475 CardBus Controller
xE0000000 - xE1FFFFFFF	Intel(R) 82801DB PCI Bridge - 244E
xE1000000 - xE101FFFF	Intel(R) PRO/1000 MT Network Connection
xE1020000 - xE102FFFF	Intel(R) PRO/1000 MT Network Connection
xE2000000 - xE207FFFF	Intel(R) 82852/82855 GM/GME Graphics Controller
xE2080000 - xE20FFFFF	Intel(R) 82852/82855 GM/GME Graphics Controller
xE2100000 - xE21003FF	Intel USB 2.0 Enhanced Host Controller
xE2101000 - xE21011FF	Realtek AC'97 Audio
xE2102000 - xE21020FF	Realtek AC'97 Audio
xFEC00000 - xFECFFFFF	System board extension for ACPI BIOS
xFEE00000 - xFEEFFFFF	System board extension for ACPI BIOS
xFFB00000 - xFFB7FFFF	System board extension for ACPI BIOS
xFFB80000 - xFFBFFFFF	Intel(r) 82802 Firmware Hub Device
xFFFF00000 - xFFFFFFF	System board extension for ACPI BIOS

C.3 <System IRQ and DMA Resource>

C3.1 IRQ

IRQ Number	Device
0	System Clock
1	Standard 101/102-Key or Microsoft Natural Keyboard
2	Programmable Interrupt Controller
3	Communication Port (COM2)
4	Communication Port (COM1)
5	Realtek AC'97 Audio
5	Intel(R) 82801DB/DBM SMBus Controller - 24C3
5	ACPI IRQ Holder for PCI IRQ Steering
6	Standard Floppy Controller
7	Printer Port (LPT1)
8	System CMOS/ Real Time Clock
9	Ricoh RL5C475 CardBus Controller
9	ACPI IRQ Holder for PCI IRQ Steering
9	SCI IRQ used by ACPI bus
10	Intel(R) 82801DB/DBM USB Universal Host Controller - 24C7
10	Intel(R) 82801DB/DBM USB Universal Host Controller - 24C2
10	Intel(R) 82852/82855 GM/GME Graphics Controller
10	ACPI IRQ Holder for PCI IRQ Steering
10	ACPI IRQ Holder for PCI IRQ Steering
11	Intel(R) PRO/1000 MT Network Connection
11	Intel USB 2.0 Enhanced Host Controller
11	Intel(R) 82801DB/DBM USB Universal Host Controller - 24C4
11	ACPI IRQ Holder for PCI IRQ Steering
11	ACPI IRQ Holder for PCI IRQ Steering
12	PS/2 Compatible Mouse Port
13	Numeric Data Processor
14	Primary IDE controller (dual fifo)
14	Intel(R) 82801DB Ultra ATA Storage Controller - 24CB
15	Secondary IDE controller (dual fifo)
15	Intel(R) 82801DB Ultra ATA Storage Controller - 24CB

C3.2 DMA**Channel Device**

0	(free)
1	(free)
2	Standard Floppy Disk Controller
3	(free)
4	Direct Memory Access Controller
5	(free)
6	(free)
7	(free)

Contact Information

Any advice or comment about our products and service, or anything we can help you please don't hesitate to contact with us. We will do our best to support you for your products, projects and business

Taiwan Commate Computer Inc.

Address	8F, No. 94, Sec. 1, Shin Tai Wu Rd., Shi Chih Taipei Hsien, Taiwan
TEL	+886-2-26963909
FAX	+886-2-26963911
Website	http://www.commell.com.tw
E-Mail	info@commell.com.tw (General Information) tech@commell.com.tw (Technical Support)

Commell is our trademark of industrial PC division

Free Manuals Download Website

<http://myh66.com>

<http://usermanuals.us>

<http://www.somanuals.com>

<http://www.4manuals.cc>

<http://www.manual-lib.com>

<http://www.404manual.com>

<http://www.luxmanual.com>

<http://aubethermostatmanual.com>

Golf course search by state

<http://golfingnear.com>

Email search by domain

<http://emailbydomain.com>

Auto manuals search

<http://auto.somanuals.com>

TV manuals search

<http://tv.somanuals.com>