

ADE-9040

**Intel® Core™ 2 Duo Desktop
Q965 ATX Mother Board**

User's Manual

Rev. 1.0
2007/03/27

P/N: 600C002904010

Copyright

All rights reserved. The information contained in this guide has been validated and reviewed for accuracy. No patent liability is assumed with respect to the use of the information contained herein. While every precaution has been taken in the preparation of this guide, the Manufacturer assumes no responsibility for errors or omissions.

No part of this publication may be reproduced, stored in a retrieval system, or transmitted in any form or by any means, electronic, mechanical, photocopying, recording, or otherwise, without the prior written permission of Manufacturer.

Trademark

Intel[®], Pentium[®] and Celeron[®] are registered trademarks of Intel[®] Corporation.

Microsoft[®] and Windows[®] are registered trademarks of Microsoft Corporation.

All products and company names are trademarks or registered trademarks of their respective holders.

These specifications are subject to change without notice.

Technical Support

We hope you to get the maximum performance from your products and be willing to help if running into technical difficulties. For the most frequently asked questions, it's easily found answers from the product documentation and usually a lot more detailed, so please take reference to this manual first. If the answer still can not be found, gather all the information or questions applying to the problem, and with the product on hand, contact your distributor, sales representative, or customer service center for technical support. Most problems reported are minor and able to be easily solved over the phone. In addition, free technical support is available and always ready to give advices on application requirements or specific information on the installation and operation of any of our products.

Please have the following information ready before you call:

1. Product name and serial number
2. Description of your peripheral attachments
3. Description of your software (operating system, version, application software, etc.)
4. A complete description of the problem
5. The exact wording of any error messages

How to Use This Manual

This manual is written for the system integrator, PC technician and knowledgeable PC end user. It describes how to configure your ADE-9040 to meet various operating requirements. The user's manual is divided into four chapters, with each chapter addressing a basic concept and operation of the server board.

Chapter 1: Introduction - presents what you have inside the box and gives you an overview of the product specifications and basic system architecture for the ADE-9040 server board.

Chapter 2: Hardware Configuration Setting - shows the definitions and locations of Jumpers and Connectors so that you can easily configure your system.

Chapter 3: System Installation - describes how to properly mount the CPU, main memory, and M-System Flash disk for a safe installation. It will also introduce and show you the driver installation procedure for the Graphics Controller and Ethernet Controller.

Chapter 4: BIOS Setup Information - specifies the meaning of each setup parameter, how to get advanced BIOS performance and update to a new BIOS.

Table of Content

1.	Introduction.....	8
1.1	Description.....	8
1.2	Packing Check List.....	9
1.3	Specifications	10
1.4	System Architecture.....	12
1.5	Dimensions	13
2.	Hardware Configuration Setting.....	15
2.1	Board Layout	15
2.2	Jumpers & Connectors	16
2.3	Jumpers/Connectors Setting.....	17
2.3.1	RTC Clear CMOS (JP1)	17
2.3.2	BIOS Write Protect (JP2).....	17
2.3.3	AT/ATX Power Select (JP3).....	17
2.3.4	DVI Select (JP4).....	17
2.3.5	P-ATA Select (JP5).....	17
2.3.6	COM2 RS-232/422/485 Select (JPB1)	17
2.3.7	USB 2/3/4/5/0/1 & LAN1/2 Connectors (CN1, CN2, CN22).....	17
2.3.8	Internal USB 6/7/8/9 Connectors (CN23, CN24)	17
2.3.9	CPU/System/Chassis Fan Connector (CN4, CN5, CN6).....	17
2.3.10	CD-In from CD-ROM (CN13).....	17
2.3.11	Extend Line-out Connector (CN14)	17
2.3.12	Audio Connector (CN15)	18
2.3.13	PS/2 Keyboard & Mouse Connector (CN17)	18
2.3.14	Extend Keyboard & Mouse Connector (CN18).....	18
2.3.15	Digital I/O Connector (CN19).....	18
2.3.16	VGA & Serial Port 1 Connector (CN20)	18
2.3.17	Serial Port 4 Connector (CN21).....	18
2.3.18	Serial Port 3 & 2 Connectors (CN29, CN30)	18
2.3.19	4-pin ATX Power Connector (CN25).....	19
2.3.20	24-pin ATX Power Connector (CN26).....	19
2.3.21	Front Panel Connector (CN27).....	19
2.3.22	DVI Connector (CN31)	20
2.3.23	Serial ATA 1/2/3/4 Connectors (SATA1, SATA2, SATA3, SATA4)	20

3.	System Installation	22
3.1	Intel® µFC-LGA775 Processor	22
3.1.1	Installing Intel® Core™ 2 Duo / Pentium® 4 / Celeron® D CPU.....	22
3.1.2	Installing Intel µFC-LGA 775 CPU Fan, and Heat Sink	23
3.1.3	Removing CPU.....	23
3.2	Main Memory	24
3.3	Installing the ATX Mother Board	25
3.4.1	Dual Marvell Gigabit Ethernet Controllers	25
3.4.2	Drivers Support	25
4.	BIOS Setup	27
4.1	Entering Setup	27
4.1.1	Main Menu.....	27
4.1.2	Advanced Setting	28
4.1.3	Advanced PCI/PnP Setting.....	43
4.1.4	Boot Settings	46
4.1.5	Security Settings	49
4.1.6	Advanced Chipset Settings	50
4.1.7	Exit Options	55

Revision History

Revision	Date	Comment
Rev.1.0	Mar. 2007	Initial released



CHAPTER 1

1. Introduction

1.1 Description

Taking advantages of Intel energy-efficient dual-core processing, ADE-9040 ATX Mother Board adopts Intel® Core™ 2 Duo Desktop processors up to 1066 MHz FSB and Intel® Q965 Express chipset with Intel® ICH8R RAID function to fit the high performance computer system applications for meeting today's demanding pace and keep complete compatibility with hardware and software designed. The onboard devices support one PCI Express x16 for an alternative graphics add-in card, one PCI Express x1, four PCI slots, integrated graphics, and built dual Marvell 88E8053 Gigabit Ethernet controllers offering stable high-speed networking.

ADE-9040 comes with the Intel® GMA 3000 graphics supporting DVMT 4.0 display memory up to 256 MB for dual display function by VGA/DVI. The board also features two DIMMs up to 4 GB SDRAM with dual channel DDR2 533/667/800, enhanced onboard one SATA to Parallel ATA IDE interface supporting Ultra ATA 33/66/100 synchronous mode feature, four Serial ATA high-speed data transferring at up to 3 GB/s, and 7.1 + 2 CH HDAC through Realtek ALC883 audio codec. The onboard ITE IT8712F Super I/O chipset supports four serial ports: one RS-232 serial port interfaces, two RS-232 and one RS-232/422/485 pin headers, Hardware Monitor function, ten Hi-speed USB 2.0 ports, two 6-pin Mini-DIN connectors for PS/2 mouse and keyboard, and one 24-pin standard connector designed to support ATX power function. Besides, a feature of CPU overheat protection will provide user more security and stability.

Built with these impressed functions, ADE-9040 ATX Mother Board are those ideal solutions for DVR, KIOSK, medical equipment, industrial automation, financial automation, process control, semiconductor equipment, and network security markets.

1.2 Packing Check List

The ADE-9040 package includes the following basic items accompany with this manual.

- One ADE-9040 ATX Mother Board
- One Quick Installation Guide for ADE-9040
- One 40-pin IDE cable
- Two Serial ATA cable
- One Serial port cable for COM2 or COM3
- One Serial port cable for COM4
- One USB 2.0 cable
- One I/O shield
- One Supporting CD-ROM contains User's Manual and internal VGA display driver and Marvell Gigabit Ethernet network controller driver and on board devices drivers

If any of these items is damaged or missed, please contact your vendor and save all packing materials for future replacement and maintenance.

1.3 Specifications

System	
CPU	Intel® Core™ 2 Duo Desktop / Pentium® D / Pentium® 4 / Celeron® D processor in the LGA775 package (E6000, 900, 800, 600, 500, 300 sequences)
FSB	1066/800/533 MHz
BIOS	AMI BIOS with 8 Mb Flash EEPROM
System Chipset	Intel® Q965 + ICH8R
I/O Chip	ITE IT8718F I/O controller
System Memory	2 x 240-pin DIMM sockets support dual channel DDR2 533/667/800 SDRAM Max. up to 4 GB memory
Storage	1 x SATA to Parallel ATA IDE port with UDMA 33, ATA-66/100 support 4 x Series ATA 300 ports
RAID	ICH8R supports RAID 0, 1, 5, 10 function
Watchdog Timer	Reset: 1 sec.~255 min. and 1 sec. or 1 min./step
H/W Status Monitor	Monitoring system temperature, voltage, and cooling fan status. Auto throttling control when CPU overheats. System automatically restored on recovery of AC power loss.
GPIO	On-board programmable 8-bit Digital I/O interface
Expansion	1 x PCI Express x16, 1 x PCI Express x1 and 4 x PCI slots
MIO	
Internal I/O	1 x IrDA, 2 x RS-232, 1 x RS-232/422/485, 4 x USB 2.0
Back Panel I/O	1 x VGA, 1 x Audio jack, 2 x RJ-45, 1 x RS-232, 6 x USB 2.0, 1 x KB, 1 x Mouse
Display	
Chipset	Intel® Q965 Integrated GMA 3000 graphics
Display Memory	Intel® DVMT 4.0 supports up to 256 MB video memory
Resolution	Analog display : up to 2048 x 1536 @ 75Hz (QXGA) Digital LVDS : up to 2048 x 1536 @ 60 Hz
VGA/LCD Interface	DSUB-15 connector for VGA output
DVI	Chrontel CH7307 DVI transmitter

Audio	
HDAC	Realtek ALC883 7.1 + 2CH audio codec
Audio Interface	Mic in, Line in, CD Audio in, Line out, Rear out and Center/Subwoofer out
Ethernet	
Chipset	Dual Marvell® 88E8053 PCI Express™ Gigabit Ethernet controllers
Ethernet Interface	IEEE 802.3 10BASE-T/100BASE-TX/1000BASE-T
Mechanical & Environmental	
Power Requirement	+3.3 V @ 4.73 A, +5 V @ 0.96 A, +12 V @ 9.11 A, -12 V @ 0.01 A,, 5 VSB @ 0.07A
Power Type	24-pin ATX power connector, 1 x 4-pin ATX 12V power connector
FAN Connector	1 x CPU, 2 x system with DC 12V
Operating Temperature	0~60°C (32~140°F)
Operating Humidity	0%~90% relative humidity, non-condensing
Size (L x W)	12" x 8.7" (305 mm x 220 mm)
Weight	1.44 lbs (650 g)

1.4 System Architecture

All of details operating relations are shown in ADE-9040 system block diagram.

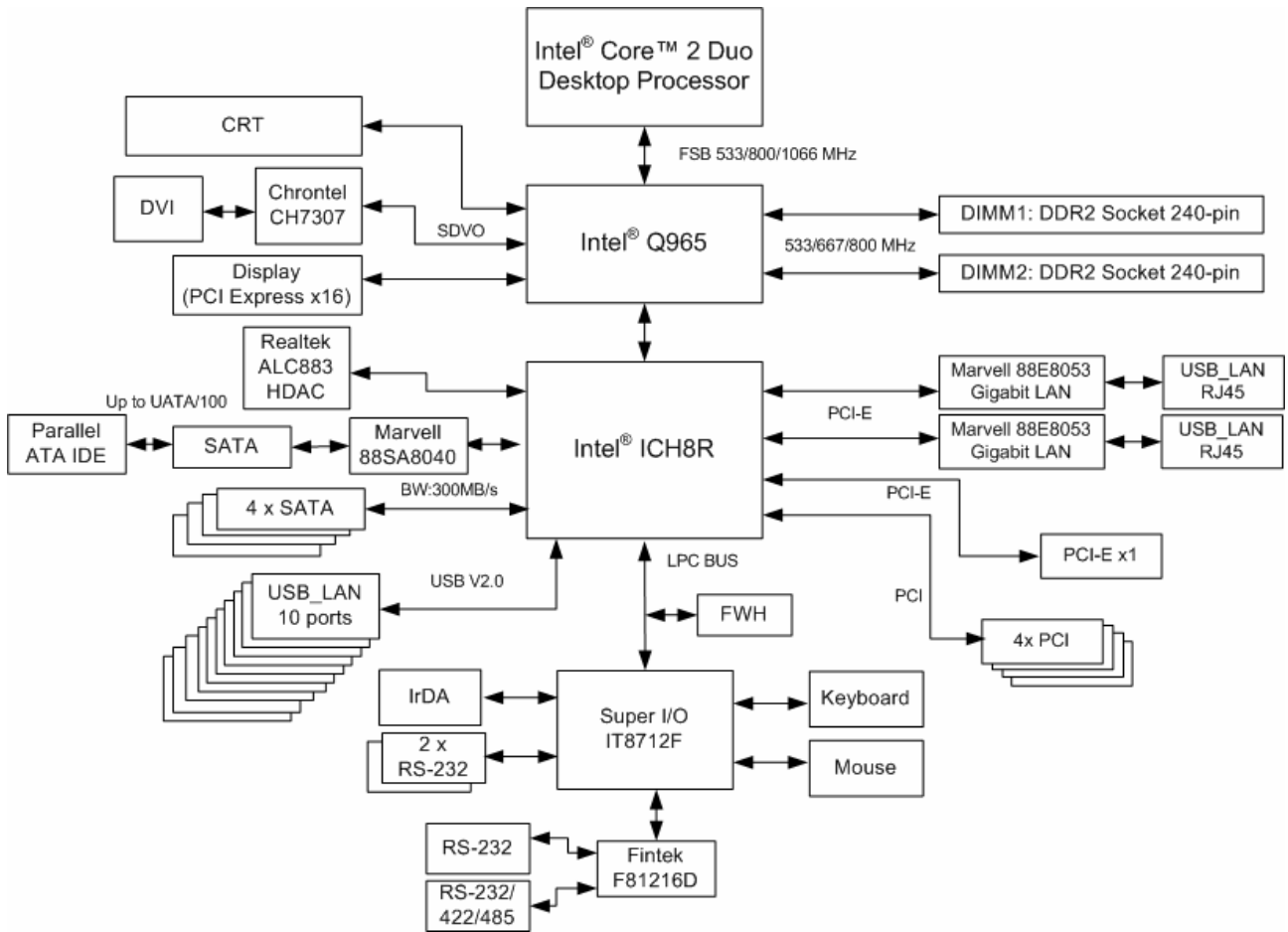

1.5 Dimensions

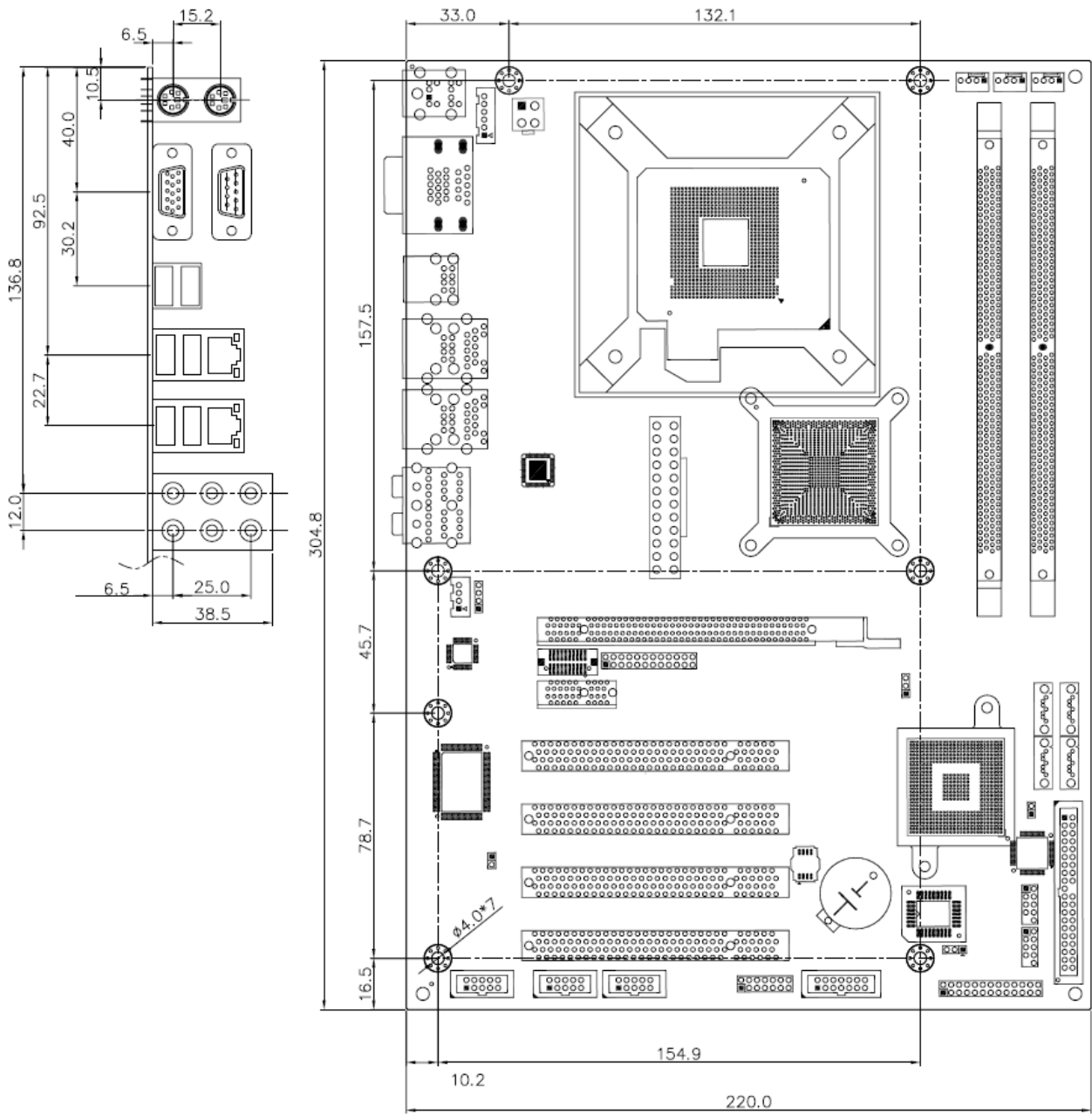

Unit: mm



CHAPTER 2

2. Hardware Configuration Setting

This chapter gives the definitions and shows the positions of jumpers, headers and connectors. All of the configuration jumpers on ADE-9040 are in the proper position. The default settings shipped from factory are marked with an asterisk (★).

In general, jumpers on the ATX Main Board are used to select options for certain features. Some of the jumpers are designed to be user-configurable, allowing for system enhancement. The others are for testing purpose only and should not be altered. To select any option, cover the jumper cap over (SHORT) or remove (NC) it from the jumper pins according to the following instructions. Here, NC stands for "Not Connect".

2.1 Board Layout

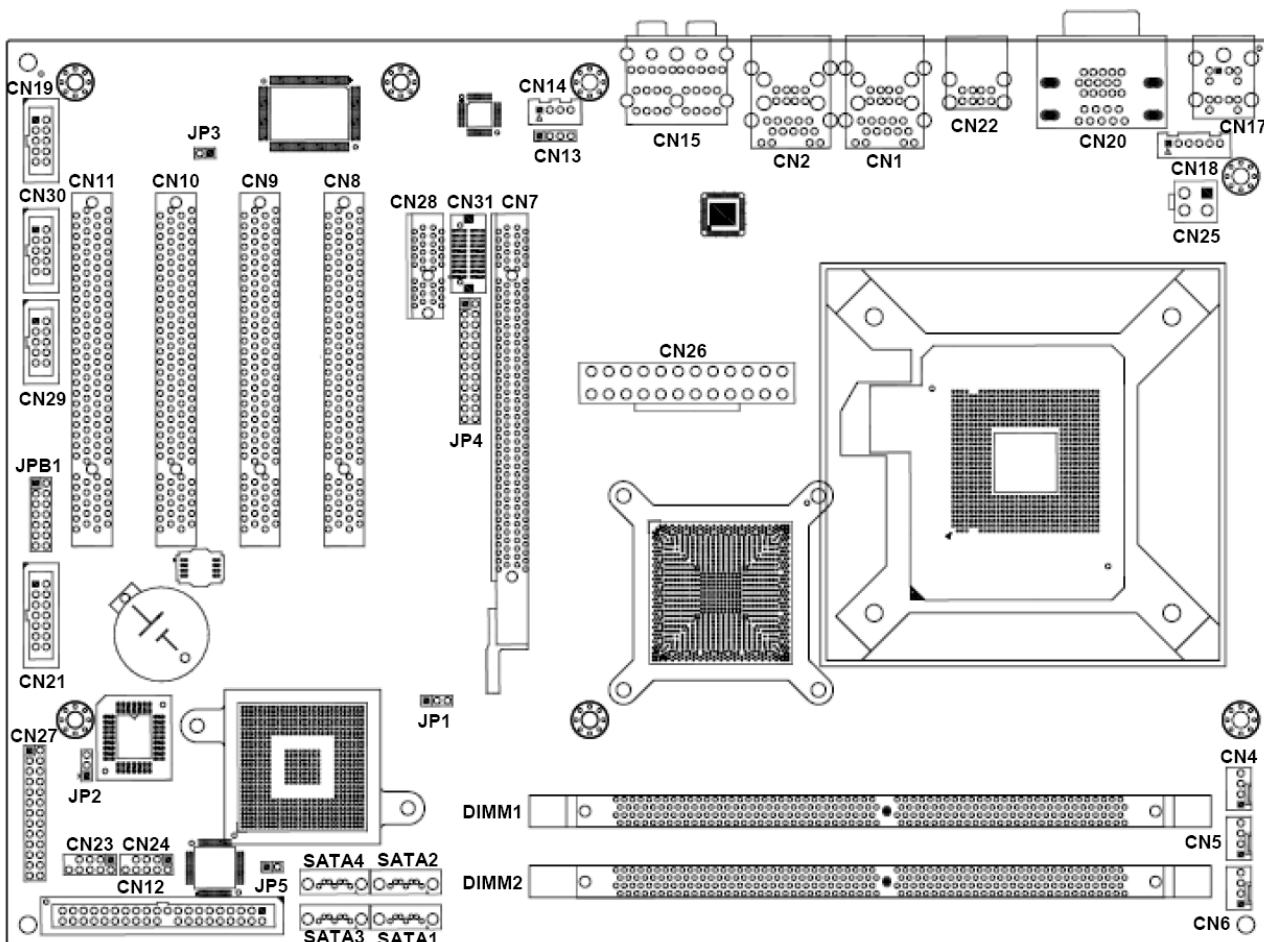

2.2 Jumpers & Connectors

JUMPERS	FUNCTION	REMARK
JP1	RTC CMOS clear select	1 x 3 header
JP2	BIOS write protect	1 x 3 header
JP3	AT/ATX power select	1 x 2 header
JP4	DVI select	2 x 12 header
JP5	PATA select	1 x 2 header
JPB1	COM4 RS-232/422/485 select	2 x 7 header

CONNECTORS	FUNCTION	REMARK
CN1, CN2	USB 2/3/4/5 & RJ-45 LAN 1/2 connector	
CN4	CPU fan connector	1 x 4 wafer
CN5	System fan connector	1 x 4 wafer
CN6	Chassis fan connector	1 x 4 wafer
CN7	PCI-Express x16 connector	
CN8, CN9, CN10, CN11	PCI connector 1, 2, 3 & 4	
CN12	Primary IDE connector	2 x 20 header
CN13	CD-In from CD-ROM connector	1 x 4 header
CN14	Extend Line-out connector	1 x 4 wafer
CN15	Audio connector	Audio jack
CN17	PS/2 keyboard & mouse connector	
CN18	Extend keyboard & mouse connector	1 x 6 header
CN19	Digital IO connector	2 x 5 header
CN20	D-sub 15-pin VGA & D-sub 9-pin serial port 1 connectors	
CN21	Serial port 4 connector	2 x 7 header
CN22	USB 0 & 1 connectors	
CN23, CN24	USB 6, 7 & 8, 9 connectors	2 x 5 header
CN25	4-pin ATX power connector	
CN26	24-pin ATX power connector	
CN27	Front panel connector	
CN28	PCI Express x1 connector	2 x 13 header
CN29, CN30	Serial port 3 & 2 connectors	
CN31	DVI connector	
DIMM1, DIMM2	240-pin DDR2 DIMM socket	
SATA1, SATA2	Serial ATA connector 1, 2	
SATA3, SATA4	Serial ATA connector 3, 4	

2.3 Jumpers/Connectors Setting

2.3.1 RTC Clear CMOS (JP1)

PIN No.	Description
1-2	Normal operation ★
2-3	Clear CMOS

2.3.2 BIOS Write Protect (JP2)

PIN No.	Description
1-2	BIOS write disabled ★
2-3	BIOS write enabled

2.3.3 AT/ATX Power Select (JP3)

PIN No.	Description
Open	ATX Power ★
1-2	AT Power

2.3.4 DVI Select (JP4)

Item.	Description
Open	PCI Express x16 Display ★
DVI	1-2, 3-4, 5-6, 7-8,9-10,11-12, 13-14, 15-16, 17-18, 19-20,21-22,23-24 short

2.3.5 P-ATA Select (JP5)

PIN No.	Description
Open	P-ATA enabled ★
1-2	P-ATA disabled

2.3.6 COM2 RS-232/422/485 Select (JPB1)

PIN No.	RS-232 ★	RS-422	RS-485
1-2	OFF	ON (Term.)	ON (Term.)
3-4	OFF	ON (Term.)	ON (Term.)
5-6	OFF	OFF	ON
7-8	OFF	ON	OFF
9-10	OFF	ON	ON
11-12	ON	OFF	OFF
13-14	OFF	OFF	ON

2.3.7 USB 2/3/4/5/0/1 & LAN1/2 Connectors (CN1, CN2, CN22)

LAN 1/2

PIN No.	Description	PIN No.	Description
1	TX+	5	NC
2	TX-	6	RX-
3	RX+	7	NC
4	NC	8	NC

USB 0/1/2/3/4/5

PIN No.	Description	PIN No.	Description
1	+5 V (fused)	5	+5 V (fused)
2	USBP0-/2-/4-	6	USBP1-/3-/5-
3	USBP0+/2+/4+	7	USBP1+/3+/5+
4	Ground	8	Ground

2.3.8 Internal USB 6/7/8/9 Connectors (CN23, CN24)

PIN No.	Description	PIN No.	Description
1	+5V	6	USBP7+/9+
2	+5V	7	Ground
3	USBP6-/8-	8	Ground
4	USBP7-/9-	9	NC
5	USBP6+/8+	10	NC

2.3.9 CPU/System/Chassis Fan Connector (CN4, CN5, CN6)

PIN No.	Description
1	Ground
2	+12V
3	Fan Status Signal
4	Fan Speed Control

2.3.10 CD-In from CD-ROM (CN13)

PIN No.	Description
1	CD-L
2	CD-Ground
3	CD-Ground
4	CD-R

2.3.11 Extend Line-out Connector (CN14)

PIN No.	Description
1	LINE_OUT_L
2	GND
3	GND
4	LINE_OUT_R

2.3.12 Audio Connector (CN15)

PIN No.	Description	PIN No.	Description
1(Orange)	Central out	4(Blue)	Line-in
2(Black)	Surround out	5(Green)	Line-out
3(Gray)	Side out	6(Red)	Mic-in

2.3.13 PS/2 Keyboard & Mouse Connector (CN17)

PIN No.	Description	PIN No.	Description
1	Keyboard Data	7	Mouse Data
2	NC	8	NC
3	Ground	9	Ground
4	+5V	10	+5V
5	Keyboard Clock	11	Mouse Clock
6	NC	12	NC

2.3.14 Extend Keyboard & Mouse Connector (CN18)

PIN No.	Description
1	Mouse Clock
2	Mouse Data
3	Keyboard Clock
4	Keyboard Data
5	Ground
6	+5V

2.3.15 Digital I/O Connector (CN19)

Description	PIN No.	PIN No.	Description
ISO_I1	2	1	EXT_VDD
ISO_I2	4	3	ISO_O1
ISO_I3	6	5	ISO_O2
ISO_I4	8	7	ISO_O3
EXT_VSS	10	9	ISO_O4

2.3.16 VGA & Serial Port 1 Connector (CN20)

COM1

PIN No.	Description
1	Data Carrier Detect
2	Received Data
3	Transmit Data
4	Data Terminal Ready
5	Ground
6	Data Set Ready
7	Request To Send
8	Clear To Send
9	Ring Indicator
10	Not used

VGA

Description	PIN No.	PIN No.	Description
Green Signal	2	1	Red Signal
NC	4	3	Blue Signal
Ground	6	5	Ground
Ground	8	7	Ground
Ground	10	9	+5V
DCC_DATA	12	11	NC
VSYNC	14	13	HSYNC
		15	DCC_CLK

2.3.17 Serial Port 4 Connector (CN21)

Description	PIN No.	PIN No.	Description
DCD	1	2	DSR
RXD	3	4	RTS
TXD	5	6	CTS
DTR	7	8	RI
Ground	9	10	Ground
TX+	11	12	TX-
RX+	13	14	RX-

2.3.18 Serial Port 3 & 2 Connectors (CN29, CN30)

Description	PIN No.	PIN No.	Description
DCD	1	2	DSR
RXD	3	4	RTS
TXD	5	6	CTS
DTR	7	8	RI
Ground	9	10	Ground

2.3.19 4-pin ATX Power Connector (CN25)

PIN No.	Description
1	GND
2	GND
3	+12V
4	+12V

2.3.20 24-pin ATX Power Connector (CN26)

Description	PIN No.	PIN No.	Description
+3.3V	13	1	+3.3V
-12V	14	2	+3.3V
Ground	15	3	Ground
PS_ON	16	4	+5V
Ground	17	5	Ground
Ground	18	6	+5V
Ground	19	7	Ground
-5V	20	8	PW_OK
+5V	21	9	5VSB
+5V	22	10	+12V
+5V	23	11	+12V
Ground	24	12	+3.3V

2.3.21 Front Panel Connector (CN27)

IrDA

PIN No.	Signal Description
1	+5V
5	IRRX
7	Ground
9	IRTX

System Reset

PIN No.	Signal Description
2	Reset
4	Ground

External Speaker

PIN No.	Signal Description
8	Speaker
14	+5V

IDE Active LED

PIN No.	Signal Description
13	+5V (Pull-up for HDD LED)
15	HDD active# (LED cathode terminal)

System Power On LED

PIN No.	Signal Description
18	+5V
22	Power On

System Power On Switch

PIN No.	Signal Description
23	Power button control signal
25	Ground

Keyboard Lock

PIN No.	Signal Description
24	Keyboard lock
26	Ground

2.3.22 DVI Connector (CN31)

Description	PIN No.	PIN No.	Description
HPDET	1	2	Ground
Ground	3	4	DVIDATA
TDC0#	5	6	DVICLK
TDC0	7	8	Ground
Ground	9	10	TLC#
TDC1#	11	12	TLC
TDC1	13	14	Ground
Ground	15	16	Ground
TDC2#	17	18	Ground
TDC2	19	20	+5V

Signal	Type	Description
TDC0,TDC0#	O	DVI Data Channel 0 Output: These pins provide the DVI differential output for data channel 0 (Blue).
TDC1,TDC1#	O	DVI Data Channel 1 Output: These pins provide the DVI differential output for data channel 1 (Green).
TDC2,TDC2#	O	DVI Data Channel 2 Output: These pins provide the DVI differential output for data channel 2 (Red).
HPDET	I	Hot Plug Detect (internal pull-down): This input determines whether the DVI is connected to a DVI monitor. When terminated, the monitor is required to apply a voltage greater than 2.4 volts. Changes on the status of this pin will be relayed to the graphics controller via the P-OUT/TLDET* or GPIO(1)/TLDET* pin pulling low.
DVIDATA	I/O	DVI I2C Data: This signal is used as the I2C DOC clock for a digital display connector (i.e. TV-Out Encoder, TMDS transmitter). This signal is tri-stated during a hard reset.
DVICLK	I/O	DVI DOC Clock: This signal is used as the DOC clock for a digital display connector (i.e. primary digital monitor). This signal is tri-stated during a hard reset.
TLC,TLC#	O	DVI Clock Output: These pins provide the differential clock outputs to the DVI interface corresponding a data on TDC(0:2) outputs.

2.3.23 Serial ATA 1/2/3/4 Connectors (SATA1, SATA2, SATA3, SATA4)

These SATA connectors support Serial ATA 300. Each SATA connector can only support one serial ATA device.

Note: With most storage devices, there is a power cable that you need attach to a power source (power supply).



CHAPTER 3

3. System Installation

This chapter provides you with instructions on how to setup your system. The additional information shows you how to install CPU/ FAN and memory.

3.1 Intel® μ FC-LGA775 Processor

3.1.1 Installing Intel® Core™ 2 Duo / Pentium® 4 / Celeron® D CPU

- The board comes with a surface mount LGA775 socket designed for the Intel® Pentium® 4 processor in the 775-land package.
- Remove the plastic cap to install the μ FC-LGA 775 Pentium 4 CPU.
- Unlock the socket by pressing the metal lever sideways to lift it up, and open the load plate. (1, 2, 3, 4)
- Position the CPU above the socket and the gold triangular mark on the CPU must align with pin 1 of the CPU socket. Then Insert the CPU gently seated in place.
- Close the load plate and push it back to the original position. (5, 6, 7)

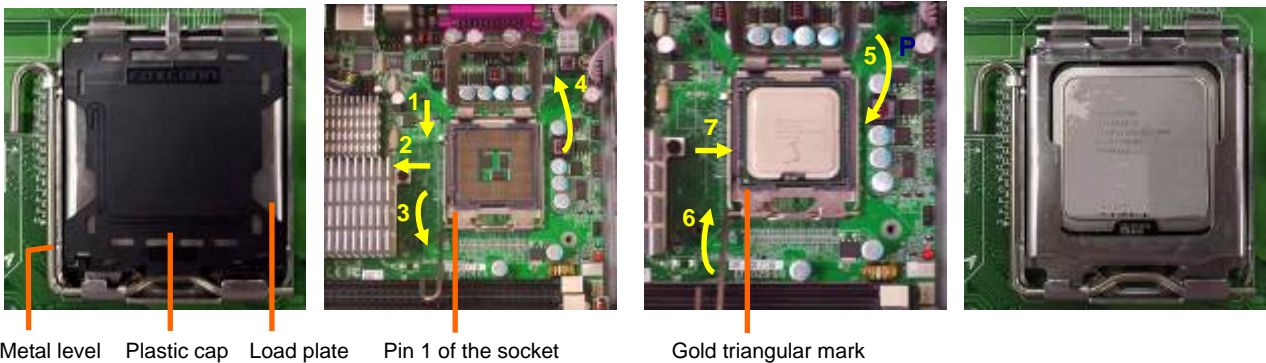

Note:

Do not force the CPU into the socket. It may bend the pins and damage the CPU.

3.1.2 Installing Intel μ FC-LGA 775 CPU Fan, and Heat Sink

- The Intel μ FC-LGA 775 CPU heat sink and fan assembly comes in a push-pin design and requires no tool to install.
- Place the fan with heat sink right above the CPU and make sure four pins matching the holes of the board. (8, 9)
- Press all push-pins down and rotate them to lock. (Please check the rear side of the board.)
- Place the CPU fan connector.

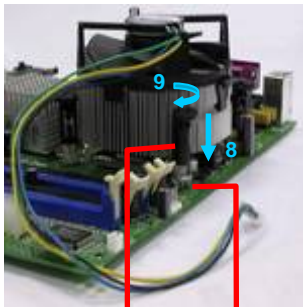

Push-pin Board's hole

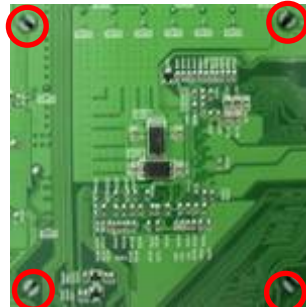

CPU fan connector

3.1.3 Removing CPU

- Disconnect the CPU fan connector.
- Remove the CPU fan and heat sink first.
- Unlock the Intel μ FC-LGA 775 Pentium 4 processor.
- Carefully lift up the existing CPU to remove it from the socket.
- Follow the steps of installing a CPU to change to another one.

Warning : For a safety landing, avoid leaving prongs on hard surface.

Instructions : Smear thermal grease on the top of the CPU. Lower the CPU fan onto the CPU/CPU socket and secure it using the attachments or screws provided on the fan. Finally, attach the fan power cable to the CPUFAN adapter. For more details on this, go to <http://www.intel.com>

3.2 Main Memory

ADE-9040 provides 2 DIMMs (240-pin Dual In-line Memory Module) to support 1.8V DDRAM (Synchronized DRAM) as on-board main memory. The maximum memory size is 256 MB ~ 4 GB with using 256MB/512MB/1GB technology. Supports up to 2 double sided DIMMs at DDR2 533/667/800MHz. The memory architecture adopts 128-bit data interface to support for x8 and x16 DDRAM(DDR2) device width. In addition, it only supports Non-ECC memory.

For system compatibility and stability, don't use memory module without brand. You can also use the single or double-side DIMM .The two DIMMs can be out of order. You can install different size of DDRAM module on DIMM1, DIMM2 or all to boot up system.

Without out the contact and lock integrity of memory module with socket, it will impact on the system reliability. Follow normal procedure to install your DDRAM module into memory socket. Before locking, make sure that the module has been fully inserted into the DIMM slot.

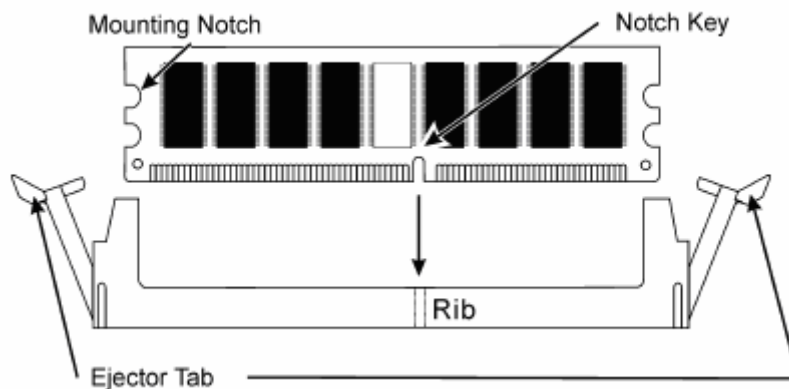

NOTE: For maintaining system stability, do not change any of DDR2 memory parameters in BIOS setup to upgrade your system performance without acquiring technical information.

3.3 Installing the ATX Mother Board

To install your ADE-9040 into standard chassis or proprietary environment, you need to perform the following steps:

1. Check all jumpers setting on proper position
2. Install and configure CPU and memory module on right position
3. Place ADE-9040 into the dedicated position in your system
4. Attach cables to existing peripheral devices and secure it

NOTE: Please refer section 3.4 to install display and Ethernet drivers and setup your system.

WARNING: Please ensure that your ATX Main Board properly inserted and fixed by mechanism. Otherwise, the system might be unstable or do not work from bad contact of golden finger.

3.4.1 Dual Marvell Gigabit Ethernet Controllers

Dual Marvell Gigabit Ethernet 10/100/1000BASE-TX controllers by PCI Express.

The ADE-9040 provides dual LED indicators on RJ-45 connectors to show LAN interface status. These messages will give you a guide for troubleshooting.

Yellow LED indicates transmit and receive activity.

Blinking: indicates transmit/receive activity

On: indicates no activity but link is valid

Off: link is invalid

Green LED indicates Link speed

On: link speed at 1000Mbps

On: link speed at 100Mbps

Off: link speed at 10Mbps

3.4.2 Drivers Support

ADE-9040 provide on CD-Title to support on-board VGA and Ethernet device drivers in various operating systems. Before installing the device drivers, please see the reference files in each sub-directory. You cannot install drivers from CD-Title directly.

Intel Q965 Chipset Integrated Graphics supports Win2000, XP, Win2003 and 64bit Windows environment.

Intel Q965 & ICH8(R) Chipset Driver supports Win2000, XP, Win2003 and 64bit Windows environment.

Dual Marvell Gigabit Ethernet Controllers support Win2000, XP, Win2003, and 64 bit Windows environment.



CHAPTER 4

4. BIOS Setup

4.1 Entering Setup

AMI BIOS has a built-in setup program that allows users to modify the basic system configuration. This information is stored in CMOS RAM whose power is supplied by a battery so that it can retain the setup information even when the power is turned off. Press Delete when you Power on or Reboot the computer system. (i.e. After the logo appears at the center of the screen, please press Delete to enter the BIOS setup program). In the BIOS, make sure that everything is working fine before you try to optimize it for maximum performance.

4.1.1 Main Menu

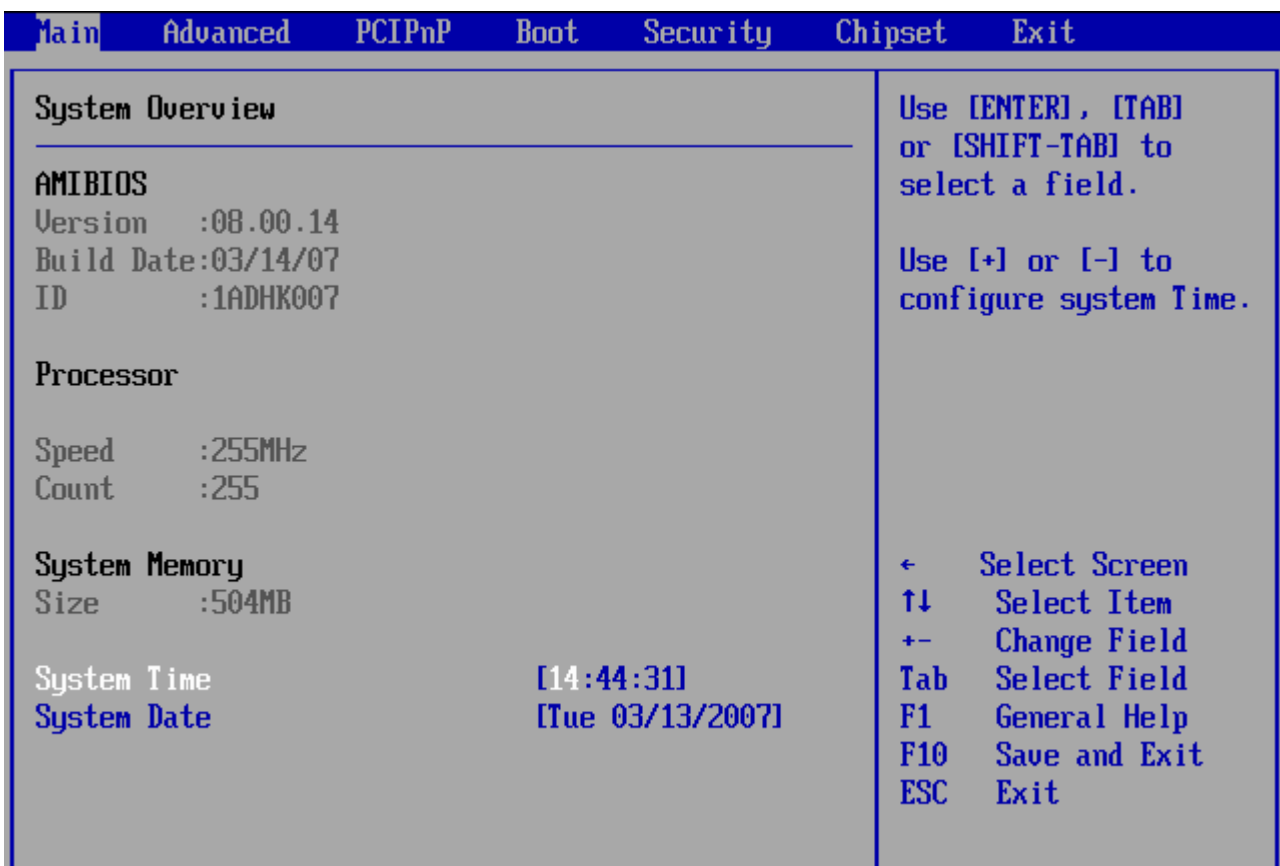

When you enter the AMI CMOS Setup Utility, the **Main** will appear on the screen. The Main allows you to select several configuration options. Use the left/right arrow keys to highlight a particular configuration screen from the top menu bar or use the down arrow key to access and configure the information below.

4.1.1.1 System Time / System Date

Use this option to change the system time and date. The date must be entered in MM/DD/YY format. The time is entered in HH:MM:SS format.

4.1.2 Advanced Setting

Main	Advanced	PCIPnP	Boot	Security	Chipset	Exit
<p>Advanced Settings</p> <hr/> <p>WARNING: Setting wrong values in below sections may cause system to malfunction.</p> <ul style="list-style-type: none"> ▶ CPU Configuration ▶ IDE Configuration ▶ SuperIO Configuration ▶ Hardware Health Configuration ▶ ACPI Configuration ▶ APM Configuration ▶ MPS Configuration ▶ Remote Access Configuration ▶ USB Configuration 						<p>Configure CPU.</p> <p>← Select Screen ↑↓ Select Item Enter Go to Sub Screen F1 General Help F10 Save and Exit ESC Exit</p>

4.1.2.1 CPU Configuration

The CPU Configuration setup screen varies depending on the installed processor.

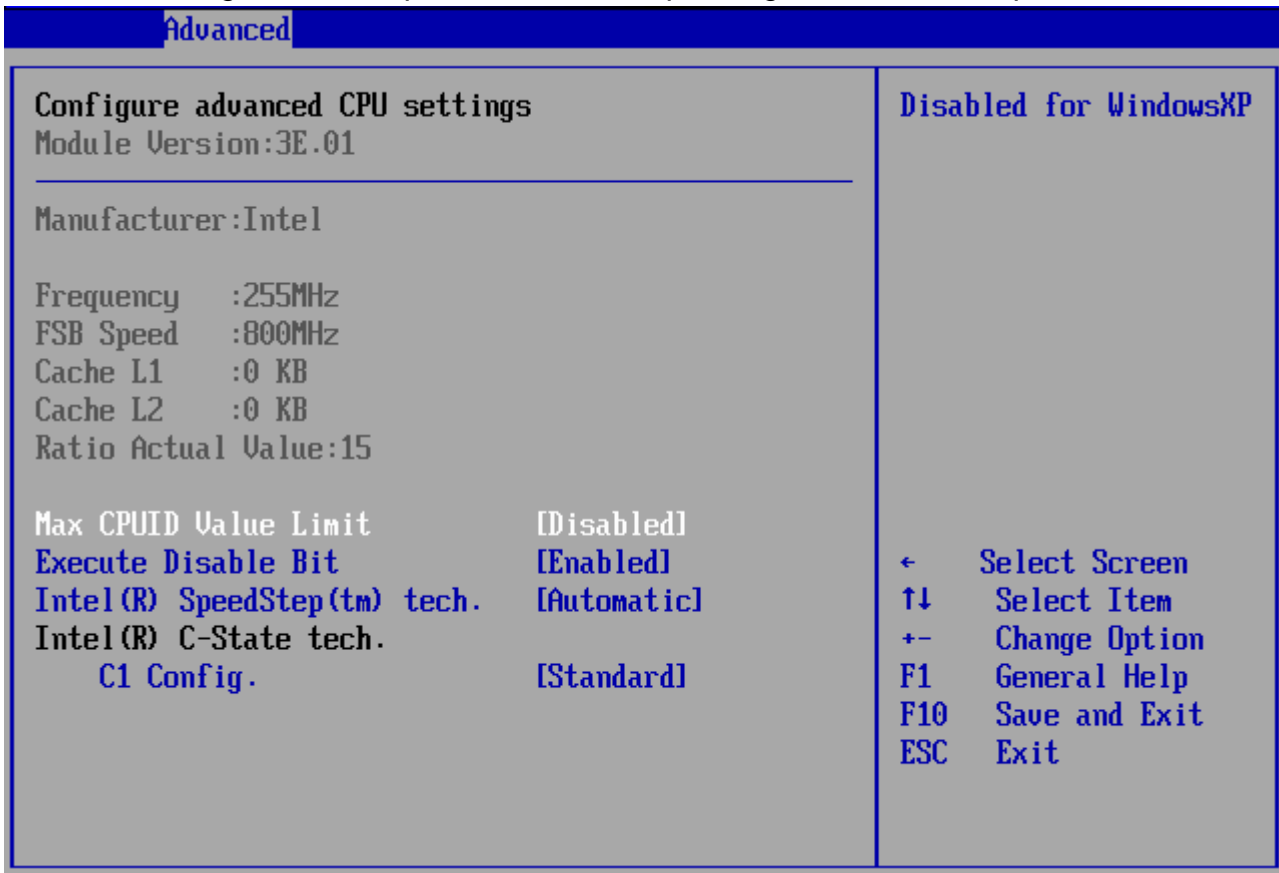

4.1.2.1.1 Max CPUID Value Limit

The Intel® Processor Identification Utility requires the 'Max CPUID Value Limit' in the system BIOS to be disabled for proper processor identification. Once processor identification has taken place, the option can be re-enabled if desired.

4.1.2.1.2 Execute Disable Bit

A feature designed to stop buffer overflow attacks against the operating system. Buffer overflow attacks are one of the most common tactics used to attack personal computers. The processor prevents the execution of code in data-only memory pages while enabled and will not restrict code execution in any memory area if disabled. This makes the processor more vulnerable to buffer overflow attacks

4.1.2.1.3 Intel® SpeedStep (tm) tech.

Intel (R) SpeedStep(tm) tech. is Intel's new power saving technology. Processor can switch between multiple frequency and voltage points to enable power savings. If you select [Auto], you need to set the "Power Schemes" as "Portable/Laptop" to enable this function. This option will be hidden if the current CPU does not support Intel SpeedStep(tm) tech..

4.1.2.1.4 Intel C-State tech

Specific C-State supports. Standard = Conventional C-State. Enhanced = Enhanced C-State.

4.1.2.2 IDE Configuration

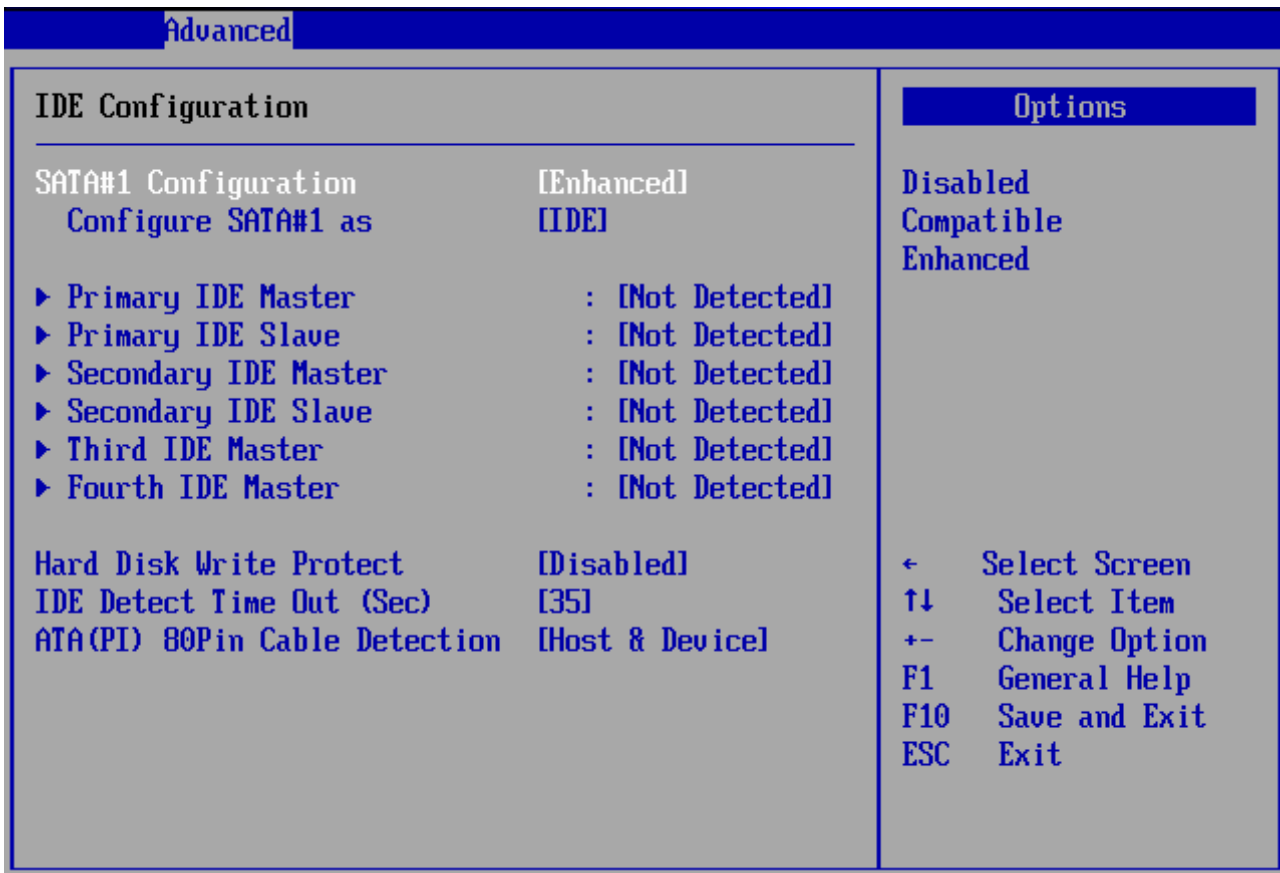

4.1.2.2.1 SATA#1 Configuration

Option: [Disabled], [Enhanced].

4.1.2.2.2 Configure SATA#1 as

Option: [IDE], [RAID]

4.1.2.2.3 Primary/Secondary IDE Master/Slave

Select one of the hard disk drives to configure it. Press <Enter> to access its the sub menu. The options on the sub menu are described in the following sections.

4.1.2.2.4 Hard Disk Write Protect

Set this option to protect the hard disk drive from being overwritten. The Optimal and Fail-Safe default setting is Disabled.

4.1.2.2.5 IDE Detect Time Out (Sec)

Set this option to stop the AMIBIOS from searching for IDE devices within the specified number of seconds. Basically, this allows you to fine-tune the settings to allow for faster boot times. Adjust this setting until a suitable timing that can detect all IDE disk drives attached is found.

The options: 0, 5, 10, 15, 20, 25, 30, 35 sec.

4.1.2.2.6 ATA(PI) 80Pin Cable Detection

Set this option to select the method used to detect the ATA (PI) 80 pin cable. The Optimal and Fail-Safe setting is Host & Device.

Item	Description
Host & Device	Set this value to use both the motherboard onboard IDE controller and IDE disk drive to detect the type of IDE cable used. This is the default setting.
Host	Set this value to use motherboard onboard IDE controller to detect the type of IDE cable used.
Device	Set this value to use IDE disk drive to detect the type of IDE cable used.

4.1.2.3 Super IO Configuration

Advanced	
<p>Configure ITE8718 Super IO Chipset</p> <hr/>	
Serial Port1 Address	[3F8/IRQ4]
Serial Port2 Address	[2F8/IRQ3]
Serial Port2 Mode	[Normal]
Restore on AC Power Loss by IO	[Last State]
Serial Port3 Address	[3E8]
Serial Port3 IRQ	[11]
Serial Port4 Address	[2E8]
Serial Port4 IRQ	[10]
	<p>Allows BIOS to Select Serial Port1 Base Addresses.</p>
	<p>← Select Screen ↑↓ Select Item +- Change Option F1 General Help F10 Save and Exit ESC Exit</p>

4.1.2.3.1 Serial Port1/2 Address

This option specifies the base I/O port address and Interrupt Request address of serial port 1/2. The Optimal setting is 3F8/IRQ4. The Fail-Safe default setting is Disabled.

Item	Description
Disabled	Set this value to prevent the serial port from accessing any system resources. When this option is set to <i>Disabled</i> , the serial port physically becomes unavailable.
3F8/IRQ4	Set this value to allow the serial port to use 3F8 as its I/O port address and IRQ 4 for the interrupt address. This is the default setting. The majority of serial port 1 or COM1 ports on computer systems use IRQ4 and I/O Port 3F8 as the standard setting. The most common serial device connected to this port is a mouse. If the system will not use a serial device, it is best to set this port to <i>Disabled</i> .
2F8/IRQ3	Set this value to allow the serial port to use 2F8 as its I/O port address and IRQ 3 for the interrupt address. If the system will not use a serial device, it is best to set this port to <i>Disabled</i> .
3E8/IRQ4	Set this value to allow the serial port to use 3E8 as its I/O port address and IRQ 4 for the interrupt address. If the system will not use a serial device, it is best to set this port to <i>Disabled</i> .
2E8/IRQ3	Set this value to allow the serial port to use 2E8 as its I/O port address and IRQ 3 for the interrupt address. If the system will not use a serial device, it is best to set this port to <i>Disabled</i> .

4.1.2.3.2 Serial Port2 Mode

Allows BIOS to select mode for Serial Port2.

4.1.2.3.3 Restore on AC Power Loss by IO

This item allows you to select if you want to power on the system after power failure.

Option: [Power On], [Power Off], [Last state].

4.1.2.3.4 Serial Port3/4 Address

Allows BIOS to select serial port 3/4 base addresses.

4.1.2.3.5 Serial Port3/4 IRQ

Allows BIOS to select serial port 3/4 IRQ.

4.1.2.4 Hardware Health Configuration

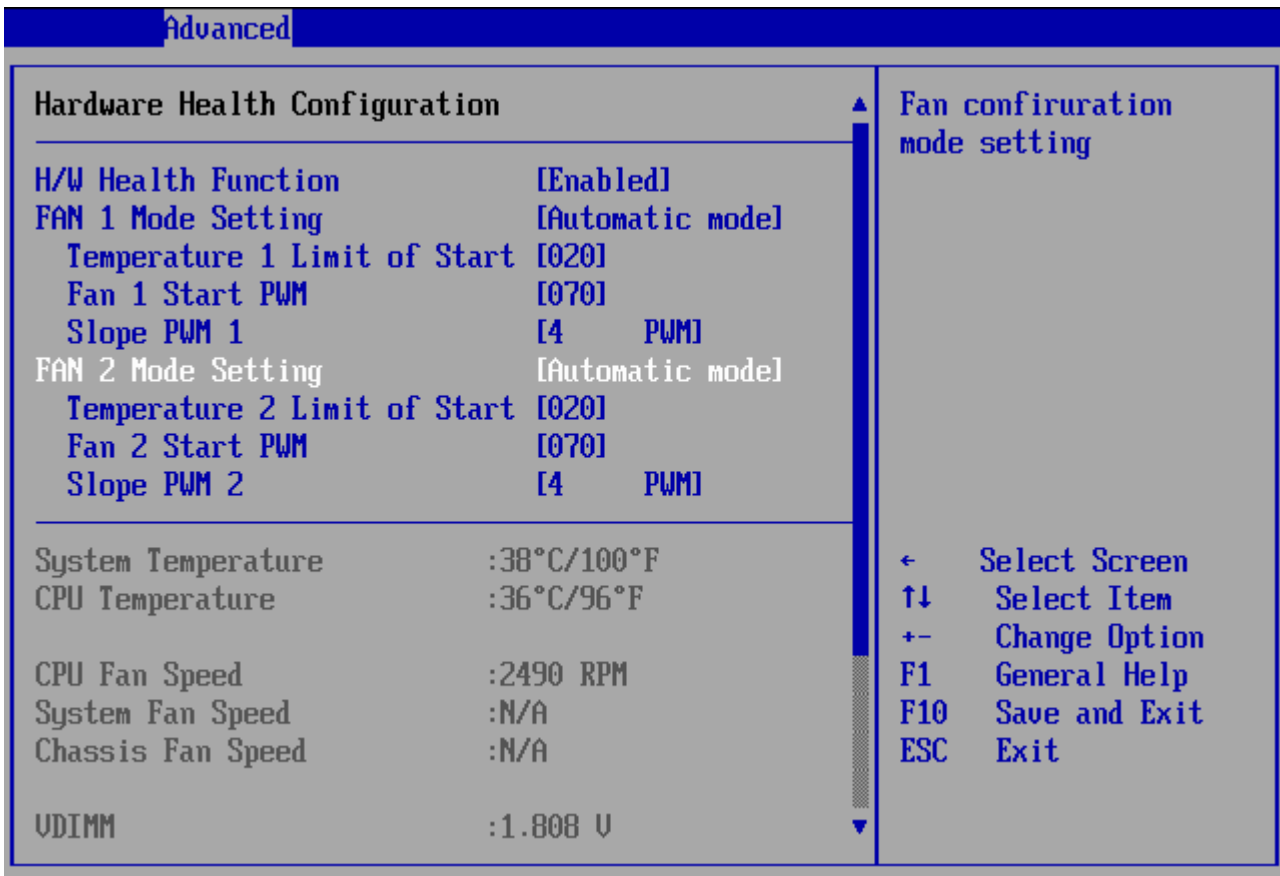

4.1.2.4.1 H/W Health Function

Enables Hardware Health Monitoring Device.

4.1.2.4.2 FAN 1 Mode Setting

This item allows you to set fan speed control mode.

Option: [Full On mode], [Automatic mode].

4.1.2.4.3 Temperature 1 Limit of Start

Fan spins in a start PWM value when temp exceeds a start limit

Min=0°C, Max=127°C, Please input Dec number:

4.1.2.4.4 Fan 1 Start PWM

Fan start PWM value.

Min=0, Max=127, Please input Dec number.

4.1.2.4.5 Slope PWM 1

The PWM value is subject to the temperature inputs by linear changing.

4.1.2.4.6 FAN 2 Mode Setting

This item allows you to set fan speed control mode.

Option: [Full On mode], [Automatic mode].

4.1.2.4.7 Temperature 2 Limit of Start

Fan spins in a start PWM value when temp exceeds a start limit

Min=0°C, Max=127°C, Please input Dec number:

4.1.2.4.8 Fan 2 Start PWM

Fan start PWM value.

Min=0, Max=127, Please input Dec number:.

4.1.2.4.9 Slope PWM 2

The PWM value is subject to the temperature inputs by linear changing.

4.1.2.5 ACPI Configuration

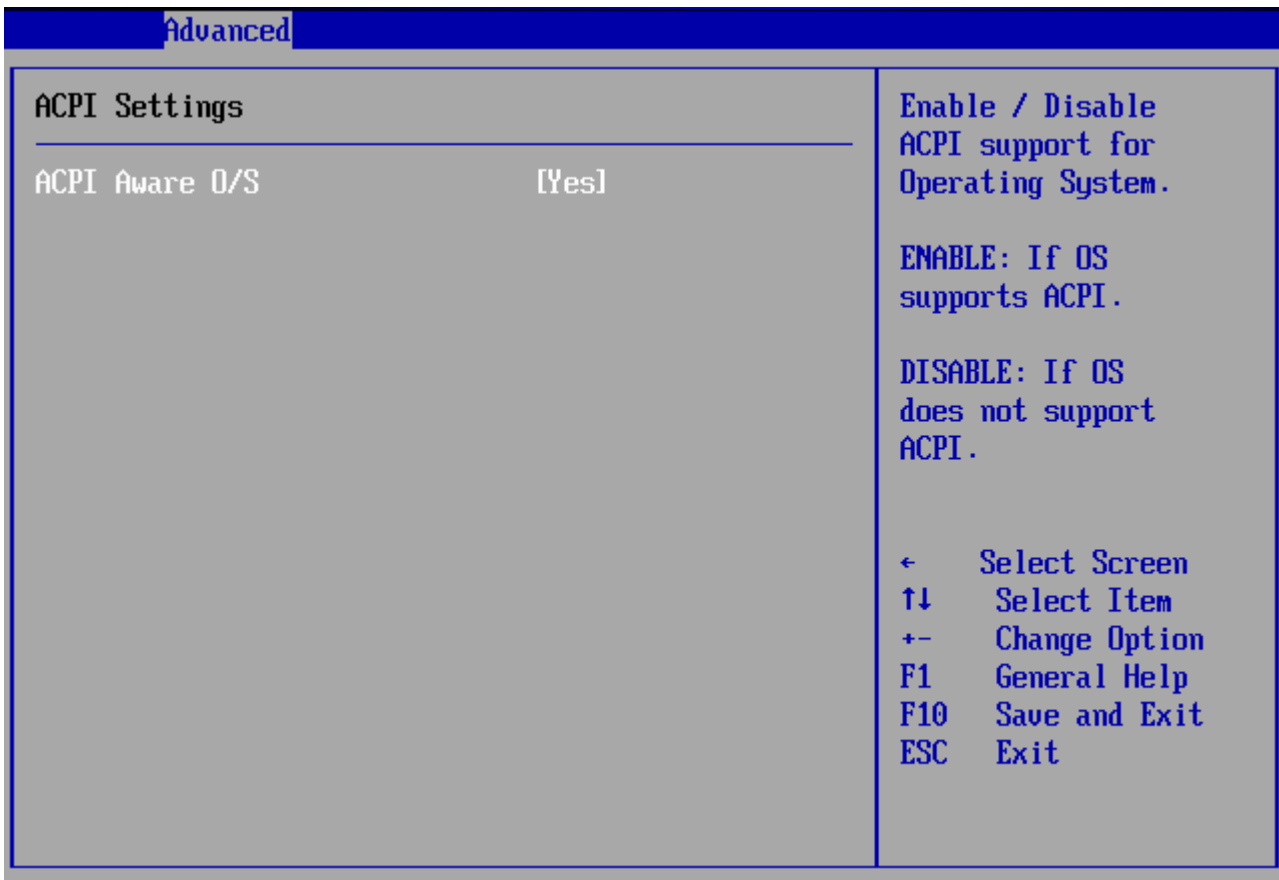

4.1.2.5.1 ACPI Aware O/S

Set this value to allow the system to utilize the Intel ACPI (Advanced Configuration and Power Interface) specification.

Item	Description
No	This setting should be set if the operating system in use does not comply with the ACPI (Advanced Configuration and Power Interface) specification. DOS®, Windows 3.x®, and Windows NT® are examples of non-ACPI aware operating systems.
Yes	This setting should be set if the operating system complies with the ACPI (Advanced Configuration and Power Interface) specification. This is the default setting. Windows 95®, Windows 98® and Windows 2000® are examples of ACPI aware operating systems.

4.1.2.6 APM Configuration

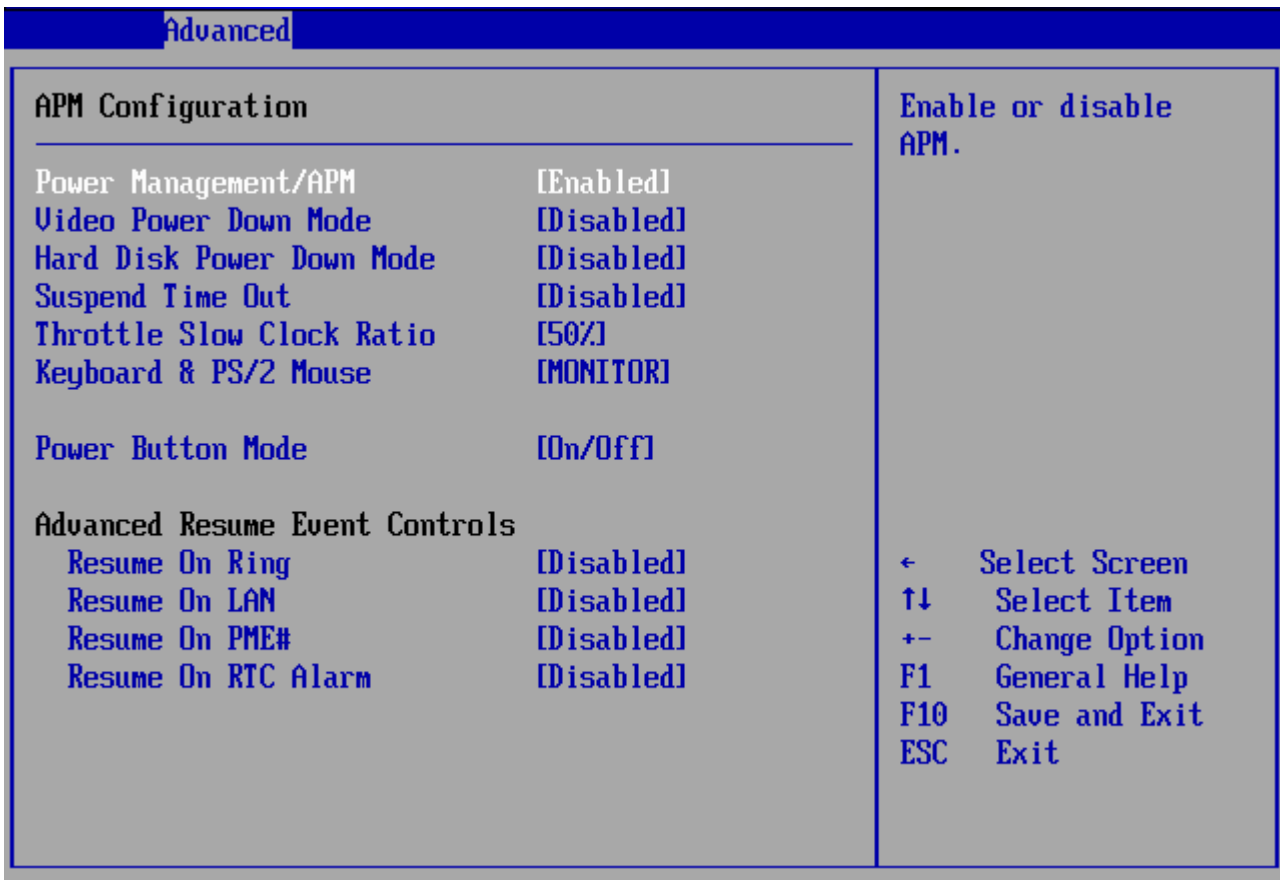

4.1.2.6.1 Power Management/APM

Set this value to allow Power Management/APM support.

4.1.2.6.2 Video Power Down Mode

This option specifies the length of time the system waits before it enters suspend mode. The options: Disabled, 1, 5, 10 Min.

4.1.2.6.3 Hard Disk Power Down Mode

This option specifies the power conserving state that the hard disk drive enters after the specified period of hard drive inactivity has expired.

The options: Disabled, Standby, Suspend.

4.1.2.6.4 Suspend Time Out

Go into Suspend in the specified time.

4.1.2.6.5 Throttle Slow Clock Ratio

In a power management state, the BIOS can throttle the CPU clock to reduce power consumption. For example, a throttle ratio of 50% means the clock is turned off half of its normal operational time.

The options: 87.5%, 75.0%, 62.5%, 50%, 37.5%, 25%, 12.5%.

4.1.2.6.6 Keyboard & PS/2 Mouse

Monitor KBC Ports 60/64.

4.1.2.6.7 Power Button Mode

This option specifies how the externally mounted power button on the front of the computer chassis is used.

The options: On/Off, Standby, Suspend.

4.1.2.6.8 Resume On Ring

Disable/Enable RI to generate a wake event.

4.1.2.6.9 Resume On LAN

Disable/Enable LAN GPI to generate a wake event.

4.1.2.6.10 Resume On PME#

Disable/Enable PME to generate a wake event.

4.1.2.6.11 Resume On RTC Alarm

Disable/Enable RTC to generate a wake event.

4.1.2.7 MPS Configuration

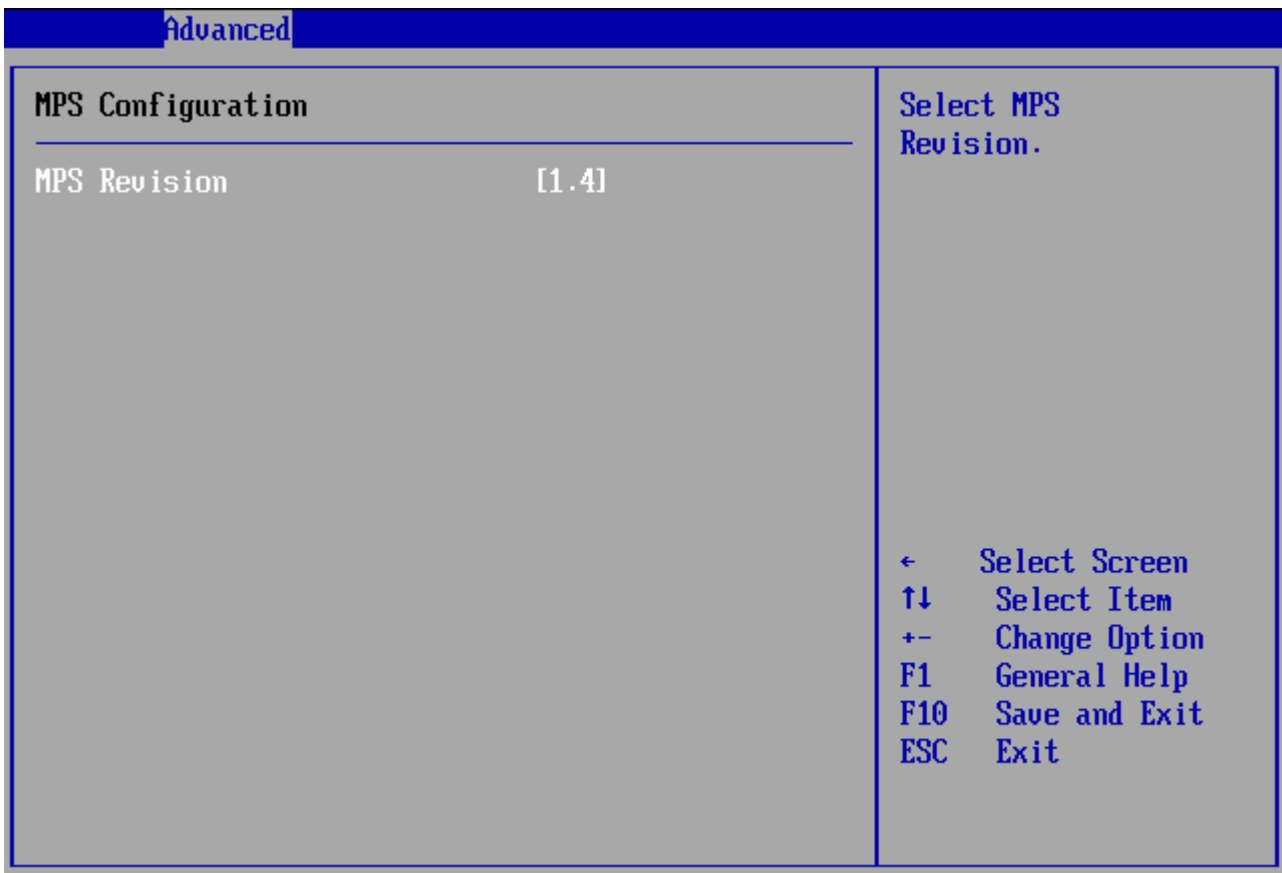

Select MPS Revision.

4.1.2.8 Remote Access Configuration

Advanced	
Configure Remote Access type and parameters	
Remote Access	[Enabled]
Serial port number	[COM1]
Base Address, IRQ	[3F8h, 4]
Serial Port Mode	[115200 8,n,1]
Flow Control	[None]
Redirection After BIOS POST	[Always]
Terminal Type	[ANSI]
VT-UTF8 Combo Key Support	[Enabled]
Sredir Memory Display Delay	[No Delay]
	Select Remote Access type. ← Select Screen ↑↓ Select Item +- Change Option F1 General Help F10 Save and Exit ESC Exit

4.1.2.8.1 Remote Access

You can disable or enable the BIOS remote access feature here.

4.1.2.8.2 Serial Port Number

Select serial port for console redirection. Make sure the selected port is enabled.

4.1.2.8.3 Flow Control

Select Flow Control for console redirection.

4.1.2.8.4 Redirection after BIOS POS

Disable: Turns off the redirection after POST Boot Loader: Redirection is active during POST and during Boot Loader. Always: Redirection is always active.

(Some OSs may not work if set to Always)

[Enabled] - keep it, [Disabled]- deactivate

4.1.2.8.5 Terminal Type

Select the target terminal type.

4.1.2.8.6 VT-UTF8 Combo Key Support

Enable VT-UTF8 Combination Key Support for ANSI/VT100 terminals.

4.1.2.8.7 Sredir Memory Display Delay

Gives the delay in seconds to display memory information.

4.1.2.9 USB Configuration

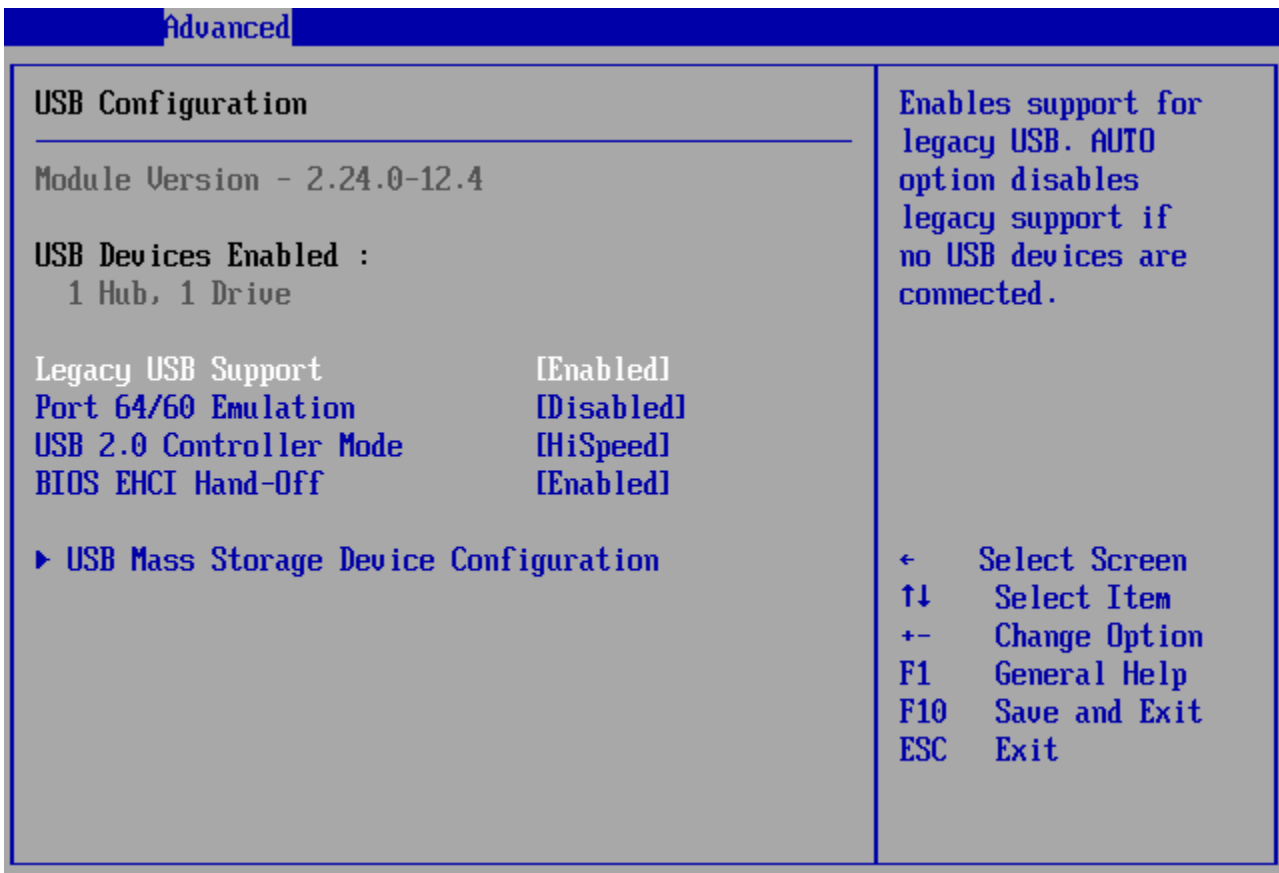

4.1.2.9.1 Legacy USB Support

Legacy USB Support refers to the USB mouse and USB keyboard support. Normally if this option is not enabled, any attached USB mouse or USB keyboard will not become available until a USB compatible operating system is fully booted with all USB drivers loaded. When this option is enabled, any attached USB mouse or USB keyboard can control the system even when there is no USB drivers loaded on the system. Set this value to enable or disable the Legacy USB Support. The Optimal and Fail-Safe default setting is *Disabled*.

4.1.2.9.2 Port 64/60 Emulation

Enables I/O port 60h/64h emulation support. This should be enabled for the complete USB keyboard legacy support for non-USB aware OSes.

4.1.2.9.3 USB 2.0 Controller Mode

Configures the USB 2.0 controller in HiSpeed (480Mbps) or FullSpeed (12Mbps).

4.1.2.9.4 BIOS EHCI Hand-Off

This is a workaround for OSes without EHCI hand-off support. The EHCI ownership change should claim by EHCI driver.

4.1.2.9.5 USB Mass Storage Device Configuration

Advanced	
USB Mass Storage Device Configuration	
USB Mass Storage Reset Delay [20 Sec]	Number of seconds POST waits for the USB mass storage device after start unit command.
Device #1 USB Flash Disk Emulation Type [Auto]	
← Select Screen ↑↓ Select Item +- Change Option F1 General Help F10 Save and Exit ESC Exit	

4.1.2.9.5.1 Emulation Type

If Auto, USB devices less than 530MB will be emulated as Floppy and remaining as hard drive. Forced FDD option can be used to force a HDD formatted drive to boot as FDD (Ex. ZIP drive)

4.1.3 Advanced PCI/PnP Setting

Main	Advanced	PCIPnP	Boot	Security	Chipset	Exit
Advanced PCI/PnP Settings						▲ Clear NVRAM during System Boot.
WARNING: Setting wrong values in below sections may cause system to malfunction.						
Clear NVRAM		[No]				
Plug & Play O/S		[No]				
PCI Latency Timer		[64]				
Allocate IRQ to PCI UGA		[Yes]				
Palette Snooping		[Disabled]				
PCI IDE BusMaster		[Enabled]				
OffBoard PCI/ISA IDE Card		[Auto]				
IRQ3		[Available]				← Select Screen
IRQ4		[Available]				↑↓ Select Item
IRQ5		[Available]				+− Change Option
IRQ7		[Available]				F1 General Help
IRQ9		[Available]				F10 Save and Exit
IRQ10		[Available]				ESC Exit
IRQ11		[Available]				

Main	Advanced	PCIPnP	Boot	Security	Chipset	Exit
OffBoard PCI/ISA IDE Card		[Auto]				▲ Size of memory block to reserve for legacy ISA devices.
IRQ3		[Available]				
IRQ4		[Available]				
IRQ5		[Available]				
IRQ7		[Available]				
IRQ9		[Available]				
IRQ10		[Available]				
IRQ11		[Available]				
IRQ14		[Available]				
IRQ15		[Available]				
DMA Channel 0		[Available]				← Select Screen
DMA Channel 1		[Available]				↑↓ Select Item
DMA Channel 3		[Available]				+− Change Option
DMA Channel 5		[Available]				F1 General Help
DMA Channel 6		[Available]				F10 Save and Exit
DMA Channel 7		[Available]				ESC Exit
Reserved Memory Size		[Disabled]				

4.1.3.1 Clear NVRAM

Clear NVRAM during System Boot.

4.1.3.2 Plug & Play O/S

Set this value to allow the system to modify the settings for Plug and Play operating system support.

Item	Description
No	The <i>No</i> setting is for operating systems that do not meet the Plug and Play specifications. It allows the BIOS to configure all the devices in the system.
Yes	The <i>Yes</i> setting allows the operating system to change the interrupt, I/O, and DMA settings. Set this option if the system is running Plug and Play aware operating systems.

4.1.3.3 PCI Latency Timer

Set this value to allow the PCI Latency Timer to be adjusted. This option sets the latency of all PCI devices on the PCI bus.

The options: 32, 64, 96, 128, 160, 192, 224, 248 PCI clock cycles.

4.1.3.4 Allocate IRQ to PCI VGA

Set this value to allow or restrict the system from giving the VGA adapter card an interrupt address.

4.1.3.5 Palette Snooping

Set this value to allow the system to modify the Palette Snooping settings.

Item	Description
Disabled	This is the default setting and should not be changed unless the VGA card manufacturer requires Palette Snooping to be Enabled.
Enabled	This setting informs the PCI devices that an ISA based Graphics device is installed in the system. It does this so the ISA based Graphics card will function correctly. This does not necessarily indicate a physical ISA adapter card. The graphics chipset can be mounted on a PCI card. Always check with your adapter card's manuals first, before modifying the default settings in the BIOS.

4.1.3.6 PCI IDE BusMaster

Set this value to allow or prevent the use of PCI IDE busmastering.

4.1.3.7 OffBoard PCI/ISA IDE Card

Set this value to allow the OffBoard PCI/ISA IDE Card to be selected.

4.1.3.8 IRQ3/4/5/7/9/10/11/14/15

Set this value to allow the IRQ settings to be modified.

Item	Description
Available	This setting allows the specified IRQ to be used by a PCI/PnP device.
Reserved	This setting allows the specified IRQ to be used by a legacy ISA device.

4.1.3.9 DMA Channel 0/1/3/5/6/7

Set this value to allow the DMA setting to be modified.

Item	Description
Available	This setting allows the specified DMA to be used by PCI/PnP device.
Reserved	This setting allows the specified DMA to be used by a legacy ISA device.

4.1.3.10 Reserved Memory Size

Set this value to allow the system to reserve memory that is used by ISA devices

The options: Disabled, 16K, 32K, 64K.

4.1.4 Boot Settings

Main	Advanced	PCIPnP	Boot	Security	Chipset	Exit
------	----------	--------	-------------	----------	---------	------

<p>Boot Settings</p> <p>▶ Boot Settings Configuration</p> <p>▶ Boot Device Priority</p> <p>▶ Removable Drives</p>	<p>Configure Settings during System Boot.</p> <p>← Select Screen ↑↓ Select Item Enter Go to Sub Screen F1 General Help F10 Save and Exit ESC Exit</p>
--	--

4.1.4.1 Boot Settings Configuration

Boot	
Boot Settings Configuration	
Quick Boot	[Enabled]
Quiet Boot	[Disabled]
AddOn ROM Display Mode	[Force BIOS]
Bootup Num-Lock	[On]
Wait For 'F1' If Error	[Enabled]
Hit 'DEL' Message Display	[Enabled]
Interrupt 19 Capture	[Disabled]
Allows BIOS to skip certain tests while booting. This will decrease the time needed to boot the system.	
← Select Screen ↑↓ Select Item +- Change Option F1 General Help F10 Save and Exit ESC Exit	

4.1.4.1.1 Quick Boot

The Optimal and Fail-Safe default setting is *Disabled*. Allow to set this value to allow the BIOS to skip certain POST tests to boot faster or disabled to perform all POST tests.

4.1.4.1.2 Quiet Boot

Set this value to allow the boot up screen options to be modified between POST messages or OEM logo. The Optimal and Fail-Safe default setting is *Enabled*.

4.1.4.1.3 AddOn ROM Display Mode

Set this option to display add-on ROM (read-only memory) messages.

Item	Description
Force BIOS	Set this value to allow the computer system to force a third party BIOS to display during system boot. This is the default setting.
Keep Current	Set this value to allow the computer system to display the information during system boot.

4.1.4.1.4 Bootup Num-Lock

Set this value to allow the Number Lock setting to be modified during boot up.

4.1.4.1.5 Wait For 'F1' If Error

Set this value to allow the Wait for 'F1' Error setting to be modified.

Item	Description
Disabled	This prevents the to wait on an error for user intervention. This setting should be used if there is a known reason for a BIOS error to appear. An example would be a system administrator must remote boot the system. The computer system does not have a keyboard currently attached. If this setting is set, the system will continue to boot up in to the operating system. If 'F1' is enabled, the system will wait until the BIOS setup is entered.
Enabled	Set this value to allow the system BIOS to wait for any error. If an error is detected, pressing <F1> will enter Setup and the BIOS setting can be adjusted to fix the problem. This normally happens when upgrading the hardware and not setting the BIOS to recognize it. This is the default setting.

4.1.4.1.6 Hit 'DEL' Message Display

Set this value to allow the *Hit "DEL" to enter Setup* Message Display to be modified.

4.1.4.1.7 Interrupt 19 Capture

Enabled: Allows option ROMs to trap interrupt 19. This is required by some PCI cards that provide a ROM based setup utility.

4.1.5 Security Settings

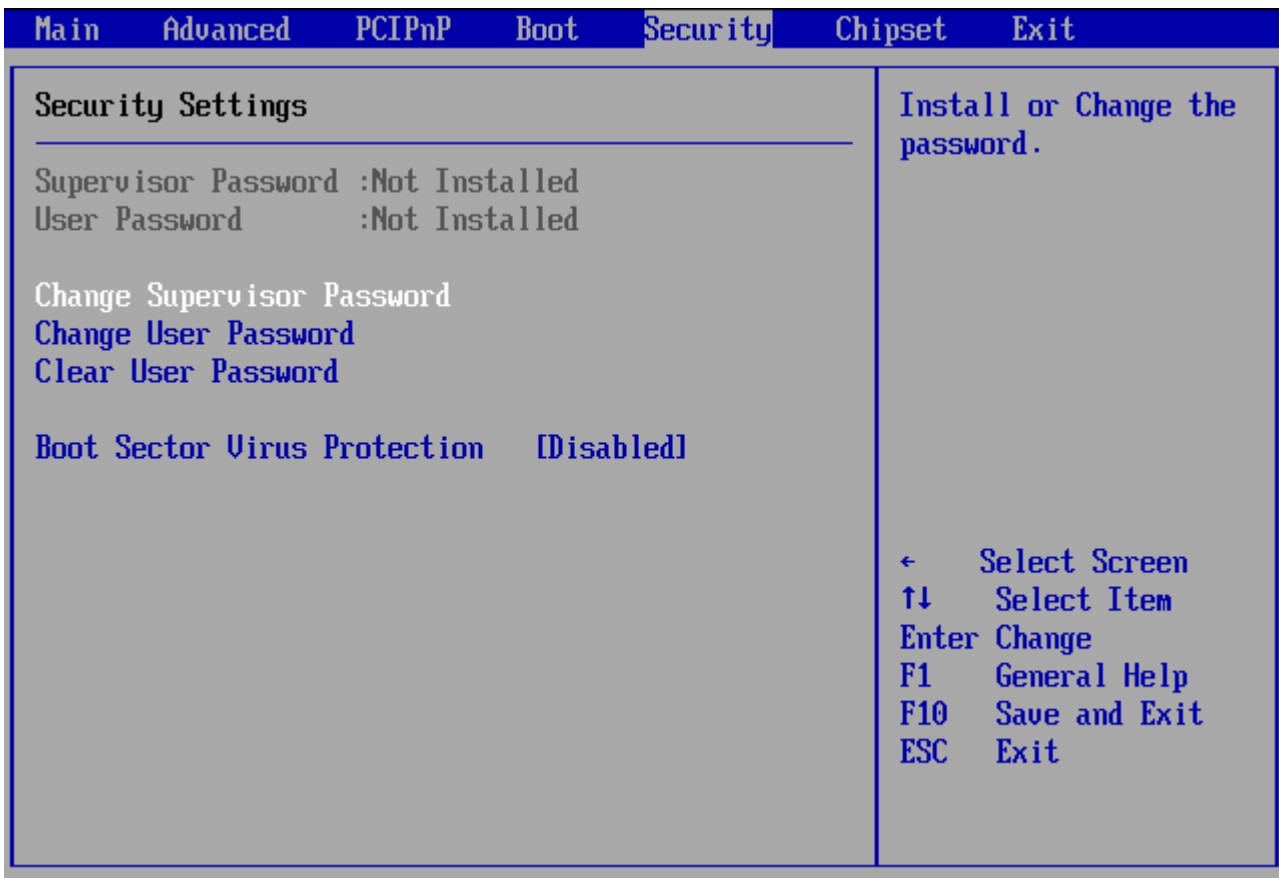

4.1.5.1 Change Supervisor Password

Indicates whether a supervisor password has been set. If the password has been installed, *Installed* displays. If not, *Not Installed* displays.

4.1.5.2 Change User Password

Indicates whether a user password has been set. If the password has been installed, *Installed* displays. If not, *Not Installed* displays.

4.1.5.3 Clear User Password

Select Clear User Password from the Security Setup menu.

4.1.5.4 Boot Sector Virus Protection

Enable/Disable Boot Sector Virus Protection.

4.1.6 Advanced Chipset Settings

Main	Advanced	PCIPnP	Boot	Security	Chipset	Exit
Advanced Chipset Settings					Configure North Bridge features.	
WARNING: Setting wrong values in below sections may cause system to malfunction.						
▶ North Bridge Configuration						
▶ South Bridge Configuration						
					← Select Screen	
					↑↓ Select Item	
					Enter Go to Sub Screen	
					F1 General Help	
					F10 Save and Exit	
					ESC Exit	

4.1.6.1 North Bridge Configuration

You can use this screen to select options for the North Bridge Configuration. Use the up and down <Arrow> keys to select an item. Use the <Plus> and <Minus> keys to change the value of the selected option.

Note: The North Bridge Configuration setup screen varies depending on the supported North Bridge chipset.

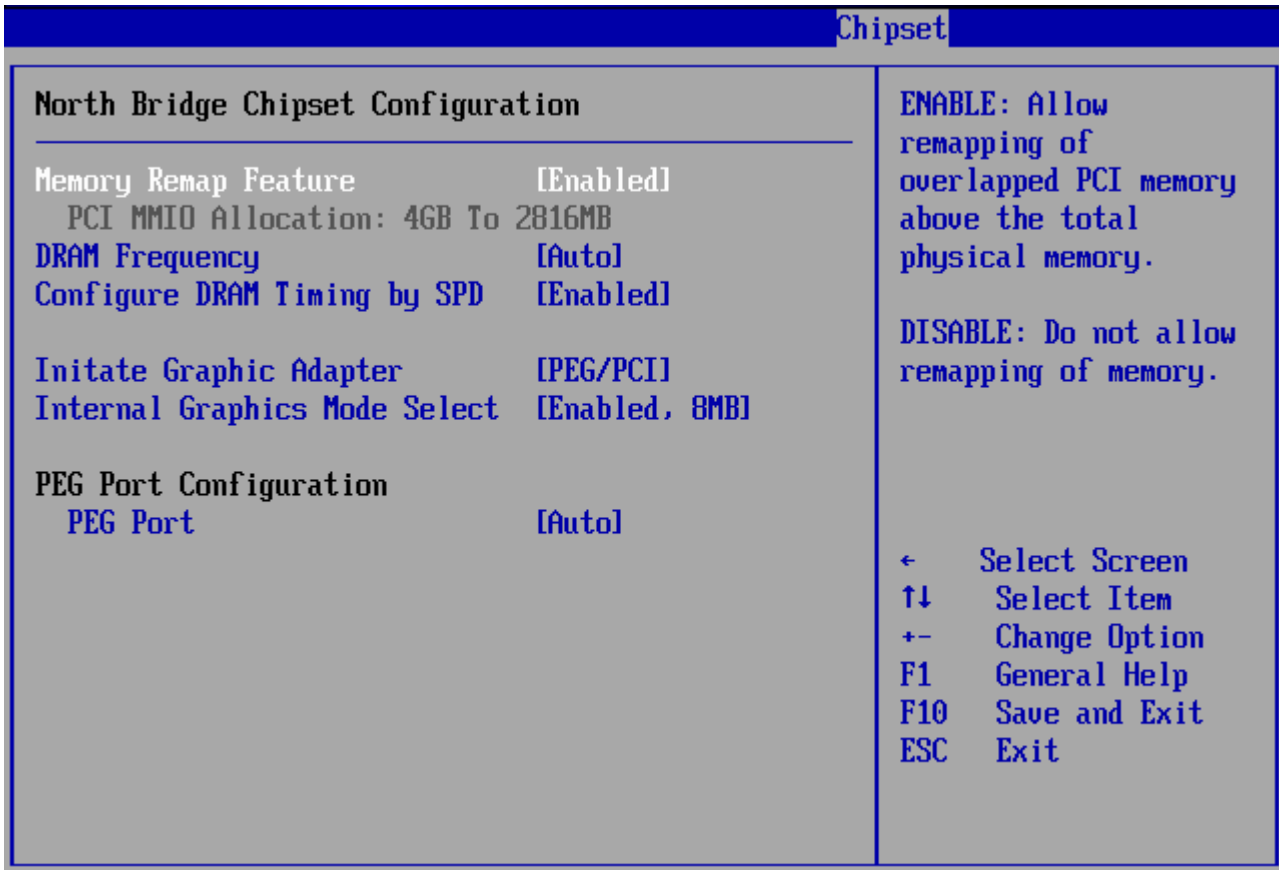

4.1.6.1.1 Memory Remap Feature

ENABLE: Allow remapping of overlapped PCI memory above the total physical memory.

DISABLE: Do not allow remapping of memory.

4.1.6.1.2 DRAM Frequency

The item allows you to set the DRAM frequency.

4.1.6.1.3 Configure DRAM Timing by SPD

Select the operating system that is selecting DRAM timing, so select SPD for setting DRAM timing by SPD.

The choice: [Enable], [Disable]

4.1.6.1.4 Initiate Graphic Adapter

Select which graphics controller to use as the primary boot device.

4.1.6.1.5 Internal Graphics Mode Select

Select the amount of system memory used by the internal graphics device.

4.1.6.1.6 PEG Port

This item allows you to control the PEG or on-chip VGA.

The choice: [Auto], [Disabled].

4.1.6.2 South Bridge Configuration

You can use this screen to select options for the South Bridge Configuration. South Bridge is a chipset on the motherboard that controls the basic I/O functions, USB ports, audio functions, modem functions, IDE channels, and PCI slots. Use the up and down <Arrow> keys to select an item. Use the <Plus> and <Minus> keys to change the value of the selected option.

Note: The South Bridge Configuration setup screen varies depending on the supported South Bridge chipset.

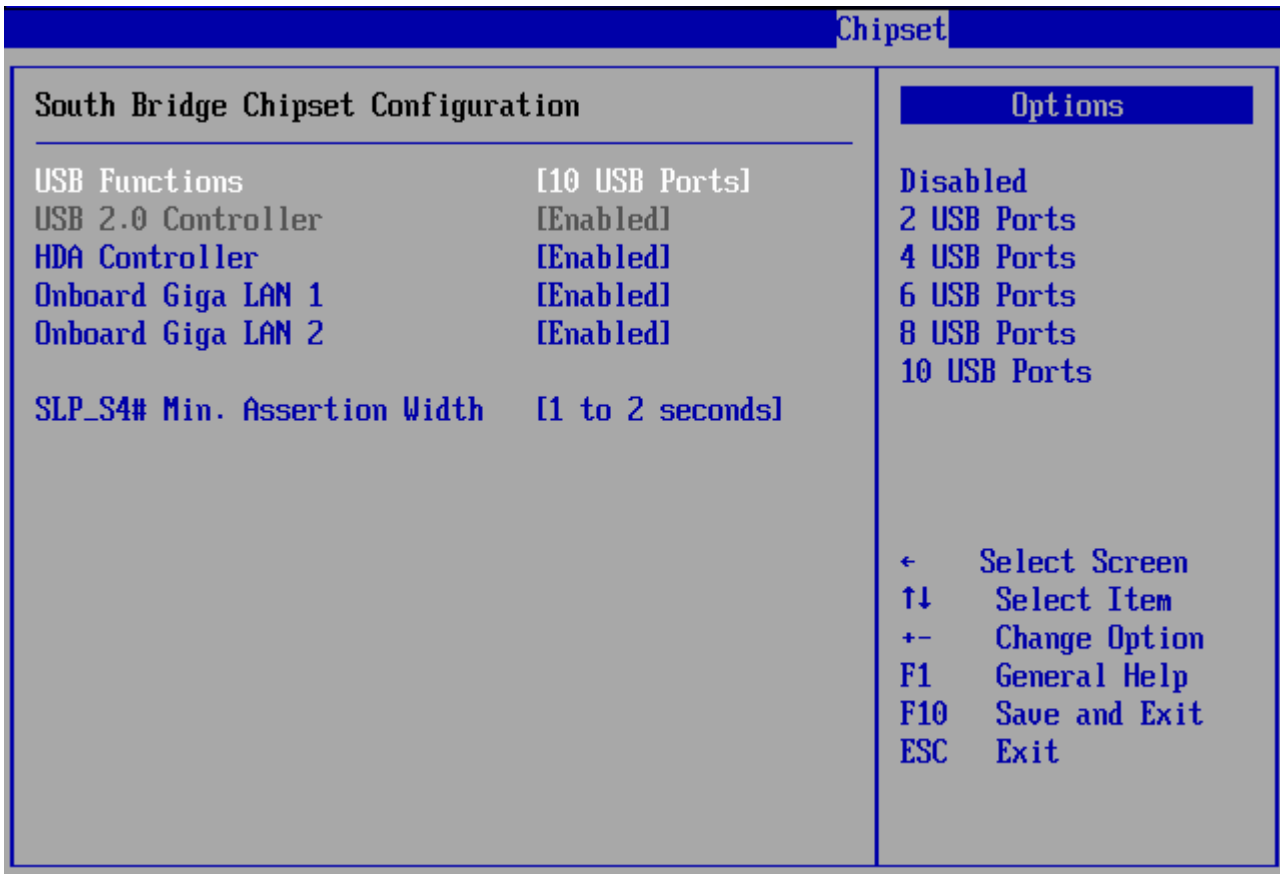

4.1.6.2.1 USB Functions

This item allows you to active USB ports.

4.1.6.2.2 USB 2.0 Controller

Select “Enabled” if your system contains a Universal Serial Bus 2.0 (USB 2.0) controller and you have USB peripherals.

The choice: Enabled, Disabled.

4.1.6.2.3 HDA Controller

This item allows you to select the chipset family to support High Definition Audio Controller.

The choice: Disabled, Enabled.

4.1.6.2.4 Onboard Giga LAN 1/2

Select "Enabled" if your system has a LAN device installed on the system board and you wish to use it.

The choice: Enabled, Disabled

4.1.6.2.5 SLP_S4# Min. Assertion Width

The item allows you to select the assertion width of SLP_S4#.

The choice: 4 to 5 sec., 3 to 4 sec., 2 to 3 sec, 1 to 2 sec.

4.1.7 Exit Options

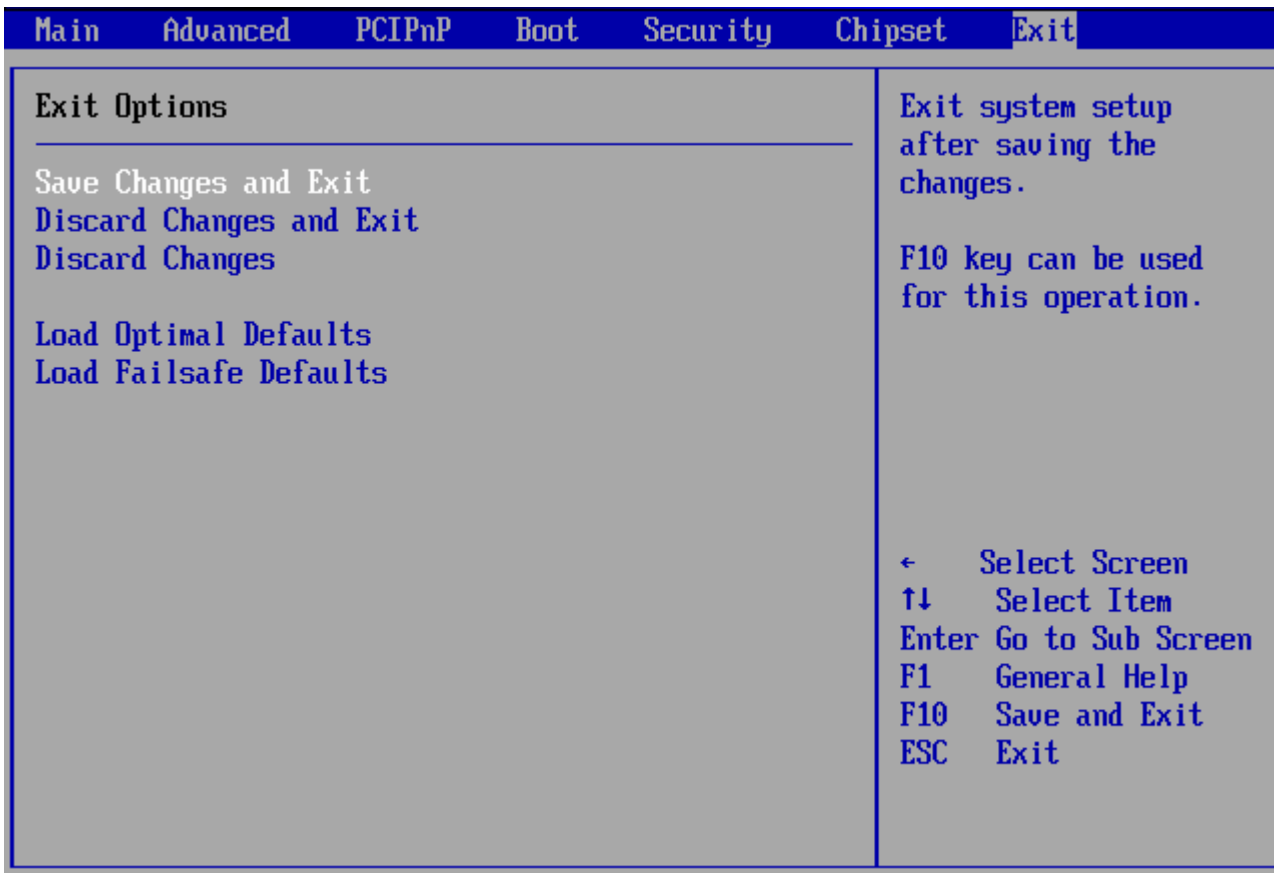

4.1.7.1 Save Changes and Exit

When you have completed the system configuration changes, select this option to leave Setup and reboot the computer so the new system configuration parameters can take effect.

4.1.7.2 Discard Changes and Exit

Select this option to quit Setup without making any permanent changes to the system configuration.

4.1.7.3 Discard Changes

Select Discard Changes from the Exit menu and press <Enter>.

4.1.7.4 Load Optimal Defaults

Load Optimal Default values for all the setup questions. F9 key can be used for this operation.

4.1.7.5 Load Failsafe Defaults

Load Failsafe Default values for all the setup questions. F8 key can be used for this operation



Free Manuals Download Website

<http://myh66.com>

<http://usermanuals.us>

<http://www.somanuals.com>

<http://www.4manuals.cc>

<http://www.manual-lib.com>

<http://www.404manual.com>

<http://www.luxmanual.com>

<http://aubethermostatmanual.com>

Golf course search by state

<http://golfingnear.com>

Email search by domain

<http://emailbydomain.com>

Auto manuals search

<http://auto.somanuals.com>

TV manuals search

<http://tv.somanuals.com>