

8VM533M-RZ / 8VM533M-RZ-C

Intel® Pentium® 4 Processor Motherboard

User's Manual

Rev. 1003

12ME-VM533MRZ-1003

Copyright

©2004 GIGABYTE TECHNOLOGY CO., LTD

Copyright by GIGA-BYTE TECHNOLOGY CO., LTD. ("GBT"). No part of this manual may be reproduced or transmitted in any form without the expressed, written permission of GBT.

Trademarks

Third-party brands and names are the property of their respective owners.

Notice

Please do not remove any labels on motherboard, this may void the warranty of this motherboard.

Due to rapid change in technology, some of the specifications might be out of date before publication of this booklet.

The author assumes no responsibility for any errors or omissions that may appear in this document nor does the author make a commitment to update the information contained herein.

DECLARATION OF CONFORMITY

Per FCC Part 2, Section 2.1077(a)



Responsible Party Name: G.B.T. INC. (U.S.A.)

Address: 17358 Railroad Street

City of Industry, CA 91748

Phone/Fax No: (818) 854-9338 (818) 854-9339

I hereby declares that the product

Product Name: **Motherboard**

Model Number: **8VM533M-RZ**

Conforms to the following specifications:

FCC Part 15, Subpart B, Section 15.107(a) and Section 15.109

(e), Class B Digital Device

Supplementary Information:

This device complies with part 15 of the FCC Rules. Operation is subject to the following two conditions: (1) This device may not cause harmful and (2) this device must accept any interference received, including that may cause undesired operation.

Representative Person's Name: ERIC LU

Signature: Eric Lu

Date: Feb. 20, 2004

Declaration of Conformity

Mr. Manfred Wirtler
Jail Address

G.B.T. Technology Trading GmbH
Autobogenweg 41, 76287 Rembig, Germany

de, we have filed a declaration of conformity with the Federal Communications Commission (FCC) under Part 15 of the FCC Rules.

Mother Board

8VM533M-RZ

Reference to the specification under which conformity is declared

FCC Part 15, Subpart B, Section 15.107(a)

E-EM001

2. Radio set made of separate parts

Units not part of the instrument

E-EM002

2.1. Radio set made of separate parts

Radio set containing a radio part

E-EM003

2.2. Radio set containing a radio part

E-EM004

Units not part of the instrument

E-EM005

2.3. Radio set containing a radio part

Units not part of the instrument

E-EM006

2.4. Radio set containing a radio part

E-EM007

Units not part of the instrument

E-EM008

2.5. Radio set containing a radio part

E-EM009

Units not part of the instrument

E-EM010

2.6. Radio set containing a radio part

E-EM011

Units not part of the instrument

E-EM012

2.7. Radio set containing a radio part

E-EM013

Units not part of the instrument

E-EM014

2.8. Radio set containing a radio part

E-EM015

Units not part of the instrument

E-EM016

2.9. Radio set containing a radio part

E-EM017

Units not part of the instrument

E-EM018

2.10. Radio set containing a radio part

E-EM019

Units not part of the instrument

E-EM020

2.11. Radio set containing a radio part

E-EM021

Units not part of the instrument

E-EM022

2.12. Radio set containing a radio part

E-EM023

Units not part of the instrument

E-EM024

2.13. Radio set containing a radio part

E-EM025

Units not part of the instrument

E-EM026

2.14. Radio set containing a radio part

E-EM027

Units not part of the instrument

E-EM028

2.15. Radio set containing a radio part

E-EM029

Units not part of the instrument

E-EM030

2.16. Radio set containing a radio part

E-EM031

Units not part of the instrument

E-EM032

2.17. Radio set containing a radio part

E-EM033

Units not part of the instrument

E-EM034

2.18. Radio set containing a radio part



The manufacturer also declares the conformity of his product with the following standards in accordance with EN 55022:CE

EN 55022:CE

EN 55024:CE

EN 55025:CE

Manufacturer's name:

Signature:

Date: Feb. 20, 2004

Preparing Your Computer

Computer motherboards and expansion cards contain very delicate Integrated Circuit (IC) chips. To protect them against damage from static electricity, you should follow some precautions whenever you work on your computer.

1. Unplug your computer when working on the inside.
2. Use a grounded wrist strap before handling computer components. If you do not have one, touch both of your hands to a safely grounded object or to a metal object, such as the power supply case.
3. Hold components by the edges and try not touch the IC chips, leads or connectors, or other components.
4. Place components on a grounded antistatic pad or on the bag that came with the components whenever the components are separated from the system.
5. Ensure that the ATX power supply is switched off before you plug in or remove the ATX power connector on the motherboard.



Installing the motherboard to the chassis

If the motherboard has mounting holes, but they don't line up with the holes on the base and there are no slots to attach the spacers, do not become alarmed you can still attach the spacers to the mounting holes. Just cut the bottom portion of the spacers (the spacer may be a little hard to cut off, so be careful of your hands). In this way you can still attach the motherboard to the base without worrying about short circuits. Sometimes you may need to use the plastic springs to isolate the screw from the motherboard PCB surface, because the circuit wire may be near by the hole. Be careful, don't let the screw contact any printed circuit write or parts on the PCB that are near the fixing hole, otherwise it may damage the board or cause board malfunctioning.

Table of Contents

Chapter 1 Introduction	5
Features Summary	5
8VM533M-RZ Series Motherboard Layout	6
Block Diagram	7
Hardware Installation Process	8
Step 1: Install the Central Processing Unit (CPU)	8
Step 1-1: CPU Installation	9
Step 1-2: CPU Cooling Fan Installation	9
Step 2: Install Memory Modules	10
Step 3: Install AGP Card	11
Step 4: Install I/O Peripherals Cables	11
Step 4-1: I/O Back Panel Introduction	11
Step 4-2: Connectors Introduction	12
Chapter 2 BIOS Setup	19
The Main Menu (For example: BIOS Ver.: F4a)	19
Standard CMOS Features	21
Advanced BIOS Features	23
Integrated Peripherals	24
Power Management Setup	26
PnP/PCI Configurations	27
PC Health Status	28
Frequency/Voltage Control	29
Load Fail-Safe Defaults	30
Load Optimized Defaults	30
Set Supervisor/User Password	31
Save & Exit Setup	32
Exit Without Saving	32
Chapter 3 Install Drivers	33

Chapter 1 Introduction

Features Summary

CPU	<ul style="list-style-type: none"> • Socket 478 for Intel® Pentium® 4 (Northwood) with HT Technology • Intel® Pentium® 4 533/400MHz FSB • 2nd cache depends on CPU
Chipset	<ul style="list-style-type: none"> • North Bridge: VIA P4M266A/P4M533 • South Bridge: VIA VT8235/VT8237R
Memory	<ul style="list-style-type: none"> • 2 184-pin DDR DIMM sockets, supports up to 2GB DRAM (Max) • Supports DDR266/DDR200 DIMM • Supports only 2.5V DDR SDRAM
Slots	<ul style="list-style-type: none"> • 1 AGP slot 4X (1.5V) device support • 3 PCI slots support 33MHz & PCI 2.2 compliant
On-Board IDE	<ul style="list-style-type: none"> • 2 IDE controller provide IDE HDD/CD-ROM (IDE1, IDE2) with PIO, Bus Master (Ultra DMA33/ATA66/ATA100/ATA133) operation modes • Can connect up to 4 IDE devices
On-Board Floppy	<ul style="list-style-type: none"> • 1 Floppy port supports 2 FDD with 360K, 720K, 1.2M, 1.44M and 2.88M bytes
On-Board Peripherals	<ul style="list-style-type: none"> • 1 Parallel port supports Normal/EPP/ECP mode • 1 Serial port (COMA), 1 VGA port, COMB onboard • 6 USB 2.0/1.1 ports (4 x Rear, 2 x Front by cable) • 1 Front Audio connector • 1 PS/2 Keyboard • 1 PS/2 Mouse
On-Board LAN *	<ul style="list-style-type: none"> • Built-in VIA 6103 chipset * • 1 RJ45 port *
On-Board Sound	<ul style="list-style-type: none"> • VIA VT1616 CODEC • Support 2/6 channel • Line Out/ Line In / Mic In • CD In
BIOS	<ul style="list-style-type: none"> • Licensed AWARD BIOS • Supports Q-Flash™
I/O Control	<ul style="list-style-type: none"> • ITE8705
Hardware Monitor	<ul style="list-style-type: none"> • CPU Fan Revolution detect • CPU Fan Fail Warning • CPU temperature detect • System Voltage Detect
Additional Features	<ul style="list-style-type: none"> • Supports @BIOS™ • Supports EasyTune 4™
Form Factor	<ul style="list-style-type: none"> • Micro ATX size form factor, 24.5cm x 20.8cm

*** For 8VM533M-RZ only.

8VM533M-RZ Series Motherboard Layout

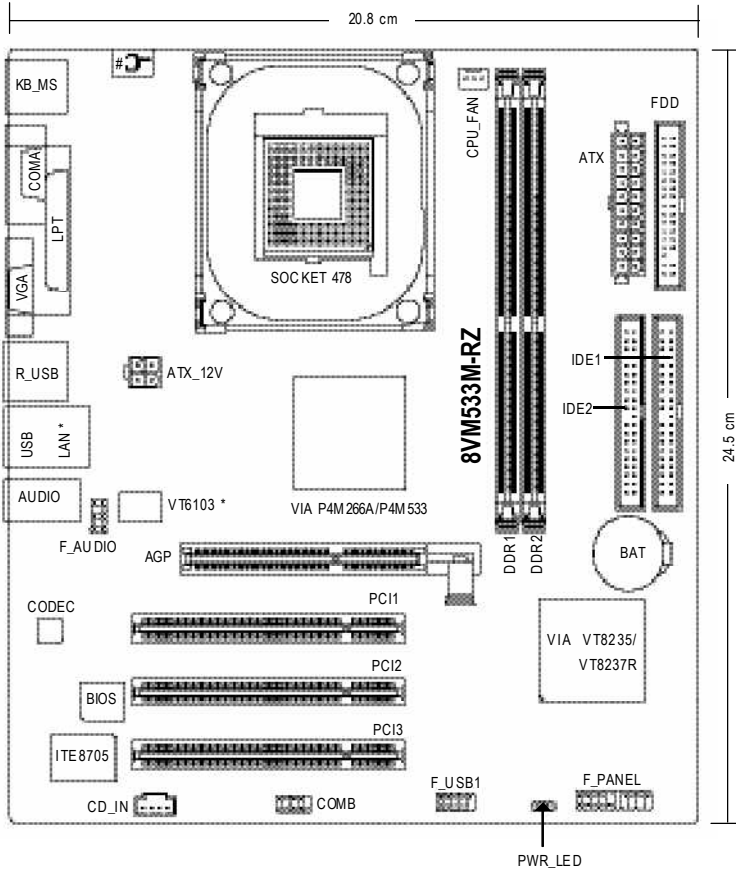

*** For 8VM533M-RZ only.

For 8VM533M-RZ-C only.

Block Diagram

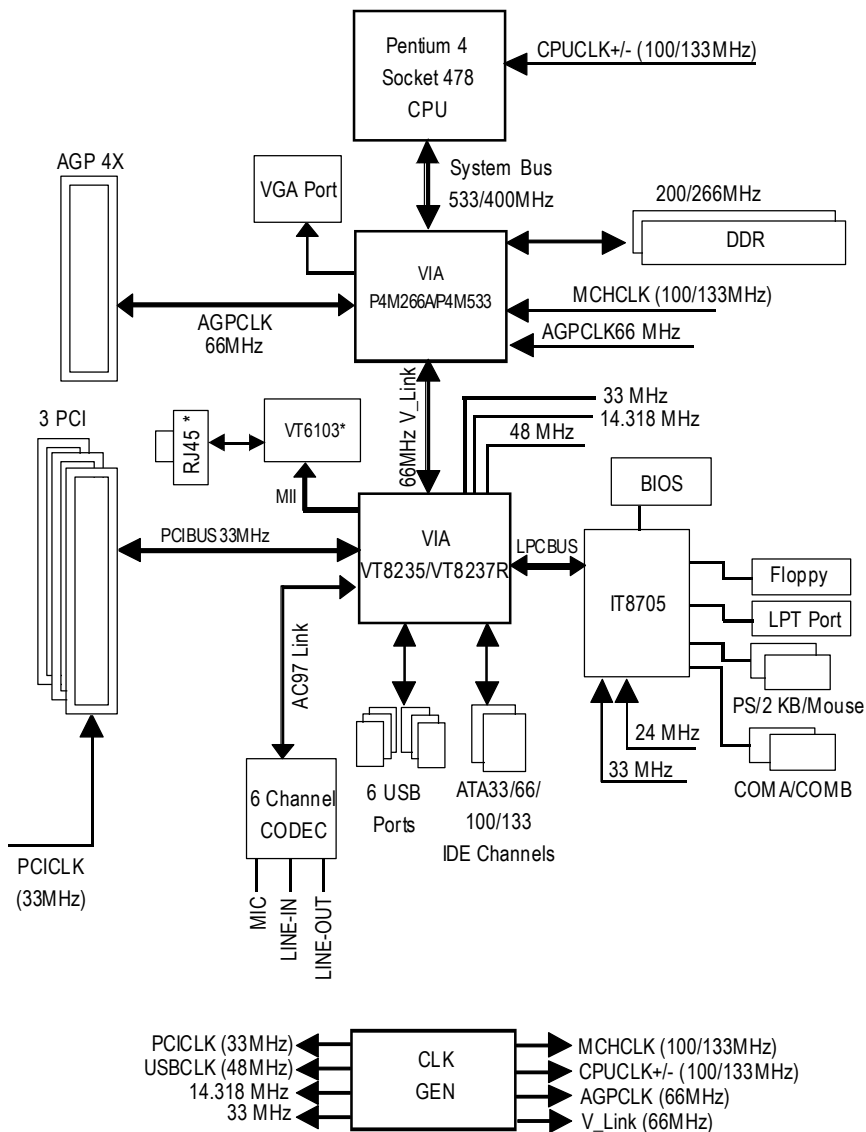

*** For 8VM533M-RZ only.

Hardware Installation Process

To set up your computer, you must complete the following steps:

- Step 1- Install the Central Processing Unit (CPU)
- Step 2- Install memory modules
- Step 3- Install expansion cards
- Step 4- Connect ribbon cables, cabinet wires, and power supply

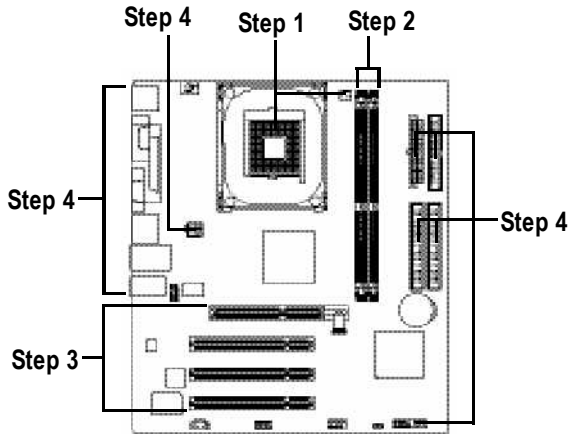

Step 1: Install the Central Processing Unit (CPU)



CAUTION

Before installing the processor, adhere to the following warning:

1. Please make sure the CPU type is supported by the motherboard.
2. The processor will overheat without the heatsink and/or fan, resulting in permanent irreparable damage.
3. If you do not match the CPU socket Pin 1 and CPU cut edge well, it will cause improper installation. Please change the insert orientation.
4. Apply thermal grease between the processor and cooling fan.
5. Never run the processor without the heatsink properly and firmly attached. Permanent damage will result.
6. Please set the CPU host frequency in accordance with your processor's specifications. We don't recommend you to set the system bus frequency over the CPU's specification because these specific bus frequencies are not the standard specifications for CPU, chipset and most of the peripherals. Whether your system can run under these specific bus frequencies properly will depend on your hardware configurations, including CPU, Memory, Cards...etc.



NOTE

HT functionality requirement content :

Enabling the functionality of Hyper-Threading Technology for your computer system requires all of the following platform components:

- CPU: An Intel® Pentium 4 Processor with HT Technology
- Chipset: An VIA Chipset that supports HT Technology
- BIOS: A BIOS that supports HT Technology and has it enabled
- OS: An operation system that has optimizations for HT Technology

Step 1-1: CPU Installation

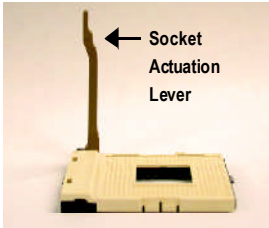

Figure 1.
Pull the rod to the 90-degree directly.

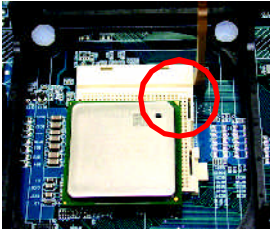

Figure 2.
Locate Pin 1 in the socket and look for a (golden) cut edge on the CPU upper corner. Insert the CPU into the socket. (Do not force the CPU into the socket.) Then move the socket lever to the locked position while holding pressure on the center of the CPU.

Step 1-2: CPU Cooling Fan Installation



Figure 1.
Apply the thermal tape(or grease) to provide better heat conduction between your CPU and cooling fan.



Figure 2.
Fasten the cooling fan supporting-base onto the CPU socket on the motherboard.

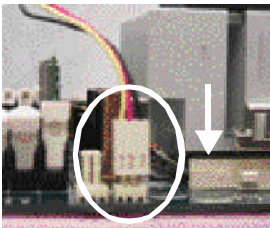

Figure 3.
Make sure the CPU fan is plugged to the CPU fan connector, than install complete.

Step 2: Install Memory Modules



Before installing the memory modules, adhere to the following warning:

1. Please note that the DIMM module can only fit in one direction due to the one notch. Wrong orientation will cause improper installation. Please change the insert orientation.

The motherboard has 2 dual inline memory module (DIMM) sockets. The BIOS will automatically detects memory type and size. To install the memory module, just push it vertically into the DIMM socket. The DIMM module can only fit in one direction due to the notch. Memory size can vary between sockets.

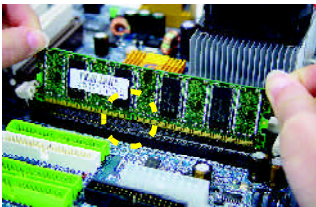
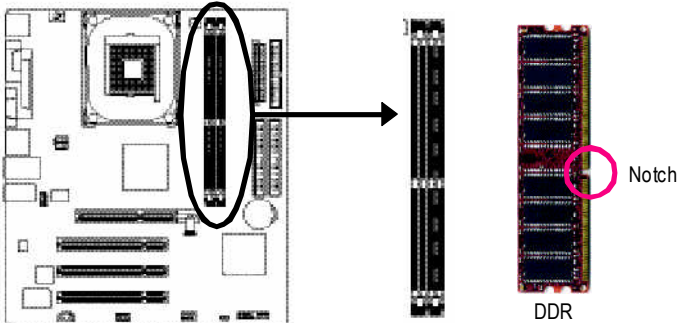

1. The DIMM socket has a notch, so the DIMM memory module can only fit in one direction.

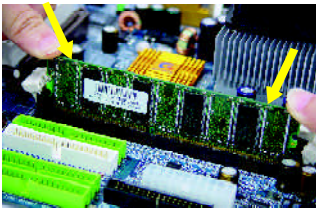

2. Insert the DIMM memory module vertically into the DIMM socket. Then push it down.



3. Close the plastic clip at both edges of the DIMM sockets to lock the DIMM module. Reverse the installation steps when you wish to remove the DIMM module.

Step 3: Install AGP Card

1. Read the relateAGP card's instruction document before install the AGP card into the computer.
2. If your AGP card has "AGP 4X(1.5V) notch" (show below), please make sure your AGP card is AGP 4X(1.5V).



3. Please carefully pull out the small white- drawable bar at the end of the AGP slot when you try to install/ Uninstall the AGP card. Please align the AGP card to the onboard AGP slot and press firmly down on the slot .Make sure your AGP card is locked by the small white- drawable bar.

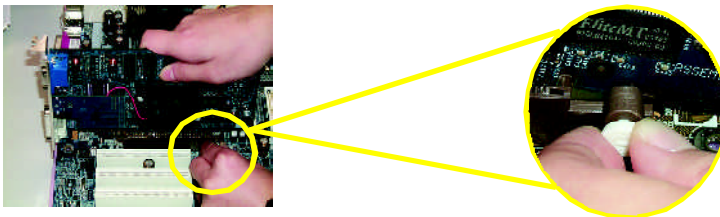

Step 4: Install I/O Peripherals Cables

Step 4-1: I/O Back Panel Introduction

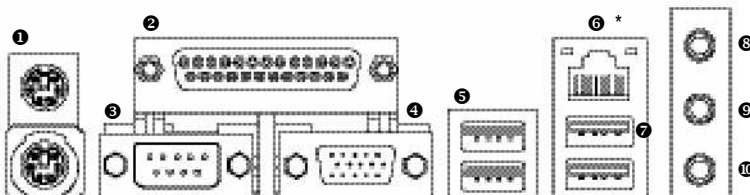

- ❶ **PS/2 Keyboard and PS/2 Mouse connector**
This connector supports standard PS/2 keyboard and PS/2 mouse.
- ❷ **Parallel port (LPT)**
Device like printer can be connected to Parallel port.
- ❸ **Serial port (COMA)**
Mouse and modem etc. can be connected to Serial port.
- ❹ **VGA port**
Monitor can be connected to VGA port.
- ❺/❻ **USB port**
Before you connect your device(s) into USB connector(s), please make sure your device(s) such as USB keyboard, mouse, scanner, zip, speaker...etc. Have a standard USB interface. Also make sure your OS supports USB controller. If your OS does not support USB controller, please contact OS vendor for possible patch or driver upgrade. For more information please contact your OS or device(s) vendors.

** For 8VM533M-RZ only.

⑥ **LAN port ***

LAN is fast Ethernet with 10/100Mbps speed.

⑧ **Line In jack**

Devices like CD-ROM, walkman etc. can be connect to Line In jack.

⑨ **Line Out jack**

Connect the stereo speakers or earphone to this connector.

⑩ **MIC In jack**

Microphone can be connect to MIC In jack.

After installation of the audio driver, you are able to use 2/4/6-channel audio feature by software selection. You can connect "Front speaker" to "Line Out" jack, Connect "Rear speaker" to "Line In" jack and connect "Center/Subwoofer" to "MIC In" jack.

Step 4-2: Connectors Introduction

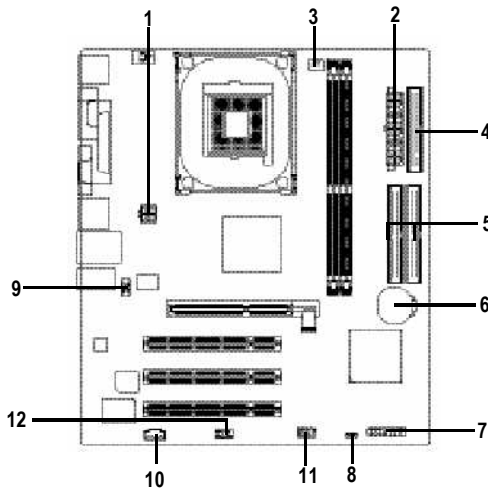

1) ATX_12V	7) F_PANEL
2) ATX	8) PWR_LED
3) CPU_FAN	9) F_AUDIO
4) FDD	10) CD_IN
5) IDE1 / IDE2	11) F_USB1
6) BAT	12) COMB

*** For 8VM533M-RZ only.

1) ATX_12V (+12V Power Connector)

This connector (ATX_12V) supplies the CPU operation voltage (Vcore).
 If this "ATX_12V connector" is not connected, system cannot boot

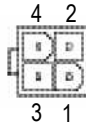
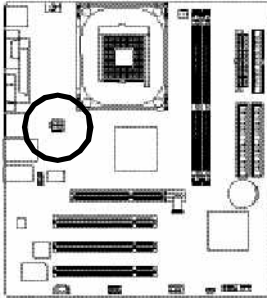

Pin No.	Definition
1	GND
2	GND
3	+12V
4	+12V

2) ATX(ATX Power)

AC power cord should only be connected to your power supply unit after ATX power cable and other related devices are firmly connected to the mainboard.

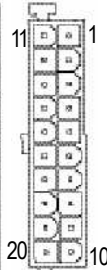
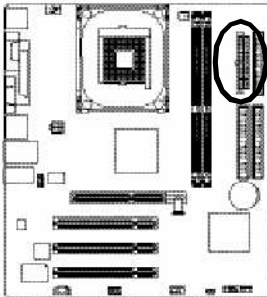

Pin No.	Definition	Pin No.	Definition
1	3.3V	11	3.3V
2	3.3V	12	-12V
3	GND	13	GND
4	VCC	14	PS_ON(softon/off)
5	GND	15	GND
6	VCC	16	GND
7	GND	17	GND
8	PowerGood	18	-5V
9	5VSB (stand by +5V)	19	VCC
10	+12V	20	VCC

3) CPU_FAN (CPU Fan Connector)

Please note, a proper installation of the CPU cooler is essential to prevent the CPU from running under abnormal condition or damaged by overheating. The CPU fan connector supports Max. current up to 600 mA.

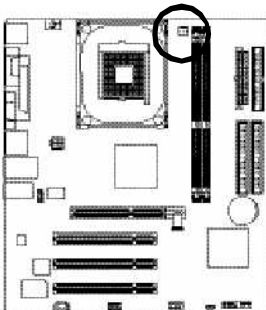

Pin No.	Definition
1	GND
2	+12V
3	Sense

4) FDD (Floppy Connector)

Please connect the floppy drive ribbon cables to FDD. It supports 360K, 1.2M, 720K, 1.44M and 2.88M bytes floppy disk types.

The red stripe of the ribbon cable must be the same side with the Pin 1.

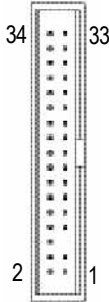
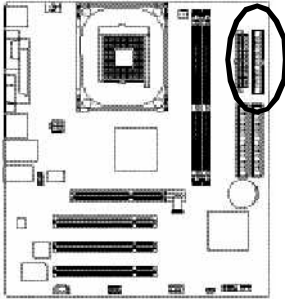

5) IDE1 / IDE2 (IDE1 / IDE2 Connector)

Important Notice: Please connect first hard disk to IDE1 and connect CD-ROM to IDE2. The red stripe of the ribbon cable must be the same side with the Pin 1.

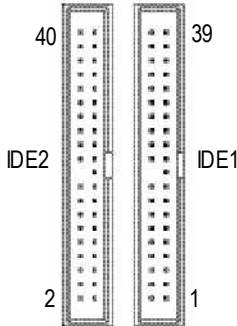
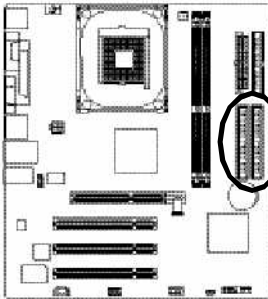

6) BAT (BATTERY)

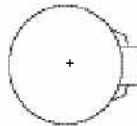
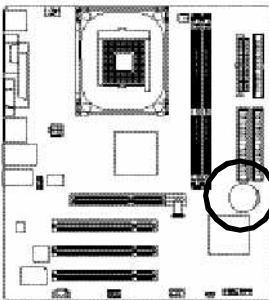

CAUTION

- ❖ Danger of explosion if battery is incorrectly replaced.
- ❖ Replace only with the same or equivalent type recommended by the manufacturer.
- ❖ Dispose of used batteries according to the manufacturer's instructions.

If you want to erase CMOS...

1. Turn OFF the computer and unplug the power cord.
2. Remove the battery, wait for 30 second.
3. Re-install the battery.
4. Plug the power cord and turn ON the computer.

7) F_PANEL (2 x 10 pins Connector)

Please connect the power LED, PC speaker, reset switch and power switch etc of your chassis front panel to the F_PANEL connector according to the pin assignment below.

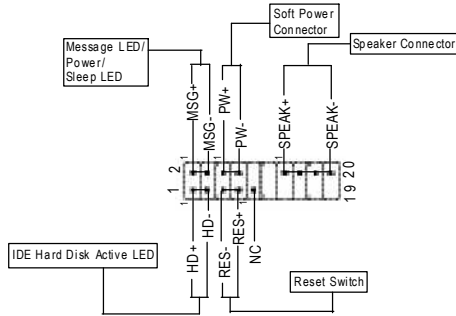
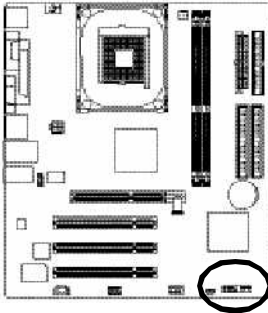

HD (IDE Hard Disk Active LED)	Pin 1:LED anode(+) Pin 2:LED cathode(-)
SPK(Speaker Connectbr)	Pin 1:VCC(+) Pin 2- Pin 3: NC Pin 4:Data(-)
RES(ResetSwitch)	Open:Normal Operatōn Close:ResetHardware System
PW(SoftPower Connector)	Open:Normal Operatōn Close:Power On/Off
MSG (Message LED/Power/Sleep LED)	Pin 1:LED anode(+) Pin 2:LED cathode(-)
NC	NC

8) PWR_LED

PWR_LED is connect with the system power indicator to indicate whether the system is on/off. It will blink when the system enters suspend mode. If you use dual color LED, power LED will turn to another color.

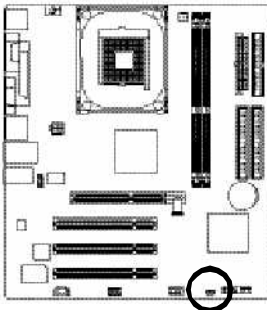

Pin No.	Definition
1	MPD+
2	MPD-
3	MPD-

9) F_AUDIO (Front Audio Connector)

In order to utilize the front audio header, your chassis must have front audio connector. Also please make sure the pin assignment on the cable is the same as the pin assignment on the MB header. To find out if the chassis you are buying support front audio connector, please contact your dealer. Please note, you can have the alternative of using front audio connector or of using rear audio connector to play sound.

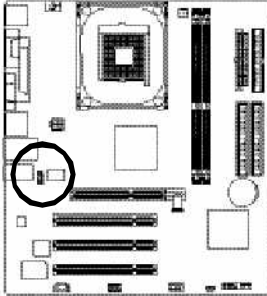

Pin No.	Definition
1	MIC
2	GND
3	REF
4	Power
5	FrontAudio (R)
6	RearAudio (R)
7	Reserved
8	No Pin
9	FrontAudio (L)
10	RearAudio (L)

10) CD_IN (CD In Connector)

Connect CD-ROM or DVD-ROM audio out to the connector.

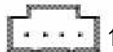
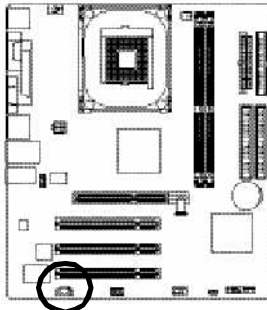

Pin No.	Definition
1	CD-L
2	GND
3	GND
4	CD-R

11) F_USB1 (Front USB Connector)

Be careful with the polarity of the front USB connector. Check the pin assignment carefully while you connect the front USB cable, incorrect connection between the cable and connector will make the device unable to work or even damage it. For optional front USB cable, please contact your local dealer.

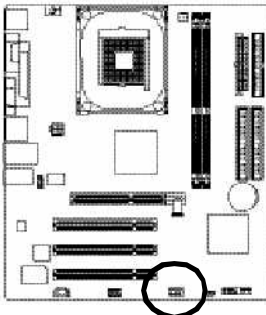

Pin No.	Definition
1	Power
2	Power
3	USB D _X -
4	USB D _y -
5	USB D _X +
6	USB D _y +
7	GND
8	GND
9	No Pin
10	NC

12) COMB (COM B Connector)

Be careful with the polarity of the COMB connector. Check the pin assignment while you connect the COMB cable. Please contact your nearest dealer for optional COMB cable.

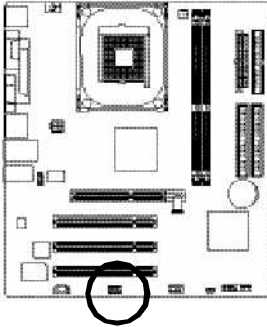

Pin No.	Definition
1	NDCDB-
2	NSINB
3	NSOUTB
4	NDTRB-
5	GND
6	NDSRB-
7	NRTSB-
8	NCTSB-
9	NRIB-
10	No Pin

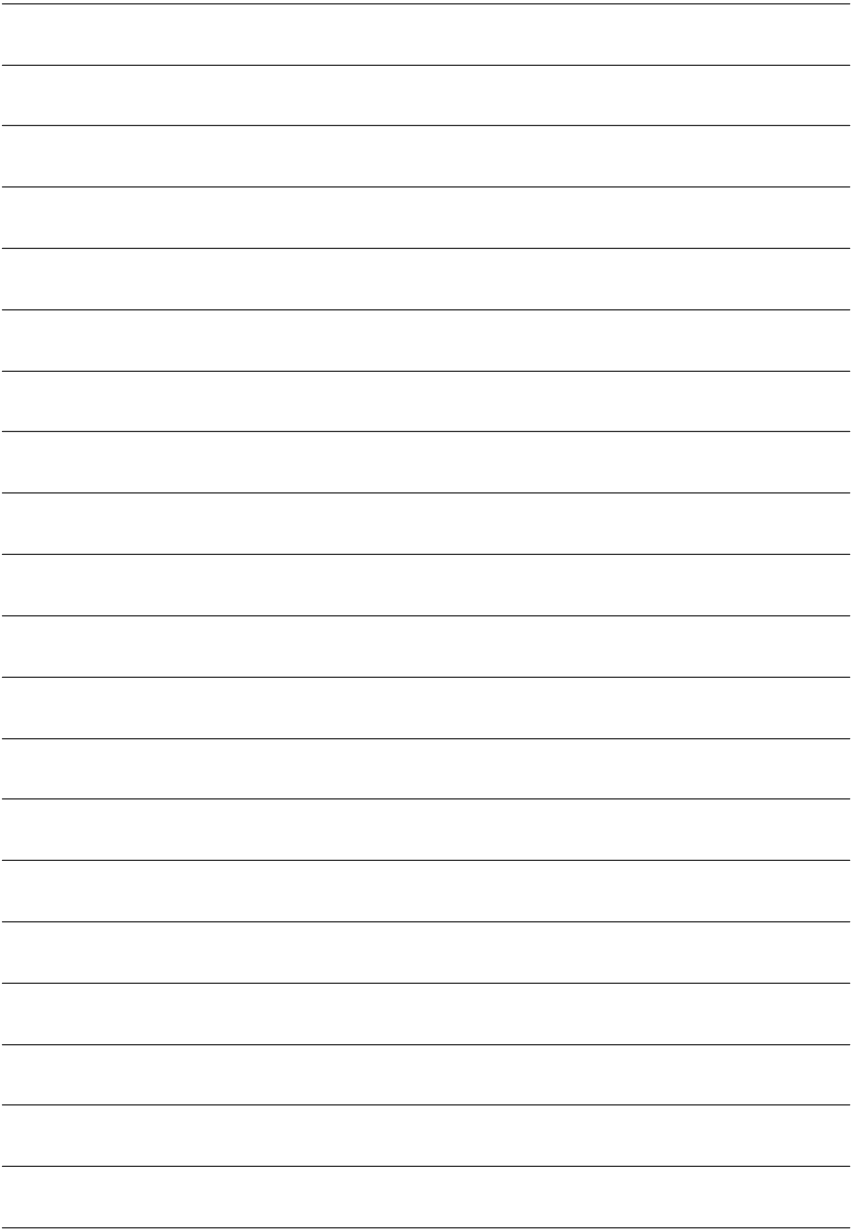

Chapter 2 BIOS Setup

BIOS Setup is an overview of the BIOS Setup Program. The program that allows users to modify the basic system configuration. This type of information is stored in battery-backed CMOS RAM so that it retains the Setup information when the power is turned off.

ENTERING SETUP

Powering ON the computer and pressing immediately will allow you to enter Setup. If you require more advanced BIOS settings, please go to "Advanced BIOS" setting menu. To enter Advanced BIOS setting menu, press "Ctrl+F1" key on the BIOS screen.

CONTROL KEYS

<↑><↓><←><→>	Move to select item
<Enter>	Select Item
<Esc>	Main Menu - Quit and not save changes into CMOS Status Page Setup Menu and Option Page Setup Menu - Exit current page and return to Main Menu
<+/PgUp>	Increase the numeric value or make changes
<-/PgDn>	Decrease the numeric value or make changes
<F1>	General help, only for Status Page Setup Menu and Option Page Setup Menu
<F2>	Item Help
<F5>	Restore the previous CMOS value from CMOS, only for Option Page Setup Menu
<F6>	Load the file-safe default CMOS value from BIOS default table
<F7>	Load the Optimized Defaults
<F8>	Q-Flash utility
<F9>	System Information
<F10>	Save all the CMOS changes, only for Main Menu

Main Menu

The on-line description of the highlighted setup function is displayed at the bottom of the screen.

Status Page Setup Menu / Option Page Setup Menu

Press F1 to pop up a small help window that describes the appropriate keys to use and the possible selections for the highlighted item. To exit the Help Window press <Esc>.

The Main Menu (For example: BIOS Ver. : F4a)

Once you enter Award BIOS CMOS Setup Utility, the Main Menu (as figure below) will appear on the screen. The Main Menu allows you to select from eight setup functions and two exit choices. Use arrow keys to select among the items and press <Enter> to accept or enter the sub-menu.

CMOS Setup Utility-Copyright (C) 1984-2003 Award Software

<ul style="list-style-type: none"> ▶ Standard CMOS Features ▶ Advanced BIOS Features ▶ Integrated Peripherals ▶ Power Management Setup ▶ PnP/PCI Configurations ▶ PC Health Status ▶ Frequency/Voltage Control 	<ul style="list-style-type: none"> Load Fail-Safe Defaults Load Optimized Defaults Set Supervisor Password Set User Password Save & Exit Setup Exit Without Saving
ESC: Quit	↑↓←→: Select Item
F8: Q-Flash	F10: Save & Exit Setup
Time, Date, Hard Disk Type...	



If you can't find the setting you want, please press "Ctrl+F1" to search the advanced option hidden.

- **Standard CMOS Features**
This setup page includes all the items in standard compatible BIOS.
- **Advanced BIOS Features**
This setup page includes all the items of Award special enhanced features.
- **Integrated Peripherals**
This setup page includes all onboard peripherals.
- **Power Management Setup**
This setup page includes all the items of Green function features.
- **PnP/PCI Configuration**
This setup page includes all the configurations of PCI & PnP ISA resources.
- **PC Health Status**
This setup page is the System auto detect Temperature, voltage, fan, speed.
- **Frequency/Voltage Control**
This setup page is control CPU clock and frequency ratio.
- **Load Fail-Safe Defaults**
Fail-Safe Defaults indicates the value of the system parameters which the system would be in safe configuration.
- **Load Optimized Defaults**
Optimized Defaults indicates the value of the system parameters which the system would be in best performance configuration.
- **Set Supervisor Password**
Change, set, or disable password. It allows you to limit access to the system and Setup, or just to Setup.
- **Set User Password**
Change, set, or disable password. It allows you to limit access to the system.
- **Save & Exit Setup**
Save CMOS value settings to CMOS and exit setup.
- **Exit Without Saving**
Abandon all CMOS value changes and exit setup.

Standard CMOS Features

CMOS Setup Utility-Copyright (C) 1984-2003 Award Software
Standard CMOS Features

		Item Help
Date (mm:dd:yy)	Fri, Jan 9 2004	Menu Level▶ Change the day, month, year
Time (hh:mm:ss)	22:31:24	<Week> Sun. to Sat.
▶ IDE Primary Master	[None]	
▶ IDE Primary Slave	[None]	
▶ IDE Secondary Master	[None]	
▶ IDE Secondary Slave	[None]	
Drive A	[1.44M, 3.5"]	<Month> Jan. to Dec.
Drive B	[None]	
Floppy 3 Mode Support	[Disabled]	<Day> 1 to 31 (or maximum allowed in the month)
Halt On	[All, But Keyboard]	<Year> 1999 to 2098
Base Memory	640K	
Extended Memory	127M	
Total Memory	128M	
↑↓→←: Move Enter: Select +/-/PU/PD: Value F10: Save ESC: Exit F1: General Help F5: Previous Values F6: Fail-Safe Default F7: Optimized Defaults		

☛ Date

The date format is <week>, <month>, <day>, <year>.

- ▶▶ Week The week, from Sun to Sat, determined by the BIOS and is display only
- ▶▶ Month The month, Jan. Through Dec.
- ▶▶ Day The day, from 1 to 31 (or the maximum allowed in the month)
- ▶▶ Year The year, from 1999 through 2098

☛ Time

The times format in <hour> <minute> <second>. The time is calculated base on the 24-hour military-time clock. For example, 1 p.m. is 13:00:00.

☛ IDE Primary Master, Slave / IDE Secondary Master, Slave

The category identifies the types of hard disk from drive C to F that has been installed in the computer. There are two types: auto type, and manual type. Manual type is user-definable; Auto type which will automatically detect HDD type.

Note that the specifications of your drive must match with the drive table. The hard disk will not work properly if you enter improper information for this category.

If you select User Type, related information will be asked to enter to the following items. Enter the information directly from the keyboard and press <Enter>. Such information should be provided in the documentation from your hard disk vendor or the system manufacturer.

- ▶▶ Cylinder Number of cylinders
- ▶▶ Head Number of heads
- ▶▶ Precomp Write precomp
- ▶▶ Landing Zone Landing zone
- ▶▶ Sector Number of sectors

If a hard disk has not been installed, select NONE and press <Enter>.

☛ Drive A / Drive B

The category identifies the types of floppy disk drive A or drive B that has been installed in the computer.

- ▶▶ None No floppy drive installed
- ▶▶ 360K, 5.25" 5.25 inch PC-type standard drive; 360K byte capacity.
- ▶▶ 1.2M, 5.25" 5.25 inch AT-type high-density drive; 1.2M byte capacity (3.5 inch when 3 Mode is Enabled).
- ▶▶ 720K, 3.5" 3.5 inch double-sided drive; 720K byte capacity
- ▶▶ 1.44M, 3.5" 3.5 inch double-sided drive; 1.44M byte capacity.
- ▶▶ 2.88M, 3.5" 3.5 inch double-sided drive; 2.88M byte capacity.

☛ Floppy 3 Mode Support (for Japan Area)

- ▶▶ Disabled Normal Floppy Drive. (Default value)
- ▶▶ Drive A Drive A is 3 mode Floppy Drive.
- ▶▶ Drive B Drive B is 3 mode Floppy Drive.
- ▶▶ Both Drive A & B are 3 mode Floppy Drives.

☛ Halt on

The category determines whether the computer will stop if an error is detected during power up.

- ▶▶ No Errors The system boot will not stop for any error that may be detected and you will be prompted.
- ▶▶ All Errors Whenever the BIOS detects a non-fatal error the system will be stopped.
- ▶▶ All, But Keyboard The system boot will not stop for a keyboard error; it will stop for all other errors. (Default value)
- ▶▶ All, But Diskette The system boot will not stop for a disk error; it will stop for all other errors.
- ▶▶ All, But Disk/Key The system boot will not stop for a keyboard or disk error; it will stop for all other errors.

☛ Memory

The category is display-only which is determined by POST (Power On Self Test) of the BIOS.

▶▶ Base Memory

The POST of the BIOS will determine the amount of base (or conventional) memory installed in the system.

The value of the base memory is typically 512K for systems with 512K memory installed on the motherboard, or 640K for systems with 640K or more memory installed on the motherboard.

▶▶ Extended Memory

The BIOS determines how much extended memory is present during the POST.

This is the amount of memory located above 1 MB in the CPU's memory address map.

Advanced BIOS Features

CMOS Setup Utility-Copyright (C) 1984-2003 Award Software
Advanced BIOS Features

First Boot Device	[Floppy]	Item Help
Second Boot Device	[HDD-0]	Menu Level▶
Third Boot Device	[CDROM]	Select Boot Device
Password Check	[Setup]	priority
CPU Hyper-Threading #	[Enabled]	[Floppy]
		Boot from floppy
		[LS120]
		Boot from LS120
		[HDD-0]
		Boot from First HDD
		[HDD-1]
		Boot from Second HDD
↑↓←→: Move Enter: Select +/~/PU/PD: Value F10: Save ESC: Exit F1: General Help F5: Previous Values F6: Fail-Safe Default F7: Optimized Defaults		



"#" System will detect automatically and show up when you install the Intel® Pentium® 4 processor with HT Technology.

First / Second / Third Boot Device

- ▶▶ Floppy Select your boot device priority by Floppy.
- ▶▶ LS120 Select your boot device priority by LS120.
- ▶▶ HDD-0~3 Select your boot device priority by HDD-0~3.
- ▶▶ SCSI Select your boot device priority by SCSI.
- ▶▶ CDROM Select your boot device priority by CDROM.
- ▶▶ ZIP Select your boot device priority by ZIP.
- ▶▶ USB-FDD Select your boot device priority by USB-FDD.
- ▶▶ USB-ZIP Select your boot device priority by USB-ZIP.
- ▶▶ USB-CDROM Select your boot device priority by USB-CDROM.
- ▶▶ USB-HDD Select your boot device priority by USB-HDD.
- ▶▶ LAN Select your boot device priority by LAN.
- ▶▶ Disabled Select your boot device priority by Disabled.

Password Check

- ▶▶ System The system can not boot and can not access to Setup page will be denied if the correct password is not entered at the prompt.
- ▶▶ Setup The system will boot, but access to Setup will be denied if the correct password is not entered at the prompt. (Default value)

CPU Hyper-Threading

- ▶▶ Enabled Enables CPU Hyper Threading Feature. Please note that this feature is only working for operating system with multi processors mode supported. (Default value)
- ▶▶ Disabled Disables CPU Hyper Threading.

Integrated Peripherals

CMOS Setup Utility-Copyright (C) 1984-2003 Award Software
Integrated Peripherals

	Item Help
OnChip IDE Channel0	[Enabled]
OnChip IDE Channel1	[Enabled]
AC97 Audio	[Auto]
VIA onboard LAN *	[Enabled]
USB 1.1 Controller	[Enabled]
USB 2.0 Controller	[Enabled]
USB Keyboard Support	[Disabled]
USB Mouse Support	[Disabled]
Onboard Serial Port 1	[3F8/IRQ4]
Onboard Serial Port 2	[2F8/IRQ3]
Onboard Parallel Port	[378/IRQ7]
Parallel Port Mode	[SPP]
	Menu Level▶
	[Auto]
	Auto-detect IDE cable type
	[ATA66/100/133]
	Set Conductor cable to ATA66/100/133(80-pins)
	[ATA33]
	Set Conductor cable to ATA33(40-pins)
↑↓←→: Move Enter: Select +/-/PU/PD: Value F10: Save ESC: Exit F1: General Help F5: Previous Values F6: Fail-Safe Default F7: Optimized Defaults	

OnChip IDE Channel0

When enabled, allows you to use the onboard primary PCI IDE. If a hard disk controller card is used, set at Disabled.

- ▶ Enabled Enable onboard 1st channel IDE port. (Default v alue)
- ▶ Disabled Disable onboard 1st channel IDE port.

OnChip IDE Channel1

When enabled, allows you to use the onboard secondary PCI IDE. If a hard disk controller card is used, set at Disabled.

- ▶ Enabled Enable onboard 2nd channel IDE port. (Default v alue)
- ▶ Disabled Disable onboard 2nd channel IDE port.

AC97 Audio

- ▶ Auto Enable onboard AC'97 audio function. (Default v alue)
- ▶ Disabled Disable this function.

VIA onboard LAN *

- ▶ Enable Enable onboard LAN function.(Default v alue)
- ▶ Disable Disable onboard LAN function.

USB 1.1 Controller

Disable this option if you are not using the onboard USB feature.

- ▶ Enabled Enable USB1.1 Controller. (Default v alue)
- ▶ Disabled Disable USB1.1 Controller.

USB 2.0 Controller

Disable this option if you are not using the onboard USB 2.0 feature.

- ▶ Enabled Enable USB 2.0 Controller. (Default v alue)
- ▶ Disabled Disable USB 2.0 Controller.

*** For 8VM533M-RZ only.

☛ USB Keyboard Support

- ▶▶ Enabled Enable USB key board support.
- ▶▶ Disabled Disable USB keyboard support. (Default v alue)

☛ USB Mouse Support

- ▶▶ Enabled Enable USB mouse support.
- ▶▶ Disabled Disable USB mouse support. (Default v alue)

☛ Onboard Serial Port 1

- ▶▶ Auto BIOS will automatically setup the port 1 address.
- ▶▶ 3F8/IRQ4 Enable onboard Serial port 1 and address is 3F8. (Default v alue)
- ▶▶ 2F8/IRQ3 Enable onboard Serial port 1 and address is 2F8.
- ▶▶ 3E8/IRQ4 Enable onboard Serial port 1 and address is 3E8.
- ▶▶ 2E8/IRQ3 Enable onboard Serial port 1 and address is 2E8.
- ▶▶ Disabled Disable onboard Serial port 1.

☛ Onboard Serial Port 2

- ▶▶ Auto BIOS will automatically setup the port 2 address.
- ▶▶ 3F8/IRQ4 Enable onboard Serial port 2 and address is 3F8.
- ▶▶ 2F8/IRQ3 Enable onboard Serial port 2 and address is 2F8. (Default v alue)
- ▶▶ 3E8/IRQ4 Enable onboard Serial port 2 and address is 3E8.
- ▶▶ 2E8/IRQ3 Enable onboard Serial port 2 and address is 2E8.
- ▶▶ Disabled Disable onboard Serial port 2.

☛ Onboard Parallel port

- ▶▶ 378/IRQ7 Enable onboard LPT port and address is 378/IRQ7. (Default v alue)
- ▶▶ 278/IRQ5 Enable onboard LPT port and address is 278/IRQ5.
- ▶▶ Disabled Disable onboard LPT port.
- ▶▶ 3BC/IRQ7 Enable onboard LPT port and address is 3BC/IRQ7.

☛ Parallel Port Mode

- ▶▶ SPP Using Parallel port as Standard Parallel Port. (Default v alue)
- ▶▶ EPP Using Parallel port as Enhanced Parallel Port.
- ▶▶ ECP Using Parallel port as Extended Capabilities Port.
- ▶▶ ECP+EPP Using Parallel port as ECP & EPP mode.

Power Management Setup

CMOS Setup Utility-Copyright (C) 1984-2003 Award Software
Power Management Setup

		Item Help
	ACPI Suspend Type	[S1(POS)]
x	USB Device Wake-Up From S3	Disabled
	Soft-Off by PWR-BTTN	[Instant-Off]
	AC Back Function	[Soft-Off]
	Keyboard Power On	[Disabled]
	Mouse Power On	[Disabled]
	PME Event Wake Up	[Enabled]
	Resume by Alarm	[Disabled]
x	Date (of Month) Alarm	Everyday
x	Time (hh:mm:ss) Alarm	0 : 0 : 0
		Menu Level▶ [S1] Set suspend type to Power On Suspend under ACPI OS
		[S3] Set suspend type to Suspend to RAM under ACPI OS
↑↓←→: Move Enter: Select +/-/PU/PD: Value F10: Save ESC: Exit F1: General Help F5: Previous Values F6: Fail-Safe Default F7: Optimized Defaults		

ACPI Suspend Type

- ▶▶ S1(POS) Set ACPI suspend type to S1. (Default v alue)
- ▶▶ S3(STR) Set ACPI suspend type to S3.

USB Device Wakeup From S3(When ACPI Suspend Type is set [S3/STR])

USB Device wakeup From S3 can be set when ACPI standby state set to S3/STR.

- ▶▶ Enabled USB Device can wakeup system from S3.
- ▶▶ Disabled USB Device can't wakeup system from S3. (Default v alue)

Soft-off by PWR-BTTN

- ▶▶ Instant-off Press power button then Power off instantly. (Default v alue)
- ▶▶ Delay 4 Sec. Press power button 4 sec to Power off. Enter suspend if button is pressed less than 4 sec.

AC Back Function

- ▶▶ Soft-Off Always in Off state when AC back. (Default v alue)
- ▶▶ Memory System power on depends on the status before AC lost.
- ▶▶ Full-On Always power on the system when AC back.

Keyboard Power On

This feature allows you to set the method for powering-on the system.

The option "Password" allows you to set up to 8 alphanumeric characters to power-on the system. The option "Keyboard 98" allows you to use the standard keyboard 98 to power on the system.

- ▶▶ Password Enter from 1 to 8 characters to set the keyboard power on password.
- ▶▶ Disabled Disabled this function. (Default v alue)
- ▶▶ Keyboard 98 If your keyboard have "POWER Key" button, you can press the key to power on your system.

Mouse Power On

- ▶▶ Disabled Can't Power on system by Mouse Event. (Default v alue)
- ▶▶ Enabled Can Power on system by Mouse Event.

☛ **PME Event Wake Up**

When set at Enabled, any PCI-PM event aw akes the system from a PCI-PM controlled state.

This feature requires an ATX power supply that provides at least 1A on the +5VSB lead.

- ▶ Disabled Disable this function.
- ▶ Enabled Enable PME as wake up event. (Default v alue)

☛ **Resume by Alarm**

You can set "Resume by Alarm" item to enabled and key in Data/time to power on sy stem.

- ▶ Disabled Disable this function. (Default Value)
- ▶ Enabled Enable alarm function to POWER ON sy stem.

If RTC Alarm Lead To Power On is Enabled.

Date (of Month) Alarm : Every day, 1~31
 Time (hh: mm: ss) Alarm : (0~23) : (0~59) : (0~59)

PnP/PCI Configurations

CMOS Setup Utility-Copyright (C) 1984-2003 Award Software
 PnP/PCI Configurations

		Item Help
PCI 1 IRQ Assignment	[Auto]	Menu Level▶ Device(s) using this INT: Display Cntrlr -Bus 1 Dev 0 Func 0
PCI 2 IRQ Assignment	[Auto]	
PCI 3 IRQ Assignment	[Auto]	
↑↓→←: Move Enter: Select +/-/PU/PD: Value F10: Save ESC: Exit F1: General Help F5: Previous Values F6: Fail-Safe Default F7: Optimized Defaults		

☛ **PCI 1 IRQ Assignment**

- ▶ Auto Auto assign IRQ to PCI 1. (Default value)
- ▶ 3,4,5,7,9,10,11,12,14,15 Set IRQ 3,4,5,7,9,10,11,12,14,15 to PCI 1.

☛ **PCI 2 IRQ Assignment**

- ▶ Auto Auto assign IRQ to PCI 2. (Default value)
- ▶ 3,4,5,7,9,10,11,12,14,15 Set IRQ 3,4,5,7,9,10,11,12,14,15 to PCI 2.

☛ **PCI 3 IRQ Assignment**

- ▶ Auto Auto assign IRQ to PCI 3. (Default value)
- ▶ 3,4,5,7,9,10,11,12,14,15 Set IRQ 3,4,5,7,9,10,11,12,14,15 to PCI 3.

PC Health Status

CMOS Setup Utility—Copyright (C) 1984–2003 Award Software
PC Health Status

		Item Help	
Vcore	1.54V	Menu Level▶ Don't reset case open status Clear case open status at next boot	
DDR25V	2.544V		
+3.3V	3.360V		
+12V	11.92V		
Current CPU Temperature	45° C		
Current CPU FAN Speed	4440 RPM		
CPU FAN Fail Warning	[Disabled]		
↑↓→←: Move Enter: Select +/-/PU/PD: Value F10: Save ESC: Exit F1: General Help F5: Previous Values F6: Fail-Safe Default F7: Optimized Defaults			

- ☞ **Current Voltage (V) Vcore / DDR25V / +3.3V / +12V**
 - ▶▶ Detect system's voltage status automatically.
- ☞ **Current CPU Temperature**
 - ▶▶ Detect CPU temperature automatically.
- ☞ **Current CPU FAN Speed (RPM)**
 - ▶▶ Detect CPU Fan speed status automatically.
- ☞ **CPU FAN Fail Warning**
 - ▶▶ Disabled Fan warning function disable. (Default value)
 - ▶▶ Enabled Fan warning function enable.

Frequency/Voltage Control

CMOS Setup Utility-Copyright (C) 1984-2003 Award Software
Frequency/Voltage Control

CPU Clock Ratio	[15X]	Item Help
Auto Detect PCI/DIMM Clk	[Enabled]	Menu Level▶
Spread Spectrum	[Enabled]	
CPU Host Clock Control	[Disabled]	
✱ CPU Clock	100	
↑↓→←: Move Enter: Select +/-/PU/PD: Value F10: Save ESC: Exit F1: General Help F5: Previous Values F6: Fail-Safe Default F7: Optimized Defaults		

✱ This item will be available when "CPU Host Clock Control" is set to Enabled.

☛ CPU Clock Ratio

This option will not be shown or not be available if you are using a CPU with the locked ratio.

▶▶ 15X~21X It depends on CPU Clock Ratio.

This setup option will automatically assign by CPU detection.

For C-Stepping P4: 8X,10X~24X default: 15X

For Northwood CPU: 12X~24X default: 16X

The option will display "Locked" and read only if the CPU ratio is not changeable.

☛ Auto Detect PCI/DIMM Clk

▶▶ Disabled Disable auto detect PCI/DIMM Clk.

▶▶ Enabled Enable auto detect PCI/DIMM Clk. (Default v alue)

☛ Spread Spectrum

▶▶ Disabled Disable spread spectrum.

▶▶ Enabled Enable spread spectrum. (Default v alue)

☛ CPU Host Clock Control

Note: If system hangs up before enter CMOS setup utility , wait for 20 sec for times out reboot.

When time out occur, system will reset and run at CPU default Host clock at next boot.

▶▶ Disabled Disable CPU Host Clock Control. (Default v alue)

▶▶ Enabled Enable CPU Host Clock Control.

☛ CPU Clock

Incorrect using it may cause your system broken. For power End-User use only!

▶▶ 100 Set CPU Clock to 100MHz~132MHz.

▶▶ 133 Set CPU Clock to 133MHz~165MHz.

Load Fail-Safe Defaults

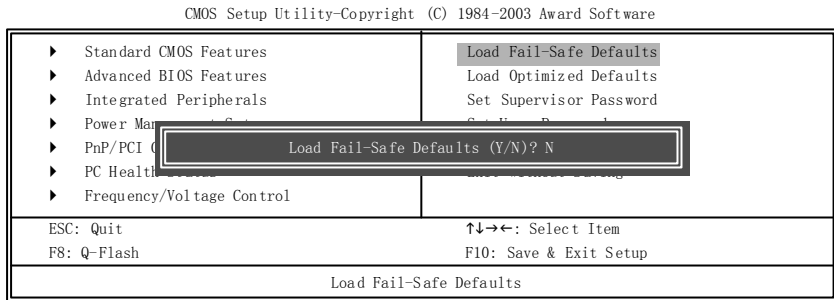

Fail-Safe defaults contain the most appropriate values of the system parameters that allow minimum system performance.

Load Optimized Defaults

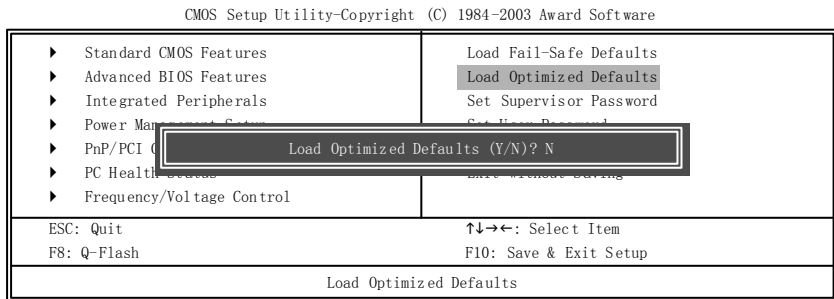

Selecting this field loads the factory defaults for BIOS and Chipset Features which the system automatically detects.

Set Supervisor/User Password

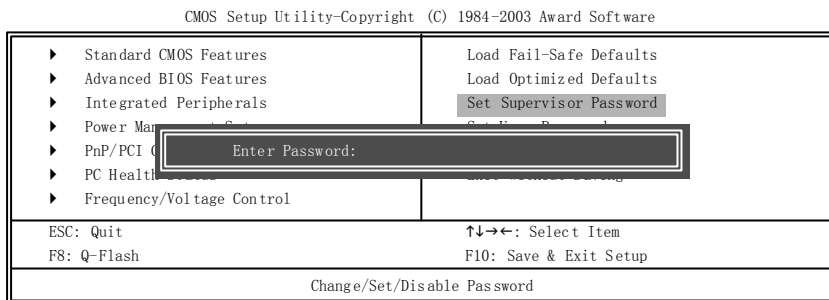

When you select this function, the following message will appear at the center of the screen to assist you in creating a password.

Type the password, up to eight characters, and press <Enter>. You will be asked to confirm the password. Type the password again and press <Enter>. You may also press <Esc> to abort the selection and not enter a password.

To disable password, just press <Enter> when you are prompted to enter password. A message "PASSWORD DISABLED" will appear to confirm the password being disabled. Once the password is disabled, the system will boot and you can enter Setup freely.

The BIOS Setup program allows you to specify two separate passwords:

SUPERVISOR PASSWORD and a USER PASSWORD. When disabled, anyone may access all BIOS Setup program function. When enabled, the Supervisor password is required for entering the BIOS Setup program and having full configuration fields, the User password is required to access only basic items.

If you select "System" at "Password Check" in Advance BIOS Features Menu, you will be prompted for the password every time the system is rebooted or any time you try to enter Setup Menu.

If you select "Setup" at "Password Check" in Advance BIOS Features Menu, you will be prompted only when you try to enter Setup.

Save & Exit Setup

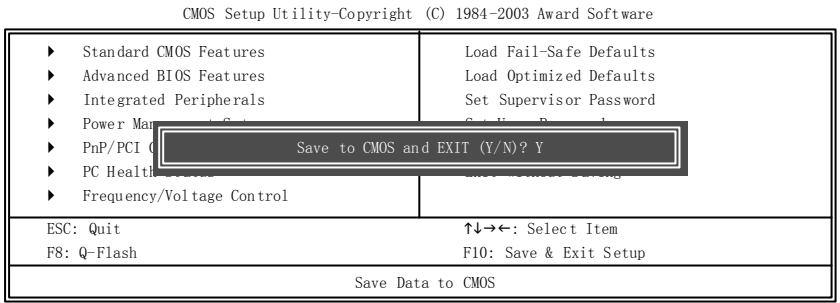

Type "Y" will quit the Setup Utility and save the user setup value to RTC CMOS.
 Type "N" will return to Setup Utility .

Exit Without Saving

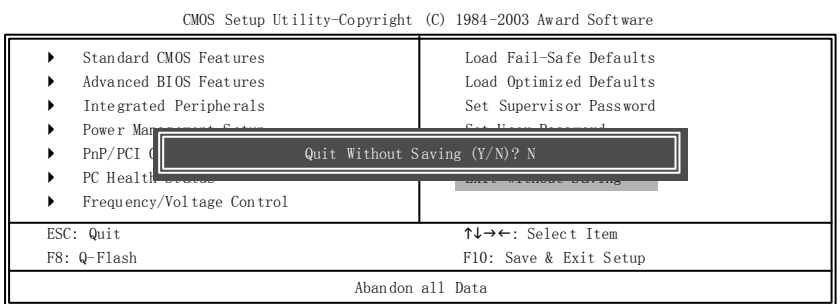

Type "Y" will quit the Setup Utility without saving to RTC CMOS.
 Type "N" will return to Setup Utility .

Chapter 3 Install Drivers

Install Drivers





Pictures below are shown in Windows XP (CD ver. 2.3)

Insert the driver CD-title that came with your motherboard into your CD-ROM drive, the driver CD-title will auto start and show the installation guide. If not, please double click the CD-ROM device icon in "My computer", and execute the setup.exe.

INSTALL CHIPSET DRIVER

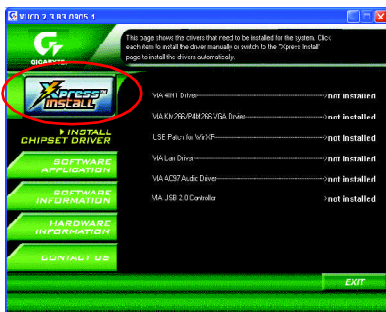
This page shows the drivers that need to be installed for the system. Click each item to install the driver manually or switch to the  to install the drivers automatically.



The "Xpress Install" uses the "Click and Go" technology to install the drivers automatically. Just select the drivers you want then click the "GO" button. The  will execute the installation for you by itself.

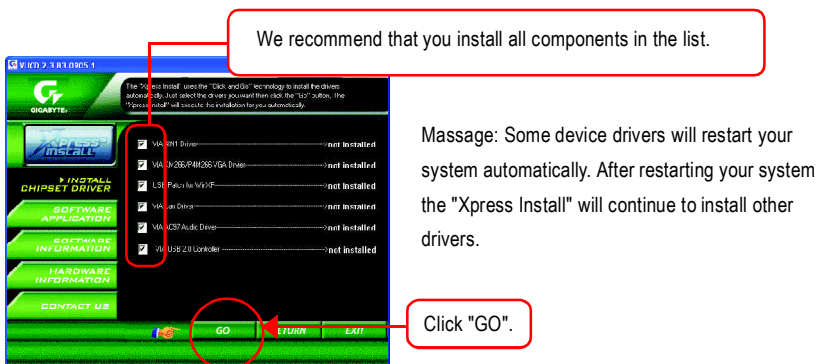

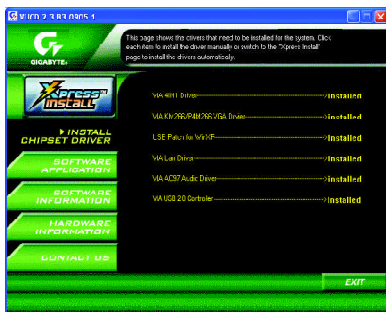

Driver install finished!! you have to reboot system!!

Item Description

- VIA 4IN1 Driver
For INF, AGP, IDE and DMA Driver.
- VIA KM266/P4M266 VGA Driver
For VIA KM266/P4M266 VGA driver.
- USB Path for WinXP
This patch driver can help you to resolve the USB device wake up S3 hang up issue in XP.
- VIA Lan Driver *
For VIA LAN driver.
- VIA AC97 Audio Driver
Audio driver for VIA AC97 codec chipset.
- VIA USB 2.0 Controller
For VIA VT8233 (VT6203) / VIA VT8235 / VIA VT8237/ VIA VT8237R south bridge.



For USB2.0 driver support under Windows XP operating system, please use Windows Service Pack. After install Windows Service Pack, it will show a question mark "?" in "Universal Serial Bus controller" under "Device Manager". Please remove the question mark and restart the system (System will auto-detect the right USB2.0 driver).

*** For 8VM533M-RZ only.



Contact Us

- **Taiwan (Headquarters)**

GIGA-BYTE TECHNOLOGY CO., LTD.

Address: No.6, Bau Chiang Road, Hsin-Tien, Taipei Hsien, Taiwan

TEL: +886 (2) 8912-4888

FAX: +886 (2) 8912-4003

Tech. Support :

<http://tw.giga-byte.com/TechSupport/ServiceCenter.htm>

Non-Tech. Support (Sales/Marketing) :

<http://ggts.gigabyte.com.tw/nontech.asp>

WEB address (English) : <http://www.gigabyte.com.tw>

WEB address (Chinese) : <http://chinese.giga-byte.com>

- **U.S.A.**

G.B.T. INC.

Address: 17358 Railroad St, City of Industry, CA 91748.

TEL: +1 (626) 854-9338

FAX: +1 (626) 854-9339

Tech. Support :

<http://www.giga-byte.com/TechSupport/ServiceCenter.htm>

Non-Tech. Support (Sales/Marketing) :

<http://ggts.gigabyte.com.tw/nontech.asp>

WEB address : <http://www.giga-byte.com>

- **Germany**

G.B.T. TECHNOLOGY TRADING GMBH

Address: Friedrich-Ebert-Damm 11222047 Hamburg

TEL: +49-40-2533040 (Sales)

+49-1803-428468 (Tech.)

FAX: +49-40-25492343 (Sales)

+49-1803-428329 (Tech.)

Tech. Support :

<http://de.giga-byte.com/TechSupport/ServiceCenter.htm>

Non-Tech. Support (Sales/Marketing) :

<http://ggts.gigabyte.com.tw/nontech.asp>

WEB address : <http://www.gigabyte.de>

- **Japan**

NIPPON GIGA-BYTE CORPORATION

WEB address : <http://www.gigabyte.co.jp>

- **Singapore**

GIGA-BYTE SINGAPORE PTE. LTD.

Tech. Support :

<http://tw.giga-byte.com/TechSupport/ServiceCenter.htm>

Non-Tech. Support (Sales/Marketing) :

<http://ggts.gigabyte.com.tw/nontech.asp>

- **U.K.**

G.B.T. TECH. CO., LTD.

Address: GUnit 13 Avanti Business Centre 3 Third Avenue, Denbigh West Bletchley Milton Keynes, MK1 1DR, UK, England

TEL: +44-1908-362700

FAX: +44-1908-362709

Tech. Support :

<http://uk.giga-byte.com/TechSupport/ServiceCenter.htm>

Non-Tech. Support (Sales/Marketing) :

<http://ggts.gigabyte.com.tw/nontech.asp>

WEB address : <http://uk.giga-byte.com>

- **The Netherlands**

GIGA-BYTE TECHNOLOGY B.V.

TEL: +31 40 290 2088

NL Tech.Support: 0900-GIGABYTE (0900-44422983)

BE Tech.Support: 0900-84034

FAX: +31 40 290 2089

Tech. Support :

<http://nz.giga-byte.com/TechSupport/ServiceCenter.htm>

Non-Tech. Support (Sales/Marketing) :

<http://ggts.gigabyte.com.tw/nontech.asp>

WEB address : <http://www.giga-byte.nl>

- **China**

NINGBO G.B.T. TECH. TRADING CO., LTD.

Tech. Support :

<http://cn.giga-byte.com/TechSupport/ServiceCenter.htm>

Non-Tech. Support (Sales/Marketing) :

<http://ggts.gigabyte.com.tw/nontech.asp>

WEB address : <http://www.gigabyte.com.cn>

Shanghai

TEL: +86-021-63410999

FAX: +86-021-63410100

Beijing

TEL: +86-010-82886651

FAX: +86-010-82888013

Wuhan

TEL: +86-027-87851061

FAX: +86-027-87851330

GuangZhou

TEL: +86-020-87586074

FAX: +86-020-85517843

Chengdu

TEL: +86-028-85236930

FAX: +86-028-85256822

Xian

TEL: +86-029-85531943

FAX: +86-029-85539821

Shenyang

TEL: +86-024-23960918

FAX: +86-024-23960918-809

- **Australia**

GIGABYTE TECHNOLOGY PTY. LTD.

Address: 3/6 Garden Road, Clayton, VIC 3168 Australia

TEL: +61 3 85616288

FAX: +61 3 85616222

Tech. Support :

<http://www.giga-byte.com.au/TechSupport/ServiceCenter.htm>

Non-Tech. Support (Sales/Marketing) :

<http://ggts.gigabyte.com.tw/nontech.asp>

WEB address : <http://www.giga-byte.com.au>

- **France**

GIGABYTE TECHNOLOGY FRANCES S.A.R.L.

Tech. Support :

<http://tw.giga-byte.com/TechSupport/ServiceCenter.htm>

Non-Tech. Support (Sales/Marketing) :

<http://ggts.gigabyte.com.tw/nontech.asp>

WEB address : <http://www.gigabyte.fr>

- **Russia**

Moscow Representative Office Of Giga-Byte Technology Co., Ltd.

Tech. Support :

<http://tw.giga-byte.com/TechSupport/ServiceCenter.htm>

Non-Tech. Support (Sales/Marketing) :

<http://ggts.gigabyte.com.tw/nontech.asp>

WEB address : <http://www.gigabyte.ru>

- **Poland**

Representative Office Of Giga-Byte Technology Co., Ltd.

POLAND

Tech. Support :

<http://tw.giga-byte.com/TechSupport/ServiceCenter.htm>

Non-Tech. Support (Sales/Marketing) :

<http://ggts.gigabyte.com.tw/nontech.asp>

WEB address : <http://www.gigabyte.pl>

Free Manuals Download Website

<http://myh66.com>

<http://usermanuals.us>

<http://www.somanuals.com>

<http://www.4manuals.cc>

<http://www.manual-lib.com>

<http://www.404manual.com>

<http://www.luxmanual.com>

<http://aubethermostatmanual.com>

Golf course search by state

<http://golfingnear.com>

Email search by domain

<http://emailbydomain.com>

Auto manuals search

<http://auto.somanuals.com>

TV manuals search

<http://tv.somanuals.com>