

8S661FXMP-RZ

Intel® Pentium® 4 Processor Motherboard

User's Manual

Rev. 1002

12ME-661FXMPRZ-1002

Copyright

© 2005 GIGABYTE TECHNOLOGY CO., LTD

Copyright by **GIGA-BYTE TECHNOLOGY CO., LTD. ("GBT")**. No part of this manual may be reproduced or transmitted in any form without the expressed, written permission of **GBT**.

Trademarks

Third-party brands and names are the property of their respective owners.

Notice

Please do not remove any labels on motherboard, this may void the warranty of this motherboard.

Due to rapid change in technology, some of the specifications might be out of date before publication of this booklet.

The author assumes no responsibility for any errors or omissions that may appear in this document nor does the author make a commitment to update the information contained herein.

Declaration of Conformity

G.B.T. Technology Training GmbH

We, Manufacturer/Importer

Auserschlager Weg 41, 1F 20537 Hamburg, Germany

declare that the product
(description of the apparatus, system, installation to which it refers)

(reference to the specification under which conformity is declared)
in accordance with 89/338 EEC/EMC Directive

Mother Board

- | | | | |
|----------------------------------------------|------------------------------------------------------------------------------------------------------------------------------------------------------------|----------------------------------------------|----------------------------------------------------------------------------------------|
| <input type="checkbox"/> EN 55011 | Limits and methods of measurement of radio disturbance characteristics of industrial, scientific and medical (ISM) high frequency equipment | <input type="checkbox"/> EN 51000-3-2 | Disturbances in supply systems caused by radio frequency equipment |
| <input type="checkbox"/> EN 55013 | Limits and methods of measurement of radio disturbance characteristics of broadcast receivers and associated equipment | <input checked="" type="checkbox"/> EN 55024 | Information technology equipment - Limits and methods of measurement |
| <input type="checkbox"/> EN 55014-1 | Limits and methods of measurement of radio disturbance characteristics of household electrical appliances, portable tools and similar electrical apparatus | <input type="checkbox"/> EN 55022-1 | Generic immunity standard Part 1: Residential, commercial and light industry |
| <input type="checkbox"/> EN 55015 | Limits and methods of measurement of radio disturbance characteristics of fluorescent lamps and luminaires | <input type="checkbox"/> EN 55014-2 | Immunity requirements for household electrical appliances, tools and similar apparatus |
| <input type="checkbox"/> EN 55020 | Immunity from radio interference of equipment | <input type="checkbox"/> EN 55019-2 | EMC requirements for uninterruptible power systems (UPS) |
| <input checked="" type="checkbox"/> EN 55022 | Limits and methods of measurement of radio disturbance characteristics of information technology equipment | | |
| <input type="checkbox"/> EN IEC 6085 | Cabled distribution systems, Equipment for receiving and/or distribution from part 10 | | |
| <input type="checkbox"/> Part 12 | sound and television signals | | |
- CE marking
- (EC conformity marking)
- 
- The manufacturer also declares the conformity of above mentioned product with the actual required safety standards in accordance with LVD 7323 EEC
- | | | | |
|-----------------------------------|------------------------------------------------------------------------------------------------|-------------------------------------|-------------------------------------------------------------------------------------|
| <input type="checkbox"/> EN 60085 | Safety requirements for mains operated household and similar general use electrical appliances | <input type="checkbox"/> EN 60950 | Safety for information technology equipment including electrical business equipment |
| <input type="checkbox"/> EN 60335 | Safety of household and similar electrical appliances | <input type="checkbox"/> EN 50091-1 | General and Safety requirements for uninterruptible power systems (UPS) |

Manufacturer/Importer

Signature: Jimmy Huang

(Stamp)

Date: Oct. 22, 2004

Name: Jimmy Huang

DECLARATION OF CONFORMITY

Per FCC Part 2, Section 2.1077(a)



Responsible Party Name: G.B.T. INC. (U.S.A.)

Address: 17358 Railroad Street

City of Industry, CA 91748

Phone/Fax No: (818) 854-9338/ (818) 854-9339

hereby declares that the product

Product Name: Motherboard

Model Number: 8S661FXMP-RZ

Conforms to the following specifications:

FCC Part 15, Subpart B, Section 15.107(a) and Section 15.109

(a) Class B Digital Device

Supplementary Information:

This device complies with part 15 of the FCC Rules. Operation is subject to the following two conditions: (1) This device may not cause harmful and (2) this device must accept any interference received, including that may cause undesired operation.

Representative Person's Name: ERIC LU

Signature: Eric Lu

Date: Oct. 22, 2004

Preparing Your Computer

Computer motherboards and expansion cards contain very delicate Integrated Circuit (IC) chips. To protect them against damage from static electricity, you should follow some precautions whenever you work on your computer.

1. Unplug your computer when working on the inside.
2. Use a grounded wrist strap before handling computer components. If you do not have one, touch both of your hands to a safely grounded object or to a metal object, such as the power supply case.
3. Hold components by the edges and try not touch the IC chips, leads or connectors, or other components.
4. Place components on a grounded antistatic pad or on the bag that came with the components whenever the components are separated from the system.
5. Ensure that the ATX power supply is switched off before you plug in or remove the ATX power connector on the motherboard.



Installing the motherboard to the chassis

If the motherboard has mounting holes, but they don't line up with the holes on the base and there are no slots to attach the spacers, do not become alarmed you can still attach the spacers to the mounting holes. Just cut the bottom portion of the spacers (the spacer may be a little hard to cut off, so be careful of your hands). In this way you can still attach the motherboard to the base without worrying about short circuits. Sometimes you may need to use the plastic springs to isolate the screw from the motherboard PCB surface, because the circuit wire may be near by the hole. Be careful, don't let the screw contact any printed circuit write or parts on the PCB that are near the fixing hole, otherwise it may damage the board or cause board malfunctioning.

Table of Content

Chapter 1 Introduction	5
Features Summary	5
8S661FXMP-RZ Motherboard Layout	7
Block Diagram	8
Hardware Installation Process	9
Step 1: Install the Central Processing Unit (CPU)	9
Step 1-1: CPU Installation	10
Step 1-2: CPU Cooling Fan Installation	10
Step 2: Install memory modules	11
Step 3: Install expansion cards	12
Step 4: Install I/O Peripherals Cables	12
Step 4-1: I/O Back Panel Introduction	12
Step 4-2: Connectors Introduction	13
 Chapter 2 BIOS Setup	 21
The Main Menu (For example: BIOS Ver. : E2)	21
Standard CMOS Features	23
Advanced BIOS Features	25
Integrated Peripherals	27
Power Management Setup	29
PnP/PCI Configurations	31
PC Health Status	32
MB Intelligent Tweaker (M.I.T.)	33
Load Fail-Safe Defaults	35
Load Optimized Defaults	35
Set Supervisor/User Password	35
Save & Exit Setup	36
Exit Without Saving	36
 Chapter 3 Driver Installation	 37

Chapter 1 Introduction

Features Summary

CPU	<ul style="list-style-type: none"> • Socket 478 for Intel® Pentium® 4 (Northwood, Prescott) processor with HT Technology • Supports 800/533/400MHz FSB • L2 cache varies with processors
Chipset	<ul style="list-style-type: none"> • North Bridge:SiS® 661FX Chipset • South Bridge:SiS® 964
Memory	<ul style="list-style-type: none"> • 2 184-pin DDR slots • Supports DDR400/DDR333/DDR266 DIMMs • Supports up to 2GB (Max.)
Slots	<ul style="list-style-type: none"> • 1 AGP slot 4X/8X (1.5V) device support • 3 PCI slots
IDE Connections	<ul style="list-style-type: none"> • 2 IDE connection (UDMA 33/ATA 66/ATA 100/ATA 133), allows connection of 4 IDE devices
Onboard SATA	<ul style="list-style-type: none"> • 2 Serial ATA ports
FDD Connections	<ul style="list-style-type: none"> • 1 FDD connection, allows connection of 2 FDD devices
Peripherals	<ul style="list-style-type: none"> • 1 parallel port supporting Normal/EPP/ECP mode • 1 VGA port, 1 COMA port, onboard COMB connection • 8 USB 2.0/1.1 ports (rear x 4, front x 4 via cable) • 1 front audio connector • 1 PS/2 keyboard port • 1 PS/2 mouse port
Onboard VGA	<ul style="list-style-type: none"> • Built-in SiS® 661FX Chipset
Onboard LAN	<ul style="list-style-type: none"> • ICS 1883 chip • 1 RJ45 port
Onboard Audio	<ul style="list-style-type: none"> • Realtek ALC655 CODEC • Supports Line In ; Line Out ; MIC In • Supports 2 / 4 / 6 channel audio • SPDIF In/Out connection • CD In connection • Supports Jack-Sensing function
BIOS	<ul style="list-style-type: none"> • Use of licensed AWARD BIOS • Supports Q-Flash

to be continued.....

I/O Control	<ul style="list-style-type: none">• IT8705AF
Onboard SATA RAID	<ul style="list-style-type: none">• Onboard SiS964 chipset<ul style="list-style-type: none">- supports data striping (RAID 0) or mirroring (RAID 1) function- supports JBOD function- supports data transfer rate of up to 150 MB/s- supports hot plugging function- supports a maximum of 2 SATA connections
Hardware Monitor	<ul style="list-style-type: none">• CPU / System fan speed detection• System voltage detection• CPU temperature detection
Additional Features	<ul style="list-style-type: none">• Supports EasyTune 5 (only supports Hardware Monitor function)• Supports @BIOS
Form Factor	<ul style="list-style-type: none">• Micro-ATX form factor; 24.4cm x 23.0cm



Please set the CPU host frequency in accordance with your processor's specifications. We don't recommend you to set the system bus frequency over the CPU's specification because these specific bus frequencies are not the standard specifications for CPU, chipset and most of the peripherals. Whether your system can run under these specific bus frequencies properly will depend on your hardware configurations, including CPU, Chipsets, Memory, Cards....etc.

8S661FXMP-RZ Motherboard Layout

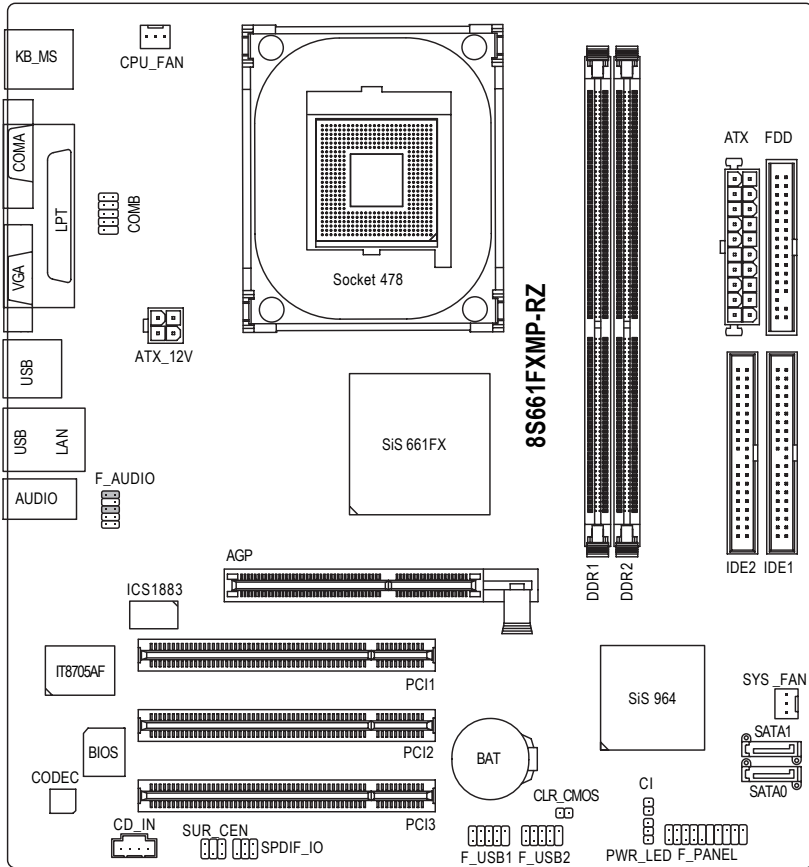

Block Diagram

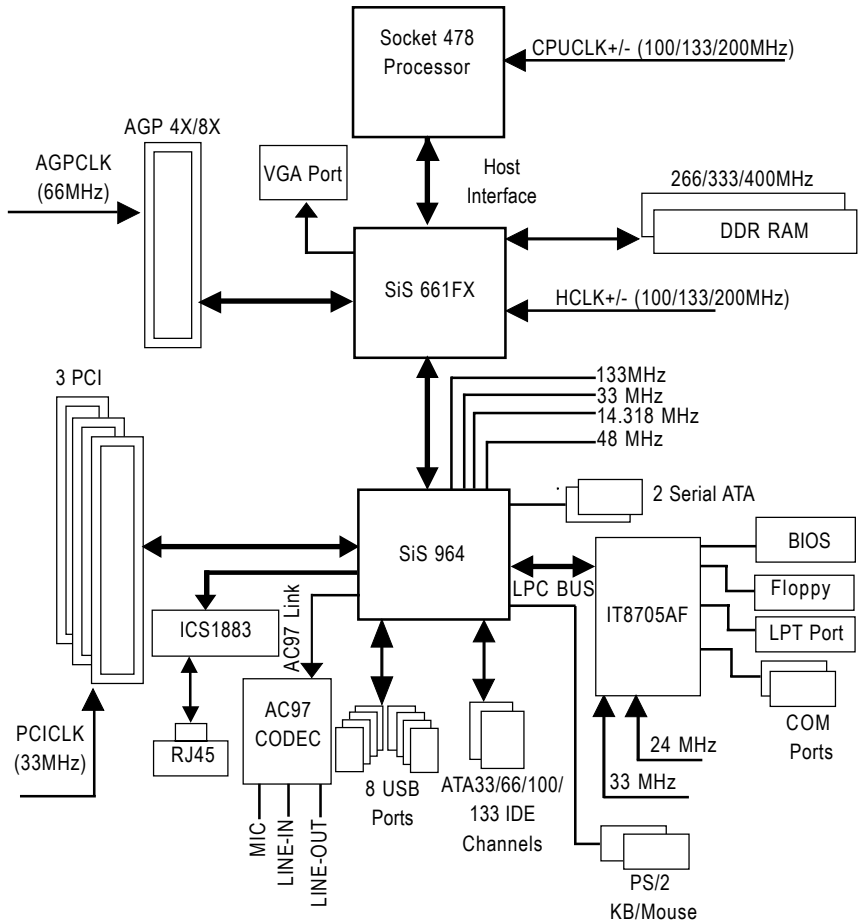

Hardware Installation Process

To set up your computer, you must complete the following steps:

- Step 1- Install the Central Processing Unit (CPU)
- Step 2- Install memory modules
- Step 3- Install expansion cards
- Step 4- Install I/O Peripherals cables

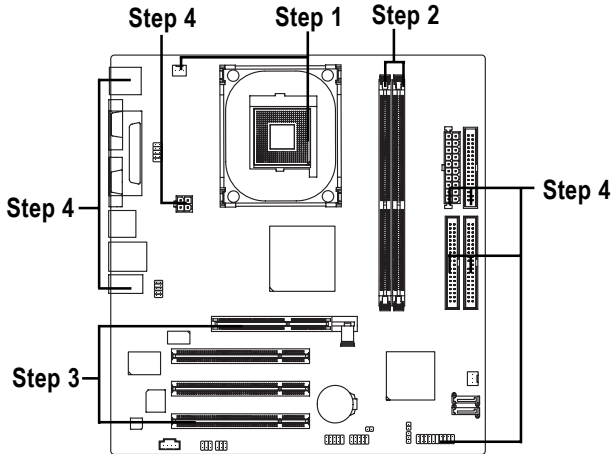

Step 1: Install the Central Processing Unit (CPU)



Before installing the CPU, please comply with the following conditions:

1. Please make sure that the motherboard supports the CPU.
2. Please take note of the one indented corner of the CPU. If you install the CPU in the wrong direction, the CPU will not insert properly. If this occurs, please change the insert direction of the CPU.
3. Please add an even layer of heat sink paste between the CPU and heatsink.
4. Please make sure the heatsink is installed on the CPU prior to system use, otherwise overheating and permanent damage of the CPU may occur.
5. Please set the CPU host frequency in accordance with the processor specifications. It is not recommended that the system bus frequency be set beyond hardware specifications since it does not meet the required standards for the peripherals. If you wish to set the frequency beyond the proper specifications, please do so according to your hardware specifications including the CPU, graphics card, memory, hard drive, etc.



HT functionality requirement content :

Enabling the functionality of Hyper-Threading Technology for your computer system requires all of the following platform components:

- CPU: An Intel® Pentium 4 Processor with HT Technology
- Chipset: An SiS® Chipset that supports HT Technology
- BIOS: A BIOS that supports HT Technology and has it enabled
- OS: An operation system that has optimizations for HT Technology

Step 1-1: CPU Installation

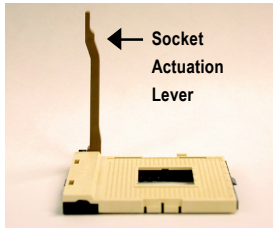

Figure 1.
Pull the rod to the 90-degree directly.

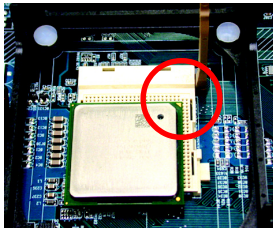

Figure 2.
Locate Pin 1 in the socket and look for a (golden) cut edge on the CPU upper corner. Insert the CPU into the socket. (Do not force the CPU into the socket.) Then move the socket lever to the locked position while holding pressure on the center of the CPU.

Step 1-2: CPU Cooling Fan Installation



Figure 1.
Apply the thermal tape(or grease) to provide better heat conduction between your CPU and cooling fan.



Figure 2.
Fasten the cooling fan supporting-base onto the CPU socket on the motherboard.

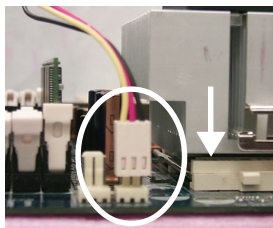

Figure 3.
Make sure the CPU fan is plugged to the CPU fan connector, and then the installation is completed.

Step 2: Install memory modules



Before installing the memory modules, please comply with the following conditions:

1. Please make sure that the memory used is supported by the motherboard. It is recommended that memory of similar capacity, specifications and brand be used.
2. Before installing or removing memory modules, please make sure that the computer power is switched off to prevent hardware damage.
3. Memory modules have a foolproof insertion design. A memory module can be installed in only one direction. If you are unable to insert the module, please switch the direction.

The motherboard has 2 dual inline memory module (DIMM) sockets. The BIOS will automatically detect memory type and size. To install the memory module, just push it vertically into the DIMM socket. The DIMM module can only fit in one direction due to the notch. Memory size can vary between sockets.

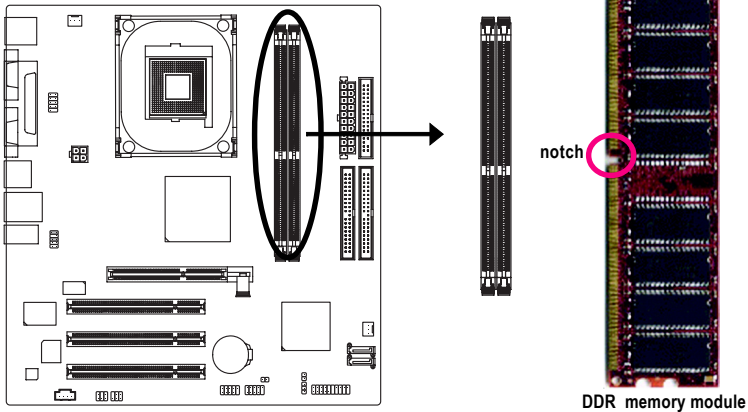

Fig.1

The DIMM socket has a notch, so the DIMM memory module can only fit in one direction. Insert the DIMM memory module vertically into the DIMM socket. Then push it down.



Fig. 1

Fig.2

Close the plastic clip at both edges of the DIMM sockets to lock the DIMM module.

Reverse the installation steps when you wish to remove the DIMM module.

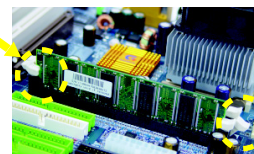

Fig. 2

Step 3: Install expansion cards

1. Read the related expansion card's instruction document before installing the expansion card into the computer.
2. Please make sure your AGP card is AGP 4X/8X (1.5V).



3. Please carefully pull out the small white drawable bar at the end of the AGP slot when you try to install/ Uninstall the AGP card. Please align the AGP card to the onboard AGP slot and press firmly down on the slot. Make sure your AGP card is locked by the small white-drawable bar.

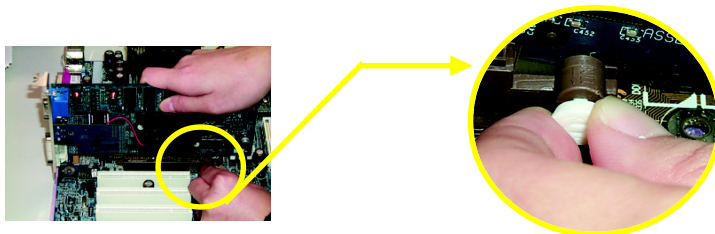

AGP Card

Step 4: Install I/O Peripherals Cables

Step 4-1: I/O Back Panel Introduction

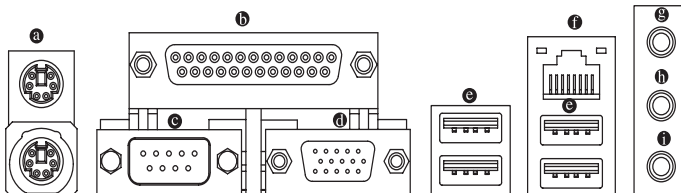

a PS/2 Keyboard and PS/2 Mouse Connector

To install a PS/2 port keyboard and mouse, plug the mouse to the upper port (green) and the keyboard to the lower port (purple).

b Parallel Port

The parallel port allows connection of a printer, scanner and other peripheral devices.

c Serial Port

Devices like mouses, modems, and etc. can be connected to Serial port.

d VGA Port

Monitor can be connected to VGA port.

e USB port

Before you connect your device(s) into USB connector(s), please make sure your device(s) such as USB keyboard, mouse, scanner, zip, speaker...etc. have a standard USB interface. Also make sure your OS supports USB controller. If your OS does not support USB controller, please contact OS vendor for possible patch or driver upgrade. For more information please contact your OS or device(s) vendors.

④ **LAN Port**

The LAN port provides Internet connection.

⑤ **Line In**

Devices like CD-ROM, walkman etc. can be connected to Line In jack.

⑥ **Line Out (Front Speaker Out)**

Connect the stereo speakers, earphone or front surround channels to this connector.

⑦ **MIC In**

Microphone can be connected to MIC In jack.

Step 4-2: Connectors Introduction

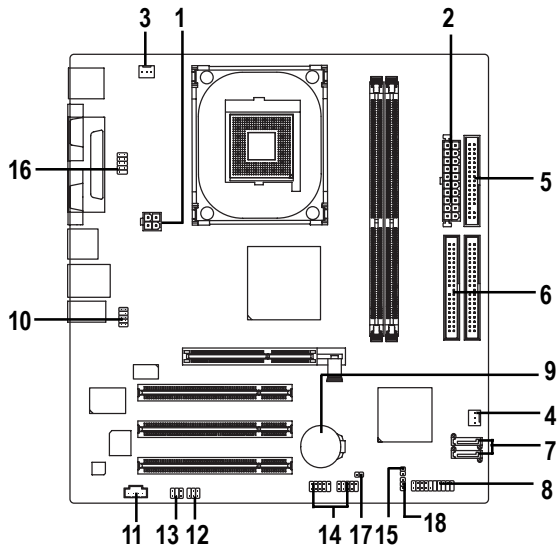

1) ATX_12V	10) F_AUDIO
2) ATX	11) CD_IN
3) CPU_FAN	12) SPDIF_IO
4) SYS_FAN	13) SUR_CEN
5) FDD	14) F_USB1 / F_USB2
6) IDE1 / IDE2	15) CI
7) SATA0/SATA1	16) COMB
8) F_PANEL	17) CLR_CMOS
9) BAT	18) PWR_LED

1/2) ATX_12V/ATX (Power Connector)

With the use of the power connector, the power supply can supply enough stable power to all the components on the motherboard. Before connecting the power connector, please make sure that all components and devices are properly installed. Align the power connector with its proper location on the motherboard and connect tightly.

The ATX_12V power connector mainly supplies power to the CPU. If the ATX_12V power connector is not connected, the system will not start.

Caution!

Please use a power supply that is able to handle the system voltage requirements. It is recommended that a power supply that can withstand high power consumption be used (300W or greater). If a power supply is used that does not provide the required power, the result can lead to an unstable system or a system that is unable to start.

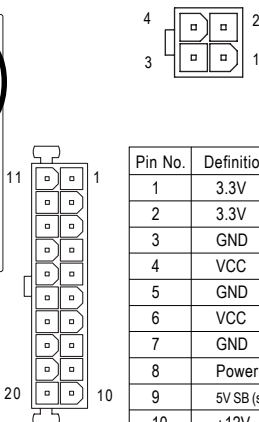
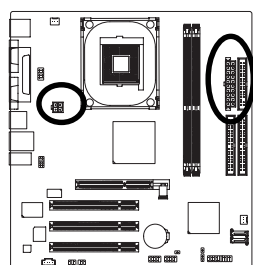

Pin No.	Definition
1	GND
2	GND
3	+12V
4	+12V

Pin No.	Definition	Pin No.	Definition
1	3.3V	11	3.3V
2	3.3V	12	-12V
3	GND	13	GND
4	VCC	14	PS_ON(soft on/off)
5	GND	15	GND
6	VCC	16	GND
7	GND	17	GND
8	Power Good	18	-5V
9	5V SB (stand by +5V)	19	VCC
10	+12V	20	VCC

3) CPU_FAN (CPU FAN Connector)

Please note, a proper installation of the CPU cooler is essential to prevent the CPU from running under abnormal condition or damaged by overheating. The CPU fan connector supports Max. current up to 600 mA.

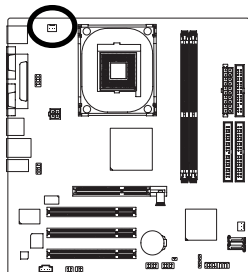

Pin No.	Definition
1	GND
2	+12V
3	Sense

4) SYS_FAN (System FAN Connector)

This connector allows you to link with the cooling fan on the system case to lower the system temperature.

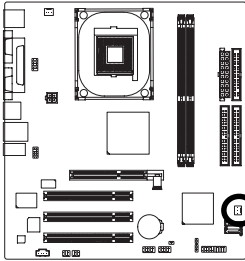

Pin No.	Definition
1	GND
2	+12V
3	Sense

5) FDD (Floppy Connector)

Please connect the floppy drive ribbon cables to FDD. It supports 360K,720K,1.2M,1.44M and 2.88Mbytes floppy disk types. The red stripe of the ribbon cable must be the same side with the Pin1.

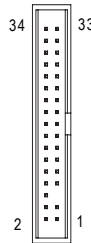
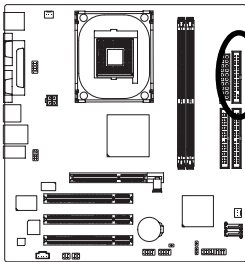

6) IDE1/ IDE2 (IDE1/IDE2 Connector)

Please connect first harddisk to IDE1 and connect CDROM to IDE2.
The red stripe of the ribbon cable must be the same side with the Pin1.

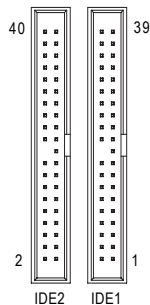
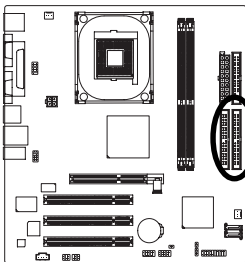

7) SATA0/SATA1 (Serial ATA Connector, Controlled by SiS964)

Serial ATA can provide 150MB/s transfer rate. Please refer to the BIOS setting for the Serial ATA and install the proper driver in order to work properly.

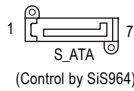
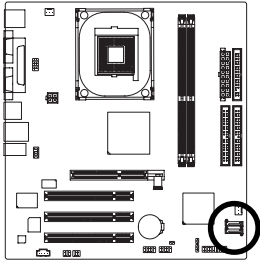

Pin No.	Definition
1	GND
2	TXP
3	TXN
4	GND
5	RXN
6	RXP
7	GND



For more detailed Serial ATA RAID setup information, please visit our website at <http://www.gigabyte.com.tw>.

8) F_PANEL (2x10 pins connector)

Please connect the power LED, PC peaker, reset switch and power switch etc. of your chassis front panel to the F_PANEL connector according to the pin assignment above.

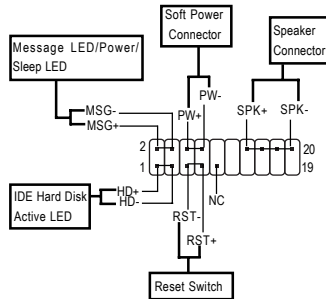
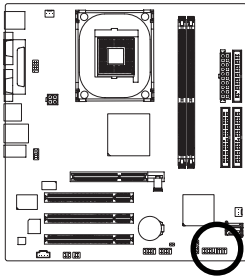

HD (IDE Hard Disk Active LED)	Pin 1: LED anode(+) Pin 2: LED cathode(-)
SPK (Speaker Connector)	Pin 1: VCC(+) Pin 2- Pin 3: NC Pin 4: Data(-)
RST (Reset Switch)	Open: Normal Operation Close: Reset Hardware System
PW (Soft Power Connector)	Open: Normal Operation Close: Power On/Off
MSG (Message LED/Power/ Sleep LED)	Pin 1: LED anode(+) Pin 2: LED cathode(-)
NC	NC

9) BAT (Battery)

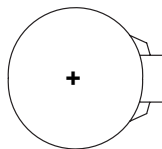
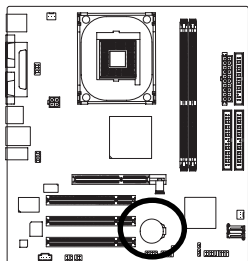

CAUTION

- ❖ Danger of explosion if battery is incorrectly replaced.
- ❖ Replace only with the same or equivalent type recommended by the manufacturer.
- ❖ Dispose of used batteries according to the manufacturer's instructions.

If you want to erase CMOS...

1. Turn off the computer and unplug the power cord.
2. Remove the battery, wait for 30 seconds.
3. Re-install the battery.
4. Plug the power cord and turn on the computer.

10) F_AUDIO (Front Audio Panel Connector)

If you want to use Front Audio connector, you must remove jumpers on pins 5-6, 9-10. In order to utilize the front audio header, your chassis must have front audio connector. Also please make sure the pin assignments on the cable are the same as the pin assignments on the MB header. To find out if the chassis you are buying support front audio connector, please contact your dealer. Please note, you can have the alternative of using front audio connector or of using rear audio connector to play sound.

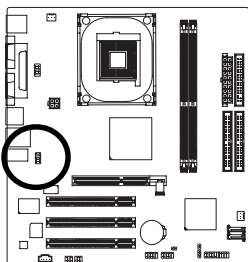

Pin No.	Definition
1	MIC
2	GND
3	MIC_BIAS
4	Power
5	Front Audio (R)
6	Rear Audio (R)/ Return R
7	NC
8	No Pin
9	Front Audio (L)
10	Rear Audio (L)/ Return L

11) CD_IN (CD In Connector)

Connect CD-ROM or DVD-ROM audio out to the connector.

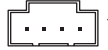
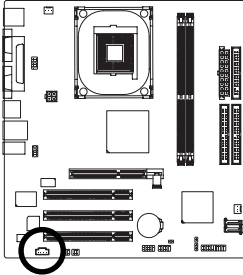

Pin No.	Definition
1	CD-L
2	GND
3	GND
4	CD-R

12) SPDIF_IO (SPDIF In/Out)

The SPDIF output is capable of providing digital audio to external speakers or compressed AC3 data to an external Dolby Digital Decoder. Use this feature only when your stereo system has digital input function. Use SPDIF IN feature only when your device has digital output function. Be careful with the polarity of the SPDIF_IO connector. Check the pin assignment carefully while you connect the SPDIF_IO cable, incorrect connection between the cable and connector will make the device unable to work or even damage it. For optional SPDIF_IO cable, please contact your local dealer.

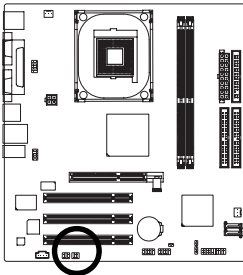

Pin No.	Definition
1	VCC
2	No Pin
3	SPDIF
4	SPDIFI
5	GND
6	GND

13) SUR_CEN

Please contact your nearest dealer for optional SUR_CEN cable.

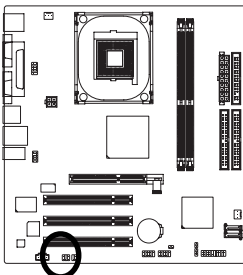

Pin No.	Definition
1	SUR OUTL
2	SUR OTR
3	GND
4	No Pin
5	CENTER_OUT
6	BASS_OUT

14) F_USB1 / F_USB2 (Front USB Connectors)

Be careful with the polarity of the F_USB connector. Check the pin assignment carefully while you connect the F_USB cable, incorrect connection between the cable and connector will make the device unable to work or even damage it. For optional F_USB cable, please contact your local dealer.

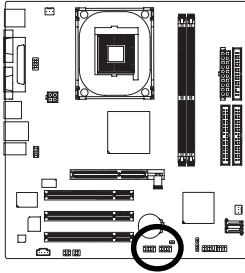

Pin No.	Definition
1	Power
2	Power
3	USB DX-
4	USB Dy-
5	USB DX+
6	USB Dy+
7	GND
8	GND
9	No Pin
10	NC

15) CI (Chassis Intrusion, Case Open)

This 2-pin connector allows your system to detect if the chassis cover is removed. You can check the "Case Open" status in BIOS Setup.

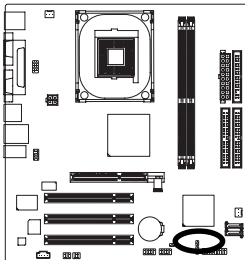

Pin No.	Definition
1	Signal
2	GND

16) COMB (COMB Connector)

Be careful with the polarity of the COMB connector. Check the pin assignment carefully while you connect the COMB cable because incorrect connection between the cable and connector will make the device unable to work or even damage it. For optional COMB cable, please contact your local dealer.

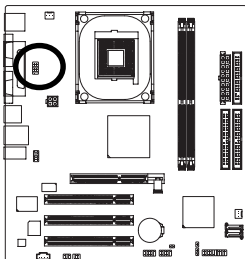

Pin No.	Definition
1	NDCDB-
2	NSINB
3	NSOUTB
4	NDTRB-
5	GND
6	NDSRB-
7	NRTSB-
8	NCTSB-
9	NRIB-
10	No Pin

17) CLR_CMOS (Clear CMOS)

You may clear the CMOS data to its default values by this jumper. To clear CMOS, temporarily short pins 1-2. Default doesn't include a jumper on pins 1-2 to prevent improper use of this header.

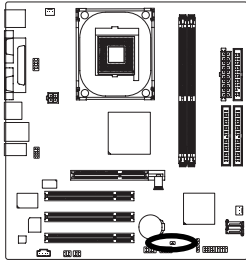

 **Open: Normal**

1

 **Short: Clear CMOS**

1

18) PWR_LED

PWR_LED is connected with the system power indicator to indicate whether the system is on/off. It will blink when the system enters suspend mode. If you use dual color LED, power LED will turn to another color.

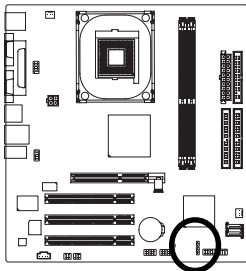

1

Pin No.	Definition
1	MPD+
2	MPD-
3	MPD-

Chapter 2 BIOS Setup

Chapter 2 provides an overview of the BIOS Setup Program, which allows users to modify the basic system configurations. This type of information is stored in battery-backed CMOS RAM so that it retains the Setup information when the power is turned off.

ENTERING BIOS Setup

Turning on the computer and pressing immediately allow you to enter BIOS Setup. If you need more advanced BIOS settings, please press **Ctrl** and **F1** keys on the BIOS main screen to access the advanced BIOS settings.

CONTROL KEYS

<↑><↓><←><→>	Move to select item
<Enter>	Select Item
<Esc>	Main Menu - Quit and not save changes into CMOS Status Page Setup Menu and Option Page Setup Menu - Exit current page and return to Main Menu
<+/PgUp>	Increase the numeric value or make changes
<-/PgDn>	Decrease the numeric value or make changes
<F1>	General help, only for Status Page Setup Menu and Option Page Setup Menu
<F2>	Item Help
<F5>	Restore the previous CMOS value from CMOS, only for Option Page Setup Menu
<F6>	Load the file-safe default CMOS value from BIOS default table
<F7>	Load the Optimized Defaults
<F8>	Q-Flash utility
<F9>	System Information
<F10>	Save all the CMOS changes, only for Main Menu

Main Menu

The on-line description of the highlighted setup function is displayed at the bottom of the screen.

Status Page Setup Menu / Option Page Setup Menu

Press F1 to pop up a small help window that describes the appropriate keys to use and the possible selections for the highlighted item. To exit the Help Window, press <Esc>.

The Main Menu (For example: BIOS Ver. : E2)

Once you enter Award BIOS CMOS Setup Utility, the Main Menu (as figure below) will appear on the screen. The Main Menu allows you to select from eight setup functions and two exit choices. Use arrow keys to select among the items and press <Enter> to accept or enter the sub-menu.

CMOS Setup Utility-Copyright (C) 1984-2004 Award Software	
<ul style="list-style-type: none"> ▶ Standard CMOS Features ▶ Advanced BIOS Features ▶ Integrated Peripherals ▶ Power Management Setup ▶ PnP/PCI Configurations ▶ PC Health Status ▶ MB Intelligent Tweaker (M.I.T.) 	<ul style="list-style-type: none"> Load Fail-Safe Defaults Load Optimized Defaults Set Supervisor Password Set User Password Save & Exit Setup Exit Without Saving
Esc: Quit	↑↓←→: Select Item
F8: Q-Flash	F10: Save & Exit Setup
Time, Date, Hard Disk Type...	



If you can't find the settings you want, press **Ctrl and F1** in BIOS main menu to access the hidden advanced options.

- **Standard CMOS Features**

This setup page includes all the items in standard compatible BIOS.

- **Advanced BIOS Features**

This setup page includes all the items of Award special enhanced features.

- **Integrated Peripherals**

This setup page includes all onboard peripherals settings.

- **Power Management Setup**

This setup page includes all the items of Green function features.

- **PnP/PCI Configuration**

This setup page includes all the configurations of PCI & PnP ISA resources.

- **PC Health Status**

This setup page includes the information of the CPU auto-detected temperature, system voltage, and CPU/system fan speed.

- **MB Intelligent Tweaker (M.I.T.)**

This setup page allows to control CPU clock and frequency ratio.

- **Load Fail-Safe Defaults**

Fail-Safe Defaults indicates the value of the system parameters with which the system would be in safe configuration.

- **Load Optimized Defaults**

Optimized Defaults indicates the value of the system parameters which the system would be in best performance configuration.

- **Set Supervisor Password**

Change, set, or disable password. It allows you to limit access to the system and Setup, or just to Setup.

- **Set User Password**

Change, set, or disable password. It allows you to limit access to the system.

- **Save & Exit Setup**

Save CMOS value settings to CMOS and exit setup.

- **Exit Without Saving**

Abandon all CMOS value changes and exit setup.

Standard CMOS Features

CMOS Setup Utility-Copyright (C) 1984-2004 Award Software
Standard CMOS Features

		Item Help
Date (mm:dd:yy)	Fri, Jan 9 2004	Menu Level ▶ Change the day, month, year
Time (hh:mm:ss)	22:31:24	<Week> Sun. to Sat.
▶ IDE Channel 0 Master	[None]	
▶ IDE Channel 0 Slave	[None]	
▶ IDE Channel 1 Master	[None]	
▶ IDE Channel 1 Slave	[None]	
Drive A	[1.44M, 3.5"]	<Month> Jan. to Dec.
Drive B	[None]	
Floppy 3 Mode Support	[Disabled]	<Day> 1 to 31 (or maximum allowed in the month)
Halt On	[All, But Keyboard]	<Year> 1999 to 2098
Base Memory	640K	
Extended Memory	127M	
Total Memory	128M	
↑↓→←: Move Enter: Select +/-/PU/PD: Value F10: Save ESC: Exit F1: General Help F5: Previous Values F6: Fail-Safe Defaults F7: Optimized Defaults		

☞ Date

The date format is <week>, <month>, <day>, <year>.

- ▶▶ Week From Sun. to Sat., determined by the BIOS and for display only.
- ▶▶ Month From Jan. to Dec.
- ▶▶ Day From 1st to 31st (or the maximum allowed in the month)
- ▶▶ Year From Year 1999 to 2098

☞ Time

The format used to express time is hours:minutes:seconds. The time is calculated based on the 24-hour military-time clock. For example, 1 p.m. is 13:00:00.

☞ IDE Channel 0 Master, Slave / IDE Channel 1 Master, Slave

- ▶▶ IDE HDD Auto-Detection Press "Enter" to select this option for automatic device detection.
 - ▶▶ IDE Channel 0/Channel 1 Master(Slave) setup You can use one of the three methods below:
 - Auto Allows BIOS to automatically detect IDE devices during POST. (Default value)
 - None Select this if no IDE devices are used and the system will skip the automatic detection step and allow for faster system start up.
 - Manual User can manually input the correct settings
 - ▶▶ Access Mode Use this to set the access mode for the hard drive. The four options are: CHS/LBA/Large/Auto (Default:Auto)
 - ▶▶ Capacity Capacity of currently installed hard disk.
- Hard drive information should be labeled on the outside drive casing.
Enter the appropriate option based on this information.
- ▶▶ Cylinder Number of cylinders
 - ▶▶ Head Number of heads
 - ▶▶ Precomp Write precomp
 - ▶▶ Landing Zone Landing zone
 - ▶▶ Sector Number of sectors

☞ Drive A / Drive B

The category identifies the types of floppy disk (drive A and drive B) installed in the computer.

- ▶▶ None No floppy disk is installed
- ▶▶ 360K, 5.25" 5.25 inch PC-type standard drive; 360K byte capacity.
- ▶▶ 1.2M, 5.25" 5.25 inch AT-type high-density drive; 1.2M byte capacity (3.5 inch when 3 Mode is Enabled).
- ▶▶ 720K, 3.5" 3.5 inch double-sided drive; 720K byte capacity
- ▶▶ 1.44M, 3.5" 3.5 inch double-sided drive; 1.44M byte capacity.
- ▶▶ 2.88M, 3.5" 3.5 inch double-sided drive; 2.88M byte capacity.

☞ Floppy 3 Mode Support (for Japan Area)

- ▶▶ Disabled Normal Floppy Drive. (Default value)
- ▶▶ Drive A Enable Drive A 3 Mode support.
- ▶▶ Drive B Enable Drive B 3 Mode support.
- ▶▶ Both Enable both Drive A and B 3 Mode support.

☞ Halt on

The category determines whether the computer will stop if an error is detected during power up.

- ▶▶ All Errors Whenever the BIOS detects a non-fatal error the system will stop.
- ▶▶ No Errors The system boot will not stop for any error that may be detected and you will be prompted.
- ▶▶ All, But Keyboard The system boot will not stop for a keyboard error; it will stop for all other errors. (Default value)
- ▶▶ All, But Diskette The system boot will not stop for a disk error; it will stop for all other errors.
- ▶▶ All, But Disk/Key The system boot will not stop for a keyboard or disk error; it will stop for all other errors.

☞ Memory

The category is display-only which is determined by POST (Power On Self Test) of the BIOS.

▶▶ Base Memory

The POST of the BIOS will determine the amount of base (or conventional) memory installed in the system.

The value of the base memory is typically 512K for systems with 512K memory installed on the motherboard, or 640K for systems with 640K or more memory installed on the motherboard.

▶▶ Extended Memory

The BIOS determines how much extended memory is present during the POST.

This is the amount of memory located above 1 MB in the CPU's memory address map.

▶▶ Total Memory

This item displays the memory size that used.

Advanced BIOS Features

CMOS Setup Utility-Copyright (C) 1984-2004 Award Software
Advanced BIOS Features

▶ Hard Disk Boot Priority [Press Enter] First Boot Device [Floppy] Second Boot Device [Hard Disk] Third Boot Device [CDROM] Boot Up Floppy Seek [Disabled] Password Check [Setup] CPU Hyper-Threading ^{*** 1} [Enabled] Limit CPUID Max. to 3 ^{*** 2} [Enabled] Init Display First [AGP]	Item Help Menu Level ▶ Select Hard Disk Boot Device Priority
↑↓←→: Move Enter: Select +/-/PU/PD: Value F10: Save ESC: Exit F1: General Help F5: Previous Values F6: Fail-Safe Defaults F7: Optimized Defaults	

Note 1: This option appears only when the Intel Pentium® 4 processor you install on the system supports the Hyper-Threading Technology.

Note 2: This option is available only when you install an Intel® Prescott processor

☞ Hard Disk Boot Priority

Select boot sequence for onboard (or add-on cards) SCSI, RAID, etc.

Use <> or <+> to select a device, then press<+> to move it up, or <-> to move it down the list.

Press <ESC> to exit this menu.

☞ First / Second / Third Boot Device

- ▶ Floppy Select your boot device priority by Floppy.
- ▶ LS120 Select your boot device priority by LS120.
- ▶ Hard Disk Select your boot device priority by Hard disk.
- ▶ CDROM Select your boot device priority by CDROM.
- ▶ ZIP Select your boot device priority by ZIP.
- ▶ USB-FDD Select your boot device priority by USB-FDD.
- ▶ USB-ZIP Select your boot device priority by USB-ZIP.
- ▶ USB-CDROM Select your boot device priority by USB-CDROM.
- ▶ USB-HDD Select your boot device priority by USB-HDD.
- ▶ LAN Select your boot device priority by LAN.
- ▶ Disabled Select your boot device priority by Disabled.

☞ Boot Up Floppy Seek

During POST, BIOS will determine the floppy disk drive installed is 40 or 80 tracks. 360K type is 40 tracks 720K, 1.2M and 1.44M are all 80 tracks.

- ▶ Disabled BIOS will not search for the type of floppy disk drive by track number. Note that there will not be any warning message if the drive installed is 360K. (Default value)
- ▶ Enabled BIOS searches for floppy disk drive to determine if it is 40 or 80 tracks. Note that BIOS can not tell from 720K, 1.2M or 1.44M drive type as they are all 80 tracks.

☞ Password Check

- ▶▶ Setup The system will boot but will not access to Setup page if the correct password is not entered at the prompt. (Default value)
- ▶▶ System The system will not boot and will not access to Setup page if the correct password is not entered at the prompt.

☞ CPU Hyper-Threading

This option is available only when you install an Intel® processor supporting Hyper-Threading Technology.

- ▶▶ Disabled Disable CPU Hyper Threading.
- ▶▶ Enabled Enable CPU Hyper Threading Feature. Please note that this feature is only working for operating system with multi processors mode supported. (Default value)

☞ Limit CPUID Max. to 3

This option is available only when you install an Intel® Prescott processor

- ▶▶ Enabled Limit CPUID Maximum value to 3 when using older OS like NT4. (Defaults value)
- ▶▶ Disabled Disable CPUID Limit for Windows XP.

☞ Init Display First

Select the first initiation of the monitor display from AGP or PCI VGA card.

- ▶▶ PCI Set Init Display First to PCI.
- ▶▶ AGP Set Init Display First to AGP. (Default value)

Integrated Peripherals

CMOS Setup Utility-Copyright (C) 1984-2004 Award Software
Integrated Peripherals

		Item Help
IDE1 Conductor Cable	[Auto]	
IDE2 Conductor Cable	[Auto]	
On-Chip Primary PCI IDE	[Enabled]	Menu Level ▶
On-Chip Secondary PCI IDE	[Enabled]	[Auto]
AC97 Audio	[Enabled]	Auto-detect IDE cable type
Onboard LAN device	[Enabled]	
USB Controller	[Enabled]	[ATA66/100/133]
USB Legacy Support	[Disabled]	Set Conductor cable to
Sis Serial ATA Controller	[Enabled]	ATA66/100/133
Sis Serial ATA Mode	[RAID]	(80 pins)
Onboard Serial Port 1	[3F8/IRQ4]	[ATA33]
Onboard Serial Port 2	[2F8/IRQ3]	Set Conductor cable to
Onboard Parallel Port	[378/IRQ7]	ATA33 (40 pins)
Parallel Port Mode	[ECP]	
ECP Mode Use DMA	[3]	

↑↓←→: Move Enter: Select +/-/PU/PD: Value F10: Save ESC: Exit F1: General Help
F5: Previous Values F6: Fail-Safe Defaults F7: Optimized Defaults

☞ IDE1 Conductor Cable

- ▶▶ Auto BIOS autodetects IDE1 conductor cable .(Default Value)
- ▶▶ ATA66/100/133 Set IDE1 Conductor Cable to ATA66/100/133 (please make sure your IDE device and cable is compatible with ATA66/100/133).
- ▶▶ ATA33 Set IDE1 Conductor Cable to ATA33 (please make sure your IDE device and cable is compatible with ATA33).

☞ IDE2 Conductor Cable

- ▶▶ Auto BIOS autodetects IDE2 conductor cable. (Default Value)
- ▶▶ ATA66/100/133 Set IDE2 Conductor Cable to ATA66/100/133 (please make sure your IDE device and cable is compatible with ATA66/100/133).
- ▶▶ ATA33 Set IDE2 Conductor Cable to ATA33 (please make sure your IDE device and cable is compatible with ATA33).

☞ On-Chip Primary PCI IDE

- ▶▶ Enabled Enable onboard 1st channel IDE port. (Default value)
- ▶▶ Disabled Disable onboard 1st channel IDE port.

☞ On-Chip Secondary PCI IDE

- ▶▶ Enabled Enable onboard 2nd channel IDE port. (Default value)
- ▶▶ Disabled Disable onboard 2nd channel IDE port.

☞ AC97 Audio

- ▶▶ Enabled Enable onboard AC'97 audio function. (Default value)
- ▶▶ Disabled Disable this function.

☞ Onboard LAN device

- ▶▶ Enabled Enable Onboard LAN function. (Default value)
- ▶▶ Disabled Disable this function.

☞ USB Controller

- ▶▶ Enabled Enable USB Controller. (Default value)
- ▶▶ Disabled Disable USB Controller.

☞ USB Legacy Support

- ▶▶ Enabled Enable USB Legacy Support.
- ▶▶ Disabled Disable USB Legacy Support. (Default value)

☞ SiS Serial ATA Controller

- ▶▶ Enabled Enable SiS Serial ATA Controller.(Default value)
- ▶▶ Disabled Disable SiS Serial ATA Controller.

☞ SiS Serial ATA Mode

- ▶▶ IDE Set SiS Serial ATA Mode to IDE.
- ▶▶ RAID Set SiS Serial ATA Mode to RAID. (Default value)

☞ Onboard Serial Port 1

- ▶▶ Disabled Disable onboard Serial port 1.
- ▶▶ 3F8/IRQ4 Enable onboard Serial port 1 and address is 3F8/IRQ4. (Default value)
- ▶▶ 2F8/IRQ3 Enable onboard Serial port 1 and address is 2F8/IRQ3.
- ▶▶ 3E8/IRQ4 Enable onboard Serial port 1 and address is 3E8/IRQ4.
- ▶▶ 2E8/IRQ3 Enable onboard Serial port 1 and address is 2E8/IRQ3.
- ▶▶ Auto BIOS will automatically setup the port 1 address.

☞ Onboard Serial Port 2

- ▶▶ Disabled Disable onboard Serial port 2
- ▶▶ 3F8/IRQ4 Enable onboard Serial port 2 and address is 3F8/IRQ4.
- ▶▶ 2F8/IRQ3 Enable onboard Serial port 2 and address is 2F8/IRQ3. (Default value)
- ▶▶ 3E8/IRQ4 Enable onboard Serial port 2 and address is 3E8/IRQ4.
- ▶▶ 2E8/IRQ3 Enable onboard Serial port 2 and address is 2E8/IRQ3.
- ▶▶ Auto BIOS will automatically setup the port 2 address. .

☞ Onboard Parallel port

- ▶▶ Disabled Disable onboard LPT port.
- ▶▶ 378/IRQ7 Enable onboard LPT port and address is 378/IRQ7. (Default Value)
- ▶▶ 278/IRQ5 Enable onboard LPT port and address is 278/IRQ5.
- ▶▶ 3BC/IRQ7 Enable onboard LPT port and address is 3BC/IRQ7.

☞ **Parallel Port Mode**

This option is available when **Onboard Parallel port** is not set to **Disabled**.

- ▶▶ SPP Use Parallel port as Standard Parallel Port.
- ▶▶ EPP Use Parallel port as Enhanced Parallel Port.
- ▶▶ ECP Use Parallel port as Extended Capabilities Port. (Default Value)
- ▶▶ ECP+EPP Use Parallel port as ECP & EPP mode.

☞ **ECP Mode Use DMA**

This feature allows you to select Direct Memory Access(DMA) channel if the ECP mode selected.

- ▶▶ 1 Set ECP Mode Use DMA to 1.
- ▶▶ 3 Set ECP Mode Use DMA to 3. (Default value)

Power Management Setup

CMOS Setup Utility-Copyright (C) 1984-2004 Award Software
Power Management Setup

ACPI Suspend Type	[S1 (POS)]	Item Help
Soft-Off by PWR_BTN	[Off]	Menu Level ▶
System After AC Back	[Off]	[S1]
IRQ [3-7, 9-15], NMI	[Enabled]	Set suspend type to
ModemRingOn	[Enabled]	Power On Suspend under
PME Event Wake Up	[Enabled]	ACPI OS
Power On by Keyboard	[Disabled]	
Power On by Mouse	[Disabled]	[S3]
Resume by Alarm	[Disabled]	Set suspend type to
x Month Alarm	NA	Suspend to RAM under
x Day (of Month)	Everyday	ACPI OS
x Time (hh:mm:ss)	0 : 0 : 0	
Power LED in S1 state	[Blinking]	
↑↓→←: Move Enter: Select +/-/PU/PD: Value F10: Save ESC: Exit F1: General Help F5: Previous Values F6: Fail-Safe Defaults F7: Optimized Defaults		

☞ **ACPI Suspend Type**

- ▶▶ S1(POS) Set ACPI suspend type to S1. (Default Value)
- ▶▶ S3(STR) Set ACPI suspend type to S3.

☞ **Soft-off by PWR_BTN**

- ▶▶ Off Once a user presses the power button, the system will be turned off. (Default Value)
- ▶▶ Suspend Once a user presses the power button, the system will enter suspend mode.

☞ System After AC Back

- ▶▶ Off When AC-power back to the system, the system will be in "Off" state. (Default Value)
- ▶▶ On When AC-power back to the system, the system will be in "On" state.
- ▶▶ Laststate When AC-power back to the system, the system will return to the Last state before AC-power off.

☞ IRQ [3-7, 9-15], NMI

When IRQ [3-7, 9-15] or NMI triggered, the suspend timer will be reloaded to prevent system from getting into green mode.

- ▶▶ Disabled Disable this function.
- ▶▶ Enabled Enable this function. (Default value)

☞ ModemRingOn

- ▶▶ Disabled Disable Modem Ring on function.
- ▶▶ Enabled Enable Modem Ring on function. (Default Value)

☞ PME Event Wake Up

- ▶▶ Disabled Disable this function.
- ▶▶ Enabled Enable PME Event Wake up. (Default Value)

☞ Power On by Keyboard

- ▶▶ Any Key Set Keyboard power on by any key.
- ▶▶ Password Input password (from 1 to 8 numbers) and press Enter to set the Keyboard Power On Password.
- ▶▶ Disabled Disable this function. (Default Value)

☞ Power On by Mouse

- ▶▶ Enabled Enable Power On by Mouse function.
- ▶▶ Disabled Disable this function. (Default Value)

☞ Resume by Alarm

You can enable **Resume by Alarm** and key in month/date/time to turn on system.

- ▶▶ Disabled Disable this function. (Default Value)
- ▶▶ Enabled Enable alarm function to POWER ON system.
If Resume by Alarm is Enabled.
Month Alarm : NA, 1~12
Day (of Month) : 0~31
Time (hh: mm: ss) : (0~23) : (0~59) : (0~59)

☞ Power LED in S1 state

- ▶▶ Blinking The Power LED will be blinking during S1 state. (Default value)
- ▶▶ Dual/OFF The Power LED will be turned off or change color.

PnP/PCI Configurations

CMOS Setup Utility-Copyright (C) 1984-2004 Award Software
PnP/PCI Configurations

PCI 1 IRQ Assignment	[Auto]	Item Help
PCI 2 IRQ Assignment	[Auto]	Menu Level ▶
PCI 3 IRQ Assignment	[Auto]	Device(s) using this INT:
		RAID Cntrlr -Bus 0 Dev 5 Func 0
<p>↑↓→←: Move Enter: Select +/-/PU/PD: Value F10: Save ESC: Exit F1: General Help F5: Previous Values F6: Fail-Safe Defaults F7: Optimized Defaults</p>		

☞ PCI 1 IRQ Assignment

- ▶▶ Auto Auto assign IRQ to PCI 1. (Default value)
- ▶▶ 3,4,5,7,9,10,11,12,14,15 Set IRQ 3,4,5,7,9,10,11,12,14,15 to PCI 1.

☞ PCI 2 IRQ Assignment

- ▶▶ Auto Auto assign IRQ to PCI 2. (Default value)
- ▶▶ 3,4,5,7,9,10,11,12,14,15 Set IRQ 3,4,5,7,9,10,11,12,14,15 to PCI 2.

☞ PCI 3 IRQ Assignment

- ▶▶ Auto Auto assign IRQ to PCI 3. (Default value)
- ▶▶ 3,4,5,7,9,10,11,12,14,15 Set IRQ 3,4,5,7,9,10,11,12,14,15 to PCI 3.

PC Health Status

CMOS Setup Utility-Copyright (C) 1984-2004 Award Software
PC Health Status

Reset Case Open Status	[Disabled]	Item Help
Case Opened	No	Menu Level ▶
Vcore	OK	[Disabled]
DDR 2.5V	OK	Don't reset case open status
+3.3V	OK	open status
+12V	OK	[Enabled]
Current CPU Temperature	27°C	Clear case open status and set to be Disabled at next boot
Current CPU FAN Speed	4821 RPM	
Current SYSTEM FAN Speed	0 RPM	
↑↓→←: Move Enter: Select +/-/PU/PD: Value F10: Save ESC: Exit F1: General Help F5: Previous Values F6: Fail-Safe Defaults F7: Optimized Defaults		

Reset Case Open Status

- ▶▶ Disabled Don't reset case open status. (Default value)
- ▶▶ Enabled Clear case open status at next boot.

Case Opened

If the case is closed, **Case Opened** will show "No."

If the case is opened, **Case Opened** will show "Yes."

If you want to reset **Case Opened** value, enable **Reset Case Open Status** and save the change to CMOS, and then your computer will restart.

Current Voltage (V) VCORE / +3.3V / DDR 2.5V / +12V

- ▶▶ Detect system's voltage status automatically.

Current CPU Temperature

- ▶▶ Detect CPU Temp. automatically.

Current CPU/SYSTEM FAN Speed (RPM)

- ▶▶ Detect CPU/SYSTEM Fan speed status automatically.

MB Intelligent Tweaker (M.I.T.)

CMOS Setup Utility-Copyright (C) 1984-2004 Award Software
MB Intelligent Tweaker (M.I.T.)

		Item Help
Configure DRAM Timing	[Auto]	
x Cas Latency Setting	3T	
x DRAM RAS Active Time	9T	
x DRAM RAS Precharge Time	3T	
x DRAM RAS to CAS Delay	3T	
CPU Clock Ratio	[15X]	
Linear Frequency Control	[Disabled]	
x CPU Clock (MHz)	133	
x DRAM Clock (MHz)	266	
AGP/PCI Clock Control	[AUTO]	
x AGP Clock (MHz)	66	
x PCI Clock (MHz)	33	
		Menu Level ▶
		[AUTO] Configure DRAM Timing automatically
		[Manual] Configure DRAM Timing by manual
		Warning: Wrong DRAM Timing may make system can't boot. Clear CMOS to overcome wrong Timing issue
↑↓←→: Move Enter: Select +/-/PU/PD: Value F10: Save ESC: Exit F1: General Help F5: Previous Values F6: Fail-Safe Defaults F7: Optimized Defaults		

Incorrectly using these features may cause your system corrupted. For power users only!

☞ Configure DRAM Timing

- ▶▶ Auto BIOS will automatically setup the DRAM Timing by DRAM SPD data. (Default value)
- ▶▶ Manual This item allows user to set DRAM Timing manually.

☞ CAS Latency Setting

- ▶▶ 2T/2.5T/3T Set CAS Latency to 2T/2.5T/3T. (Default value is 3T)
- ▶▶ Auto BIOS will automatically detect CAS Latency.

☞ DRAM RAS Active Time

- ▶▶ 4T/5T/6T/7T/8T/9T Set DRAM RAS Active Time to 4T/5T/6T/7T/8T/9T. (Default value:9T)

☞ DRAM RAS Precharge Time

- ▶▶ 3T/2T/4T/5T Set DRAM RAS Precharge time to 2T/3T/4T/5T. (Default value:3T)

☞ DRAM RAS to CAS Delay

- ▶▶ 3T/2T/4T/5T Set DRAM RAS to CAS Delay to 3T/2T/4T/5T. (Default value:3T)

☞ CPU Clock Ratio

This setup option will automatically assign by CPU detection.
The option will display "Locked" and read only if the CPU ratio is not changeable.

☞ Linear Frequency Control

- ▶▶ Disabled Disable this function. (Default value)
- ▶▶ Enabled Enable this function.

☞ CPU Clock (MHz)

This option is available only when **Linear Frequency Control** is enabled.

▶▶ 100~355 Select CPU Clock to 100MHz~355MHz.

If you use a FSB400 Pentium 4 processor, please set "CPU Clock" to 100MHz.

If you use a FSB533 Pentium 4 processor, please set "CPU Clock" to 133MHz. If you use a FSB800 Pentium 4 processor, please set "CPU Clock" to 200MHz.

Incorrectly using it may cause your system corrupted. For power End-User use only!

☞ DRAM Clock (MHz)

This option is available only when **Linear Frequency Control** is enabled.

▶▶ Please set DRAM Clock according to your requirement.

If you use DDR266 DRAM module, please set "DRAM Clock(MHz)" to 266. If you use DDR333 DRAM module, please set "DRAM Clock(MHz)" to 333.

Incorrectly using it may cause your system corrupted. For power End-User use only!

☞ AGP/PCI Clock Control

▶▶ AUTO Set AGP/PCI clock automatically. (Default Value)

▶▶ Manual Set AGP/PCI clock manually.

⚠ Incorrectly using it may cause your system corrupted. For power users only!

☞ AGP Clock (MHz)

This option is available when **AGP/PCI Clock Control** is set to **Manual**.

▶▶ Please set AGP Clock according to your requirement.

Incorrectly using it may cause your system corrupted. For power users only!

☞ PCI Clock (MHz)

When you select to set the AGP Clock (MHz) manually, the PCI Clock (MHz) will change automatically depending on the AGP Clock (MHz) you set.

Load Fail-Safe Defaults

CMOS Setup Utility-Copyright (C) 1984-2004 Award Software

▶ Standard CMOS Features	Load Fail-Safe Defaults
▶ Advanced BIOS Features	Load Optimized Defaults
▶ Integrated Peripherals	Set Supervisor Password
▶ Power Man	Load Fail-Safe Defaults (Y/N)? N
▶ PnP/PCI C	Exit Without Saving
▶ PC Health Status	
▶ MB Intelligent Tweaker (M.I.T.)	
Esc: Quit	↑↓→←: Select Item
F8: Q-Flash	F10: Save & Exit Setup
Load Fail-Safe Defaults	

Fail-Safe defaults contain the most appropriate values of the system parameters that allow minimum system performance.

Load Optimized Defaults

CMOS Setup Utility-Copyright (C) 1984-2004 Award Software

▶ Standard CMOS Features	Load Fail-Safe Defaults
▶ Advanced BIOS Features	Load Optimized Defaults
▶ Integrated Peripherals	Set Supervisor Password
▶ Power Man	Load Optimized Defaults (Y/N)? N
▶ PnP/PCI C	Exit Without Saving
▶ PC Health Status	
▶ MB Intelligent Tweaker (M.I.T.)	
Esc: Quit	↑↓→←: Select Item
F8: Q-Flash	F10: Save & Exit Setup
Load Optimized Defaults	

Selecting this field loads the factory defaults for BIOS and Chipset Features which the system automatically detects.

Set Supervisor/User Password

CMOS Setup Utility-Copyright (C) 1984-2004 Award Software

▶ Standard CMOS Features	Load Fail-Safe Defaults
▶ Advanced BIOS Features	Load Optimized Defaults
▶ Integrated Peripherals	Set Supervisor Password
▶ Power Management Setup	Set User Password
▶ PnP/PCI	Enter Password:
▶ PC Heal	
▶ MB Intelligent Tweaker (M.I.T.)	
Esc: Quit	↑↓→←: Select Item
F8: Q-Flash	F10: Save & Exit Setup
Change/Set/Disable Password	

When you select this function, the following message will appear at the center of the screen to assist you in creating a password.

Type the password, up to eight characters, and press <Enter>. You will be asked to confirm the password. Type the password again and press <Enter>. You may also press <Esc> to abort the selection and not enter a password. To disable password, just press <Enter> when you are prompted to enter password. A message "PASSWORD DISABLED" will appear to confirm the password being disabled. Once the password is disabled, the system will boot and you can enter Setup freely.

The BIOS Setup program allows you to specify two separate passwords:

SUPERVISOR PASSWORD and **USER PASSWORD**. When disabled, anyone may access all BIOS Setup program function. When enabled, the Supervisor password is required for entering the BIOS Setup program and having full configuration fields, the User password is required to access only basic items.

If you select "System" at "Password Check" in Advance BIOS Features Menu, you will be prompted for the password every time the system is rebooted or any time you try to enter Setup Menu.

If you select "Setup" at "Password Check" in Advance BIOS Features Menu, you will be prompted only when you try to enter Setup.

Save & Exit Setup

CMOS Setup Utility-Copyright (C) 1984-2004 Award Software

▶ Standard CMOS Features	Load Fail-Safe Defaults
▶ Advanced BIOS Features	Load Optimized Defaults
▶ Integrated Peripherals	Save to CMOS and EXIT (Y/N)? Y
▶ Power Management Setup	Set User Password
▶ PnP/PCI Configurations	Save & Exit Setup
▶ PC Health Status	Exit Without Saving
▶ MB Intelligent Tweaker (M.I.T.)	
Esc: Quit	↑↓←→: Select Item
F8: Q-Flash	F10: Save & Exit Setup
Save Data to CMOS	

Type "Y" will quit the Setup Utility and save the user setup value to RTC CMOS.

Type "N" will return to Setup Utility.

Exit Without Saving

CMOS Setup Utility-Copyright (C) 1984-2004 Award Software

▶ Standard CMOS Features	Load Fail-Safe Defaults
▶ Advanced BIOS Features	Load Optimized Defaults
▶ Integrated Peripherals	Quit Without Saving (Y/N)? N
▶ Power Management Setup	Set User Password
▶ PnP/PCI Configurations	Save & Exit Setup
▶ PC Health Status	Exit Without Saving
▶ MB Intelligent Tweaker (M.I.T.)	
Esc: Quit	↑↓←→: Select Item
F8: Q-Flash	F10: Save & Exit Setup
Abandon all Data	

Type "Y" will quit the Setup Utility without saving to RTC CMOS.

Type "N" will return to Setup Utility.

Chapter 3 Install Drivers

Install Drivers



NOTE

Pictures below are shown in Windows XP

Insert the driver CD-title that came with your motherboard into your CD-ROM drive, the driver CD-title will auto start and show the installation guide. If not, please double click the CD-ROM device icon in "My computer", and execute the setup.exe.

INSTALL CHIPSET DRIVER

This page shows the drivers that need to be installed for the system. Click each item to install the driver manually or switch to the  to install the drivers automatically.

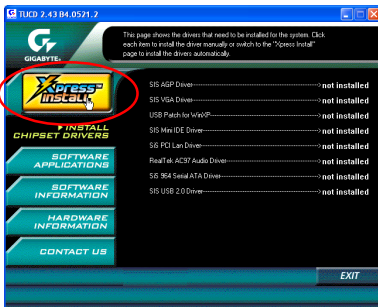

Message: Some device drivers will restart your system automatically. After restarting your system the "Xpress Install" will continue to install other drivers.

The "Xpress Install" uses the "Click and Go" technology to install the drivers automatically. Just select the drivers you want then click the "GO" button. The  will execute the installation for you by itself.

We recommend that you install all components in the list.

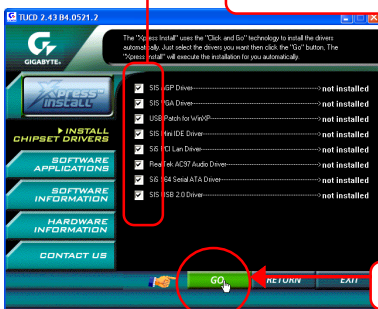

Click "GO".

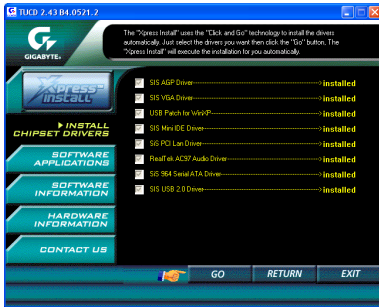

You have completed drivers installation.

Item Description

- **SIS AGP Driver**
AGP interface driver for SiS series chipset.
- **SiS VGA Driver**
VGA driver for VGA integrated SiS 661FX chipset.
- **USB Patch for WinXP**
This patch driver can help you to resolve the USB device wake up S3 hang up issue in XP.
- **SiS Mini IDE Driver**
SiS IDE driver .
- **SiS PCI Lan Driver**
SiS Series Lan driver.
- **RealTek AC97 Audio Driver**
Audio driver for RealTek AC97 codec chipset.
- **SiS 964 Serial ATA Driver**
Serial ATA driver for SiS 964 chip.
- **SiS USB 2.0 Driver**
USB 2.0 driver for SiS series chipset.



If your CD doesn't have SiS® USB 2.0 driver, please download the USB 2.0 driver from Microsoft® website (www.microsoft.com) for USB 2.0 devices support. Please also note that Microsoft® USB2.0 driver is currently supported by Windows XP and Windows 2000 only.

Once we get the latest SiS® USB 2.0 driver for Windows 98 and Windows ME, we will put the driver on GIGABYTE website asap. (<http://www.gigabyte.com.tw>).



For USB 2.0 driver support under Windows XP operating system, please use Windows Service Pack. After install Windows Service Pack, it will show a question mark "?" in "Universal Serial Bus controller" under "Device Manager". Please remove the question mark and restart the system (System will auto-detect the right USB 2.0 driver).



Contact Us

• Taiwan (Headquarters)

GIGA-BYTE TECHNOLOGY CO., LTD.
Address: No.6, Bau Chiang Road, Hsin-Tien, Taipei Hsien, Taiwan
TEL: +886 (2) 8912-4888
FAX: +886 (2) 8912-4003
Tech. Support :
<http://tw.giga-byte.com/TechSupport/ServiceCenter.htm>
Non-Tech. Support (Sales/Marketing) :
<http://ggts.gigabyte.com.tw/nontech.asp>
WEB address (English) : <http://www.gigabyte.com.tw>
WEB address (Chinese) : <http://chinese.giga-byte.com>

• U.S.A.

G.B.T. INC.
Address: 17358 Railroad St, City of Industry, CA 91748.
TEL: +1 (626) 854-9338
FAX: +1 (626) 854-9339
Tech. Support :
<http://www.giga-byte.com/TechSupport/ServiceCenter.htm>
Non-Tech. Support (Sales/Marketing) :
<http://ggts.gigabyte.com.tw/nontech.asp>
WEB address : <http://www.giga-byte.com>

• Germany

G.B.T. TECHNOLOGY TRADING GMBH
Address: Friedrich-Ebert-Damm 112 22047 Hamburg
TEL: +49-40-2533040 (Sales)
+49-1803-428468 (Tech.)
FAX: +49-40-25492343 (Sales)
+49-1803-428329 (Tech.)
Tech. Support :
<http://de.giga-byte.com/TechSupport/ServiceCenter.htm>
Non-Tech. Support (Sales/Marketing) :
<http://ggts.gigabyte.com.tw/nontech.asp>
WEB address : <http://www.gigabyte.de>

• Japan

NIPPON GIGA-BYTE CORPORATION
WEB address : <http://www.gigabyte.co.jp>

• Singapore

GIGA-BYTE SINGAPORE PTE. LTD.
Tech. Support :
<http://tw.giga-byte.com/TechSupport/ServiceCenter.htm>
Non-Tech. Support (Sales/Marketing) :
<http://ggts.gigabyte.com.tw/nontech.asp>

• U.K.

G.B.T. TECH. CO., LTD.
Address: GUnit 13 Avant Business Centre 3 Third Avenue, Denbigh West Bletchley Milton Keynes, MK1 1DR, UK, England
TEL: +44-1908-362700
FAX: +44-1908-362709
Tech. Support :
<http://uk.giga-byte.com/TechSupport/ServiceCenter.htm>
Non-Tech. Support (Sales/Marketing) :
<http://ggts.gigabyte.com.tw/nontech.asp>
WEB address : <http://uk.giga-byte.com>

• The Netherlands

GIGA-BYTE TECHNOLOGY B.V.
TEL: +31 40 290 2088
NL Tech.Support: 0900-GIGABYTE (0900-44422983)
BE Tech.Support: 0900-84034
FAX: +31 40 290 2089
Tech. Support :
<http://nz.giga-byte.com/TechSupport/ServiceCenter.htm>
Non-Tech. Support (Sales/Marketing) :
<http://ggts.gigabyte.com.tw/nontech.asp>
WEB address : <http://www.giga-byte.nl>

- **China**

NINGBO G.B.T. TECH. TRADING CO., LTD.

Tech. Support :

<http://cn.giga-byte.com/TechSupport/ServiceCenter.htm>

Non-Tech. Support (Sales/Marketing) :

<http://ggts.gigabyte.com.tw/nontech.asp>

WEB address : <http://www.gigabyte.com.cn>

- **Shanghai**

TEL: +86-021-63410999

FAX: +86-021-63410100

- **Beijing**

TEL: +86-010-82886651

FAX: +86-010-82888013

- **Wuhan**

TEL: +86-027-87851061

FAX: +86-027-87851330

- **GuangZhou**

TEL: +86-020-87586074

FAX: +86-020-85517843

- **Chengdu**

TEL: +86-028-85236930

FAX: +86-028-85256822

- **Xian**

TEL: +86-029-85531943

FAX: +86-029-85539821

- **Shenyang**

TEL: +86-024-23960918

FAX: +86-024-23960918-809

- **Australia**

GIGABYTE TECHNOLOGY PTY. LTD.

Tech. Support :

<http://www.giga-byte.com.au/TechSupport/ServiceCenter.htm>

Non-Tech. Support (Sales/Marketing) :

<http://ggts.gigabyte.com.tw/nontech.asp>

WEB address : <http://www.giga-byte.com.au>

- **France**

GIGABYTE TECHNOLOGY FRANCES S.A.R.L.

Tech. Support :

<http://tw.giga-byte.com/TechSupport/ServiceCenter.htm>

Non-Tech. Support (Sales/Marketing) :

<http://ggts.gigabyte.com.tw/nontech.asp>

WEB address : <http://www.gigabyte.fr>

- **Russia**

Moscow Representative Office Of Giga-Byte Technology Co., Ltd.

Tech. Support :

<http://tw.giga-byte.com/TechSupport/ServiceCenter.htm>

Non-Tech. Support (Sales/Marketing) :

<http://ggts.gigabyte.com.tw/nontech.asp>

WEB address : <http://www.gigabyte.ru>

- **Poland**

Representative Office Of Giga-Byte Technology Co., Ltd.

POLAND

Tech. Support :

<http://tw.giga-byte.com/TechSupport/ServiceCenter.htm>

Non-Tech. Support (Sales/Marketing) :

<http://ggts.gigabyte.com.tw/nontech.asp>

WEB address : <http://www.gigabyte.pl>

Free Manuals Download Website

<http://myh66.com>

<http://usermanuals.us>

<http://www.somanuals.com>

<http://www.4manuals.cc>

<http://www.manual-lib.com>

<http://www.404manual.com>

<http://www.luxmanual.com>

<http://aubethermostatmanual.com>

Golf course search by state

<http://golfingnear.com>

Email search by domain

<http://emailbydomain.com>

Auto manuals search

<http://auto.somanuals.com>

TV manuals search

<http://tv.somanuals.com>