

# **IB865**

LGA775 Pentium 4  
Intel 865G Chipset  
Full Size CPU Card

## **USER'S MANUAL**

Version 1.0

---

## Acknowledgments

Award is a registered trademark of Award Software International, Inc.

PS/2 is a trademark of International Business Machines Corporation.

Intel and Pentium 4 are registered trademarks of Intel Corporation.

Microsoft Windows is a registered trademark of Microsoft Corporation.

Winbond is a registered trademark of Winbond Electronics Corporation.

All other product names or trademarks are properties of their respective owners.

---

# Table of Contents

<b>Introduction.....</b>	<b>1</b>
Checklist .....	1
Product Description .....	2
Specifications .....	3
Board Dimensions.....	4
<b>Installations.....</b>	<b>5</b>
Installing the CPU .....	6
ATX Power Installation .....	7
Installing the Memory .....	7
Setting the Jumpers.....	8
Connectors on IB865 .....	17
Watchdog Timer .....	29
<b>BIOS Setup.....</b>	<b>31</b>
<b>Drivers Installation .....</b>	<b>53</b>

---

## ATTENTION:

It is strongly recommended that only heatsinks that have corresponding (metal) backplates are used on the CPU card. This is to avoid the CPU card being bent/distorted, causing the CPU card to become damaged. A reference picture of a backplate and heatsink that has backplate are shown below.

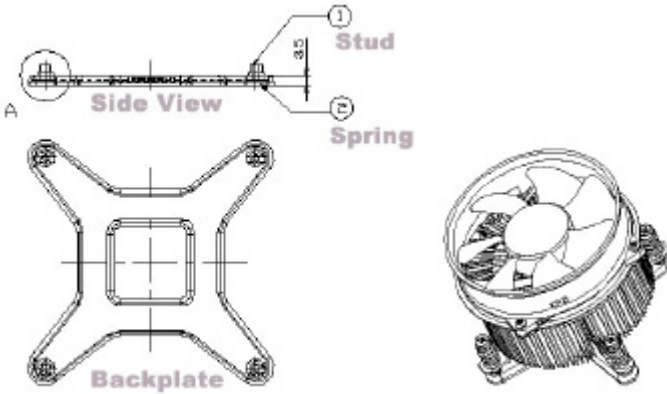

# Introduction

## Checklist

---

Your IB865 Pentium 4 CPU card package should include the items listed below:

- The IB865 CPU Card
- This User's Manual
- 1 IDE Ribbon Cable
- 1 Floppy Ribbon Connector
- SATA Power Cord
- SATA Cable
- 2 Serial Port Ribbon Cable and 1 Parallel Port Attached to a Mounting Bracket
- 1 Y-Cable supporting a PS/2 Keyboard and a PS/2 Mouse
- 1 CD containing the following:
  - Chipset Drivers
  - Flash Memory Utility
- Optional audio cable with bracket (Audio8K)
- Optional USB cable with bracket (USB2K-4)
- Optional Secondary CRT VGA cable with bracket (VGA4K, for use with IBA110)
- Optional TMDS cable with bracket (ID120P, for use with IBA110)
- Optional TV-out cable (TVOUT-6, for use with IBA120)
- Optional MicroAGP cards (IBA120, IBA110)

## Product Description

---

The IB865 Pentium 4 CPU card incorporates the Intel 865G chipset that can utilize a LGA775 processor of up to 3.8GHz or higher and supports FSB frequency of 533/800Mhz (133Mhz, and 200Mhz HCLK respectively).

The 865G chipset comes with a Graphics Memory Controller Hub (GMCH) designed for use with the Pentium 4 processor with 1MB L2 cache on 0.09 micron process. The GMCH component provides the CPU interface, DDR interface, AGP interface, Hub Interface, and integrated graphics with display interfaces.

Aside from CRT support, the VGA function feature a Micro AGP slot for optional daughter cards:

IBA120: with Chrontel CH7017 chipset that supports dual channel LVDS, TV-out interface

IBA110: with ATI M7CSP32, M9CSP64 / M10CSP64 chipset, 64MB/32MB frame buffer and supports dual channel LVDS interface, TMDS and CRT2 display function.

The board also has one Intel 82547GI Gigabit LAN and an Intel 82551 10/100MB fast Ethernet LAN.

Other advanced features include two Serial ATA ports, four USB 2.0 ports, IrDA interface and audio function.

## Specifications

<b>Product Name</b>	IB865
<b>CPU Type</b>	LGA775 socket (Intel Pentium 4 / Celeron D)
<b>CPU Voltage</b>	0.8375V~1.6V (VRD 10.1)
<b>System Speed</b>	2.53GHz~3.8GHz
<b>CPU Operating Frequency</b>	533MHz/800MHz
<b>Green /APM</b>	APM1.2
<b>CPU Socket</b>	LGA 775 Socket
<b>Chipset</b>	Intel 865G Chipset GMCH: 82865G 932-pin FC-BGA, ICH5: 82801EB 460-pin MBGA, FWH
<b>BIOS</b>	Award BIOS; support ACPI Function
<b>Cache</b>	256K/1M Level 2 (CPU integrated)
<b>MicroAGP Socket</b>	Two selection: IBA110 or IBA120 Micro AGP card
<b>VGA</b>	Two selection : 1. 82865G built-in VGA, AGP 4X, supports with CRT + IBA120: CH7017, for LVDS dual channel or TV-OUT. 2. MicroAGP card: IBA110: ATI Mobility M7/M9/M10 graphics controller, embedded 32/64MB Frame buffer (DDR), AGP 4X/8X, for CRT, LVDS, TMDS, 2nd CRT
<b>Primary LAN</b>	Intel 82551QM LAN controller (10/100Mb)
<b>Secondary LAN</b>	Intel 82547GI (10/100/1000Mb) Gigabit LAN (optional)
<b>Audio</b>	ICH5 Built-in Sound controller + AC97 Codec ALC655 support AC3 5.1 channel, 2x6 12-pin header
<b>Memory type</b>	2 x DDR 2.5V DDR333/400 SDRAM( without ECC Function) DIMM Module, Max. capacity - 2GB
<b>LPC I/O</b>	Winbond 83627HF: IrDAx1, Parallel x1, COM1 (RS-232), COM2 (RS-232/RS422/RS485), FDC 1.44MB, Hardware monitor (3 thermal inputs, 6 voltage monitor inputs, VIDO-4, 1 chassis open detection, 3 fan headers)
<b>RTC/CMOS</b>	ICH5 built-in
<b>Local bus IDE</b>	ICH5 built-in, IDE1, 2 (Ultra DMA 33/66/100)
<b>Serial ATA</b>	2 ports
<b>D-type Connectors</b>	PS/2 keyboard/mouse, VGA (CRT), RJ-45 x 2
<b>Power Connector</b>	ATX 12V
<b>PCI to ISA Bridge</b>	ITE 8888
<b>ISA High Drive</b>	Yes, SN74ABT16245
<b>USB</b>	4 x USB 2.0
<b>Watchdog Timer</b>	Yes ( 256 segments : 0, 1, 2,...255 sec/min)
<b>System Voltages</b>	+5V, +12V, -12V, 5VSB
<b>Other Features</b>	Modem Wakeup, LAN Wakeup, DiskOnChip, IrDA
<b>Form Factor</b>	PICMG (full size CPU card)
<b>Board Size</b>	122 x 338 mm

# Board Dimensions

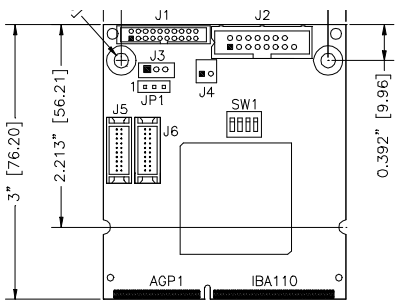
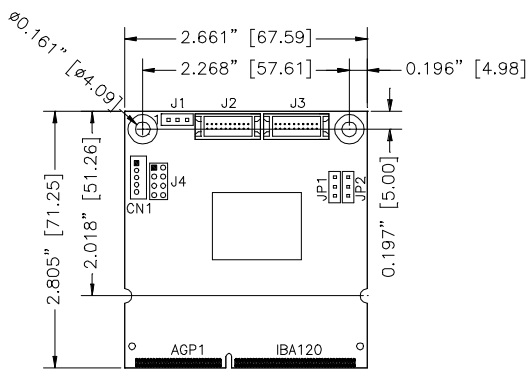
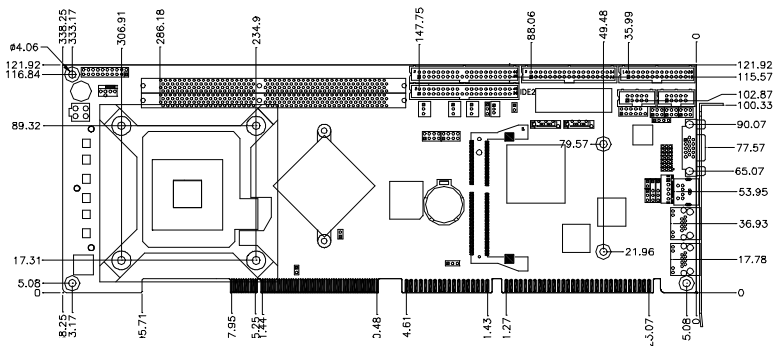



## Installations

This section provides information on how to use the jumpers and connectors on the IB865 in order to set up a workable system. The topics covered are:

Installing the CPU .....	6
ATX Power Installation .....	7
Installing the Memory .....	7
Setting the Jumpers.....	8
Connectors on IB865 .....	17

## Installing the CPU

---

---

The IB865 CPU card supports a LGA 775 processor socket for Intel® Pentium® 4 processors.

The LGA 775 processor socket comes with a lever to secure the processor. Refer to the pictures below, from left to right, on how to place the processor into the CPU socket. ***Please note that the cover of the LGA775 socket must always be installed during transport to avoid damage to the socket.***

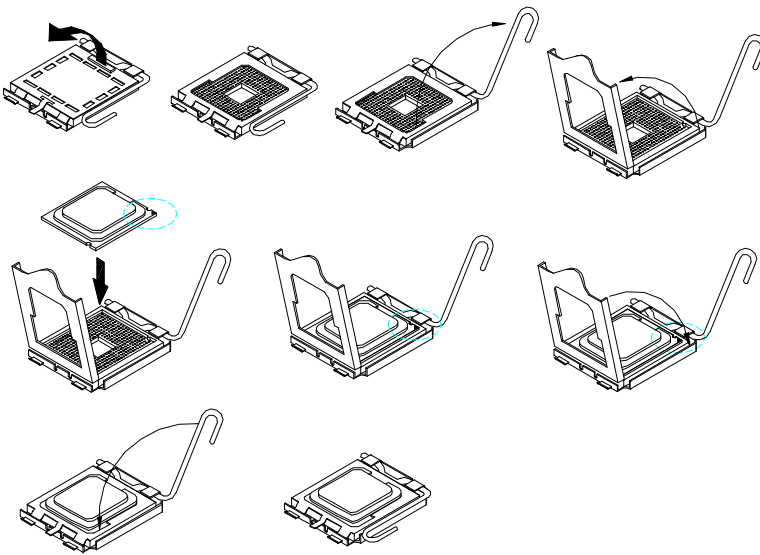

---

## ATX Power Installation

---

The system power is provided to the CPU card with the CN1 and J7 ATX power connectors. Please note that the J7 external ATX power connector should be connected to the backplane for IB865 to function. J7 is a 3-pin power connector. CN1 is a 4-pin 12V power connector. CN1 is to be connected to the ATX power supply.

---

## Installing the Memory

---

The IB865 CPU card supports two DDR memory sockets for a maximum total memory of 2GB in DDR memory type. You can install unbuffered & non-ECC DDR DIMMs. It supports DDR266/333 when installed with CPUs that have clock speeds of 533MHz. It supports DDR266/320/400 when installed with CPUs that have clock speeds of 800MHz. The board provides dual channel functionality for its DIMM slots. DIMM1 is for one channel and DIMM2 is for the other channel. Enabling dual channels can increase data access rates.

Basically, the system memory interface has the following features:

- Supports two 64-bit wide DDR data channels
- Available bandwidth up to 3.2GB/s (DDR400) for single-channel mode and 6.4GB/s (DDR400) in dual-channel mode.
- Supports non ECC DIMMs.
- Supports 128Mb, 256Mb, 512Mb DDR technologies.
- Supports only x8, x16, DDR devices with four banks
- Registered DIMMs not supported
- Supports opportunistic refresh
- Up to 16 simultaneously open pages (four per row, four rows maximum)

## Setting the Jumpers

---

Jumpers are used on IB865 to select various settings and features according to your needs and applications. Contact your supplier if you have doubts about the best configuration for your needs. The following lists the connectors on IB865 and their respective functions.

Jumper Locations on IB865.....	9
JP1: Clear CMOS Contents.....	10
JP2, JP3, JP4: RS232/422/485 (COM2) Selection .....	10
JP5/6/7/8/9/10/11: CRT VGA Signal Select .....	10
JP13: Primary LAN Enable/Disable .....	11
JP14: DiskOnChip Address Select .....	11
Jumper and Connectors on IBA120.....	12
J1: Panel Inverter Power Connector .....	12
JP2: Panel Voltage Setting.....	12
J4: TV out Connector.....	12
JP1: TV Type Select.....	13
JP2: LVDS Panel Power Select .....	13
J2, J3: LVDS Connectors (2nd channel, 1st channel).....	13
Jumper and Connectors on IBA110.....	14
J1: TMDS Panel Connector.....	14
J2: CRT2 / TV-Out Connector .....	14
J3: Panel Inverter Power Connector .....	15
J4: VGA Chipset Fan Power Connector .....	15
J5, J6: LVDS Connectors (2nd channel, 1st channel).....	15
JP1: LVDS Panel Power Select .....	15
SW1: LVDS Resolution Select .....	16

## Jumper Locations on IB865

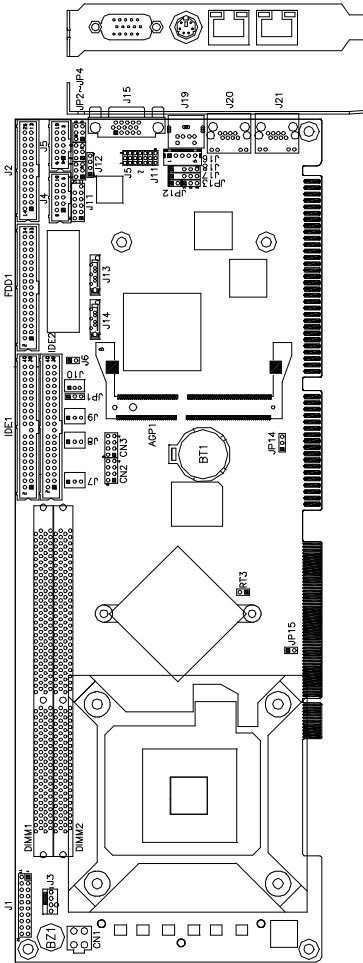



- JP1: Clear CMOS Contents
- JP2, JP3, JP4: RS232/422/485 (COM2) Selection
- JP5/6/7/8/9/10/11: CRT VGA Signal Select
- JP13: Primary LAN Enable/Disable
- JP14: DiskOnChip Address Select

Jumper Locations on IB865

**JP1: Clear CMOS Contents**

Use JP1, a 3-pin header, to clear the CMOS contents. *Note that the ATX-power connector should be disconnected from the CPU card before clearing CMOS.*

JP1	Setting	Function
	Pin 1-2 Short/Closed	Normal
	Pin 2-3 Short/Closed	Clear CMOS

**JP2, JP3, JP4: RS232/422/485 (COM2) Selection**

J4, COM1 is fixed for RS-232 use only.

J5, COM2 is selectable for RS232, RS-422 and RS-485.

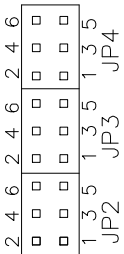

The following table describes the jumper settings for COM2 selection.

COM2 Function	RS-232	RS-422	RS-485
	JP2: 1-2	JP2: 3-4	JP2: 5-6
Jumper Setting (pin closed)	JP3: 3-5 & 4-6	JP3: 1-3 & 2-4	JP3: 1-3 & 2-4
	JP4: 3-5 & 4-6	JP4: 1-3 & 2-4	JP4: 1-3 & 2-4





**JP5/6/7/8/9/10/11: CRT VGA Signal Select**



Use these seven 3-pin headers to select the VGA signal either from the on board VGA or from the MicroAGP VGA.

JP5/6/7/8/9/10/11	Setting	Function
	Pin 1-2 Short/Closed	On board VGA
	Pin 2-3 Short/Closed	MicroAGP VGA

**JP13: Primary LAN Enable/Disable**

JP13	Function
 1 2 3	Enable LAN
 1 2 3	Disable LAN

**JP14: DiskOnChip Address Select**

JP14	Address
 1 2 3	D0000-D7FFF
 1 2 3	D8000-DFFFF (default)

**Jumper and Connectors on IBA120**

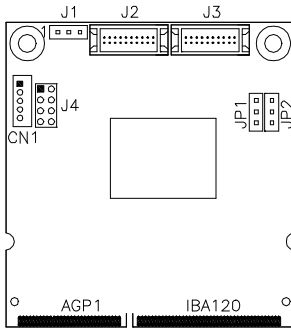

**J1: Panel Inverter Power Connector**

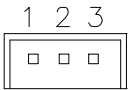

Pin #	Signal Name
1	+12V
2	ENABKL
3	Ground

**Remarks:** Maximum current is 1A.

**JP2: Panel Voltage Setting**

JP2	Setting	Panel Voltage
	Pin 1-2 Short/Closed	3.3V
	Pin 2-3 Short/Closed	5V

**J4: TV out Connector**

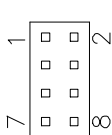

The pin assignments of the TV out connector are as follows:





Signal Name	Pin	Pin	Signal Name
Ground	1	2	Ground
Y	3	4	C
NC	5	6	NC
COMP	7	8	Protect pin



**JP1: TV Type Select**

JP1	Setting	TV Type
	Pin 1-2 Short/Closed	NTSC
	Pin 2-3 Short/Closed	PAL

**JP2: LVDS Panel Power Select**

JP2	Setting	Panel Voltage
	Pin 1-2 Short/Closed	3.3V (default)
	Pin 2-3 Short/Closed	5V

**J2, J3: LVDS Connectors (2nd channel, 1st channel)**

The LVDS connectors, DF13 20-pin mating connectors, are composed of the first channel (J2) and second channel (J3) to support 24-bit or 48-bit.

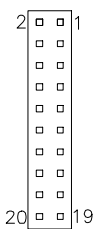
	Signal Name	Pin #	Pin #	Signal Name
	TX0-	2	1	TX0+
	Ground	4	3	Ground
	TX1-	6	5	TX1+
	5V/3.3V	8	7	Ground
	TX3-	10	9	TX3+
	TX2-	12	11	TX2+
	Ground	14	13	Ground
	TXC-	16	15	TXC+
	5V/3.3V	18	17	ENABKL
	+12V	20	19	+12V

**Remarks:** Maximum current for +12V is 1A.

**Jumper and Connectors on IBA110**

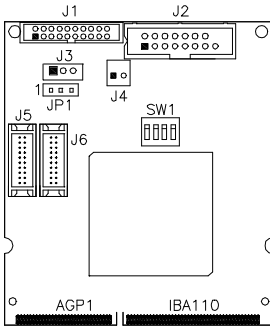

**J1: TMDS Panel Connector**

TMDS stands Transition Minimized Differential Signaling.

	Signal Name	Pin #	Pin #	Signal Name
	TX1P	1	11	TX2P
	TXIN	2	12	TX2N
	GND	3	13	GND
	GND	4	14	GND
	TXCP	5	15	TX0P
	TXCN	6	16	TX0N
	GND	7	17	NC
	+5v	8	18	NC
	HTPG	9	19	DDCDATA
	NC	10	20	DDCCLK

**J2: CRT2 / TV-Out Connector**

This connector is used for a second CRT monitor or use with a TV output device.

	Signal Name	Pin #	Pin #	Signal Name
	Red / C	1	9	+5V
	Green / Y	2	10	Ground
	Blue / COMP	3	11	N. C.
	N.C.	4	12	CRT2 DDCCDAT
	Ground	5	13	HSYNC
	Ground	6	14	VSYNC
	Ground	7	15	CRT2 DDCCLK
	Ground	8	16	N.C.

### J3: Panel Inverter Power Connector

The connector supports 1A current (maximum).

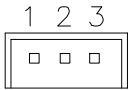
	Pin #	Signal Name
	1	+12V
	2	NC
	3	Ground

### J4: VGA Chipset Fan Power Connector

	Pin #	Signal Name
	1	+12V
	2	Ground

### J5, J6: LVDS Connectors (2nd channel, 1st channel)

The LVDS connectors, DF13 20-pin mating connectors, are composed of the first channel (J6) and second channel (J5) to support 24-bit or 48-bit.

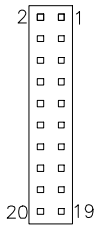
	Signal Name	Pin #	Pin #	Signal Name
	TX0-	2	1	TX0+
	Ground	4	3	Ground
	TX1-	6	5	TX1+
	5V/3.3V	8	7	Ground
	TX3-	10	9	TX3+
	TX2-	12	11	TX2+
	Ground	14	13	Ground
	TXC-	16	15	TXC+
	5V/3.3V	18	17	ENABKL
	+12V	20	19	+12V

**Remarks:** Maximum current for +12V is 1A.

### JP1: LVDS Panel Power Select

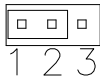
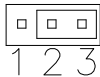
JP1	Setting	Panel Voltage
	Pin 1-2 Short/Closed	3.3V (default)
	Pin 2-3 Short/Closed	5V

**SW1: LVDS Resolution Select**

SW1-1	SW1-2	SW1-3	Resolution
OFF	ON	ON	800x600 18 bit
ON	OFF	ON	1024x768 18bit
OFF	OFF	ON	1024x768 24 bit

## Connectors on IB865

---



---

The connectors on IB865 allows you to connect external devices such as keyboard, floppy disk drives, hard disk drives, printers, etc. The following table lists the connectors on IB865 and their respective functions.

Connector Locations on IB865 .....	18
IDE1, IDE2: EIDE Connectors.....	20
FDD1: Floppy Drive Connector.....	20
CN1: ATX 12V/+12V Power Connector .....	20
CN2, CN3: USB Connectors .....	21
J3: CPU Fan Power Connector .....	21
J7: External ATX Power Connector .....	21
J8, J9: System Fan Power Connector .....	21
J1: System Function Connector .....	22
J2: Parallel Port Connector.....	24
J4, J5: COM1 and COM2 Serial Ports Connector .....	24
J10: Wake On LAN Connector.....	25
J11: External Audio Connector .....	25
J12: CD-In Audio Connector.....	25
J13, J14: Serial ATA (SATA) Connectors .....	25
J15: VGA CRT Connector.....	26
J16, J18: External PS/2 Keyboard and Mouse Connector .....	26
J17: IrDA Connector .....	26
J19: PS/2 Keyboard and Mouse Connector .....	27
J20: Primary RJ45 Connector .....	27
J21: Gigabit LAN RJ45 Connector .....	27
AGP1: MicroAGP Connector (for IBA110 / IBA120).....	27

Connector Locations on IB865

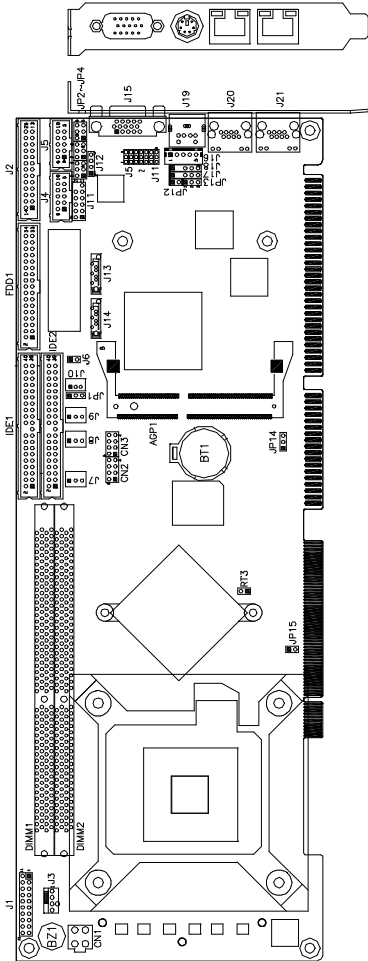

- Connector Locations on IB865:
- IDE1, IDE2: EIDE Connectors
  - FDD1: Floppy Drive Connector
  - CN1: ATX 12V/+12V Power Connector
  - CN2, CN3: USB Connectors
  - J3: CPU Fan Power Connector
  - J7: External ATX Power Connector
  - J8, J9: System Fan Power Connector
  - J1: System Function Connector
  - J2: Parallel Port Connector
  - J4, J5: COM1 and COM2 Serial Ports Connector
  - J10: Wake On LAN Connector
  - J11: External Audio Connector
  - J12: CD-In Audio Connector
  - J13, J14: Serial ATA (SATA) Connectors
  - J15: VGA CRT Connector
  - J16, J18: External PS/2 Mouse and Keyboard Connector
  - J17: IrDA Connector
  - J19: PS/2 Keyboard and Mouse Connector
  - J20: Primary RJ45 Connector
  - J21: Gigabit LAN RJ45 Connector
  - AGP1: MicroAGP Connector (for IBA110 / IBA120)

**IDE1, IDE2: EIDE Connectors**

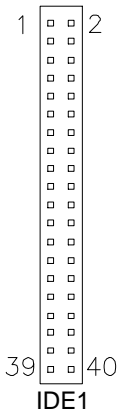

Signal Name	Pin #	Pin #	Signal Name
Reset IDE	1	2	Ground
Host data 7	3	4	Host data 8
Host data 6	5	6	Host data 9
Host data 5	7	8	Host data 10
Host data 4	9	10	Host data 11
Host data 3	11	12	Host data 12
Host data 2	13	14	Host data 13
Host data 1	15	16	Host data 14
Host data 0	17	18	Host data 15
Ground	19	20	Protect pin
DRQ0	21	22	Ground
Host IOW	23	24	Ground
Host IOR	25	26	Ground
IOCHRDY	27	28	Host ALE
DACK0	29	30	Ground
IRQ14	31	32	No connect
Address 1	33	34	No connect
Address 0	35	36	Address 2
Chip select 0	37	38	Chip select 1
Activity	39	40	Ground

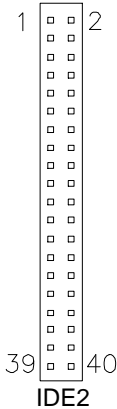

Signal Name	Pin #	Pin #	Signal Name
Reset IDE	1	2	Ground
Host data 7	3	4	Host data 8
Host data 6	5	6	Host data 9
Host data 5	7	8	Host data 10
Host data 4	9	10	Host data 11
Host data 3	11	12	Host data 12
Host data 2	13	14	Host data 13
Host data 1	15	16	Host data 14
Host data 0	17	18	Host data 15
Ground	19	20	Protect pin
DRQ1	21	22	Ground
Host IOW	23	24	Ground
Host IOR	25	26	Ground
IOCHRDY	27	28	Host ALE
DACK1	29	30	Ground
IRQ15	31	32	No connect
Address 1	33	34	No connect
Address 0	35	36	Address 2
Chip select 0	37	38	Chip select 1
Activity	39	40	Ground

**FDD1: Floppy Drive Connector**

FDD1 is a 34-pin header and will support up to 2.88MB floppy drives.

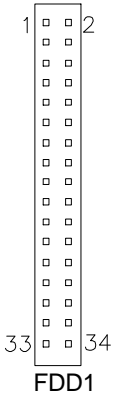

Signal Name	Pin #	Pin #	Signal Name
Ground	1	2	RM/LC
Ground	3	4	No connect
Ground	5	6	No connect
Ground	7	8	Index
Ground	9	10	Motor enable 0
Ground	11	12	Drive select 1
Ground	13	14	Drive select 0
Ground	15	16	Motor enable 1
Ground	17	18	Direction
Ground	19	20	Step
Ground	21	22	Write data
Ground	23	24	Write gate
Ground	25	26	Track 00
Ground	27	28	Write protect
Ground	29	30	Read data
Ground	31	32	Side 1 select
Ground	33	34	Diskette change

**CN1: ATX 12V/+12V Power Connector**

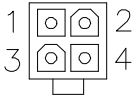

Pin #	Signal Name
1	Ground
2	Ground
3	+12V
4	+12V



### CN2, CN3: USB Connectors

The following table shows the pin outs of the USB pin headers connectors. Overall, the two pin headers support four USB ports.

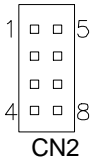

Signal Name	Pin	Pin	Signal Name
Vcc	1	5	Ground
USB0-	2	6	USB1+
USB0+	3	7	USB1-
Ground	4	8	Vcc

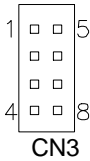

Signal Name	Pin	Pin	Signal Name
Vcc	1	5	Ground
USB2-	2	6	USB3+
USB2+	3	7	USB3-
Ground	4	8	Vcc

### J3: CPU Fan Power Connector

J3 is a 3-pin header for the CPU fan. The fan must be a 12V fan.



Pin #	Signal Name
1	Ground
2	+12V
3	Rotation detection
4	Control

### J7: External ATX Power Connector

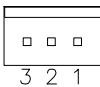

Pin #	Signal Name
1	Ground
2	PS-ON (soft on/off)
3	5VSB (Standby +5V)

### J8, J9: System Fan Power Connector

J8 and J9 are 3-pin headers for system fans. The fan must be a 12V fan.

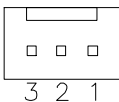

Pin #	Signal Name
1	Ground
2	+12V
3	Rotation detection

**J1: System Function Connector**

J1 provides connectors for system indicators that provide light indication of the computer activities and switches to change the computer status. J1 is a 20-pin header that provides interfaces for the following functions.

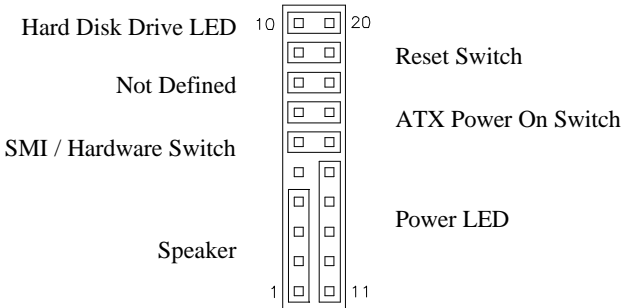

**Speaker: Pins 1 - 4**

This connector provides an interface to a speaker for audio tone generation. An 8-ohm speaker is recommended.

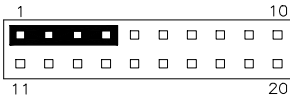

Pin #	Signal Name
1	Speaker out
2	No connect
3	Ground
4	+5V

**Power LED: Pins 11 - 15**

The power LED indicates the status of the main power switch.

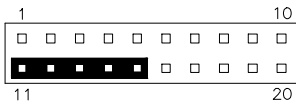

Pin #	Signal Name
11	Power LED
12	No connect
13	Ground
14	No connect
15	Ground

**SMI/Hardware Switch: Pins 6 and 16**

This connector supports the "Green Switch" on the control panel, which, when pressed, will force the system into the power-saving mode immediately.

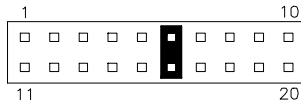

Pin #	Signal Name
6	SMI
16	Ground

**ATX Power ON Switch: Pins 7 and 17**

This 2-pin connector is an "ATX Power Supply On/Off Switch" on the system that connects to the power switch on the case. When pressed, the power switch will force the system to power on. When pressed again, it will force the system to power off.

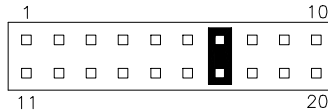

**Reset Switch: Pins 9 and 19**

The reset switch allows the user to reset the system without turning the main power switch off and then on again. Orientation is not required when making a connection to this header.

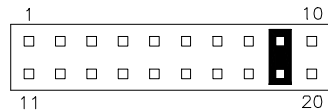

**Hard Disk Drive LED Connector: Pins 10 and 20**

This connector connects to the hard drive activity LED on control panel. This LED will flash when the HDD is being accessed.

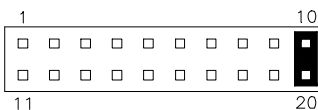

Pin #	Signal Name
10	HDD Active
20	5V

**J2: Parallel Port Connector**

The following table describes the pin out assignments of this connector.

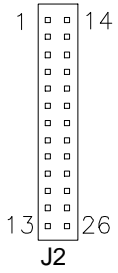

Signal Name	Pin #	Pin #	Signal Name
Line printer strobe	1	14	AutoFeed
PD0, parallel data 0	2	15	Error
PD1, parallel data 1	3	16	Initialize
PD2, parallel data 2	4	17	Select
PD3, parallel data 3	5	18	Ground
PD4, parallel data 4	6	19	Ground
PD5, parallel data 5	7	20	Ground
PD6, parallel data 6	8	21	Ground
PD7, parallel data 7	9	22	Ground
ACK, acknowledge	10	23	Ground
Busy	11	24	Ground
Paper empty	12	25	Ground
Select	13	N/A	N/A

**J4, J5: COM1 and COM2 Serial Ports Connector**

J4 and J5 both 10-pin headers, are the onboard serial port connectors.

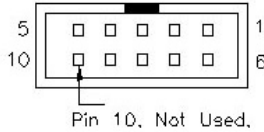

J4 Fixed as RS-232	Pin #	Signal Name		
		RS-232	RS-422	RS-485
J5 Configurable as RS-232/ RS-422/485 with jumpers JP2/JP3/JP4	1	DCD	TX-	DATA-
	2	RX	TX+	DATA+
	3	TX	RX+	NC
	4	DTR	RX-	NC
	5	GND	GND	GND
	6	DSR	RTS-	NC
	7	RTS	RTS+	NC
	8	CTS	CTS+	NC
	9	RI	CTS-	NC
	10	NC	NC	NC

**J10: Wake On LAN Connector**

J10 is a 3-pin header for the Wake On LAN function on the motherboard. The following table shows the pin out assignments of this connector. Wake On LAN will function properly only with an ATX power supply with 5VSB that has 1A.

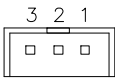

Pin #	Signal Name
1	+5VSB
2	Ground
3	LAN Wakeup

**J11: External Audio Connector**

J11 is a 12-pin header that is used to connect to the optional audio cable that integrates jacks for Line In, Line Out and Mic.

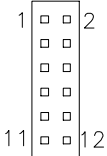

Signal Name	Pin #	Pin #	Signal Name
LINEOUT_R	1	2	LINEOUT_L
Ground	3	4	Ground
LINEIN_R	5	6	LINEIN L
Ground	7	8	Ground
Mic-In	9	10	VREFOUT
Ground	11	12	Protect pin

**J12: CD-In Audio Connector**



Pin #	Signal Name
1	CD Audio R
2	Ground
3	Ground
4	CD Audio L

**J13, J14: Serial ATA (SATA) Connectors**

The SATA connectors support serial ATA 150. Each connector can only use one serial ATA hard disk. J13 is port 1 and J14 is port 2.

**J15: VGA CRT Connector**

The pin assignments of the J15 VGA CRT connector are as follows:

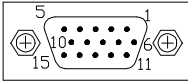

J15

Signal Name	Pin	Pin	Signal Name
Red	1	2	Green
Blue	3	4	N.C.
GND	5	6	GND
GND	7	8	GND
N.C.	9	10	GND
N.C.	11	12	N.C.
HSYNC	13	14	VSYNC
NC	15		

**J16, J18: External PS/2 Keyboard and Mouse Connector**

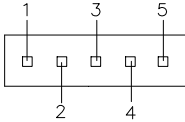

Pin #	J16	J18
1	KB clock	Mouse data
2	KB data	N.C.
3	N.C.	Ground
4	Ground	Vcc
5	Vcc	Mouse clock

**J17: IrDA Connector**

J17 is used for an optional IrDA connector for wireless communication.

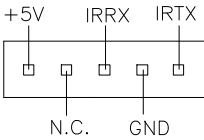

Pin #	Signal Name
1	+5V
2	No connect
3	Ir RX
4	Ground
5	Ir TX

**J19: PS/2 Keyboard and Mouse Connector**

J19 uses a Y-cable with dual D-connectors for a PS/2 keyboard and a PS/2 mouse.

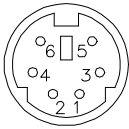

J19

Pin #	Signal Name
1	Mouse data
2	Keyboard data
3	Ground
4	Vcc
5	Mouse Clock
6	Keyboard Clock

**J20: Primary RJ45 Connector**

J20 is the primary RJ-45 connector based on the chipset integrated LAN. The figure below shows the pin out assignments of the connector and its corresponding input jack.

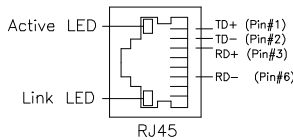

**J21: Gigabit LAN RJ45 Connector**

J21 is the Gigabit LAN RJ45 connector.

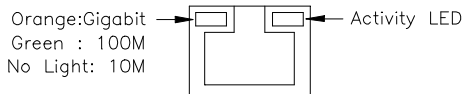

**AGP1: MicroAGP Connector (for IBA110 / IBA120)**

## Watchdog Timer Configuration

---

---

The WDT is used to generate a variety of output signals after a user programmable count. The WDT is suitable for use in the prevention of system lock-up, such as when software becomes trapped in a deadlock. Under these sort of circumstances, the timer will count to zero and the selected outputs will be driven. Under normal circumstance, the user will restart the WDT at regular intervals before the timer counts to zero.

### SAMPLE CODE:

This code and information is provided "as is" without warranty of any kind, either expressed or implied, including but not limited to the implied warranties of merchantability and/or fitness for a particular purpose.

---

---

```
:[]=====
; Name  : Enable_And_Set_Watchdog
; IN   : AL - 1sec ~ 255sec
; OUT  : None
:[]=====
Enable_And_Set_Watchdog Proc Near
    pushax                ;save time interval
    call Unlock_Chip

    mov cl, 2Bh
    call Read_Reg
    and al, NOT 10h
    call Write_Reg        ;set GP24 as WDTO

    mov cl, 07h
    mov al, 08h
    call Write_Reg        ;switch to LD8

    mov cl, 0F5h
    call Read_Reg
    and al, NOT 08h
    call Write_Reg        ;set count mode as second

    pop ax
    mov cl, 0F6h
    call Write_Reg        ;set watchdog timer
```



```

        mov al, 01h
        mov cl, 30h
        call Write_Reg          ;watchdog enabled

        call Lock_Chip
        ret
Enable_And_Set_Watchdog Endp
;[]=====
; Name   : Disable_Watchdog
; IN    : None
; OUT   : None
;[]=====
Disable_Watchdog Proc Near
        call Unlock_Chip

        mov cl, 07h
        mov al, 08h
        call Write_Reg          ;switch to LD8

        xor  al, al
        mov cl, 0F6h
        call Write_Reg          ;clear watchdog timer

        xor  al, al
        mov cl, 30h
        call Write_Reg          ;watchdog disabled

        call Lock_Chip
        ret
Disable_Watchdog Endp
;[]=====
; Name   : Unlock_Chip
; IN    : None
; OUT   : None
;[]=====
Unlock_Chip Proc Near
        mov dx, 2Eh
        mov al, 87h
        out  dx, al
        out  dx, al
        ret
Unlock_Chip Endp
;[]=====

```

```
; Name : Lock_Chip
; IN : None
; OUT : None
;[]=====
Unlock_Chip Proc Near
    mov dx, 2Eh
    mov al, 0AAh
    out dx, al
    ret
Unlock_Chip Endp
;[]=====
; Name : Write_Reg
; IN : CL - register index
; AL - Value to write
; OUT : None
;[]=====
Write_Reg Proc Near
    pushax
    mov dx, 2Eh
    mov al, cl
    out dx, al
    pop ax
    inc dx
    out dx, al
    ret
Write_Reg Endp
;[]=====
; Name : Read_Reg
; IN : CL - register index
; OUT : AL - Value to read
;[]=====
Read_Reg Proc Near
    mov al, cl
    mov dx, 2Eh
    out dx, al
    inc dx
    in al, dx
    ret
Read_Reg Endp
;[]=====
```

---

# BIOS Setup

This chapter describes the different settings available in the Award BIOS that comes with the CPU card. The topics covered in this chapter are as follows:

BIOS Introduction.....	32
BIOS Setup .....	32
Standard CMOS Setup.....	34
Advanced BIOS Features .....	37
Advanced Chipset Features .....	40
Integrated Peripherals .....	43
Power Management Setup.....	46
PNP/PCI Configurations .....	49
PC Health Status.....	50
Frequency/Voltage Control.....	51
Load Fail-Safe Defaults.....	52
Load Setup Defaults .....	52
Set Supervisor/User Password .....	52
Save & Exit Setup .....	52
Exit Without Saving .....	52

## BIOS Introduction

The Award BIOS (Basic Input/Output System) installed in your computer system's ROM supports Intel Pentium 4 processors. The BIOS provides critical low-level support for a standard device such as disk drives, serial ports and parallel ports. It also adds virus and password protection as well as special support for detailed fine-tuning of the chipset controlling the entire system.

## BIOS Setup

The Award BIOS provides a Setup utility program for specifying the system configurations and settings. The BIOS ROM of the system stores the Setup utility. When you turn on the computer, the Award BIOS is immediately activated. Pressing the <Del> key immediately allows you to enter the Setup utility. If you are a little bit late pressing the <Del> key, POST (Power On Self Test) will continue with its test routines, thus preventing you from invoking the Setup. If you still wish to enter Setup, restart the system by pressing the "Reset" button or simultaneously pressing the <Ctrl>, <Alt> and <Delete> keys. You can also restart by turning the system Off and back On again. The following message will appear on the screen:

Press <DEL> to Enter Setup

In general, you press the arrow keys to highlight items, <Enter> to select, the <PgUp> and <PgDn> keys to change entries, <F1> for help and <Esc> to quit.

When you enter the Setup utility, the Main Menu screen will appear on the screen. The Main Menu allows you to select from various setup functions and exit choices.

## Phoenix - AwardBIOS CMOS Setup Utility

Standard CMOS Features	Frequency/Voltage Control
Advanced BIOS Features	Load Fail-Safe Defaults
Advanced Chipset Features	Load Optimized Defaults
Integrated Peripherals	Set Supervisor Password
Power Management Setup	Set User Password
PnP/PCI Configurations	Save & Exit Setup
PC Health Status	Exit Without Saving
ESC : Quit	↑ ↓ → ← : Select Item
F10 : Save & Exit Setup	
Time, Date, Hard Disk Type...	

The section below the setup items of the Main Menu displays the control keys for this menu. At the bottom of the Main Menu just below the control keys section, there is another section, which displays information on the currently highlighted item in the list.

**Note:** *If the system cannot boot after making and saving system changes with Setup, the Award BIOS supports an override to the CMOS settings that resets your system to its default.*

**Warning:** *It is strongly recommended that you avoid making any changes to the chipset defaults. These defaults have been carefully chosen by both Award and your system manufacturer to provide the absolute maximum performance and reliability. Changing the defaults could cause the system to become unstable and crash in some cases.*

## Standard CMOS Setup

“Standard CMOS Setup” choice allows you to record some basic hardware configurations in your computer system and set the system clock and error handling. If the CPU card is already installed in a working system, you will not need to select this option. You will need to run the Standard CMOS option, however, if you change your system hardware configurations, the onboard battery fails, or the configuration stored in the CMOS memory was lost or damaged.

Phoenix - AwardBIOS CMOS Setup Utility  
Standard CMOS Features

		Item Help
Date (mm:dd:yy)	Thu, May 21, 2001	Menu Level
Time (hh:mm:ss)	00 : 00 : 00	
IDE Channel 0 Master	Press Enter 13020 MB	Change the day, month, Year and century
IDE Channel 0 Slave	Press Enter None	
IDE Channel 1 Master	Press Enter None	
IDE Channel 1 Slave	Press Enter None	
IDE Channel 2 Master		
IDE Channel 3 Master		
Drive A	1.44M, 3.5 in.	
Drive B	None	
Video	EGA/VGA	
Halt On	All , But Keyboard	
Base Memory	640K	
Extended Memory	129024K	
Total Memory	130048K	

At the bottom of the menu are the control keys for use on this menu. If you need any help in each item field, you can press the <F1> key. It will display the relevant information to help you. The memory display at the lower right-hand side of the menu is read-only. It will adjust automatically according to the memory changed. The following describes each item of this menu.

### Date

The date format is:

- Day :** Sun to Sat
- Month :** 1 to 12
- Date :** 1 to 31
- Year :** 1994 to 2079

To set the date, highlight the “Date” field and use the PageUp/ PageDown or +/- keys to set the current time.

**Time**

The time format is: **Hour : 00 to 23**  
**Minute : 00 to 59**  
**Second : 00 to 59**

To set the time, highlight the “Time” field and use the <PgUp>/<PgDn> or +/- keys to set the current time.

**IDE Primary HDDs / IDE Secondary HDDs**

The onboard PCI IDE connectors provide Primary and Secondary channels for connecting up to four IDE hard disks or other IDE devices. Each channel can support up to two hard disks; the first is the “Master” and the second is the “Slave”.

Press <Enter> to configure the hard disk. The selections include Auto, Manual, and None. Select ‘Manual’ to define the drive information manually. You will be asked to enter the following items.

**CYLS :**            Number of cylinders  
**HEAD :**            Number of read/write heads  
**PRECOMP :**        Write precompensation  
**LANDZ :**            Landing zone  
**SECTOR :**          Number of sectors

The Access Mode selections are as follows:

Auto  
Normal (HD < 528MB)  
Large (for MS-DOS only)  
LBA (HD > 528MB and supports  
Logical Block Addressing)

**Remarks:** The main board supports two serial ATA ports and are represented in this setting as IDE Channel 2 / 3 Master.

**Drive A / Drive B**

These fields identify the types of floppy disk drive A or drive B that has been installed in the computer. The available specifications are:

360KB	1.2MB	720KB	1.44MB	2.88MB
5.25 in.	5.25 in.	3.5 in.	3.5 in.	3.5 in.

### Video

This field selects the type of video display card installed in your system.

You can choose the following video display cards:

EGA/VGA	For EGA, VGA, SEGA, SVGA or PGA monitor adapters. (default)
CGA 40	Power up in 40 column mode.
CGA 80	Power up in 80 column mode.
MONO	For Hercules or MDA adapters.

### Halt On

This field determines whether or not the system will halt if an error is detected during power up.

No errors	The system boot will not be halted for any error that may be detected.
All errors	Whenever the BIOS detects a non-fatal error, the system will stop and you will be prompted.
All, But Keyboard	The system boot will not be halted for a keyboard error; it will stop for all other errors
All, But Diskette	The system boot will not be halted for a disk error; it will stop for all other errors.
All, But Disk/Key	The system boot will not be halted for a keyboard or disk error; it will stop for all others.



## Advanced BIOS Features

This section allows you to configure and improve your system and allows you to set up some system features according to your preference.

Phoenix - AwardBIOS CMOS Setup Utility  
Advanced BIOS Features

		ITEM HELP
CPU Feature	Press Enter	
Hard Disk Boot Priority	Press Enter	Menu Level
CD-ROM Boot Priority	Press Enter	
Virus Warning	Disabled	
CPU L1 and L2 Cache	Enabled	
Hyper-threading Technology	Enabled	
Quick Power On Self Test	Enabled	
First Boot Device	Floppy	
Second Boot Device	Hard Disk	
Third Boot Device	CD-ROM	
Boot Other Device	Enabled	
Swap Floppy Drive	Disabled	
Boot Up Floppy Seek	Disabled	
Boot Up Numlock Status	On	
Gate A20 Option	Fast	
Typeomatic Rate Setting	Disabled	
Typeomatic Rate (chars/Sec)	6	
Typeomatic Delay (Msec)	250	
Security Option	Setup	
APIC Mode	Enabled	
MPS Version Control for OS	1.4	
OS Select For DRAM>64MB	Non-OS2	
Report No FDD For WIN 95	Yes	
Small Logo (EPA) Show	Enable	
		Allows you choose the VIRUS warning feature for IDE Hard Disk boot sector protection. If this function is enabled and someone attempt to write data into this area, BIOS will show a warning message on screen and alarm beep

### CPU Feature

Press Enter to configure the settings relevant to CPU Feature.

### Hard Disk / CD-ROM Boot Priority

This item allows you to set the priority for hard disk boot. When you press enter, the selections shows the current hard disks used in your system as well as the "Bootable Add-in Card" that is relevant to other boot sources media such as SCSI cards and LAN cards.

### Virus Warning

If this option is enabled, an alarm message will be displayed when trying to write on the boot sector or on the partition table on the disk, which is typical of the virus.

### CPU L1 and L2 Cache

Cache memory is additional memory that is much faster than conventional DRAM (system memory). CPUs from 486-type on up contain internal cache memory, and most, but not all, modern PCs have additional (external) cache memory. When the CPU requests data, the system transfers the requested data from the main DRAM into cache memory, for even faster access by the CPU. These items allow you to enable (speed up memory access) or disable the cache function. By default, these items are Enabled.

### **Hyper-Threading Technology**

This feature is enabled when your processor supports Hyper-Threading Technology. Otherwise, this field will be hidden.

### **Quick Power On Self Test**

When enabled, this field speeds up the Power On Self Test (POST) after the system is turned on. If it is set to Enabled, BIOS will skip some items.

### **First/Second/Third Boot Device**

These fields determine the drive that the system searches first for an operating system. The options available include *Floppy*, *LS/ZIP*, *HDD-0*, *SCSI*, *CDROM*, *HDD-1*, *HDD-2*, *HDD-3*, *LAN* and *Disable*.

### **Boot Other Device**

These fields allow the system to search for an operating system from other devices other than the ones selected in the First/Second/Third Boot Device.

### **Swap Floppy Drive**

This item allows you to determine whether or not to enable Swap Floppy Drive. When enabled, the BIOS swaps floppy drive assignments so that Drive A becomes Drive B, and Drive B becomes Drive A. By default, this field is set to *Disabled*.

### **Boot Up Floppy Seek**

This feature controls whether the BIOS checks for a floppy drive while booting up. If it cannot detect one (either due to improper configuration or its absence), it will flash an error message.

### **Boot Up NumLock Status**

This allows you to activate the NumLock function after you power up the system.

### **Gate A20 Option**

This field allows you to select how Gate A20 is worked. Gate A20 is a device used to address memory above 1 MB.

### **Typematic Rate Setting**

When disabled, continually holding down a key on your keyboard will generate only one instance. When enabled, you can set the two typematic controls listed next. By default, this field is set to *Disabled*.

**Typematic Rate (Chars/Sec)**

When the typematic rate is enabled, the system registers repeated keystrokes speeds. Settings are from 6 to 30 characters per second.

**Typematic Delay (Msec)**

When the typematic rate is enabled, this item allows you to set the time interval for displaying the first and second characters. By default, this item is set to *250msec*.

**Security Option**

This field allows you to limit access to the System and Setup. The default value is *Setup*. When you select *System*, the system prompts for the User Password every time you boot up. When you select *Setup*, the system always boots up and prompts for the Supervisor Password only when the Setup utility is called up.

**APIC Mode**

APIC stands for Advanced Programmable Interrupt Controller. The default setting is *Enabled*.

**MPS Version Control for OS**

This option specifies the MPS (Multiprocessor Specification) version for the OS. MPS version 1.4 added extended configuration tables to improve support for multiple PCI bus configurations and improve future expandability. The default setting is *1.4*.

**OS Select for DRAM > 64MB**

This option allows the system to access greater than 64MB of DRAM memory when used with OS/2 that depends on certain BIOS calls to access memory. The default setting is *Non-OS/2*.

**Report No FDD For WIN 95**

If you are using Windows 95/98 without a floppy disk drive, select Enabled to release IRQ6. This is required to pass Windows 95/98's SCT test. You should also disable the Onboard FDC Controller in the Integrated Peripherals screen when there's no floppy drive in the system. If you set this feature to Disabled, the BIOS will not report the missing floppy drive to Win95/98.

**Small Logo (EPA) Show**

The EPA logo appears at the right side of the monitor screen when the system is boot up. The default setting is *Enabled*.

---

## Advanced Chipset Features

This Setup menu controls the configuration of the chipset.

Phoenix - AwardBIOS CMOS Setup Utility  
Advanced Chipset Features

DRAM Timing Selectable	By SPD	ITEM HELP
CAS Latency Time	2.5	Menu Level
Active to Precharge Delay	6	
DRAM RAS# to CAS# Delay	3	
DRAM RAS# Precharge	3	
Memory Frequency For	Auto	
System BIOS Cacheable	Enabled	
Video BIOS Cacheable	Disabled	
Memory Hole at 15M-16M	Disabled	
Delay Prior to Thermal	16 Min	
AGP Aperture Size (MB)	128	
Init Display First	Onboard/AGP	
** On-Chip VGA Setting **		
On-Chip VGA	Enabled	
On-Chip Frame Buffer Size	8MB	
Boot Display	CRT + LVDS	
Panel Scaling	Auto	
Panel Number	1024x768 LVDS	
TV Standard	Off	
Video Connector	Automatic	
TV Format	Auto	

### DRAM Timing Selectable

This option refers to the method by which the DRAM timing is selected. The default is *By SPD*.

### CAS Latency Time

You can select CAS latency time in HCLKs of 2/2 or 3/3. The system board designer should set the values in this field, depending on the DRAM installed. Do not change the values in this field unless you change specifications of the installed DRAM or the installed CPU. The choices are 2 and 3.

### Active to Precharge Delay

The default setting for the Active to Precharge Delay is **6**.

### DRAM RAS# to CAS# Delay

This option allows you to insert a delay between the RAS (Row Address Strobe) and CAS (Column Address Strobe) signals. This delay occurs when the SDRAM is written to, read from or refreshed. Reducing the delay improves the performance of the SDRAM.

**DRAM RAS# Precharge**

This option sets the number of cycles required for the RAS to accumulate its charge before the SDRAM refreshes. The default setting for the Active to Precharge Delay is **3**.

**Memory Frequency For**

This field sets the frequency of the DRAM memory installed. The default setting is *Auto*. The other settings are *PC200* and *PC266*.

**System BIOS Cacheable**

The setting of *Enabled* allows caching of the system BIOS ROM at F000h-FFFFh, resulting in better system performance. However, if any program writes to this memory area, a system error may result.

**Video BIOS Cacheable**

The Setting *Enabled* allows caching of the video BIOS ROM at C0000h-F7FFFh, resulting in better video performance. However, if any program writes to this memory area, a system error may result.

**Memory Hole At 15M-16M**

In order to improve performance, certain space in memory can be reserved for ISA cards. This memory must be mapped into the memory space below 16 MB. The choices are *Enabled* and *Disabled*.

**Delay Prior to Thermal**

This field activates the CPU thermal function after the systems boots for the set number of minutes. The options are **16Min** and **64Min**.

**AGP Aperture Size**

The field sets aperture size of the graphics. The aperture is a portion of the PCI memory address range dedicated for graphics memory address space. Host cycles that hit the aperture range are forwarded to the AGP without any translation. The default setting is **128M**.

**Init Display First**

This field allows the system to initialize first the VGA on chip or the display card on the PCI Slot.

### **On-Chip VGA**

By default, the On-Chip VGA or 865G chipset-integrated VGA is *Enabled*.

### **On-Chip Frame Buffer Size**

The On-Chip Frame Buffer Size can be set us 1MB, 8MB or 16MB. This memory is shared with the system memory.

### **Boot Display**

Boot Display determines the display output device where the system boots. The default setting is *LVDS*.

### **Panel Scaling**

With the default setting of Auto, this item automatically displays the resolution of the panel used in the system to 'full' screen.

### **Panel Number**

By default, this item is set to *1024 x 768 LVDS*. If you are using other kinds of panel, enter this field to select the one that suits your panel.

### **TV Standard**

By default, this item is set to *off*.

### **Video Connector**

By default, this item is set to *Automatic*.

### **TV Format**

By default, this item is set to *Auto*.

## Integrated Peripherals

This section sets configurations for your hard disk and other integrated peripherals. The first screen shows three main items for user to select. Once an item selected, a submenu appears. Details follow.

Phoenix - AwardBIOS CMOS Setup Utility  
Integrated Peripherals

On-Chip Primary IDE Device	Press Enter	ITEM HELP
Onboard Device	Press Enter	Menu Level
SuperIO Device	Press Enter	
Onboard Lan Boot ROM	Enable	

Phoenix - AwardBIOS CMOS Setup Utility  
OnChip IDE Device

IDE Block Mode	Enabled	ITEM HELP
On-Chip Primary PCI IDE	Enabled	Menu Level
IDE Primary Master PIO	Auto	
IDE Primary Slave PIO	Auto	
IDE Primary Master UDMA	Auto	
IDE Primary Slave UDMA	Auto	
On-Chip Secondary PCI IDE	Enabled	
IDE Secondary Master PIO	Auto	
IDE Secondary Slave PIO	Auto	
IDE Secondary Master UDMA	Auto	
IDE Secondary Slave UDMA	Auto	
*** On-Chip Serial ATA Setting ***		
On-Chip Serial ATA	Auto	
Serial ATA Port0 Mode	SATA0 master	
Serial ATA Port1 Mode	SATA1 master	

Phoenix - AwardBIOS CMOS Setup Utility  
Onboard Device

USB 2.0 Controller	Enabled	ITEM HELP
USB Controller	Enabled	Menu Level
USB Keyboard Support	Disabled	
USB Mouse Support	Disabled	
AC97 Audio	Auto	
CSA LAN (Giga-LAN)	Enable	

Phoenix - AwardBIOS CMOS Setup Utility  
SuperIO Device

Onboard FDC Controller	Enabled	ITEM HELP
Onboard Serial Port 1	3F8/IRQ4	Menu Level
Onboard Serial Port 2	2F8/IRQ3	
UART Mode Select	Normal	
Onboard Parallel Port	378/IRQ7	
Parallel Port Mode	SPP	
Power After PWR-Fail	off	

**IDE HDD Block Mode**

This field allows your hard disk controller to use the fast block mode to transfer data to and from your hard disk drive.

**OnChip Primary/Secondary PCI IDE**

The integrated peripheral controller contains an IDE interface with support for two IDE channels. Select *Enabled* to activate each channel separately.

**IDE Primary/Secondary Master/Slave PIO**

These fields allow your system hard disk controller to work faster. Rather than have the BIOS issue a series of commands that transfer to or from the disk drive, PIO (Programmed Input/Output) allows the BIOS to communicate with the controller and CPU directly. The system supports five modes, numbered from 0 (default) to 4, which primarily differ in timing. When Auto is selected, the BIOS will select the best mode.

**IDE Primary/Secondary Master/Slave UDMA**

These fields allow your system to improve disk I/O throughput to 33Mb/sec with the Ultra DMA/33 feature. The options are *Auto* and *Disabled*.

**On-Chip Serial ATA**

The default setting of *Auto* allows the Serial ATA drive to be enabled, when the system detects one.

**USB Controller**

By default, this field is set to *Enabled*.

**USB 2.0 Controller**

By default, this field is set to *Disabled*. In order to use USB 2.0, necessary OS drivers must be installed first.



**USB Keyboard Support**

By default, this field is set to *Disabled*.

**USB Mouse Support**

By default, this field is set to *Disabled*.

**AC97 Audio**

The default setting of the AC97 Audio is *Auto*.

**CSA LAN (Giga-LAN)**

The default setting of the onboard Gigabit LAN is enabled.

**Onboard FDC Controller**

Select *Enabled* if your system has a floppy disk controller (FDC) installed on the CPU card and you wish to use it. If you install an add-in FDC or the system has no floppy drive, select *Disabled* in this field. This option allows you to select the onboard FDD port.

**Onboard Serial/Parallel Port**

These fields allow you to select the onboard serial and parallel ports and their addresses. The default values for these ports are:

Serial Port 1	3F8/IRQ4
Serial Port 2	2F8/IRQ3
Parallel Port	378H/IRQ7

**UART Mode Select**

This field determines the UART 2 mode in your computer. The default value is *Normal*. Other options include *IrDA* and *ASKIR*.

**Parallel Port Mode**

This field allows you to determine parallel port mode function.

SPP	Standard Printer Port
EPP	Enhanced Parallel Port
ECP	Extended Capabilities Port

**Power After PWR-Fail**

This field refers to the power status (ON/Off) of the system when the power returns to the system after power is cut off.

**Onboard Lan Boot ROM**

By default, the on board LAN boot ROM is enabled.

## Power Management Setup

The Power Management Setup allows you to save energy of your system effectively.

Phoenix - AwardBIOS CMOS Setup Utility  
Power Management Setup

		ITEM HELP
Power-Supply Type	ATX	
ACPI Function	Enabled	Menu Level
Power Management	User Define	Menu Level
Video Off Method	V/H SYNC+Blank	
Video Off In Suspend	Yes	
Suspend Type	Stop Grant	
Modem Use IRQ	3	
Suspend Mode	Disabled	
HDD Power Down	Disabled	
Soft-Off by PWR-BTTN	Instant-Off	
CPU THRM-Throttling	50%	
Wake-Up by PCI Card	Disabled	
Power On by Ring	Disabled	
Wake Up on CSA Lan	Disabled	
Resume by Alarm	Disabled	
Date (of Month) Alarm	0	
Time (hh:mm:ss) Alarm	0 : 0 : 0	
** Reload Global Timer Events **		
Primary IDE 0	Enabled	
Primary IDE 1	Enabled	
Secondary IDE 0	Enabled	
Secondary IDE 1	Enabled	
FDD, COM, LPT Port	Enabled	
PCI PIRQ[A-D] #	Enabled	

### Power Supply Type

This field sets the power supply type that is in your system. By default, the setting is set to **ATX**.

### ACPI Function

Enable this function to support ACPI (Advance Configuration and Power Interface).

## Power Management

This field allows you to select the type of power saving management modes. There are four selections for Power Management.

Min. Power Saving	Minimum power management
Max. Power Saving	Maximum power management.
User Define	Each of the ranges is from 1 min. to 1hr. Except for HDD Power Down which ranges from 1 min. to 15 min.

## Video Off Method

This field defines the Video Off features. There are three options.

V/H SYNC + Blank	Default setting, blank the screen and turn off vertical and horizontal scanning.
DPMS	Allows BIOS to control the video display.
Blank Screen	Writes blanks to the video buffer.

## Video Off In Suspend

When enabled, the video is off in suspend mode. The default setting is *Yes*.

## Suspend Type

The default setting for the Suspend Type field is *Stop Grant*.

## Modem Use IRQ

This field sets the IRQ used by the Modem. By default, the setting is **3**.

## Suspend Mode

When enabled, and after the set time of system inactivity, all devices except the CPU will be shut off.

## HDD Power Down

When enabled, and after the set time of system inactivity, the hard disk drive will be powered down while all other devices remain active.

## Soft-Off by PWRBTN

This field defines the power-off mode when using an ATX power supply. The *Instant Off* mode allows powering off immediately upon pressing the power button. In the *Delay 4 Sec* mode, the system powers off when the power button is pressed for more than four seconds or enters the suspend mode when pressed for less than 4 seconds.

### **CPU THRM-Throttling**

When the system enters Doze mode, the CPU clock runs only part of the time. You may select the percent of time that the clock runs.

### **Wake-Up by PCI Cards**

Enable this field to allow wake up function through a PCI card.

### **Power On by Ring**

This field enables or disables the power on of the system through the modem connected to the serial port or LAN.

### **Wake Up On CSA Lan**

Enable this field to allow wake up function through the onboard CSA LAN.

### **Resume by Alarm**

This field enables or disables the resumption of the system operation. When enabled, the user is allowed to set the *Date* and *Time*.

### **Reload Global Timer Events**

The HDD, FDD, COM, LPT Ports, and PCI PIRQ are I/O events which can prevent the system from entering a power saving mode or can awaken the system from such a mode. When an I/O device wants to gain the attention of the operating system, it signals this by causing an IRQ to occur. When the operating system is ready to respond to the request, it interrupts itself and performs the service.

## PNP/PCI Configurations

This option configures the PCI bus system. All PCI bus systems on the system use INT#, thus all installed PCI cards must be set to this value.

Phoenix - AwardBIOS CMOS Setup Utility  
PnP/PCI Configurations

PNP OS Install	No	ITEM HELP
Reset Configuration Data	Disabled	Menu Level
Resources Controlled By	Auto (ESCD)	Default is Disabled.
IRQ Resources	Press Enter	Select Enabled to reset
DMA Resources	Press Enter	Extended System
PCI/VGA Palette Snoop	Disabled	Configuration Data
INT Pin 1 Assignment	Auto	(ESCD) when you exit
INT Pin 2 Assignment	Auto	Setup if you have
INT Pin 3 Assignment	Auto	installed a new add-on
INT Pin 4 Assignment	Auto	and the system
INT Pin 5 Assignment	Auto	reconfiguration has
INT Pin 6 Assignment	Auto	caused such a serious
INT Pin 7 Assignment	Auto	conflict that the OS
INT Pin 8 Assignment	Auto	cannot boot

### PNP OS Install

Enable the PNP OS Install option if it is supported by the operating system installed. The default value is *No*.

### Reset Configuration Data

This field allows you to determine whether to reset the configuration data or not. The default value is *Disabled*.

### Resources Controlled by

This PnP BIOS can configure all of the boot and compatible devices automatically with the use of a use a PnP operating system such as Windows 95.

### PCI/VGA Palette Snoop

Some non-standard VGA display cards may not show colors properly. This field allows you to set whether or not MPEG ISA/VESA VGA cards can work with PCI/VGA. When this field is enabled, a PCI/VGA can work with an MPEG ISA/VESA VGA card. When this field is disabled, a PCI/VGA cannot work with an MPEG ISA/VESA card.

## PC Health Status

This section shows the parameters in determining the PC Health Status. These parameters include temperatures, fan speeds and voltages.

Phoenix - AwardBIOS CMOS Setup Utility  
PC Health Status

		ITEM HELP
CPU Warning Temperature	Disabled	
Current SystemTemp.	34°C/93°F	
Current CPU Temp.	35°C/95°F	
Current System Temp.	34°C/93°F	
CPU FAN Speed	4166 RPM	
Chassis FAN1 Speed	5625PM	
Chassis FAN2 Speed	0 RPM	
Vcore (V)	1.63V	
Vcc3(V)	3.37V	
+5(V)	5.05V	
+12(V)	12.09V	
-12(V)	(-)12.03V	
VBAT	3.21V	
5VSB(V)	5.05V	
Shutdown Temperature	Disabled	
Temperature Warning Beep	Disabled	
CPU Fan Failure Warning	Disabled	
Sys FAN Failure Warning	Disabled	
Aux FAN Failure Warning	Disabled	

### CPU Warning Temperature

This field allows the user to set the temperature so that when the temperature is reached, the system sounds a warning. This function can help prevent damage to the system that is caused by overheating.

### Temperatures/Fan Speeds/Voltages

These fields are the parameters of the hardware monitoring function feature of the CPU card. The values are read-only values as monitored by the system and show the PC health status.

### Shutdown Temperature

This field allows the user to set the temperature by which the system automatically shuts down once the threshold temperature is reached. This function can help prevent damage to the system that is caused by overheating.

### Temperature/CPU/Chassis Fan Failure Warning

When enabled, this field lets the system sounds an audible warning to the user that the CPU fan or chassis fan has malfunctioned.

## Frequency/Voltage Control

This section shows the user how to configure the processor frequency.

Phoenix - AwardBIOS CMOS Setup Utility  
Frequency/Voltage Control

Auto Detect PCI Clk	Disabled	ITEM HELP
Spread Spectrum	Disabled	Menu Level

### Auto Detect PCI Clk

This field enables or disables the auto detection of the PCI clock.

### Spread Spectrum

This field sets the value of the spread spectrum. The default setting is *Disabled*. This field is for CE testing use only.

### **Load Fail-Safe Defaults**

This option allows you to load the troubleshooting default values permanently stored in the BIOS ROM. These default settings are non-optimal and disable all high-performance features.

### **Load Setup Defaults**

This option allows you to load the default values to your system configuration. These default settings are optimal and enable all high performance features.

### **Set Supervisor/User Password**

These two options set the system password. Supervisor Password sets a password that will be used to protect the system and Setup utility. User Password sets a password that will be used exclusively on the system. To specify a password, highlight the type you want and press <Enter>. The Enter Password: message prompts on the screen. Type the password, up to eight characters in length, and press <Enter>. The system confirms your password by asking you to type it again. After setting a password, the screen automatically returns to the main screen.

To disable a password, just press the <Enter> key when you are prompted to enter the password. A message will confirm the password to be disabled. Once the password is disabled, the system will boot and you can enter Setup freely.

### **Save & Exit Setup**

This option allows you to determine whether or not to accept the modifications. If you type “Y”, you will quit the setup utility and save all changes into the CMOS memory. If you type “N”, you will return to Setup utility.

### **Exit Without Saving**

Select this option to exit the Setup utility without saving the changes you have made in this session. Typing “Y” will quit the Setup utility without saving the modifications. Typing “N” will return you to Setup utility.



## Drivers Installation

This section describes the installation procedures for software and drivers under the Windows 98, Windows NT 4.0 and Windows 2000. The software and drivers are included with the CPU card. If you find the items missing, please contact the vendor where you made the purchase. The contents of this section include the following:

Intel 865G Chipset Software Intallation Utility .....	54
Intel 865G Chipset Graphics Driver .....	57
Realtek AC97 Codec Audio Driver Installation .....	59
Intel PRO LAN Drivers Installation .....	60

### **IMPORTANT NOTE:**

After installing your Windows operating system (Windows 98/98SE/ME/2000/XP), you must install first the Intel Chipset Software Installation Utility before proceeding with the drivers installation.

## Intel 865G Chipset Software Intallation Utility

The Intel 865G Chipset Drivers should be installed first before the software drivers to enable Plug & Play INF support for Intel chipset components. Follow the instructions below to complete the installation under Windows 98/98SE/ME/2000/XP.

1. Insert the CD that comes with the CPU card and the screen below would appear. Click Intel Chipsets and then Intel 865G Chipset Family Drivers.

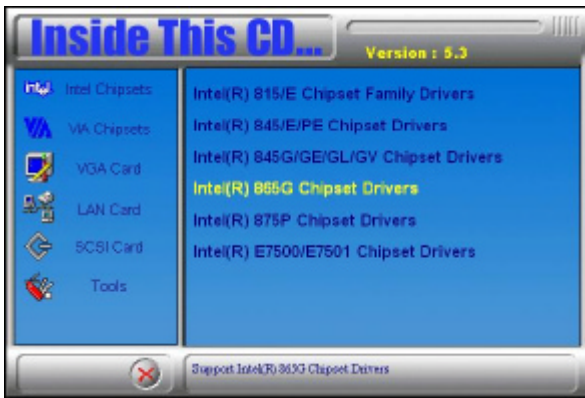

2. Click Intel 865G Chipset Software Intallation Utility.

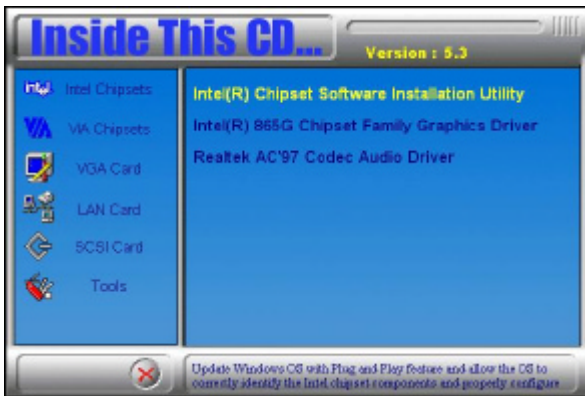

3. When the Welcome screen appears, click Next to continue.

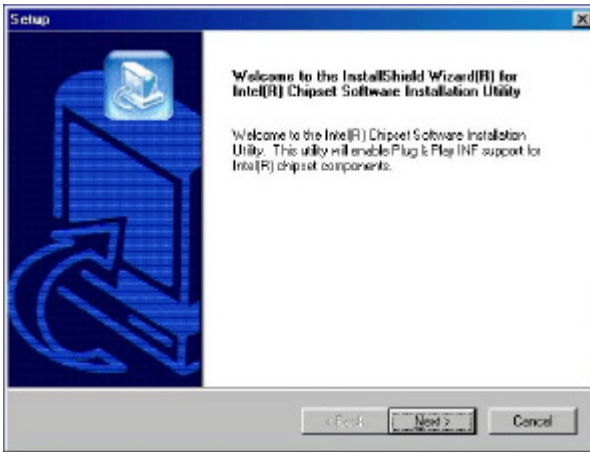

4. Click Yes to accept the software license agreement and proceed with the installation process.

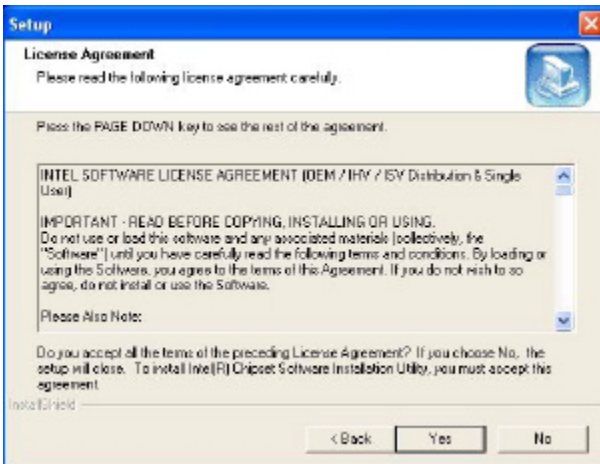

5. On Readme Information screen, click Next to continue the installation.

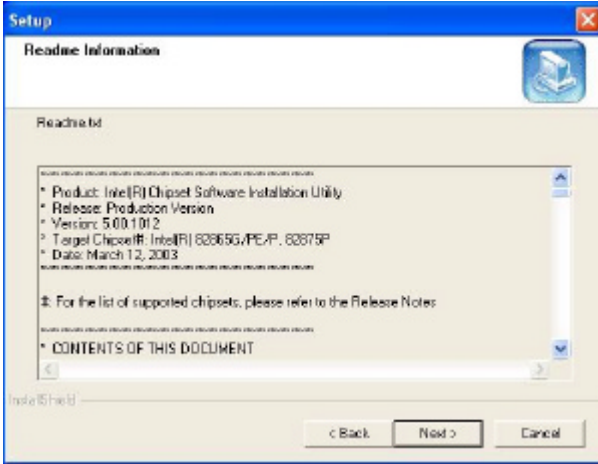

6. The Setup process is now complete. Click Finish to restart the computer and for changes to take effect. When the computer has restarted, the system will be able to find some devices. Restart your computer when prompted.

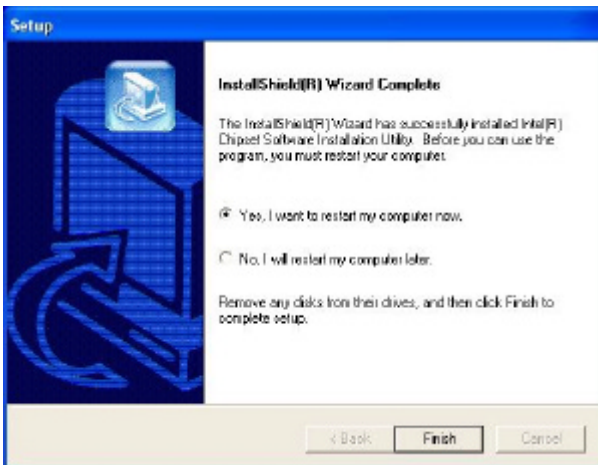

## Intel 865G Chipset Graphics Driver

The Intel 865G Chipset Family Graphics Drivers come in the CD with the CPU card . Follow the instructions below to complete the installation under Windows 98/98SE/ME/2000/XP.

1. Insert the CD that comes with the CPU card and the screen below would appear. Click Intel Chipsets and then Intel 865G Chipset Family Drivers.

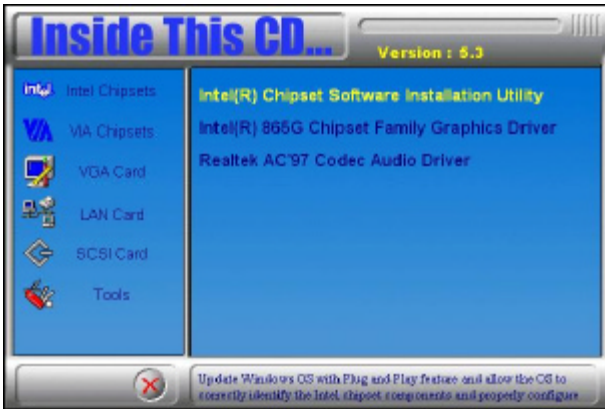

2. When the Welcome screen appears, click Next to continue.

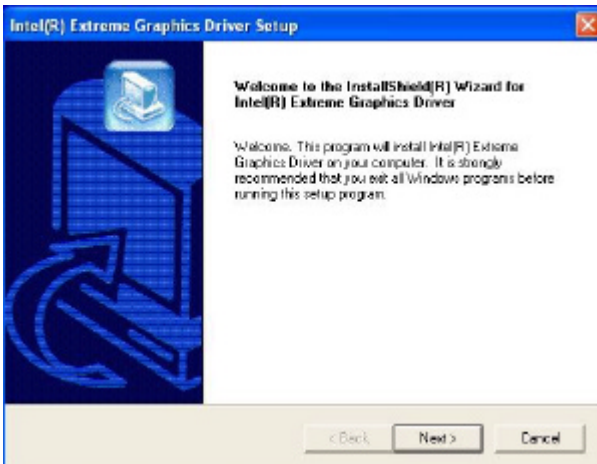

3. Click Yes to accept the software license agreement and proceed with the installation process.

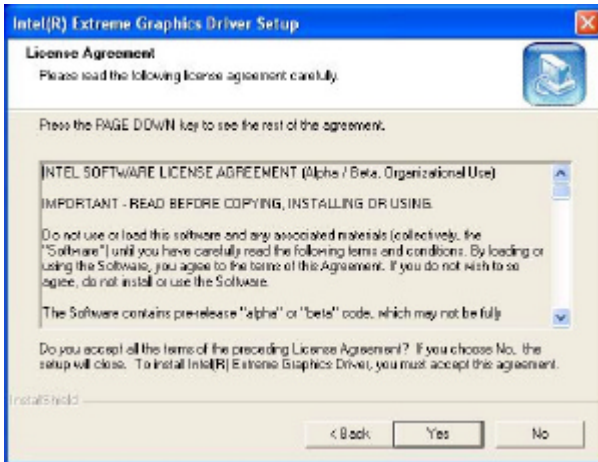

4. The Setup process is now complete. Click Finish to restart the computer and for changes to take effect. When the computer has restarted, the system will be able to find some devices. Restart your computer when prompted.

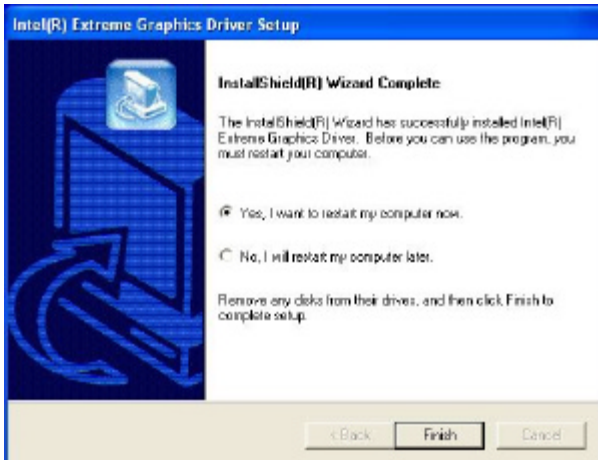

## Realtek AC97 Codec Audio Driver Installation

Follow the steps below to install the Realtek AC97 Codec Audio Drivers.

1. Insert the CD that comes with the CPU card and the screen below would appear. Click Intel Chipsets, then Intel 865G Chipset Family Drivers. Click Realtek AC97 Codec Audio Drivers to start installation.

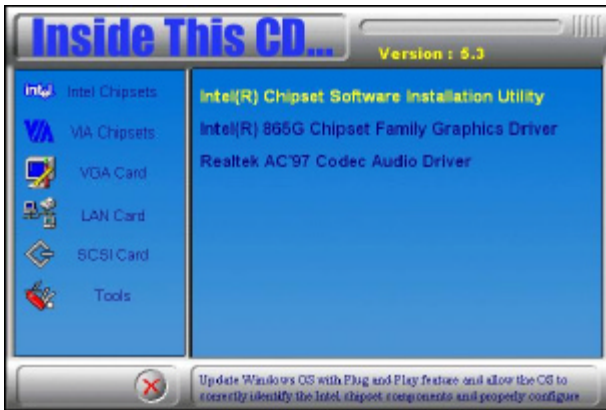

2. Click Finish to restart the computer and for changes to take effect. .

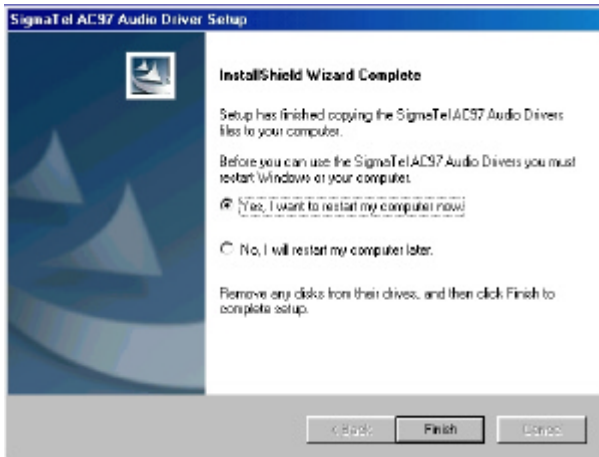

## Intel PRO LAN Drivers Installation

The Intel PRO LAN drivers support both Intel® PRO/100 and PRO/1000 drivers. Follow the steps below to complete the installation.

1. Insert the CD that comes with the CPU card and the screen below would appear. Click on LAN Card on the left side to make the LAN drivers selection. Click on Intel(R) PRO LAN Drivers.

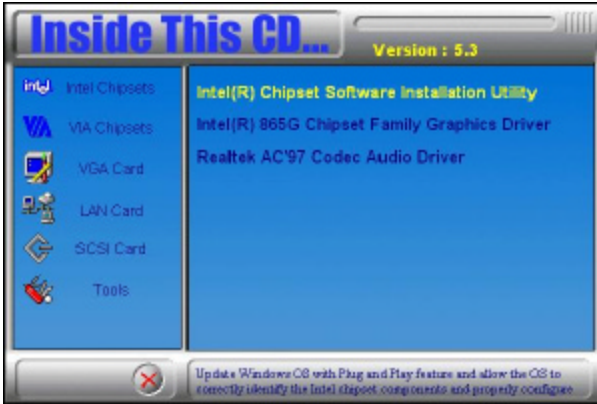

2. Click Install Now.

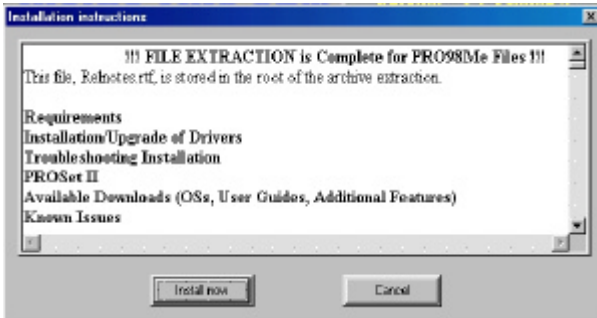

3. Click Restart to restart the computer and new settings to take effect.





## Free Manuals Download Website

<http://myh66.com>

<http://usermanuals.us>

<http://www.somanuals.com>

<http://www.4manuals.cc>

<http://www.manual-lib.com>

<http://www.404manual.com>

<http://www.luxmanual.com>

<http://aubethermostatmanual.com>

Golf course search by state

<http://golfingnear.com>

Email search by domain

<http://emailbydomain.com>

Auto manuals search

<http://auto.somanuals.com>

TV manuals search

<http://tv.somanuals.com>