

**32882**

***USER'S MANUAL***  
***Of***  
***Intel H55 Express Chipset***  
***Based***  
***M/B for Intel LGA 1156 Processors***

***NO. G03-HI06-F***

***Rev: 1.0***

**Release date: February, 2010**

**Trademark:**

\* Specifications and Information contained in this documentation are furnished for information use only, and are subject to change at any time without notice, and should not be construed as a commitment by manufacturer.

## Environmental Protection Announcement

Do not dispose this electronic device into the trash while discarding. To minimize pollution and ensure environment protection of mother earth, please recycle.



---

---

# TABLE OF CONTENT

---

---

ENVIROMENTAL SAFETY INSTRUCTION.....	iii
USER'S NOTICE .....	iv
MANUAL REVISION INFORMATION.....	iv
COOLING SOLUTIONS.....	iv
<b>CHAPTER 1 INTRODUCTION OF H55 EXPRESS CHIPSET MOTHERBOARDS</b>	
1-1 FEATURES OF MOTHERBOARD .....	1
1-1.1 SPECIAL FEATURES OF MOTHERBOARD .....	2
1-2 SPECIFICATION .....	4
1-3 PERFORMANCE LIST.....	5
1-4 LAYOUT DIAGRAM.....	6
<b>CHAPTER 2 HARDWARE INSTALLATION</b>	
2-1 HARDWARE INSTALLATION STEPS.....	8
2-2 CHECKING MOTHERBOARD'S JUMPER SETTING.....	8
2-3 INSTALLING CPU.....	10
2-3-1 GLOSSARY .....	10
2-3-2 ABOUT INTEL LGA 1156 CPU SOCKET .....	10
2-3-3 LGA 1156 CPU INSTALLATION GUIDE .....	11
2-3-4 INTEL REFERENCE THERMAL SOLUTION ASSEMBLY .....	12
2-4 INSTALL MEMORY .....	13
2-5 EXPANSION CARDS.....	14
2-5-1 PROCEDURE FOR EXPANSION CARD INSTALLATION .....	14
2-5-2 ASSIGNING IRQ FOR EXPANSION CARD .....	14
2-5-3 PCI-EXPRESS SLOT.....	15
2-5-4 INSTALLING THE CROSSFIRE/SLI BRIDGE CARD .....	16
2-6 CONNECTORS, HEADERS.....	17
2-6-1 CONNECTORS .....	17
2-6-2 HEADERS .....	20
2-7 STARTING UP YOUR COMPUTER .....	23
<b>CHAPTER 3 INTRODUCING BIOS</b>	
3-1 ENTERING SETUP .....	24
3-2 GETTING HELP .....	24
3-3 THE MAIN MENU.....	25
3-4 STANDARD BIOS FEATURES .....	26
3-5 ADVANCED BIOS FEATURES .....	27
3-5-1 CPU FEATURES .....	28
3-6 ADVANCED CHIPSET FEATURES .....	29
3-7 INTEGRATED PERIPHERALS.....	30
3-8 POWER MANAGEMENT SETUP.....	31
3-9 MISCELLANEOUS CONTROL.....	32
3-10 PC HEALTH STATUS.....	32
3-10-1 SMART FAN CONFIGURATION.....	33
3-11 USER OVERCLOCK SETTINGS.....	33
3-12 PASSWORD SETTINGS.....	35
3-13 LOAD OPTIMAL DEFAULTS/LOAD STANDARD DEFAULTS .....	35
3-14 SAVE CHANGES AND EXIT/ DISCARD CHANGES AND EXIT.....	36
<b>CHAPTER 4 DRIVER &amp; FREE PROGRAM INSTALLATION</b>	
MAGIC INSTALL SUPPORTS WINDOWS XP/VISTA/7 .....	37
4-1 INF    INSTALL INTELH55 CHIPSET SYSTEM DRIVER .....	38
4-2 SOUND  INSTALL ALC HD AUDIO CODEC DRIVER.....	39
4-3 REALTEK  INSTALL REALTEK GIGABIT ETHERNET NIC DRIVER.....	40
4-4 NORTON  INSTALL NORTON INTERNET SECURITY 2010 .....	41
4-5 PC-HEALTH  INSTALL MYGUARD HARDWARE MONITOR UTILITY .....	41
4-6 VGA    INSTALL INTEL HD VGA DRIVER .....	42
4-7 DOTNET  INSTALL DOTNET .....	43
4-8 IMSS    INSTALL IMSS .....	43
4-9 AHCI/RAID  INSTALL INTEL AHCI /RAID DRIVER.....	44
4-10 HOW TO UPDATE BIOS .....	45
4-11 PRO MAGIC PLUS FUNCTION INTRODUCTION .....	45
4-12 G.P.I.FUNCTION LED DISPLAY .....	47



## Environmental Safety Instruction

---

- Avoid the dusty, humidity and temperature extremes. Do not place the product in any area where it may become wet.
- 0 to 40 centigrade is the suitable temperature. (The figure comes from the request of the main chipset)
- Generally speaking, dramatic changes in temperature may lead to contact malfunction and crackles due to constant thermal expansion and contraction from the welding spots' that connect components and PCB. Computer should go through an adaptive phase before it boots when it is moved from a cold environment to a warmer one to avoid condensation phenomenon. These water drops attached on PCB or the surface of the components can bring about phenomena as minor as computer instability resulted from corrosion and oxidation from components and PCB or as major as short circuit that can burn the components. Suggest starting the computer until the temperature goes up.
- The increasing temperature of the capacitor may decrease the life of computer. Using the close case may decrease the life of other device because the higher temperature in the inner of the case.
- Attention to the heat sink when you over-clocking. The higher temperature may decrease the life of the device and burned the capacitor.

---

---

## USER'S NOTICE

COPYRIGHT OF THIS MANUAL BELONGS TO THE MANUFACTURER. NO PART OF THIS MANUAL, INCLUDING THE PRODUCTS AND SOFTWARES DESCRIBED IN IT MAY BE REPRODUCED, TRANSMITTED OR TRANSLATED INTO ANY LANGUAGE IN ANY FORM OR BY ANY MEANS WITHOUT WRITTEN PERMISSION OF THE MANUFACTURER.

THIS MANUAL CONTAINS ALL INFORMATION REQUIRED FOR THE UTILIZATION OF THESE MOTHER-BOARDS TO MEET THE USER'S REQUIREMENTS. BUT IT WILL CHANGE, CORRECT AT ANY TIME WITHOUT NOTICE. MANUFACTURER PROVIDES THIS MANUAL "AS IS" WITHOUT WARRANTY OF ANY KIND, AND WILL NOT BE LIABLE FOR ANY INDIRECT, SPECIAL, INCIDENTAL OR CONSEQUENTIAL DAMAGES (INCLUDING DAMAGES FOR LOSS OF PROFIT, LOSS OF BUSINESS, LOSS OF USE OF DATA, INTERRUPTION OF BUSINESS AND THE LIKE).

PRODUCTS AND CORPORATE NAMES APPEARING IN THIS MANUAL MAY OR MAY NOT BE REGISTERED TRADEMARKS OR COPYRIGHTS OF THEIR RESPECTIVE COMPANIES, AND THEY ARE USED ONLY FOR IDENTIFICATION OR EXPLANATION AND TO THE OWNER'S BENEFIT, WITHOUT INTENT TO INFRINGE.

## Manual Revision Information

Reversion	Revision History	Date
1.0	First Edition	February, 2010

## Item Checklist

- IntelH55 Express chipset based motherboard
- User's manual
- DVD for motherboard utilities
- SATA Cable
- I/O Back Panel Shield

## Intel Core Processor Family Cooling Solutions

As processor technology pushes to faster speeds and higher performance, thermal management becomes increasingly crucial while building computer systems. Maintaining the proper thermal environment is the key to reliable, long-term system operation. The overall goal in providing the proper thermal environment is keeping the processor below its specified maximum case temperature. Heat sinks induce improved processor heat dissipation through increased surface area and concentrated airflow from attached fans. In addition, interface materials allow effective transfers of heat from the processor to the heat sink. For optimum heat transfer, Intel recommends the use of thermal grease and mounting clips to attach the heat sink to the processor.

When selecting a thermal solution for your system, please refer to the website below for collection of heat sinks evaluated and recommended by Intel for use with Intel processors. Note, those heat sinks are recommended for maintaining the specified Maximum T case requirement. In addition, this collection is not intended to be a comprehensive listing of all heat sinks that support Intel processors.

---

---

# Chapter 1

## Introduction of H55 Express Chipset Motherboards

### 1-1 Features of Motherboard

The H55 Express chipset based motherboard series are based on Intel H55 Express chipset technology which supports the innovative Intel LGA 1156 socket Intel® Core™ i7 Quad Processor, Intel® Core™ i5 Quad Processor, Intel® Core™ i3 Dual Processor and Intel® Pentium Processor.

The H55 Express chipset based motherboard series deliver the revolutionary levels of performance enabling vivid, high-definition experiences and multi-tasking responsiveness from state-of-the-art Intel quad-core technologies, AMD CrossFire technology through the high bandwidth of 4 dual-channel DDRIII1066/DDRIII1333 MHz system memories which are expandable to 16 GB capacity and the new generation of PCI Express interface for the latest graphics AMD cards. The H55 Express chipset motherboard series are absolutely the ultimate solution for game enthusiasts and applications, and it also meets the demanding usage of computing of gaming, multimedia entertainment and business applications.

The motherboard provides six serial ATA2 interfaces of 3.0 Gb / s data transfer rate for six serial ATA devices.

The H55 Express chipset Based motherboard provides dual Gigabit LAN function by using Gigabit LAN chips which supports 10M / 100M / 1Gbps data transfer rate. Embedded 8-channel ALC888 HD CODEC is fully compatible with Sound Blaster Pro® standards that offer you with the home cinema quality and absolutely software compatibility.

The H55 Express chipset based motherboard series offer two PCI-Express2.0 x16 graphics slots with PE2 being PCI Express 2.0 x16@16 lane slot while PE3 being PCI Express 2.0 x16@4 lane slot. These two graphics slots are fully compatible with the latest AMD CrossFireX Technology to guarantee the fully operational Multi-GPUs graphics function and avoid the possible installation error. One PCI Express x1 I/O slot and two 32-bit PCI slots guarantee the rich connectivity for the I/O of peripherals. And the H55 motherboard is embedded with a mini-PCIE slot that supports WiFi card.

Embedded USB controllers as well as capability of expanding to 10 of USB2.0 functional ports delivering 480Mb/s bandwidth of rich connectivity, these motherboards meet the future USB demands which are also equipped with hardware monitor function on system to monitor and protect your system and maintain your non-stop business computing.

Some special features--- **CPU Smart Fan/ CPU Vcore 7-shift/ Debug Port/OC-CON / G.P.I. Function/3D Audio/DIY Clear/Power on Button/Reset Button** in this motherboard is designed for power user to use the over-clocking function in more flexible ways. But please be caution that the over-clocking may cause the failure in system reliability. This motherboard provides the guaranteed performance and meets

---

---

the demands of the next generation computing. But if you insist to gain more system performance with variety possibilities of the components you choose, please be careful and make sure to read the detailed descriptions of these value added product features, please get them in the coming section.

## 1-1.1 Special Features of motherboard

### **CPU Smart Fan**--- The Noise Management System

It's never been a good idea to gain the performance of your system by sacrificing its acoustics. CPU Smart Fan Noise Management System is the answer to control the noise level needed for now-a-day's high performance computing system. The system will automatically increase the fan speed when CPU operating loading is high, after the CPU is in normal operating condition, the system will low down the fan speed for the silent operating environment. The system can provide the much longer life cycle for both CPU and the system fans for game use and business requirements.

### **CPU Vcore 7-Shift**--- Shift to Higher Performance

The CPU voltage can be adjusted up by 7 stages for the precisely over-clocking of extra demanding computing performance.

### **Debug Port**--- The Professional Hardware Diagnosis System

Being bugged of abnormal system failure through the tossed and turned nights no more, the embedded Hardware Debug Port offers you the real-time visual system healthy for the demanding usage of computing. No more bugging by unknown system failure and no more time wasted in the first moment of 24-hour nonstop ping business computing, the embedded Debug Port will turn you into a well training hardware professional with the seeing system situation. (The Post Code please refer Appendix)

### **OC-CON** ---High-polymer Solid Electrolysis Aluminum Capacitors

The working temperature is from 55 degrees Centigrade below zero to 125 degrees Centigrade, OC-CON capacitors possess superior physical characteristics that can be while reducing the working temperature between 20 degrees Centigrade each time, intact extension 10 times of effective product operation lives, at not rising degrees Centigrade of working temperatures each time a relative one, life of product decline 10% only too.

### **G.P.I. Function**—Green power indicator function

The full name of G.P.I technology is Green Power Indicator technology, obviously technology utilized to low power consumption. G.P.I is a technology with remarkable power saving function.

### **3D Audio**—(3D Audio Sound Effect)

OP with two-stage Butterworth filter and quadruple noninverting amplifier enhances bass effect under the 100MHz range to perfect audio effect, brings you stunning shock experience in video game, true-to-life simulated feeling when watching films and the greatest touch as that in the concert. There is a 3D Audio button integrated on the board. Press down the button to enable 3D audio effect or press again to disabled it.

---

---

### **DIY Clear**

This CMOS Buttons (CMOS1) is to facilitate the clear COMS process for power user overclocking function. The user can easily clear or restore COMS settings by pressing down the button, without taking trouble to remove the case and locate the jumper for clear CMOS. ( Please remove or turn off the power supply before COMS clear )

### **Power on Button**

You can easily start the computer by pressing down this button for a few seconds, without troubling yourself to locate the front panel jumpers to find the Power on jumper.

### **Reset Button**

You can easily restart the computer by pressing down this button for a few seconds, without troubling yourself to locate the front panel jumpers to find the reset jumper.



## 1-2 Specification

Spec	Description
<b>Design</b>	<ul style="list-style-type: none"> <li>● ATX form factor 4 layers PCB size: 30.5x24.5cm</li> </ul>
<b>Chipset</b>	<ul style="list-style-type: none"> <li>● Intel H55 Express Chipset</li> </ul>
<b>CPU Socket</b>	<ul style="list-style-type: none"> <li>● Intel LGA 1156 socket Intel® Core™ i7 Quad Processor、 Intel® Core™ i5 Quad Processor、 Intel® Core™ i3 Dual Processor and Intel® Pentium Processor</li> </ul>
<b>Memory Sockets</b>	<ul style="list-style-type: none"> <li>● DDRIII module sockets x 4</li> <li>● Support 4pcs DDRIII 1066MHz/ DDRIII 1333 MHz memory modules expandable to 16GB.</li> <li>● Support Dual- channel function</li> </ul>
<b>Expansion Slots</b>	<ul style="list-style-type: none"> <li>● PCI-Express2.0 x16 slot 2pcs</li> <li>● PCI-Express2.0 x1 slot 1pcs</li> <li>● 32-bit PCI slot 2pcs</li> <li>● Mini PCI-Express 1pcs</li> </ul>
<b>Serial ATA2</b>	<ul style="list-style-type: none"> <li>● The Intel H55 chipset supports six internal Serial ATA ports for six SATA devices providing 3.0 Gb/sec data transfer rate</li> </ul>
<b>Gigabit LAN</b>	<ul style="list-style-type: none"> <li>● Integrated Realtek RTL8111DL PCI-E Gigabit LAN chip</li> <li>● Supports Fast Ethernet LAN function provide 10Mb/100Mb/1Gb /s data transfer rate</li> </ul>
<b>8-CH HD Audio</b>	<ul style="list-style-type: none"> <li>● Realtek ALC888 Azalia 8-channel HD Audio Codec integrated</li> <li>● Support 8-channel 3D surround &amp; Positioning Audio</li> <li>● Audio driver and utility included</li> </ul>
<b>BIOS</b>	<ul style="list-style-type: none"> <li>● AMI 32MB SMT Flash ROM</li> </ul>
<b>Multi I/O</b>	<ul style="list-style-type: none"> <li>● PS/2 keyboard connector x1</li> <li>● PS/2 Mouse connector x1</li> <li>● HDMI connector x1</li> <li>● VGA connector x1/DV I connector x1</li> <li>● Coaxial S/PDIF Out connector x1</li> <li>● ESATA connector x1 /SATA connectors x6</li> <li>● USB2.0 port x4 and headers x3</li> <li>● RJ-45 LAN connector x1</li> <li>● Audio connector x1 (8-CH Audio)</li> <li>● Serial Port header x1</li> <li>● HDMI-SPDIF header x1</li> <li>● IR header x 1</li> <li>● CDIN header x1</li> <li>● FP__AUDIO header x1</li> </ul>

## 1-3 Performance List

The following performance data list is the testing result of some popular benchmark testing programs. These data are just referred by users, and there is no responsibility for different testing data values gotten by users (the different Hardware & Software configuration will result in different benchmark testing results.)

Test Environment				
CPU	I3 540		VGA DRIVER	
BIOS	T03		MEMORY	Apacer 2G1333
VGA	onboard VGA			
HDD	WesternDigital 160GB SATA			
3DMark Vantage		4344		
3D Mark 2006		1393		
3D Mark 2005		2955		
AQUAMRK3				
PCMark2005				
System / CPU / Memory		6159	8519	5157
Graph / HDD		3227	5421	
Content Creation Winstone 2004		54.5		
Business Winstone 2004		33.5		
Winbench 99 V2.0:				
Business/Hi-end Disk Winmark99		21700		
Business/Hi-end Graphic Winmark				
SysMark 2004: SISMark Rating(Internet Content Creation / Office Productivity )				
SvSMARK 2004		309		
3D Creation / 2D Creation		550	683	
/ Web publication		474		
Communication / Document Creation		183	400	
/ Data Analysis		343		
SiSOFT Sandra 2005 : 1.CPU Arithmetic Benchmark 2.Memory bandwidth Benchmark				
3.CPU Multi-Media Benchmark				
1.Dhrystone ALU	MIPS	45.21		
Whetstone FPU iSSE2	FLOPS	32.02		
2.Int/Float Buffered iSSE2	MB/S	37.88		
3.Integer/Floating-Point SSE2	IT/S	9.26		
UT2003 Benchmark				189.550140
Quake3 DEMO1 / DEMO2	FPS	289.2	291.6	
Return to Castle <b>Wolfenstein</b>	FPS			
Super Pi (1M)	Second	13.369s		
CPUZ System / CPU Clock				

# 1-4 Layout Diagram

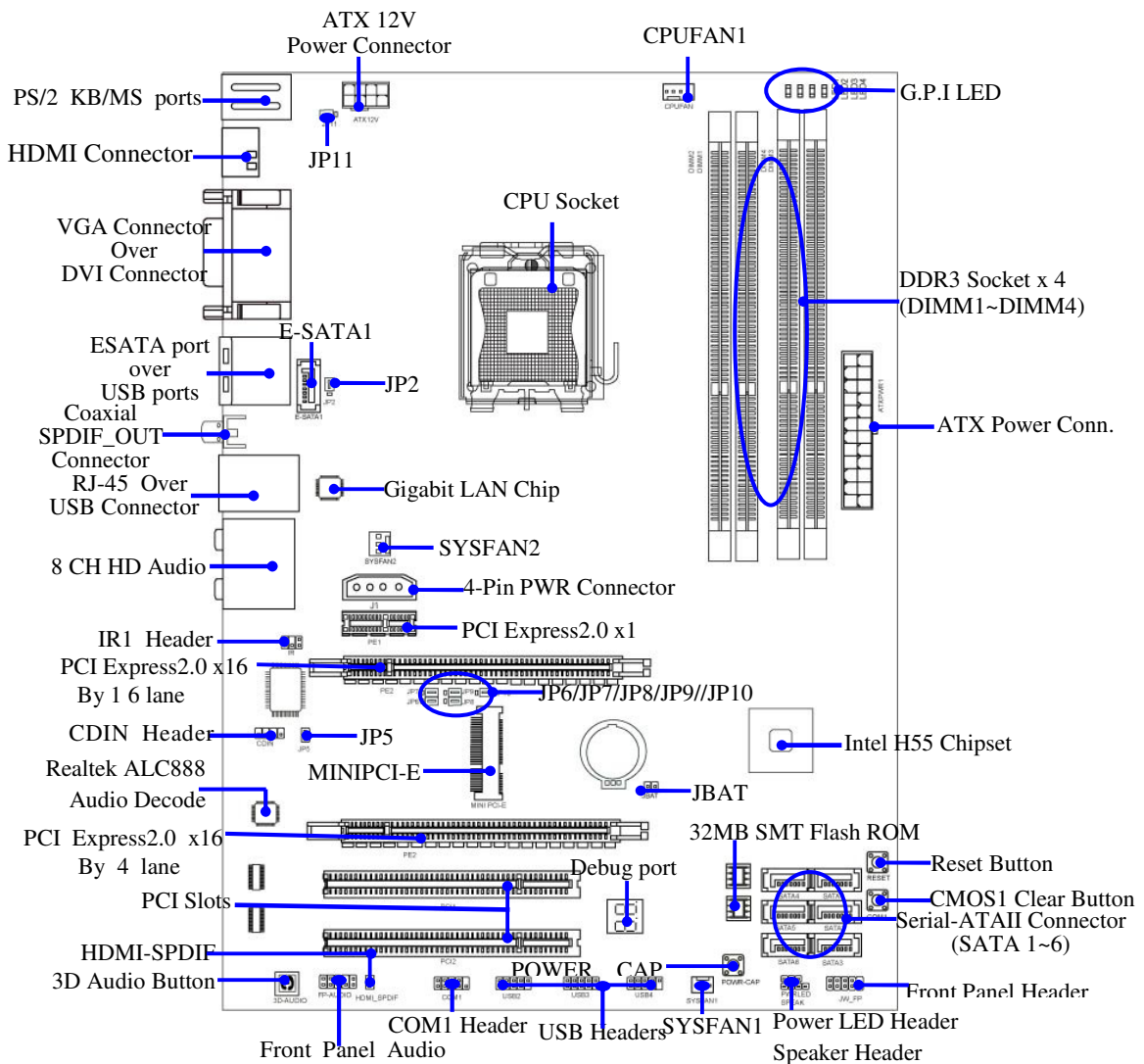
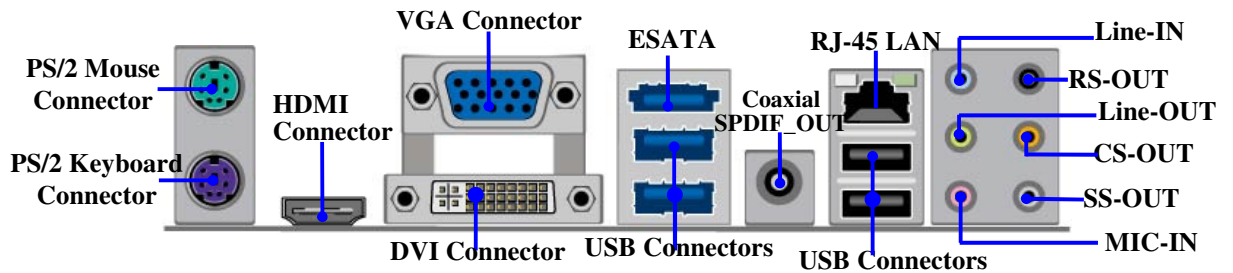

## Jumpers

Jumper	Name	Description
JBAT	CMOS RAM Clear	2-pin Block
JP11	KB/MS Power On Enabled/Disabled	3-pin Block
JP2	USB Power On Enabled/Disabled	3-pin Block
JP6/JP7/JP8/JP9	PE1/MINIPCI-E select	3-pin Block
JP10	MINIPCI-E 3VSB/VCC3 select	3-pin Block

## Sockets and Slots

Socket/Slot	Name	Description
CPU Socket	LGA 1156 CPU Socket	LGA 1156 CPU Socket
DIMM1~DIMM4	DDRIII Module Sockets	240-pin DDRIII Module Sockets
PCI1,PC2	PCI Slots	32-bit PCI Local Bus Expansion slots
PE1	PCI-Express2.0 x 1 Slot	PCI-Express2.0 x 1 Expansion Slots
PE2,PE3	PCI-Express 2.0x 16 Slots	PCI-Express2.0 x16 Expansion Slots

## Connectors

Connector	Name	Description
ATXPWR	ATX Power Connector	24-pin Block
ATX12V	ATX 12V Power Connector	8-pin Block
J1	Large 4-pin Power Connector	4-pin Block
KB1	PS/2 Keyboard/Mouse Connector	6-pin Female
VGA	D-Sub Connector	15-pin Connector
DVI	Digital Visual Interface	24-pin Connector
HDMI	High-Definition Multimedia	19-pin Connector
USB from UL1 and CN2	USB 2.0 Port Connectors	4-pin Connector
RJ45 LAN from UL1	RJ-45 LAN Port Over USB Connectors.	8-pin Connector
AUDIO	8-CH Audio Connector	6 phone jack
SATA~SATA6	Serial ATA2 Connector	7-pin Connector
E-SATA from CN1	External Serial ATA2 Connectors	7-pin Connector
SPDIF_Out	Coaxial S/PDIF Out Connector	1-pin Connector

## Headers

Header	Name	Description
FP_AUDIO	SPEAKER, MIC header	9-pin Block
USB2,USB3, USB4	USB Port Headers	9-pin Block
SPEAK	PC Speaker header	4-pin Block
PWR LED	Power LED header	3-pin Block
JW_FP(PWR LED/Reset/ HD LED/PWR BTN)	Front Panel Header (including Power LED/ IDE activity LED/Reset switch / Power On Button lead)	9-pin Block
CPUFAN1	CPUFAN Header	4-pin Block
SYSFAN1, SYSFAN2	System FAN Headers	3-pin Block
CDIN	CD Audio-In Header	4-pin Block
IR1	IR Header	5-pin Block
COM1	Serial Port Header	9-pin Block
HDMI-SPDIF	SPDIF-Out header	2-pin Block

---

---

# Chapter 2

## Hardware Installation

**WARNING!** Turn off your power when adding or removing expansion cards or other system components. Failure to do so may cause severe damage to both your motherboard and expansion cards.

### 2-1 Hardware installation Steps

Before using your computer, you had better complete the following steps:

1. Check motherboard jumper setting
2. Install CPU and Fan
3. Install System Memory (DIMM)
4. Install Expansion cards
5. Connect IDE Front Panel /Back Panel cable
6. Connect ATX Power cable
7. Power-On and Load Standard Default
8. Reboot
9. Install Operating System
10. Install Driver and Utility

### 2-2 Checking Motherboard's Jumper Setting

#### (1) CMOS RAM Clear (2-pin): JBAT

A battery must be used to retain the motherboard configuration in CMOS RAM, short 1-2 pins of JBAT to clear the CMOS data.

To clear the CMOS, follow the procedure below:

1. Turn off the system and unplug the AC power
2. Remove ATX power cable from ATX power connector
3. Locate JBAT and short pins 1-2 for a few seconds, if shorted with the jump cap, short for a few seconds then pull out the hat.
4. Connect ATX power cable back to ATX power connector

#### **Note: When should clear CMOS**

1. **Troubleshooting**
2. **Forget password**
3. **After over clocking system boot fail**

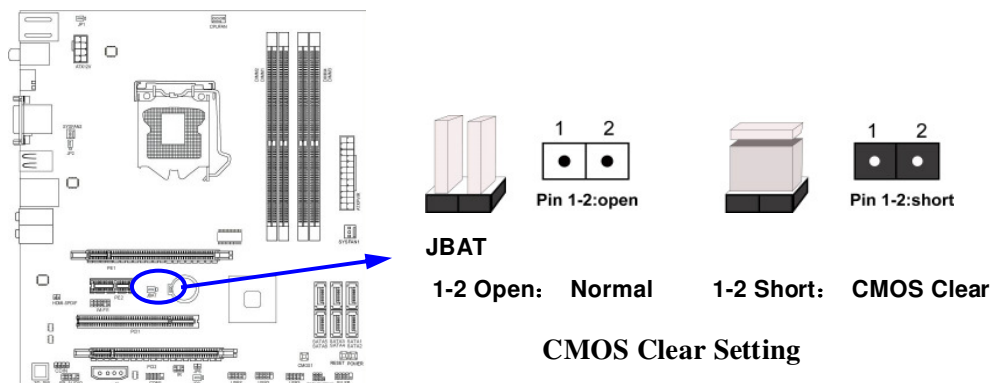

**(2) KB/MS Power on Function Enabled/Disabled: JP11**

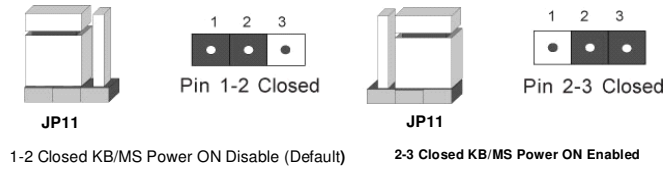
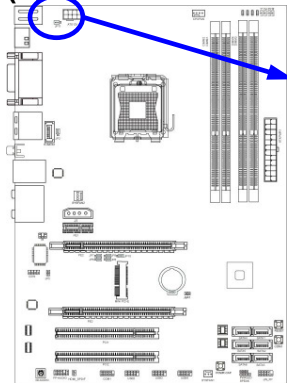

1-2 Closed KB/MS Power ON Disable (Default)      2-3 Closed KB/MS Power ON Enabled

**Keyboard/Mouse Power On Setting**

**(3) USB Power On function Enabled/Disabled: JP2**

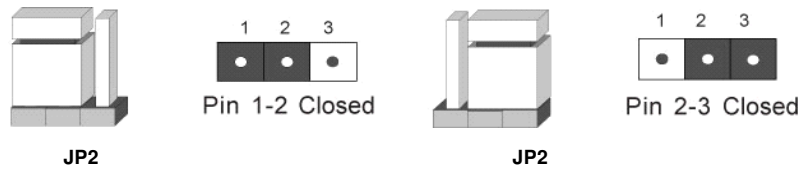
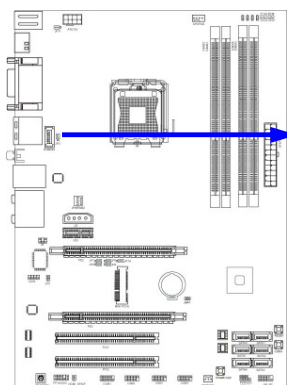

1-2 closed USB Power On Disable (Default)      2-3 closed USB Power On Enabled

**USB Power-On Setting**

**(4) MINIPCI-E 3VSB/VCC3 Select: JP10**

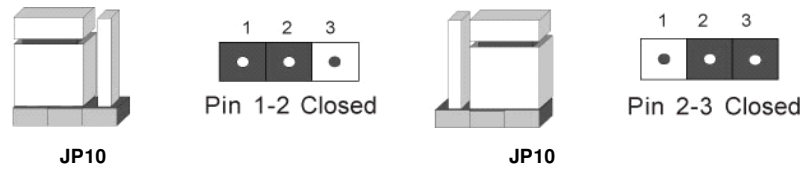
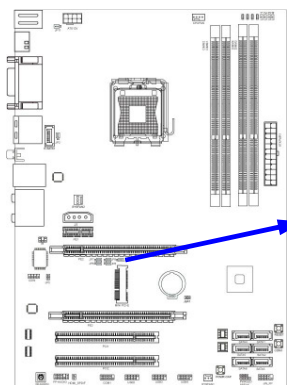

1-2 Close 3VSB      2-3 Close VCC3

**(5) PE1/MINIPCI-E Select : JP6/JP7/JP8/JP9**

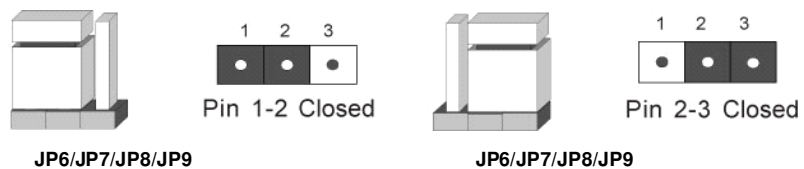
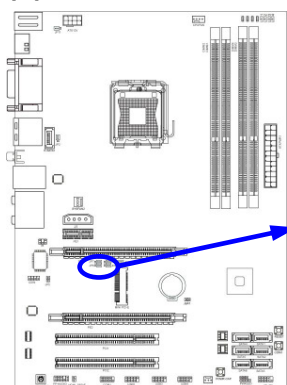

1-2 Close (all): PE1      2-3 Close (all): MINIPCI-E

---

---

## 2-3 Installing CPU

### 2-3-1 Glossary

**Chipset (or core logic)** - two or more integrated circuits which control the interfaces between the system processor, RAM, I/O devices, and adapter cards.

**Processor slot/socket** - the slot or socket used to mount the system processor on the motherboard.

**Slot (PCI-E, PCI, RAM)** - the slots used to mount adapter cards and system RAM.

**PCI** - **P**eripheral **C**omponent **I**nterconnect - a high speed interface for video cards, sound cards, network interface cards, and modems; runs at 33MHz.

**PCI Express2.0**- Peripheral Component Interconnect Express2.0, developed in 2003, the speed of each line doubled from the previous PCI-E of 2.5Gbps to 5 Gbps.

**Serial Port** - a low speed interface typically used for mouse and external modems.

**Parallel Port** - a low speed interface typically used for printers.

**PS/2** - a low speed interface used for mouse and keyboards.

**USB** - **U**niversal **S**erial **B**us - a medium speed interface typically used for mouse, keyboards, scanners, and some digital cameras.

**Sound** (interface) - the interface between the sound card or integrated sound connectors and speakers, MIC, game controllers, and MIDI sound devices.

**LAN** (interface) - **L**ocal **A**rea **N**etwork - the interface to your local area network.

**BIOS** (**B**asic **I**nput/**O**utput **S**ystem) - the program logic used to boot up a computer and establish the relationship between the various components.

**Driver** - software, which defines the characteristics of a device for use by another device or other software.

**Processor** - the "central processing unit" (CPU); the principal integrated circuit used for doing the "computing" in "personal computer"

**Front Side Bus Frequency** - the working frequency of the motherboard, which is generated by the clock generator for CPU, DRAM and PCI BUS.

**CPU L2 Cache** - the flash memory inside the CPU, normal it depend on CPU type.

### 2-3-2 About Intel LGA 1156 CPU Socket

This motherboard provides an 1156-pin DIP, LGA 1156 Land Grid Array socket, referred to as the LGA 1156 socket.

The CPU that comes with the motherboard should have a cooling FAN attached to prevent overheating. If this is not the case, then purchase a correct cooling FAN before you turn on your system.

<b>NOTED!</b>	Be sure that there is sufficient air circulation across the processor's heat sink and CPU cooling FAN is working correctly, otherwise it may cause the processor and motherboard overheat and damage, you may install an auxiliary cooling FAN, if necessary.
---------------	---

To install a CPU, first turn off your system and remove its cover. Locate the LGA 1156 socket and open it by first pulling the level sideways away from the socket then upward to a 135-degree angle. Insert the CPU with the correct orientation as shown below. The notched corner should point toward the end of the level. Because the CPU



---

---

has a corner pin for two of the four corners, the CPU will only fit in the orientation as shown.

When you install the CPU into the LGA 1156 socket, there's no force required CPU insertion; then press the level to locate position slightly without any extra force.

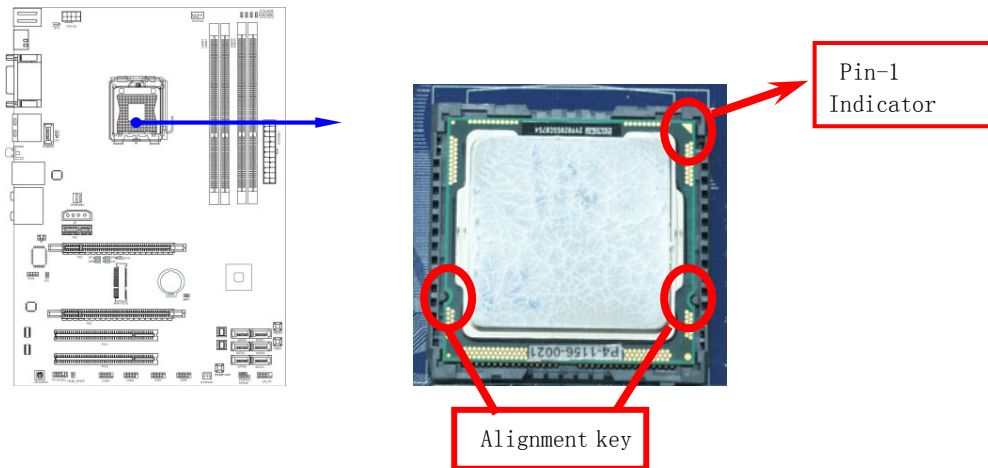

### 2-3-3 LGA 1156 CPU Installation Guide

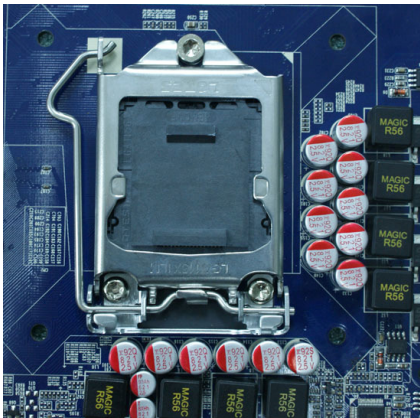

1. Please make sure that CPU socket is facing towards you and the level is on you left hand side.

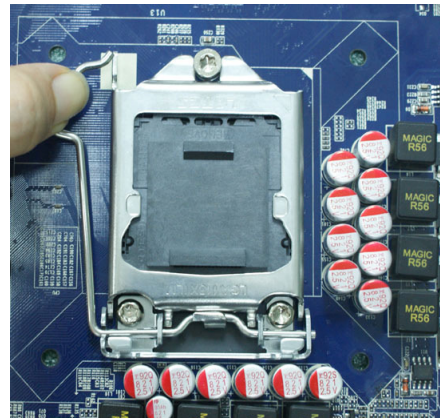

2. Press down the level and move it to the left side to make sure it is freed from the hook and then open it upwards about 135 degree.

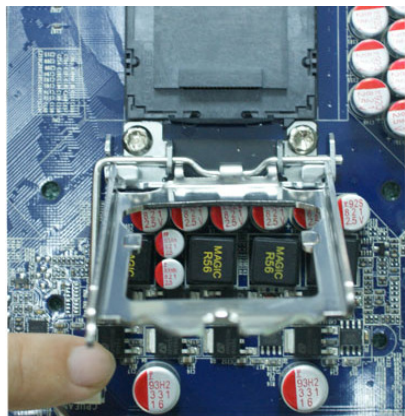

3. Open the level upwards about 135 degree and the metal protection plate will be pulled up at the same time.

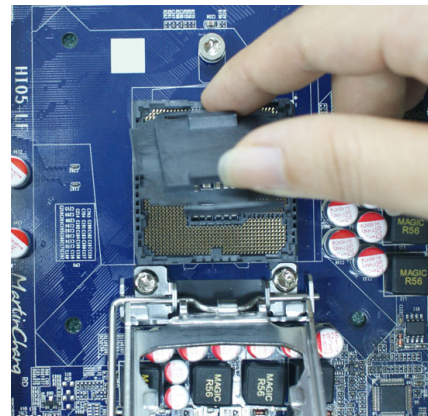

4. Remove the plastic protective cap from the socket. (Put it to the original place if CPU is not installed. Do not touch the metal contact point of



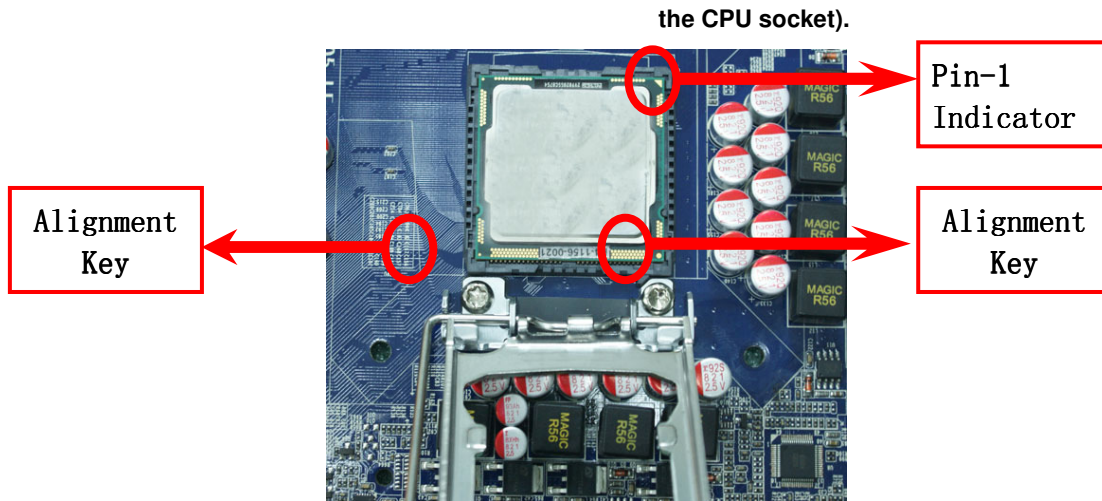

5. Make sure that golden finger in the right place as shown in the above illustration and match the two alignment keys on the CPU with two points of the socket. CPU can only be correctly installed with this direction. Incorrect installation might cause damage to CPU.

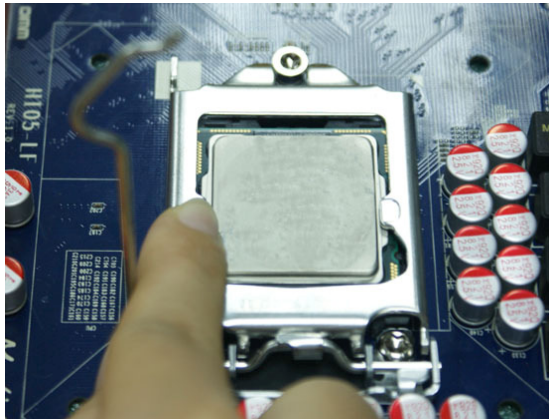

6. Put down the load plate in the direction shown above.

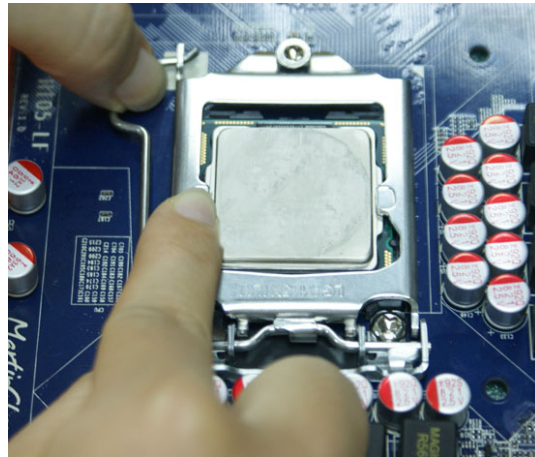

7. Press down the load level and move it rightwards make sure it is locked under the notch.

## 2-3-4 Intel Reference Thermal Solution Assembly

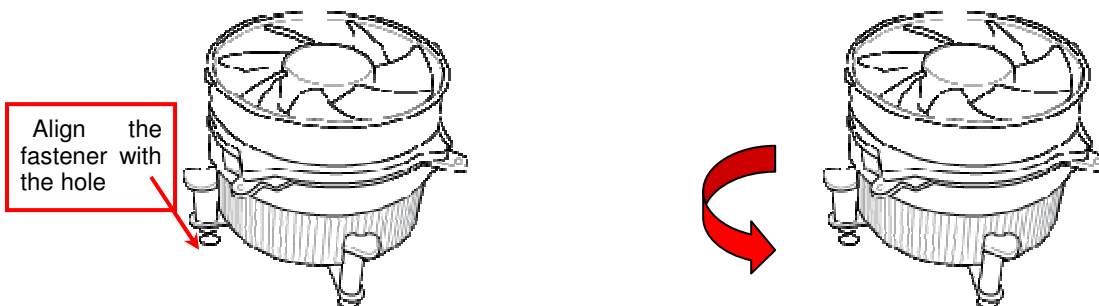

1. Put the heat sink vertically above the CP-installed socket and make sure to align the four fasteners with four holes around the socket.
2. Revolve the four fasteners in the counter-clockwise direction.

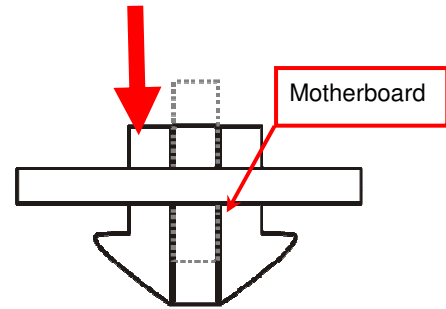
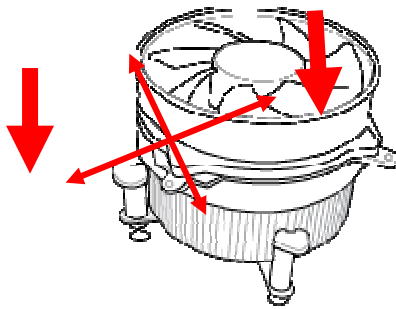

3. Press down two fasteners down in the oblique crossing direction as shown above.
4. Turn over the motherboard carefully to make sure the fastener insert in the right direction.

**Notice :**

- ▶ Please apply thermal interface material to the CPU HIS surface.
- ▶ The heat sink and installation steps are for reference use only; Installation steps might differ depending on different heat sink models.
- ▶ Please use Intel original heat sink for better heat dissipation or other heat sinks that has pass Intel certification.

## 2-4 Install Memory

This motherboard provides four 240-pin DDR III DUAL INLINE MEMORY MODULES (DIMM) socket for DDR III memory expansion available to maximum memory volume of 16GB DDRIII SDRAM.

### Valid Memory Configurations

Bank	240-Pin DIMM	PCS	Maximum Capacity
DIMM1	DDR III 1066/ DDR III1333	X1	4GB
DIMM2	DDR III 1066/ DDR III1333	X1	4GB
DIMM3	DDR III 1066/ DDR III1333	X1	4GB
DIMM4	DDR III 1066/ DDR III1333	X1	4GB
Total	System Memory (Max4GB)	4	16GB

### **Recommend DIMM Module Combination:**

1. One DDRIII Memory Module ----Plug in DIMMM1.
2. Two DDRIII Memory Modules---Plug in DIMM1 & DIMM 3 for Dual channel function
3. Four DDRIII Memory Modules---Plug in DIMM1 & DIMM 2 & DIMM3 & DIMM4

### **Dual channel Limited!**

1. Dual channel function only supports when 2 DIMM Modules plug in either both DIMM1 & DIMM3, or four DIMM Modules plug in DIMM1~DIMM4.
2. Memory modules plugged in the same color DIMM must be of the same type, same size, and same frequency for dual channel function.

Install DDR SDRAM modules to your motherboard is not difficult, you can refer to figure below to see how to install DDRIII 1066/DDRIII 1333 SDRAM module.

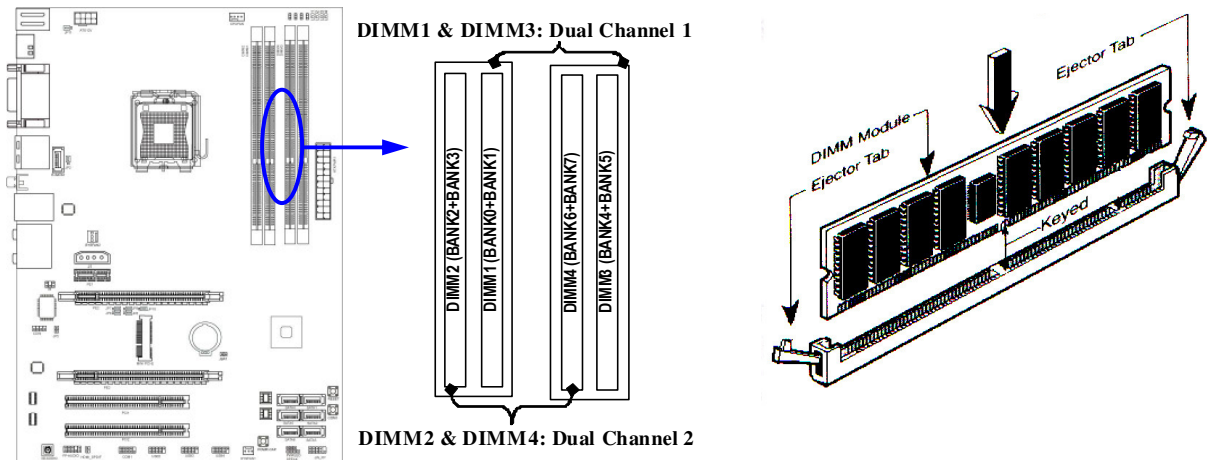

Graph 2-4

### Installation Tips:

- ▶ Open the two plastic clips of memory slots then push down the module vertically into the slot. See to it that the hole of the module fit into the notch of the slot.
- ▶ The two plastic clips will automatically close if the memory module is fitted in a proper way.
- ▶ We suggest that priority given to DIMM1 and DIMM3 in multi-DIMM installation. System won't start when you only install memory DIMM in DIMM2 and DIMM4.

## 2-5 Expansion Cards

### 2-5-1 Procedure For Expansion Card Installation

1. Read the documentation for your expansion card and make any necessary hardware or software setting for your expansion card such as jumpers.
2. Remove your computer's cover and the bracket plate on the slot you intend to use.
3. Align the card's connectors and press firmly.
4. Secure the card on the slot with the screen you remove above.
5. Replace the computer system's cover.
6. Set up the BIOS if necessary.
7. Install the necessary software driver for your expansion card.

### 2-5-2 Assigning IRQs for Expansion Card

Some expansion cards need to set up the IRQ to operate. An IRQ must be assigned exclusively to single interface use only. There are 16 IRQs available but most of them are already being used.

### Standard Interrupt Assignments

IRQ	Priority	Standard function
0	N/A	System Timer
1	N/A	Keyboard Controller
2	N/A	Programmable Interrupt
3 *	8	Communications Port (COM2)

4 *	9	Communications Port (COM1)
5 *	6	Sound Card (sometimes LPT2)
6 *	11	Floppy Disk Controller
7 *	7	Printer Port (LPT1)
8	N/A	System CMOS/Real Time Clock
9 *	10	ACPI Mode when enabled
10 *	3	IRQ Holder for PCI Steering
11 *	2	IRQ Holder for PCI Steering
12 *	4	PS/2 Compatible Mouse Port
13	N/A	Numeric Data Processor
14 *	5	Primary IDE Channel
15 *	1	Secondary IDE Channel

\* These IRQs are usually available for ISA or PCI devices.

### 2-5-3 PCI Express Slot

The H55 Express chipset based motherboard series offer two PCI-Express2.0 x16 graphics slots with PE2 being PCI Express 2.0 x16@16 lane slot while PE3 being PCI Express 2.0 x16@4 lane slot. These two graphics slots are fully compatible with the latest AMD CrossFireX Technology to guarantee the fully operational Multi-GPUs graphics function and avoid the possible installation error. One PCI Express x1 I/O slot and two 32-bit PCI slots guarantee the rich connectivity for the I/O of peripherals. And the H55 motherboard is embedded with a mini-PCIE slot that supports WiFi card.

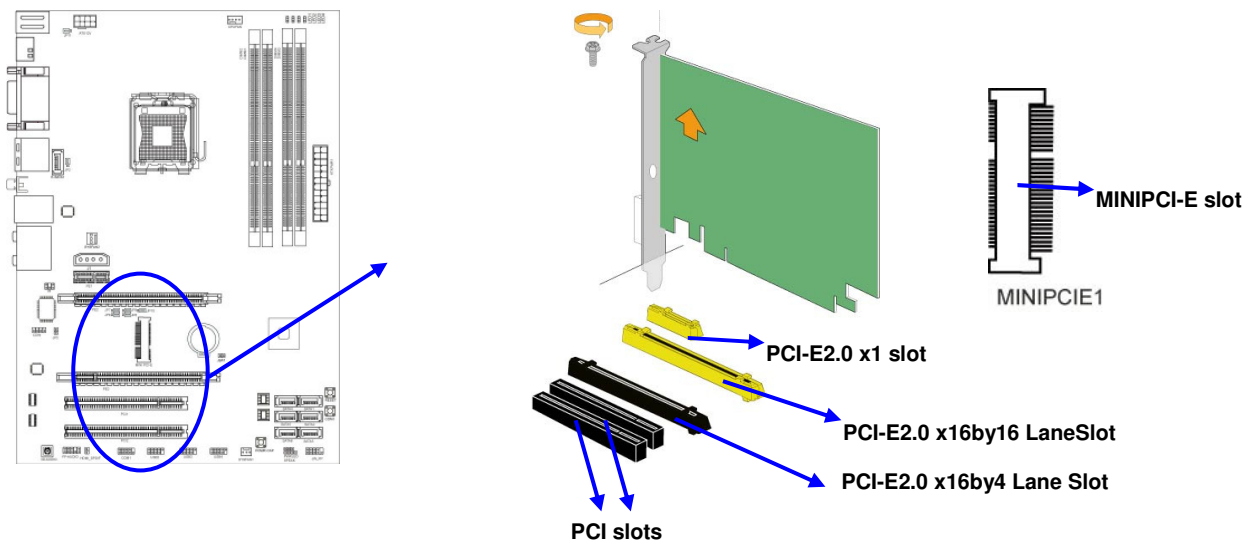



---

---

## 2-5-4 Installing the CrossFire Bridge Card

The following illustrations show you how to install the CrossFire Bridge Card.

In order to activate the CrossFire technology, you have to install the optional Bridge for your CrossFire Tech. Supported VGA Cards before you activating the advance multi-GPUs functions.

### CrissFire Bridge Installation Reference

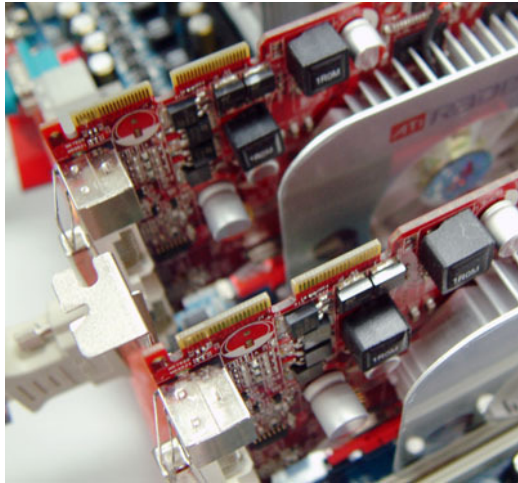

1. Install your CrossFire Tech Supported VGA Cards in the PCI-E x16 slots.

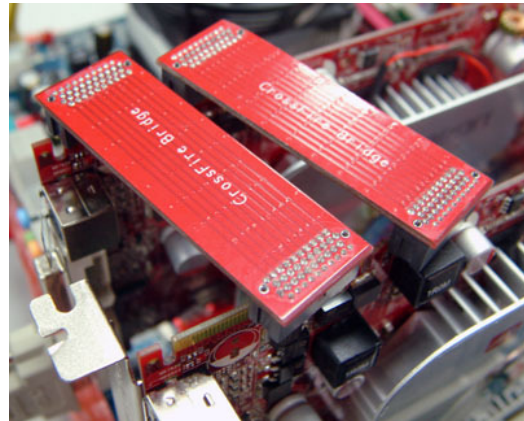

2. Prepare with the CF Bridges with your crossFire Tech Supported VGA Cards.

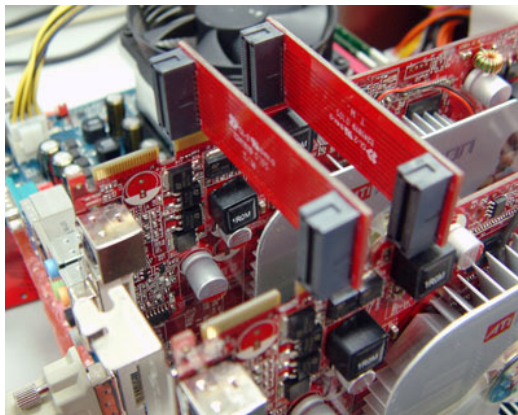

3. Be careful with the position for the pin you would like to set up.

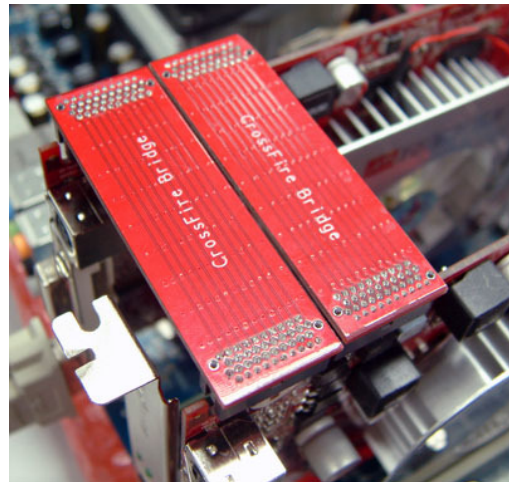

4. Keep straight to force the CF Bridges plug into both sides of CrossFire Tech Supported VGA Cards.

#### Notice!

- ▶ The motherboard and graphics card illustrations are for reference use only.
- ▶ We suggest that you install graphics cards in PE2 and PE3 slot for better CrossFire performance.

## 2-6 Connectors, Headers

### 2-6-1 Connectors

#### (1) Power Connector (24-pin block): ATXPWR

ATX Power Supply connector: This is a new defined 24-pins connector that usually comes with ATX case. The ATX Power Supply allows using soft power on momentary switch that connect from the front panel switch to 2-pins Power On jumper pole on the motherboard. When the power switch on the back of the ATX power supply turned on, the full power will not come into the system board until the front panel switch is momentarily pressed. Press this switch again will turn off the power to the system board.

- \*\* We recommend that you use an ATX 12V Specification 2.0-compliant power supply unit (PSU) with a minimum of 350W power rating. This type has 24-pin and 4-pin power plugs.
- \*\* If you intend to use a PSU with 20-pin and 4-pin power plugs, make sure that the 20-pin power plug can provide at least 15A on +12V and the power supply unit has a minimum power rating of 350W. The system may become unstable or may not boot up if the power is inadequate.

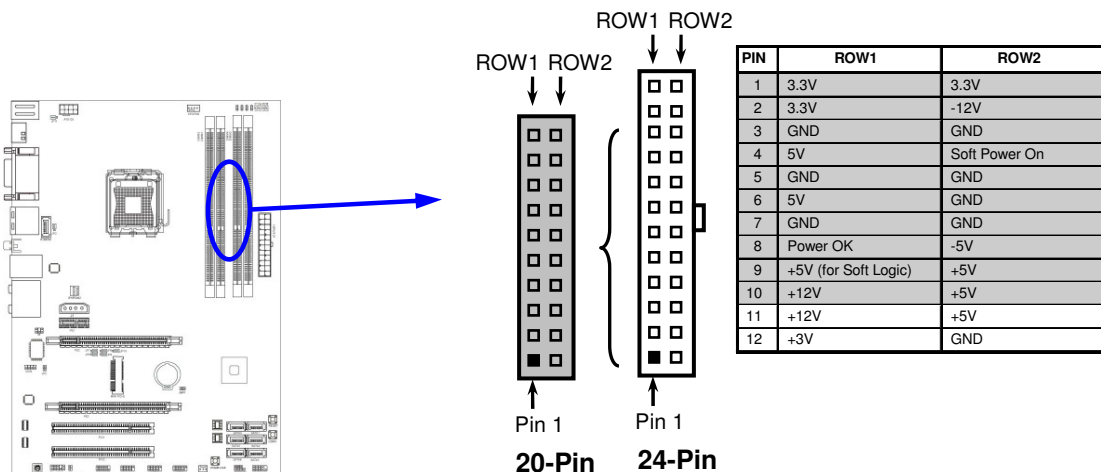

- \*\* If you are using a 20-pin power plug, please refer to Figure1 for power supply connection. Power plug form power supply and power connectors from motherboard both adopt key design to avoid mistake installation. You can insert the power plug into the connector with ease only in the right direction. If the direction is wrong it is hard to fit in and if you make the connection by force it is possible.

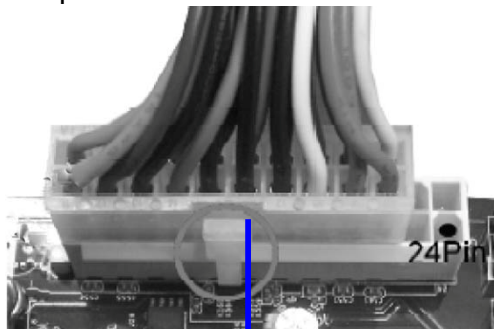

Figure1: 20-pin power plug

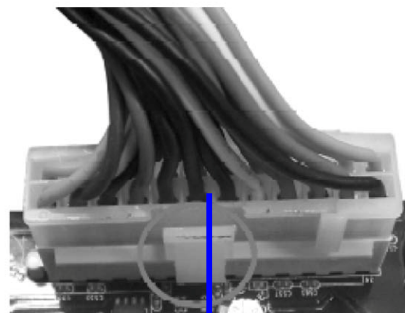

Figure 2: 24-pin power plug

---

---

(2) **ATX 12V Power Connector (8-pin block) : ATX12V**

This is a new defined 8-pin connector that usually comes with ATX Power Supply. The ATX Power Supply which fully supports LGA 1156 processor must including this connector for support extra 12V voltage to maintain system power consumption. Without this connector might cause system unstable because the power supply can not provide sufficient current for system.

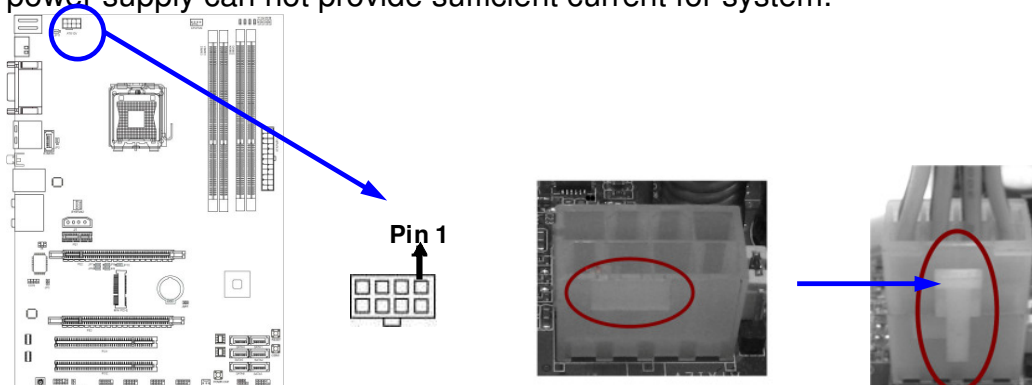

(3) **Large 4-Pin Power Connector: J1**

The connectors are 4-pin connector that supports extra 12V / 5V power to your system

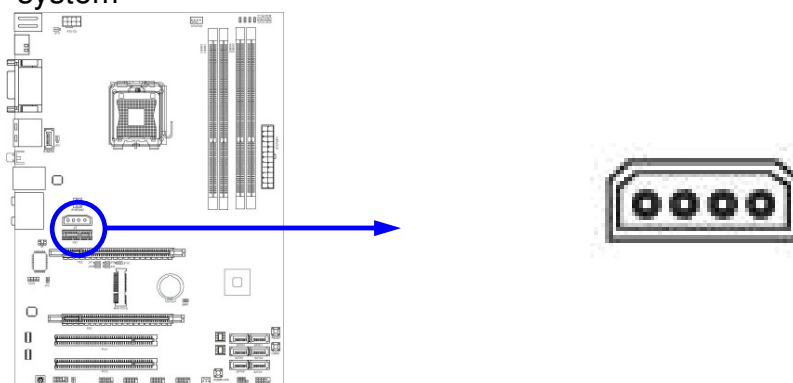

(4) **PS/2 Keyboard /Mouse Connectors: KB1**

The connectors are for PS/2 keyboard input devices.

(5) **USB Port connector: USB post from CN1 and UL1**

The connectors are 4-pin connectors that connect USB devices with the 480 Mbit / sec data transfer rate to the system board.

(6) **LAN Port connector: RJ-45 LAN ports from UL1**

This connector is standard RJ45 over USB connectors for Network connection. The connector supports 10MB/100MB/1G B/s data transfer rate

(7) **Audio Line-In, Lin-Out, MIC, RS-Out, CS-Out , SS-Out connector: AUDIO**

These Connectors are 6 Phone-Jack for LINE-OUT, LINE-IN, MIC, RS-Out, CS-Out , SS-Out audio connections.

<b>Line-in: (BLUE)</b>	Audio input to sound chip
<b>Line-out: (GREEN)</b>	Audio output to speaker
<b>MIC: (PINK)</b>	Microphone Connector
<b>RS-OUT: (BLACK)</b>	Rear-Surround audio output
<b>CS-OUT: (ORANGE)</b>	Center/ Subwoofer audio output

---

---

**SS-OUT: (GRAY)**

Side-Surround audio output

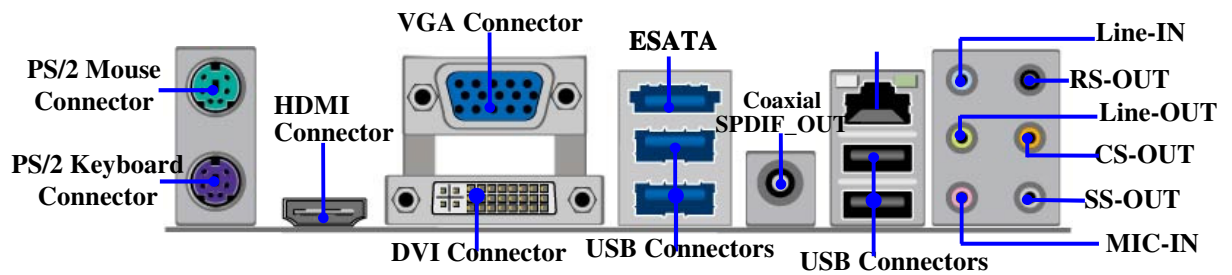

**(8) Serial-ATA2 Port connectors: SATA1~SATA6**

These connectors support the provided Serial ATA and Serial ATA2 IDE hard disk cable to connect the motherboard and serial ATA2 hard disk drives.



**(9) ESATA Port: ESATA ports from CN1**

This ESATA support the External Serial ATA2 (e-SATA) to enable the full SATA interface speed outside the chassis.

**(10) SPDIF Out connectors: SPDIF\_OUT**

The SPDIF output is capable of providing digital audio to external speakers or compressed AC3 data to an external Dolby digital decoder. Use this feature only when your stereo system has digital input function. SPDIF\_OUT is a coaxial SPDIF\_OUT connector.

**(11) D-Sub 15-pin Connector: VGA**

VGA connector is the 15-pin D-subminiature female connector; it is for the display devices, such as the CRT monitor, LCD monitor and so on.

**(12) Digital Visual Interface: DVI1**

This interface standard designed to maximize the visual quality of digital display devices such as flat panel LCD computer displays and digital projectors.

**(13) High-Definition Multimedia Interface: HDMI**

This point-to-point interface is for audio and video signals designed as a single-cable solution for home theater and consumer electronics equipment.



---

---

## 2-6-2 Headers

### (1) Line-Out/MIC Header for Front Panel (9-pin): FP\_AUDIO

These headers connect to Front Panel Line-out, MIC connector with cable.

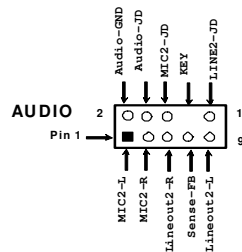
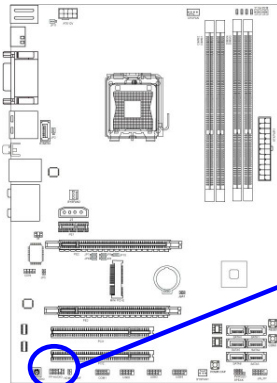

Line-Out, MIC Headers

### (2) USB Port Headers (9-pin): USB2/USB3/USB4

These headers are used for connecting the additional USB port plugs. By attaching an option USB cable, your can be provided with two additional USB plugs affixed to the back panel.

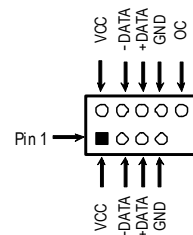
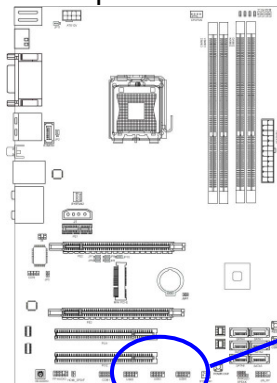

USB Port Header

### (3) Speaker connector: SPEAK

This 4-pin connector connects to the case-mounted speaker. See the figure below.

### (4) Power LED: PWR LED

The Power LED is light on while the system power is on. Connect the Power LED from the system case to this pin.

### (5) IDE Activity LED: HD LED

This connector connects to the hard disk activity indicator light on the case.

### (6) Reset switch lead: RESET

This 2-pin connector connects to the case-mounted reset switch for rebooting your computer without having to turn off your power switch. This is a preferred method of rebooting in order to prolong the life of the system's power supply. See the figure below.

### (7) Power switch: PWR BTN

This 2-pin connector connects to the case-mounted power switch to power ON/OFF the system.

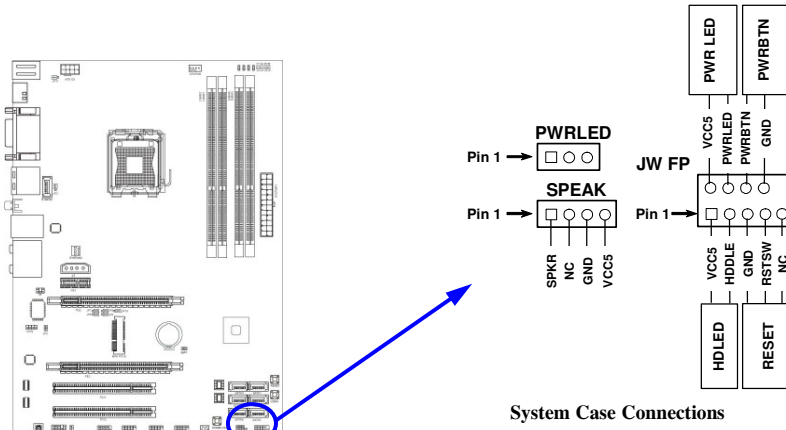

**(8) FAN Headers: SYSFAN1 (3-pin), SYSFAN2 (3-pin), CPUFAN (4-pin)**

These connectors support cooling fans of 350mA (4.2 Watts) or less, depending on the fan manufacturer, the wire and plug may be different. The red wire should be positive, while the black should be ground. Please connect the fan's plug to the board taking into consideration the polarity of connector.

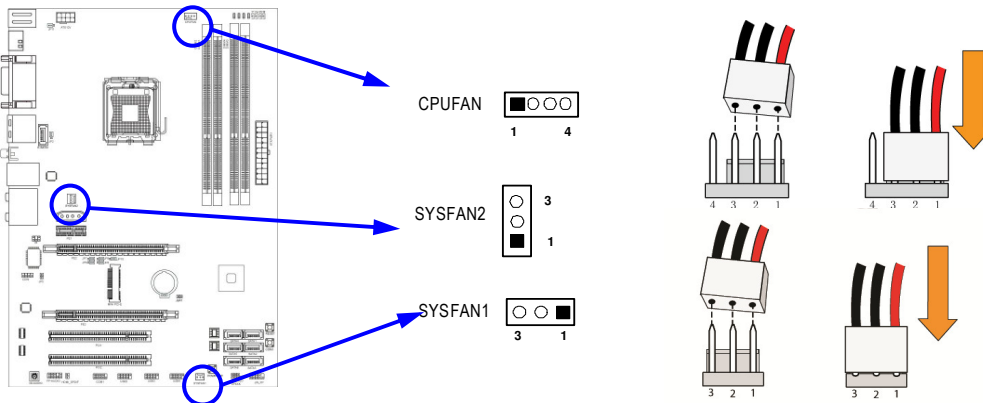

**(9) CD Audio-In Headers (4-pin): CDIN**

CDIN are the connectors for CD-Audio Input signal. Please connect it to CD-ROM CD-Audio output connector.

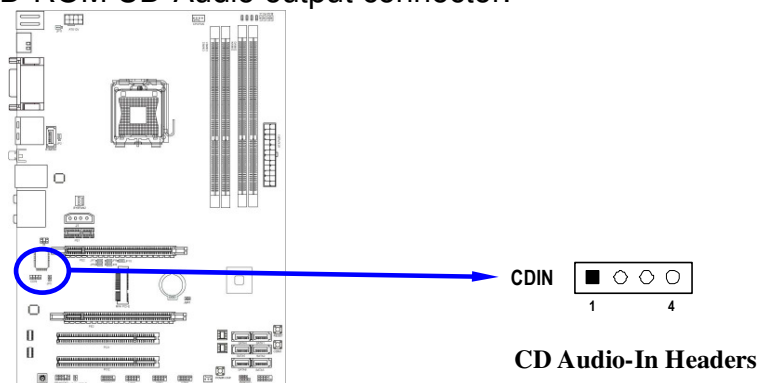

**(10) IR infrared module Headers (5-pin): IR1**

This connector supports the optional wireless transmitting and receiving infrared module. You must configure the setting through the BIOS setup to use the IR function.

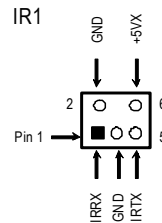
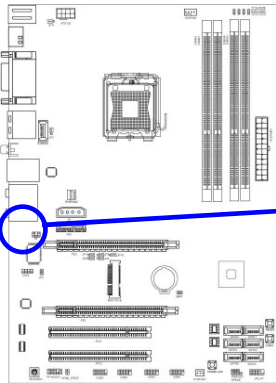

**IR infrared module Headers**

**(11) Serial COM Port header: COM1**  
COM1 is a 9-pin RS232 connector.

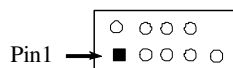
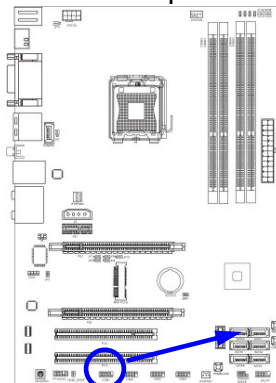

**Serial COM Port 9-pin Block**

**(12) SPDIF Out header: HDMI\_SPDIF**

The SPDIF output is capable of providing digital audio to external speakers or compressed AC3 data to an external Dolby digital decoder. Use this feature only when your stereo system has digital input function.

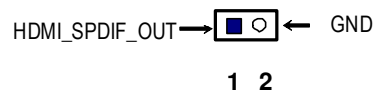
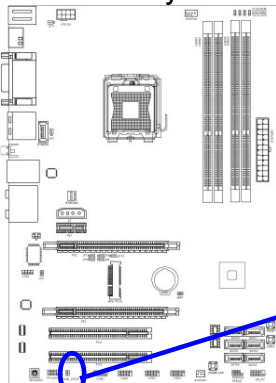

**HDMI\_SPDIF Header**

---

---

## 2-7 Starting Up Your Computer

1. After all connection is made, close your computer case cover.
2. Be sure all the switch are off, and check that the power supply input voltage is set to proper position, usually in-put voltage is 220V~240V or 110V~120V depending on your country's voltage used.
3. Connect the power supply cord into the power supply located on the back of your system case according to your system user's manual.
4. Turn on your peripheral as following order:
  - a. Your monitor.
  - b. Other external peripheral (Printer, Scanner, External Modem etc...)
  - c. Your system power. For ATX power supplies, you need to turn on the power supply and press the ATX power switch on the front side of the case.
5. The power LED on the front panel of the system case will light. The LED on the monitor may light up or switch between orange and green after the system is on. If it complies with green standards or if it is has a power standby feature. The system will then run power-on test. While the test are running, the BIOS will alarm beeps or additional message will appear on the screen.

If you do not see any thing within 30 seconds from the time you turn on the power. The system may have failed on power-on test. Recheck your jumper settings and connections or call your retailer for assistance.

6. During power-on, press <Delete> key to enter BIOS setup. Follow the instructions in BIOS SETUP.
7. **Power off your computer:** You must first exit or shut down your operating system before switch off the power switch. For ATX power supply, you can press ATX power switching after exiting or shutting down your operating system. If you use Windows 9X, click "**Start**" button, click "**Shut down**" and then click "**Shut down the computer?**" The power supply should turn off after windows shut down.

---

---

## Chapter 3

# Introducing BIOS

The BIOS is a program located on a Flash Memory on the motherboard. This program is a bridge between motherboard and operating system. When you start the computer, the BIOS program will gain control. The BIOS first operates an auto-diagnostic test called POST (power on self test) for all the necessary hardware, it detects the entire hardware device and configures the parameters of the hardware synchronization. Only when these tasks are completed done it gives up control of the computer to operating system (OS). Since the BIOS is the only channel for hardware and software to communicate, it is the key factor for system stability, and in ensuring that your system performance as its best.

In the BIOS Setup main menu of Figure 3-1, you can see several options. We will explain these options step by step in the following pages of this chapter, but let us first see a short description of the function keys you may use here:

- Press <Esc> to quit the BIOS Setup.
- Press ↑↓←→ (up, down, left, right) to choose, in the main menu, the option you want to confirm or to modify.
- PGUP: Previous Value; PGDN: Next Value.
- Press <F10> when you have completed the setup of BIOS parameters to save these parameters and to exit the BIOS Setup menu.
- Press <+>/<-> keys when you want to modify the BIOS parameters for the active option.

### 3-1 Entering Setup

Power on the computer and by pressing <Del> immediately allows you to enter Setup. If the message disappears before your respond and you still wish to enter Setup, restart the system to try again by turning it OFF then ON or pressing the “RESET” button on the system case. You may also restart by simultaneously pressing <Ctrl>, <Alt> and <Delete> keys. If you do not press the keys at the correct time and the system does not boot, an error message will be displayed and you will again be asked to

**Press <Del> to enter Setup**

### 3-2 Getting Help

#### Main Menu

The on-line description of the highlighted setup function is displayed at the bottom of the screen.

#### Status Page Setup Menu/Option Page Setup Menu

Press F1 to pop up a small help window that describes the appropriate keys to use and the possible selections for the highlighted item. To exit the Help Window, press <Esc>.

---

---

### 3-3 The Main Menu

Once you enter AMI BIOS Setup Utility, the Main Menu (Figure 3-1) will appear on the screen. The Main Menu allows you to select from 12 setup functions and 2 exit choices. Use arrow keys to select among the items and press <Enter> to accept or enter the sub-menu.

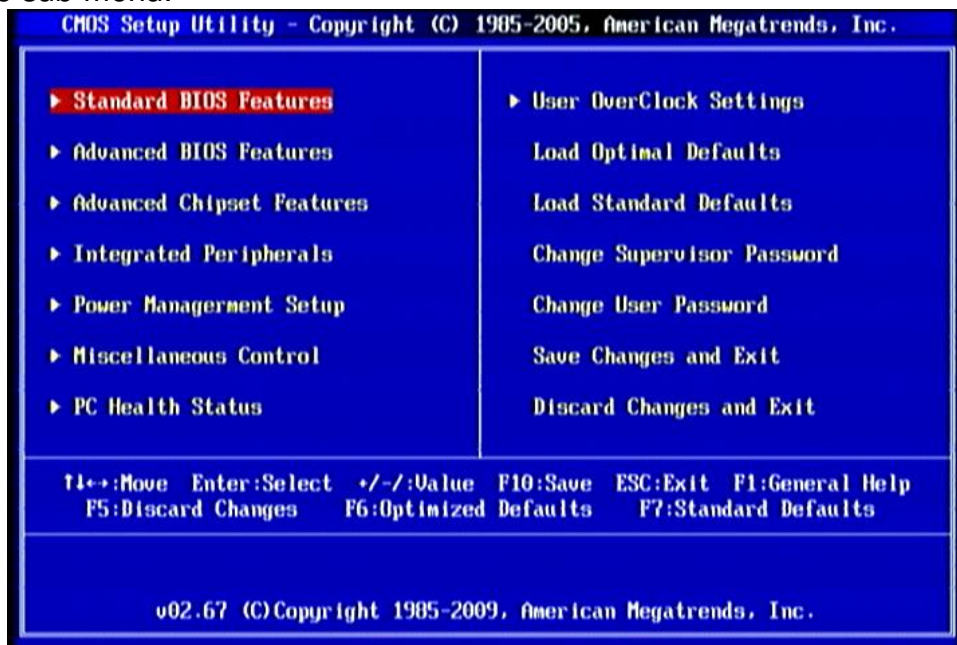

Figure 3-1

#### **Standard BIOS Features**

Use this Menu for basic system configurations.

#### **Advanced BIOS Features**

Use this menu to set the Advanced Features available on your system.

#### **Advanced Chipset Features**

Use this menu to change the values in the chipset registers and optimize your system's performance.

#### **Integrated Peripherals**

Use this menu to specify your settings for integrated peripherals.

#### **Power Management Setup**

Use this menu to specify your settings for power management setup.

#### **Miscellaneous Control**

Use this menu to specify your settings for Miscellaneous Control.

#### **PC Health Status**

Use this item to configure hardware health status.

#### **User Overclock Settings**

Use this menu to specify your settings (frequency, Voltage) for overclocking demand

#### **Load Optimal Defaults**

Use this menu to load the BIOS default values these are setting for optimal performances system operations for performance use.

#### **Load Standard Defaults**

This menu uses a standard performance setting, but the system would run in a stable way.

---

---

## Change Supervisor Password

This entry is for setting Supervisor password.

## Change User Password

This entry for setting User password

## Save Changes and Exit

Save CMOS value changes to CMOS and exit setup.

## Discard Changes and Exit

Abandon all CMOS value changes and exit setup.

## 3-4 Standard BIOS Features

The items in Standard CMOS Setup Menu are divided into several categories. Each category includes no, one or more than one setup items. Use the arrow keys to highlight the item and then use the <+> or <-> and numerical keyboard keys to select the value you want in each item.

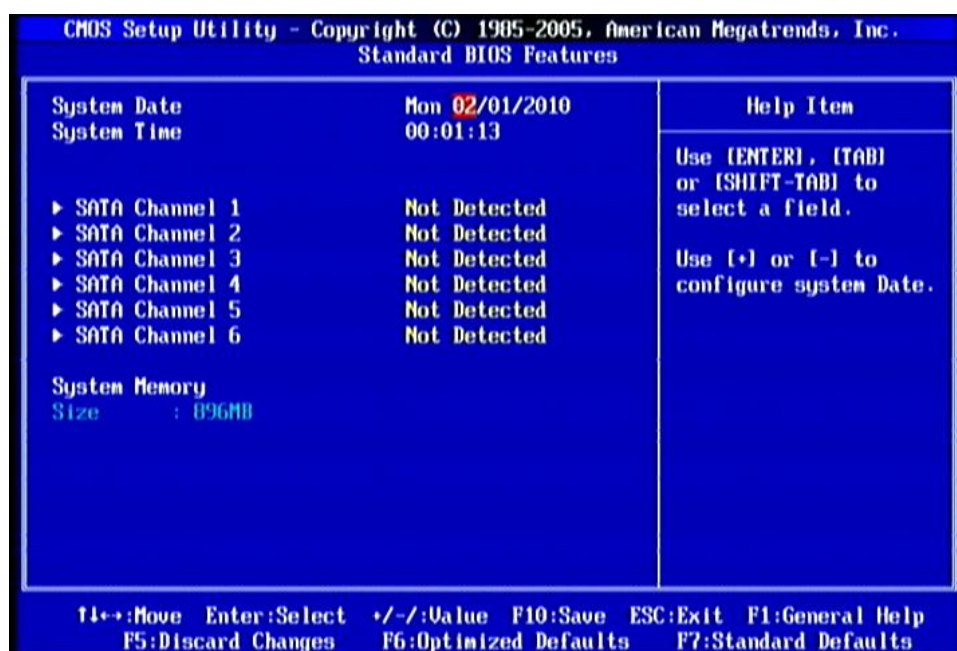

### System Date

The date format is <day><month><date><year>.

**Day** Day of the week, from Sun to Sat, determined by BIOS. Read-only.

**Month** The month from Jan. through Dec.

**Date** The date from 1 to 31 can be keyed by numeric function keys.

**Year** The year depends on the year of the BIOS.

### System Time

The time format is <hour><minute><second>.

### SATA Channel 1, 2, 3, 4, 5, 6

**Type:** The optional settings are: Not Installed; Auto; CD/DVD and ARMD.

**LBA/Large Mode:** The optional settings are Auto; Disabled.

**Block (Multi-Sector Transfer):** The optional settings are: Disabled and Auto.

**PIO Mode:** the optional settings are: Auto, 0, 1, 2, 3 and 4.

**DMA MODE:** the optional settings are Auto, SWDMAN, MWDMAN, UDMAN.

**S.M.A.R.T.:** This option allows you to enable the HDD S.M.A.R.T. Capability (Self-Monitoring, Analysis and Reporting Technology). The optional settings are Auto; Disabled and Enabled.



---

---

### 32 Bit Data Transfer

The optional settings are: Disabled and Enabled.

### System Memory

This item will show information about the memory modules(s) installed.

## 3-5 Advanced BIOS Features

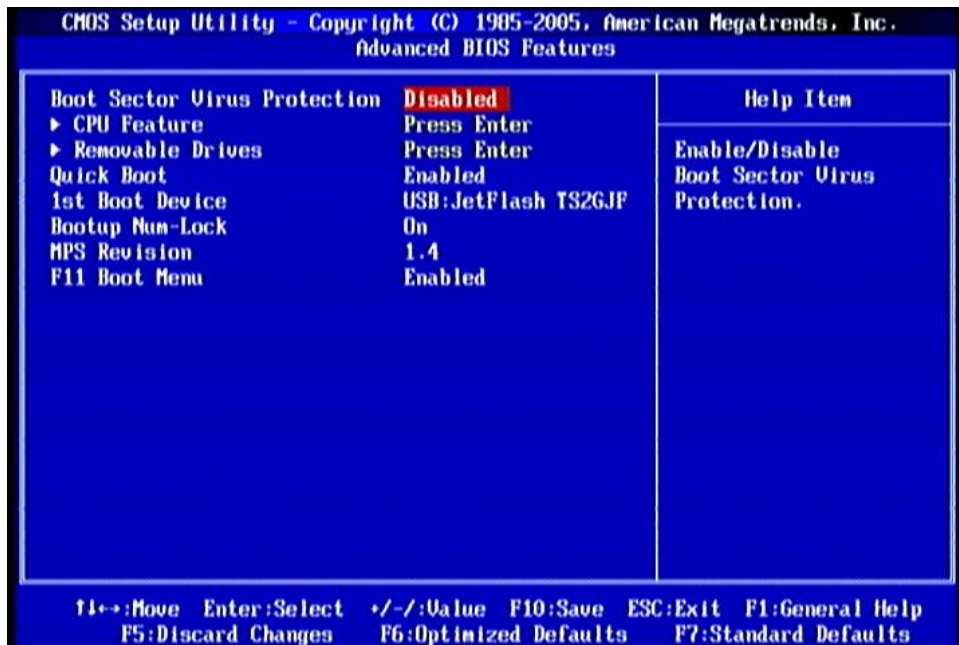

### Boot Sector Virus Protection

The selection Allow you to choose the VIRUS Warning feature for IDE Hard Disk boot sector protection. If this function is enabled and someone attempt to write data into this area, BIOS will show a warning message on screen and alarm beep.

**Disabled** (default) No warning message to appear when anything attempts to access the boot sector or hard disk partition table.

**Enabled** Activates automatically when the system boots up causing a warning message to appear when anything attempts to access the boot sector of hard disk partition table.

### Quick Boot

Allows BIOS to skip certain tests while booting. This will decrease the needed to boot the system.

### 1<sup>st</sup> Boot Device

Use this item to specified the boot sequence from the available devices. A device enclosed in parenthesis has been disabled in the corresponding type menu.

### Boot Up NumLock Status

The default value is On.

**On** (default) Keypad is numeric keys.

**Off** Keypad is arrow keys.

### MPS Revision

This option is only valid for multiprocessor motherboards as it specifies the version of the Multiprocessor Specification (MPS) that the motherboard will use. The optional settings are: 1.1; 1.4.



---

---

## 3-5-1 CPU Features

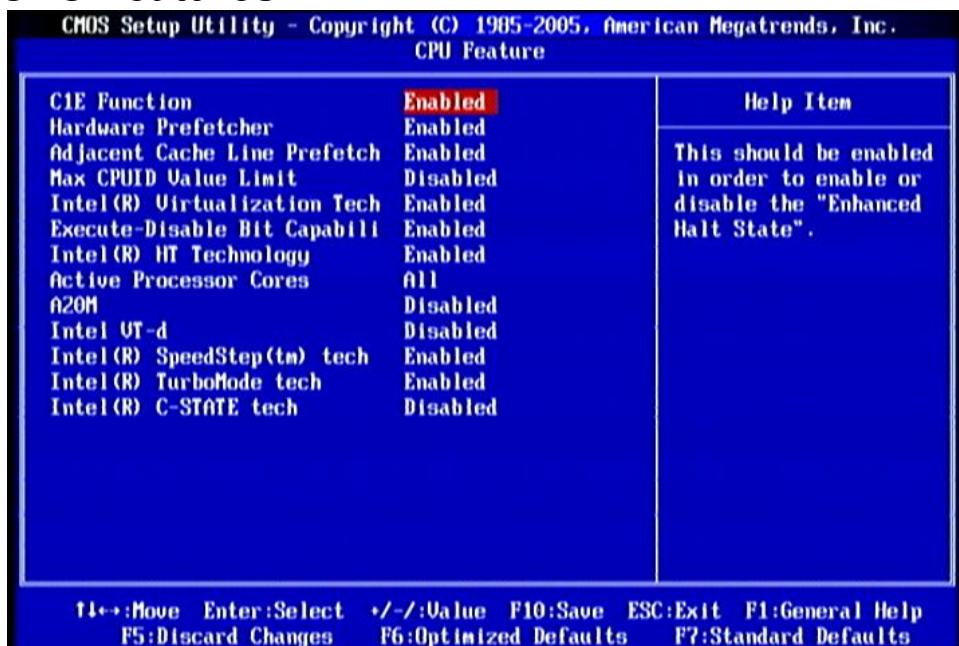

The screenshot shows the BIOS 'CPU Feature' menu. The title bar reads 'CMOS Setup Utility - Copyright (C) 1985-2005, American Megatrends, Inc. CPU Feature'. The main area contains a table of settings:

Feature	Value	Help Item
C1E Function	Enabled	This should be enabled in order to enable or disable the "Enhanced Halt State".
Hardware Prefetcher	Enabled	
Adjacent Cache Line Prefetch	Enabled	
Max CPUID Value Limit	Disabled	
Intel(R) Virtualization Tech	Enabled	
Execute-Disable Bit Capabili	Enabled	
Intel(R) HT Technology	Enabled	
Active Processor Cores	All	
A20M	Disabled	
Intel VT-d	Disabled	
Intel(R) SpeedStep(tm) tech	Enabled	
Intel(R) TurboMode tech	Enabled	
Intel(R) C-STATE tech	Disabled	

At the bottom, navigation instructions are listed: F1: Move, Enter: Select, +/-: Value, F10: Save, ESC: Exit, F1: General Help, F5: Discard Changes, F6: Optimized Defaults, F7: Standard Defaults.

### C1E Function

This should be enabled in order to enable or disable the "Enhanced Halt State". The optional settings are: Enabled; Disabled.

### Hardware Prefetcher

For UP platform, leave it as Enabled. For DP/MP servers, it may use to tune performance to the specific application. The optional settings are: Enabled; Disabled.

### Adjacent Cache Line Prefetch

For UP platform, leave it as Enabled. For DP/MP servers, it may use to tune performance to the specific application. The optional settings are: Enabled; Disabled.

### Max CPUID Value Limit

Set it as Disabled for Windows XP. The optional settings are: Enabled; Disabled.

### Intel (R) Virtualization Tech

When this item is set as Enabled, a VMM can utilize the additional HW Caps. Provided by Intel(R) Virtualization Tech. Note: A full reset is required to change the setting. The optional settings are: Enabled; Disabled.

### Execute-Disable Bit Capabili

When disabled, force the XD feature flag to always return 0. The optional settings are: Enabled; Disabled.

### Intel(R) HT Technology

When Disabled, only one thread per enabled core is enabled. The optional settings are: Enabled; Disabled.

### Active Processor Core

Use this item to decide the number of cores to enable in each processor package. The optional settings are: All; 1, 2, 3 and 4.

### A20M

Legacy OSES and APs may need A20M enabled. The optional settings are: Enabled; Disabled.

---

---

### Intel(R) SpeedStep (tm)tech

The optional settings are: Enabled; Disabled.

Disable: Disable GV3.

Enable: Enable GV3.

### Intel(R) TurboMode tech

Turbo mode allows processor cores to run faster than marked frequency in specific condition.

### Intel(R) C-STATE tech

CState: CPU idle is set to C2/C3/C4.

## 3-6 Advanced Chipset Features

The Advanced Chipset Features Setup option is used to change the values of the chipset registers. These registers control most of the system options in the computer.

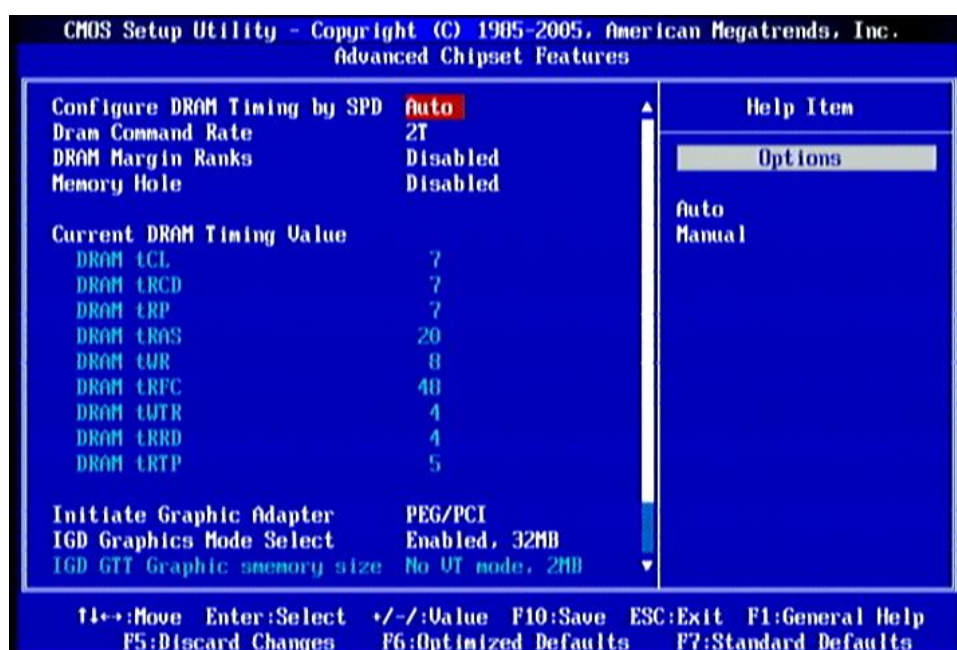

### Configure DRAM Timing by SPD

The optional setting is: Auto; Manual.

### DRAM Command Rate

The optional settings are: Auto; 1T; 2T.

### DRAM Margin Ranks

The optional settings are: Disabled; Enabled.

### Memory Hole

The optional settings are: Disabled; 15MB-16MB.

### Initiate Graphics Adapter

Select which graphics controller to use as the primary boot device. The optional settings are: IGD;PCI/IGD; PCI/PEG;PEG/IGD;; PEG/PCI.

### IGD Graphics Mode Select

Select the amount of system memory used by the internal graphics device. The optional settings are: Disabled; Enabled, 32MB;Enabled, 64MB; Enabled,128MB.

---

---

## 3-7 Integrated Peripherals

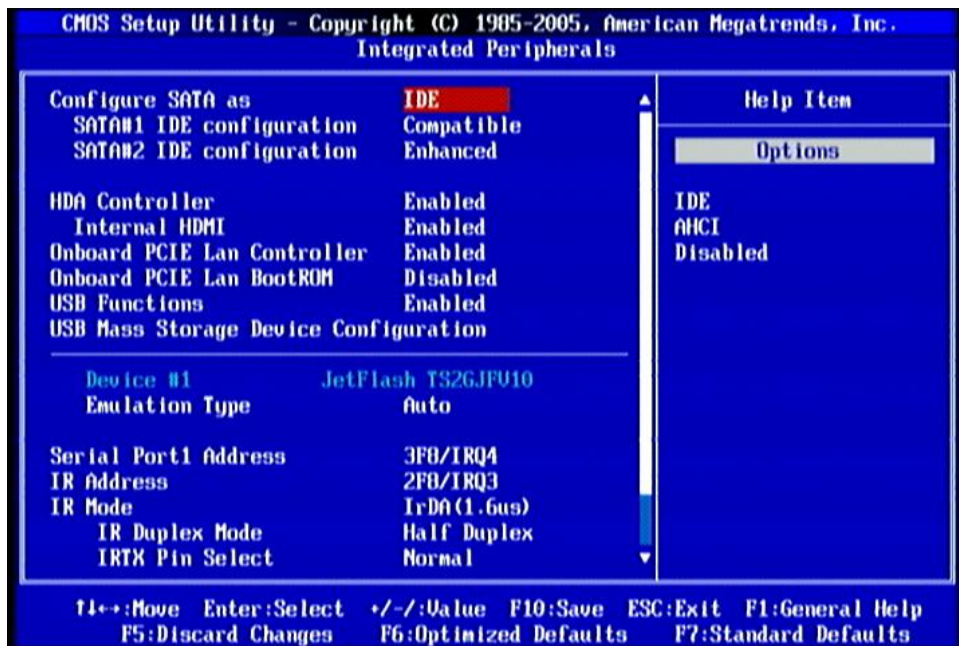

### Configure SATA as

Press Enter to select the SATA type. The optional settings are: IDE; AHCI and Disabled.

### SATA#1 IDE Configuration

The optional settings are: Compatible and Enhanced.

### SATA#2 IDE Configuration

The optional settings are: Disabled and Enhanced.

### Onboard PCIE Lan Controller

Use this item to enable or disable onboard PCIE Lan controller.

### Onboard PCIE Lan BootROM

The optional settings are: Disabled; Enabled.

### USB Functions

The optional settings are: Disabled; Enabled.

### Emulation Type

If Auto, USB devices less than 530MB will be emulated as Floppy and remaining as hard drive. Force FDD option can be used to force a HDD formatted driver to boot as FDD (Ex. ZIP drive).

### Serial Port1 Address

Allow BIOS to Select Serial Port1 Base Addresses.

### IR Address

Allow BIOS to Select Serial Port2 Base Addresses.

### IR Mode

Allow BIOS to select mode for Serial Port2.

### IR Duplex Mode

Allow BIOS to select Full or Half Duplex for Serial Port2. (IR Mode)

### IRTX Pin Select

Allow BIOS to select transmit pin is normal condition or inverse the IRTX (IR Mode).

---

---

## 3-8 Power Management Setup

The Power Management Setup allows you to configure your system to most effectively save energy saving while operating in a manner consistent with your own style of computer use.



### ACPI Version Features

The optional settings are: ACPI v1.0; ACPI v2.0; ACPI v3.0.

### ACPI APIC Support

Include ACPI APIC table pointer to RSDT pointer list.

### AMI OEMB Table

Include OEMB table Pointer to R(X) SDT pointer lists.

### Headless Mode

Enable/Disable headless operation through ACPI.

### ACPI Aware O/S

The optional settings are: Enabled; Disabled.

### Suspend Mode

Select the ACPI states used for system suspend. The optional settings are: S1 (POS); S3 (STR).

### Restore on AC Power Loss

The optional settings are: Power Off; Power On; Last State.

### Video Power Down Mode

Power Down video in suspend or standby mode. The optional settings are: Disabled; Standby and Suspend.

### Suspend Time Out

Use this item to go into suspend mode in specific time.

### Power Button Mode

Use this item to go into On/Off, or suspend when power button is pressed.

### Wake-Up by PCI Card/wake-up by PCIE/LAN from S5/Wake-Up by Ring/Wake-Up PS/2 KB/MS

To generate a wake event by the above devices. The optional settings are: Enabled;



Disabled.

### High Performance Event Timer

The optional settings are: Enabled; Disabled.

### Resume On RTC Alarm

Use this item to disable or enable RTC to generate a wake event.

## 3-9 Miscellaneous Control



### Palette Snooping

The optional settings are: Enabled; Disabled.

Enable: inform the PCI device that an ISA graphics devices is installed in the system so the card will function correctly.

## 3-10 PC Health Status

This section shows the Status of you CPU, Fan, and Warning for overall system status. This is only available if there is Hardware Monitor onboard.

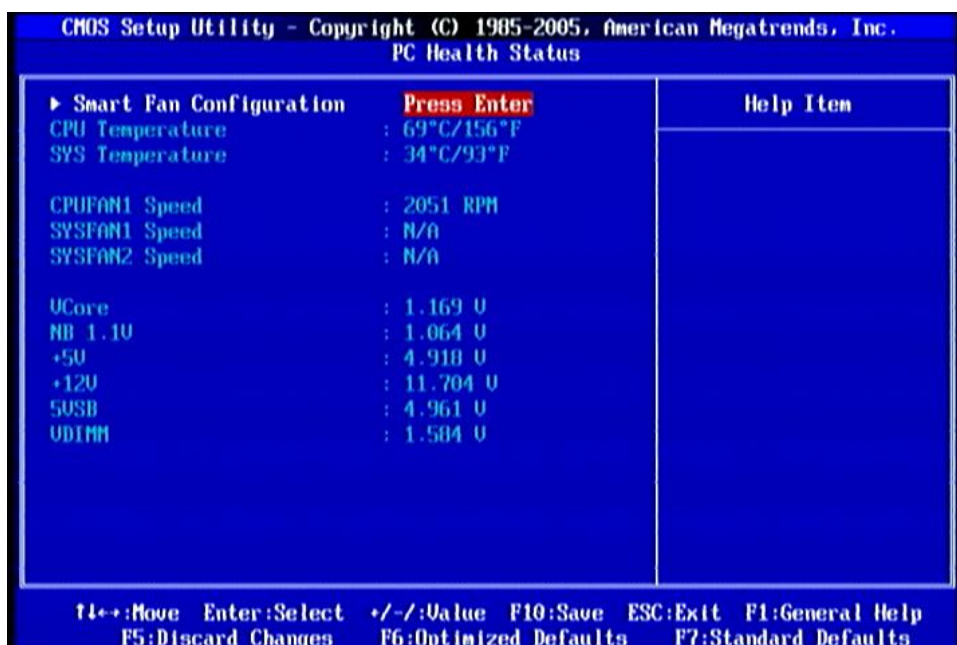

### CPU Temperature/ SYS Temperature/CPUFAAN1/SYSFAN1 Speed/SYSFAN2 Speed /VCore/NB 1.1V/+5V/+12V/5VSB/VDIMM

This will show the CPU/ /System voltage chart and FAN Speed, etc.

## 3-10-1 Smart FAN Configuration

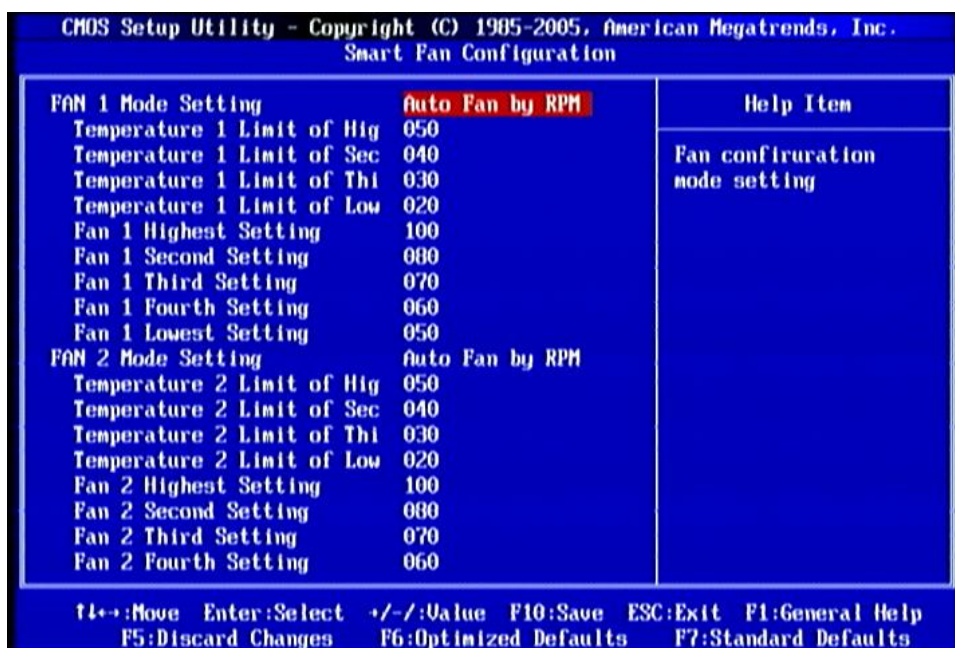

### FAN1/FAN2 Mode Setting

Press enter to select FAN1/FAN2 Mode setting, the optional settings are: Auto Fan by RPM; Auto Fan by DutyCycle; Manual Mode by RPM; Manual Mode by DutyCycle.

## 3-11 User Overclock Settings



### Linear PCIEX Clock

Use this item to set Linear PCIEX clock in the range of 100 to 200.

### CPU Diff AMP

The optional settings are: 700mV; 800mV; 900mV; 1000mV.

### PCIEX Diff AMP

The optional settings are: 700mV; 800mV; 900mV; 1000mV.

---

---

### **CPU Clock Skew**

The optional settings are: Default; 100ps~1500ps.

### **DRAM Clock at Next Boot**

The optional setting are: Auto; 800MHz (DDR3 800); 1066 MHz (DDR3 1066); 1333MHz (DDR3 1333).

### **Host/PCI Clock at Next Boot**

Use the item to set CPU Frequency. Range between 133~500.

### **CPU Vcore 7-Shift**

Use this item to set value in CPU Vcore 7-Shift function. optional settings are: +50mV to 350mV.

### **CPU PLL Select**

Use this tem to set CPU PLL from 1.816V (Default) to 2.043V.

### **PCH Core Voltage**

Use this item to set PCH core voltage from the range of 1.079 (Default) to 1.180V.

### **CPU VTT Voltage**

Use this item to set CPU VTT voltage from 1.140Vto 2.247V. The default value is 1.176v.

### **DRAM Voltage Select**

Use this item to set DRAM voltage from 1.538V to 2.204V. The default value is 1.589v.

### **CPU AGX Voltage Select**

The optional settings are: Auto, +50mV~+350 mV.

<b>NOTICE!</b> The voltage in BIOS settings is only for reference. If Voltage is set too high, the color will change into red.
--

---

---

## 3-12 Password Settings

You can set either supervisor or user password, or both of them. The differences are:

**Change Supervisor password:** Can enter and change the options of the setup menus.

**Change User password:** Can only enter but do not have the right to change the options of the setup menus. When you select this function, the following message will appear at the center of the screen to assist you in creating a password.

### Enter New Word:

Type the password, up to eight characters in length, and press <Enter>. The password typed now will clear any previously entered password from CMOS memory. You will be asked to confirm the password. Type the password again and press <Enter>. You may also press <Esc> to abort the selection and not enter a password. To disable a password, just press <Enter> when you are prompted to enter the password. A message will confirm that the password will be disabled. Once the password is disabled, the system will boot and you can enter Setup freely.

### PASSWORD DISABLED.

When a password has been enabled, you will be prompted to enter it every time you try to enter Setup. This prevents an unauthorized person from changing any part of your system configuration.

Additionally, when a password is enabled, you can also require the BIOS to request a password every time your system is rebooted. This would prevent unauthorized use of your computer.

You determine when the password is required within the BIOS Features Setup Menu and its Security option. If the Security option is set to "System", the password will be required both at boot and at entry to Setup. If set to "Setup", prompting only occurs when trying to enter Setup.

## 3-13 Load Optimal Defaults/ Load Standard Defaults

### Load Optimal Defaults

When you press <Enter> on this item, you get a confirmation dialog box with a message similar to:



Pressing <OK> loads the default values that are factory settings for optimal performance system operations.

### Load Standard Defaults

When you press <Enter> on this item, you get a confirmation dialog box with a message similar to:





Pressing <OK> loads the default values that are factory settings for stable performance system operations.

### 3-14 Save Changes and Exit / Discard Changes and Exit

#### Save Changes and Exit

When you press <Enter> on this item, you get a confirmation dialog box with a message similar to:



Pressing <OK> save the values you made previously and exit BIOS setup.

#### Discard and Exit

When you press <Enter> on this item, you get a confirmation dialog box with a message similar to:



Pressing <OK> to leave BIOS setting without saving previously set values.

**Notice!** The BIOS options in this manual are for reference only. Different configurations may lead to difference in BIOS screen and BIOS screens in manuals are usually the first BIOS version when the board is released and may be different from your purchased motherboard. Users are welcome to download the latest BIOS version form our official website.

---

---

## Chapter 4

# Driver & Free Program Installation

Check your package and there is A MAGIC INSTALL CD included. This CD consists of all DRIVERS you need and some free application programs and utility programs. In addition, this CD also include an auto detect software which can tell you which hardware is installed, and which DRIVERS needed so that your system can function properly. We call this auto detect software MAGIC INSTALL.

### MAGIC INSTALL Supports WINDOWS XP/Vista/7

Insert CD into your CD-ROM drive and the MAGIC INSTALL Menu should appear as below. If the menu does not appear, double-click MY COMPUTER / double-click CD-ROM drive or click START / click RUN / type X:\SETUP.EXE (assuming X is your CD-ROM drive).



#### From MAGIC INSTALL MENU you may make 11 selections:

1. INF install Intel H55 chipset system driver
2. SOUND install ALCHD Audio driver
3. RealTek install Realtek Gigabit Ethernet NIC Driver
4. Norton install Norton Internet Security 2010
5. PC-Health install MyGuard Hardware Monitor Utility
6. VGA install Intel HD VGA Driver
7. DOTNET install DOTNET
8. IMSS install IMSS
9. AHCI/RAID install Intel AHCI Driver
10. BROWSE CD to browse the contents of the CD

11. EXIT to exit from MAGIC INSTALL menu

## 4-1 INF Install Intel H55 Chipset System Driver



1. Click INF item when Magic Install menu appears.
2. Click Next when Intel Chipset Device Software appears.

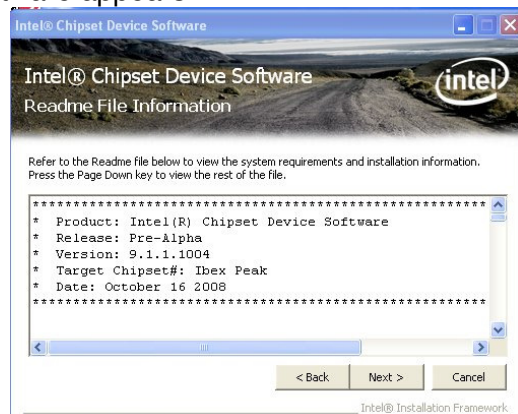

3. Click Yes on the License Agreement.
4. After reading the Readme File Information click Next.

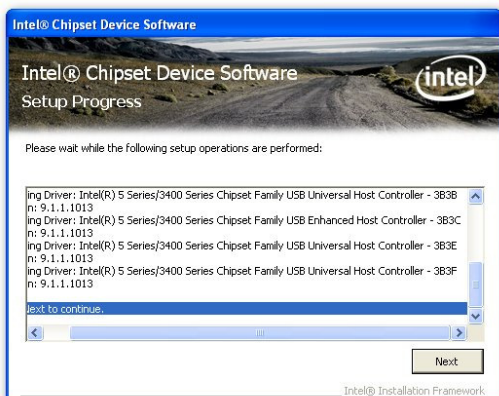

5. Click Next.
6. Click Finish to finish installation.

## 4-2 SOUND Install ALC HD Audio Codec Driver



1. Click Sound on the Magic Install menu.

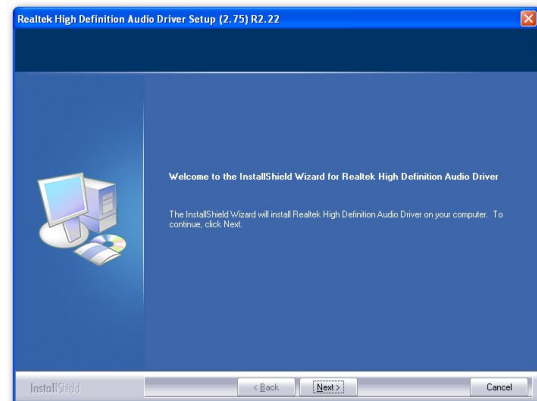

2. Click Next When Realtek High Definition Audio driver windows appear



3. Click Finish and restart your computer



4. Manual Sound Effect Setting



5. The mixer.



6. Audio input and output settings.

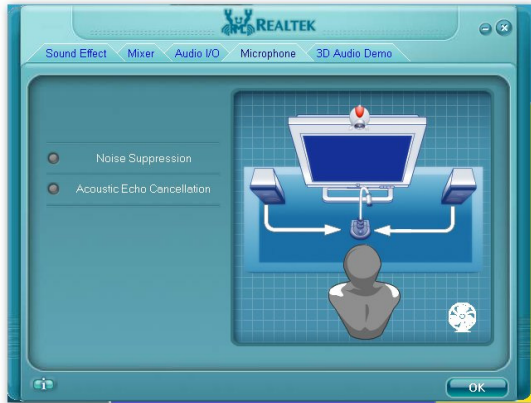

7. Microphone effect.



8. 3D sound effect..

**NOTE: Please upgrade your Windows XP to Service Pack to Service Pack 4 or later before you the HD Audio CODEC driver.**

### 4-3 RealTek Install Realtek Gigabit Ethernet NIC Driver



1. Click LAN when Magic Install Menu appears

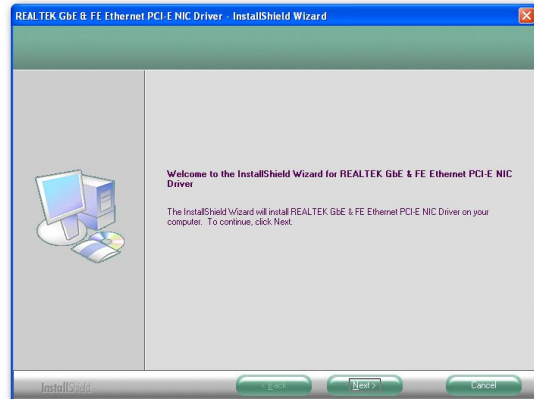

2. Click Next, install REALTEK LAN and Fast Ethernet NIC Driver

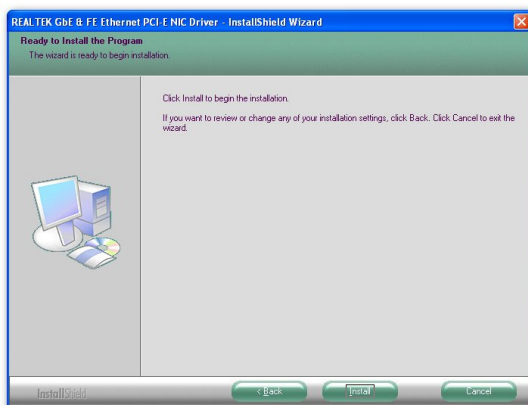

3. Click install to begin the installation.

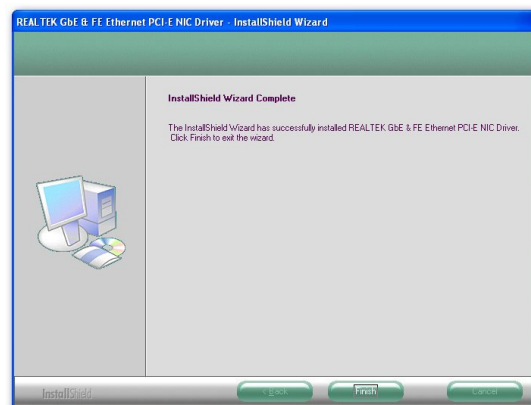

4. After driver installation completed, Click Finish.



---

---

## 4-4 Norton Install Norton Internet Security 2010

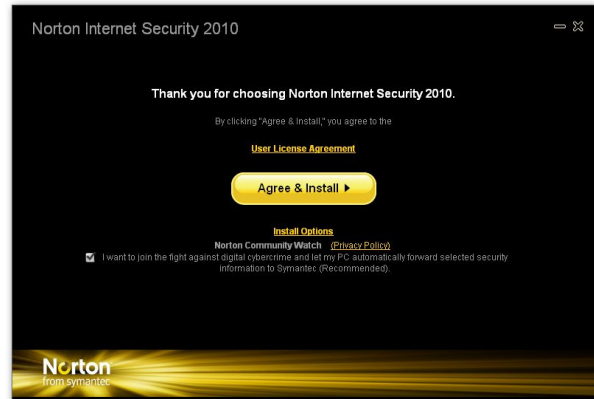

1. Click Norton when Magic Install menu appears.
2. Click AGREE & INSTALL after reading User License Agreement.

## 4-5 PC-health Install MyGuard Hardware Monitor Utility

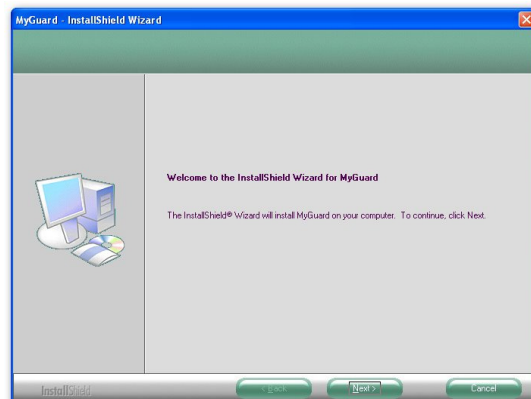

1. Click PC-Health when MAGIC INSTALL MENU appears
2. Click Next when Install shield wizard Window appears.

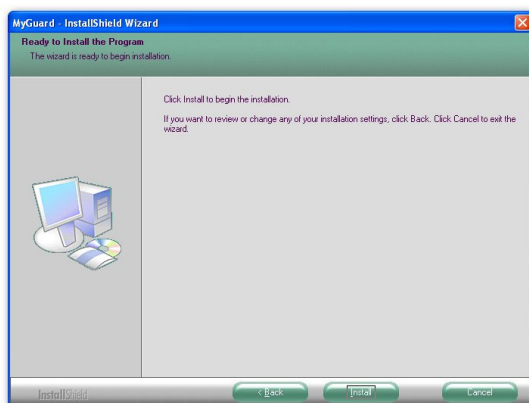

3. Click Install to begin the installation.

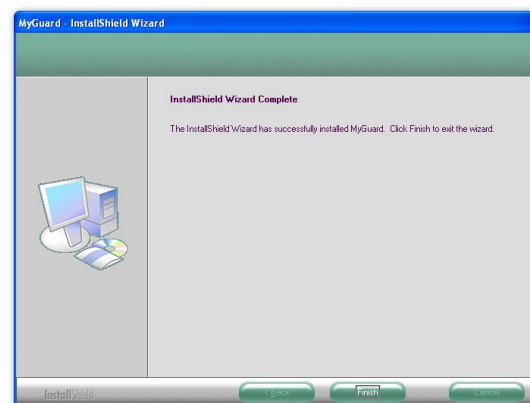

4. Click Finish to complete the installation.

## 4-6 VGA Install Intel HD VGA Driver



1. Click VGA when MAGIC INSTALL MENU appears.
2. Click Next to continue.

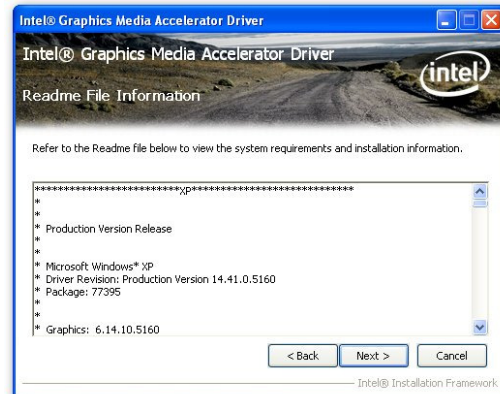
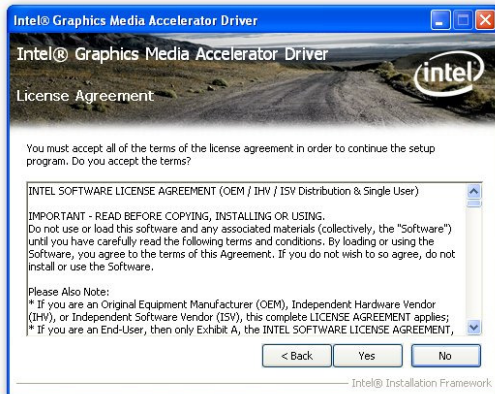

3. Accept the license agreement and Click yes.
4. Click next.

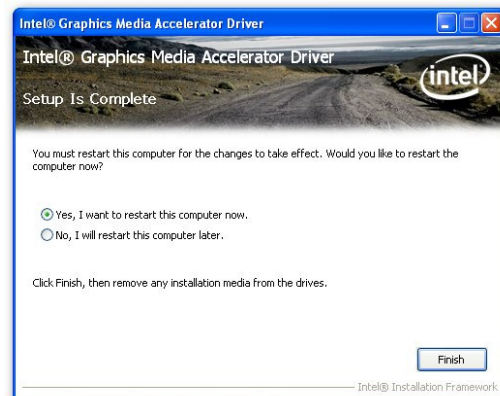
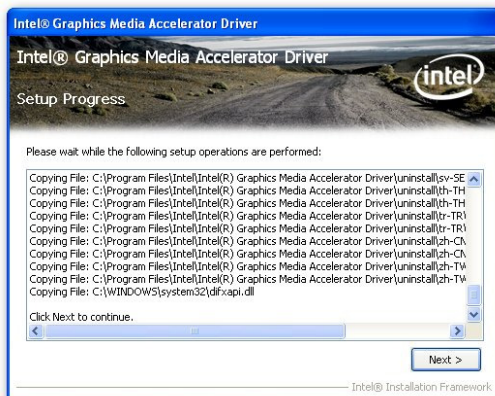

5. Click next to continue.
6. Click finish.



## 4-7 DOTNET Install DOTNET



1. Click DOTNET when MAGIC INSTALL MENU appears.

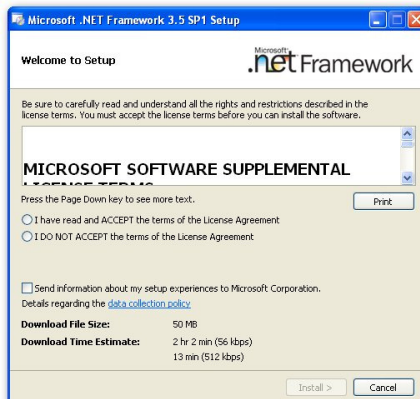

2. choose "I have read and accept the terms of the license agreement.

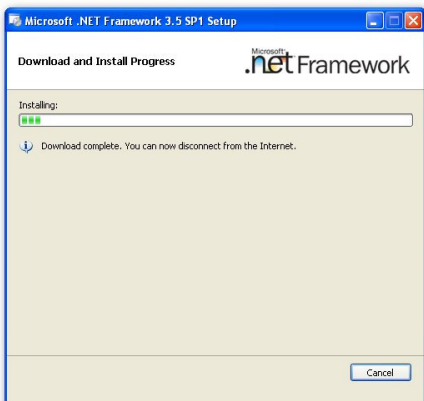

3. download and install progress.

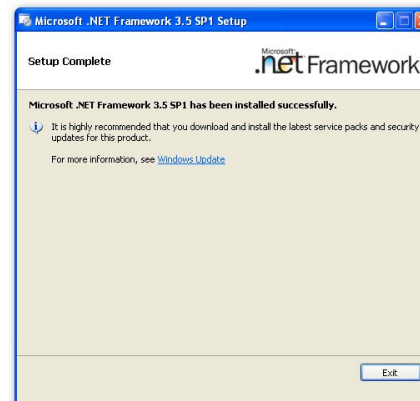

4. setup complete and Click Exit.

## 4-8 IMSS Install IMSS

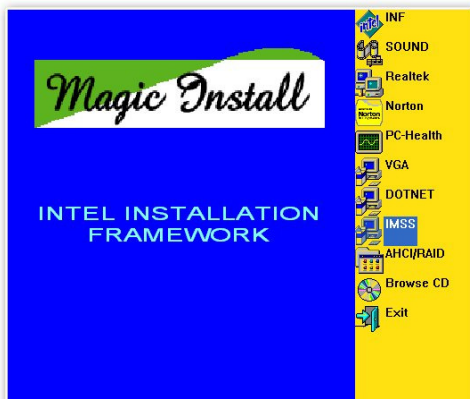

1. Click IMSS when MAGIC INSTALL MENU appears.
2. Click Next.





3. Click Yes.

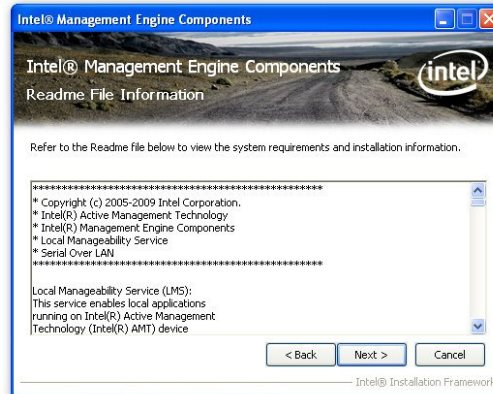

4. Click Next.



5. Click Next to continue.



6. Click finish to complete the setup process.

## 4-9 AHCI/RAID Install Intel AHCI /RAID Driver

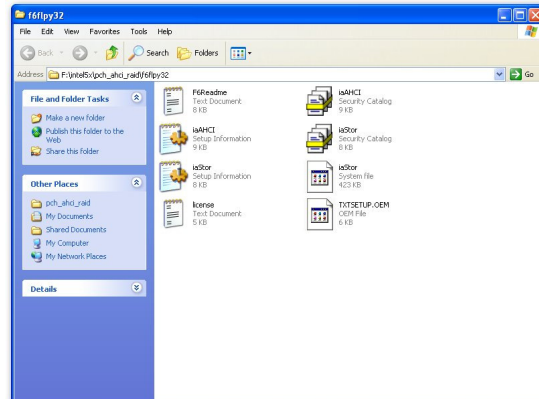

If you want to use Intel SATA AHCI mode for your system, please according to following steps to install driver:

1. Copy `CD: \intel5x\pch_ahci_raid\f6flpy32` all files to empty boot disk root directory. (For windows XP / vistaX32)  
Copy `CD: \intel5x\pch_ahci_raid\f6flpy64` all files to empty boot disk root directory. (For windows xp64 / vistaX64)
2. Please going to BIOS setup \ Integrated Peripherals \ Onboard SATA Function, Set the SATA mode to "AHCI".
3. Before you Install Windows XP OS, Please press F6 key to install SATA AHCI

---

---

driver First.

4. If you are Windows 7 /Vista OS, please load SATA ACHI driver from this location.

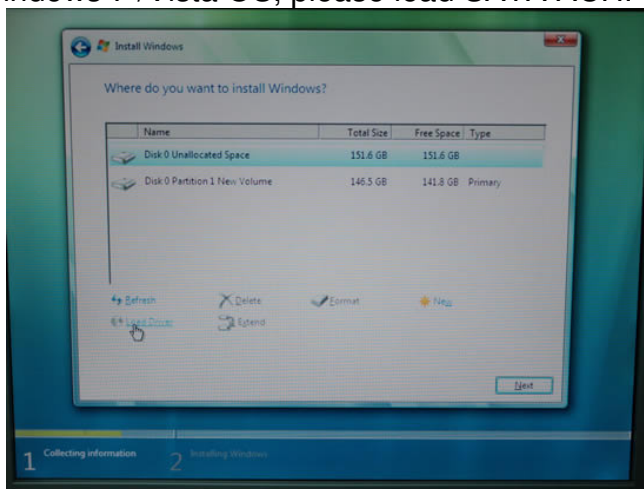

**NOTICE!** The above driver screen and operation steps are for reference only because we might update the drivers or make modifications due to technological need and user's benefits. We reserve these changes or upgrade without advanced notification. Please visit our website for possible driver upgrade.

## 4-10 How to Update BIOS

- STEP 1.** Prepare a bootable disk. (You may make one by click START click RUN type SYS A: click OK)
- STEP 2.** Download upgrade tools and the latest BIOS files of the motherboard from official website and then make a copy of it to your bootable floppy disk after decompressing these files
- STEP 3.** Insert the disk into A: start your computer and then type in "A:\xxxxxx.BAT" (xxxxxxx being the file name of the latest BIOS)
- STEP 4.** Type Enter to update and flash the BIOS. The system will restart automatically when BIOS is upgraded.

## 4-11 Pro Magic Plus Function Introduction

### What's Pro Magic Plus?

Tired with reinstall OS each time when it doesn't work? Does your computer often crash down or unable to work after installed new software? Have you had great loses and troubles because of computer problems? Still using time-consuming backup software that occupies lots of HD space?

Pro Magic Plus- an instant system recovery software tailored to solve these problems for you. It combines various application tools (e.g. anti-virus, backup software, uninstall software, multi-boot software) to satisfy your needs of all sorts of system protections.

### What functions does Pro Magic Plus have?

1. **Instant System Restoration** – Regardless of mis-operation or system crash, install Pro Magic Plus beforehand would allow you to instantly restore your system back by simply reboot your computer.
2. **Easy-to-use** – Auto installation from CD ROM; Supports Mouse
3. **System Uninstall** – Pro Magic provides a protection mode, which allows user to freely test any

- software. If user does not want to keep the software, just reboot the computer to restore back to the previous state, and Pro Magic will remove it completely from your computer.
4. **Password Security** – Pro Magic provides double password protection, including user password for entering each OS and manager password for managing 'Pro Magic', which can effectively prevent others from using your computer without permission or data from being stolen. (disable item for OEM version)
  5. **Complete Protection** – Pro Magic not only protects the system disk, but also can protect your data disk, and does not require rebooting when backup or restoring data disk.
  6. **Multipoint Save/Restore** – You can backup your system whenever you need and restore them back to anytime you wish, 1 hour, 1 day or 1 month ago. Restore points are unlimited. (disable item for OEM version)
  7. **Data Disk Protection** – Pro Magic Plus now comes with data disk protection, provides complete protection for your computer! (disable item for OEM version)
  8. **You can choose to change the default path of 'My Document', 'My Favorite' and 'Outlook Express'**, so that when you are restoring the system, data in these folders will not be restored as well. (This is optional; you can leave it as it is).

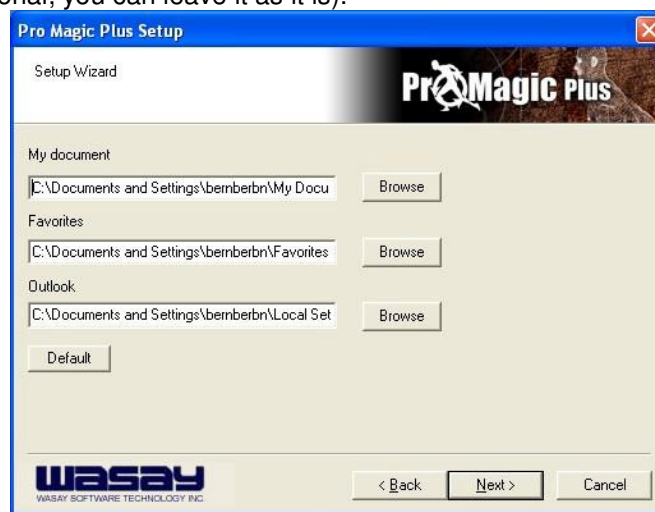

graph 4

**NOTE:** Functions of each version will differ from each other, and will be based on the function descriptions of each version.

## System Requirements

- ◇ First OS must be WindowsXP/Vista/7
- ◇ Support Only Windows OS (No Linux)
- ◇ Windows server OS and Windows NT not supported
- ◇ Minimum of Intel 486 or above, 16MB of memory or above
- ◇ Minimum of 500MB free/usable space or above
- ◇ Support for SCSI & SATA Hard disk

*Pro Magic Plus only supports SCSI hard disk with Windows XP or OS above*

## Notice Before Installation

1. Before install Pro Magic Plus, turn off all anti-virus software. (Include BIOS anti-virus function)
2. Pro Magic Plus does not support multiple PRI partitions. If you have multiple PRI partitions, please repartition your HD before installation.
3. If your HDD is not fully partitioned (with un-partitioned/unused space at end of HDD), please repartition the HDD before install Pro Magic Plus.

---

---

## 4-12 G.P.I. Function LED Display

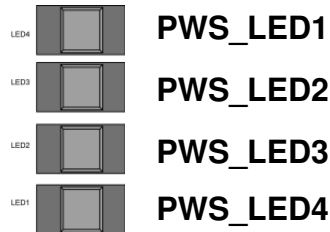

All LED off or glitter. It means the motherboard in the G.P.I mode. CPU works with the low power consumption.



Three LED off or glitter. It means the motherboard is working on partial power saving mode. (The LED off indicate the relative power phase working with idle mode).



Three LED on. It means the motherboard is working on partial power saving mode. (The LED off indicate the relative power phase working with idle mode)

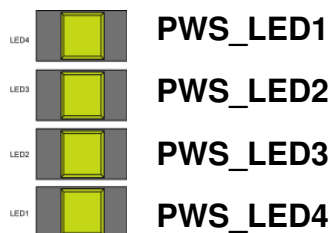

All LED on. It means the motherboard is working at full-speed with non- power saving mode. CPU is working on high-load state.

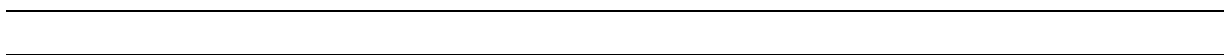

## Free Manuals Download Website

<http://myh66.com>

<http://usermanuals.us>

<http://www.somanuals.com>

<http://www.4manuals.cc>

<http://www.manual-lib.com>

<http://www.404manual.com>

<http://www.luxmanual.com>

<http://aubethermostatmanual.com>

Golf course search by state

<http://golfingnear.com>

Email search by domain

<http://emailbydomain.com>

Auto manuals search

<http://auto.somanuals.com>

TV manuals search

<http://tv.somanuals.com>