

ESM-2850

Intel Pentium® M/Celeron® M ETXexpress Module

User's Manual

2nd Ed – 22 September 2006

Part No. 2047285001R

FCC Statement



THIS DEVICE COMPLIES WITH PART 15 FCC RULES. OPERATION IS SUBJECT TO THE FOLLOWING TWO CONDITIONS:

- (1) THIS DEVICE MAY NOT CAUSE HARMFUL INTERFERENCE.
- (2) THIS DEVICE MUST ACCEPT ANY INTERFERENCE RECEIVED INCLUDING INTERFERENCE THAT MAY CAUSE UNDESIRE OPERATION.

THIS EQUIPMENT HAS BEEN TESTED AND FOUND TO COMPLY WITH THE LIMITS FOR A CLASS "A" DIGITAL DEVICE, PURSUANT TO PART 15 OF THE FCC RULES.

THESE LIMITS ARE DESIGNED TO PROVIDE REASONABLE PROTECTION AGAINST HARMFUL INTERFERENCE WHEN THE EQUIPMENT IS OPERATED IN A COMMERCIAL ENVIRONMENT. THIS EQUIPMENT GENERATES, USES, AND CAN RADIATE RADIO FREQUENCY ENERGY AND, IF NOT INSTALLED AND USED IN ACCORDANCE WITH THE INSTRUCTION MANUAL, MAY CAUSE HARMFUL INTERFERENCE TO RADIO COMMUNICATIONS.

OPERATION OF THIS EQUIPMENT IN A RESIDENTIAL AREA IS LIKELY TO CAUSE HARMFUL INTERFERENCE IN WHICH CASE THE USER WILL BE REQUIRED TO CORRECT THE INTERFERENCE AT HIS OWN EXPENSE.

Notice

This guide is designed for experienced users to setup the system within the shortest time. For detailed information, please always refer to the electronic user's manual.

Copyright Notice

Copyright © 2006 Evalue Technology Inc., ALL RIGHTS RESERVED.

No part of this document may be reproduced, copied, translated, or transmitted in any form or by any means, electronic or mechanical, for any purpose, without the prior written permission of the original manufacturer.

Trademark Acknowledgement

Brand and product names are trademarks or registered trademarks of their respective owners.

Disclaimer

Evalue Technology Inc. reserves the right to make changes, without notice, to any product, including circuits and/or software described or contained in this manual in order to improve design and/or performance. Evalue Technology assumes no responsibility or liability for the use of the described product(s), conveys no license or title under any patent, copyright, or masks work rights to these products, and makes no representations or warranties that these products are free from patent, copyright, or mask work right infringement, unless otherwise specified. Applications that are described in this manual are for illustration purposes only. Evalue Technology Inc. makes no representation or warranty that such application will be suitable for the specified use without further testing or modification.

Life Support Policy

Evalue Technology's PRODUCTS ARE NOT FOR USE AS CRITICAL COMPONENTS IN LIFE SUPPORT DEVICES OR SYSTEMS WITHOUT THE PRIOR WRITTEN APPROVAL OF Evalue Technology Inc.

As used herein:

1. Life support devices or systems are devices or systems which, (a) are intended for surgical implant into body, or (b) support or sustain life and whose failure to perform, when properly used in accordance with instructions for use provided in the labeling, can be reasonably expected to result in significant injury to the user.
2. A critical component is any component of a life support device or system whose failure to perform can be reasonably expected to cause the failure of the life support device or system, or to affect its safety or effectiveness.

A Message to the Customer

Evalue Customer Services

Each and every Evalue's product is built to the most exacting specifications to ensure reliable performance in the harsh and demanding conditions typical of industrial environments. Whether your new Evalue device is destined for the laboratory or the factory floor, you can be assured that your product will provide the reliability and ease of operation for which the name Evalue has come to be known.

Your satisfaction is our primary concern. Here is a guide to Evalue's customer services. To ensure you get the full benefit of our services, please follow the instructions below carefully.

Technical Support

We want you to get the maximum performance from your products. So if you run into technical difficulties, we are here to help. For the most frequently asked questions, you can easily find answers in your product documentation. These answers are normally a lot more detailed than the ones we can give over the phone. So please consult the user's manual first.

To receive the latest version of the user's manual; please visit our Web site at:

<http://www.evaluate-tech.com/>

If you still cannot find the answer, gather all the information or questions that apply to your problem, and with the product close at hand, call your dealer. Our dealers are well trained and ready to give you the support you need to get the most from your Evaluate's products. In fact, most problems reported are minor and are able to be easily solved over the phone.

In addition, free technical support is available from Evaluate's engineers every business day. We are always ready to give advice on application requirements or specific information on the installation and operation of any of our products. Please do not hesitate to call or e-mail us.

Headquarters

Evalue Technology Inc.

7F, 228, Lian-cheng Road,
Chung Ho City, Taipei,
Taiwan

Tel : +886-2-8226-2345

Fax : +886-2-8226-2777

<http://www.evaluate-tech.com>

E-mail: service@evaluate-tech.com

Europe Branch Office

Evalue Europe A/S

Stenholttsvej 13,
3480 Fredensborg,
Denmark

Tel : +45-7025-0310

Fax : +45-4975-5026

<http://www.evaluate-tech.com>

E-mail: service.europe@evaluate-tech.com

China Branch Office

Evalue Technology Shanghai Inc.

Room 909, 9F, Section B, No.900,
Yisan Road, Caohejing Hi-tech Park,
Shanghai 200233, China

Tel : +86-21-5423-4170

Fax : +86-21-5423-4171

<http://www.evaluate-tech.com>

E-mail: service.china@evaluate-tech.com

US Branch Office

Evalue Technology Inc.

Suite 210, 200 Tornillo Way,
Tinton Falls, NJ 07712
USA

Tel: +1-732-578-0200

Fax: +1-732-578-0250

<http://www.evaluate-tech.com>

E-mail: service.usa@evaluate-tech.com

Product Warranty

Evalue warrants to you, the original purchaser, that each of its products will be free from defects in materials and workmanship for two years from the date of purchase.

This warranty does not apply to any products which have been repaired or altered by persons other than repair personnel authorized by Evalue, or which have been subject to misuse, abuse, accident or improper installation. Evalue assumes no liability under the terms of this warranty as a consequence of such events. Because of Evalue's high quality-control standards and rigorous testing, most of our customers never need to use our repair service. If any of Evalue's products is defective, it will be repaired or replaced at no charge during the warranty period. For out-of-warranty repairs, you will be billed according to the cost of replacement materials, service time, and freight. Please consult your dealer for more details. If you think you have a defective product, follow these steps:

1. Collect all the information about the problem encountered. (For example, CPU type and speed, Evalue's products model name, hardware & BIOS revision number, other hardware and software used, etc.) Note anything abnormal and list any on-screen messages you get when the problem occurs.
2. Call your dealer and describe the problem. Please have your manual, product, and any helpful information available.
3. If your product is diagnosed as defective, obtain an RMA (return material authorization) number from your dealer. This allows us to process your good return more quickly.
4. Carefully pack the defective product, a complete Repair and Replacement Order Card and a photocopy proof of purchase date (such as your sales receipt) in a shippable container. A product returned without proof of the purchase date is not eligible for warranty service.
5. Write the RMA number visibly on the outside of the package and ship it prepaid to your dealer.

Contents

1. Getting Started	9
1.1 Safety Precautions	9
1.2 Packing List	9
1.3 Document Amendment History	10
1.4 Manual Objectives	11
1.5 System Specifications	12
1.6 Architecture Overview	13
1.6.1 Block Diagram	13
1.6.2 Intel NQ82915GM and FW82801FMB ICH6-M	14
1.6.3 Ethernet	16
2. Hardware Configuration	17
2.1 Product Overview	18
2.2 Installation Procedure	19
2.2.1 Processor Installation	19
2.2.2 Main Memory	20
2.3 Jumper and Connector List	22
2.4 Setting Jumpers & Connectors	23
2.4.1 CPU Frequency Select / Clear CMOS (SW1)	23
2.4.2 ETX Express Connector 1 (CN1A)	24
2.4.3 ETX Express Connector 2 (CN1B)	33
3 BIOS Setup	39
3.1 Starting Setup	40
3.2 Using Setup	41
3.3 Getting Help	42
3.4 In Case of Problems	42
3.5 Main Menu	43
3.5.1 Standard CMOS Features	44
3.5.2 Advanced BIOS Features	46
3.5.3 Advanced Chipset Features	50
3.5.4 Integrated Peripherals	54
3.5.5 Power Management Setup	58
3.5.6 PnP / PCI Configuration	61
3.5.7 PC Health Status	62
3.5.8 Load Fail-Safe Defaults	63
3.5.9 Load Optimized Defaults	63
3.5.10 Set Supervisor / User Password	64

3.5.11	Save & Exit Setup	65
3.5.12	Exit Without Save.....	66
4	Drivers Installation	67
4.1	Install Chipset Driver (For Intel NQ82915GM)	68
4.2	Install Display Driver (For Intel NQ82915GM).....	69
4.3	Install Audio Driver (For VIA VT1616).....	70
4.4	Install Ethernet Driver (For Marvell 88E8053 Gigabit LAN).....	71
5	Measurement Drawing	73
	Appendix A: BIOS Revisions	75
	Appendix B: AWARD BIOS POST Messages	76
	Overview.....	77
	Post Beep	77
	Error Messages	77
1.	CMOS BATTERY HAS FAILED	77
2.	CMOS CHECKSUM ERROR	77
3.	DISK BOOT FAILURE, INSERT SYSTEM DISK AND PRESS ENTER	77
4.	DISKETTE DRIVES OR TYPES MISMATCH ERROR - RUN SETUP.....	77
5.	DISPLAY SWITCH IS SET INCORRECTLY.....	78
6.	DISPLAY TYPE HAS CHANGED SINCE LAST BOOT	78
7.	EISA Configuration Checksum Error PLEASE RUN EISA CONFIGURATION UTILITY.....	78
8.	EISA Configuration Is Not Complete PLEASE RUN EISA CONFIGURATION UTILITY	78
9.	ERROR ENCOUNTERED INITIALIZING HARD DRIVE.....	78
10.	ERROR INITIALIZING HARD DISK CONTROLLER	78
11.	FLOPPY DISK CNTRLR ERROR OR NO CNTRLR PRESENT	78
12.	Invalid EISA Configuration PLEASE RUN EISA CONFIGURATION UTILITY	79
13.	KEYBOARD ERROR OR NO KEYBOARD PRESENT	79
14.	Memory Address Error at	79
15.	Memory parity Error at	79
16.	MEMORY SIZE HAS CHANGED SINCE LAST BOOT	79
17.	Memory Verify Error at	79
18.	OFFENDING ADDRESS NOT FOUND	79
19.	OFFENDING SEGMENT:	79
20.	PRESS A KEY TO REBOOT	80
21.	PRESS F1 TO DISABLE NMI, F2 TO REBOOT	80
22.	RAM PARITY ERROR - CHECKING FOR SEGMENT	80
23.	Should Be Empty But EISA Board Found PLEASE RUN EISA CONFIGURATION UTILITY	80
24.	Should Have EISA Board But Not Found PLEASE RUN EISA CONFIGURATION UTILITY	80
25.	Slot Not Empty	80
26.	SYSTEM HALTED, (CTRL-ALT-DEL) TO REBOOT	80

ESM-2850

27.	Wrong Board In Slot PLEASE RUN EISA CONFIGURATION UTILITY	81
28.	FLOPPY DISK(S) fail (80) → Unable to reset floppy subsystem.....	81
29.	FLOPPY DISK(S) fail (40) → Floppy Type mismatch.....	81
30.	Hard Disk(s) fail (80) → HDD reset failed.....	81
31.	Hard Disk(s) fail (40) → HDD controller diagnostics failed.....	81
32.	Hard Disk(s) fail (20) → HDD initialization error.....	81
33.	Hard Disk(s) fail (10) → Unable to recalibrate fixed disk.....	81
34.	Hard Disk(s) fail (08) → Sector Verify failed.....	81
35.	Keyboard is locked out - Unlock the key.....	81
36.	Keyboard error or no keyboard present.....	81
37.	Manufacturing POST loop.....	81
38.	BIOS ROM checksum error - System halted.....	81
39.	Memory test fail.....	81
40.	POST Codes	82

1. Getting Started

1.1 Safety Precautions

Warning!



Always completely disconnect the power cord from your chassis whenever you work with the hardware. Do not make connections while the power is on. Sensitive electronic components can be damaged by sudden power surges. Only experienced electronics personnel should open the PC chassis.

Caution!



Always ground yourself to remove any static charge before touching the CPU card. Modern electronic devices are very sensitive to static electric charges. As a safety precaution, use a grounding wrist strap at all times. Place all electronic components in a static-dissipative surface or static-shielded bag when they are not in the chassis.

1.2 Packing List

Before you begin installing your single board, please make sure that the following materials have been shipped:

- 1 x ESM-2850 Intel Pentium® M/Celeron® M ETXexpress Board
- 1 x Quick Installation Guide
- 1 x CD-ROM or DVD-ROM contains the followings:
 - User's Manual (this manual in PDF file)
 - Ethernet driver and utilities
 - VGA drivers and utilities
 - Audio drivers and utilities



If any of the above items is damaged or missing, contact your retailer.

1.3 Document Amendment History

Revision	Date	By	Comment
1 st	Feb. 2006	Vicky Lin	Initial Release
2 nd	Sep. 2006	Vicky Lin	1) 2.4.2 Signals of CN1A modified 2) 2.4.3 Signals of CN1B modified

1.4 Manual Objectives

This manual describes in detail the Evalue Technology ESM-2850 series Single Board.







We have tried to include as much information as possible but we have not duplicated information that is provided in the standard IBM Technical References, unless it proved to be necessary to aid in the understanding of this board.

We strongly recommend that you study this manual carefully before attempting to interface with ESM-2850 series or change the standard configurations. Whilst all the necessary information is available in this manual we would recommend that unless you are confident, you contact your supplier for guidance.

Please be aware that it is possible to create configurations within the CMOS RAM that make booting impossible. If this should happen, clear the CMOS settings, (see the description of the Jumper Settings for details).

If you have any suggestions or find any errors concerning this manual and want to inform us of these, please contact our Customer Service department with the relevant details.

1.5 System Specifications

System 	
CPU	Supports 90nm Intel® µFC-PGA 478 / µFC-BGA 479 Pentium® M / Celeron® M CPU Note: Available in different CPU speeds by request
BIOS	Award 512 KB Flash BIOS
System Chipset	Intel® NQ82915GM GMCH/FW82801FBM ICH6-M
System Memory	One 200-pin DDR2 SODIMM socket supports up to 1 GB DDR2 533 SDRAM
Watchdog Timer	Reset: 1 sec.~255 min. and 1 sec. or 1 min./step (from the base board)
Expansion	Four PCI slots (PCI Rev. 2.3 compliant), three PCI Express x1 slot, one PCI Express x16 slot
I/O 	
MIO	2 x EIDE (Ultra DMA 100), 2 x SATA
USB	8 x USB 2.0 ports
DIO	4-bit GPI and 4-bit GPO
Display 	
Chipset	Intel® NQ82915GM GMCH integrated Extreme Graphics controller
Display Memory	Intel® DVMT 3.0 supports up to 128 MB video memory
Resolution	CRT mode: 2048 x 1536 @ 32 bpp (85 Hz) LCD/Simultaneous mode: 1600 x 1200 @ 16 bpp (60 Hz)
Dual Display	CRT + LVDS
LVDS	Dual-channel 18-bit LVDS
TV-Out	Intel® NQ82915GM GMCH integrated TV interface supports HDTV
Audio 	
Chipset	Intel® FW82801FBM ICH6-M
Ethernet 	
LAN	Marvell 88E8053
Ethernet Interface	1000Base-T Fast Ethernet compatible
Mechanical & Environmental 	
Power Requirement	+5 V @ 0.24 A, +12 V @ 3.51 A, +3.3 V @ 0.04 A, 5 Vsb @ 0.42 A (with Intel® Pentium® M 1.86 GHz & 256 MB DDR2 533 SDRAM)
Power Type	ATX
Operation Temperature	0~60°C (32~140°F)
Operating Humidity	0%~90% relative humidity, non-condensing
Size (L x W)	5" x 3.7" (125 mm x 95 mm)
Weight	0.44 lbs (0.2 Kg)

1.6 Architecture Overview

1.6.1 Block Diagram

The following block diagram shows the architecture and main components of ESM-2850 series.

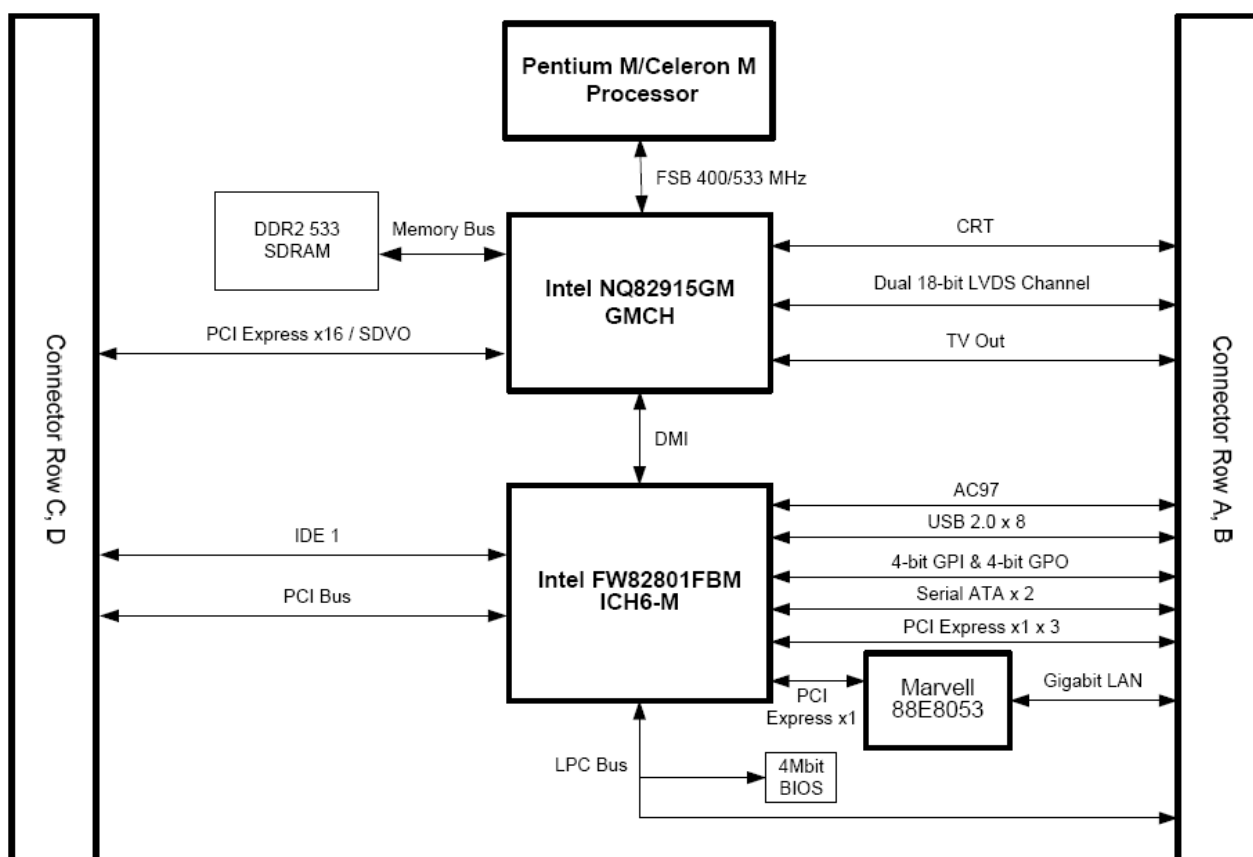

The following sections provide detail information about the functions provided onboard.

1.6.2 Intel NQ82915GM and FW82801FMB ICH6-M

The Mobile Intel® 915GM Express Chipset for Embedded Computing, consisting of the Intel® 915GM Graphic Memory Controller Hub (GMCH) and Intel® I/O Controller Hub 6-M (ICH6-M), is an optimized integrated graphics solution with a 400 MHz and 533 MHz front-side bus. The integrated 32-bit 3D graphics engine, based on Intel® Graphics Media Accelerator 900 (Intel® GMA 900) architecture, operates at core speeds of up to 320 MHz. It features a lowpower design, is validated with the Intel® Pentium® M and Intel® Celeron® M processors on 90nm process, and supports up to 2 GB system memory.

Intel's platform architecture delivers the performance and high scalability required for today's cutting-edge embedded computing applications. The Intel 915GM GMCH and ICH6-M are part of Intel's comprehensive validation process that enables fast deployment of next-generation platforms to maximize competitive advantage while minimizing development risks.

Intel 915GM chipset adds enhancements for the following areas:

- System Memory
- PCI Express Based Graphics (discrete graphics devices)
- Intel Graphics enhancements:
 - DVMT 3.0 support
 - Zone Rendering 2.0 support
 - Quad pixel pipe rendering engine
 - Pixel Shader 2.0 support
 - 4x Faster Setup Engine
 - TV Out Support
 - HDTV resolution support
 - LVDS support
 - Wide panel support
 - Ambient Light Sense support for automatic backlight brightness adjustments
 - Intel Display Power Savings Technology 2.0 support
 - Integrated PWM interface for LCD Backlight Inverter Control
 - Direct Media Interface (DMI)

The GMCH integrates a system memory DDR controller with two, 64-bit wide interfaces. Only double Data Rate (DDR) memory is supported; consequently, the buffers support DDR SSTL_2 signaling interfaces. The memory controller interface is fully configurable through a set of control registers.

Three system memory modes of operation supported are:

- Single Channel mode
- Dual Channel Asymmetric mode
- Dual Channel Symmetric mode

The GMCH contains one 16-lane (x16) PCI Express port intended for an external PCI Express Based graphics card. The PCI Express port is fully compliant to the PCI Express Base Specification revision 1.0a. The x16 port operates at a data rate of 2.5 GB/s while employing 8b/10b encoding. This allows a maximum theoretical bandwidth of 40 GB/s each direction. Intel 915GM/ PM may also be configured as PCI Express x1 port.

The GMCH is capable of driving a CRT, LCD panel, Analog TV and/or two SDVO devices (SDVO ports are mixed with PCI Express). The display is the defining portion of a graphics controller. The display converts a set of source images or surfaces, combines them and sends them out at the proper timing to an output interface connected to a display device. Along the way, the data can be converted from one format to another, stretched or shrunk, and color corrected or gamma converted.

The GMCH supports two SDVO ports multiplexed with PCI Express Graphics interface. The SDVO ports are capable of driving a variety of external TV-Out, TMDS, and LVDS transmitter devices. SDVO devices are capable of driving a standard progressive scan analog monitor with resolutions up to 2048x1536 at 75 Hz. This interface may be configured for as PCI Express x1 port also.

DMI is a point -to- point connection from the GMCH to the ICH6-M.

1.6.3 Ethernet

1.6.3.1 Marvell 88EE8053 Gigabit Ethernet Controller

The single-chip PCI Express based 88E8053 device is ideally suited for LAN on motherboard (LOM) and Network Interface Card (NIC) applications. The 88E8053 device is compliant with the PCI Express 1.0a specification. Offered in a 9 x 9 mm, 64-pin QFN package, the 88E8053 reduces board space required for Gigabit LOM implementation significantly.

- PCI Express Features:
 - PCI Express base specification 1.0a compliant
 - X1 PCI Express interface with 2.5 GHz signaling
 - Active state power management (Los) support
 - Advanced error reporting
- MAC/PHY Features:
 - Configurable 48 KB deep buffer
 - Descriptor bursting and caching
 - Message signalled interrupts
 - TCP segmentation offload/Large-send support
 - On-chip VLAN insertion and removal
 - TCP, IP, UDP Checksum offload
 - Interrupt moderation Jumbo Frame support
 - Compliant to 802.3x flow control support
 - IEEE 802.1p and 802.1q support
 - 10/100/1000 IEEE 802.3 compliant
 - Automatic MDI/MDIX crossover at all speeds
- Manageability:
 - Wake On LAN (WOL) power management support compliant to ACPI 2.0 specification
 - Out of the box WOL support
 - Wake On Link
 - Serial Peripheral Interface (SPI) for remote boot (PXE 2.1)
 - Smart Power down when link is not detected
 - Marvell virtual Cable Tester (VCT) for advanced cable diagnostics
- Others:
 - LOM disable pin
 - Power regulator outputs for 2.5V and 1.2V supplies
 - Tow Wire Serial Interface (TWSI) for VPD EEPROM
 - 9 mm x 9 mm, 64-pin QFN package

2. Hardware Configuration

2.1 Product Overview

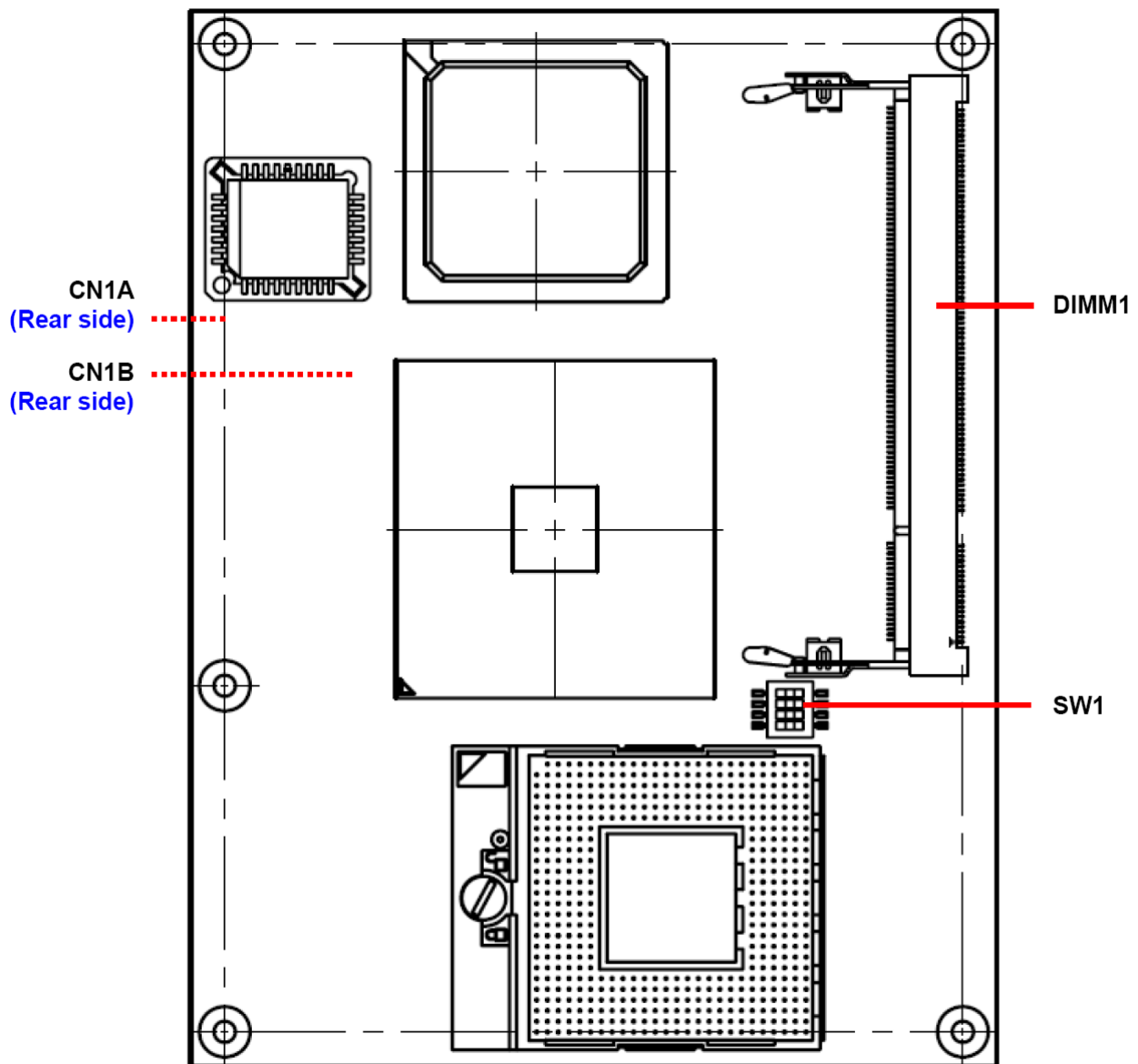

2.2 Installation Procedure

This chapter explains you the instructions of how to setup your system.

1. Turn off the power supply.
2. Insert the DIMM module (be careful with the orientation).
3. Insert all external cables for hard disk, floppy, keyboard, mouse, USB etc. except for flat panel. A CRT monitor must be connected in order to change CMOS settings to support flat panel.
4. Connect power supply to the board via the ATXPWR.
5. Turn on the power.
6. Enter the BIOS setup by pressing the delete key during boot up. Use the "LOAD BIOS DEFAULTS" feature. The **Integrated Peripheral Setup** and the **Standard CMOS Setup** Window must be entered and configured correctly to match the particular system configuration.
7. If TFT panel display is to be utilized, make sure the panel voltage is correctly set before connecting the display cable and turning on the power.

2.2.1 Processor Installation

2.2.1.1 Installing Pentium M CPU

- The processor socket comes with a screw to secure the processor, please unlock the screw first.
- Position the CPU above the socket and the gold triangular mark on the CPU must align with pin 1 of the CPU socket. Then Insert the CPU gently seated in place.
- Turn the screw to the lock position.

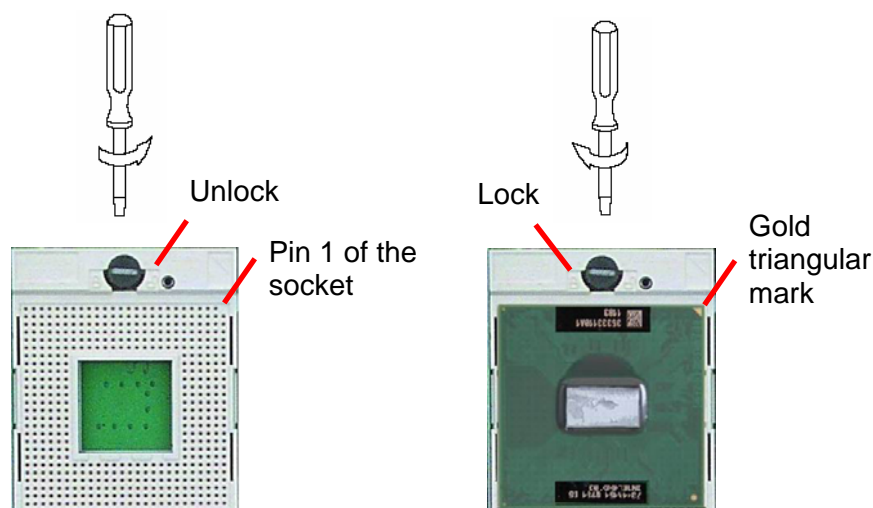

Note: Do not force the CPU into the socket. It may bend the pins and damage the CPU.

ESM-2850

2.2.1.2 Removing CPU

- Unlock the Pentium M processor.
- Carefully lift up the existing CPU to remove it from the socket.
- Follow the steps of installing a CPU to change to another one.

2.2.2 Main Memory

ESM-2850 series provide two 200-pin SODIMM sockets to support DDR2 533 SDRAM. The total maximum memory size is 1 GB.

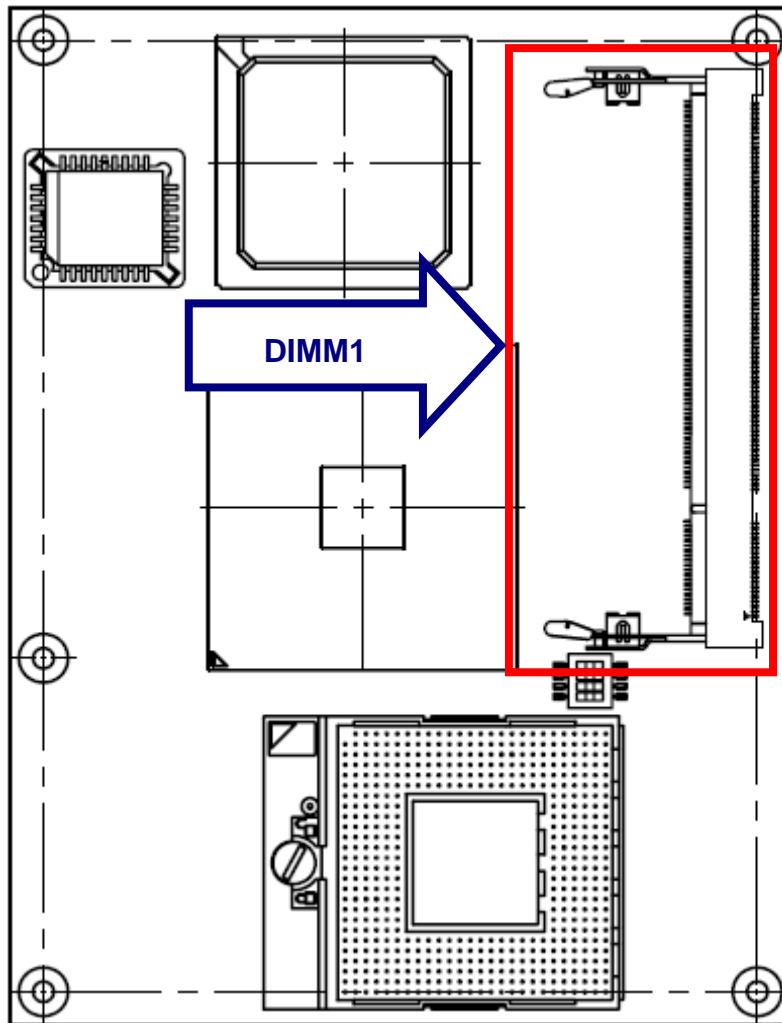

Make sure to unplug the power supply before adding or removing DIMMs or other system components. Failure to do so may cause severe damage to both the board and the components.

- Locate the DIMM socket on the board.
- Hold two edges of the DIMM module carefully. Keep away of touching its connectors.
- Align the notch key on the module with the rib on the slot.
- Firmly press the modules into the socket automatically snaps into the mounting notch. Do not force the DIMM module in with extra force as the DIMM module only fit in one direction.

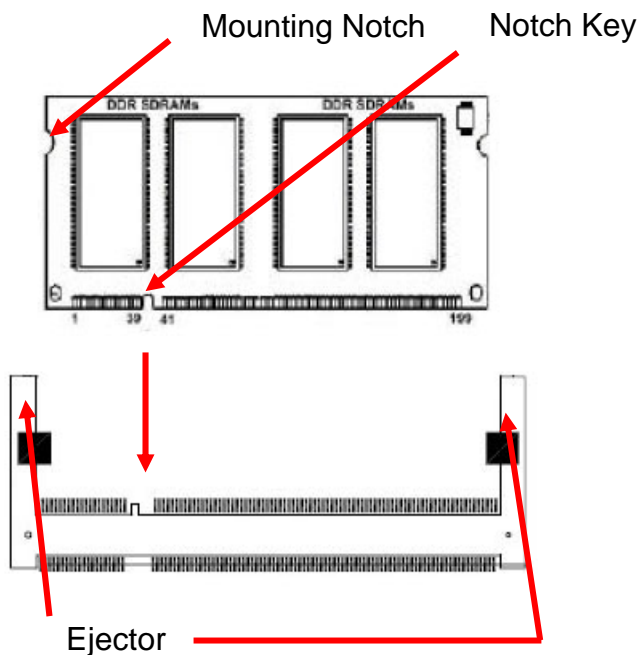

200-pin DDR2 DIMM

- To remove the DIMM modules, push the two ejector tabs on the slot outward simultaneously, and then pull out the DIMM module.



Note:

- (1) Please do not change any DDR2 SDRAM parameter in BIOS setup to increase your system's performance without acquiring technical information in advance.
- (2) Static electricity can damage the electronic components of the computer or optional boards. Before starting these procedures, ensure that you are discharged of static electricity by touching a grounded metal object briefly.

2.3 Jumper and Connector List

You can configure your board to match the needs of your application by setting jumpers. A jumper is the simplest kind of electric switch.

It consists of two metal pins and a small metal clip (often protected by a plastic cover) that slides over the pins to connect them. To “close” a jumper you connect the pins with the clip. To “open” a jumper you remove the clip. Sometimes a jumper will have three pins, labeled 1, 2, and 3. In this case, you would connect either two pins.

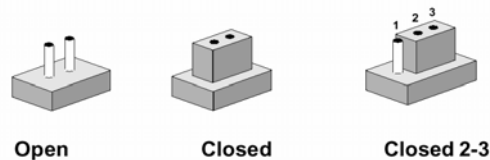

The jumper settings are schematically depicted in this manual as follows:



A pair of needle-nose pliers may be helpful when working with jumpers.

Connectors on the board are linked to external devices such as hard disk drives, a keyboard, or floppy drives. In addition, the board has a number of jumpers that allow you to configure your system to suit your application.

If you have any doubts about the best hardware configuration for your application, contact your local distributor or sales representative before you make any changes.

The following tables list the function of each of the board's jumpers and connectors.

Jumpers

Label	Function	Note
SW1	CPU Frequency Select / Clear CMOS	Switch

Connectors

Label	Function	Note
CN1A	ETX Express connector 1	
CN1B	ETX Express connector 2	
DIMM1	200-pin SODIMM socket	

2.4 Setting Jumpers & Connectors

2.4.1 CPU Frequency Select / Clear CMOS (SW1)

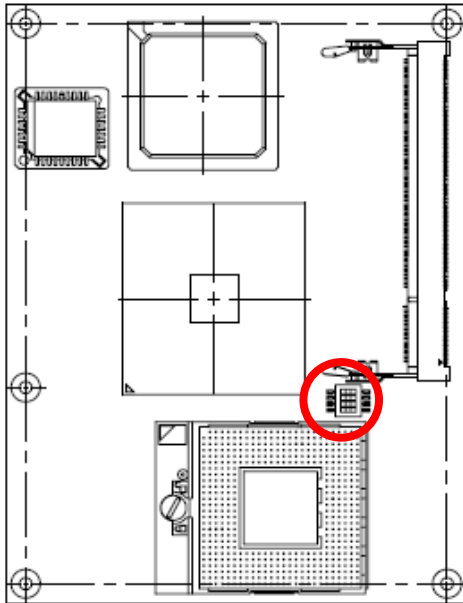

* Default

CPU Frequency Select (Bit 1 & 2)

Auto Detected* 100 MHz

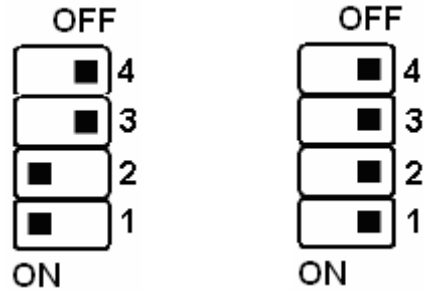

Clear CMOS (Bit 3)

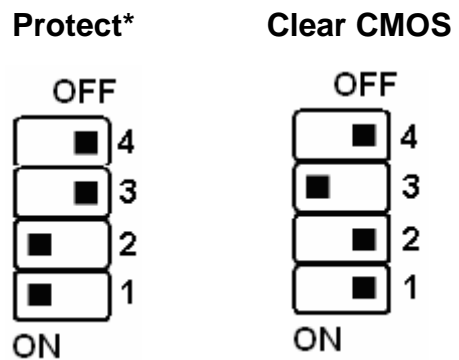

ESM-2850

2.4.2 ETX Express Connector 1 (CN1A)

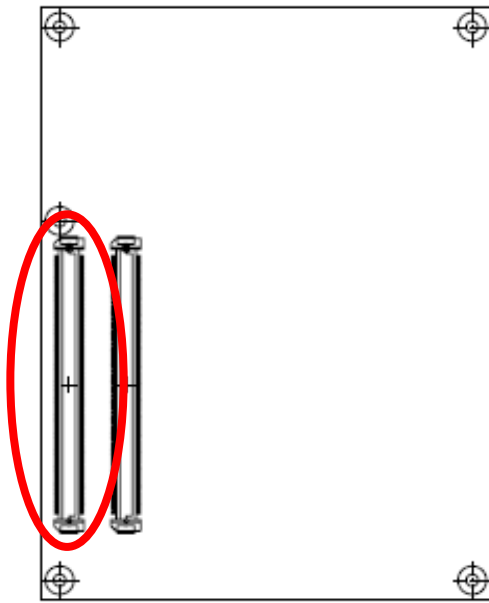

(Rear side)



Signal	PIN	PIN	Signal
GND	A1	B1	GND
GBE0_MD3-	A2	B2	GBE0_ACT#
GBE0_MD3+	A3	B3	LPC_FRAME#
GBE0_Link100#	A4	B4	LPC_AD0
GBE0_Link1000#	A5	B5	LPC_AD1
GBE0_MD2-	A6	B6	LPC_AD2
GBE0_MD2+	A7	B7	LPC_AD3
GBE0_Link#	A8	B8	LPC_DRQ0#
GBE0_MD1-	A9	B9	LPC_DRQ1#
GBE0_MD1+	A10	B10	LPC_CLK
GND	A11	B11	GND
GBE0_MD0-	A12	B12	PWRBTN#
GBE0_MD0+	A13	B13	SMB_CK
+2.5V	A14	B14	SMB_DTA
SUS_S3#	A15	B15	SMB_ALERT#
SATA0_TX+	A16	B16	SATA1_TX+
SATA0_TX-	A17	B17	SATA1_TX-
SUS_S4#	A18	B18	SUS_STAT#
SATA0_RX+	A19	B19	SATA1_RX+
SATA0_RX-	A20	B20	SATA1_RX-
GND	A21	B21	GND
SATA2_TX+	A22	B22	SATA3_TX+
SATA2_TX-	A23	B23	SATA3_TX-
SUS_S5#	A24	B24	PWR_OK
SATA2_RX+	A25	B25	SATA3_RX+
SATA2_RX-	A26	B26	SATA3_RX-
BATLOW#	A27	B27	WDT
ATA_ACT#	A28	B28	AC_SDIN2
AC_SYNC	A29	B29	AC_SDIN1
AC_RST#	A30	B30	AC_SDIN0

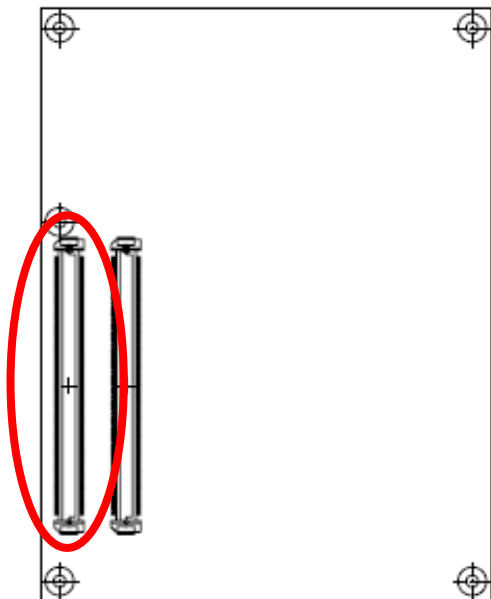

(Rear side)



Signal	PIN	PIN	Signal
GND	A31	B31	GND
AC_BITCLK	A32	B32	SPKR
AC_SDOOUT	A33	B33	I ² C_CLK
NC	A34	B34	I ² C_DAT
THRMTRIP#	A35	B35	THRM#
USB6-	A36	B36	USB7-
USB6+	A37	B37	USB7-
USB_6_7_OC#	A38	B38	USB_4_5_OC#
USB4-	A39	B39	USB5-
USB4+	A40	B40	USB5+
GND	A41	B41	GND
USB2-	A42	B42	USB3-
USB2+	A43	B43	USB3+
USB_2_3_OC#	A44	B44	USB_0_1_OC#
USB0-	A45	B45	USB1-
USB0+	A46	B46	USB1+
VCC_RTC	A47	B47	NC
NC	A48	B48	NC
NC	A49	B49	SYS_RESET#
LPC_SERIRQ	A50	B50	RSMRST#
GND	A51	B51	GND
NC	A52	B52	NC
NC	A53	B53	NC
GPI0	A54	B54	GPO1
NC	A55	B55	NC
NC	A56	B56	NC
GND	A57	B57	GPO2
NC	A58	B58	NC
NC	A59	B59	NC
GND	A60	B60	GND

ESM-2850

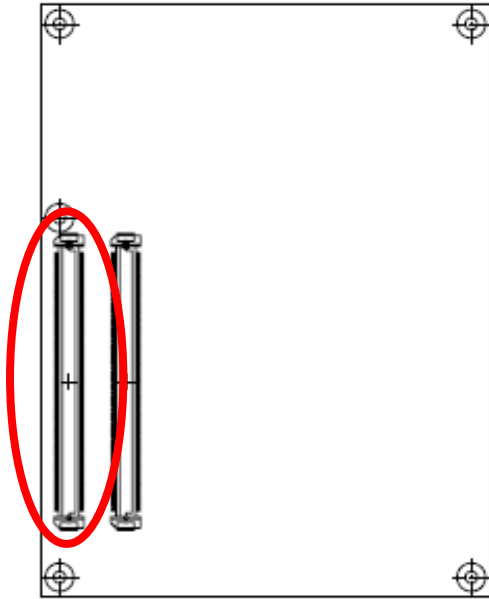

(Rear side)

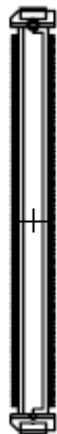

Signal	PIN	PIN	Signal
PCIE_TX2+	A61	B61	PCIE_RX2+
PCIE_TX2-	A62	B62	PCIE_RX2-
GPI1	A63	B63	GPO3
PCIE_TX1+	A64	B64	PCIE_RX1+
PCIC_TX1-	A65	B65	PCIE_RX1-
GND	A66	B66	WAKE0#
GPI2	A67	B67	WAKE1#
PCIE_TX0+	A68	B68	PCIE_RX0+
PCIE_TX0-	A69	B69	PCIE_RX0-
GND	A70	B70	GND
Txout0	A71	B71	E_Txout0
Txout0#	A72	B72	E_Txout0#
Txout1	A73	B73	E_Txout1
Txout1#	A74	B74	E_Txout1#
Txout2	A75	B75	E_Txout2
Txout2#	A76	B76	E_Txout2#
DIGON	A77	B77	NC
NC	A78	B78	NC
NC	A79	B79	ENBKL#
GND	A80	B80	GND
Txclk	A81	B81	E_Txclk
Txclk#	A82	B82	E_Txclk#
I ² C_CLK	A83	B83	BIASON
I ² C_DAT	A84	B84	VCC_5V_SBY
GPI3	A85	B85	VCC_5V_SBY
KBE_RST#	A86	B86	VCC_5V_SBY
KBD_A20GATE	A87	B87	VCC_5V_SBY
PCIE0_CK_REF+	A88	B88	NC
PCIE0_CK_REF-	A89	B89	VGA_RED
GND	A90	B90	GND

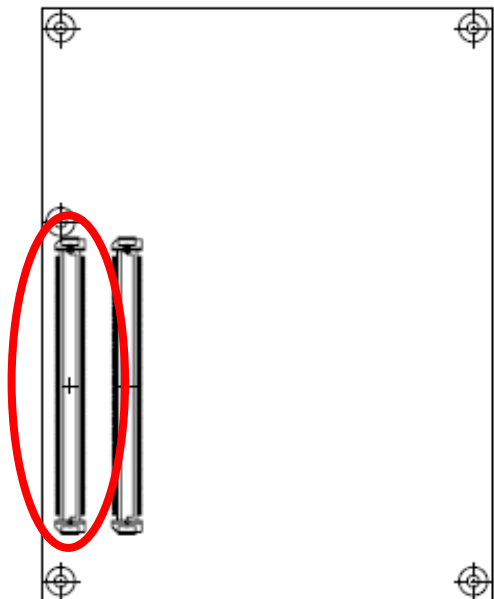

(Rear side)

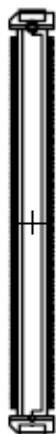

Signal	PIN	PIN	Signal
NC	A91	B91	VGA_GRN
NC	A92	B92	VGA_BLU
GPO0	A93	B93	VGA_HSYNC
NC	A94	B94	VGA_VSYNC
NC	A95	B95	VGA_I ² C_CLK
GND	A96	B96	VGA_I ² C_DAT
+12V	A97	B97	Pb
+12V	A98	B98	Y
+12V	A99	B99	Pr
GND	A100	B100	GND
+12V	A101	B101	+12V
+12V	A102	B102	+12V
+12V	A103	B103	+12V
+12V	A104	B104	+12V
+12V	A105	B105	+12V
+12V	A106	B106	+12V
+12V	A107	B107	+12V
+12V	A108	B108	+12V
+12V	A109	B109	+12V
GND	A110	B110	GND

ESM-2850

2.4.2.1 Signal Description – ETX Express Connector 1 (CN1A)

2.4.2.1.1 Audio Signals

Signal	Signal Description
AC_SYNC	48kHz fixed-rate, sample-synchronization signal to the CODEC(s)
AC_RST#	Reset output to AC97 CODEC, active low.
AC_SDIN[0:2]	Serial TDM data inputs from up to 3 CODECs.
AC_BITCLK	12.228 MHz serial data clock generated by the external CODEC(s)
AC_SDOUT	Serial TDM data output to the CODEC.

2.4.2.1.2 Gigabit Ethernet Signals

Signal	Signal Description																				
GBE0_MD[0:3] +/-	Gigabit Ethernet Controller 0: Media Dependent Interface Differential Pairs 0,1,2,3. The MDI can operate in 1000, 100 and 10 Mbit / sec modes. Some pairs are unused in some modes, per the following:																				
	<table border="1"> <thead> <tr> <th></th> <th>1000B-T</th> <th>100B-T</th> <th>10B-T</th> </tr> </thead> <tbody> <tr> <td>MDI[0] +/-</td> <td>B1_DA+/-</td> <td>TX+/-</td> <td>TX+/-</td> </tr> <tr> <td>MDI[1] +/</td> <td>B1_DB+/-</td> <td>RX+/-</td> <td>RX+/-</td> </tr> <tr> <td>MDI[2] +/</td> <td>B1_DC+/-</td> <td>X</td> <td>X</td> </tr> <tr> <td>MDI[3] +/</td> <td>B1_DD+/-</td> <td>X</td> <td>X</td> </tr> </tbody> </table>		1000B-T	100B-T	10B-T	MDI[0] +/-	B1_DA+/-	TX+/-	TX+/-	MDI[1] +/	B1_DB+/-	RX+/-	RX+/-	MDI[2] +/	B1_DC+/-	X	X	MDI[3] +/	B1_DD+/-	X	X
		1000B-T	100B-T	10B-T																	
	MDI[0] +/-	B1_DA+/-	TX+/-	TX+/-																	
	MDI[1] +/	B1_DB+/-	RX+/-	RX+/-																	
MDI[2] +/	B1_DC+/-	X	X																		
MDI[3] +/	B1_DD+/-	X	X																		
GBE0_ACT#	Gigabit Ethernet Controller 0 activity indicator, active low.																				
GBE0_Link#	Gigabit Ethernet Controller 0 link indicator, active low.																				
GBE0_Link100#	Gigabit Ethernet Controller 0 100 Mbit / sec link indicator, active low.																				
GBE0_Lin1000#	Gigabit Ethernet Controller 0 1000 Mbit / sec link indicator, active low.																				

2.4.2.1.3 GPIO Signals

Signal	Signal Description
GPI[0:3]	General purpose input pins. Pulled high internally on the module.
GPO[0:3]	General purpose output pins. Upon a hardware reset, these outputs will be low.

2.4.2.1.4 Flat Panel LVDS Signals

Signal	Signal Description
BIASON	Controls panel contrast voltage.
DIGON	Controls panel digital power.
ENBKL#	Controls backlight power enable.
I ² C_DAT, I ² C_CLK	I ² C interface for panel parameter EEPROM. This EEPROM is mounted on the LVDS receiver. The data in the EEPROM allows the EXT module to automatically set the proper timing parameters for a specific LCD panel.

2.4.2.1.5 LPC Signals

Signal	Signal Description
LPC_FRAME#	LPC frame indicates the start of an LPC cycle
LPC_AD[0:3]	LPC multiplexed address, command and data bus
LPC_DRQ[0:1]#	LPC serial DMA request
LPC_CLK	LPC clock output - 33MHz nominal
LPC_SERIRQ	LPC serial interrupt

2.4.2.1.6 Miscellaneous Signals

Signal	Signal Description
I ² C_CK	General purpose I ² C port clock output
I ² C_DAT	General purpose I ² C port data I/O line
SPKR	Output for audio enunciator - the "speaker" in PC-AT systems
BIOS_DISABLE#	Module BIOS disable input. Pull low to disable module BIOS. Used to allow off-module BIOS implementations.
KB_RST#	Input to module from (optional) external keyboard controller that can force a reset. Pulled high on the module. This is a legacy artifact of the PC-AT.
KB_A20GATE	Input to module from (optional) external keyboard controller that can be used to control the CPU A20 gate line. The A20GATE restricts the memory access to the bottom megabyte and is a legacy artifact of the PC-AT. Pulled low on the module.

2.4.2.1.7 PCI Express Signals

Signal	Signal Description
PCIE_TX[0:2] +/-	PCI Express Differential Transmit Pair 0-2
PCIE_RX[0:2] +/-	PCI Express Differential Receive Pair 0-2
PCIE0_CK_REF+/-	Reference clock output for PCI Express lanes 0-7 and for PCI Express Graphics lanes 0-15

2.4.2.1.8 Power Signals

Signal	Signal Description
VCC_5V_SBY	Standby power input: +5.0V nominal. See Electrical Specifications for allowable input range. If VCC5_SBY is used, all available VCC_5V_SBY pins on the connector(s) must be used. Only used for standby and suspend functions. May be left unconnected if these functions are not used in the system design.
VCC_RTC	Real-time clock circuit-power input. Nominally +3.0V. See Electrical Specifications section for details.

2.4.2.1.9 Power & System Management Signals

Signal	Signal Description
SUS_S3#	Indicates system is in Suspend to RAM state. Active low output.
SUS_S4#	Indicates system is in Suspend to Disk state. Active low output.
SUS_S5#	Indicates system is in Soft Off state. Also known as "PS_ON" and can be used to control an ATX power supply.
BATLOW#	Indicates that external battery is low
PWRBTN#	Power button to bring system out of S5 (soft off), active on rising edge.
SMB_CK	System Management Bus bidirectional clock line. Power sourced through 5V standby rail and main power rails.
SMB_DTA	System Management Bus bidirectional data line. Power sourced through 5V standby rail and main power rails.
SMB_ALERT#	System Management Bus Alert - input can be used to generate an SMI# (System Management Interrupt) or to wake the system. Power sourced through 5V standby rail and main power rails.
SUS_STAT#	Indicates imminent suspend operation; used to notify LPC devices
PWR_OK	Power OK from main power supply
THRMTRIP#	Active low output indicating that the CPU has entered thermal shutdown.
THRM#	Input from off-module temp sensor indicating and over-temp situation.
SYS_RESET#	Reset button input. Active low input. System is held in hardware reset while this input is low, and comes out of reset upon release.
RSMRST#	Resume reset input, active low. Resets power plane logic. May be left open on carrier board if not used.
WAKE0#	PCI Express wake up signal
WAKE1#	General purpose wake up signal

2.4.2.1.10 SATA Signals

Signal	Signal Description
SATA[0:3]_TX +/-	Serial ATA Channel 0-3 transmit differential pair.
SATA[0:3]_RX +/-	Serial ATA Channel 0-3 receive differential pair.
ATA_ACT#	ATA (parallel and serial) activity indicator, active low.

ESM-2850

2.4.2.1.11 TV Out Signals

Signal	Signal Description
Pb	TVDAC Channel A Output supports the following: Composite: CVBS signal Component: Chrominance (Pb) analog signal.
Y	TVDAC Channel B Output supports the following: S-Video: Luminance analog signal. Component: Luminance (Y) analog signal.
Pr	TVDAC Channel C Output supports the following: S-Video: Chrominance analog signal. Component: Chrominance (Pr) analog signal.

2.4.2.1.12 VGA Signals

Signal	Signal Description
VGA_RED	Red for monitor. Analog DAC output, designed to drive a 37.5-Ohm equivalent load.
VGA_GRN	Green for monitor. Analog DAC output, designed to drive a 37.5-Ohm equivalent load.
VGA_BLU	Blue for monitor. Analog DAC output, designed to drive a 37.5-Ohm equivalent load.
VGA_HSYNC	Horizontal sync output to VGA monitor
VGA_VSYNC	Vertical sync output to VGA monitor
VGA_I ² C_CLK	DDC clock line (I2C port dedicated to identify VGA monitor capabilities)
VGA_I ² C_DAT	DDC data line.

2.4.2.1.13 USB Signals

Signal	Signal Description
USB[0:7] +/-	USB differential pairs, channels 0 through 7
USB_0_1_OC#	USB over-current sense, USB channels 0 and 1
USB_2_3_OC#	USB over-current sense, USB channels 2 and 3
USB_4_5_OC#	USB over-current sense, USB channels 4 and 5
USB_6_7_OC#	USB over-current sense, USB channels 6 and 7

2.4.3 ETX Express Connector 2 (CN1B)

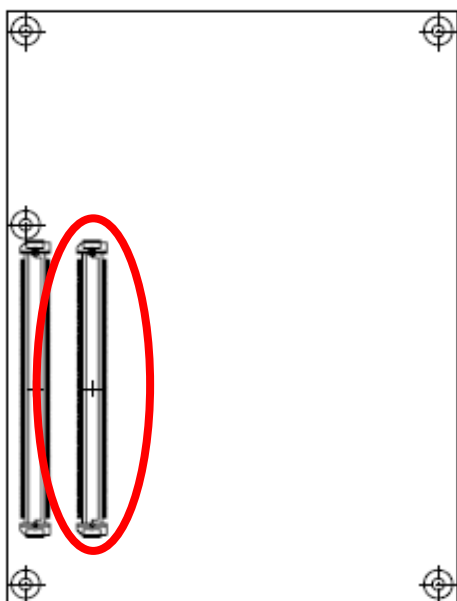

(Rear side)

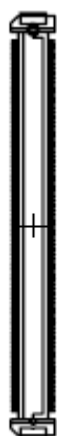

Signal	PIN	PIN	Signal
GND	C1	D1	GND
IDE_D7	C2	D2	IDE_D5
IDE_D6	C3	D3	IDE_D10
IDE_D3	C4	D4	IDE_D11
IDE_D15	C5	D5	IDE_D12
IDE_D8	C6	D6	IDE_D4
IDE_D9	C7	D7	IDE_D0
IDE_D2	C8	D8	IDE_REQ#
IDE_D13	C9	D9	IDE_IOW#
IDE_D1	C10	D10	IDE_ACK#
GND	C11	D11	GND
IDE_D14	C12	D12	IDE_IRQ
IDE_IORDY	C13	D13	IDE_A0
IDE_IOR#	C14	D14	IDE_A1
PCI_PME#	C15	D15	IDE_A2
PCI_GNT2#	C16	D16	IDE_CS1#
PCI_REQ2#	C17	D17	IDE_CS3#
PCI_GNT1#	C18	D18	IDE_RESET#
PCI_REQ1#	C19	D19	PCI_GNT3#
PCI_GNT0#	C20	D20	PCI_REQ3#
GND	C21	D21	GND
PCI_REQ0#	C22	D22	PCI_AD1
PCI_RESET#	C23	D23	PCI_AD3
PCI_AD0	C24	D24	PCI_AD5
PCI_AD2	C25	D25	PCD_AD7
PCI_AD4	C26	D26	PCI_CBE0#
PCI_AD6	C27	D27	PCI_AD9
PCI_AD8	C28	D28	PCI_AD11
PCI_AD10	C29	D29	PCI_AD13
PCI_AD12	C30	D30	PCI_AD15

ESM-2850

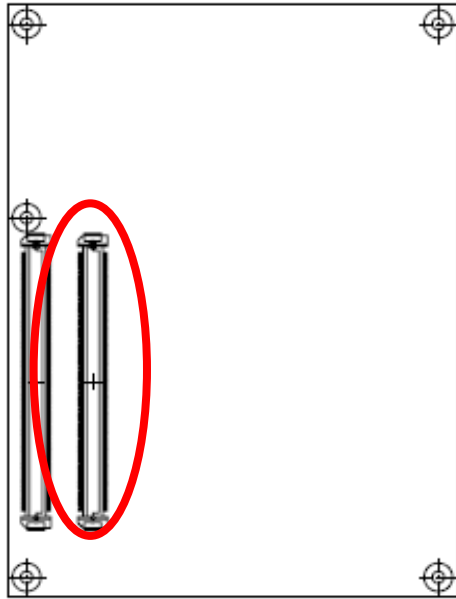

(Rear side)

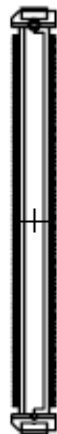

Signal	PIN	PIN	Signal
GND	C31	D31	GND
PCI_AD14	C32	D32	PCI_PAR
PCI_CBE1#	C33	D33	PCI_SERR#
PCI_PERR#	C34	D34	PCI_STOP#
PCI_LOCK#	C35	D35	PCI_TRDY#
PCI_DEVSEL#	C36	D36	PCI_FRAME#
PCI_IRDY#	C37	D37	PCI_AD16
PCI_CBE2#	C38	D38	PCI_AD18
PCI_AD17	C39	D39	PCI_AD20
PCI_AD19	C40	D40	PCI_AD22
GND	C41	D41	GND
PCI_AD21	C42	D42	PCI_AD24
PCI_AD23	C43	D43	PCI_AD26
PCI_CBE3#	C44	D44	PCI_AD28
PCI_AD25	C45	D45	PCI_AD30
PCI_AD27	C46	D46	PCI_IRQC#
PCI_AD29	C47	D47	PCI_IRQD#
PCI_AD31	C48	D48	PCI_CLKRUN#
PCI_IRQA#	C49	D49	NC
PCI_IRQB#	C50	D50	PCI_CLK
GND	C51	D51	GND
PEG_RX0+	C52	D52	PEG_TX0+
PEG_RX0-	C53	D53	PEG_TX0-
NC	C54	D54	PEG_LANE_RV#
PEG_RX1+	C55	D55	PEG_TX1+
PEG_RX1-	C56	D56	PEG_TX1-
NC	C57	D57	NC
PEG_RX2+	C58	D58	PEG_TX2+
PEG_RX2-	C59	D59	PEG_TX2-
GND	C60	D60	GND

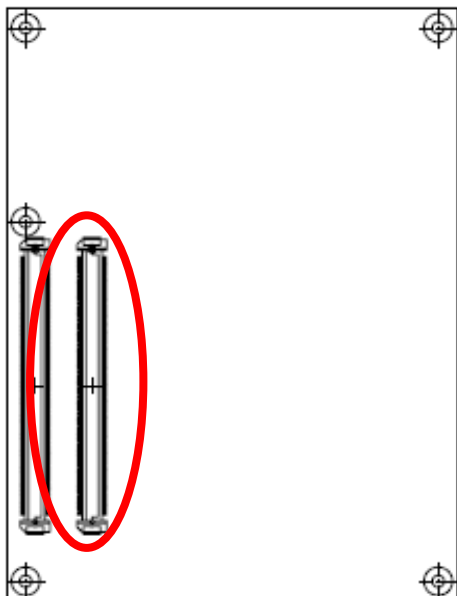

(Rear side)

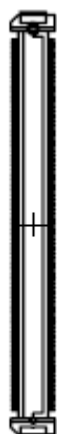

Signal	PIN	PIN	Signal
PEG_RX3+	C61	D61	PEG_TX3+
PEG_RX3-	C62	D62	PEG_TX3-
NC	C63	D63	NC
NC	C64	D64	NC
PEG_RX4+	C65	D65	PEG_TX4+
PEG_RX4-	C66	D66	PEG_TX4-
NC	C67	D67	GND
PEG_RX5+	C68	D68	PEG_TX5+
PEG_RX5-	C69	D69	PEG_TX5-
GND	C70	D70	GND
PEG_RX6+	C71	D71	PEG_TX6+
PEG_RX6-	C72	D72	PEG_TX6-
SDVO_DATA	C73	D73	SDVO_CLK
PEG_RX7+	C74	D74	PEG_TX7+
PEG_RX7-	C75	D75	PEG_TX7-
GND	C76	D76	GND
NC	C77	D77	IDE_CBLID#
PEG_RX8+	C78	D78	PEG_TX8+
PEG_RX8-	C79	D79	PEG_TX8-
GND	C80	D80	GND
PEG_RX9+	C81	D81	PEG_TX9+
PEG_RX9-	C82	D82	PEG_TX9-
NC	C83	D83	NC
GND	C84	D84	GND
PEG_RX10+	C85	D85	PEG_TX10+
PEG_RX10-	C86	D86	PEG_TX10-
GND	C87	D87	GND
PEG-RX11+	C88	D88	PEG_TX11+
PEG-RX11-	C89	D89	PEG_TX11-
GND	C90	D90	GND

ESM-2850

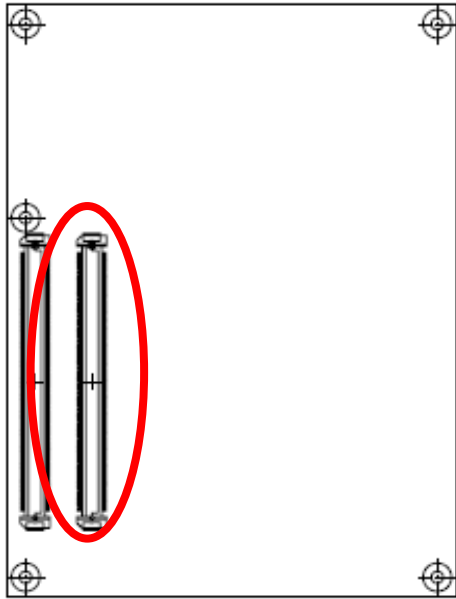

(Rear side)

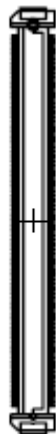

Signal	PIN	PIN	Signal
PEG_RX12+	C91	D91	PEG_TX12+
PEG_RX12-	C92	D92	PEG_TX12-
GND	C93	D93	GND
PEG_RX13+	C94	D94	PEG_TX13+
PEG_RX13-	C95	D95	PEG_TX13-
GND	C96	D96	GND
NC	C97	D97	PEG_ENABLE#
PEG_RX14+	C98	D98	PEG_TX14+
PEG_RX14-	C99	D99	PEG_TX14-
GND	C100	D100	GND
PEG_RX15+	C101	D101	PEG_TX15+
PEG_RX15-	C102	D102	PEG_TX15-
GND	C103	D103	GND
+12V	C104	D104	+12V
+12V	C105	D105	+12V
+12V	C106	D106	+12V
+12V	C107	D107	+12V
+12V	C108	D108	+12V
+12V	C109	D109	+12V
GND	C110	D110	GND

2.4.3.1 Signal Description – ETX Express Connector 2 (CN1B)

2.4.3.1.1 IDE Signals

Signal	Signal Description
IDE_D[0:15]	Bidirectional data to / from IDE device.
IDE_A[0:2]	Address lines to IDE device.
IDE_REQ#	IDE Device DMA Request. It is asserted by the IDE device to request a data transfer.
IDE_IOW#	I/O write line to IDE device. Data latched on trailing (rising) edge.
IDE_ACK#	IDE Device DMA Acknowledge.
IDE_IRQ	Interrupt request from IDE device.
IDE_IORDY	IDE device I/O ready input. Pulled low by the IDE device to extend the cycle.
IDE_IOR#	I/O read line to IDE device.
IDE_CS1#	IDE Device Chip Select for 1F0h to 1FFh range.
IDE_CS3#	IDE Device Chip Select for 3F0h to 3FFh range.
IDE_RESET#	Reset output to IDE device, active low.

2.4.3.1.2 PCI Signals

Signal	Signal Description
PCI_AD[0:31]	PCI bus multiplexed address and data lines
PCI_PME#	PCI Power Management Event: PCI peripherals drive PME# to wake system from low-power states S1–S5.
PCI_GNT[0:3]#	PCI bus master grant output lines, active low.
PCI_REQ[0:3]#	PCI bus master request input lines, active low.
PCI_RESET#	PCI Reset output, active low.
PCI_CBE[0:3]	PCI bus byte enable lines, active low
PCI_PERR#	Parity Error: An external PCI device drives PERR# when it receives data that has a parity error.
PCI_LOCK#	PCI Lock control line, active low.
PCI_DEVSEL#	PCI bus Device Select, active low.
PCI_IRD Y#	PCI bus Initiator Ready control line, active low.
PCI_IRQ[A:D]	PCI interrupt request lines.
PCI_PAR	PCI bus parity
PCI_SERR#	System Error: SERR# can be pulsed active by any PCI device that detects a system error condition.
PCI_STOP#	PCI bus STOP control line, active low, driven by cycle initiator.
PCI_TRDY#	PCI bus Target Ready control line, active low.
PCI_FRAME#	PCI bus Frame control line, active low.
PCI_CLKRUN#	Bidirectional pin used to support PCI clock run protocol for mobile systems.
PCI_CLK	PCI 33MHz clock output.

2.4.3.1.3 PCI Express Graphics Signals

Signal	Signal Description
PEG_RX[0:15] +/-	PCI Express Graphics receive differential pairs. Some of these are multiplexed with SDVO lines (see SDVO section).
PEG_TX[0:15] +/-	PCI Express Graphics transmit differential pairs. Some of these are multiplexed with SDVO lines (see SDVO section).
TYPE[0:2]	
PEG_LANE_RV#	PCI Express Graphics lane reversal input strap. Pull low to reverse lane order. Pulled high on module.
SDVO_DATA	SDVO I ² C data line - to set up SDVO peripherals.
SDVO_CLK	SDVO I ² C clock line - to set up SDVO peripherals.

3 BIOS Setup

3.1 Starting Setup

The AwardBIOS™ is immediately activated when you first power on the computer. The BIOS reads the system information contained in the CMOS and begins the process of checking out the system and configuring it. When it finishes, the BIOS will seek an operating system on one of the disks and then launch and turn control over to the operating system.

While the BIOS is in control, the Setup program can be activated in one of two ways:

By pressing immediately after switching the system on, or

By pressing the key when the following message appears briefly at the bottom of the screen during the POST (Power On Self Test).

Press DEL to enter SETUP

If the message disappears before you respond and you still wish to enter Setup, restart the system to try again by turning it OFF then ON or pressing the "RESET" button on the system case. You may also restart by simultaneously pressing <Ctrl>, <Alt>, and <Delete> keys. If you do not press the keys at the correct time and the system does not boot, an error message will be displayed and you will again be asked to.

Press F1 to Continue, DEL to enter SETUP

3.2 Using Setup

In general, you use the arrow keys to highlight items, press <Enter> to select, use the PageUp and PageDown keys to change entries, press <F1> for help and press <Esc> to quit. The following table provides more detail about how to navigate in the Setup program using the keyboard.

Button	Description
↑	Move to previous item
↓	Move to next item
←	Move to the item in the left hand
→	Move to the item in the right hand
Esc key	Main Menu -- Quit and not save changes into CMOS Status Page Setup Menu and Option Page Setup Menu -- Exit current page and return to Main Menu
PgUp key	Increase the numeric value or make changes
PgDn key	Decrease the numeric value or make changes
+ key	Increase the numeric value or make changes
- key	Decrease the numeric value or make changes
F1 key	General help, only for Status Page Setup Menu and Option Page Setup Menu
(Shift) F2 key	Change color from total 16 colors. F2 to select color forward, (Shift) F2 to select color backward
F3 key	Calendar, only for Status Page Setup Menu
F4 key	Reserved
F5 key	Restore the previous CMOS value from CMOS, only for Option Page Setup Menu
F6 key	Load the default CMOS value from BIOS default table, only for Option Page Setup Menu
F7 key	Load the default
F8 key	Reserved
F9 key	Reserved
F10 key	Save all the CMOS changes, only for Main Menu

- **Navigating Through The Menu Bar**

Use the left and right arrow keys to choose the menu you want to be in.



Note: Some of the navigation keys differ from one screen to another.

- **To Display a Sub Menu**

Use the arrow keys to move the cursor to the sub menu you want. Then press <Enter>. A “>” pointer marks all sub menus.

3.3 Getting Help

Press F1 to pop up a small help window that describes the appropriate keys to use and the possible selections for the highlighted item. To exit the Help Window press <Esc> or the F1 key again.

3.4 In Case of Problems

If, after making and saving system changes with Setup, you discover that your computer no longer is able to boot, the AwardBIOS™ supports an override to the CMOS settings which resets your system to its defaults.

The best advice is to only alter settings which you thoroughly understand. To this end, we strongly recommend that you avoid making any changes to the chipset defaults. These defaults have been carefully chosen by both Award and your systems manufacturer to provide the absolute maximum performance and reliability. Even a seemingly small change to the chipset setup has the potential for causing you to use the override.

3.5 Main Menu

Once you enter the AwardBIOS™ CMOS Setup Utility, the Main Menu will appear on the screen. The Main Menu allows you to select from several setup functions and two exit choices. Use the arrow keys to select among the items and press <Enter> to accept and enter the sub-menu.

Note that a brief description of each highlighted selection appears at the bottom of the screen.

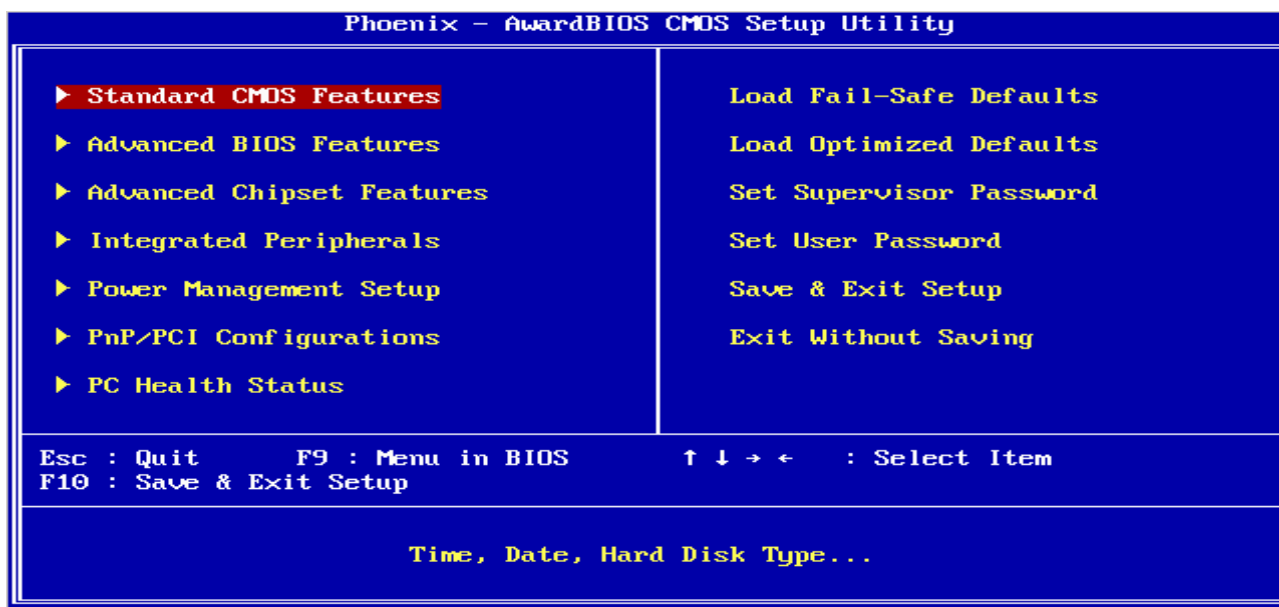

Note: The BIOS setup screens shown in this chapter are for reference purposes only, and may not exactly match what you see on your screen. Visit the Evalue website (www.evalue-tech.com) to download the latest product and BIOS information.

3.5.1 Standard CMOS Features

The items in Standard CMOS Setup Menu are divided into few categories. Each category includes no, one or more than one setup items. Use the arrow keys to highlight the item and then use the <PgUp> or <PgDn> keys to select the value you want in each item.

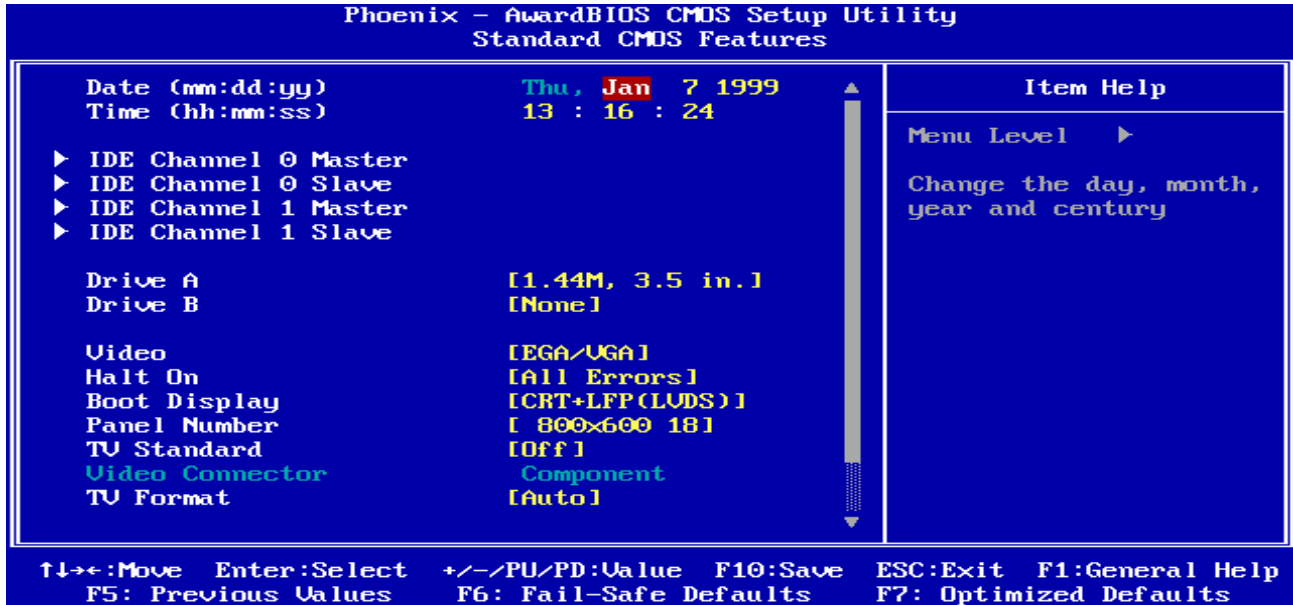

3.5.1.1 Main Menu Selection

This reference table shows the selections that you may make on the Main Menu.

Item	Options	Description
Time	HH : MM : SS	Set the system time
IDE Channel 0 Master IDE Channel 0 Slave IDE Channel 1 Master IDE Channel 1 Slave	Options are in 3.5.1.2	Press <Enter> to enter the sub menu of detailed options
Drive A Drive B	None 360K, 5.25 in 1.2M, 5.25 in 720K, 3.5 in 1.44M, 3.5 in 2.88M, 3.5 in	Select the type of floppy disk drive installed in your system
Video	EGA/VGA CGA 40 CGA 80 MONO	Select the default video device
Halt On	All Errors No Errors All, but Keyboard All, but Diskette All, but Disk/Key	Select the situation in which you want the BIOS to stop the POST process and notify you
Boot Display	CRT LFP (LVDS) CRT+LFP(LVDS) TV	Select Display Device that the screen will be shown

Item	Options	Description
Panel Number	640x480 18, 800x600 18, 1024x768 18, 1280x1024 36 1400x1050 36, 1600x1200 36 1280x768 18, 1680x1050 36 1920x1200 36, 1024x768 18 1024x768 36, 1280x800 18 1280x600 18	Select Panel Resolution that will be displayed depending on the LCD Panel (LFP)
TV Standard	Off NTSC PAL SECAM	Select the output mode of TV Standard
TV Format	Auto, NTSC_M, NTSC_M_J, NTSC_433, NTSC_N, PAL_B, PAL_G, PAL_D, PAL_H, PAL_I, PAL_M, PAL_N, PAL_60, SECAM_L, SECAM_L1, SECAM_B, SECAM_D, SECAM_G, SECAM_H, SECAM_K, SECAM_K1	This item allows you to select different TV signal format when the TV Standard item is not off.

3.5.1.2 IDE Adapter Setup

The IDE adapters control the hard disk drive. Use a separate sub menu to configure each hard disk drive. The below Figure will shows the IDE primary master sub menu.

Use the following table to configure the hard disk.

Item	Options	Description
IDE HDD Auto-detection	Press Enter	Press Enter to auto-detect the HDD on this channel. If detection is successful, it fills the remaining fields on this menu.
IDE Channel 0 Master IDE Channel 0 Slave, IDE Channel 1 Master, IDE Channel 1 Slave	None Auto Manual	Selecting 'manual' lets you set the remaining fields on this screen. Selects the type of fixed disk. "User Type" will let you select the number of cylinders, heads, etc. Note: PRECOMP=65535 means NONE !
Access Mode	CHS LBA Large Auto	Choose the access mode for this hard disk
The following options are selectable only if the 'IDE Channel ...' item is set to 'Manual'		
Cylinder	Min = 0 Max = 65535	Set the number of cylinders for this hard disk.
Head	Min = 0 Max = 255	Set the number of read/write heads
Precomp	Min = 0 Max = 65535	**** Warning: Setting a value of 65535 means no hard disk
Landing zone	Min = 0 Max = 65535	****
Sector	Min = 0 Max = 255	Number of sectors per track

3.5.2 Advanced BIOS Features

This section allows you to configure your system for basic operation. You have the opportunity to select the system's default speed, boot-up sequence, keyboard operation, shadowing and security.

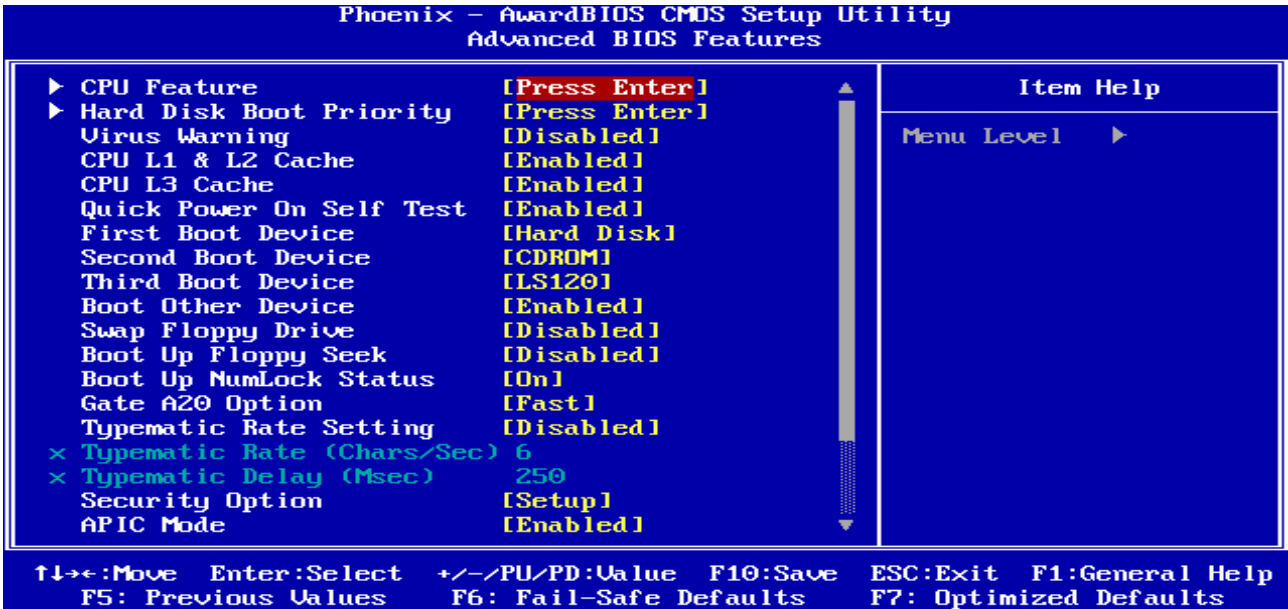

3.5.2.1 CPU Feature

This item allows you to setup the CPU thermal management function.

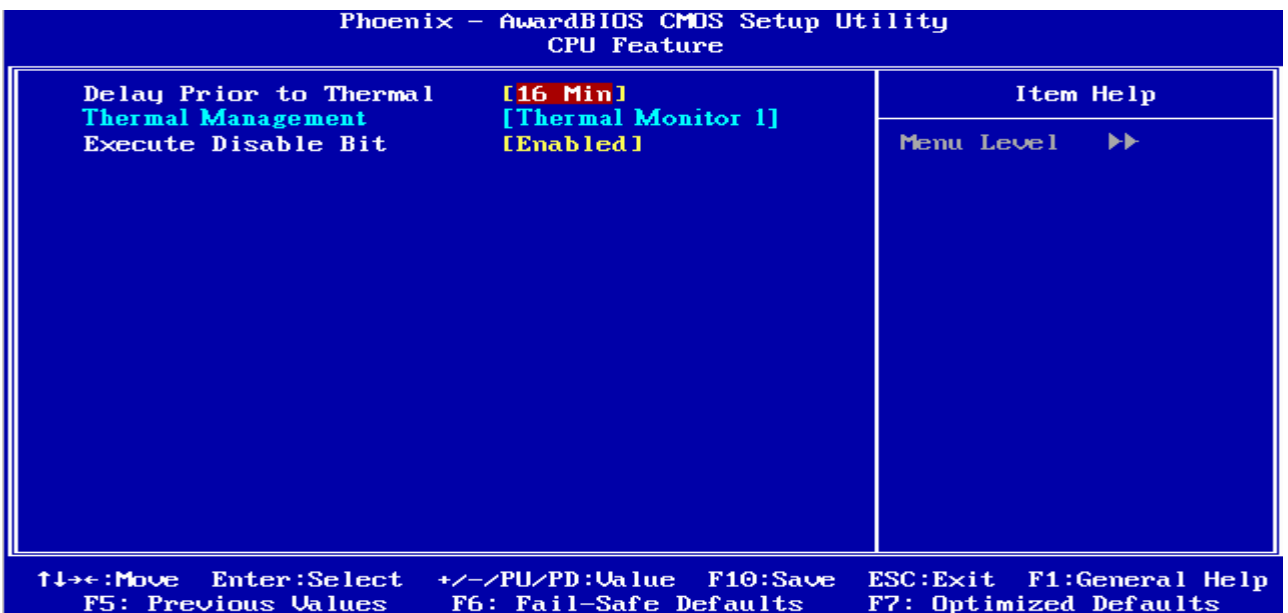

3.5.2.2 Hard Disk Boot Priority

This item allows you to select the Hard Disk device boot up priority.

Item	Description
Pri./Sec. Master/Slave	Boot up from IDE Primary/Secondary Master/Slave Hard Disk
USBHDD 0/1/2	Boot up from 1st/2nd/3rd USB Hard Disk
Bootable Add-in Cards	Boot up from other Add-In Card Hard Disk Device.

3.5.2.3 Virus Warning

Allows you to choose the VIRUS Warning feature for IDE Hard Disk boot sector protection. If this function is enabled and someone attempt to write data into this area, BIOS will show a warning message on screen and alarm beep.

Item	Description
Enabled	Activates automatically when the system boots up causing a warning message to appear when anything attempts to access the boot sector or hard disk partition table.
Disabled	No warning message will appear when anything attempts to access the boot sector or hard disk partition table.

3.5.2.4 CPU L1 & L2 & L3 Cache

The item allows you to speed up memory access. However, it depends on CPU design.

Item	Description
Enabled	Enable cache
Disabled	Disable cache

3.5.2.5 Quick Power On Self Test

This category speeds up Power On Self Test (POST) after you power up the computer. If it is set to Enable, BIOS will shorten or skip some check items during POST.

Item	Description
Enabled	Enable quick POST
Disabled	Normal POST

3.5.2.6 First/Second/Third/Other Boot Device

The BIOS attempts to load the operating system from the devices in the sequence selected in these items.

Item	Description
Floppy	Floppy Device
LS120	LS120 Device
Hard Disk	Hard Disk Device
CDROM	CDROM Device
ZIP100	ZIP-100 Device
USB-FDD	USB Floppy Device
USB-ZIP	USB ZIP Device
USB-CDROM	USB CDROM Device
LAN	Network Device
Disabled	Disabled any boot device

3.5.2.7 Swap Floppy Drive

While system has two floppy drivers installed, this item will be affected. This function is to assign physical drive B to logical drive A

Item	Description
Enabled	Assign physical drive B to logical drive A
Disabled	No change

3.5.2.8 Boot Up Floppy Seek

Seeks disk drives during boot up. Disabling seeds boot up.

Item	Description
Enabled	Enable Floppy Seek
Disabled	Disable Floppy Seek

3.5.2.9 Boot Up NumLock Status

Select power on state for NumLock.

Item	Description
On	Enable NumLock
Off	Disable NumLock

3.5.2.10 Gate A20 Option

Select if chipset or keyboard controller should control Gate A20.

Item	Description
Normal	A pin in the keyboard controller controls Gate A20
Fast	Lets chipset control Gate A20

3.5.2.11 Typematic Rate Setting

Key strokes repeat at a rate determined by the keyboard controller. When enabled, the typematic rate and typematic delay can be selected.

Item	Description
Enabled	Enable typematic rate/delay setting
Disabled	Disable typematic rate/delay setting

3.5.2.12 Typematic Rate (Chars/Sec)

Sets the number of times a second to repeat a key stroke when you hold the key down. The choice: 6, 8, 10, 12, 15, 20, 24, 30.

3.5.2.13 Typematic Rate (Msec)

Sets the delay time after the key is held down before it begins to repeat the keystroke. The choice: 250, 500, 750, 1000.

3.5.2.14 Security Option

Select whether the password is required every time the system boots or only when you enter setup.

Item	Description
System	The system will not boot and access to Setup will be denied if the correct password is not entered at the prompt.
Setup	The system will boot, but access to Setup will be denied if the correct password is not entered at the prompt.



Note: To disable security, select PASSWORD SETTING at Main Menu and then you will be asked to enter password. Do not type anything and just press <Enter>, it will disable security. Once the security is disabled, the system will boot and you can enter Setup freely.

3.5.2.15 APIC Mode

The BIOS supports versions 1.4 of the Intel multiprocessor specification. When enabled, The MPS Version 1.4 Control for OS can be activated.

The choices: Enabled, Disabled.

3.5.2.16 MPS Version Control For OS

This feature is only applicable to multiprocessor board as it specifies the version of the Multi-Processor Specification (MPS) that the board will use.

The choice: 1.4, 1.1.

3.5.2.17 OS Select for DRAM > 64MB

Select the operating system that is running with greater than 64MB of RAM on the system.

Item	Description
Non-OS2	Disable OS for over 64 MB DRAM
OS2	Enable OS for over 64 MB DRAM

3.5.2.18 Report No FDD For WIN95

The original Windows95 requires the presence of a floppy. Unless the BIOS tells it to disregard the absence of the drive, it will generate an error message. For other operating systems as Win98 etc this field is without relevance.

Item	Description
No	Don't generate error message
Yes	Generate error message

3.5.2.19 Full Screen Logo Show

This item allows you to enable/disable the custom company logo on the screen.

Item	Description
Enabled	Full Screen Logo show is enabled
Disabled	Full Screen Logo show is disabled

3.5.2.20 Small Logo (EPA) Show

This item allows you enabled/disabled the small EPA logo show on screen at the POST step.

Item	Description
Enabled	EPA Logo show is enabled
Disabled	EPA Logo show is disabled

3.5.3 Advanced Chipset Features

This section allows you to configure the system based on the specific features of the installed chipset. This chipset manages bus speeds and access to system memory resources, such as DRAM and the external cache. It also coordinates communications between the conventional ISA bus and the PCI bus. It must be stated that these items should never need to be altered. The default settings have been chosen because they provide the best operating conditions for your system. The only time you might consider making any changes would be if you discovered that data was being lost while using your system.

The first chipset settings deal with CPU access to dynamic random access memory (DRAM). The default timings have been carefully chosen and should only be altered if data is being lost. Such a scenario might well occur if your system had mixed speed DRAM chips installed so that greater delays may be required to preserve the integrity of the data held in the slower memory chips.

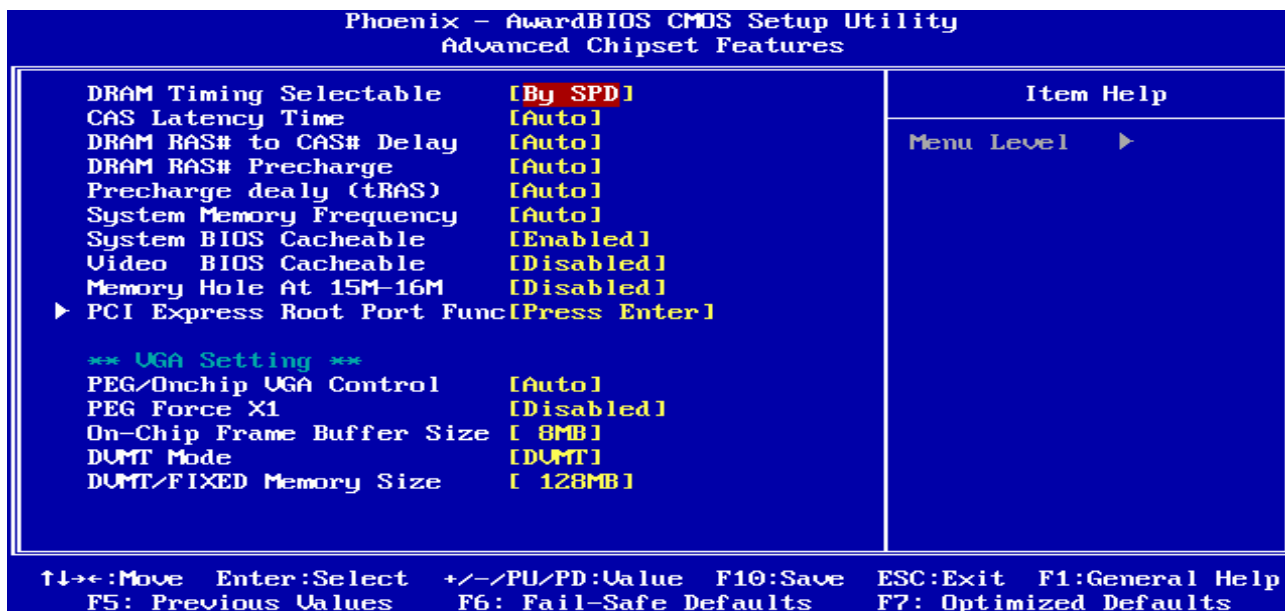

3.5.3.1 DRAM Timing Selectable

This item allows you to select the DRAM timing value by SPD data or Manual by yourself. The choices: Manual, By SPD.

3.5.3.2 CAS Latency Time

This item controls the time delay (in clock cycles - CLKs) that passes before the SDRAM starts to carry out a read command after receiving it. This also determines the number of CLKs for the completion of the first part of a burst transfer. In other words, the lower the latency, the faster the transaction.

The choices: Auto, 2, 2.5, 3.

3.5.3.3 DRAM RAS# to CAS# Delay

This option allows you to insert a delay between the RAS (**Row Address Strobe**) and CAS (**Column Address Strobe**) signals. This delay occurs when the SDRAM is written to, read from or refreshed. Naturally, reducing the delay improves the performance of the SDRAM while increasing it reduces performance.

The choices: Auto, 2, 3, 4, 5.

3.5.3.4 DRAM RAS# Precharge

This option sets the number of cycles required for the RAS to accumulate its charge before the SDRAM refreshes. Reducing the precharge time to **2** improves SDRAM performance but if the precharge time of **2** is insufficient for the installed SDRAM, the SDRAM may not be refreshed properly and it may fail to retain data

So, for better SDRAM performance, set the **SDRAM RAS Precharge Time** to **2** but increase it to **3** if you face system stability issues after reducing the precharge time.

The choices: Auto, 2, 3, 4, 5.

3.5.3.5 Precharge Delay (tRAS)

The Active to Precharge timing controls the length of the delay between the activation and precharge commands -- basically how long after activation can the access cycle be started again. This influences row activation time which is taken into account when memory has hit the last column in a specific row, or when an entirely different memory location is requested.

The choices: Auto, 4, 5, 6, 7, 8, 9, 10, 11, 12, 13, 14, 15.

3.5.3.6 System Memory Frequency

This item is to determine the maximum performance and reliability of memory.

The choices: Auto, 333MHz, 400MHz, 533MHz.

3.5.3.7 System BIOS Cacheable

This feature is only valid when the system BIOS is shadowed. It enables or disables the caching of the system BIOS ROM at **F0000h-FFFFh** via the L2 cache. This greatly speeds up accesses to the system BIOS. However, this does **not** translate into better system performance because the OS does not need to access the system BIOS much.

The choices: Disabled, Enabled.

3.5.3.8 Video BIOS Cacheable

This feature is only valid when the video BIOS is shadowed. It enables or disables the caching of the video BIOS ROM at **C0000h-C7FFFh** via the L2 cache. This greatly speeds up accesses to the video BIOS. However, this does **not** translate into better system performance because the OS bypasses the BIOS using the graphics driver to access the video card's hardware directly.

The Choice: Enabled, Disabled.

3.5.3.9 Memory Hole At 15M-16M

Enabling this feature reserves 15MB to 16MB memory address space to ISA expansion cards that specifically require this setting. This makes the memory from 15MB and up unavailable to the system. Expansion cards can only access memory up to 16MB. The choice: Enable, Disable.

3.5.3.10 PCI Express Root Port Function

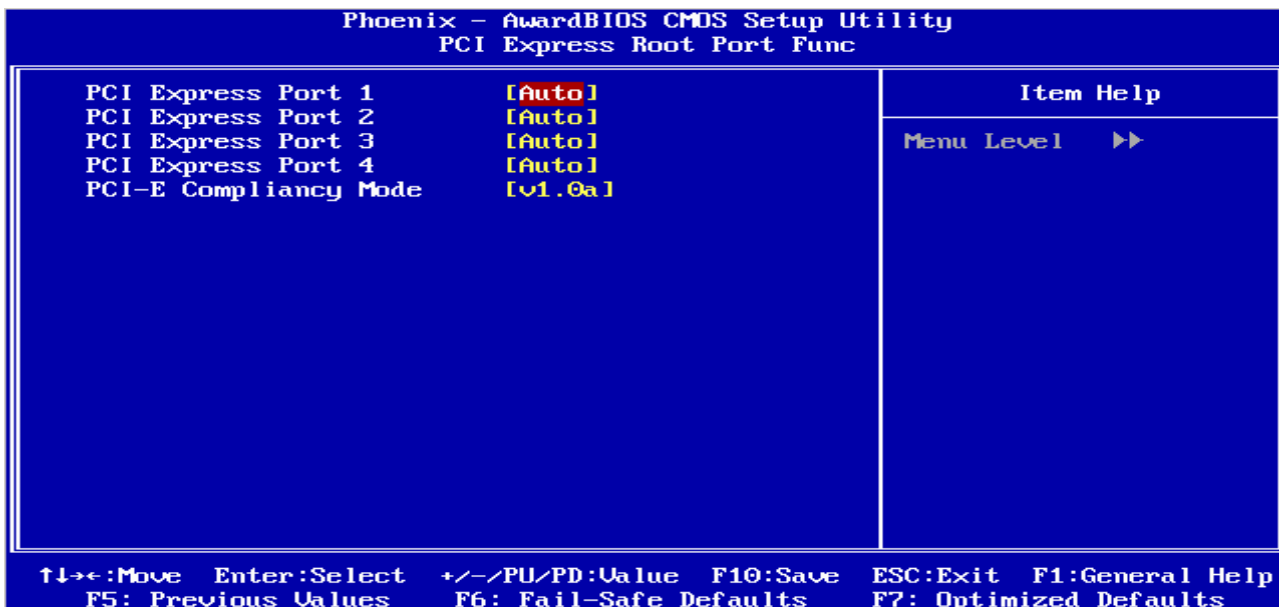

Item	Options	Description
PCI Express Port 1/2/3/4	Auto Enabled Disabled	Enable/Disable PCI Express port 1/2/3/4.
PCI-E Compliancy Mode	v1.0a v1.0	Allows to select the PCI-E Compliancy mode.

3.5.3.11 PEG/Onchip VGA Control

This item is enabled to set the device of Onchip VGA or PCI Express X16 the system used. The choices: Onchip VGA, PEG Port, Auto.

3.5.3.12 PEG Force X1

This item is used to set PCI Express X16 slot to PCI Express X1 slot. This item will be shown and modified when you use PCI Express X16 device or Onboard VGA. The choices: Enabled, Disabled.

3.5.3.13 On-Chip Frame Buffer Size

This item is to select the amount of system memory that will be utilized as internal graphics device memory. The choices: 1MB, 8MB.

3.5.3.14 DVMT Mode

The item allows to select the video mode. The choices: FIXED, DVMT, BOTH.

3.5.3.15 DVMT/FIXED Memory Size

This item allows to select DVMT/FIXED memory size.

The choices: 64MB, 128MB.

3.5.4 Integrated Peripherals

Use this menu to specify your settings for integrated peripherals.

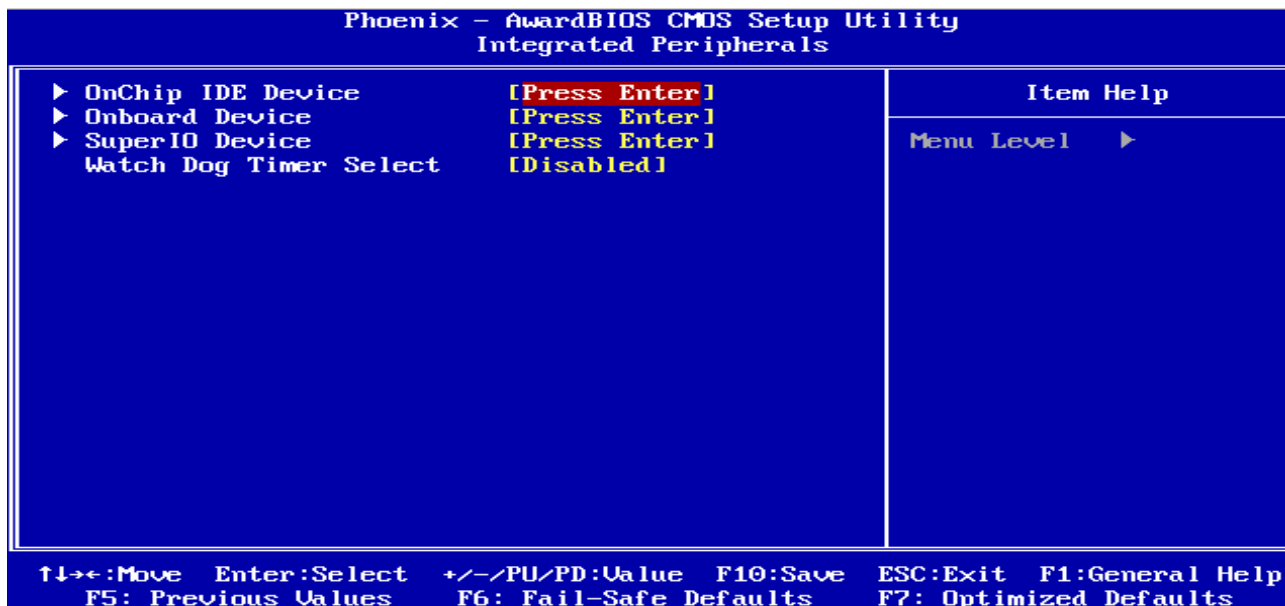

3.5.4.1 OnChip IDE Device

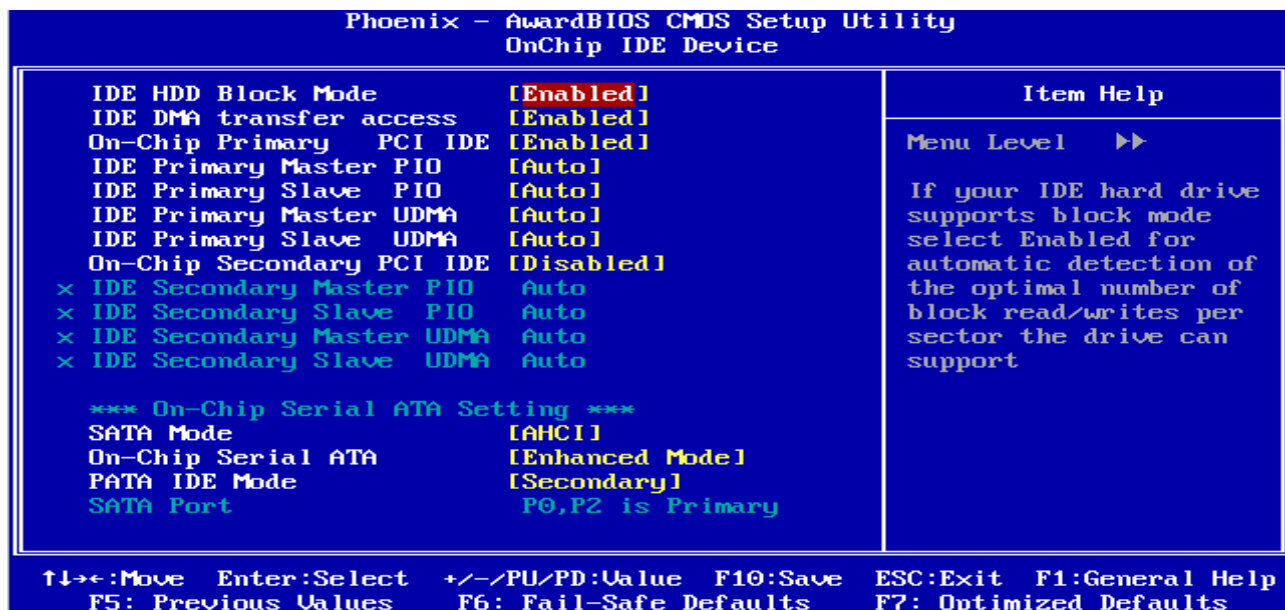

The chipset contains a PCI IDE interface with support for two IDE channels. Select Enabled to activate the primary IDE interface. Select Disabled to deactivate this interface.

Item	Options	Description
IDE HDD Block Mode	Enabled Disabled	Block mode is also called block transfer, multiple commands, or multiple sector read/write. If the IDE hard drive supports block mode (most new drives do), select Enabled for automatic detection of the optimal number of block read/writes per sector the drive can support.
IDE DMA transfer access	Enabled Disabled	This item could allows you to enabled/disabled the IDE UDMA transfer function and only use PIO mode.
On-Chip Primary / Secondary PCI IDE	Enabled Disabled	The chipset contains a PCI IDE interface with support for two IDE channels. Select Enabled to activate the primary/Secondary IDE interface. Select Disabled to deactivate this interface.
IDE Primary Master PIO IDE Primary Slave PIO IDE Secondary Master PIO IDE Secondary Slave PIO	Auto Mode 0 Mode 1 Mode 2 Mode 3 Mode 4	The IDE PIO (Programmed Input/Output) fields let you set a PIO mode (0-4) for each of the four IDE devices that the onboard IDE interface supports. Modes 0 through 4 provide successively increased performance. In Auto mode, the system automatically determines the best mode for each device.
IDE Primary Master UDMA IDE Primary Slave UDMA IDE Secondary Master UDMA IDE Secondary Slave UDMA	Auto Disabled	Ultra DMA implementation is possible only if your IDE hard drive supports it and the operating environment includes a DMA driver (Windows 95 OSR2 or a third-party IDE bus master driver). If the hard drive and the system software both support Ultra DMA, select Auto to enable BIOS support.
SATA Mode	IDE AHCI	Setup the onboard SATA Mode.
OnChip Serial ATA	Disabled Auto Combined Mode Enhanced Mode SATA Only	The chipset contains a SATA IDE interface with support for two IDE channels. Select Enabled to activate the primary IDE interface (Channel0). Select Disabled to deactivate this interface.
PATA IDE Mode	Secondary	To select PATA IDE mode.

3.5.4.2 Onboard Device

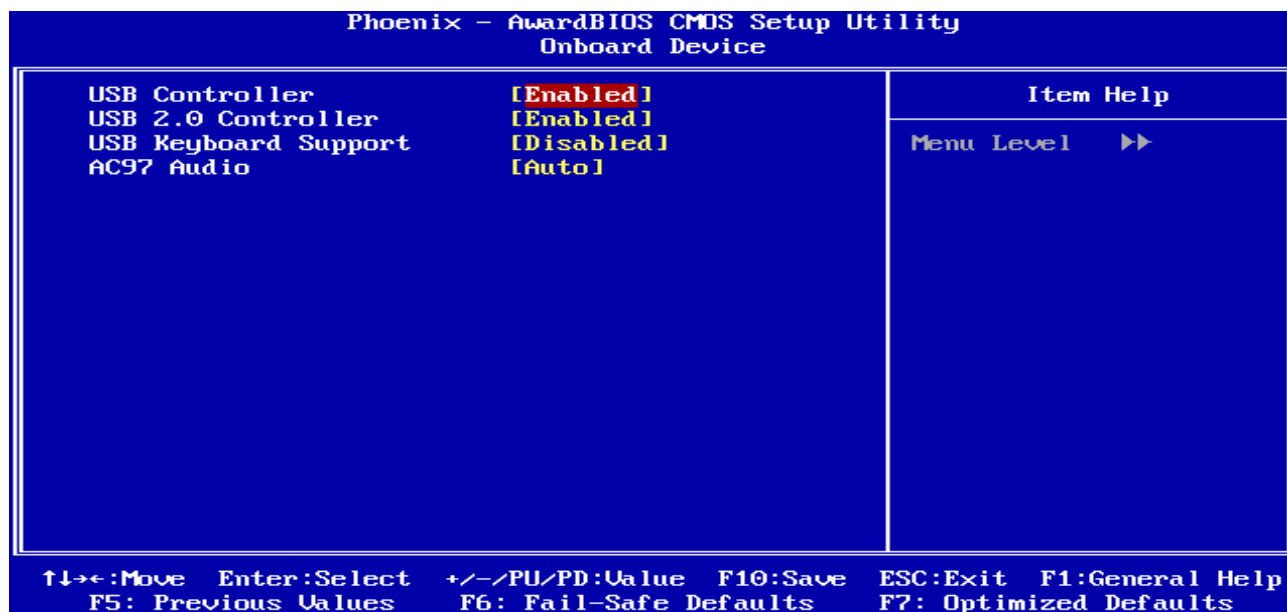

Item	Options	Description
USB Controller	Enabled Disabled	This item allows you to set the USB Controller.
USB 2.0 Controller	Disabled Enabled	This item allows you to set the USB 2.0 Controller.
USB Keyboard Support	Enabled Disabled	This item allows you to set the system's USB keyboard to Enabled/Disabled.
AC97 Audio	Auto Disabled	This item allows you to decide to Auto/disable the Codec chip to support AC97 Audio.

3.5.4.3 Super IO Device

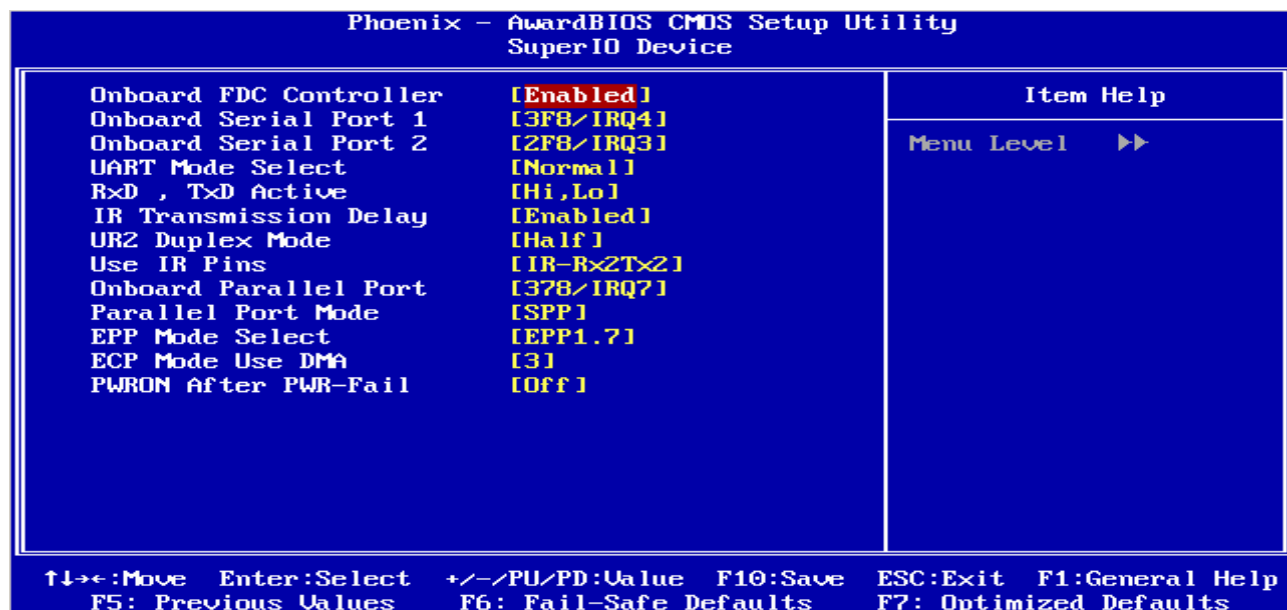

Item	Options	Description
Onboard FDC Controller	Enabled Disabled	Select Enabled if your system has a floppy disk controller (FDC) installed on the system board and you wish to use it. If you are not going to use FDC or the system has no floppy drive, select Disabled in this field.
Onboard Serial Port 1 Onboard Serial Port 2	Disabled 3F8/IRQ4 2F8/IRQ3 3E8/IRQ4 2E8/IRQ3 AUTO	Select an address and corresponding interrupt for the first and second serial ports.
UART Mode Select	IrDA ASKIR Normal	Select UART2 mode as standard serial port or IR port.
RxD , TxD Active	Hi,Hi Hi,Lo Lo,Hi Lo,Lo	This item allows you to determine the active of RxD, TxD level.
IR Transmission Delay	Enabled Disabled	This item allows you to enable/disable the IR Transmission Delay.
UR2 Duplex Mode	Half Full	Select the value required by the IR device connected to the IR port. Full-duplex mode permits simultaneous two-direction transmission. Half-duplex mode permits transmission in one direction only at a time.
Use IR Pins	RxD2,TxD2 IR-Rx2Tx2	This item allows you to determine the pin definition.
Onboard Parallel Port	Disabled 378/IRQ7 278/IRQ5 3BC/IRQ7	Select a matching address and interrupt for the physical parallel (printer) port.
Parallel Port Mode	SPP EPP ECP ECP+EPP Normal	Select an operating mode for the onboard parallel port. Select Compatible or Extended unless you are certain both your hardware and software support EPP or ECP mode.
EPP Mode Select	EPP1.9 EPP1.7	Select EPP port type 1.7 or 1.9.
ECP Mode Use DMA	1 3	Select a DMA channel for the port.
PWRON After PWR-Fail	Off On Former-Sts	This item is to set whether to run Ac Loss Auto Restart or off

3.5.4.4 Watch Dog Timer

This option will determine watch dog timer.

The choices: Disabled, 1, 2, 4 Min.

3.5.5 Power Management Setup

The Power Management Setup allows you to configure you system to most effectively save energy while operating in a manner consistent with your own style of computer use.

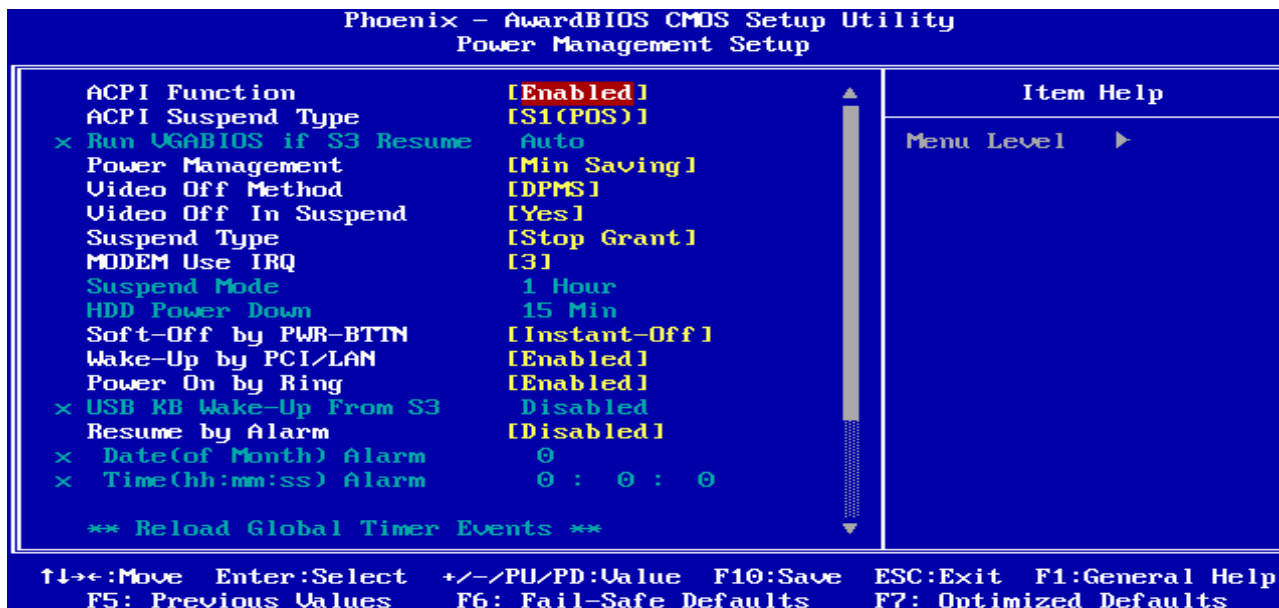

3.5.5.1 ACPI Function

This item allows you to enable/disable the ACPI function.

The choices: Enable, Disable.

3.5.5.2 ACPI Suspend Type

This item will set which ACPI suspend type will be used.

The choice: S1(POS), S3(STR).

3.5.5.3 Run VGABIOS if S3 Resume

Select whether to run VGABIOS if resumed from S3 state. This is only necessary for older VGA drivers, select Auto if in doubt.

The choices: Auto, Yes, No.

3.5.5.4 Power Management

This category allows you to select the type (or degree) of power saving and is directly related to the following modes:

3.5.5.4.1 HDD Power Down

There are three selections for Power Management Option; both of them have fixed mode settings.

Item	Description
Min. Power Saving	Minimum power management, HDD Power Down = 15 Min,
Max. Power Saving	Maximum power management, HDD Power Down =1 Min,
User Defined	Allows you to set each mode individually. When not disabled, each of the ranges are from 1 min. to 1 hr. except for HDD Power Down which ranges from 1 min. to 15 min. and disable.

3.5.5.5 Video Off Method

This determines the manner in which the monitor is blanked.

The choices: Blank Screen, V/H SYNC+Blank, DPMS.

3.5.5.6 Video Off In Suspend

This determines the manner in which the monitor is blanked.

The choice: No, Yes.

3.5.5.7 Suspend Type

This item will set the system status to shut down the PC.

The choices: Stop Grant, PwrOn Suspend.

3.5.5.8 MODEM Use IRQ

This determines the IRQ in which the MODEM can use.

The choices: NA, 3, 4, 5, 7, 9, 10, 11.

3.5.5.9 Suspend Mode

The item allows to set the number of minutes before the system enters suspend mode.

The choices: Disabled, 1, 2, 4, 8, 12, 20, 30, 40 Min, 1 Hour.

3.5.5.10 HDD Power Down

There are three selections for Power Management Option; both of them have fixed mode settings.

The choices: Disabled, 1, 2, 3, 4, 5, 6, 7, 8, 9, 10, 11, 12, 13, 14, 15 Min.

3.5.5.11 Soft-Off by PWR-BTTN

Pressing the power button for more than 4 seconds forces the system to enter the Soft-Off state when the system has "hung".(Only could working on ATX Power supply)

The choices: Delay 4 Sec, Instant-Off.

3.5.5.12 Wake Up by PCI/LAN

This will enable the system to wake up through PCI/LAN peripheral.

The choices: Enable, Disabled.

3.5.5.13 Power On By Ring

This determines whether the system boot up if there's an incoming call from the Modem.

The choices: Enable, Disabled.

3.5.5.14 USB KB Wake-up From S3

This option is used to enabled/disabled USB keyboard wake up with suspend to RAM.

The choices: Enable, Disabled.

3.5.5.15 Resume By Alarm

This function is for setting date and time for your computer to boot up.

The choices: Enabled, Disabled.

3.5.5.16 Primary/Secondary IDE 0/1

This function is for setting IDE 0/1 on primary/secondary mode.

The choices: Enabled, Disabled.

ESM-2850

3.5.5.17 FDD,COM,LPT Port

System can be awaked by Floppy Drive, COM or LPT port.

The choices: Enabled, Disabled.

3.5.5.18 PCI PIRQ[A-D]#

This function will cause the system waking up completely from the power management mode.

The choices: Enabled, Disabled.

3.5.6 PnP / PCI Configuration

This section describes configuring the PCI bus system. PCI, or **P**ersonal **C**omputer **I**nterconnect, is a system which allows I/O devices to operate at speeds nearing the speed the CPU itself uses when communicating with its own special components. This section covers some very technical items and it is strongly recommended that only experienced users should make any changes to the default settings.

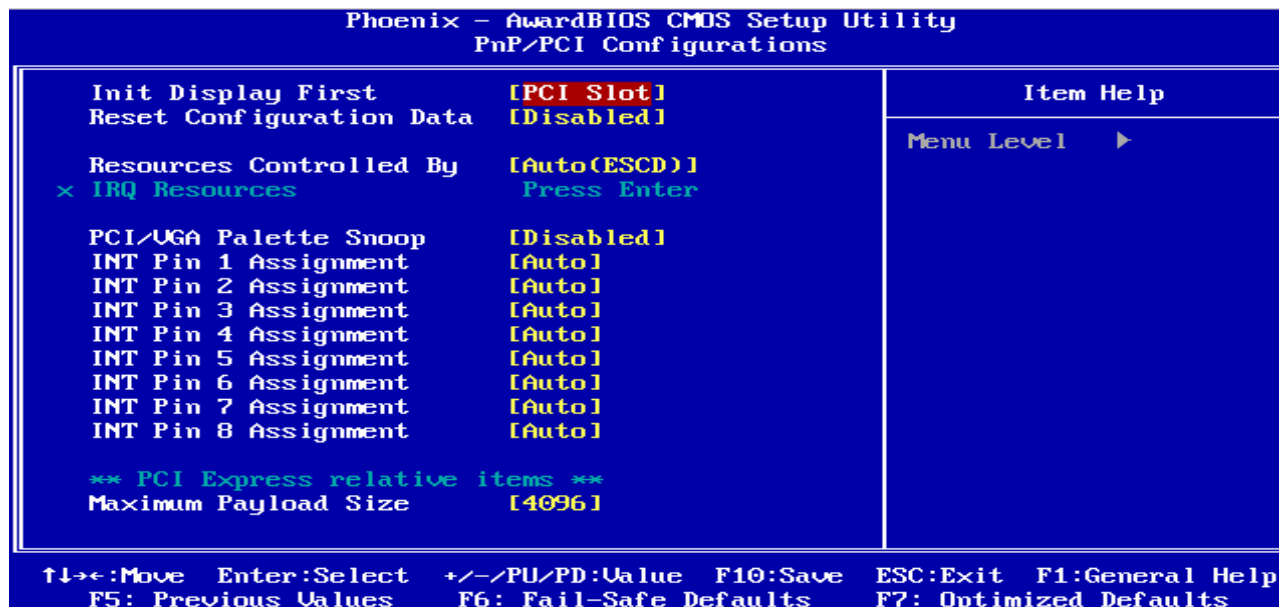

3.5.6.1 Init Display First

This item allows you to decide to active whether PCI Slot or Onboard/AGP first.

The choices: PCI Slot, Onboard, PCI Ex.

3.5.6.2 Reset Configuration Data

Normally, you leave this field Disabled. Select Enabled to reset Extended System Configuration Data (ESCD) when you exit Setup if you have installed a new add-on and the system reconfiguration has caused such a serious conflict that the operating system cannot boot.

The choices: Enabled, Disabled.

3.5.6.3 Resources Controlled By

The Award Plug and Play BIOS has the capacity to automatically configure all of the boot and Plug and Play compatible devices. However, this capability means absolutely nothing unless you are using a Plug and Play operating system such as Windows®95. If you set this field to "manual" choose specific resources by going into each of the sub menu that follows this field (a sub menu is preceded by a "▶").

The choices: Auto(ESCD), Manual.

ESM-2850

3.5.6.4 IRQ Resources

3.5.6.4.1 IRQ-3/4/5/7/9/10/11/12/14/15 Assigned to

This item allows you to determine the IRQ assigned to the ISA bus and is not available to any PCI slot. Legacy ISA for devices compliant with the original PC AT bus specification, PCI/ISA PnP for devices compliant with the Plug and Play standard whether designed for PCI or ISA bus architecture.

The choices: PCI Device, Reserved.

3.5.6.5 PCI / VGA Palette Snoop

Leave this field at Disabled.

The choices: Enabled, Disabled.

3.5.6.6 INT Pin 1/2/3/4/5/6/7/8 Assignment

This item is used to name the interrupt request (IRQ) line assigned to a device connected to the PCI interface on the system.

The choices: Auto, 3, 4, 5, 7, 9, 10, 11, 12, 14, 15.

3.5.6.7 Maximum Payload Size

This item allows to set the maximum TLP payload size (unit in byte) for the PCI Express devices.

The choices: 128, 256, 512, 1024, 2048, 4096.

3.5.7 PC Health Status

This section shows the status of your CPU, Fan & System.

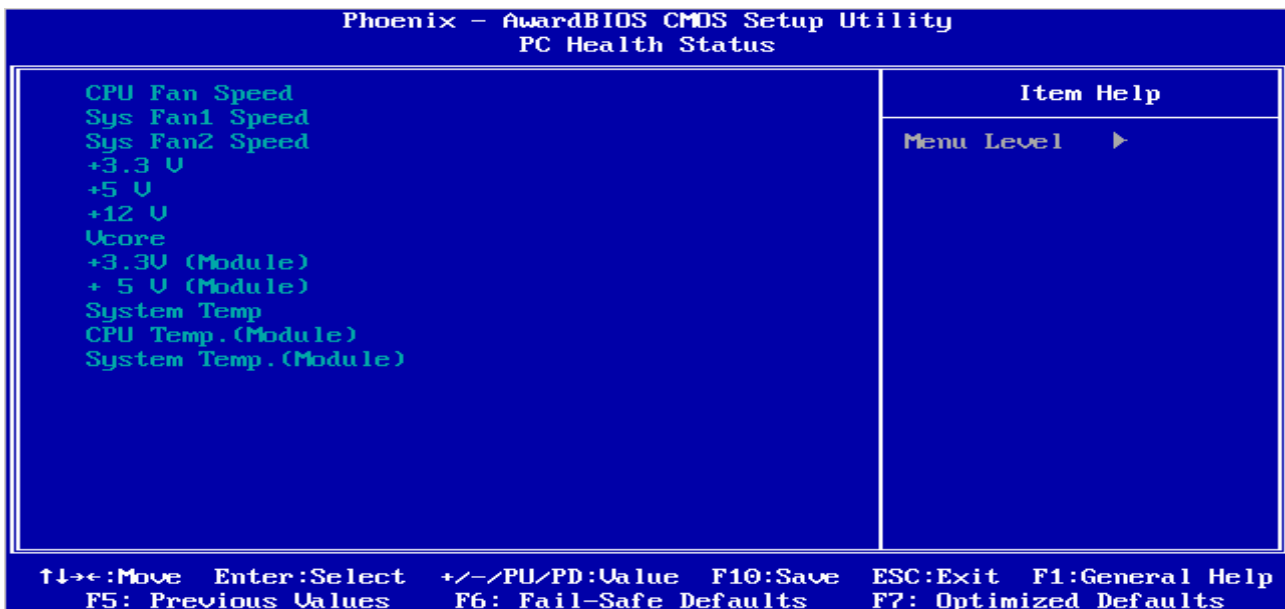

3.5.8 Load Fail-Safe Defaults

Use this menu to load the BIOS default values for the minimal/stable performance for your system to operate.

Press <Y> to load the BIOS default values for the most stable, minimal-performance system operations.

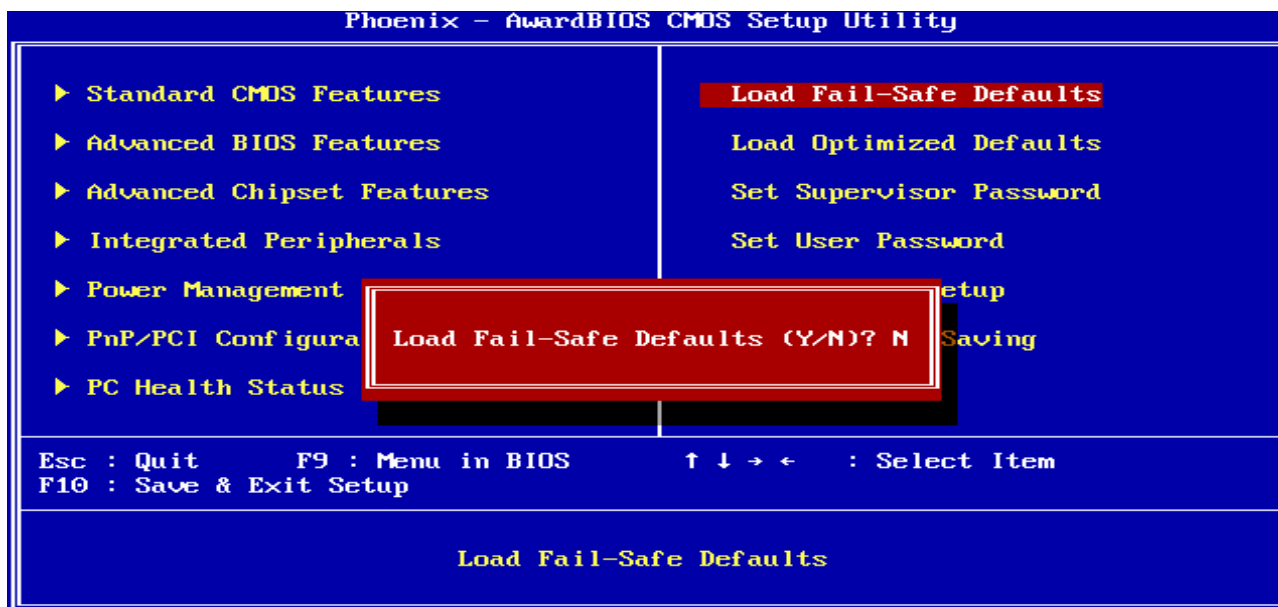

3.5.9 Load Optimized Defaults

Use this menu to load the BIOS default values that are factory settings for optimal performance system operations. While Award has designed the custom BIOS to maximize performance, the factory has the right to change these defaults to meet their needs.

Press <Y> to load the default values setting for optimal performance system operations.

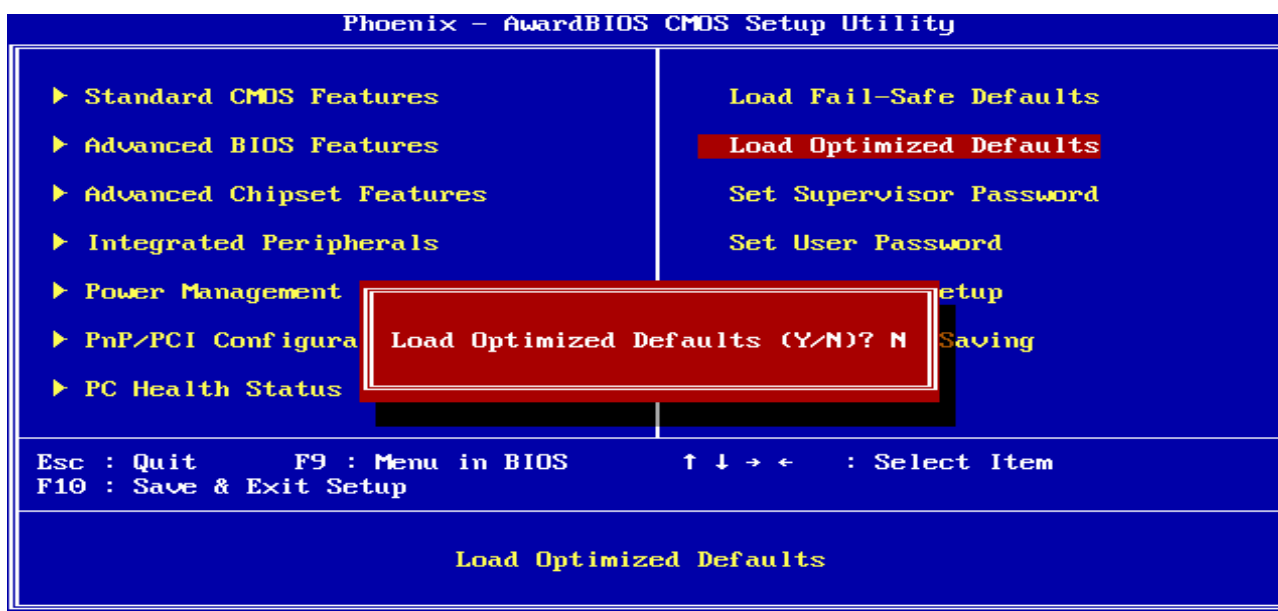

3.5.10 Set Supervisor / User Password

You can set either supervisor or user password, or both of them.

Supervisor Password: able to enter/change the options of setup menus.

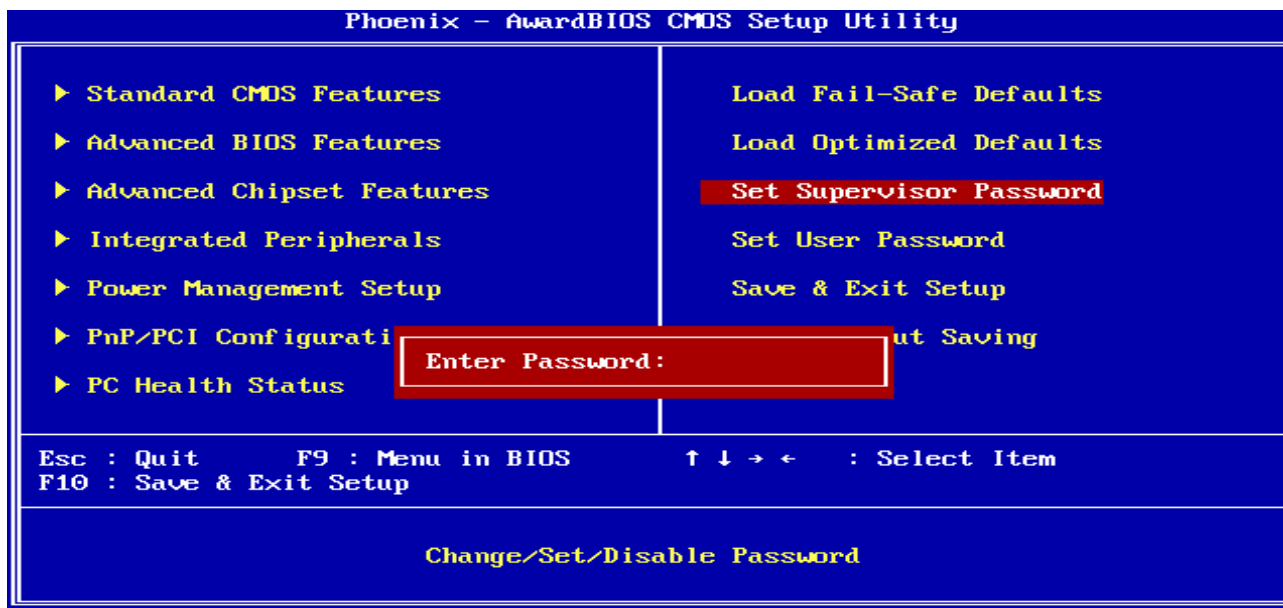

User Password: able to enter but no right to change the options of setup menus.

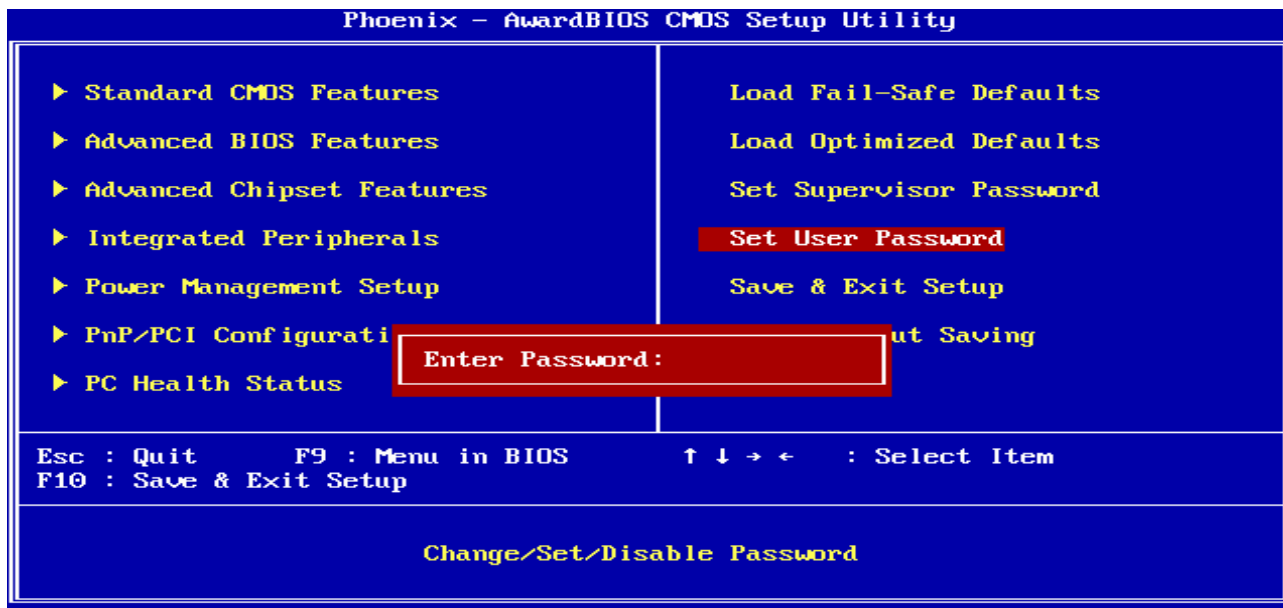

Type the password, up to eight characters in length, and press <Enter>. The password typed now will clear any previously entered password from CMOS memory. You will be asked to confirm the password. Type the password again and press <Enter>. You may also press <Esc> to abort the selection and not enter a password. To disable a password, just press <Enter> when you are prompted to enter the password. A message will confirm the password will be disabled. Once the password is disabled, the system will boot and you can enter Setup freely.

PASSWORD DISABLED.

When a password has been enabled, you will be prompted to enter it every time you try to enter Setup. This prevents an unauthorized person from changing any part of your system configuration. Additionally, when a password is enabled, you can also require the BIOS to request a password every time your system is rebooted. This would prevent unauthorized use of your computer. You determine when the password is required within the BIOS Features Setup Menu and its Security option (see Section 3). If the Security option is set to "System", the password will be required both at boot and at entry to Setup. If set to "Setup", prompting only occurs when trying to enter Setup

3.5.11 Save & Exit Setup

Save CMOS value changes to CMOS and exit setup.

Enter <Y> to store the selection made in the menus in CMOS, a special section in memory that stays on after turning the system off. The BIOS configures the system according to the Setup selection stored in CMOS when boot the computer next time.

The system is restarted after saving the values.

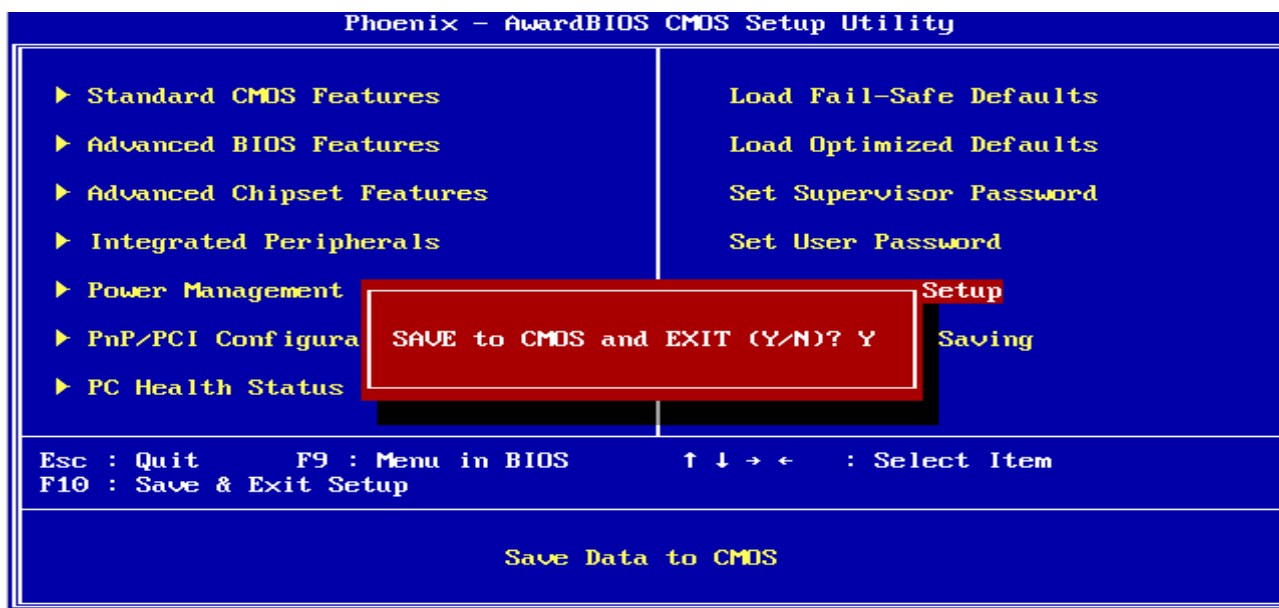

ESM-2850

3.5.12 Exit Without Save

Abandon all CMOS value changes and exit setup, and the system is restarted after exiting.

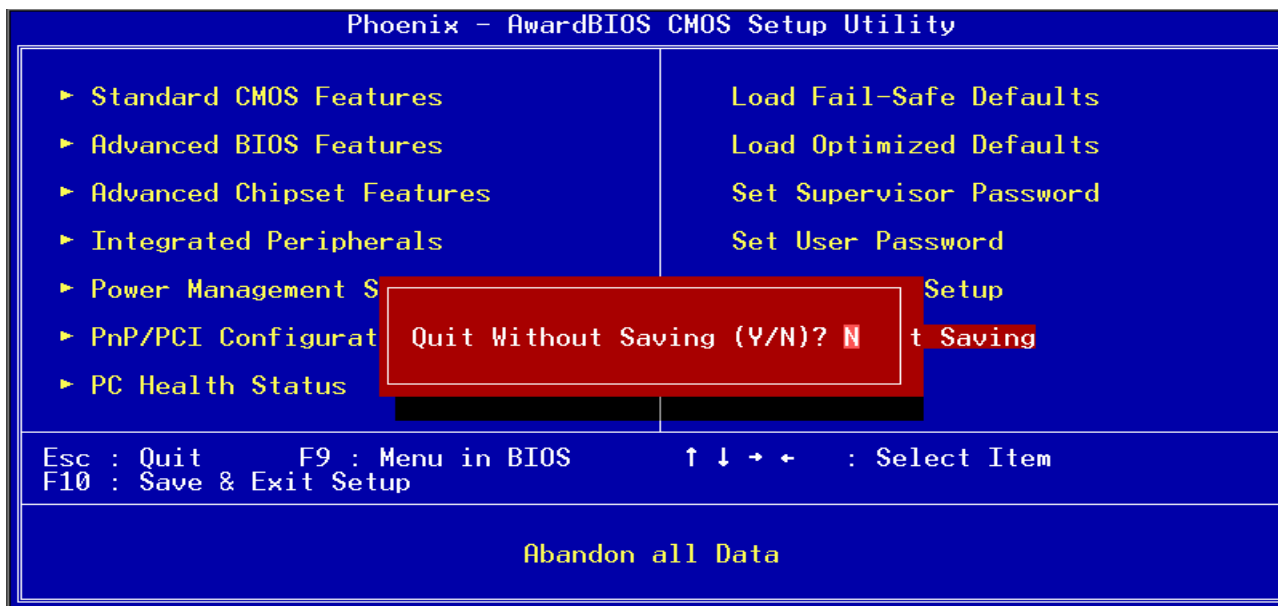

4 Drivers Installation



Note: Installation procedures and screen shots in this section are for your reference and may not be exactly the same as shown on your screen.

4.1 Install Chipset Driver (For Intel NQ82915GM)

Insert the Supporting CD-ROM to CD-ROM drive, and it should show the index page of Evalve's products automatically. If not, locate Index.htm and choose the product from the menu left, or link to \Driver_Chipset\Intel\915GM.



Note: The installation procedures and screen shots in this section are based on Windows XP operation system.

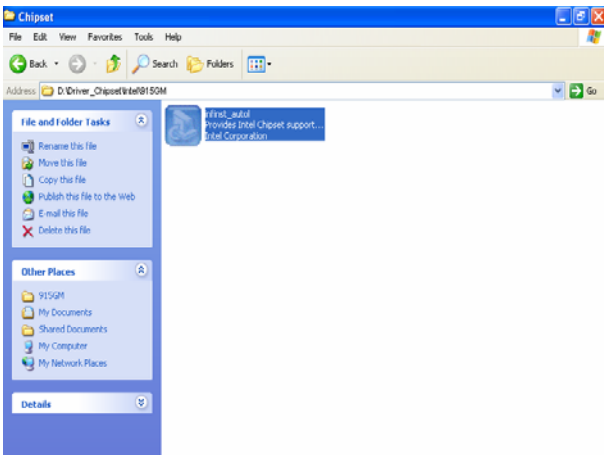

Step 1. Locate 「\Driver_Chipset\Intel\915GM\inst_autol.exe」.

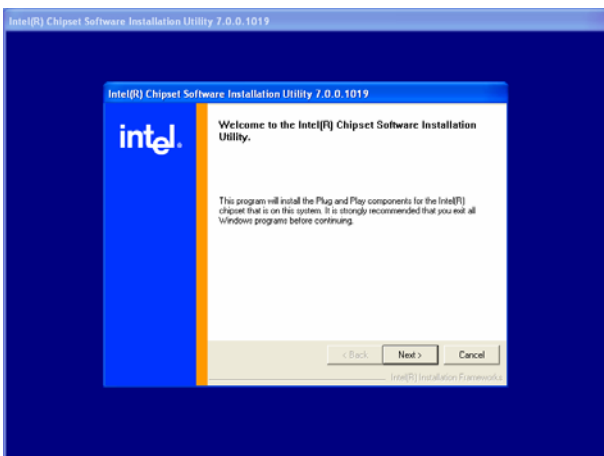

Step 2. Click **Next**.

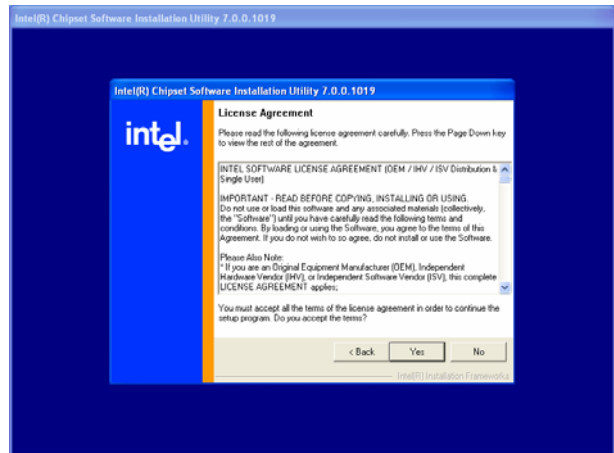

Step 3. Click **Yes** to accept the agreement.

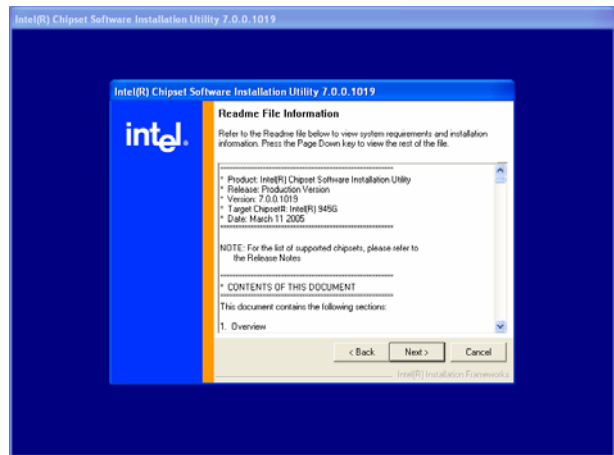

Step 4. Click **Next** to complete setup.

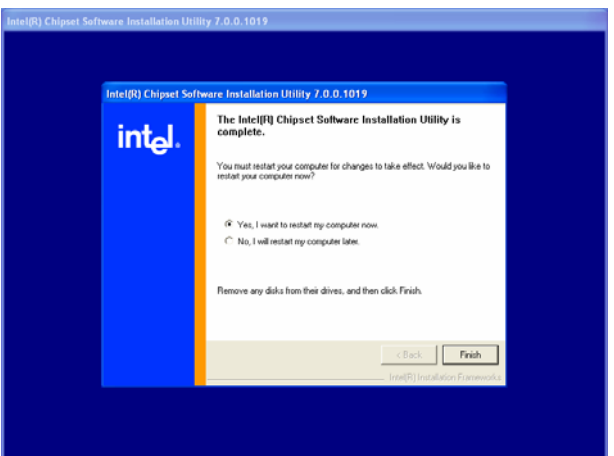

Step 4. Click **Finish** to complete setup and reboot the PC.

4.2 Install Display Driver (For Intel NQ82915GM)

Insert the Supporting CD-ROM to CD-ROM drive, and it should show the index page of Evalve's products automatically. If not, locate Index.htm and choose the product from the menu left, or link to \Driver_Video\Intel\82915GM.



Note: The installation procedures and screen shots in this section are based on Windows XP operation system.

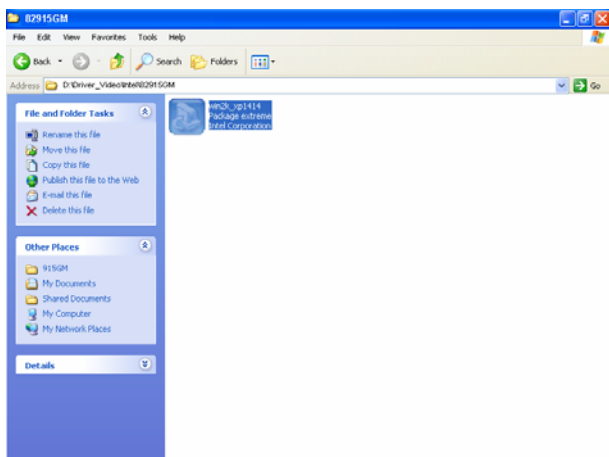

Step 1. Locate 「 Driver_Video\Intel\82915GM\ win2k_xp1415.exe 」 .

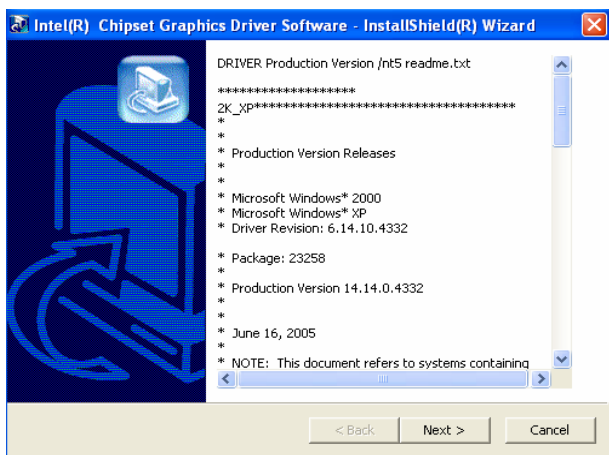

Step 2. Click **Next**.

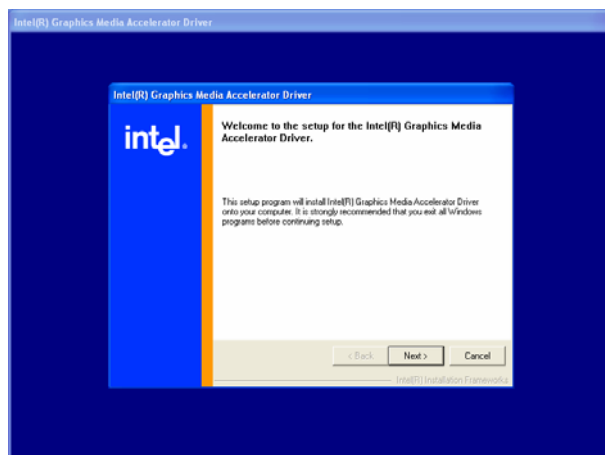

Step 3. Click **Next**.

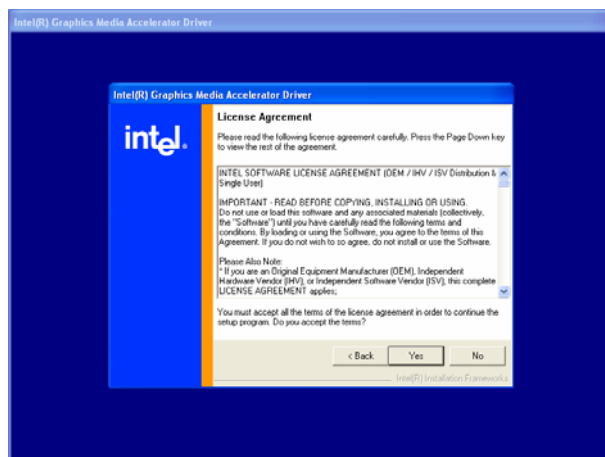

Step 4. Click **Yes** to accept the agreement.

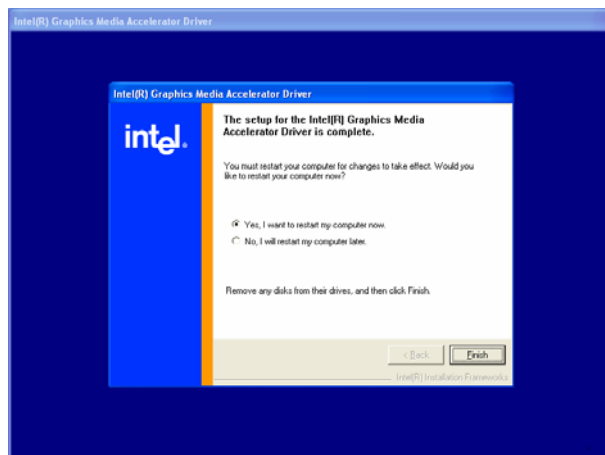

Step 5. Click **Finish** to complete setup and reboot the PC.

4.3 Install Audio Driver (For VIA VT1616)

Insert the Supporting CD-ROM to CD-ROM drive, and it should show the index page of Evalve's products automatically. If not, locate Index.htm and choose the product from the menu left, or link to \Driver_Audio\VIA\VT1616.



Note: The installation procedures and screen shots in this section are based on Windows XP operation system.

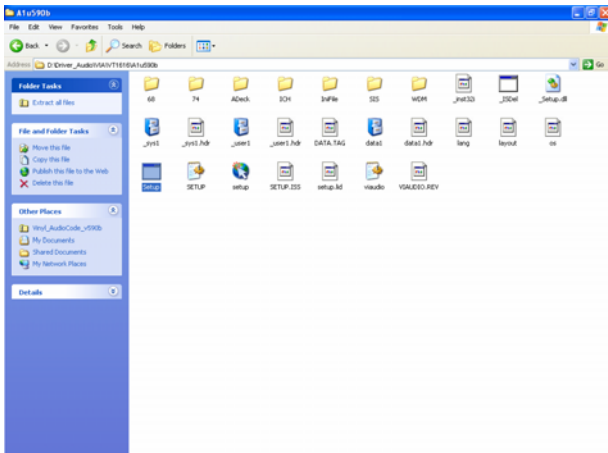

Step 1. Locate "D:\Driver_Audio\VIA\VT1616\A1u590b\setup.exe".

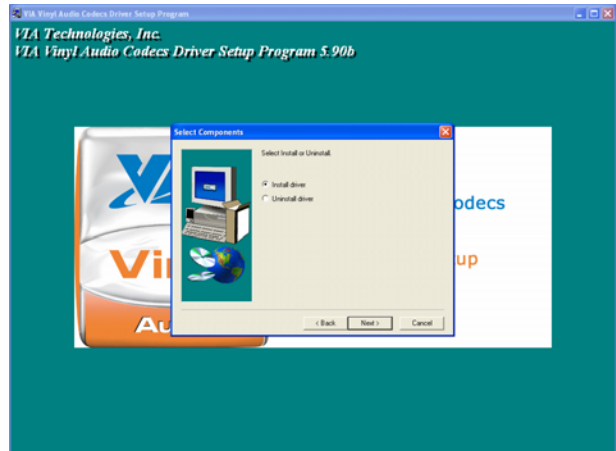

Step 3. Select **Install Driver** and click **Next** to the following step.



Step 4. Click **Continue Anyway** to run the setup.

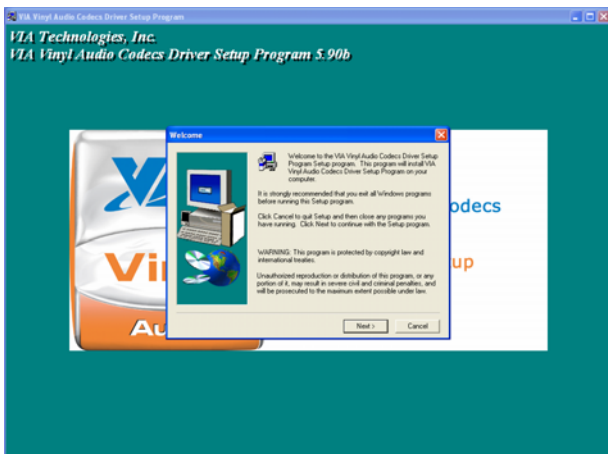

Step 2. Click **Next**.

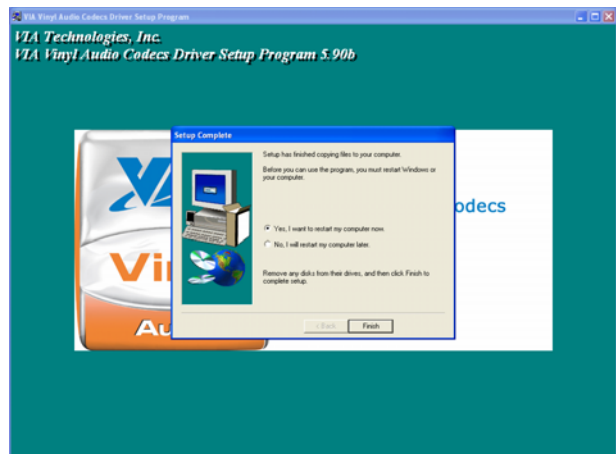

Step 5. Click **Finish** to complete the setup and restart the PC.

4.4 Install Ethernet Driver (For Marvell 88E8053 Gigabit LAN)

Insert the Supporting CD-ROM to CD-ROM drive, and it should show the index page of Evalue's products automatically. If not, locate Index.htm and choose the product from the menu left, or link to \Driver_Gigabit\Marvell\88E8053.



Note: The installation procedures and screen shots in this section are based on Windows XP operation system.

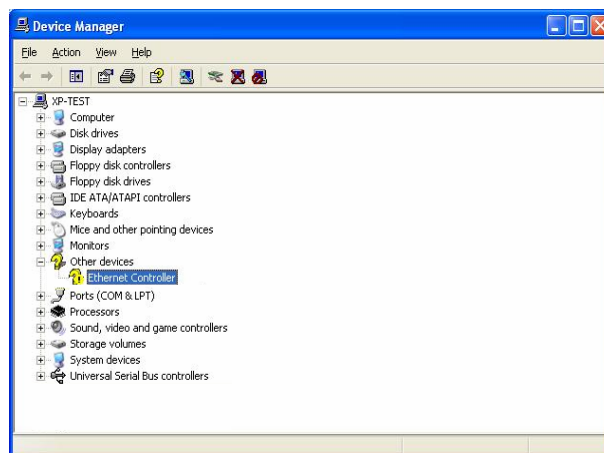

Step 3. Double click **Ethernet Controller**.

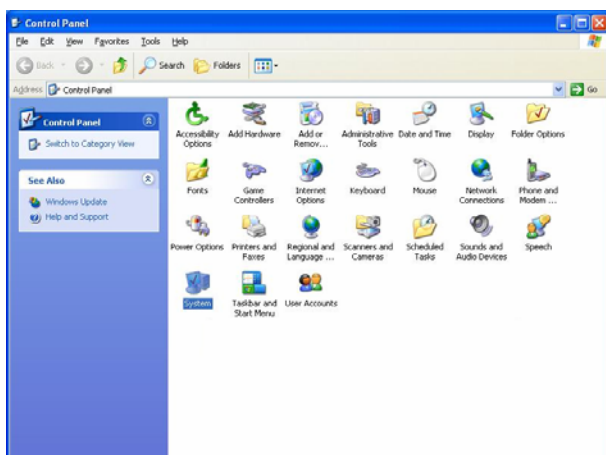

Step 1. Click **Start** of the task bar, then the **System of Performance and Maintenance** in **Control Panel**.

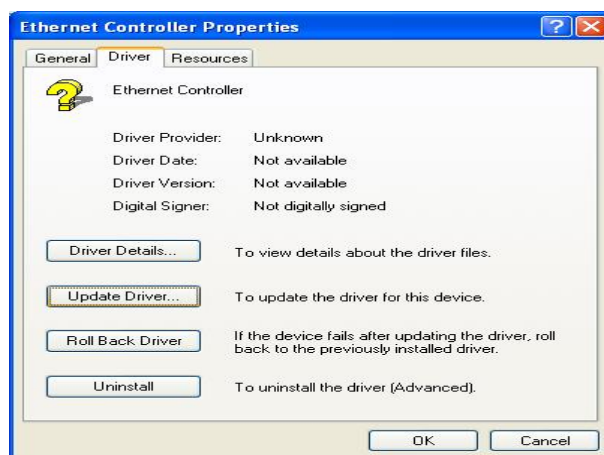

Step 4. Click **Update Driver**.

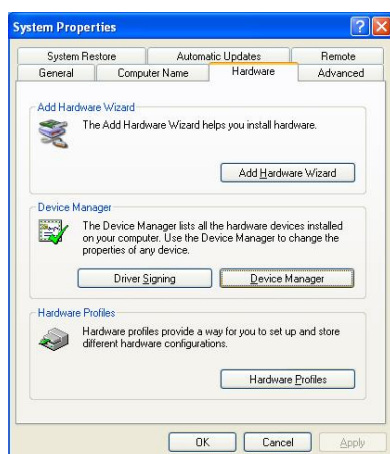

Step 2. Click **Device Manager** of **Hardware**.



Step 5. Select the **Advanced** item and click **Next**.



Step 6. Select the specific location to Next.

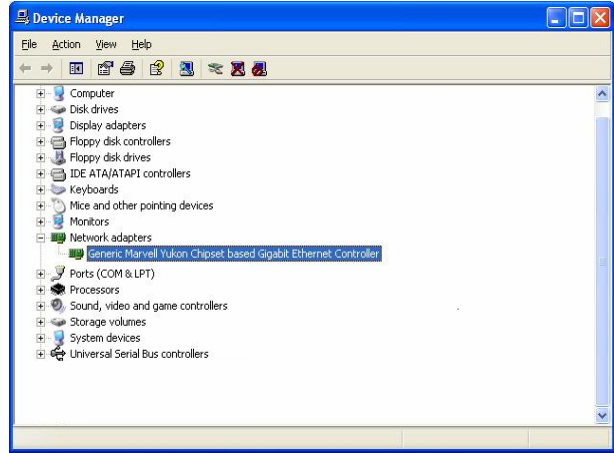

Step 9. Repeat the Step 1 ~ Step 3 to confirm the Generic Marvell is ready.

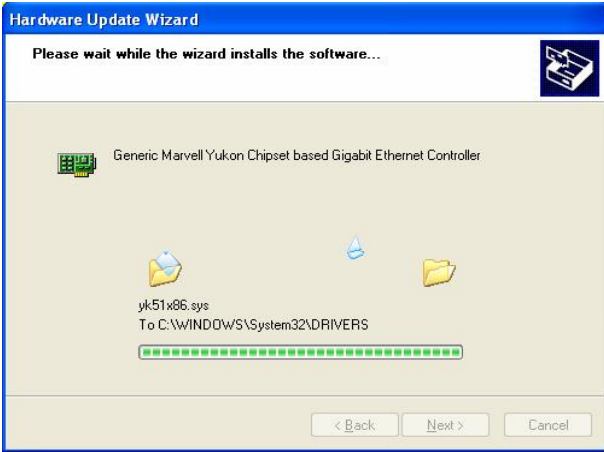

Step 7. The wizard runs the setup automatically.



Step 8. Click **Finish** to complete the installation.

5 Measurement Drawing

ESM-2850

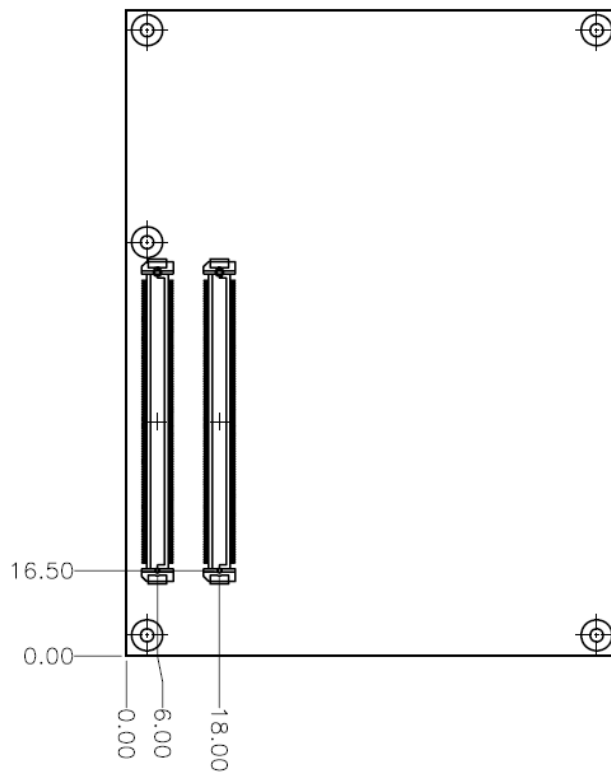
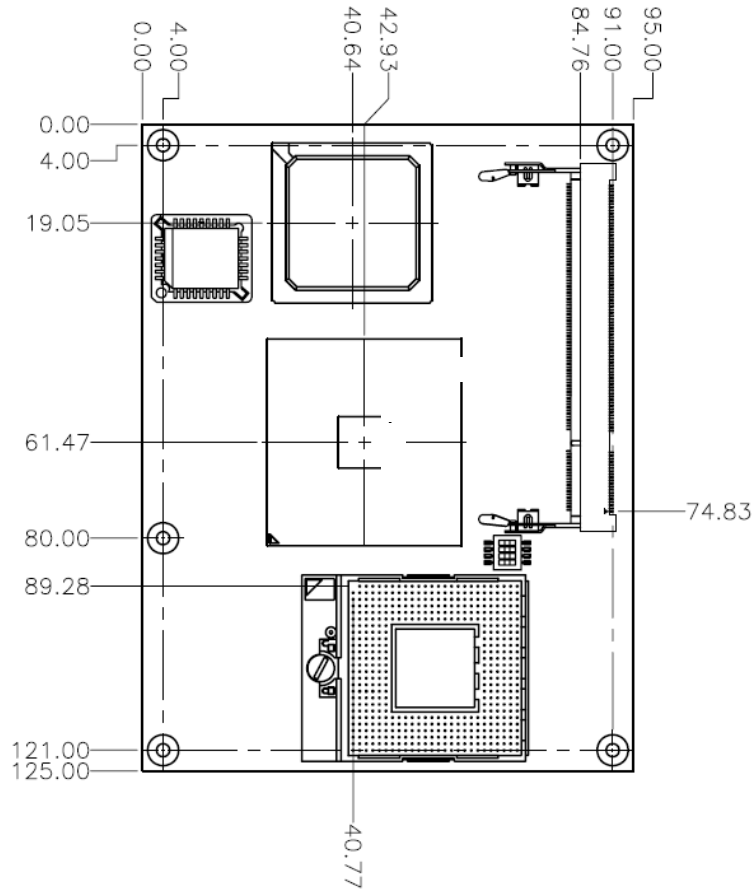

(Unit: mm)

Appendix A: BIOS Revisions

BIOS Rev.

New Features

Bugs/Problems Solved

Known Problems

Appendix B:

AWARD BIOS POST

Messages

Overview

During the Power On Self-Test (POST), if the BIOS detects an error requiring you to do something to fix, it will either sound a beep code or display a message.

If a message is displayed, it will be accompanied by:

PRESS F1 TO CONTINUE, CTRL-ALT-ESC OR DEL TO ENTER SETUP

Post Beep

Currently there are two kinds of beep codes in BIOS. This code indicates that a video error has occurred and the BIOS cannot initialize the video screen to display any additional information. This beep code consists of a single long beep followed by two short beeps. The other code indicates that your DRAM error has occurred. This beep code consists of a single long beep repeatedly.

Error Messages

One or more of the following messages may be displayed if the BIOS detects an error during the POST. This list includes messages for both the ISA and the EISA BIOS.

1. CMOS BATTERY HAS FAILED

CMOS battery is no longer functional. It should be replaced.

2. CMOS CHECKSUM ERROR

Checksum of CMOS is incorrect. This can indicate that CMOS has become corrupt. This error may have been caused by a weak battery. Check the battery and replace if necessary.

3. DISK BOOT FAILURE, INSERT SYSTEM DISK AND PRESS ENTER

No boot device was found. This could mean that either a boot drive was not detected or the drive does not contain proper system boot files. Insert a system disk into Drive A: and press <Enter>. If you assumed the system would boot from the hard drive, make sure the controller is inserted correctly and all cables are properly attached. Also be sure the disk is formatted as a boot device. Then reboot the system.

4. DISKETTE DRIVES OR TYPES MISMATCH ERROR - RUN SETUP

Type of diskette drive installed in the system is different from the CMOS definition. Run Setup to reconfigure the drive type correctly.

5. DISPLAY SWITCH IS SET INCORRECTLY

Display switch on the motherboard can be set to either monochrome or color. This indicates the switch is set to a different setting than indicated in Setup. Determine which setting is correct, and then either turn off the system and change the jumper, or enter Setup and change the VIDEO selection.

6. DISPLAY TYPE HAS CHANGED SINCE LAST BOOT

Since last powering off the system, the display adapter has been changed. You must configure the system for the new display type.

7. EISA Configuration Checksum Error

PLEASE RUN EISA CONFIGURATION UTILITY

The EISA non-volatile RAM checksum is incorrect or cannot correctly read the EISA slot. This can indicate either the EISA non-volatile memory has become corrupt or the slot has been configured incorrectly. Also be sure the card is installed firmly in the slot.

8. EISA Configuration Is Not Complete

PLEASE RUN EISA CONFIGURATION UTILITY

The slot configuration information stored in the EISA non-volatile memory is incomplete.



Note: When either of these errors appears, the system will boot in ISA mode, which allows you to run the EISA Configuration Utility.

9. ERROR ENCOUNTERED INITIALIZING HARD DRIVE

Hard drive cannot be initialized. Be sure the adapter is installed correctly and all cables are correctly and firmly attached. Also be sure the correct hard drive type is selected in Setup.

10. ERROR INITIALIZING HARD DISK CONTROLLER

Cannot initialize controller. Make sure the cord is correctly and firmly installed in the bus. Be sure the correct hard drive type is selected in Setup. Also check to see if any jumper needs to be set correctly on the hard drive.

11. FLOPPY DISK CNTRLR ERROR OR NO CNTRLR PRESENT

Cannot find or initialize the floppy drive controller. Make sure the controller is installed correctly and firmly. If there are no floppy drives installed, be sure the Diskette Drive selection in Setup is set to NONE.

12. Invalid EISA Configuration

PLEASE RUN EISA CONFIGURATION UTILITY

The non-volatile memory containing EISA configuration information was programmed incorrectly or has become corrupt. Re-run EISA configuration utility to correctly program the memory.



Note: When either of these errors appears, the system will boot in ISA mode, which allows you to run the EISA Configuration Utility.

13. KEYBOARD ERROR OR NO KEYBOARD PRESENT

Cannot initialize the keyboard. Make sure the keyboard is attached correctly and no keys are being pressed during the boot.

If you are purposely configuring the system without a keyboard, set the error halt condition in Setup to HALT ON ALL, BUT KEYBOARD. This will cause the BIOS to ignore the missing keyboard and continue the boot.

14. Memory Address Error at ...

Indicates a memory address error at a specific location. You can use this location along with the memory map for your system to find and replace the bad memory chips.

15. Memory parity Error at ...

Indicates a memory parity error at a specific location. You can use this location along with the memory map for your system to find and replace the bad memory chips.

16. MEMORY SIZE HAS CHANGED SINCE LAST BOOT

Memory has been added or removed since the last boot. In EISA mode use Configuration Utility to reconfigure the memory configuration. In ISA mode enter Setup and enter the new memory size in the memory fields.

17. Memory Verify Error at ...

Indicates an error verifying a value already written to memory. Use the location along with your system's memory map to locate the bad chip.

18. OFFENDING ADDRESS NOT FOUND

This message is used in conjunction with the I/O CHANNEL CHECK and RAM PARITY ERROR messages when the segment that has caused the problem cannot be isolated.

19. OFFENDING SEGMENT:

This message is used in conjunction with the I/O CHANNEL CHECK and RAM PARITY ERROR messages when the segment that has caused the problem has been isolated.

20. PRESS A KEY TO REBOOT

This will be displayed at the bottom screen when an error occurs that requires you to reboot. Press any key and the system will reboot.

21. PRESS F1 TO DISABLE NMI, F2 TO REBOOT

When BIOS detects a Non-maskable Interrupt condition during boot, this will allow you to disable the NMI and continue to boot, or you can reboot the system with the NMI enabled.

22. RAM PARITY ERROR - CHECKING FOR SEGMENT ...

Indicates a parity error in Random Access Memory.

23. Should Be Empty But EISA Board Found

PLEASE RUN EISA CONFIGURATION UTILITY

A valid board ID was found in a slot that was configured as having no board ID.



Note: When either of these errors appears, the system will boot in ISA mode, which allows you to run the EISA Configuration Utility.

24. Should Have EISA Board But Not Found

PLEASE RUN EISA CONFIGURATION UTILITY

The board installed is not responding to the ID request, or no board ID has been found in the indicated slot.



Note: When either of these errors appears, the system will boot in ISA mode, which allows you to run the EISA Configuration Utility.

25. Slot Not Empty

Indicates that a slot designated as empty by the EISA Configuration Utility actually contains a board.



Note: When either of these errors appears, the system will boot in ISA mode, which allows you to run the EISA Configuration Utility.

26. SYSTEM HALTED, (CTRL-ALT-DEL) TO REBOOT ...

Indicates the present boot attempt has been aborted and the system must be rebooted. Press and hold down the CTRL and ALT keys and press DEL.

27. Wrong Board In Slot**PLEASE RUN EISA CONFIGURATION UTILITY**

The board ID does not match the ID stored in the EISA non-volatile memory.



Note: When either of these errors appears, the system will boot in ISA mode, which allows you to run the EISA Configuration Utility.

28. FLOPPY DISK(S) fail (80) → Unable to reset floppy subsystem.

29. FLOPPY DISK(S) fail (40) → Floppy Type mismatch.

30. Hard Disk(s) fail (80) → HDD reset failed.

31. Hard Disk(s) fail (40) → HDD controller diagnostics failed.

32. Hard Disk(s) fail (20) → HDD initialization error.

33. Hard Disk(s) fail (10) → Unable to recalibrate fixed disk.

34. Hard Disk(s) fail (08) → Sector Verify failed.

35. Keyboard is locked out - Unlock the key.

BIOS detect the keyboard is locked. P17 of keyboard controller is pulled low.

36. Keyboard error or no keyboard present.

Cannot initialize the keyboard. Make sure the keyboard is attached correctly and no keys are being pressed during the boot.

37. Manufacturing POST loop.

System will repeat POST procedure infinitely while the P15 of keyboard controller is pull low. This is also used for M/B burn in test.

38. BIOS ROM checksum error - System halted.

The checksum of ROM address F0000H-FFFFFFH is bad.

39. Memory test fail.

BIOS reports the memory test fail if the onboard memory is tested error.

40. POST Codes

Please take reference to Phoenix-Award website for the latest post codes.

<http://www.phoenix.com/en/Customer+Services/BIOS/AwardBIOS/Award+Error+Codes.htm>

40.1 Normal POST Code



Note: EISA POST codes are typically output to port address 300h. ISA POST codes are output to port address 80h.

Code (hex)	Name	Description
C0	Turn Off Chipset and CPU test	OEM Specific-Cache control cache Processor Status (1FLAGS) Verification. Tests the following processor status flags: Carry, zero, sign, overflow, the BIOS sets each flag, verifies They are set, then turns each flag off and verifies it is off. Read/Write/Verify all CPU registers except SS, SP, and BP with data pattern FF and 00. RAM must be periodically refreshed to keep the memory from decaying. This function ensures that the memory refresh function is working properly.
C1	Memory Presence	First block memory detect OEM Specific-Test to size on-board memory. Early chip set initialization Memory presence test OEM chip set routines clear low 64K of memory Test first 64K memory.
C2	Early Memory Initialization	OEM Specific- Board Initialization
C3	Extend Memory DRAM select	OEM Specific- Turn on extended memory Initialization Cyrix CPU initialization, Cache initialization
C4	Special Display Handling	OEM Specific- Display/Video Switch handling so that switch handling display switch errors never occurs
C5	Early Shadow	OEM specific- Early shadow enable for fast boot
C6	Cache presence test	External cache size detection
CF	CMOS Check	CMOS checkup
B0	Spurious	If interrupt occurs in protected mode.
B1	Unclaimed NMI	If unmasked NMI occurs, display Press F1 to disable NMI, F2 reboot.
BF	Program Chip Set	To program chipset from defaults values
E1-EF	Setup Pages	E1- Page 1, E2 - Page 2, etc.
1	Force load Default to chipset	Chipset defaults program
2	Reserved	

Code (hex)	Name	Description
3	Early Superio Init	Early Initialized the super IO
4	Reserved	
5	Blank video	Reset Video controller
6	Reserved	
7	Init KBC	Keyboard controller init
8	KB test	Test the Keyboard
9	Reserved	
A	Mouse Init	Initialized the mouse
B	Onboard Audio init	Onboard audio controller initialize if exist
C	Reserved	
D	Reserved	
E	CheckSum Check	Check the intergraty of the ROM, BIOS and message
F	Reserved	
10	Auto detec EEPROM	Check Flash type and copy flash write/erase routines to 0F000h segments
11	Reserved	
12	Cmos Check	Check Cmos Circuitry and reset CMOS
13	Reserved	
14	Chipset Default load	Program the chipset registers with CMOS values
15	Reserved	
16	Clock Init	Init onboard clock generator
17	Reserved	
18	Identify the CPU	Check the CPU ID and init L1/L2 cache
19	Reserved	
1A	Reserved	
1B	Setup Interrupt Vector Table	Initialize first 120 interrupt vectors with SPURIOUS_INT_HDLR and initialize INT 00h-1Fh according to INT_TBL
1C	Reserved	
1D	Early PM Init	First step initialize if single CPU onboard
1E	Reserved	
1F	Re-initial KB	Re-init KB
20	Reserved	
21	HPM init	If support HPM, HPM get initialized here
22	Reserved	
23	Test CMOS Interface and battery Status	Verifies CMOS is working correctly, detects bad battery. If failed, load CMOS defaults and load into chipset
24	Reserved	

ESM-2850

Code (hex)	Name	Description
25	Reserved	
26	Reserved	
27	KBC final Init	Final Initial KBC and setup BIOS data area
28	Reserved	
29	Initialize Video Interface	Read CMOS location 14h to find out type of video in use. Detect and Initialize Video Adapter.
2A	Reserved	
2B	Reserved	
2C	Reserved	
2D	Video memory test	Test video memory, write sign-on message to screen. Setup shadow RAM - Enable shadow according to Setup.
2E	Reserved	
2F	Reserved	
30	Reserved	
31	Reserved	
32	Reserved	
33	PS2 Mouse setup	Setup PS2 Mouse and reset KB
34	Reserved	
35	Test DMA Controller 0	Test DMA Controller 0
36	Reserved	
37	Test DMA Controller 1	Test DMA Controller 1
38	Reserved	
39	Test DMA Page Registers	Test DMA Page Registers.
3A	Reserved	
3B	Reserved	
3C	Test Timer Counter 2	Test 8254 Timer 0 Counter 2.
3D	Reserved	
3E	Test 8259-1 Mask Bits	Verify 8259 Channel 1 masked interrupts by alternately turning off and on the interrupt lines.
3F	Reserved	
40	Test 8259-2 Mask Bits	Verify 8259 Channel 2 masked interrupts by alternately turning off and on the interrupt lines.
41	Reserved	
42	Reserved	

Code (hex)	Name	Description
43	Test Stuck 8259's Interrupt Bits Test 8259 Interrupt Functionality	Turn off interrupts then verify no interrupt mask register is on. Force an interrupt and verify the interrupt occurred.
44	Reserved	
45	Reserved	
46	Reserved	
47	Set EISA Mode	If EISA non-volatile memory checksum is good, execute EISA initialization. If not, execute ISA tests and clear EISA mode flag.
48	Reserved	
49	Size Base and Extended Memory	Size base memory from 256K to 640K and extended memory above 1MB.
4A	Reserved	
4B	Reserved	
4C	Reserved	
4D	Reserved	
4E	Test Base and Extended Memory	Test base memory from 256K to 640K and extended memory above 1MB using various patterns. NOTE: This test is skipped in EISA mode and can be skipped with ESC key in ISA mode.
4F	Reserved	
50	USB init	Initialize USB controller
51	Reserved	
52	Memory Test	Test all memory of memory above 1MB using Virtual 8086 mode, page mode and clear the memory
53	Reserved	
54	Reserved	
55	CPU display	Detect CPU speed and display CPU vendor specific version string and turn on all necessary CPU features
56	Reserved	
57	PnP Init	Display PnP logo and PnP early init
58	Reserved	
59	Setup Virus Protect	Setup virus protect according to Setup
5A	Reserved	
5B	Awdflash Load	If required, will auto load Awdflash.exe in POST
5C	Reserved	
5D	Onboard I/O Init	Initializing onboard superIO

ESM-2850

Code (hex)	Name	Description
5E	Reserved	
5F	Reserved	
60	Setup enable	Display setup message and enable setup functions
61	Reserved	
62	Reserved	
63	Initialize & Install Mouse	Detect if mouse is present, initialize mouse, install interrupt vectors.
64	Reserved	
65	PS2 Mouse special	Special treatment to PS2 Mouse port
66	Reserved	
67	ACPI init	ACPI sub-system initializing
68	Reserved	
69	Setup Cache Controller	Initialize cache controller.
6A	Reserved	
6B	Setup Entering	Enter setup check and auto- configuration check up
6C	Reserved	
6D	Initialize Floppy Drive & Controller	Initialize floppy disk drive controller and any drives.
6E	Reserved	
6F	FDD install	Install FDD and setup BIOS data area parameters
70	Reserved	
71	Reserved	
72	Reserved	
73	Initialize Hard Drive & Controller	Initialize hard drive controller and any drives.
74	Reserved	
75	Install HDD	IDE device detection and install
76	Reserved	
77	Detect & Initialize Serial/Parallel Port	Initialize any serial and parallel ports (also game port).
78	Reserved	
79	Reserved	
7A	Detect & Initialize Math Coprocessor	Initialize math coprocessor.
7B	Reserved	
7C	HDD Check for Write protection	HDD check out

Code (hex)	Name	Description
7D	Reserved	
7E	Reserved	
7F	POST error check	Check POST error and display them and ask for user intervention
80	Reserved	
81	Reserved	
82	Security Check	Ask password security (optional).
83	Write CMOS	Write all CMOS values back to RAM and clear screen.
84	Pre-boot Enable	Enable parity checker. Enable NMI, Enable cache before boot.
85	Initialize Option ROMs	Initialize any option ROMs present from C8000h to EFFFFh. NOTE: When FSCAN option is enabled, ROMs initialize from C8000h to F7FFFh.
86	Reserved	
87	Reserved	
88	Reserved	
89	Reserved	
8A	Reserved	
8B	Reserved	
8C	Reserved	
8D	Reserved	
8E	Reserved	
8F	Reserved	
90	Reserved	
91	Reserved	
92	Reserved	
93	Boot Medium detection	Read and store boot partition head and cylinders values in RAM
94	Final Init	Final init for last micro details before boot
95	Special KBC patch	Set system speed for boot. Setup NumLock status according to Setup
96	Boot Attempt	Set low stack Boot via INT 19h.
FF	Boot	

40.2 Quick POST Codes

Code (hex)	Name	Description
65	Init onboard device	Early Initialized the super IO. Reset Video controller. Keyboard controller init Test the Keyboard Initialized the mouse Onboard audio controller initialize if exist. Check the intergraty of the ROM, BIOS and message Check Flash type and copy flash write/erase routines to 0F000h segments Check Cmos Circuitry and reset CMOS Program the chipset registers with CMOS values Init onboard clock generator
66	Early Sytem setup	Check the CPU ID and init L1/L2 cache. Initialize first 120 interrupt vectors with SPURIOUS_INT_HDLR and 10 initialize INT 00h-1Fh according to INT_TBL First step initialize if single CPU onboard. Re-init KB If support HPM, HPM get initialized here.
67	KBC and CMOS Init	Verifies CMOS is working correctly, detects bad battery. If failed, load CMOS defaults and load into chipset. Final Initial KBC and setup BIOS data area.
68	Video Init	Read CMOS location 14h to find out type of video in use. Detect and Initialize Video Adapter. Test video memory, write sign-on message to screen. Setup shadow RAM - Enable shadow according to Setup.
69	8259 Init	Init 8259 channel 1 and mask IRQ 9
6A	Memory test	Quick Memory Test
6B	CPU Detect and IO init	CPU vendor specific version string and turn on all necessary CPU features Display PnP logo and PnP early init Setup virus protect according to Setup. If required, will auto load Awdflash.exe in POST Initializing onboard superIO
6C	Reserved	
6D	Reserved	
6E	Reserved	
6F	Reserved	
70	Setup Init	Display setup message and enable setup functions Detect if mouse is present, initialize mouse, install interrupt vectors. Special treatment to PS2 Mouse port ACPI sub-system initializing
71	Setup Cache Controller	Initialize cache controller.

Code (hex)	Name	Description
72	Install FDD	Enter setup check and auto11 configuration check up Initialize floppy disk drive controller and any drives. Install FDD and setup BIOS data area parameters
73	Install FDD	Initialize hard drive controller and any drives. IDE device detection and install Initialize any serial and parallel ports (also game port).
74	Detect & Initialize Math Coprocessor	Initialize math coprocessor.
75	HDD Check for Write protection	HDD check out
76	Reserved	
77	Display POST error	Check POST error and display them and ask for user intervention Ask password security (optional).
78	CMOS and Option ROM Init	Write all CMOS values back to RAM and clear screen. Enable parity checker Enable NMI, Enable cache before boot. Initialize any option ROMs present from C8000h to EFFFFh. NOTE: When FSCAN option is enabled, ROMs initialize from C8000h to F7FFFh.
79	Reserved	
7A	Reserved	
7B	Reserved	
7C	Reserved	
7D	Boot Medium detection	Read and store boot partition head and cylinders values in RAM
7E	Final Init	Final init for last micro details before boot
7F	Special KBC patch	Set system speed for boot. Setup NumLock status according to Setup.
80	Boot Attempt	Set low stack Boot via INT 19h.
FF	Boot	

40.3S4 POST Codes

Code (hex)	Name	Description
5A	Early Chipset Init	Early Initialized the super IO. Reset Video controller. Keyboard controller init. Test the Keyboard Initialized the mouse
5B	Cmos Check	Check Cmos Circuitry and reset CMOS
5C	Chipset default Prog	Program the chipset registers with CMOS values. Init onboard clock generator
5D	Identify the CPU	Check the CPU ID and init L1/L2 cache Initialize first 120 interrupt vectors with SPURIOUS_INT_HDLR and INT 00h-1Fh according to INT_TBL. First step initialize if single CPU Onboard. Re-init KB If support HPM, HPM get initialized Here.
5E	Setup Interrupt Vector Table	Initialize first 120 interrupt vectors with SPURIOUS_INT_HDLR and INT 00h-1Fh according to INT_TBL. First step initialize if single CPU Onboard. Re-init KB If support HPM, HPM get initialized here.
5F	Test CMOS Interface and Battery status	Verifies CMOS is working correctly, detects bad battery. If failed, load CMOS defaults and load into chipset.
60	KBC final Init	Final Initial KBC and setup BIOS data area
61	Initialize Video Interface	Read CMOS location 14h to find out type of video in use. Detect and Initialize Video Adapter.
62	Video memory test	Test video memory, write sign-on Test video memory, write sign-on message to screen. Setup shadow RAM - Enable shadow according to Setup.
63	Setup PS2 mouse and test DMA	Setup PS2 Mouse and reset KB Test DMA channel 0
64	Test 8259	Test 8259 channel 1 and mask IRQ 9
65	Init Boot Device	Detect if mouse is present, initialize mouse, install interrupt vectors. Special treatment to PS2 Mouse port ACPI sub-system initializing Initialize cache controller.
66	Install Boot Devices	Enter setup check and auto-configuration check up Initialize floppy disk drive controller and any drives. Install FDD and setup BIOS data area Parameters Initialize hard drive controller and any drives. IDE device detection and install
67	Cache Init	Cache init and USB init
68	PM init	PM initialization
69	PM final Init and issue SMI	Final init Before resume
FF	Full on	

40.4 BootBlock POST Codes

Code (hex)	Name	Description
1	Base memory test	Clear base memory area (0000:0000--9000:ffffh)
5	KB init	Initialized KBC
12	Install interrupt vectors	Install int. vector (0-77), and initialized 00-1fh to their proper place
0D	Init Video	Video initializing
41	Init FDD	Scan floppy and media capacity for onboard superIO
FF	Boot	Load boot sector

Free Manuals Download Website

<http://myh66.com>

<http://usermanuals.us>

<http://www.somanuals.com>

<http://www.4manuals.cc>

<http://www.manual-lib.com>

<http://www.404manual.com>

<http://www.luxmanual.com>

<http://aubethermostatmanual.com>

Golf course search by state

<http://golfingnear.com>

Email search by domain

<http://emailbydomain.com>

Auto manuals search

<http://auto.somanuals.com>

TV manuals search

<http://tv.somanuals.com>