

CR-4

4 TRACK CASSETTE TAPE RECORDER



Owner's Manual

REIMS

KORG

Ⓔ ①

Precautions

Location

Using the unit in the following locations can result in a malfunction.

- In direct sunlight
- Locations of extreme temperature or humidity
- Excessively dusty or dirty locations
- Locations of excessive vibration
- Close to magnetic fields

Power supply

Please connect the designated AC adapter to an AC outlet of the correct voltage. Do not connect it to an AC outlet of voltage other than that for which your unit is intended.

Interference with other electrical devices

Radios and televisions placed nearby may experience reception interference. Operate this unit at a suitable distance from radios and televisions.

Handling

To avoid breakage, do not apply excessive force to the switches or controls.

Care

If the exterior becomes dirty, wipe it with a clean, dry cloth. Do not use liquid cleaners such as benzene or thinner, or cleaning compounds or flammable polishes.

Keep this manual

After reading this manual, please keep it for later reference.

Keeping foreign matter out of your equipment

Never set any container with liquid in it near this equipment. If liquid gets into the equipment, it could cause a breakdown, fire, or electrical shock.

Be careful not to let metal objects get into the equipment. If something does slip into the equipment, unplug the AC adapter from the wall outlet. Then contact your nearest Korg dealer or the store where the equipment was purchased.

THE FCC REGULATION WARNING (for U.S.A.)

This equipment has been tested and found to comply with the limits for a Class B digital device, pursuant to Part 15 of the FCC Rules. These limits are designed to provide reasonable protection against harmful interference in a residential installation.

This equipment generates, uses, and can radiate radio frequency energy and, if not installed and used in accordance with the instructions, may cause harmful interference to radio communications. However, there is no guarantee that interference will not occur in a particular installation. If this equipment does cause harmful interference to radio or television reception, which can be determined by turning the equipment off and on, the user is encouraged to try to correct the interference by one or more of the following measures:

- Reorient or relocate the receiving antenna.
- Increase the separation between the equipment and receiver.
- Connect the equipment into an outlet on a circuit different from that to which the receiver is connected.
- Consult the dealer or an experienced radio/TV technician for help.

Unauthorized changes or modification to this system can void the user's authority to operate this equipment.

CE mark for European Harmonized Standards

CE mark which is attached to our company's products of AC mains operated apparatus until December 31, 1996 means it conforms to EMC Directive (89/336/EEC) and CE mark Directive (93/68/EEC).

And, CE mark which is attached after January 1, 1997 means it conforms to EMC Directive (89/336/EEC), CE mark Directive (93/68/EEC) and Low Voltage Directive (73/23/EEC).

Also, CE mark which is attached to our company's products of Battery operated apparatus means it conforms to EMC Directive (89/336/EEC) and CE mark Directive (93/68/EEC).

COPYRIGHT WARNING

This professional device is intended only for use with works for which you yourself own the copyright, for which you have received permission from the copyright holder to publicly perform, record, broadcast, sell, and duplicate, or in connection with activities which constitute "fair use" under copyright law. If you are not the copyright holder, have not received permission from the copyright holder, or have not engaged in fair use of the works, you may be violating copyright law, and may be liable for damages and penalties. If you are unsure about your rights to a work, please consult a copyright attorney. **KORG TAKES NO RESPONSIBILITY FOR ANY INFRINGEMENT COMMITTED THROUGH USE OF KORG PRODUCTS.**

*Company names, product names, and names of formats etc. are the trademarks or registered trademarks of their respective owners.

Introduction	4
Unpacking your CR-4	4
About this manual	4
Features of the CR-4	4
A few dos and don'ts	4
About multitrack recording	5
About the Ampworks effects	5
Finding your way around the CR-4	6
Setting up the CR-4	7
Connections to the CR-4	7
Connections from the CR-4	7
Connecting the power	7
Inserting the tape	7
Making your first recording	9
Recording the rhythm machine	9
Recording a bass	10
Recording a guitar	11
Recording vocals	11
Mixdown	12
More advanced techniques	13
Multi-track recording	13
Expanding the inputs	13
Expanding the number of tracks	13
Using the noise reduction	13
Ampworks effects	14
What is REMS?	14
Controls	14
Modeling type	14
Effects	15
The TAP control	15
Further uses for the CR-4	16
Using the CR-4 as a guitar combo	16
Using the CR-4 as a pre-amplifier	16
Specifications	17
Cassette recorder	17
Physical specifications	17
Audio specifications and performance	17
Effects	17
Dimensional drawing	17
Block Diagram	18

Introduction

● ● ● ● ● ● ● ● ● ● ● ● ● ● ● ● Unpacking your CR-4

When you first open the packing for your CR-4, you should find the following (as well as this manual):

- The CR-4 itself
- An AC power adapter
- Your warranty card and other service information.



Contact your KORG dealer if any of these items are missing.

Save the packing in case you ever need to return the CR-4 for service.

 Only use the AC adaptor supplied with your CR-4, and make sure that the voltage marked on the adapter matches your household AC voltage. If you are in any doubt, consult your KORG dealer.

● ● ● ● ● ● ● ● ● ● ● ● ● ● ● ● About this manual

In this manual, we'll use the following conventions :

- Steps that you follow are marked in order, like:
 - 1 Connect the power.
 - 2 Switch on the power switch.
- When we mention a control or indicator on the CR-4, we put it in brackets, like [PLAY].
- This symbol  indicates a caution.
- This symbol  indicates advice.
- We'll point you to other pages in the manual like this: (→p.6).

● ● ● ● ● ● ● ● ● ● ● ● ● ● ● ● Features of the CR-4

Key features of the CR-4 include the following:

High-quality multitrack cassette tape deck

The CR-4 includes a multitrack cassette tape deck, allowing you to use everyday low-cost cassette media to make your own multitrack recordings. You can record up to four tracks at a time, mixing guitars, bass, keyboards, and microphone inputs before creating your own mixes using a stereo cassette deck, CD, or even to a computer where you can make your own MP3s.

● ● ● ● ● ● ● ● ● ● ● ● ● ● ● ● **Ampworks guitar effects**

The integrated Ampworks guitar effects provide you with a wide range of guitar and bass amplifiers, that include high-quality professional-sounding digital effects such as reverb, delay, chorus, etc. Just plug into the CR-4 and go!

And you can use the Ampworks effects with the CR-4 to feed a larger amplification system, or practice your favorite licks and riffs using the CR-4 on its own.

● ● ● ● ● ● ● ● ● ● ● ● ● ● ● ● **Other Ampworks effects**

The CR-4 also provides two microphone models, allowing you to simulate the sound of two of the world's most famous microphones, as well as an "acoustic" model bypass effect. The built-in 3-band EQ features a sweepable midrange frequency control for these modes.

● ● ● ● ● ● ● ● ● ● ● ● ● ● ● ● **Built-in amplifier and speakers**

To cut down on the number of cables and connections you need to record, you can use the built-in bass-reflex speaker system.

Or, if you get a bit carried away, you can keep your playing to yourself (and a friend!) using the dual headphone facilities—this means that a singer and guitarist can both use headphones at the same time.

● ● ● ● ● ● ● ● ● ● ● ● ● ● ● ● **Easy operation**

The CR-4 has been designed to be as easy as possible to operate. If you can use a stereo cassette deck, you can use the CR-4 to make your own recordings.

Read through this manual to find out what you can do with the CR-4, and how to do it.

● ● ● ● ● ● ● ● ● ● ● ● ● ● ● ● **A few dos and don'ts**

There are some basic safety precautions at the beginning of this manual which you should read and note. In addition, please note the following:

- Keep the tape heads clean using cassette head cleaning kits—available from most electronic stores.
- Cassette tapes are sensitive to magnetic fields. Don't use the CR-4 near TV sets or computer monitors, and don't store the cassettes anywhere near these devices, or near equipment with large electric motors.

- Avoid smoking, eating or drinking over the CR-4. Smoke particles, food crumbs and spilled liquids are the enemies of fine audio gear.
- Use the best possible new cassettes (Type II) wherever possible, for high quality results.
- Use shorter tapes whenever you can. Avoid C-90 (or longer) tapes if possible because the tapes are thin, and may stretch or even break. Because the CR-4 only plays tapes in one direction, you will get half the stated recording time on a tape.
- Keep the listening levels low. High levels can destroy hearing (and you never get it back!).

● ● ● ● ● ● ● ● ● ● ● ● ● ● ● ● About multitrack recording

As we mentioned earlier, the CR-4 allows you to perform multitrack recording. Multitracking allows you to record the different parts of a piece of music separately, meaning that if you play a perfect guitar solo, but make a mess of the vocals, you don't have to record everything again—just the vocals.

There are three basic phases to multitrack recording: tracking, overdubbing and mix-down. We'll explain a sample session in this manual (→p.9) and also give tips on more advanced recording you can do with your CR-4 (→p.13).

In tracking, the basic foundations of the song are recorded.

note Most people find it easiest to record the rhythm parts (for example, drums and percussion, bass and rhythm guitar first, and then add the lead and vocal lines).

When overdubbing, you add other parts on top of the basic parts you recorded earlier.

And when you mix down, you adjust the level of the individual parts and their position in the stereo field (their "pan" position) and make a stereo recording on a separate "master" cassette, MD or CD recorder.

note Note that if you try play back the CR-4 tapes in an ordinary stereo cassette deck (or the other way round), on an ordinary stereo cassette two tracks (left and right of side A) are played back with the tape traveling in one direction and the other two

(left and right of side B) are played back with the tape traveling in the other direction. With the CR-4, all four tracks play in the same direction. Also, the CR-4 does not feature noise reduction.

● ● ● ● ● ● ● ● ● ● ● ● ● ● ● ● About the Ampworks effects

When you play an electric guitar or bass, part of the total sound comes from the instrument itself, and a significant part comes from the amplifier and speakers.

Although you may love the sound of your favorite guitarist, you know that it's going to be difficult to set up a massive stack of tube amplifiers and speakers in your home to sound just like him.

The Ampworks effects in your CR-4 simulate some of the world's most famous and best-loved amplifier/speaker combinations, allowing you to get just the sound you want without the large heavyweight stacks.

In addition, there is a digital effects unit allowing you to add reverb, delay and so on, giving that extra professional touch to your playing. Full tone controls, and gain and volume controls, just like on a full-sized guitar amplifier, give you complete control.

When you use an acoustic guitar, the two microphone models and the "acoustic" setting provide you with added flexibility and control. Full instructions on how to make the most of this feature are provided in this manual (→p.14).

Finding your way around the CR-4

Use this "road map" as a quick guide to find important features of your CR-4.

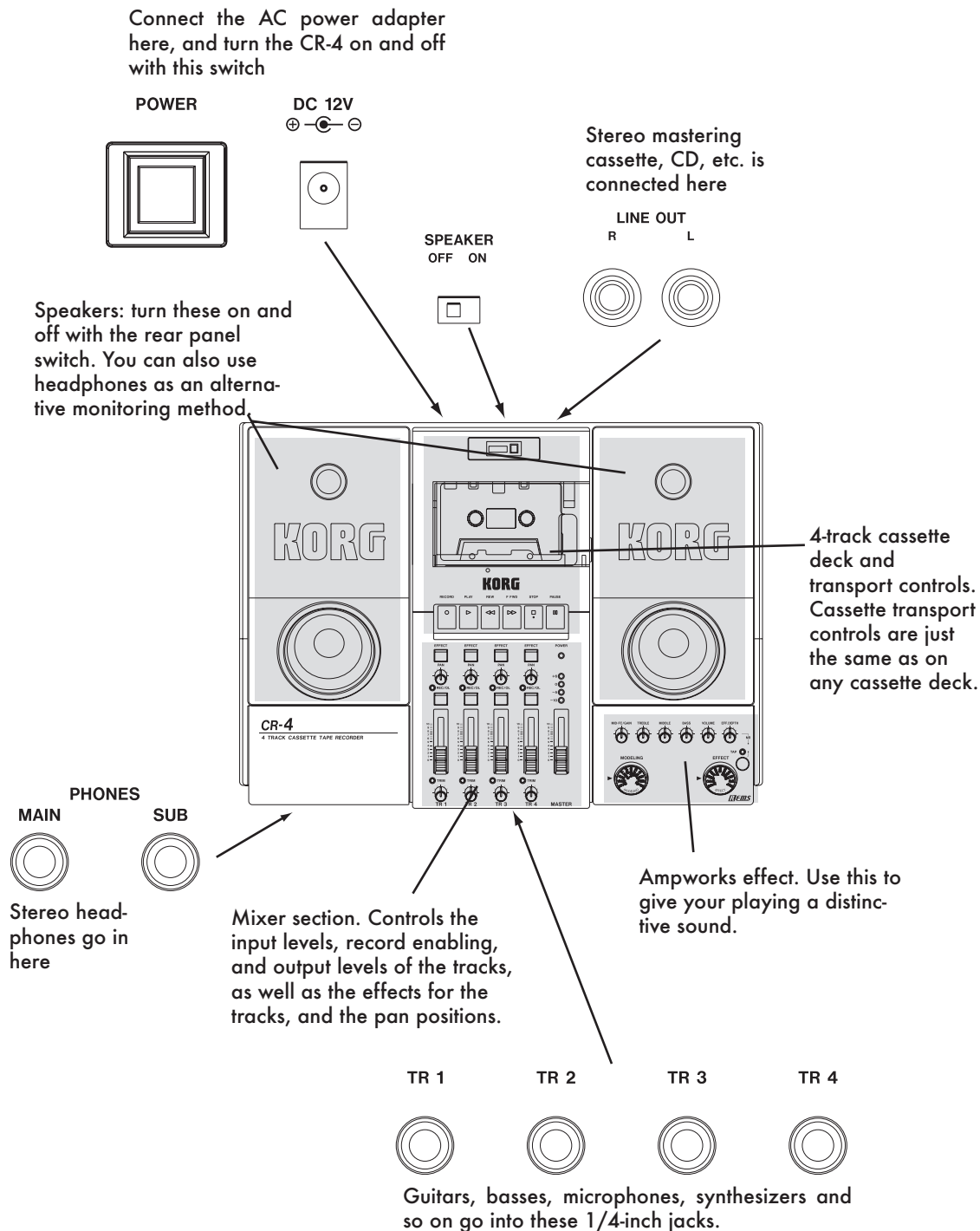

Setting up the CR-4

To use the CR-4, you need to make enough room on a level firm surface for the unit itself, and also leave enough space for connections. There are two kinds of connections to make (as well as the power connection): the audio connections **to** the CR-4 and the connections **from** the unit.

You may want to look at the “road map” (→p.6) before going much further.

Connections to the CR-4

Connections **to** the CR-4 include microphones, guitars, synthesizers and rhythm units, etc.

TR 1 TR 2 TR 3 TR 4



All of these are made through the 1/4" jacks on the front panel.

 We always suggest that you connect and disconnect equipment to and from the CR-4 and turn equipment on and off with the headphone and speaker [MASTER] volume turned down. This protects your ears, as well as the speakers and headphones.

Connections from the CR-4

The connections that you need to make **from** the CR-4 are the headphones and the connections to the master stereo recorder.

Connect headphones to the 1/4" [PHONES] jacks on the front panel. Use the [MAIN] jack if you are only connecting one pair of headphones (the [SUB] output doesn't work on its own).

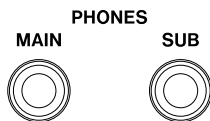

Connect any standard cassette recorder, etc. using the RCA jacks on the rear panel of the CR-4. These should be connected to the [REC IN] or [IN] of the recorder.

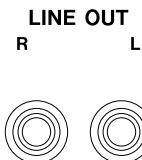

Connecting the power

Making sure that the AC adapter is the correct voltage for your region, connect the plug of the power cord to the power inlet of the CR-4, and the plug of the adapter to an AC outlet.

Switch on any rhythm machines, synthesizers or other input devices connected to the CR-4. Then switch on the CR-4.

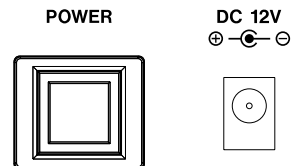

Now you can switch on the recorder, if this is connected.

note We always recommend switching on equipment starting with the source, and finishing with the final destination. Switch off equipment in the reverse order, ending with the source.

Inserting the tape

note It's a good idea to invest in a tape-cleaning kit, and clean the heads of the CR-4 before and after every recording session (we do not suggest that you use dry cassette-type head cleaners—cotton swabs and tape head and rubber cleaning fluid kits are ideal). This will help you maintain a high standard of recording, and will make your work sound much better.

You may also want to consider the use of a tape head demagnetizer. Follow the instructions of the demagnetizer for optimum results.

Remember to use only CrO₂ tape (Type II) tapes.

Setting up the CR-4

You may want to take up any slack in the tape cassette, using a pencil, before you load it into the CR-4.

- 1 Lift the cassette lid (use your fingers—there's no eject button).
- 2 Mark the tape with your project (song) name and the date, and add "CR-4" so that you know in the future that it's a multi-track tape.
- 3 Insert the tape, fully rewind to the start (with the full spool on the left side).

note It's a good idea to always use the same side (side A) of tapes for multitrack recording. That way, you won't be confused in the future.

- 4 Close the cassette lid.
- 5 Press [PLAY] to play the tape for about ten seconds, press [STOP] and press the tape counter reset button.

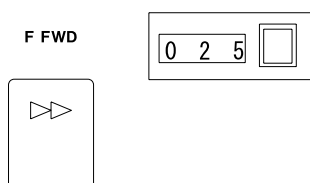

note This prevents you recording on the non-recording leader tape at the start of cassettes.

You are now ready to start recording as explained below (→p.9).

Making your first recording

For this recording, let's assume that you are starting with a bass and drum part on the first two tracks and the drum sounds will come from a rhythm (drum) machine.

The bass guitar will be recorded on track 1, and the drum part on track 2. There's also one guitar part (track 3) and one vocal part (track 4). Of course, your arrangement may be different, but we suggest you read through and follow this example as closely as you can.

note We'll record the bass using the Ampworks effects. We'll record the rhythm machine first with no effects, and then play the bass part, backed by the recorded rhythm machine, using the Ampworks effects.

Recording the rhythm machine

- 1 Connect the mono output of the rhythm machine to the [TR 2] input.

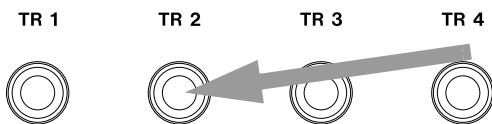

- 2 Adjust the level, etc. of the the rhythm machine and play it. Adjust the CR-4's track 2 [TRIM] control so that the red indicator lights very briefly on only the very loudest parts.

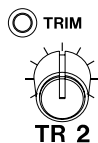

- 3 Move the fader up for track 2 so that it's between [7] and [8] (the *unity gain* position).

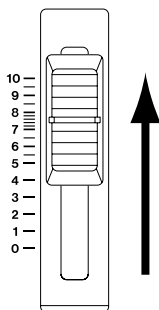

Set the [TRIM] and faders of tracks 1, 3 and 4 to their minimum levels (this prevents any unwanted noise from intruding on your recording).

- 4 Press the [REC/OL] button for track 2, so that the [REC/OL] indicator flashes green. Play the rhythm machine again. If the indicator turns red, the signal is too loud. Pull down the fader a little.

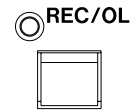

- 5 Adjust the [MASTER] fader for a comfortable monitoring level from the headphones and the speakers.

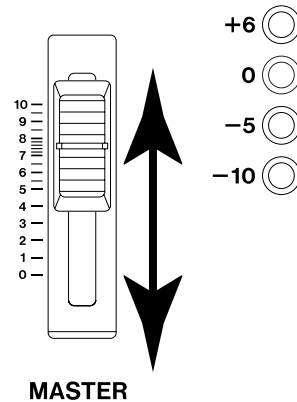

- 6 Be careful not to damage your hearing (or the speakers or headphones).

- 6 Stop the rhythm machine. If you need to "rewind" it to the start of the song, do so.
- 7 Press the [RECORD] button (which also presses the [PLAY] button). The tape starts moving and recording starts on track 2. Start the rhythm machine.

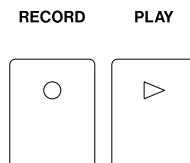

- note** You can also use the [PAUSE] button to prepare for recording without actually having the tape moving (press and hold the [RECORD] button and press the [PAUSE] button).

Making your first recording

- When you reach the end of the rhythm track, stop the rhythm machine, press the [PAUSE] button, and then press the [STOP] button. Rewind the tape to the zero position (where you started the recording). Turn down track 2's [TRIM] control and disconnect the rhythm machine .
- IMPORTANT!** Press the [REC/OL] button for track 2 to make it safe, and prevent you from recording over it.



note When you start recording, you will record on any "armed" track, with its [REC/OL] button pressed, even if nothing is connected to the track inputs! Remember to "disarm" (or "safe") a track when you have finished recording it.

Recording a bass

- Connect your bass to the [TR 1] input.

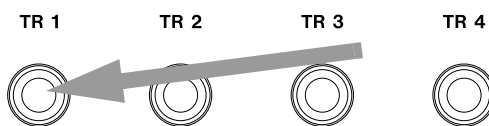

- Play your bass and adjust the [TRIM] control for track 1 so that the [TRIM] indicator only lights briefly on the very loudest notes.

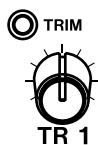

- Now we'll use the effects. Turn on the effect for track 1, using the track's [EFFECT] switch.



Select an amplifier/speaker model using the Ampworks rotary control:

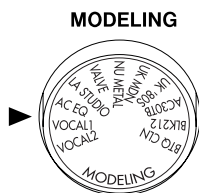

There is no "right" or "wrong" model to choose here; different amplifier models suit different guitars and playing styles. Experiment until you find the basic sound that suits you best.

- You can add an effect such as chorus, to thicken up the sound, using the Ampworks rotary control:

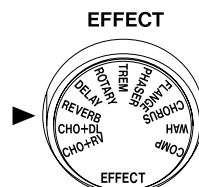

Use the Ampworks controls to adjust the tone of the bass, as well as the gain and amount of effect if you use one.

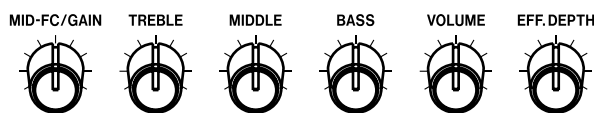

note For full details of how to use the Ampworks effect, see the appropriate section (→p.14).

- Prepare the track for recording ("arm" it) using the [REC/OL] button, and adjust the fader as you did for the rhythm machine (so that the [REC/OL] indicator barely lights on the loudest bass passages).
- Press [PLAY] and play the bass part along with the recorded rhythm part.

PLAY

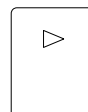

Use the fader of track 2 (the rhythm track) to adjust the relative levels, so that you can hear the bass, while still having the rhythm section loud enough to play in time.

- Record the bass part as you did the rhythm part. Remember to "safe" the track by pressing the [REC/OL] button when you're done.

Recording a guitar

This is almost the same as recording the bass. Use track 3 for the guitar part. Unplug the bass from input 1, and connect the guitar to input 3. Adjust the [TRIM] as you did for the bass (and don't forget to turn down the [TRIM] on track 1).

You will probably want to choose another Ampworks amp/speaker combination and effect for the guitar as well as adjusting the tone controls, etc. (→p.14).

Remember to turn track 3's [EFFECT] switch on and track 1's [EFFECT] switch off (a maximum of one [EFFECT] switch can be on at a time—you can turn off all [EFFECT] switches by pressing the switch that's on lightly to turn it off).

When you have adjusted the guitar recording volume using fader 3, you should use faders 1 and 2 to adjust the playback volume of the previously-recorded bass and rhythm to match the volume of the guitar. Remember that this is only to help you play in time—when you're ready for the final mixdown, you can adjust the volumes as you want.

note Let's take a look at the [PAN] controls.

These allow you to position the tracks between the left and right speakers (or all in the left or right speaker, if you want). When you're recording, especially when you're using headphones, you may find it helpful to play back the previously recorded tracks in one channel, and the track you're recording in the other.

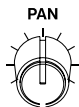

Turn down the track 3 [TRIM] control, and unplug the guitar. Turn the track 3 [EFFECT] switch off, and "safe" the guitar track when you're done, so you don't accidentally record over the top of it.

Recording vocals

For this track (track 4), use a microphone for the vocals. If you use speakers while you record with a microphone, there's a risk of feedback. Turn the speakers off, using the switch on the rear panel, and use headphones for this track.

SPEAKER
OFF ON



When you use the [TRIM] control to adjust the input volume, you will probably have to turn it clockwise in order to get the correct level (microphones have lower levels than other input sources).

There are two built-in microphone modelers (VOCAL1 and VOCAL2) which you can use with your vocal line as well as the acoustic (AC EQ) position, but you can use other models if you want.

You will probably want to add a little reverb or echo to your vocal line to make it sound a bit more spacious.

Make sure the track 4 [EFFECT] switch is on to enable the models and/or effects.

Use the [REVERB] or the [DELAY] setting here and adjust the tone, etc. so that it suits your voice (you may want to make a few test recordings and listen to them to see how you really sound. Remember to turn the [REC/OL button] on while you're recording, and off when you're playing back).

note You don't need to record all the vocals in one take. You can record the first verse and chorus, for example, stop the tape, record the next verse, etc. This works as long as there is a short space between the vocal passages, otherwise the vocals will start to sound a little "patchy".

Once you've recorded the vocals, you're ready to start mixing down to make a stereo recording. Once again, remember to "safe" the vocal track so you don't record over it!

note To prevent any accidental recording on your multitrack cassette, you can punch out the write-protect tab from the recording side (side A).

Making your first recording

Mixdown

For mixdown, it's a good idea to use speakers, rather than headphones, so turn the speakers back on.

Unplug the headphones to achieve the best sound quality from the [LINE OUT].

Mixing levels

When you're mixing down, make sure that the master meter's [+6] indicator is only lighting in the louder passages. If it is continuously lit, you will overload the amplifier of the CR-4 and cause distortion.

If you're recording to a digital recorder (such as a CD or MD recorder), remember that digital distortion is extremely unpleasant—you should adjust the input levels of your recorder or (if it has no recording level controls) the [MASTER] fader.

On the other hand, if you make the recording too quiet, you may hear background noises and tape hiss which you don't want.

You may want to move the [MASTER] fader to about the [4] position, and get a balance before adjusting the master level.

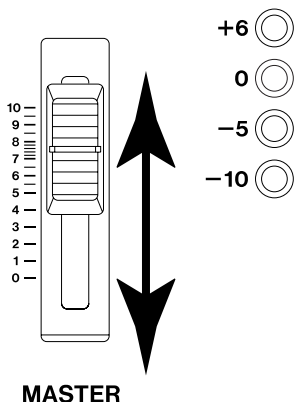

There are no absolute rules for mixing, but you should try to avoid making one part too loud at the expense of all the others.

Mix positions

You can also use the [PAN] controls to position the different tracks in the mix.

Typically, lead vocals reside in the center, equally balanced between the left and right channels.

If you have recorded a stereo source (stereo rhythm machine, synthesizer, etc.) on two tracks, you will probably want to pan these

tracks hard left and hard right to keep the original stereo image produced by the source.

Typically, the aim is to make the listeners feel as though they are "really there", listening to the original performance, but you can often use pan positions for special effects, and an unnatural pan position (or change to the pan position) is an attention-grabber. Remember that people listening on mono equipment (AM radio, etc.) won't hear the benefits of this, though.

Making the mix

When you've adjusted the level, you should:

- 1 Rewind the CR-4 tape to a little before the start of your recording.
- 2 If you're mixing to a tape, rewind the stereo tape to a little before you want to start the mix (you don't need to do this if you're recording to disc). Put your stereo recorder in record ready mode.
- 3 Play back the CR-4 tape, and if your stereo recorder has meters, watch them carefully at the loudest parts to make sure that you are not recording at too high a volume. Adjust the recording level (or if your stereo recorder has no recording level controls, lower the CR-4's [MASTER] fader).
- 4 Rewind the CR-4 tape to a little before the start of your song.
- 5 Play back your CR-4 tape.
- 6 Start recording on your stereo recorder in the quiet passage before the song actually starts.
- 7 At the end of the song, stop your recorder, and then stop the CR-4 tape.
- 8 You can now listen to the mixed tape. It's quite possible that you will not get it perfectly right first time, so be prepared to do it again (and again!) until you get it right.

note When you've finished, we suggest you clean the tape heads of your CR-4 before turning it off and putting it away.

Here are a few more techniques that you can use to help with your recording.

● ● ● ● ● ● ● ● ● ● ● ● ● ● ● ● Multi-track recording

The CR-4 allows you to record four tracks at once. The example we gave above only recorded one track at a time.

If you are recording a group of musicians, you can record more than one track at once, and adjust the balance later.

You can record on a pair of tracks (either 1+2 or 3+4). Press one [REC/OL] button, and then the other [REC/OL] button of the pair to arm. You can also arm and record on all four tracks by using four fingers to press all four [REC/OL] buttons together.

If you are recording on more than one track, remember that only one track at the most can use the Ampworks effects. Don't try to press more than one [EFFECT] switch at the same time.

● ● ● ● ● ● ● ● ● ● ● ● ● ● ● ● Expanding the inputs

You can use a small mixer to mix together several different instruments (for example, a stereo chorus rhythm guitar and a buttonboard with the bass), and use this to feed two tracks. The other two tracks can then be used for lead guitar and vocals.

Typically, you'll create a stereo sub-mix using the small external mixer, and record the left and right outputs of the mixer on two tracks. When you come to mix down, you'll pan these two tracks hard right and hard left.

● ● ● ● ● ● ● ● ● ● ● ● ● ● ● ● Expanding the number of tracks

The CR-4 is restricted to four tracks on a cassette, but you can record more than four tracks in a song if you use a mixdown stereo recorder.

note It's probably best to use a digital (CD or MD) recorder as your stereo recorder, to avoid tape hiss and noise building up.

- 1 Record the first four tracks as described above (→p.9).
- 2 Mix down to the stereo recorder(→p.12) and rewind your CR-4 tape to the start of the recording (or insert a new tape).

- 3 Connect the [LINE OUT] of the stereo recorder to inputs 1 and 2 of the CR-4. You may not want to add any effects to these tracks just yet, so make sure all [EFFECT] switches are off.
- 4 Arm all the CR-4 tracks from 1 through 4 (so that you write over the previously recorded tracks). Move the [TRIM] controls and the faders of tracks 3 and 4 to their lowest level (all the way down).
- 5 Play back the stereo recording, and adjust the [TRIM] controls of tracks 1 and 2.
- 6 Start recording on the CR-4 and play back the mixed stereo recording from the beginning. Disconnect the stereo recorder from the CR-4 inputs, and save all CR-4 tracks.

note If you're using a cassette recorder as your stereo recorder, you can take the mixed cassette from the stereo recorder and put it in the CR-4. The stereo tracks will become tracks 1 and 2 on the CR-4. Remember you cannot use noise reduction on your stereo cassette recorder, and because the track layout of the CR-4 is different to that of an ordinary cassette recorder, you must use only one side of the stereo cassette.

- 7 Now you can use tracks 3 and 4 for new tracks, along with the previous tracks now bounced onto 1 and 2.

note Once you've mixed your first four tracks to stereo, there's no way of separating them again! So if you decide after recording tracks 5 and 6 that the bass is too quiet (or you notice a wrong note!), there's not a lot you can do about it. You may want to use a new cassette for the bounced tracks, and preserve your first four tracks on the original cassette.

● ● ● ● ● ● ● ● ● ● ● ● ● ● ● ● Using the noise reduction

As part of the Ampworks effector, there is a noise-reduction system built in. If you're playing a noisy guitar, or using a microphone in a noisy situation, this allows you to cut out the unwanted sound in quiet passages while letting through the wanted sound when the threshold level is reached.

Adjust the threshold level by pressing and holding the [TAP] button and turning the [EFF. DEPTH] control.

Ampworks effects

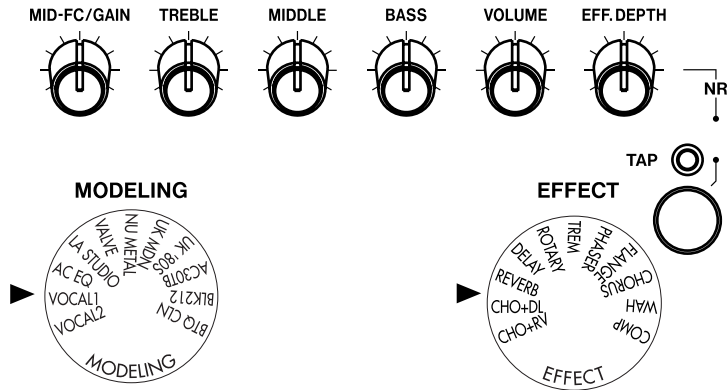

These rotary dials allow you to choose a model to add life to your playing, as well as allowing you to select a digital effect.

There is also another “combination” function: noise reduction (→p.13).

What is REMS (*REMS*)?

REMS (Resonant structure and Electronic circuit Modeling System) is KORG’s proprietary sound modeling technology which precisely reproduces the complex character and nature of both acoustic and electric instruments as well as electronic circuits in real world environments. **REMS** emulates a wide variety of sound generation characteristics including instrument bodies, speakers & cabinets, acoustic fields, microphones, vacuum tubes, transistors, etc.

Modeling type

The models available are:

BTQ CLN	Clean channel of a high-end 100 watt hand-made amp
BLK212	2 x 12 combo amp indispensable for country or blues players
AC30TB	Brilliant channel of a VOX AC30TB
UK '80S	UK-manufactured 100 watt master volume head (from 1983)
UK MDN	UK-manufactured 100 watt modern amp
NU METAL	High-gain amp with metal plate
VALVE	A tube bass amp with the ULTRA LO switch turned ON
LA STUDIO	A bass amp that is typical of the LA sound
AC EQ	3-band EQ for direct line input, and acoustic guitar
VOCAL 1	Widely used Austrian condenser microphone sound
VOCAL 2	Standard dynamic microphone

Controls

[MID-FC/GAIN] With the VOCAL1, VOCAL2, VALVE, LA STUDIO and AC EQ modeling settings, adjusts the mid frequency. With other settings, acts as a gain control. The higher you turn this control, the more distortion you will add to the sound.

[TREBLE] adjusts the amplifier high-frequency range.

[MIDDLE] adjusts the amplifier mid-frequency range.

[BASS] adjusts the amplifier low-frequency range.

[VOLUME] adjusts the amp volume.

[EFF.DEPTH] adjusts the level of the digital effects.

[TAP] sets the speed of some of the digital effects (→p.15).

Effects

In addition, there are eleven digital effects you can apply to your playing and vocals. These are listed here:

COMP	Produces consistent levels and sustain
WAH	Auto wah, applying a wah effect that responds to picking. When the [EFF.DEPTH] control is in the left half, this effect produces a down sweep, and when in the right half, produces an up sweep.
CHORUS	Vintage chorus.
FLANGE	Vintage flanging.
PHASER	Vintage phasing.
TREM	Vintage tremolo.
ROTARY	Simulates a rotary speaker.
DELAY	Delay
REVERB	Simulates a spring reverb
CHO+DL	Vintage chorus and delay
CHO+RV	Vintage chorus and spring reverb.

The TAP control

Use the [TAP] control to match the timing of the digital effects with your music.

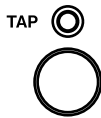

Use it in the following way—press the [TAP] button a number of times. The last two taps determine the timing of the effect. The indicator by the [TAP] button shows the current effect speed.

Use tap timing with the following effects:

CHORUS, PHASER, ROTARY	Sets the modulation speed for these effects, from 80ms to 4 seconds. The tap interval is exactly equal to the modulation speed.
FLANGE	Sets the flanger modulation speed, from 160ms to 8 seconds. The tap interval is equal to half the modulation speed.

TREM	Sets the tremolo modulation speed, from 65ms to 2 seconds. The tap interval is equal to twice the modulation speed.
DELAY, CHO+DL	Sets the delay time, from 80ms to 1 second. The tap interval is exactly equal to the delay time.
REVERB, CHO+RV	Sets the reverb decay time, from about 0.5 seconds to 8 seconds. The tap interval is equal to half the reverb decay time.

Note that you cannot use the [TAP] button with the COMP or WAH effects.

If you want to use an external amp modeler (or record Ampworks effects without modeling), turn the [MODELING TYPE] control to AC EQ. This position turns off Ampworks' amp modeling function and allows you to use three-band EQ, noise reduction and effects as desired.

Further uses for the CR-4

● ● ● ● ● ● ● ● ● ● ● ● ● ● ● ● Using the CR-4 as a guitar combo

To use the CR-4 as a very portable guitar combo, with built-in amp modeling and built-in effects:

- 1 Connect your guitar to track 1. Press the [REC/OL] button and adjust the [TRIM] and fader levels (→p.10).
- 2 Switch track 1's [EFFECT] switch on, and select your amp/speaker model and effects (→p.14).
- 3 Now you can play. Adjust the overall volume with the [MASTER] fader.

● ● ● ● ● ● ● ● ● ● ● ● ● ● ● ● Using the CR-4 as a pre-amplifier

If the CR-4's speakers aren't loud enough for you, use the [LINE OUT] jacks to connect to a suitable stereo input of another system, allowing you to use the amp/speaker modeling and effects through a larger system.

⚠ Be sure that the input of the other system matches the output of the CR-4 (see the specifications). You can damage the CR-4 and the other equipment if they do not match.

Simply press the [REC/OL] button of any tracks that you want to output through the other system. After setting the [TRIM] levels, adjust the pan position [PAN] and level (faders) of each track.

The [MASTER] fader is probably best left at the [7] or [8] position. Adjust the overall level with the other unit's volume control.

note You can use the CR-4 to do solo gigs in this way, if you've recorded your backing on two tracks of a CR-4 cassette. Play back these backing tracks, with a microphone connected to one of the unused tracks, and a guitar connected to the other. You can use a separate guitar processor or stomp box to give one set of effects for the guitar, and use the CR-4's reverb to add some depth and warmth to your vocals.

Cassette recorder

Track format	4 tracks, 4 channels
Head configuration	1 x 4-track record/replay head (Permalloy) 1 x 4-track erase head (ferrite)
Motor type	1 x DC motor (capstan and reel motor)
Tape speed	1 7/8 in./sec (4.76 cm/sec)
Wow and flutter	0.25%
Fast wind time	Approx 120 seconds (C-60 tape)
Tape	Compact Cassette (recommended tape < C-60) High-bias (CrO ₂ Type II, 70µs+3180µs only)

Physical specifications

Power requirements (supplied power adapter):	USA/CANADA/EX: 120VAC 60Hz (KA233)
	UK/EUR: 230VAC, 50Hz (UK:KA236, EUR:KA239)
	AUSTRALIA/NZ: 240VAC 50Hz (Not included.)
Power consumption:	13 W, via the supplied adaptor
Physical dimensions (w x h x d):	434 x 103 x 322 (mm), 17.1 x 4.1 x 12.7 (in.)
Weight (main unit):	4.9 kg (10.8 lb)

Audio specifications and performance

Mic/line inputs (1/4" unbalanced phone jacks)	
Input level	-50dBV or higher
Input impedance	1 MΩ
Speakers	
Speaker type:	Bass reflex, 8 cm (3.1")
Peak output power	2.5W + 2.5W
LINE OUT (2 x RCA jacks)	
Output level	-10dBV
Output impedance	10kΩ

Headphone outputs (1/4" stereo phone jacks)	
Output level	10mW + 10mW
Output impedance	30Ω
Frequency response	50Hz to 12.5kHz ±3 dB
Signal-to-noise ratio	43 dB
Total Harmonic Distortion	Better than 3.0% (at 1 kHz)
Channel separation	Better than 40 dB (at 1 kHz)
Erasure	65 dB (at 1 kHz).

Effects

Amp/cabinet models	11 models
Effects	11 + noise reduction
EQ	Bass, midrange and treble controls

Dimensional drawing

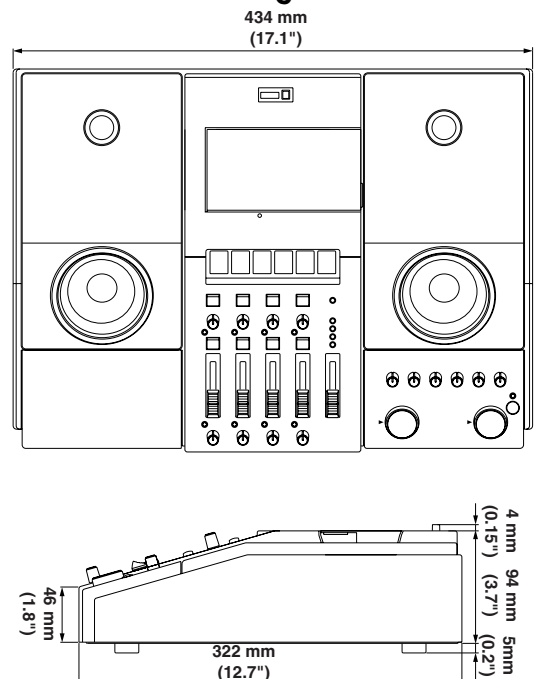

Block Diagram

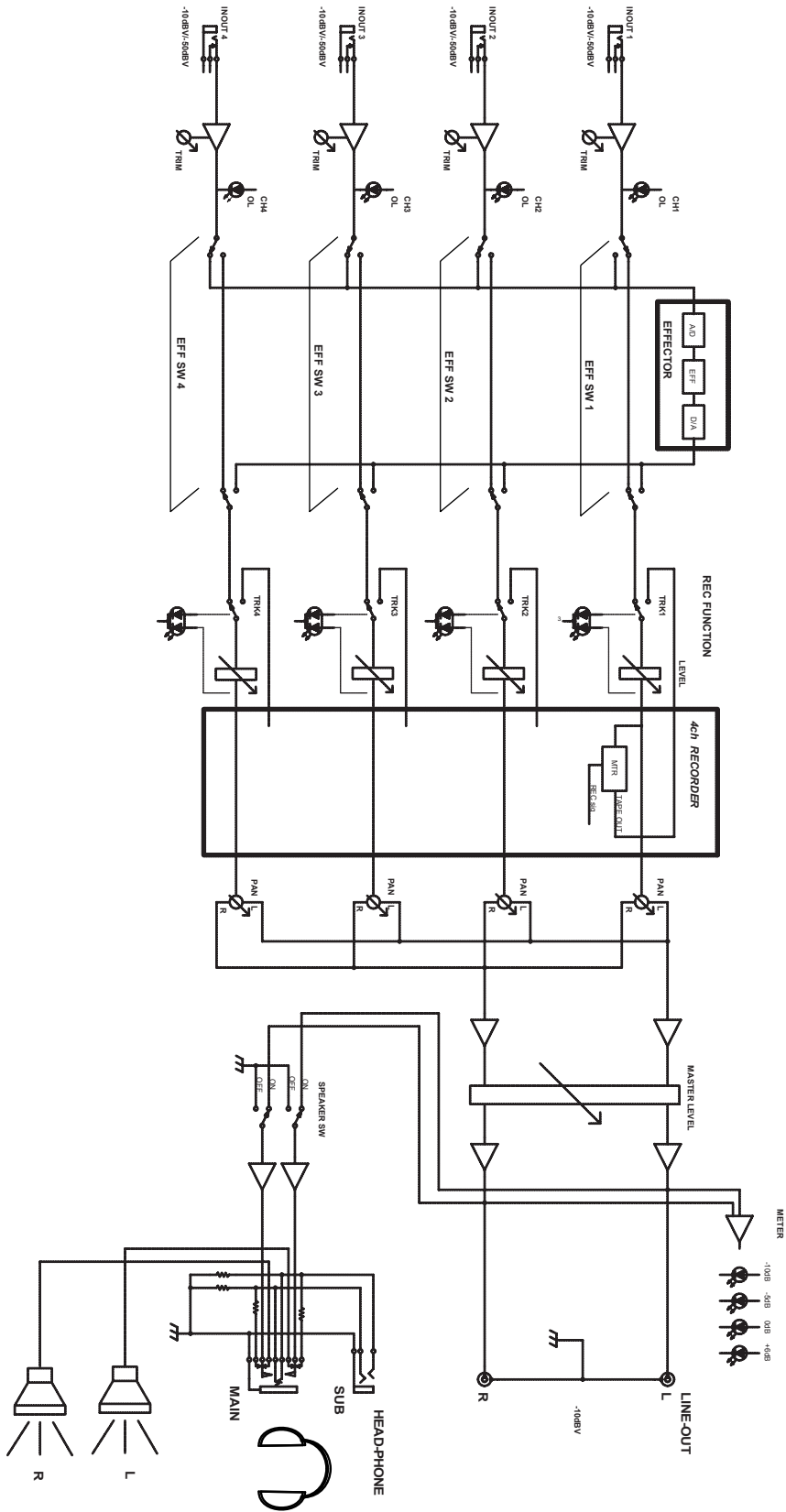

IMPORTANT NOTICE TO CONSUMERS

This product has been manufactured according to strict specifications and voltage requirements that are applicable in the country in which it is intended that this product should be used. If you have purchased this product via the internet, through mail order, and/or via a telephone sale, you must verify that this product is intended to be used in the country in which you reside.

WARNING: Use of this product in any country other than that for which it is intended could be dangerous and could invalidate the manufacturer's or distributor's warranty.

Please also retain your receipt as proof of purchase otherwise your product may be disqualified from the manufacturer's or distributor's warranty.

Free Manuals Download Website

<http://myh66.com>

<http://usermanuals.us>

<http://www.somanuals.com>

<http://www.4manuals.cc>

<http://www.manual-lib.com>

<http://www.404manual.com>

<http://www.luxmanual.com>

<http://aubethermostatmanual.com>

Golf course search by state

<http://golfingnear.com>

Email search by domain

<http://emailbydomain.com>

Auto manuals search

<http://auto.somanuals.com>

TV manuals search

<http://tv.somanuals.com>