

INSTRUCTION MANUAL

DEWALT®

XR LI-ION

DCS355-XE

18V BRUSHLESS CORDLESS MULTI TOOL



Definitions: Safety Guidelines

The definitions below describe the level of severity for each signal word. Please read the manual and pay attention to these symbols.

⚠ DANGER: Indicates an imminently hazardous situation which, if not avoided, **will** result in **death or serious injury**.

⚠ WARNING: Indicates a potentially hazardous situation which, if not avoided, **could** result in **death or serious injury**.

⚠ CAUTION: Indicates a potentially hazardous situation which, if not avoided, **may** result in **minor or moderate injury**.

NOTICE: Indicates a practice **not related to personal injury** which, if not avoided, **may** result in **property damage**.

IF YOU HAVE ANY QUESTIONS OR COMMENTS ABOUT THIS OR ANY DEWALT TOOL, CALL US AT: **1800 338 002** (Aust) or **0800 339 258** (NZ).

Technical Data

		DCS355
Voltage	V	18
Battery Type		Li-Ion
Power input	W	300
Power output	W	170
Oscillating frequency	min ⁻¹	0–20,000
Oscillating angle		1.6°
Weight	kg	1.1
<hr/>		
L _{pa} (sound pressure)	dB(A)	86
K _{pa} (sound pressure uncertainty)	dB(A)	3
L _{wa} (sound power)	dB(A)	97
K _{wa} (sound power uncertainty)	dB(A)	3

Vibration total values (triax vector sum) determined according to EN 60745:

Vibration emission value a _h	m/s ²	
a _h =	m/s ²	16.1
Uncertainty K =	m/s ²	1.5

The vibration emission level given in this information sheet has been measured in accordance with a standardised test given in EN 60745 and may be used to compare one tool with another. It may be used for a preliminary assessment of exposure.

⚠ WARNING: The declared vibration emission level represents the main applications of the tool. However if the tool is used for different applications, with different accessories or poorly maintained, the vibration emission may differ. This may significantly increase the exposure level over the total working period.

An estimation of the level of exposure to vibration should also take into account the times when the tool is switched off or when it is running but not actually doing the job. This may significantly reduce the exposure level over the total working period.

Identify additional safety measures to protect the operator from the effects of vibration such as: maintain the tool and the accessories, keep the hands warm, organisation of work patterns.

SAFETY INSTRUCTIONS FOR POWER TOOLS

When using power tools, always observe the safety regulations applicable in your country to reduce the risk of fire, electric shock and personal injury. Read the following safety instructions before attempting to operate this product. Keep these instructions in a safe place.



WARNING: To reduce the risk of injury, read the instruction manual.

GENERAL POWER TOOL SAFETY WARNINGS



WARNING! Read all safety warnings and all instructions. Failure to follow the warnings and instructions may result in electric shock, fire and/or serious injury.

SAVE ALL WARNINGS AND INSTRUCTIONS FOR FUTURE REFERENCE

The term “power tool” in the warnings refers to your mains-operated (corded) power tool or battery-operated (cordless) power tool.

1) WORK AREA SAFETY

- a) **Keep work area clean and well lit.** Cluttered or dark areas invite accidents.
- b) **Do not operate power tools in explosive atmospheres, such as in the presence of flammable liquids, gases or dust.** Power tools create sparks which may ignite the dust or fumes.
- c) **Keep children and bystanders away while operating a power tool.** Distractions can cause you to lose control.

2) ELECTRICAL SAFETY

- a) **Power tool plugs must match the outlet. Never modify the plug in any way. Do not use any adapter plugs with earthed (grounded) power tools.** Unmodified plugs and matching outlets will reduce risk of electric shock.
- b) **Avoid body contact with earthed or grounded surfaces such as pipes, radiators, ranges and refrigerators.** There is an increased risk of electric shock if your body is earthed or grounded.
- c) **Do not expose power tools to rain or wet conditions.** Water entering a power tool will increase the risk of electric shock.
- d) **Do not abuse the cord. Never use the cord for carrying, pulling or unplugging the power tool. Keep cord away from heat, oil, sharp edges or moving parts.** Damaged or entangled cords increase the risk of electric shock.
- e) **When operating a power tool outdoors, use an extension cord suitable for outdoor use.** Use of a cord suitable for outdoor use reduces the risk of electric shock.
- f) **If operating a power tool in a damp location is unavoidable, use a residual current device (RCD) protected supply.** Use of an RCD reduces the risk of electric shock.

3) PERSONAL SAFETY

- a) **Stay alert, watch what you are doing and use common sense when operating a power tool. Do not use a power tool while you are tired or under the influence of drugs, alcohol or medication.** A moment of inattention while operating power tools may result in serious personal injury.
- b) **Use personal protective equipment. Always wear eye protection.** Protective equipment such as dust mask, non-skid safety shoes, hard hat, or hearing protection used for appropriate conditions will reduce personal injuries.
- c) **Prevent unintentional starting. Ensure the switch is in the off position before connecting to power source and/or battery pack, picking up or carrying the tool.** Carrying power tools with your finger on the switch or energising power tools that have the switch on invites accidents.
- d) **Remove any adjusting key or wrench before turning the power tool on.** A wrench or a key left attached to a rotating part of the power tool may result in personal injury.
- e) **Do not overreach. Keep proper footing and balance at all times.** This enables better control of the power tool in unexpected situations.
- f) **Dress properly. Do not wear loose clothing or jewellery. Keep your hair, clothing and gloves away from moving parts.** Loose clothes, jewellery or long hair can be caught in moving parts.
- g) **If devices are provided for the connection of dust extraction and collection facilities, ensure these are connected and properly used.** Use of dust collection can reduce dust-related hazards.

4) POWER TOOL USE AND CARE

- a) **Do not force the power tool. Use the correct power tool for your application.** The correct power tool will do the job better and safer at the rate for which it was designed.
- b) **Do not use the power tool if the switch does not turn it on and off.** Any power tool that cannot be controlled with the switch is dangerous and must be repaired.
- c) **Disconnect the plug from the power source and/or the battery pack from the power tool before making any adjustments, changing accessories, or storing power tools.** Such preventive safety measures reduce the risk of starting the power tool accidentally.

- d) **Store idle power tools out of the reach of children and do not allow persons unfamiliar with the power tool or these instructions to operate the power tool.** Power tools are dangerous in the hands of untrained users.
- e) **Maintain power tools. Check for misalignment or binding of moving parts, breakage of parts and any other condition that may affect the power tool's operation. If damaged, have the power tool repaired before use.** Many accidents are caused by poorly maintained power tools.
- f) **Keep cutting tools sharp and clean.** Properly maintained cutting tools with sharp cutting edges are less likely to bind and are easier to control.
- g) **Use the power tool, accessories and tool bits, etc. in accordance with these instructions, taking into account the working conditions and the work to be performed.** Use of the power tool for operations different from those intended could result in a hazardous situation.

5) BATTERY TOOL USE AND CARE

- a) **Recharge only with the charger specified by the manufacturer.** A charger that is suitable for one type of battery pack may create a risk of fire when used with another battery pack.
- b) **Use power tools only with specifically designated battery packs.** Use of any other battery packs may create a risk of injury and fire.
- c) **When battery pack is not in use, keep it away from other metal objects like paper clips, coins, keys, nails, screws, or other small metal objects that can make a connection from one terminal to another.** Shorting the battery terminals together may cause burns or a fire.
- d) **Under abusive conditions, liquid may be ejected from the battery; avoid contact. If contact accidentally occurs, flush with water. If liquid contacts eyes, additionally seek medical help.** Liquid ejected from the battery may cause irritation or burns.

6) SERVICE

- a) **Have your power tool serviced by a qualified repair person using only identical replacement parts.** This will ensure that the safety of the power tool is maintained.

Electrical Safety

The electric motor has been designed for one voltage range only. Always check that the power supply corresponds to the voltage on the rating plate. 220–240 V AC means your tool will operate on alternating current. Operation at a voltage outside this range can cause loss of power and can result in overheating. All DeWALT tools are factory tested; if this tool does not operate, check the power supply. Your DeWALT tool is double insulated, therefore no earth wire is required.

- **Young children and the infirm.** This appliance is not intended for use by young children or infirm persons without supervision.
 - This appliance is not intended for use by persons (including children) with reduced physical, sensory or mental capabilities, or lack of experience and knowledge, unless they have been given supervision or instruction concerning use of the appliance by a person responsible for their safety.
 - Children should be supervised to ensure that they do not play with the appliance.
- **Replacement of the supply cord.** If the supply cord or plug is damaged, it must be replaced by the manufacturer or an authorised DeWALT Service Centre in order to avoid a hazard.

Extension Cords

⚠ CAUTION: Use only extension cords that are approved by the country's Electrical Authority. Before using extension cords, inspect them for loose or exposed wires, damaged insulation and defective fittings. Replace the cord if necessary.

Additional Safety Rules for Oscillating Multi-Tool

- **Hold power tool by insulated gripping surfaces, when performing an operation where the cutting accessory may contact hidden wiring or its own cord.** Cutting accessory contacting a "live" wire may make exposed metal parts of the power tool "live" and could give the operator an electric shock.
- **Use clamps or another practical way to secure and support the workpiece to a stable platform.** Holding the work by hand or against your body leaves it unstable and may lead to loss of control.
- **Air vents often cover moving parts and should be avoided.** Loose clothes, jewellery or long hair can be caught in moving parts.

⚠ WARNING: We recommend the use of a residual current device with a residual current rating of 30mA or less.

⚠ WARNING: ALWAYS wear approved protective safety equipment complying with the following standards:

- Eye protection: AS/NZS1337 Eye Protectors for Industrial Applications;
- Hearing protection: AS/NZS1270 Acoustics – Hearing Protection;
- Respiratory protection: AS/NZS1716 Respiratory Protective Devices.

⚠ WARNING: Some dust created by power sanding, sawing, grinding, drilling, and other construction activities contains chemicals known to cause cancer, birth defects or other reproductive harm. Some examples of these chemicals are:

- lead from lead-based paints,
- crystalline silica from bricks and cement and other masonry products, and
- arsenic and chromium from chemically-treated lumber.

Your risk from these exposures varies, depending on how often you do this type of work. To reduce your exposure to these chemicals: work in a well ventilated area, and work with approved safety equipment, such as those dust masks that are specially designed to filter out microscopic particles.

- **Avoid prolonged contact with dust from power sanding, sawing, grinding, drilling, and other construction activities. Wear protective clothing and wash exposed areas with soap and water.** Allowing dust to get into your mouth, eyes, or lay on the skin may promote absorption of harmful chemicals.

⚠ WARNING: Use of this tool can generate and/or disburse dust, which may cause serious and permanent respiratory or other injury. Always use AS/NZS1716 approved respiratory protection appropriate for the dust exposure. Direct particles away from face and body.

⚠ WARNING: Always wear proper personal hearing protection that conforms to AS/NZS1270 during use. Under some conditions and duration of use, noise from this product may contribute to hearing loss.

⚠ CAUTION: When not in use, place tool on its side on a stable surface where it will not cause a tripping or falling hazard. Some tools with large battery packs will stand upright on the battery pack but may be easily knocked over.

- The label on your tool may include the following symbols. The symbols and their definitions are as follows:

V.....volts	A.....amperes
Hz.....hertz	W.....watts

min.....minutes	~ or AC.....alternating current
— or DC.....direct current	⎓ or AC/DC.....alternating or direct current
Ⓜ.....Class I Construction (grounded)	no.....no load speed
Ⓜ.....Class II Construction (double insulated)	n.....rated speed
.../min.....per minute	Ⓧ.....earthing terminal
BPM.....beats per minute	⚠.....safety alert symbol
RPM.....revolutions per minute	IPM.....impacts per minute
sfpm.....surface feet per minute	SPM.....strokes per minute

SAVE ALL WARNINGS AND INSTRUCTIONS FOR FUTURE REFERENCE

Important Safety Instructions for All Battery Packs

When ordering replacement battery packs, be sure to include the catalog number and voltage. Consult the chart at the end of this manual for compatibility of chargers and battery packs.

The battery pack is not fully charged out of the carton. Before using the battery pack and charger, read the safety instructions below and then follow charging procedures outlined.

READ ALL INSTRUCTIONS

- **Do not charge or use the battery pack in explosive atmospheres, such as in the presence of flammable liquids, gases or dust.** Inserting or removing the battery pack from the charger may ignite the dust or fumes.
- **Never force the battery pack into the charger. Do not modify the battery pack in any way to fit into a non-compatible charger as battery pack may rupture causing serious personal injury.** Consult the chart at the end of this manual for compatibility of batteries and chargers.
- Charge the battery packs only in designated DeWALT chargers.
- **DO NOT** splash or immerse in water or other liquids.
- **Do not store or use the tool and battery pack in locations where the temperature may reach or exceed 40 °C (105 °F) (such as outside sheds or metal buildings in summer).** For best life store battery packs in a cool, dry location.

NOTE: Do not store the battery packs in a tool with the trigger switch locked on. Never tape the trigger switch in the ON position.

⚠ WARNING: Fire hazard. Never attempt to open the battery pack for any reason. If the battery pack case is cracked or damaged, do not insert into the charger. Do not crush, drop or damage the battery pack. Do not use a battery pack or charger that has received a sharp blow, been dropped, run over or damaged in any way (e.g., pierced with a nail, hit with a hammer, stepped on). Damaged battery packs should be returned to the service center for recycling.

⚠ WARNING: Fire hazard. Do not store or carry the battery pack so that metal objects can contact exposed battery terminals. For example, do not place the battery pack in aprons, pockets, tool boxes, product kit boxes, drawers, etc., with loose nails, screws, keys, etc. Transporting batteries can possibly cause fires if the battery terminals inadvertently come in contact with conductive materials such as keys, coins, hand tools and the like. The US Department of Transportation Hazardous Material Regulations (HMR) actually prohibit transporting batteries in commerce or on airplanes (e.g., packed in suitcases and carry-on luggage) UNLESS they are properly protected from short circuits. So when transporting individual battery packs, make sure that the battery terminals are protected and well insulated from materials that could contact them and cause a short circuit.

SPECIFIC SAFETY INSTRUCTIONS FOR LITHIUM ION (Li-Ion)

- **Do not incinerate the battery pack even if it is severely damaged or is completely worn out.** The battery pack can explode in a fire. Toxic fumes and materials are created when lithium ion battery packs are burned.
- **If battery contents come into contact with the skin, immediately wash area with mild soap and water.** If battery liquid gets into the eye, rinse water over the open eye for 15 minutes or until irritation ceases. If medical attention is needed, the battery electrolyte is composed of a mixture of liquid organic carbonates and lithium salts.
- **Contents of opened battery cells may cause respiratory irritation.** Provide fresh air. If symptoms persist, seek medical attention.

⚠ WARNING: Burn hazard. Battery liquid may be flammable if exposed to spark or flame.

Important Safety Instructions for All Battery Chargers

SAVE THESE INSTRUCTIONS: This manual contains important safety and operating instructions for battery chargers.

- Before using the charger, read all instructions and cautionary markings on the charger, battery pack and product using the battery pack.

⚠ WARNING: Shock hazard. Do not allow any liquid to get inside the charger. Electric shock may result.

⚠ CAUTION: Burn hazard. To reduce the risk of injury, charge only DEWALT rechargeable battery packs. Other types of batteries may overheat and burst resulting in personal injury and property damage.

NOTICE: Under certain conditions, with the charger plugged into the power supply, the charger can be shorted by foreign material. Foreign materials of a conductive nature, such as, but not limited to, grinding dust, metal chips, steel wool, aluminum foil or any buildup of metallic particles should be kept away from the charger cavities. Always unplug the charger from the power supply when there is no battery pack in the cavity. Unplug the charger before attempting to clean.

- **DO NOT attempt to charge the battery pack with any chargers other than the ones in this manual.** The charger and battery pack are specifically designed to work together.
- **These chargers are not intended for any uses other than charging DEWALT rechargeable batteries.** Any other uses may result in risk of fire, electric shock or electrocution.
- **Do not expose the charger to rain or snow.**
- **Pull by the plug rather than the cord when disconnecting the charger.** This will reduce the risk of damage to the electric plug and cord.
- **Make sure that the cord is located so that it will not be stepped on, tripped over or otherwise subjected to damage or stress.**
- **Do not use an extension cord unless it is absolutely necessary.** Use of improper extension cord could result in risk of fire, electric shock or electrocution.
- **When operating a charger outdoors, always provide a dry location and use an extension cord suitable for outdoor use.** Use of a cord suitable for outdoor use reduces the risk of electric shock.

- **Do not place any object on top of the charger or place the charger on a soft surface that might block the ventilation slots and result in excessive internal heat.** Place the charger in a position away from any heat source. The charger is ventilated through slots in the top and the bottom of the housing.
- **Do not operate the charger with a damaged cord or plug.**
- **Do not operate the charger if it has received a sharp blow, been dropped or otherwise damaged in any way.** Take it to an authorized service center.
- **Do not disassemble the charger; take it to an authorized service center when service or repair is required.** Incorrect reassembly may result in a risk of electric shock, electrocution or fire.
- **Disconnect the charger from the outlet before attempting any cleaning. This will reduce the risk of electric shock.** Removing the battery pack will not reduce this risk.
- **NEVER** attempt to connect 2 chargers together.
- **The charger is designed to operate on standard 230 V household electrical power. Do not attempt to use it on any other voltage.** This does not apply to the vehicular charger.

Chargers

Your tool uses a DEWALT charger. Be sure to read all safety instructions before using your charger. Consult the chart at the end of this manual for compatibility of chargers and battery packs.

Charging Procedure (Fig. 1)

1. Plug the charger into an appropriate outlet before inserting the battery pack.
2. Insert the battery pack (H) into the charger, as shown in Figure 1, making sure the pack is fully seated in charger. The red (charging) light will blink continuously, indicating that the charging process has started.
3. The completion of charge will be indicated by the red light remaining ON continuously. The pack is fully charged and may be used at this time or left in the charger.

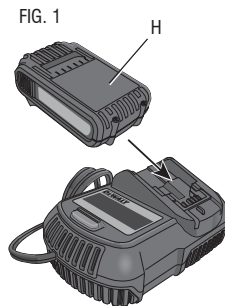

Indicator Light Operation

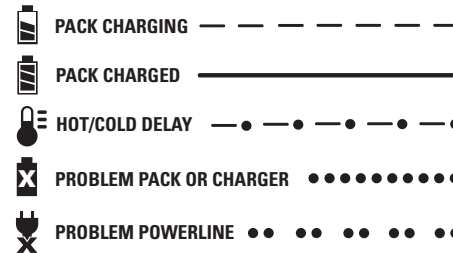

Charge Indicators

This charger is designed to detect certain problems that can arise. Problems are indicated by the red light flashing at a fast rate. If this occurs, re-insert the battery pack into the charger. If the problem persists, try a different battery pack to determine if the charger is working properly. If the new pack charges correctly, then the original pack is defective and should be returned to a service center or other collection site for recycling. If the new battery pack elicits the same trouble indication as the original, have the charger and the battery pack tested at an authorized service center.

HOT/COLD DELAY

This charger has a hot/cold delay feature: when the charger detects a battery that is hot, it automatically starts a delay, suspending charging until the battery has cooled. After the battery has cooled, the charger automatically switches to the pack charging mode. This feature ensures maximum battery life. The red light flashes long, then short while in the hot/cold delay mode.

LEAVING THE BATTERY PACK IN THE CHARGER

The charger and battery pack can be left connected with the charge indicator showing Pack Charged.

WEAK BATTERY PACKS: Weak batteries will continue to function but should not be expected to perform as much work.

FAULTY BATTERY PACKS: This charger will not charge a faulty battery pack. The charger will indicate faulty battery pack by refusing to light or by displaying problem pack or charger.

NOTE: This could also mean a problem with a charger.

PROBLEM POWERLINE

Some chargers have a problem powerline indicator. When the charger is used with some portable power sources such as generators or sources that convert DC to AC, the charger may temporarily suspend operation, flashing the red light with two fast blinks followed by a pause. This indicates the power source is out of limits.

Important Charging Notes

1. Longest life and best performance can be obtained if the battery pack is charged when the air temperature is between 18 °–24 °C (65 °F and 75 °F). DO NOT charge the battery pack in an air temperature below +4 °C (+40 °F), or above +40 °C (+105 °F). This is important and will prevent serious damage to the battery pack.
2. The charger and battery pack may become warm to the touch while charging. This is a normal condition, and does not indicate a problem. To facilitate the cooling of the battery pack after use, avoid placing the charger or battery pack in a warm environment such as in a metal shed or an uninsulated trailer.
3. A cold battery pack will charge at about half the rate of a warm battery pack. The battery pack will charge at that slower rate throughout the entire charging cycle and will not return to maximum charge rate even if the battery pack warms.
4. If the battery pack does not charge properly:
 - a. Check operation of receptacle by plugging in a lamp or other appliance;
 - b. Check to see if receptacle is connected to a light switch which turns power off when you turn out the lights;
 - c. Move the charger and battery pack to a location where the surrounding air temperature is approximately 18 °–24 °C (65 °F and 75 °F);
 - d. If charging problems persist, take the tool, battery pack and charger to your local service center.
5. The battery pack should be recharged when it fails to produce sufficient power on jobs which were easily done previously. DO NOT CONTINUE to use under these conditions. Follow the charging procedure. You may also charge a partially used pack whenever you desire with no adverse effect on the battery pack.

6. Foreign materials of a conductive nature such as, but not limited to, grinding dust, metal chips, steel wool, aluminum foil, or any buildup of metallic particles should be kept away from charger cavities. Always unplug the charger from the power supply when there is no battery pack in the cavity. Unplug the charger before attempting to clean.

7. Do not freeze or immerse the charger in water or any other liquid.

⚠ WARNING: Shock hazard. Don't allow any liquid to get inside the charger. Electric shock may result.

⚠ WARNING: Burn hazard. Do not submerge the battery pack in any liquid or allow any liquid to enter the battery pack. Never attempt to open the battery pack for any reason. If the plastic housing of the battery pack breaks or cracks, return to a service center for recycling.

Storage Recommendations

1. The best storage place is one that is cool and dry, away from direct sunlight and excess heat or cold.
2. For long storage, it is recommended to store a fully charged battery pack in a cool dry place out of the charger for optimal results.

NOTE: Battery packs should not be stored completely depleted of charge. The battery pack will need to be recharged before use.

SAVE ALL WARNINGS AND INSTRUCTIONS FOR FUTURE REFERENCE

COMPONENTS (Fig. 2)

⚠ WARNING: Never modify the power tool or any part of it. Damage or personal injury could result.

- | | |
|---------------------------|--|
| A. Variable speed trigger | F. Cut guide block
(available in selected model only) |
| B. LED worklight | G. Cut guide arm
(available in selected model only) |
| C. Accessory clamp lever | H. Battery pack |
| D. Lock on/off button | I. Battery release button |
| E. Accessory side mount | |

FIG. 2

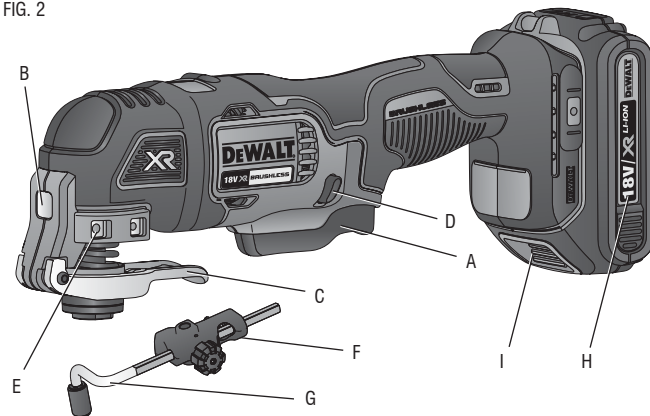

INTENDED USE

This oscillating multi-tool is designed for professional detail sanding, plunge cutting, flush cutting, removal of excess materials and surface preparation applications.

DO NOT use under wet conditions or in presence of flammable liquids or gases.

This oscillating multi-tool is a professional power tool. **DO NOT** let children come into contact with the tool. Supervision is required when inexperienced operators use this tool.

ASSEMBLY AND ADJUSTMENTS

⚠ WARNING: To reduce the risk of serious personal injury, turn the tool off and disconnect the battery pack before making any adjustments or removing/installing attachments or accessories. An accidental start-up can cause injury.

⚠ WARNING: Risk of lacerations or burns. Do not touch the sharp edges of accessories at any time. Do not touch workpiece or blade immediately after operating the tool. They can become very hot. Handle carefully. Always allow accessories and workpiece to cool before handling.

Installing/Removing Accessories (Fig. 3–5)

TOOL-FREE ACCESSORY CLAMP

The DCS355 features a quick change accessory system. This allows for faster accessory changes without the need for wrenches or hex keys like other oscillating tool systems.

1. Grasp the tool and squeeze the accessory clamping lever (C) as shown in Figure 3.
2. Clean any residual debris from the tool shaft and the accessory holder.
3. Slide the accessory between the shaft (J) and the accessory holder making sure the accessory engages all eight pins on the holder and is flush with the shaft.
4. Release the accessory clamp lever.

NOTE: Some accessories, such as scrapers and blades, can be mounted at an angle if required as shown in Figure 5.

FIG. 3

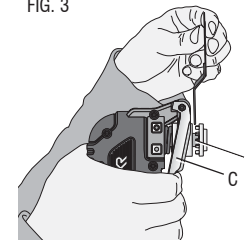

FIG. 4

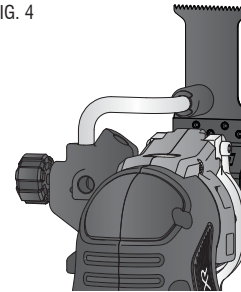
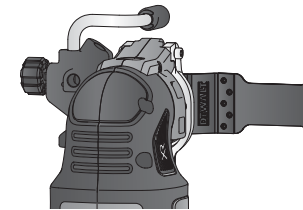

FIG. 5



INSTALLING/REMOVING SANDING SHEETS (FIG. 6)

A diamond shaped platen uses a hook and loop adhesion system to attach the sanding sheets. The platen allows you to use it on large flat surfaces and tight spots or corners.

1. Attach the sanding platen (K) as described under **Installing/Removing Accessories**.
2. Align the edges on the sanding sheet, with the edge of the sanding platen and press the sanding sheet (L) onto the platen.
3. Firmly press the base with the sanding sheet attached against a flat surface and briefly switch the tool on. This provides for good adhesion between the platen and the sanding sheet and also helps to prevent premature wear.
4. When the tip of the sanding sheet becomes worn, detach the sheet from the platen, rotate and reapply.

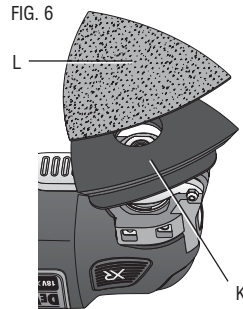

ATTACHING ACCESSORIES USING THE UNIVERSAL ADAPTER (FIG. 7)

Non-DeWALT accessories can be attached using the universal adaptor.

1. Place the washer (M) on the tool.
2. Place accessory on to washer.
3. Tighten and secure adaptor nut (N) using hex wrench.

CAUTION: To avoid injury, do not use any accessory for an application where the adaptor may fail to hold the accessory.

CAUTION: Read and follow all manufacturers' safety warnings for any accessories used with this tool.

CAUTION: To avoid injury, ensure adaptor and accessory are securely tightened.

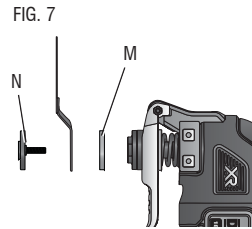

Attaching the Cut/Depth Guide (Fig. 8–12)

(AVAILABLE IN SELECTED MODEL ONLY)

The cut/depth guide allows you to precisely cut material at a specified depth or height and more accurately track a marked cut line.

1. Attach the cut guide block (F) by inserting the tabs (O) on the guide into the accessory side mount (E) on the main body of the tool.
2. Secure the block to the main body with the supplied screw (Q) and washer (S). Tighten with the supplied hex wrench (R).

DEPTH GUIDE

This feature allows you to precisely cut material at a specified depth.

1. Insert the guide arm (G) as shown in Figure 9 into the front slot on the guide block (F).
2. Adjust the length of the guide by pulling out or pushing inward to achieve the desired cut depth as shown in Figure 10.
3. Secure the guide in place by turning the depth/cut adjustment knob (P) clockwise. To release the guide, turn the depth/cut adjustment knob counterclockwise.

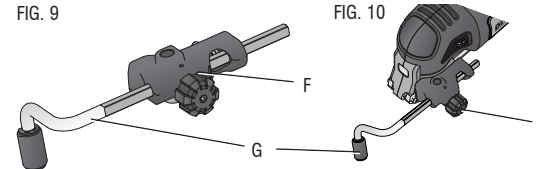
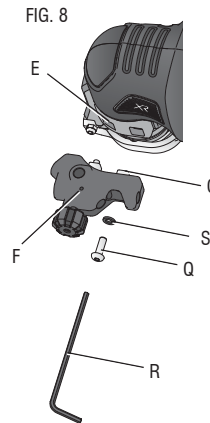

CUT GUIDE

This feature allows you to more accurately track a marked cut line.

1. Insert the guide arm (G) as shown in Figure 11 into the slots on the left and right sides of the guide block (F).

- Adjust the length of the guide by pulling out or pushing inward to achieve the desired length as shown in Figure 12.
- Secure the guide in place by turning the depth/cut adjustment knob (P) clockwise. To release the guide, turn the depth/cut adjustment knob counterclockwise.

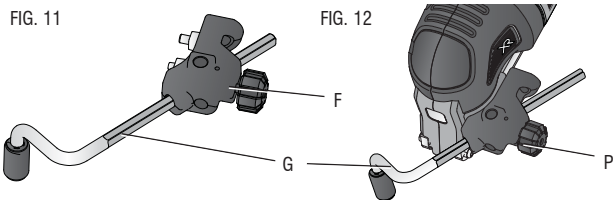

NOTE: The guide arm can also be placed in the guard assembly vertically in order to set the height of a cut. Refer to Figure 13.

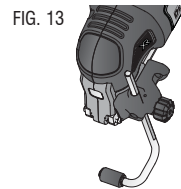

OPERATION

⚠ WARNING: To reduce the risk of serious personal injury, turn the tool off and disconnect the battery pack before making any adjustments or removing/installing attachments or accessories. An accidental start-up can cause injury.

Installing and Removing the Battery Pack (Fig. 14)

NOTE: For best results, make sure your battery pack is fully charged.

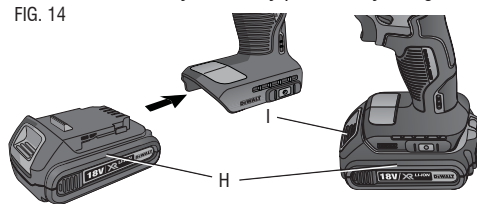

To install the battery pack (H) into the tool handle, align the battery pack with the rails inside the tool's handle and slide it into the handle until the battery pack is firmly seated in the tool and ensure that it does not disengage.

To remove the battery pack from the tool, press the release button (I) and firmly pull the battery pack out of the tool handle. Insert it into the charger as described in the charger section of this manual.

FUEL GAUGE BATTERY PACKS (FIG. 15)

Some DEWALT battery packs include a fuel gauge which consists of three green LED lights that indicate the level of charge remaining in the battery pack.

To actuate the fuel gauge, press and hold the fuel gauge button (T). A combination of the three green LED lights will illuminate designating the level of charge left. When the level of charge in the battery is below the usable limit, the fuel gauge will not illuminate and the battery will need to be recharged.

NOTE: The fuel gauge is only an indication of the charge left on the battery pack. It does not indicate tool functionality and is subject to variation based on product components, temperature and end-user application.

For more information regarding fuel gauge battery packs, please contact Stanley Black & Decker, 82 Taryn Drive, Epping, VIC 3076 Australia or call 1800 338 002 or (NZ) 0800 339 258.

Proper Hand Position (Fig. 16)

⚠ WARNING: To reduce the risk of serious personal injury, **ALWAYS** use proper hand position as shown in Figure 16.

⚠ WARNING: To reduce the risk of serious personal injury, **ALWAYS** hold securely in anticipation of a sudden reaction.

Proper hand position requires the tool to be held as shown in Figure 16.

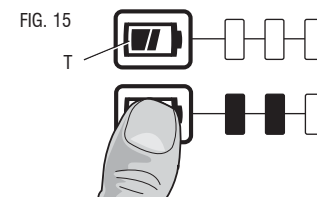
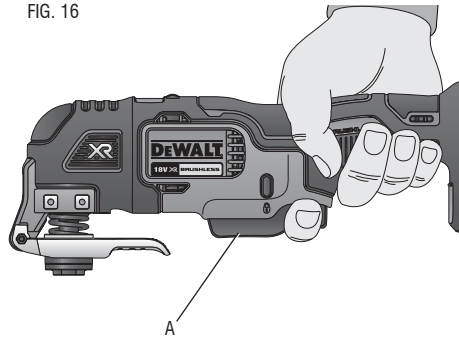

FIG. 16



Variable Speed Trigger (Fig. 16)

⚠ WARNING: Ensure switch is fully OFF before installing the battery pack.

1. Install the battery pack.
2. To turn the tool ON, hold it as shown in Figure 16 and press the variable speed trigger (A).

NOTE: The further the trigger switch is depressed, the faster the tool will operate. If in doubt about the proper speed for your operation, test the performance at low speed and gradually increase until a comfortable speed is found.

3. To turn the tool OFF, release the variable speed switch (A).

Lock On/Off Button (Fig. 17)

Engage the lock on/off button (D), by pushing it to the left or right. When the trigger (A) is not depressed, pushing the button fully to either side until it snaps into place will lock the trigger and disable it from being depressed. Placing the button in the center position allows the trigger to operate normally.

FIG. 17

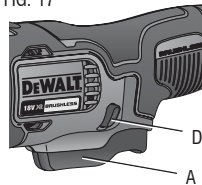

Pushing the button to the left or right with the trigger depressed will lock the trigger in the depressed position. This allows for more comfort and control in extended use applications. Pressing the trigger switch again will release the lock out and the tool will turn off upon release of the trigger.

LED Worklight (Fig. 18)

The LED worklight (B) will activate any time the trigger is depressed and will remain on for 20 seconds after trigger is released.

FIG. 18

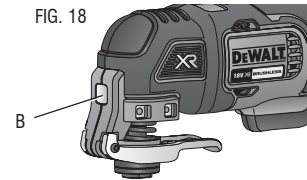

Helpful Hints

- Always ensure the workpiece is firmly held or clamped to prevent movement. Any movement of the material may affect the quality of the cutting or sanding finish.
- Do not start sanding without having the sandpaper attached to sanding platen.
- Use coarse grit paper to sand rough surfaces, medium grit for smooth surfaces and fine grit for the finishing surfaces. If necessary, first make a test run on scrap material.
- Excessive force will reduce the working efficiency and cause motor overload. Replacing the accessory regularly will maintain optimum working efficiency.
- Do not allow the sandpaper to wear away, it will damage the sanding pad.
- If the tool overheats, especially when used at low speed, set the speed to maximum and run it with no load for 2–3 minutes to cool the motor. Avoid prolonged usage at very low speeds. Always keep the blade sharp.

MAINTENANCE

⚠ WARNING: To reduce the risk of serious personal injury, turn the tool off and disconnect the battery pack before making any adjustments or removing/installing attachments or accessories. An accidental start-up can cause injury.

Lubrication

Your power tool requires no additional lubrication.

Cleaning

⚠ WARNING: Blow dirt and dust out of all air vents with clean, dry air at least once a week. To minimize the risk of eye injury, always wear AS/NZS1337 approved eye protection when performing this.

⚠ WARNING: Never use solvents or other harsh chemicals for cleaning the non-metallic parts of the tool. These chemicals may weaken the plastic materials used in these parts. Use a cloth dampened only with water and mild soap. Never let any liquid get inside the tool; never immerse any part of the tool into a liquid.

CHARGER CLEANING INSTRUCTIONS

⚠ WARNING: Shock hazard. Disconnect the charger from the AC outlet before cleaning. Dirt and grease may be removed from the exterior of the charger using a cloth or soft non-metallic brush. Do not use water or any cleaning solutions.

Repairs

This charger and battery pack are not serviceable. Servicing at an authorized service centre is required to avoid damage to static sensitive internal components.

To assure product SAFETY and RELIABILITY, repairs, maintenance and adjustment (including brush inspection and replacement) should be performed by certified service centers or other qualified service organizations, always using identical replacement parts.

Accessories

⚠ WARNING: Since accessories, other than those offered by DEWALT, have not been tested with this product, use of such accessories with this tool could be hazardous. To reduce the risk of injury, only DEWALT recommended accessories should be used with this product.

Recommended accessories for use with your tool are available at extra cost from your local service center. If you need any assistance in locating any accessory, please contact Stanley Black & Decker, 82 Taryn Drive, Epping, VIC 3076 Australia or call 1800 338 002 or (NZ) 0800 339 258.



DeWALT BATTERY AND CHARGER SYSTEMS																														
Battery		Output Nominal	Chargers/Charge Time																											
			230 Volts																	12 Volts										
Cat. Number	Voltage	Amp Hour	97014	98014	DW9106	DW9107	DW9108	DW9115	DW9116	DW9117	DW9118	DE9116	DE9118	DW9111	DC0111	DW0245	DE0246	DC9000	DC9310	DC8095	DCB100	DCB103	DCB105	DCB106	DCB107	DCR017	DCB119	DW9109	DC9319	
DC9360	36	2.2	X	X	X	X	X	X	X	X	X	X	X	X	X	X	X	60	X	X	X	X	X	X	X	X	X	X	X	
DE0240-XJ	24	2.0	X	X	X	X	X	X	X	X	X	X	X	X	X	60	60	X	X	X	X	X	X	X	X	X	X	X	X	
DW0242	24	2.0	X	X	X	X	X	X	X	X	X	X	X	X	X	60	60	X	X	X	X	X	X	X	X	X	X	X	X	
DW0240	24	1.7	X	X	X	X	X	X	X	X	X	X	X	X	X	60	60	X	X	X	X	X	X	X	X	X	X	X	X	
DC9096	18	2.4	X	X	X	X	60	X	60	20	X	60	X	60	X	X	X	X	60	X	X	X	X	X	X	X	X	X	60	
DC9180	18	2.0	X	X	X	X	X	X	X	X	X	X	X	X	X	X	X	X	60	X	X	X	X	X	X	X	X	X	60	
DCB180	18	3.0	X	X	X	X	X	X	X	X	X	X	X	X	X	X	X	X	X	X	X	X	55	140	140	90	90	X	X	
DCB181	18	1.5	X	X	X	X	X	X	X	X	X	X	X	X	X	X	X	X	X	X	X	30	30	70	70	45	40	X	X	
DCB182	18	4.0	X	X	X	X	X	X	X	X	X	X	X	X	X	X	X	X	X	X	X	70	70	180	180	120	117	X	X	
DCB183	18	2.0	X	X	X	X	X	X	X	X	X	X	X	X	X	X	X	X	X	X	X	X	40	40	90	90	60	60	X	X
DCB185	18	1.3	X	X	X	X	X	X	X	X	X	X	X	X	X	X	X	X	X	X	X	25	25	60	60	40	35	X	X	
DW9096	18	2.4	X	X	X	X	60	X	60	20	X	60	X	60	X	60	X	X	60	X	X	60	X	X	X	X	X	60	60	
DE9095-XJ	18	2.0	X	X	X	X	60	X	60	20	X	60	X	60	X	60	X	X	60	X	X	60	X	X	X	X	X	60	60	
DC9091	14.4	2.4	60	60	60	60	15	60	15	60	60	60	60	60	60	X	X	X	60	X	X	60	X	X	X	X	X	60	60	
DC9144	14.4	2.0	X	X	X	X	X	X	X	X	X	X	X	X	X	X	X	X	60	X	X	60	X	X	X	X	X	X	60	
DCB140	14.4	3.0	X	X	X	X	X	X	X	X	X	X	X	X	X	X	X	X	X	X	X	55	55	140	140	90	90	X	X	
DCB141	14.4	1.5	X	X	X	X	X	X	X	X	X	X	X	X	X	X	X	X	X	X	X	30	30	70	70	45	40	X	X	
DCB142	14.4	4.0	X	X	X	X	X	X	X	X	X	X	X	X	X	X	X	X	X	X	X	90	90	180	180	120	117	X	X	
DCB143	14.4	2.0	X	X	X	X	X	X	X	X	X	X	X	X	X	X	X	X	X	X	X	40	40	90	90	60	60	X	X	
DCB145	14.4	1.3	X	X	X	X	X	X	X	X	X	X	X	X	X	X	X	X	X	X	X	25	25	X	60	40	35	X	X	
DE9094	14.4	1.3	45	45	45	30	30	15	30	12	60	30	60	30	30	X	X	X	30	X	X	30	X	X	X	X	X	30	30	
DE9091-XJ	14.4	2.0	45	45	45	45	45	15	45	15	45	15	90	45	90	45	45	X	X	X	45	X	X	45	X	X	X	X	45	45
DW9091	14.4	1.7	45	45	45	45	45	15	45	15	90	45	90	45	45	X	X	X	45	X	X	45	X	X	X	X	X	X	45	45
DC9071	12	2.4	60	60	60	60	45	45	15	45	15	60	60	60	60	X	X	X	60	X	X	60	X	X	X	X	X	60	60	
DE9071-XJ	12	2.0	60	60	60	45	45	15	45	15	90	45	90	45	45	X	X	X	45	X	X	45	X	X	X	X	X	45	45	
DE9074-XJ	12	1.25	45	45	45	30	30	15	30	12	60	30	60	30	30	X	X	X	30	X	X	30	X	X	X	X	X	30	30	
DW9050	12	1.3	40	40	40	X	X	15	X	X	X	X	X	X	X	X	X	X	X	X	X	X	X	X	X	X	X	X	X	
DW9071	12	1.7	60	60	60	45	45	15	45	15	90	45	90	45	45	X	X	X	45	X	X	45	X	X	X	X	X	45	45	
DW9072	12	1.2	45	45	45	30	30	15	30	12	60	30	60	30	30	X	X	X	30	X	X	30	X	X	X	X	X	30	30	
DCB120	10.8	1.3	X	X	X	X	X	X	X	X	X	X	X	X	X	X	X	X	X	X	X	40	40	40	X	60	40	40	X	X
DCB123	10.8	1.5	X	X	X	X	X	X	X	X	X	X	X	X	X	X	X	X	X	X	X	40	40	40	X	70	45	40	X	X
DW9063	9.6	1.25	45	45	45	30	30	15	30	12	60	30	60	30	30	X	X	X	30	X	X	30	X	X	X	X	X	30	30	
DW9062	9.6	1.3	45	45	45	30	30	15	30	12	60	30	60	30	30	X	X	X	30	X	X	30	X	X	X	X	X	30	30	
DW9061	9.6	1.7	60	60	60	45	45	15	45	15	90	45	90	45	45	X	X	X	45	X	X	45	X	X	X	X	X	45	45	
DW9048	9.6	1.3	40	40	40	X	X	15	X	X	X	X	X	X	X	X	X	X	X	X	X	X	X	X	X	X	X	X	X	X
DCB080	7.2	1.0	X	X	X	X	X	X	X	X	X	X	X	X	X	X	X	X	X	X	60	X	X	X	X	X	X	X	X	
DW9057	7.2	1.25	45	45	45	30	30	15	30	12	60	30	60	30	30	X	X	X	30	X	X	30	X	X	X	X	X	30	30	
DW9046	7.2	1.3	40	40	40	X	X	15	X	X	X	X	X	X	X	X	X	X	X	X	X	X	X	X	X	X	X	X	X	X

X Indicates that the battery pack is not compatible with that specific charger.

All charge times are approximate. Actual charge time may vary.

Read the instruction manual for more specific information.

The battery voltage is nominal, it can measure above or below depending on the state of charge.

Stanley Black & Decker

82 Taryn Drive, Epping, VIC 3076 Australia • 1800 338 002 (Aust) or 0800 339 258 (NZ)

www.dewalt.com.au • www.dewalt.co.nz

(OCT13) Part No. N346799 DCS355-XE Copyright © 2013 DeWALT

The following are trademarks for one or more DeWALT power tools: the yellow and black color scheme; the "D" shaped air intake grill; the array of pyramids on the handgrip; the kit box configuration; and the array of lozenge-shaped humps on the surface of the tool.

Free Manuals Download Website

<http://myh66.com>

<http://usermanuals.us>

<http://www.somanuals.com>

<http://www.4manuals.cc>

<http://www.manual-lib.com>

<http://www.404manual.com>

<http://www.luxmanual.com>

<http://aubethermostatmanual.com>

Golf course search by state

<http://golfingnear.com>

Email search by domain

<http://emailbydomain.com>

Auto manuals search

<http://auto.somanuals.com>

TV manuals search

<http://tv.somanuals.com>