

**Vostro™ | A840/A860**  
**Setup and**  
**Quick Reference Guide**



# Notes, Notices, and Cautions



NOTE: A NOTE indicates important information that helps you make better use of your computer.



NOTICE: A NOTICE indicates either potential damage to hardware or loss of data and tells you how to avoid the problem.



CAUTION: A CAUTION indicates a potential for property damage, personal injury, or death.

## Macrovision Product Notice

This product incorporates copyright protection technology that is protected by method claims of certain U.S. patents and other intellectual property rights owned by Macrovision Corporation and other rights owners. Use of this copyright protection technology must be authorized by Macrovision Corporation, and is intended for home and other limited viewing uses only unless otherwise authorized by Macrovision Corporation. Reverse engineering or disassembly is prohibited.

---

Information in this document is subject to change without notice.

© 2008 Dell Inc. All rights reserved.

Reproduction of these materials in any manner whatsoever without the written permission of Dell Inc. is strictly forbidden.

Trademarks used in this text: *Dell*, the *DELL* logo, *Vostro*, *Wi-Fi Catcher*, *DellConnect*, are trademarks of Dell Inc.; *Bluetooth* is a registered trademark owned by Bluetooth SIG, Inc., and is used by Dell under license; *Intel*, *Pentium*, *Core*, and *Celeron* are registered trademarks of Intel Corporation in the U.S. and other countries; *Microsoft*, *Windows*, *Windows Vista*, and the *Windows Vista* start button logo are either trademarks or registered trademarks of Microsoft Corporation in the United States and/or other countries.

Other trademarks and trade names may be used in this document to refer to either the entities claiming the marks and names or their products. Dell Inc. disclaims any proprietary interest in trademarks and trade names other than its own.

PP37L, PP38L

August 2008

P/N G514H

Rev. A02

# Contents

<b>About Your Computer</b> . . . . .	<b>7</b>	Transferring Information to a New Computer . . . . .	19
Front View . . . . .	7	<b>Specifications</b> . . . . .	<b>21</b>
Right View . . . . .	8	<b>Troubleshooting</b> . . . . .	<b>33</b>
Left View . . . . .	10	Error Messages . . . . .	33
Battery Removal . . . . .	12	System Messages . . . . .	40
<b>Quick Setup</b> . . . . .	<b>15</b>	Troubleshooting Software and Hardware Problems . . . . .	41
Connecting to the Internet . . . . .	17	Dell Diagnostics . . . . .	42
Setting Up Your Internet Connection . . . . .	17	Troubleshooting Tips . . . . .	44
		Power Problems . . . . .	44
		Memory Problems . . . . .	46

## Contents

Lockups and Software Problems . . . . .	47	<b>Finding Information . . . . .</b>	<b>59</b>
Dell Technical Update Service . . . . .	49	<b>Getting Help . . . . .</b>	<b>63</b>
Dell Support Center . . . . .	49	Obtaining Assistance. . . . .	63
<b>Reinstalling Software . . . . .</b>	<b>51</b>	Technical Support and Customer Service . . . . .	64
Drivers . . . . .	51	Online Services . . . . .	64
Identifying Drivers . . . . .	51	AutoTech Service . . . . .	65
Reinstalling Drivers and Utilities . . . . .	51	Automated Order-Status Service . . . . .	66
Restoring Your Operating System . . . . .	54	Problems With Your Order. . . . .	66
Using Microsoft® Windows® System Restore . . . . .	54	Product Information . . . . .	66
Using the Operating System Media . . . . .	55	Returning Items for Warranty Repair or Credit . . . . .	66

Before You Call . . . . .	67
Contacting Dell . . . . .	69
<b>Index . . . . .</b>	<b>71</b>



# About Your Computer

## Front View

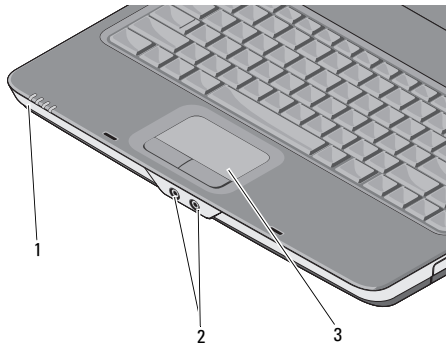

- 1 device status lights    2 audio connectors  
3 touch pad

## DEVICE STATUS LIGHTS

The lights located on the palm rest towards the front of the computer indicate the following:



**Power light** – Turns on when you turn on the computer, and blinks when the computer is in a power management mode.



**Hard drive activity light** – Turns on when the computer reads or writes data.



**NOTICE:** To avoid loss of data, never turn off the computer while the  light is flashing.



**Battery status light** – Turns on steadily or blinks to indicate battery charge status.



**Wi-Fi status light** – Turns on when wireless networking is enabled.

---

### AUDIO CONNECTORS

---

Attach headphones to the  connector

---

Attach a microphone to the  connector

---

**TOUCH PAD** — Provides the functionality of a mouse.

### Right View

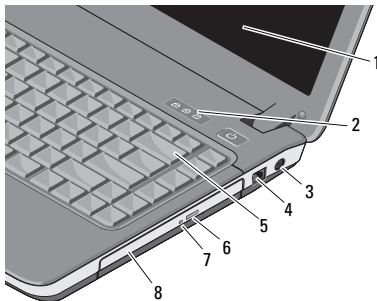

- |   |                      |   |                            |
|---|----------------------|---|----------------------------|
| 1 | display              | 2 | keyboard status lights     |
| 3 | AC adapter connector | 4 | modem connector            |
| 5 | keyboard             | 6 | optical drive eject button |
| 7 | optical drive light  | 8 | optical drive              |



**DISPLAY** — For more information on the display, see *Dell Technology Guide*.

### KEYBOARD STATUS LIGHTS —

The lights located above the keyboard indicate the following:



Turns on when the numeric keypad is enabled.



Turns on when the uppercase letter (caps lock) function is enabled.



Turns on when the scroll lock function is enabled.

---

**AC ADAPTER CONNECTOR** — Attaches an AC adapter to the computer. The AC adapter converts AC power to the DC power required by the computer. You can connect the AC adapter with your computer turned on or off.



**CAUTION:** The AC adapter works with electrical outlets worldwide. However, power connectors and power strips vary among countries. Using an incompatible cable or improperly connecting the cable to the power strip or electrical outlet may cause fire or equipment damage.



**NOTE:** Plug the power cord and the adapter firmly in, and ensure that the light is on.

### MODEM CONNECTOR (RJ-11)



Connects the telephone line to the modem connector.

For information on using the modem, see the online modem documentation supplied with your computer.

---

**KEYBOARD** — For more information on the keyboard, see *Dell Technology Guide*.

**OPTICAL DRIVE** — For more information about the optical drive, see *Dell Technology Guide*.

## Left View

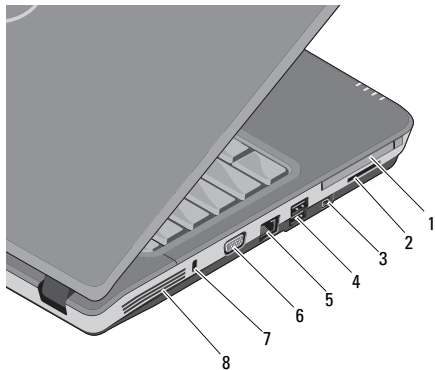

- |   |                      |   |                         |
|---|----------------------|---|-------------------------|
| 1 | PC card slot         | 2 | 3-in-1 card reader slot |
| 3 | IEEE 1394a connector | 4 | USB connectors (2)      |
| 5 | network connector    | 6 | VGA connector           |
| 7 | security cable slot  | 8 | air vents               |

**PC CARD SLOT** — Supports one PC Card, such as a modem or network adapter. The computer ships with a blank installed in the slot to prevent foreign matter from entering the computer interior when a card is not installed.

**3-IN-1 MEDIA CARD READER** — Provides a fast and convenient way to view and share digital photos, music, videos, and documents stored on the following digital memory cards:

- Secure digital (SD) memory card
- Secure Digital High Capacity (SDHC) card
- Multimedia card (MMC)

**IEEE 1394A CONNECTOR** — Connects devices supporting IEEE 1394a high-speed transfer rates, such as some digital video cameras.

## USB CONNECTORS

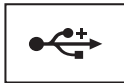

Connect USB devices, such as a mouse, keyboard, or printer, and so on.

## NETWORK CONNECTOR (RJ-45)

---

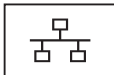

Connects the computer to a network. The two lights next to the connector indicate status and activity for wired network connections.

For information on using the network adapter, see the device user's guide supplied with your computer.

---

## VGA CONNECTOR

---



Connects video devices, such as a monitor.

---

**SECURITY CABLE SLOT** — Lets you attach a commercially available antitheft device to the computer.

**AIR VENTS** — The computer uses an internal fan to create airflow through the vents, which prevents the computer from overheating. The fan automatically turns on when the computer gets hot.



**CAUTION:** Do not block, push objects into, or allow dust to accumulate in the air vents. Do not store your Dell™ computer in a low-airflow environment, such as a closed briefcase, while it is running. Restricting the airflow can damage the computer or cause a fire. The computer turns on the fan when the computer gets hot. Fan noise is normal and does not indicate a problem with the fan or the computer.

## Battery Removal



**CAUTION:** Before working inside your computer, read the safety information that shipped with your computer. For additional safety best practices information, see the Regulatory Compliance Homepage at [www.dell.com/regulatory\\_compliance](http://www.dell.com/regulatory_compliance).



**CAUTION:** Using an incompatible battery may increase the risk of fire or explosion. Replace the battery only with a compatible battery purchased from Dell. The battery is

designed to work with your Dell™ computer. Do not use a battery from other computers with your computer.



**CAUTION:** Before removing or replacing the battery, turn off the computer, disconnect the AC adapter from the electrical outlet and the computer, disconnect the modem from the wall connector and computer, and remove any other external cables from the computer.

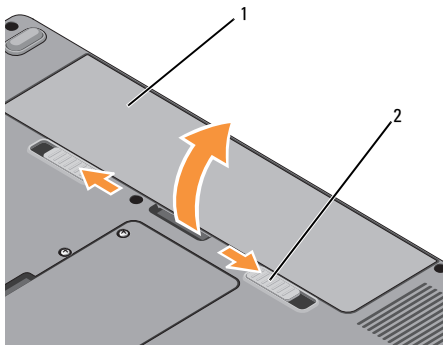

1 battery      2 battery release latches (2)

To remove the battery:

- 1 Ensure that the computer is turned off.
- 2 Slide the two release latches on the bottom of the computer, and then remove the battery from the bay.

To replace the battery, slide the battery into the bay until it clicks into place.



## Quick Setup



**CAUTION:** Before working inside your computer, read the safety information that shipped with your computer. For additional safety best practices information, see the Regulatory Compliance Homepage at [www.dell.com/regulatory\\_compliance](http://www.dell.com/regulatory_compliance).



**CAUTION:** The AC adapter works with electrical outlets worldwide. However, power connectors and power strips vary among countries. Using an incompatible cable or improperly connecting the cable to the power strip or electrical outlet may cause fire or equipment damage.



**NOTICE:** When you disconnect the AC adapter cable from the computer, grasp the connector, not the cable itself, and pull firmly but gently to avoid damaging the cable. When you wrap the AC adapter cable, ensure that you follow the angle of the connector on the AC adapter to avoid damaging the cable.



**NOTE:** Some devices may not be included if you did not order them.

## Quick Setup

- 1 Connect the AC adapter to the AC adapter connector on the computer and to the electrical outlet.

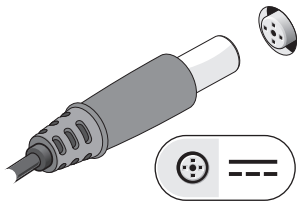

- 3 Connect USB devices, such as a mouse or keyboard.

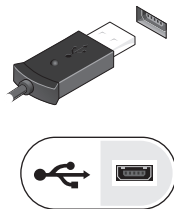

- 2 Connect the network cable.

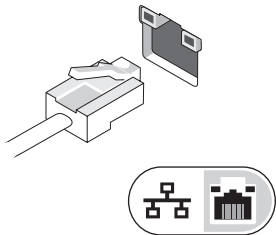



- 4 Open the computer display and press the power button to turn on the computer.



 **NOTE:** It is recommended that you turn on and shut down your computer at least once before you install any cards or connect the computer to a docking device or other external device, such as a printer.

- 5 Connect to the Internet. See "Connecting to the Internet" on page 17 for more information.

## Connecting to the Internet

 **NOTE:** Internet Service Provider(s) (ISP) and ISP offerings vary by country.

To connect to the Internet, you need a modem or network connection and an ISP. If you are using a dial-up connection, connect a telephone line to the modem connector on your computer and to the telephone wall connector before you set up your Internet connection. If you are using a DSL or cable/satellite modem connection, contact your ISP or cellular phone service for setup instructions.

## Setting Up Your Internet Connection

 **NOTE:** The instructions in this section are for computers with Windows Vista® operating system only.

## Quick Setup

To set up an Internet connection with a desktop shortcut provided by your ISP:

- 1 Save and close any open files, and exit any open programs.
- 2 Double-click the ISP icon on the Microsoft® Windows® desktop.
- 3 Follow the instructions on the screen to complete the setup.

If you do not have an ISP icon on your desktop or if you want to set up an Internet connection with a different ISP, perform the steps in the section below.



**NOTE:** If you cannot connect to the Internet, see the *Dell Technology Guide*. If you have successfully connected in the past, the ISP might have a service outage. Contact your ISP to check the service status, or try connecting again later.



**NOTE:** Have your ISP information ready. If you do not have an ISP, consult the Connect to the Internet wizard.

## Microsoft® Windows Vista® Operating System

- 1 Save and close any open files, and exit any open programs.
- 2 Click the Windows Vista Start button  → **Control Panel**
- 3 Under **Network and Internet**, click **Connect to the Internet**.
- 4 In the **Connect to the Internet** window, click either **Broadband (PPPoE)** or **Dial-up**, depending on how you want to connect:
  - Choose **Broadband** if you will use a DSL, satellite modem, cable TV modem, or Bluetooth wireless technology connection.
  - Choose **Dial-up** if you will use a dial-up modem or ISDN.



**NOTE:** If you do not know which type of connection to select, click **Help me choose** or contact your ISP.

- 5 Follow the instructions on the screen and use the setup information provided by your ISP to complete the setup.

## Transferring Information to a New Computer



**NOTE:** The instructions in this section are for computers with Windows Vista operating system installed.

- 1 Click the Windows Vista Start button , and then click **Transfer files and settings** → **Start Windows Easy Transfer**.
- 2 In the **User Account Control** dialog box, click **Continue**.
- 3 Click **Start a new transfer** or **Continue a transfer in progress**.
- 4 Follow the instructions provided on the screen by the Windows Easy Transfer wizard.



## Specifications



**NOTE:** Offerings may vary by region. For more information regarding the configuration of your computer, click **Start**→**Help and Support** and select the option to view information about your computer.

<b>Processor</b>	<b>Vostro A840</b>	<b>Vostro A860</b>
Processor type	Intel® Core™2 Duo Intel® Pentium™ Dual-Core Intel® Celeron® Dual and Single Core	Intel® Core™2 Duo Intel® Pentium™ Dual-Core Intel® Celeron® Dual and Single Core
L1 cache	32 KB per instruction, 32 KB data cache per core	32 KB per instruction, 32 KB data cache per core
L2 cache	512 KB, 1 MB, 2 MB or 4 MB per core depending on model	512 KB, 1 MB, 2 MB or 4 MB per core depending on model
External bus frequency	667 and 800 MHz	667 and 800 MHz

## Specifications

<b>System Information</b>	<b>Vostro A840</b>	<b>Vostro A860</b>
Chipset	Intel GM965 Express/ICH8M	Intel GM965 Express/ICH8M
Data bus width	64 bits	64 bits
DRAM bus width	dual-channel (2) 64-bit buses	dual-channel (2) 64-bit buses
Processor address bus width	36 bits	36 bits
Flash EPROM	2 MB	2 MB
Graphics bus	internal	internal
PCI bus	32 bits	32 bits
<b>Memory</b>	<b>Vostro A840</b>	<b>Vostro A860</b>
Memory module connector	two user-accessible SODIMM sockets	two user-accessible SODIMM sockets
Memory module capacities	512 MB, 1 GB, 2 GB 4-GB capable	512 MB, 1 GB, 2 GB 4-GB capable
Memory type	DDR2 SODIMM	DDR2 SODIMM

<b>Memory (<i>continued</i>)</b>	<b>Vostro A840</b>	<b>Vostro A860</b>
Minimum memory	512 MB	512 MB
Maximum memory	4 GB	4 GB

<b>Ports and Connectors</b>	<b>Vostro A840</b>	<b>Vostro A860</b>
Audio	microphone connector, stereo headphone/speakers connector	microphone connector, stereo headphone/speakers connector
Mini-Card	one PCI-E Mini-Card slot	one PCI-E Mini-Card slot
Modem	RJ-11 port	RJ-11 port
Network adapter	RJ-45 port	RJ-45 port
USB	two 4-pin USB 2.0-compliant connectors	two 4-pin USB 2.0-compliant connectors
Video	15-hole connector	15-hole connector
IEEE 1394	4-pin mini	4-pin mini

## Specifications

<b>3-in-1 Media Card Reader</b>	<b>Vostro A840</b>	<b>Vostro A860</b>
3-in-1 media memory card controller	Ricoh 5C847	Ricoh R5C847
3-in-1 media memory card connector	3-in-1 combo card connector	3-in-1 combo card connector
Cards supported	SD/SDIO/MMC	SD/SDIO/MMC
<b>Communications</b>	<b>Vostro A840</b>	<b>Vostro A860</b>
Modem:		
Type	v.92 Data/Fax MDC Modem	v.92 Data/Fax MDC Modem
Controller	softmodem	softmodem
Interface	HDA Bus	HDA Bus
Network adapter	10/100 Ethernet LAN on system board	10/100 Ethernet LAN on system board
Wireless	internal WLAN and Bluetooth® wireless support (if optional cards are purchased)	internal WLAN and Bluetooth® wireless support (if optional cards are purchased)



<b>Video</b>	<b>Vostro A840</b>	<b>Vostro A860</b>
Video type:	integrated on system board, hardware accelerated	integrated on system board, hardware accelerated
Data bus	integrated video	integrated video
Video controller	Intel Extreme Graphics	Intel Extreme Graphics
Video memory	up to 128 MB	up to 128 MB
<b>Audio</b>	<b>Vostro A840</b>	<b>Vostro A860</b>
Audio type	two-channel high definition audio (Azalia)	two-channel high definition audio (Azalia)
Audio controller	Conexant CX20561-12Z	Conexant CX20561-12Z
Stereo conversion	24-bit (analog-to-digital and digital-to-analog)	24-bit (analog-to-digital and digital-to-analog)
<b>Interfaces:</b>		
Internal	high-definition audio (Azalia) codec	high-definition audio (Azalia) codec
External	microphone-in connector, stereo headphones/speakers connector	microphone-in connector, stereo headphones/speakers connector

## Specifications

<b>Audio (continued)</b>	<b>Vostro A840</b>	<b>Vostro A860</b>
Speaker	one 4-ohm speaker	one 4-ohm speaker
Internal speaker amplifier	2-W channel into 4 ohms	2-W channel into 4 ohms
Volume controls	program menus	program menus

<b>Display</b>	<b>Vostro A840</b>	<b>Vostro A860</b>
Type (active-matrix TFT)	WXGA	HD
Active area (X/Y)	303.36 x 189.6	344.23 x 193.53
Dimensions:		
Height	206 mm (8.11 inches)	209.5 mm (8.24 inches)
Width	320 mm (12.6 inches)	359.3 mm (14.14 inches)
Diagonal	358.14 mm (14.1 inches)	396.24 mm (15.6 inches)
Operating angle	0° (closed) to 165°	0° (closed) to 165°

<b>Display (continued)</b>	<b>Vostro A840</b>	<b>Vostro A860</b>
Viewing angles:		
WXGA Horizontal	40/40°	40/40°
WXGA Vertical	15/30°	15/30°
Pixel pitch:		
HD	0.2373	0.255
Power Consumption (panel with backlight) (typical):		
WXGA	6.2 W (max) with no inverter losses	6.5 W (max) with no inverter losses
<b>Keyboard</b>	<b>Vostro A840</b>	<b>Vostro A860</b>
Number of keys	86 (U.S. and Canada); 87 (Europe); 90 (Japan)	86 (U.S. and Canada); 87 (Europe); 90 (Japan)
Layout	QWERTY/AZERTY/Kanji	QWERTY/AZERTY/Kanji

## Specifications

<b>Touch Pad</b>	<b>Vostro A840</b>	<b>Vostro A860</b>
X/Y position resolution (graphics table mode)	240 cpi	240 cpi
Size:		
Width	73.0-mm (2.9-inch) sensor-active area)	73.0-mm (2.9-inch) sensor-active area)
Height	42.9-mm (1.7-inch) rectangle)	42.9-mm (1.7-inch) rectangle)
<b>Battery</b>	<b>Vostro A840</b>	<b>Vostro A860</b>
Type	6-cell "smart" lithium ion 4-cell "smart" lithium ion	6-cell "smart" lithium ion 4-cell "smart" lithium ion
Dimensions:		
Depth	53.4 mm (2.10 inches)	53.4 mm (2.10 inches)
Height	20 mm (0.78 inch)	20 mm (0.78 inch)
Width	206.2 mm (8.12 inches)	206.2 mm (8.12 inches)
Weight	0.31 kg (0.68 lb) 0.23 kg (0.5 lb)	0.35 kg (0.68 lb) 0.23 kg (0.5 lb)

<b>Battery (continued)</b>	<b>Vostro A840</b>	<b>Vostro A860</b>
Voltage	11.1 VDC (6-cell) 14.8 VDC (4-cell)	11.1 VDC (6-cell) 14.8 VDC (4-cell)
Charge time (approximate):	4 hours (when computer is off)	4 hours (when computer is off)
Operating time	Battery operating time varies depending on operating conditions and can be significantly reduced under certain power-intensive conditions. See <i>Dell Technology Guide</i> for more information.	Battery operating time varies depending on operating conditions and can be significantly reduced under certain power-intensive conditions. See <i>Dell Technology Guide</i> for more information.
Life span (approximate)	300 charge/discharge cycles	300 charge/discharge cycles
Temperature range:		
Operating	0° to 35°C (32° to 95°F)	0° to 35°C (32° to 95°F)
Storage	-40° to 65°C (-40° to 149°F)	-40° to 65°C (-40° to 149°F)
Coin-cell battery	CR-2032	CR-2032

## Specifications

<b>AC Adapter</b>	<b>Vostro A840</b>	<b>Vostro A860</b>
Input voltage	100–240 VAC	100–240 VAC
Input current (maximum)	1.5 A	1.5 A
Input frequency	50–60 Hz	50–60 Hz
Output current	4.34 A (maximum at 4-second pulse); 3.34 A (continuous)	4.34 A (maximum at 4-second pulse); 3.34 A (continuous)
Output power	65 W	65 W
Rated output voltage	19.5 +/-1.0 VDC	19.5 +/-1.0 VDC
Dimensions:		
Height	28.2 mm (1.11 inches)	28.2 mm (1.11 inches)
Width	57.9 mm (2.28 inches)	57.9 mm (2.28 inches)
Depth	137.2 mm (5.4 inches)	137.2 mm (5.4 inches)
Weight (with cables)	0.4 kg (0.9 lb)	0.4 kg (0.9 lb)

<b>AC Adapter (continued)</b>	<b>Vostro A840</b>	<b>Vostro A860</b>
Temperature range:		
Operating	0° to 35°C (32° to 95°F)	0° to 35°C (32° to 95°F)
Storage	-40° to 65°C (-40° to 149°F)	-40° to 65°C (-40° to 149°F)
<b>Physical</b>	<b>Vostro A840</b>	<b>Vostro A860</b>
Height	31.1mm to 35.6 mm (1.2 to 1.4 inches)	31.5 to 36.8 mm (1.24 to 1.44 inches)
Width	340 mm (13.39 inches)	376 mm (14.8 inches)
Depth	250 mm (9.85 inches)	255 mm (10.03 inches)
Weight (with 4-cell battery)	2.03 kg (4.47 lb)	2.46 kg (5.42 lb)
Weight (with 6-cell battery)	2.11 kg (4.65 lb)	2.54 kg (5.59)
<b>Environmental</b>	<b>Vostro A840</b>	<b>Vostro A860</b>
Temperature range:		
Operating	0° to 35°C (32° to 95°F)	0° to 35°C (32° to 95°F)
Storage	-40° to 65°C (-40° to 149°F)	-40° to 65°C (-40° to 149°F)

## Specifications

<b>Environmental (continued)</b>	<b>Vostro A840</b>	<b>Vostro A860</b>
Relative humidity (maximum):		
Operating	10% to 90% (noncondensing)	10% to 90% (noncondensing)
Storage	5% to 95% (noncondensing)	5% to 95% (noncondensing)
Maximum vibration (using a random-vibration spectrum that simulates user environment):		
Operating	0.66 GRMS	0.66 GRMS
Storage	1.3 GRMS	1.3 GRMS
Maximum shock (measured with hard drive in head-parked position and a 2-ms half-sine pulse):		110 G
Operating	110 G	110 G
Storage	163 G	163 G
Airborne containment level	G2 or lower as defined by ISA-S71.04-1985	G2 or lower as defined by ISA-S71.04-1985



# Troubleshooting



**CAUTION:** To guard against the likelihood of electric shock, laceration by moving fan blades, or other expected injuries, always unplug your computer from the electrical outlet before opening the cover.



**CAUTION:** Before working inside your computer, read the safety information that shipped with your computer. For additional safety best practices information, see the Regulatory Compliance Homepage at [www.dell.com/regulatory\\_compliance](http://www.dell.com/regulatory_compliance).

## Error Messages

If the message is not listed, see the documentation for the operating system or the program that was running when the message appeared.

**AUXILIARY DEVICE FAILURE** — The touch pad or external mouse may be faulty. For an external mouse, check the cable connection. Enable the **Pointing Device** option in the system

setup program. See your *Service Manual* at [support.dell.com](http://support.dell.com) for more information. If the problem persists, contact Dell (see "Contacting Dell" on page 69).

**CACHE DISABLED DUE TO FAILURE** — The primary cache internal to the microprocessor has failed. Contact Dell (see "Contacting Dell" on page 69).

**OPTICAL DRIVE CONTROLLER FAILURE** — The optical drive does not respond to commands from the computer.

**DATA ERROR** — The hard drive cannot read the data.

**DECREASING AVAILABLE MEMORY** — One or more memory modules may be faulty or improperly seated. Reinstall the memory modules and, if necessary, replace them. See your *Service Manual* at [support.dell.com](http://support.dell.com) for more information.

**DISK C: FAILED INITIALIZATION** — The hard drive failed initialization. Run the hard drive tests in the Dell Diagnostics (see "Dell Diagnostics" on page 42).

**DRIVE NOT READY** — The operation requires a hard drive in the bay before it can continue. Install a hard drive in the hard drive bay. See your *Service Manual* at [support.dell.com](http://support.dell.com) for more information.

**ERROR READING PCMCIA CARD** — The computer cannot identify the ExpressCard. Reinsert the card or try another card. See your *Service Manual* at [support.dell.com](http://support.dell.com) for more information.

**EXTENDED MEMORY SIZE HAS CHANGED** — The amount of memory recorded in nonvolatile memory (NVRAM) does not match the memory installed in the computer. Restart the computer. If the error appears again, contact Dell (see "Contacting Dell" on page 69).

**THE FILE BEING COPIED IS TOO LARGE FOR THE DESTINATION DRIVE** — The file that you are trying to copy is too large to fit on the disk, or the disk is full. Try copying the file to a different disk or use a larger capacity disk.

**A FILENAME CANNOT CONTAIN ANY OF THE FOLLOWING CHARACTERS: \ / : \* ? " < > |** — Do not use these characters in filenames.

**GATE A20 FAILURE** — A memory module may be loose. Reinstall the memory modules and, if necessary, replace them. See your *Service Manual* at [support.dell.com](http://support.dell.com) for more information.

**GENERAL FAILURE** — The operating system is unable to carry out the command. The message is usually followed by specific information—for example, `Printer out of paper`. Take the appropriate action.

**HARD-DISK DRIVE CONFIGURATION**

**ERROR** — The computer cannot identify the drive type. Shut down the computer, remove the hard drive (see your *Service Manual* at [support.dell.com](http://support.dell.com)), and boot the computer from the media. Then, shut down the computer, reinstall the hard drive, and restart the computer. Run the Hard Disk Drive tests in the Dell Diagnostics (see "Dell Diagnostics" on page 42).

**HARD-DISK DRIVE CONTROLLER FAILURE 0** —

The hard drive does not respond to commands from the computer. Shut down the computer, remove the hard drive (see your *Service Manual* at [support.dell.com](http://support.dell.com)), and boot the computer from the media. Then, shut down the computer, reinstall the hard drive, and restart the computer. If the problem persists, try another drive. Run the Hard Disk Drive tests in the Dell Diagnostics (see "Dell Diagnostics" on page 42).

**HARD-DISK DRIVE FAILURE** — The hard drive does not respond to commands from the computer. Shut down the computer, remove the hard drive (see your *Service Manual* at [support.dell.com](http://support.dell.com)), and boot the computer from the media. Then, shut down the computer, reinstall the hard drive, and restart the computer. If the problem persists, try another drive. Run the Hard Disk Drive tests in the Dell Diagnostics (see "Dell Diagnostics" on page 42).

**HARD-DISK DRIVE READ FAILURE** — The hard drive may be defective. Shut down the computer, remove the hard drive (see your *Service Manual* at [support.dell.com](http://support.dell.com)), and boot the computer using the media. Then, shut down the computer, reinstall the hard drive, and restart the computer. If the problem persists, try another drive. Run the Hard Disk Drive tests in the Dell Diagnostics (see "Dell Diagnostics" on page 42).

**INSERT BOOTABLE MEDIA** — The operating system is trying to boot to nonbootable media. Insert bootable media.

### **INVALID CONFIGURATION INFORMATION— PLEASE RUN SYSTEM SETUP PROGRAM —**

The system configuration information does not match the hardware configuration. The message is most likely to occur after a memory module is installed. Correct the appropriate options in the system setup program. See your *Service Manual* at [support.dell.com](http://support.dell.com) for more information.

**KEYBOARD CLOCK LINE FAILURE —** For external keyboards, check the cable connection. Run the Keyboard Controller test in the Dell Diagnostics (see "Dell Diagnostics" on page 42).

**KEYBOARD CONTROLLER FAILURE —** For external keyboards, check the cable connection. Restart the computer, and avoid touching the keyboard or the mouse during the boot routine. Run the Keyboard Controller test in the Dell Diagnostics (see "Dell Diagnostics" on page 42).

**KEYBOARD DATA LINE FAILURE —** For external keyboards, check the cable connection. Run the Keyboard Controller test in the Dell Diagnostics (see "Dell Diagnostics" on page 42).

**KEYBOARD STUCK KEY FAILURE —** For external keyboards or keypads, check the cable connection. Restart the computer, and avoid touching the keyboard or keys during the boot routine. Run the Stuck Key test in the Dell Diagnostics (see "Dell Diagnostics" on page 42).

### **MEMORY ADDRESS LINE FAILURE AT ADDRESS, READ VALUE EXPECTING VALUE —**

A memory module may be faulty or improperly seated. Reinstall the memory modules and, if necessary, replace them. See your *Service Manual* at [support.dell.com](http://support.dell.com) for more information.

**MEMORY ALLOCATION ERROR —** The software you are attempting to run is conflicting with the operating system, another program, or a utility. Shut down the computer, wait 30 seconds, and then restart it. Try to run the program again. If the error message still appears, see the software documentation.

**MEMORY DATA LINE FAILURE AT ADDRESS, READ VALUE EXPECTING VALUE — A**

A memory module may be faulty or improperly seated. Reinstall the memory modules and, if necessary, replace them. See your *Service Manual* at [support.dell.com](http://support.dell.com) for more information.

**MEMORY DOUBLE WORD LOGIC FAILURE AT ADDRESS, READ VALUE EXPECTING**

**VALUE** — A memory module may be faulty or improperly seated. Reinstall the memory modules and, if necessary, replace them. See your *Service Manual* at [support.dell.com](http://support.dell.com) for more information.

**MEMORY ODD/EVEN LOGIC FAILURE AT ADDRESS, READ VALUE EXPECTING**

**VALUE** — A memory module may be faulty or improperly seated. Reinstall the memory modules and, if necessary, replace them. See your *Service Manual* at [support.dell.com](http://support.dell.com) for more information.

**MEMORY WRITE/READ FAILURE AT ADDRESS, READ VALUE EXPECTING**

**VALUE** — A memory module may be faulty or improperly seated. Reinstall the memory modules and, if necessary, replace them. See your *Service Manual* at [support.dell.com](http://support.dell.com) for more information.

**NO BOOT DEVICE AVAILABLE** — The computer cannot find the hard drive. If the hard drive is your boot device, ensure that the drive is installed, properly seated, and partitioned as a boot device.

**NO BOOT SECTOR ON HARD DRIVE** — The operating system may be corrupted. Contact Dell (see "Contacting Dell" on page 69).

**NO TIMER TICK INTERRUPT** — A chip on the system board may be malfunctioning. Run the System Set tests in the Dell Diagnostics (see "Dell Diagnostics" on page 42).

### **NOT ENOUGH MEMORY OR RESOURCES.**

#### **EXIT SOME PROGRAMS AND TRY**

**AGAIN** — You have too many programs open. Close all windows and open the program that you want to use.

#### **OPERATING SYSTEM NOT FOUND** —

Reinstall the hard drive (see your *Service Manual* at [support.dell.com](http://support.dell.com)). If the problem persists, contact Dell (see "Contacting Dell" on page 69).

**OPTIONAL ROM BAD CHECKSUM** — The optional ROM has failed. Contact Dell (see "Contacting Dell" on page 69).

#### **A REQUIRED .DLL FILE WAS NOT**

**FOUND** — The program that you are trying to open is missing an essential file. Remove and then reinstall the program.

- 1 Click the Windows Vista start button  → Control Panel → Programs → Programs and Features.
- 2 Select the program you want to remove.

- 3 Click Uninstall.

- 4 See the program documentation for installation instructions and reinstall the program.

**SECTOR NOT FOUND** — The operating system cannot locate a sector on the hard drive. You may have a defective sector or corrupted FAT on the hard drive. Run the Windows error-checking utility to check the file structure on the hard drive. See Windows Help and Support for instructions (click **Start** → **Help and Support**). If a large number of sectors are defective, back up the data (if possible), and then reformat the hard drive.

**SEEK ERROR** — The operating system cannot find a specific track on the hard drive.

**SHUTDOWN FAILURE** — A chip on the system board may be malfunctioning. Run the System Set tests in the Dell Diagnostics (see "Dell Diagnostics" on page 42).

**TIME-OF-DAY CLOCK LOST POWER** —

System configuration settings are corrupted. Connect your computer to an electrical outlet to charge the battery. If the problem persists, try to restore the data by entering the system setup program, then immediately exit the program (see your *Service Manual* at [support.dell.com](http://support.dell.com)). If the message reappears, contact Dell (see "Contacting Dell" on page 69).

**TIME-OF-DAY CLOCK STOPPED** — The coin-cell battery that supports the system configuration settings may need to be changed. Connect your computer to an electrical outlet to charge the battery. If the problem persists, contact Dell (see "Contacting Dell" on page 69).

**TIME-OF-DAY NOT SET-PLEASE RUN THE SYSTEM SETUP PROGRAM** — The time or date stored in the system setup program does not match the system clock. Correct the settings for the **Date** and **Time** options. See your *Service Manual* at [support.dell.com](http://support.dell.com) for more information.

**TIMER CHIP COUNTER 2 FAILED** — A chip on the system board may be malfunctioning. Run the System Set tests in the Dell Diagnostics (see "Dell Diagnostics" on page 42).

**UNEXPECTED INTERRUPT IN PROTECTED MODE** — The keyboard controller may be malfunctioning, or a memory module may be loose. Run the System Memory tests and the Keyboard Controller test in the Dell Diagnostics (see "Dell Diagnostics" on page 42).

**X:\ IS NOT ACCESSIBLE. THE DEVICE IS NOT READY** — Insert a disk into the drive and try again.

**WARNING: BATTERY IS CRITICALLY LOW** — The battery is running out of charge. Replace the battery, or connect the computer to an electrical outlet; otherwise, activate hibernate mode or shut down the computer.

### System Messages



**NOTE:** If the message you received is not listed in the table, see the documentation for either the operating system or the program that was running when the message appeared.

**ALERT! PREVIOUS ATTEMPTS AT BOOTING THIS SYSTEM HAVE FAILED AT CHECKPOINT [NNNN]. FOR HELP IN RESOLVING THIS PROBLEM, PLEASE NOTE THIS CHECKPOINT AND CONTACT DELL TECHNICAL SUPPORT**

— The computer failed to complete the start routine three consecutive times for the same error (see "Contacting Dell" on page 69 for assistance).

**CMOS CHECKSUM ERROR** — Possible system board failure or RTC battery low. Replace the battery. See your *Service Manual* at [support.dell.com](http://support.dell.com) or see "Contacting Dell" on page 69 for assistance.

**CPU FAN FAILURE** — Processor fan failure. Replace processor fan. See your *Service Manual* at [support.dell.com](http://support.dell.com).

**HARD-DISK DRIVE FAILURE** — Possible hard drive failure during hard drive POST. Check cables, swap hard disks, or see "Contacting Dell" on page 69 for assistance.

**HARD-DISK DRIVE READ FAILURE** —

Possible hard drive failure during hard-drive start test (see "Contacting Dell" on page 69 for assistance).

**KEYBOARD FAILURE** — Keyboard failure or keyboard cable loose.

**NO BOOT DEVICE AVAILABLE** — No bootable partition on hard drive, or the hard drive cable is loose, or no bootable device exists.

- If the hard drive is your boot device, ensure that the cables are connected and that the drive is installed properly and partitioned as a boot device.
- Enter system setup and ensure that the boot sequence information is correct (see your *Service Manual* at [support.dell.com](http://support.dell.com)).



**NO TIMER TICK INTERRUPT** — A chip on the system board might be malfunctioning or system board failure (see "Contacting Dell" on page 69 for assistance).

**USB OVER CURRENT ERROR** — Disconnect the USB device. Use external power source for the USB device.

**NOTICE - HARD DRIVE SELF MONITORING SYSTEM HAS REPORTED THAT A PARAMETER HAS EXCEEDED ITS NORMAL OPERATING RANGE. DELL RECOMMENDS THAT YOU BACK UP YOUR DATA REGULARLY. A PARAMETER OUT OF RANGE MAY OR MAY NOT INDICATE A POTENTIAL HARD DRIVE PROBLEM** —

S.M.A.R.T error, possible hard drive failure.

## Troubleshooting Software and Hardware Problems

If a device is either not detected during the operating system setup or is detected but incorrectly configured, you can use the Hardware Troubleshooter to resolve the incompatibility.

To start the Hardware Troubleshooter:

- 1 Click the Windows Vista Start button , and click **Help and Support**.
- 2 Type `hardware troubleshooter` in the search field and press <Enter> to start the search.
- 3 In the search results, select the option that best describes the problem and follow the remaining troubleshooting steps.

### Dell Diagnostics



**CAUTION:** Before working inside your computer, read the safety information that shipped with your computer. For additional safety best practices information, see the Regulatory Compliance Homepage at [www.dell.com/regulatory\\_compliance](http://www.dell.com/regulatory_compliance).

### When to Use the Dell Diagnostics

If you experience a problem with your computer, perform the checks in Lockups and Software Problems (see "Lockups and Software Problems" on page 47) and run the Dell Diagnostics before you contact Dell for technical assistance.

It is recommended that you print these procedures before you begin.



**NOTICE:** The Dell Diagnostics works only on Dell computers.



**NOTE:** The Dell *Drivers and Utilities* media is optional and may not ship with your computer.

See your *Service Manual* at [support.dell.com](http://support.dell.com) to review your computer's configuration information, and ensure that the device that you want to test displays in the system setup program and is active.

Start the Dell Diagnostics from your hard drive or from the Dell *Drivers and Utilities* media.

### Starting the Dell Diagnostics From Your Hard Drive



**NOTE:** If your computer cannot display a screen image, see "Contacting Dell" on page 69.

- 1 Ensure that the computer is connected to an electrical outlet that is known to be working properly.
- 2 Turn on (or restart) your computer.
- 3 When the DELL™ logo appears, press <F12> immediately. Select **Diagnostics** from the start menu and press <Enter>.



**NOTICE:** If you wait too long and the operating system logo appears, continue to wait until you see the Microsoft® Windows® desktop, and then shut down your computer and try again.



**NOTICE:** If you see a message stating that no diagnostics utility partition has been found, run the Dell Diagnostics from the *Drivers and Utilities* media.

- 4 Press any key to start the Dell Diagnostics from the diagnostics utility partition on your hard drive, and follow the instructions on the screen.

## Starting the Dell Diagnostics From the Dell *Drivers and Utilities* Media

- 1 Insert the *Drivers and Utilities* media.
- 2 Shut down and restart the computer. When the DELL logo appears, press <F12> immediately.



**NOTICE:** If you wait too long and the operating system logo appears, continue to wait until you see the Microsoft® Windows® desktop; then, shut down your computer and try again.



**NOTICE:** The next steps change the boot sequence for one time only. On the next start-up, the computer starts according to the devices specified in the system setup program.

- 3 When the boot device list appears, highlight CD/DVD/CD-RW and press <Enter>.
- 4 Select the **Boot from CD-ROM** option from the menu that appears and press <Enter>.

## Troubleshooting

- 5 Type 1 to start the CD menu and press <Enter> to proceed.
  - 6 Select **Run the 32 Bit Dell Diagnostics** from the numbered list. If multiple versions are listed, select the version that is appropriate for your computer.
  - 7 When the **Dell Diagnostics Main Menu** appears, select the test that you want to run, and follow the instructions on the screen.
- If an error message appears on the screen, write down the exact message. This message may help support personnel to diagnose and fix the problem(s).
  - If an error message occurs in a program, see the program documentation.



**NOTE:** The procedures in this document were written for the Windows default view, so they may not apply if you set your Dell computer to the Windows Classic view.

## Troubleshooting Tips

Follow these tips when troubleshooting your computer:

- If you added or removed a part before the problem started, review the installation procedures and ensure that the part is correctly installed (see your *Service Manual* at [support.dell.com](http://support.dell.com)).
- If a device does not work, ensure that the device is properly connected.

## Power Problems



**CAUTION:** Before working inside your computer, read the safety information that shipped with your computer. For additional safety best practices information, see the **Regulatory Compliance Homepage** at [www.dell.com/regulatory\\_compliance](http://www.dell.com/regulatory_compliance).

**IF THE POWER LIGHT IS OFF** — The computer is either turned off or is not receiving power.

- Reseat the power cable in the power connector on the back of the computer and the electrical outlet.
- Bypass power strips, power extension cables, and other power protection devices to verify that the computer turns on properly.
- Ensure that any power strips being used are plugged into an electrical outlet and are turned on.
- Ensure that the electrical outlet is working by testing it with another device, such as a lamp.
- Ensure that the main power cable and front panel cable are securely connected to the system board (see your *Service Manual* at [support.dell.com](http://support.dell.com)).

**IF THE POWER LIGHT IS BLUE AND THE COMPUTER IS NOT RESPONDING** —

- Ensure that the display is connected and powered on.

**IF THE POWER LIGHT IS BLINKING**

**BLUE** — The computer is in standby mode. Press a key on the keyboard, move the mouse, or press the power button to resume normal operation.

**IF THE POWER LIGHT IS BLINKING**

**AMBER** — The computer is receiving electrical power, a device might be malfunctioning or incorrectly installed.

- Remove and then reinstall all memory modules (see your *Service Manual* at [support.dell.com](http://support.dell.com)).
- Remove and then reinstall any expansion cards, including graphics cards (see your *Service Manual* at [support.dell.com](http://support.dell.com)).

**IF THE POWER LIGHT IS STEADY**

**AMBER** — There is a power problem, a device may be malfunctioning or incorrectly installed.

## Troubleshooting

- Ensure that the processor power cable is securely connected to the system board power connector (see your *Service Manual* at [support.dell.com](http://support.dell.com)).
- Ensure that the main power cable and the front panel cable are securely connected to the system board connector (see your *Service Manual* at [support.dell.com](http://support.dell.com)).

**ELIMINATE INTERFERENCE** — Some possible causes of interference are:

- Power, keyboard, and mouse extension cables
- Too many devices connected to the same power strip
- Multiple power strips connected to the same electrical outlet

## Memory Problems



**CAUTION:** Before working inside your computer, read the safety information that shipped with your computer. For additional safety best practices information, see the **Regulatory Compliance Homepage** at [www.dell.com/regulatory\\_compliance](http://www.dell.com/regulatory_compliance).

**IF YOU RECEIVE AN INSUFFICIENT MEMORY MESSAGE** —

- Save and close any open files and exit any open programs you are not using to see if that resolves the problem.
- See the software documentation for minimum memory requirements. If necessary, install additional memory (see your *Service Manual* at [support.dell.com](http://support.dell.com)).

- Reseat the memory modules (see your *Service Manual* at [support.dell.com](http://support.dell.com)) to ensure that your computer is successfully communicating with the memory.
- Run the Dell Diagnostics (see "Dell Diagnostics" on page 42).

### IF YOU EXPERIENCE OTHER MEMORY PROBLEMS —

- Reseat the memory modules (see your *Service Manual* at [support.dell.com](http://support.dell.com)) to ensure that your computer is successfully communicating with the memory.
- Ensure that you are following the memory installation guidelines (see your *Service Manual* at [support.dell.com](http://support.dell.com)).
- Ensure that the memory you are using is supported by your computer. For more information about the type of memory supported by your computer, see "Memory" on page 22.
- Run the Dell Diagnostics (see "Dell Diagnostics" on page 42).

## Lockups and Software Problems



**CAUTION:** Before working inside your computer, read the safety information that shipped with your computer. For additional safety best practices information, see the Regulatory Compliance Homepage at [www.dell.com/regulatory\\_compliance](http://www.dell.com/regulatory_compliance).

### The computer does not start up

**ENSURE THAT THE POWER CABLE IS FIRMLY CONNECTED TO THE COMPUTER AND TO THE ELECTRICAL OUTLET**

### The computer stops responding



**NOTICE:** You may lose data if you are unable to perform an operating system shutdown.

**TURN THE COMPUTER OFF** — If you are unable to get a response by pressing a key on your keyboard or moving your mouse, press the power button for at least 8 to 10 seconds (until the computer turns off), and then restart your computer.

### A program stops responding

#### END THE PROGRAM —

- 1 Press <Ctrl><Shift><Esc> simultaneously to access the Task Manager, and click the **Applications** tab.
- 2 Click to select the program that is no longer responding, and click **End Task**.

### A program crashes repeatedly



**NOTE:** Most software includes installation instructions in its documentation or the media (CD or DVD).

#### CHECK THE SOFTWARE

**DOCUMENTATION** — If necessary, uninstall and then reinstall the program.

### A program is designed for an earlier Microsoft® Windows® operating system

#### RUN THE PROGRAM COMPATIBILITY WIZARD —

The Program Compatibility Wizard configures a program so that it runs in an environment similar to non-Windows Vista operating system environments.

- 1 Click **Start**  → **Control Panel** → **Programs** → **Use an older program with this version of Windows**.
- 2 In the welcome screen, click **Next**.
- 3 Follow the instructions on the screen.

### A solid blue screen appears

**TURN THE COMPUTER OFF** — If you are unable to get a response by pressing a key on your keyboard or moving your mouse, press the power button for at least 8 to 10 seconds (until the computer turns off), and then restart your computer.



## Other software problems

### CHECK THE SOFTWARE DOCUMENTATION OR CONTACT THE SOFTWARE MANUFACTURER FOR TROUBLESHOOTING INFORMATION —

- Ensure that the program is compatible with the operating system installed on your computer.
- Ensure that your computer meets the minimum hardware requirements needed to run the software. See the software documentation for information.
- Ensure that the program is installed and configured properly.
- Verify that the device drivers do not conflict with the program.
- If necessary, uninstall and then reinstall the program.

### BACK UP YOUR FILES IMMEDIATELY

- Use a virus-scanning program to check the hard drive, CDs, or DVDs
- Save and close any open files or programs and shut down your computer through the Start menu

## Dell Technical Update Service

The Dell Technical Update service provides proactive e-mail notification of software and hardware updates for your computer. The service is free and can be customized for content, format, and how frequently you receive notifications.

To enroll for the Dell Technical Update service, go to [support.dell.com/technicalupdate](http://support.dell.com/technicalupdate).

## Dell Support Center

The Dell Support Center helps you find the service, support and system-specific information you need. For more information about Dell Support Center and available support tools, click the **Services** tab at [support.dell.com](http://support.dell.com).

## Troubleshooting

Click on the  icon in the taskbar to run the application. The home page provides links to access:

- Self Help (Troubleshooting, Security, System Performance, Network/Internet, Backup/Recovery, and Windows Vista)
- Alerts (technical support alerts relevant to your computer)
- Assistance from Dell (Technical Support with DellConnect™, Customer Service, Training and Tutorials, How-To Help with Dell on Call, and Online Scan with PCCheckUp)
- About Your System (System Documentation, Warranty Information, System Information, Upgrades & Accessories)

The top of the Dell Support Center home page displays your system's model number along with its service tag and express service code.

For more information on Dell Support Center, see the Dell Technology Guide. It is available in Windows Help and Support (**Start** → **Help and Support**) and at Dell Support Website ([support.dell.com](http://support.dell.com)).

# Reinstalling Software

## Drivers

### Identifying Drivers

If you experience a problem with any device, identify whether the driver is the source of your problem and, if necessary, update the driver.

- 1 Click the Windows Vista Start button™ , and right-click **Computer**.
- 2 Click **Properties**→ **Device Manager**.



**NOTE:** The User Account Control window may appear. If you are an administrator on the computer, click **Continue**; otherwise, contact your administrator to continue.

Scroll down the list to see if any device has an exclamation point (a yellow circle with a [!]) on the device icon.

If an exclamation point is next to the device name, you may need to reinstall the driver or install a new driver (see "Reinstalling Drivers and Utilities" on page 51).

### Reinstalling Drivers and Utilities



**NOTICE:** The Dell Support website at [support.dell.com](http://support.dell.com) and your *Drivers and Utilities* media provide approved drivers for Dell™ computers. If you install drivers obtained from other sources, your computer might not work correctly.

### Returning to a Previous Device Driver Version

- 1 Click the Windows Vista Start button , and right-click **Computer**.
- 2 Click **Properties**→ **Device Manager**.



**NOTE:** The User Account Control window may appear. If you are an administrator on the computer, click **Continue**; otherwise, contact your administrator to enter the Device Manager.

- 3 Right-click the device for which the new driver was installed and click **Properties**.
- 4 Click the **Drivers** tab → **Roll Back Driver**.

If Device Driver Rollback does not resolve the problem, then use System Restore (see "Restoring Your Operating System" on page 54) to return your computer to the operating state that existed before you installed the new driver.

### Using the Drivers and Utilities Media

If using Device Driver Rollback or System Restore (see "Restoring Your Operating System" on page 54) does not resolve the problem, reinstall the driver from your *Drivers and Utilities* media.

- 1 With the Windows desktop displayed, insert your *Drivers and Utilities* media.

If this is your first time to use the *Drivers and Utilities* media, go to step 2. If not, go to step 5.

- 2 When the *Drivers and Utilities* media installation program starts, follow the prompts on the screen.



**NOTE:** In most cases, the *Drivers and Utilities* program starts running automatically. If it does not, start Windows Explorer, click your media drive directory to display the media contents, and then double-click the `autorcd.exe` file.

- 3 When the InstallShield Wizard Complete window appears, remove the *Drivers and Utilities* media and click **Finish** to restart the computer.
- 4 When you see the Windows desktop, reinsert the *Drivers and Utilities* media.

- At the **Welcome Dell System Owner** screen, click **Next**.



**NOTE:** The *Drivers and Utilities* program displays drivers only for hardware that came installed in your computer. If you installed additional hardware, the drivers for the new hardware might not be displayed. If those drivers are not displayed, exit the *Drivers and Utilities* program. For drivers information, see the documentation that came with the device.

A message appears, stating that the *Drivers and Utilities* media is detecting hardware in your computer.

The drivers that are used by your computer are automatically displayed in the **My Drivers—The ResourceCD has identified these components in your system window**.

- Click the driver that you want to reinstall and follow the instructions on the screen.

If a particular driver is not listed, then that driver is not required by your operating system.

## Manually Reinstalling Drivers

After extracting the driver files to your hard drive as described in the previous section:

- Click the Windows Vista Start button , and right-click **Computer**.
- Click **Properties**→ **Device Manager**.



**NOTE:** The **User Account Control** window may appear. If you are an administrator on the computer, click **Continue**; otherwise, contact your administrator to enter the Device Manager.

- Double-click the type of device for which you are installing the driver (for example, **Audio** or **Video**).
- Double-click the name of the device for which you are installing the driver.
- Click the **Driver** tab→ **Update Driver**→ **Browse my computer for driver software**.

- 6 Click **Browse** and browse to the location to which you previously copied the driver files.
- 7 When the name of the appropriate driver appears, click the name of the driver → **OK** → **Next**.
- 8 Click **Finish** and restart your computer.

## Restoring Your Operating System

You can restore your operating system in the following ways:

- Microsoft Windows System Restore returns your computer to an earlier operating state without affecting data files. Use System Restore as the first solution for restoring your operating system and preserving data files.
- If you received the *Operating System* media with your computer, you can use it to restore your operating system. However, using the *Operating System* media also deletes all data on the hard drive. Use the media *only* if System Restore did not resolve your operating system problem.

## Using Microsoft® Windows® System Restore

The Windows operating systems provide a System Restore option that allows you to return your computer to an earlier operating state (without affecting data files) if changes to the hardware, software, or other system settings have left the computer in an undesirable operating state. Any changes that System Restore makes to your computer are completely reversible.



**NOTICE:** Make regular backups of your data files. System Restore does not monitor your data files or recover them.



**NOTE:** The procedures in this document were written for the Windows default view, so they may not apply if you set your Dell™ computer to the Windows Classic view.



**NOTE:** Set your Dell™ computer to the Windows Classic view.

## Starting System Restore

- 1 Click Start .
- 2 In the Start Search box, type `System Restore` and press <Enter>.



**NOTE:** The User Account Control window may appear. If you are an administrator on the computer, click **Continue**; otherwise, contact your administrator to continue the desired action.

- 3 Click **Next** and follow the remaining prompts on the screen.

In the event that System Restore did not resolve the issue, you may undo the last system restore (see "Undoing the Last System Restore" on page 55).

## Undoing the Last System Restore



**NOTICE:** Before you undo the last system restore, save and close all open files and exit any open programs. Do not alter, open, or delete any files or programs until the system restoration is complete.

- 1 Click Start .
- 2 In the Start Search box, type `System Restore` and press <Enter>.
- 3 Click **Undo my last restoration** and click **Next**.

## Using the Operating System Media

### Before you Begin

If you are considering reinstalling the Windows operating system to correct a problem with a newly installed driver, first try using Windows Device Driver Rollback. See "Returning to a Previous Device Driver Version" on page 51. If Device Driver Rollback does not resolve the problem, use Microsoft Windows System Restore to return your

operating system to the operating state it was in before you installed the new device driver. See "Using Microsoft® Windows® System Restore" on page 54.



**NOTICE:** Before performing the installation, back up all data files on your primary hard drive. For conventional hard drive configurations, the primary hard drive is the first drive detected by the computer.

To reinstall Windows, you need the Dell™ *Operating System* media and the Dell *Drivers and Utilities* media.



**NOTE:** The Dell *Drivers and Utilities* media contains drivers that were installed during the assembly of the computer. Use the Dell *Drivers and Utilities* media to load any required drivers. Depending on the region from which you ordered your computer, or whether you requested the media, the Dell *Drivers and Utilities* media and Dell *Operating System* media may not ship with your computer.

## Reinstalling Windows

The reinstallation process can take 1 to 2 hours to complete. After you reinstall the operating system, you must also reinstall the device drivers, virus protection program, and other software.

- 1 Save and close any open files and exit any open programs.
- 2 Insert the *Operating System* media.
- 3 If the `Install Windows` message appears, click `Exit`.
- 4 Restart the computer.

When the DELL logo appears, press <F12> immediately.



**NOTE:** If you wait too long and the operating system logo appears, continue to wait until you see the Microsoft® Windows® desktop; then, shut down your computer and try again.





**NOTE:** The next steps change the boot sequence for one time only. On the next start-up, the computer boots according to the devices specified in the system setup program.

- 5** When the boot device list appears, highlight **CD/DVD/CD-RW Drive** and press <Enter>.
- 6** Press any key to **Boot from CD-ROM**, and follow the instructions on the screen to complete the installation.



## Finding Information



**NOTE:** Some features or media may be optional and may not ship with your computer. Some features or media may not be available in certain countries.



**NOTE:** Additional information may ship with your computer.

Document/Media/Label	Contents
<p><b>Service Tag/Express Service Code</b></p> <p>The Service Tag/Express Service Code is located on your computer.</p>	<ul style="list-style-type: none"> <li>• Use the Service Tag to identify your computer when you use <a href="http://support.dell.com">support.dell.com</a> or contact support.</li> <li>• Enter the Express Service Code to direct your call when contacting support</li> </ul> <p><b>NOTE:</b> Your Service Tag/Express Service Code is located on your computer.</p>
<p><b>Drivers and Utilities Media</b></p> <p>The <i>Drivers and Utilities</i> media is a CD or DVD that may have shipped with your computer.</p>	<ul style="list-style-type: none"> <li>• A diagnostic program for your computer</li> <li>• Drivers for your computer</li> <li>• Drivers and documentation updates can be found at <a href="http://support.dell.com">support.dell.com</a>.</li> <li>• Notebook System Software (NSS)</li> <li>• Readme files</li> </ul> <p><b>NOTE:</b> Readme files may be included on your media to provide last-minute updates about technical changes to your computer or advanced technical-reference material for technicians or experienced users.</p>

<b>Document/Media/Label</b>	<b>Contents</b>
<b>Operating System Media</b> The <i>Operating System</i> media is a CD or DVD that may have shipped with your computer.	Reinstall your operating system
<b>Safety, Regulatory, Warranty, and Support Documentation</b> This type of information may have shipped with your computer. For additional regulatory information, see the Regulatory Compliance Homepage on <a href="http://www.dell.com">www.dell.com</a> at the following location: <a href="http://www.dell.com/regulatory_compliance">www.dell.com/regulatory_compliance</a> .	<ul style="list-style-type: none"><li>• Warranty information</li><li>• Terms and Conditions (U.S. only)</li><li>• Safety instructions</li><li>• Regulatory information</li><li>• Ergonomics information</li><li>• End User License Agreement</li></ul>
<b>Service Manual</b> The <i>Service Manual</i> for your computer can be found at <a href="http://support.dell.com">support.dell.com</a> .	<ul style="list-style-type: none"><li>• How to remove and replace parts</li><li>• How to configure system settings</li><li>• How to troubleshoot and solve problems</li></ul>

---

<b>Document/Media/Label</b>	<b>Contents</b>
<b>Dell Technology Guide</b> The <i>Dell Technology Guide</i> is available at <a href="http://support.dell.com">support.dell.com</a> .	<ul style="list-style-type: none"><li>• About your operating system</li><li>• Using and maintaining devices</li><li>• Understanding technologies such as RAID, Internet, Bluetooth<sup>®</sup> wireless technology, e-mail, networking, and more.</li></ul>
<b>Microsoft<sup>®</sup> Windows<sup>®</sup> License Label</b> Your Microsoft Windows License is located on your computer.	<ul style="list-style-type: none"><li>• Provides your operating system product key.</li></ul>

---



# Getting Help

## Obtaining Assistance



**CAUTION:** If you need to remove the computer cover, first disconnect the computer power and modem cables from all electrical outlets. Follow the safety instructions that shipped with your computer.

If you experience a problem with your computer, you can complete the following steps to diagnose and troubleshoot the problem:

- 1 See "Troubleshooting Tips" on page 44 for information and procedures that pertain to the problem your computer is experiencing.
- 2 See "Dell Diagnostics" on page 42 for procedures on how to run Dell Diagnostics.
- 3 Fill out the "Diagnostics Checklist" on page 68.

- 4 Use Dell's extensive suite of online services available at Dell Support ([support.dell.com](http://support.dell.com)) for help with installation and troubleshooting procedures. See "Online Services" on page 64 for a more extensive list of Dell Support online.
- 5 If the preceding steps have not resolved the problem, see "Contacting Dell" on page 69.



**NOTE:** Call Dell Support from a telephone at or near the affected computer so that the support staff can assist you with any necessary procedures.



**NOTE:** Dell's Express Service Code system may not be available in all countries.

When prompted by Dell's automated telephone system, enter your Express Service Code to route the call directly to the proper support personnel. If you do not have an Express Service Code, open

## Getting Help

the **Dell Accessories** folder, double-click the **Express Service Code** icon, and follow the directions.

For instructions on using the Dell Support, see "Technical Support and Customer Service" on page 64.



**NOTE:** Some of the following services are not always available in all locations outside the continental U.S. Call your local Dell representative for information on availability.

## Technical Support and Customer Service

Dell's support service is available to answer your questions about Dell™ hardware. Our support staff uses computer-based diagnostics to provide fast, accurate answers.

To contact Dell's support service, see "Before You Call" on page 67, and then see the contact information for your region or go to [support.dell.com](http://support.dell.com).

## Online Services

You can learn about Dell products and services at the following websites:

[www.dell.com](http://www.dell.com)

[www.dell.com/ap](http://www.dell.com/ap) (Asian/Pacific countries only)

[www.dell.com/jp](http://www.dell.com/jp) (Japan only)

[www.euro.dell.com](http://www.euro.dell.com) (Europe only)

[www.dell.com/la](http://www.dell.com/la) (Latin American and Caribbean countries)

[www.dell.ca](http://www.dell.ca) (Canada only)



You can access Dell Support through the following websites and e-mail addresses:

- Dell Support websites:

support.dell.com

support.apj.dell.com (Asia Pacific and Japan only)

support.jp.dell.com (Japan only)

support.euro.dell.com (Europe only)

- Dell Support e-mail addresses:

mobile\_support@us.dell.com

support@us.dell.com

suporte@dell.com (Brazil)

la-techsupport@dell.com (Latin America and Caribbean countries only)

apsupport@dell.com (Asian/Pacific countries only)

- Dell Marketing and Sales e-mail addresses:  
apmarketing@dell.com (Asian/Pacific countries only)  
sales\_canada@dell.com (Canada only)
- Anonymous file transfer protocol (FTP):  
ftp.dell.com – log in as user `anonymous`, and use your e-mail address as your password

## AutoTech Service

Dell's automated support service—AutoTech—provides recorded answers to the questions most frequently asked by Dell customers about their laptop and desktop computers.

When you call AutoTech, use your touch-tone telephone to select the subjects that correspond to your questions. For the telephone number to call for your region, see "Contacting Dell" on page 69.

### Automated Order-Status Service

To check on the status of any Dell products that you have ordered, you can go to [support.dell.com](http://support.dell.com), or you can call the automated order-status service. A recording prompts you for the information needed to locate and report on your order. For the telephone number to call for your region, see "Contacting Dell" on page 69.

### Problems With Your Order

If you have a problem with your order, such as missing parts, wrong parts, or incorrect billing, contact Dell for customer assistance. Have your invoice or packing slip available when you call. For the telephone number to call for your region, see "Contacting Dell" on page 69.

### Product Information

If you need information about additional products available from Dell, or if you would like to place an order, visit the Dell website at [www.dell.com](http://www.dell.com). For

the telephone number to call for your region or to speak to a sales specialist, see "Contacting Dell" on page 69.

### Returning Items for Warranty Repair or Credit

Prepare all items being returned, whether for repair or credit, as follows:

- 1 Call Dell to obtain a Return Material Authorization Number, and write it clearly and prominently on the outside of the box.

For the telephone number to call for your region, see "Contacting Dell" on page 69. Include a copy of the invoice and a letter describing the reason for the return.

- 2 Include a copy of the Diagnostics Checklist (see "Diagnostics Checklist" on page 68), indicating the tests that you have run and any error messages reported by the Dell Diagnostics (see "Contacting Dell" on page 69).

- 3 Include any accessories that belong with the item(s) being returned (power cables, software floppy disks, guides, and so on) if the return is for credit.
- 4 Pack the equipment to be returned in the original (or equivalent) packing materials.

You are responsible for paying shipping expenses. You are also responsible for insuring any product returned, and you assume the risk of loss during shipment to Dell. Collect On Delivery (C.O.D.) packages are not accepted.

Returns that are missing any of the preceding requirements will be refused at Dell's receiving dock and returned to you.

## Before You Call



**NOTE:** Have your Express Service Code ready when you call. The code helps Dell's automated-support telephone system direct your call more efficiently. You may also be asked for your Service Tag (located on the back or bottom of your computer).

Remember to fill out the Diagnostics Checklist (see "Diagnostics Checklist" on page 68). If possible, turn on your computer before you call Dell for assistance and call from a telephone at or near the computer. You may be asked to type some commands at the keyboard, relay detailed information during operations, or try other troubleshooting steps possible only at the computer itself. Ensure that the computer documentation is available.



**CAUTION:** Before working inside your computer, follow the safety instructions in the documentation that shipped with your computer.

### Diagnostics Checklist

Name:

Date:

Address:

Phone number:

Service Tag (bar code on the back or bottom of the computer):

Express Service Code:

Return Material Authorization Number (if provided by Dell support technician):

Operating system and version:

Devices:

Expansion cards:

Are you connected to a network? Yes No

Network, version, and network adapter:

Programs and versions:

See your operating system documentation to determine the contents of the system's start-up files. If the computer is connected to a printer, print each file. Otherwise, record the contents of each file before calling Dell.

Error message, beep code, or diagnostic code:

Description of problem and troubleshooting procedures you performed:

## Contacting Dell



**NOTE:** If you do not have an active Internet connection, you can find contact information on your purchase invoice, packing slip, bill, or Dell product catalog.

Dell provides several online and telephone-based support and service options. Availability varies by country and product, and some services may not be available in your area. To contact Dell for sales, technical support, or customer service issues:

- 1 Visit [support.dell.com](http://support.dell.com), and verify your country or region in the **Choose A Country/Region** drop-down menu at the bottom of the page.
- 2 Click **Contact Us** on the left side of the page, and select the appropriate service or support link based on your need.
- 3 Choose the method of contacting Dell that is convenient for you.



# Index

## B

- battery
  - removal, 12

## C

- connecting
  - AC adapter, 16
  - Internet, 17
  - network, 17
  - network cable, 16
  - USB devices, 16
- contacting Dell, 63, 69

## D

- Dell
  - contacting, 63, 69
  - software updates, 49
  - Support Utility, 49
  - technical support and customer service, 64
  - Technical Update Service, 49
- Dell Diagnostics, 42
  - starting from the Drivers and Utilities media, 43
  - starting from your hard drive, 42
- Dell Technology Guide, 61
- DellConnect, 64
- diagnostics
  - Dell, 42
- display
  - description, 9

## Index

documentation, 59

    Dell Technology Guide, 61

    Service Manual, 60–61

drivers, 51

    Drivers and Utilities media, 59

    identifying, 51

    reinstalling, 51

    returning to a previous version, 51

Drivers and Utilities media, 52, 59

    Dell Diagnostics, 42

## E

End User License Agreement (EULA), 60

ergonomics information, 60

Express Service Code, 59

## F

finding information, 59

## I

IEEE 1394 connector

    description, 10

Internet

    connecting, 17

## L

license label, 61

## M

media

    Drivers and Utilities, 59

memory

    troubleshooting, 46



**N**

network connector  
description, 11

networks  
connecting, 17

Notebook System Software, 59

**O**

operating system  
media, 55

operating system product key, 61

**P**

phone numbers, 69

power  
power light conditions, 44  
troubleshooting, 44

**R**

regulatory information, 60

reinstalling  
drivers and utilities, 51  
software, 51

**S**

S.M.A.R.T, 41

safety information, 60

security cable slot  
description, 11

Service Manual, 60–61

Service Tag, 59

setup  
computer, 15  
quick setup, 15

### software

- problems, 48
- reinstalling, 51
- troubleshooting, 48–49
- updates, 49

### specifications

- AC adapter, 30
- all, 21
- audio, 25
- battery, 28
- communications, 24
- display, 26
- environmental, 31
- keyboard, 27
- memory, 22
- physical, 31
- ports and connectors, 23
- processor, 21
- system information, 22
- touch pad, 28
- video, 25

### support, 63

- contacting Dell, 69
- DellConnect, 64
- online services, 64
- regional, 64
- technical support and customer service, 64

### support information, 60

## T

### Terms and Conditions, 60

### track stick/touch pad buttons

- description, 8

### troubleshooting, 33, 60

- blue screen, 48
- computer not responding, 47
- Dell Diagnostics, 42
- error messages, 33
- memory, 46
- power, 44
- power light conditions, 44
- program crashes, 47

troubleshooting (*continued*)  
    programs and Windows compatibility, 48  
    software, 47–49  
    tips, 44

## U

updates  
    software and hardware, 49

## V

view  
    back, 10  
    front, 7–8

## W

warranty information, 60  
Windows License label, 61

Windows Vista  
    Program Compatibility wizard, 48  
wizards  
    Program Compatibility wizard, 48



## Free Manuals Download Website

<http://myh66.com>

<http://usermanuals.us>

<http://www.somanuals.com>

<http://www.4manuals.cc>

<http://www.manual-lib.com>

<http://www.404manual.com>

<http://www.luxmanual.com>

<http://aubethermostatmanual.com>

Golf course search by state

<http://golfingnear.com>

Email search by domain

<http://emailbydomain.com>

Auto manuals search

<http://auto.somanuals.com>

TV manuals search

<http://tv.somanuals.com>