



Dell Precision™ T5500 Service Manual

[Working on Your Computer](#)
[Adding and Replacing Parts](#)
[Specifications](#)
[Diagnostics](#)
[About Memory](#)
[About Your System Board](#)
[System Setup](#)

Notes, Cautions, and Warnings

-  **NOTE:** A NOTE indicates important information that helps you make better use of your computer.
-  **CAUTION:** A CAUTION indicates potential damage to hardware or loss of data if instructions are not followed.
-  **WARNING:** A WARNING indicates a potential for property damage, personal injury, or death.

If you purchased a Dell™ n Series computer, any references in this document to Microsoft® Windows® operating systems are not applicable.

Information in this document is subject to change without notice.
© 2009 Dell Inc. All rights reserved.

Reproduction of this material in any manner whatsoever without the written permission of Dell Inc. is strictly forbidden.

Trademarks used in this text: *Dell*, the *DELL* logo, and *Dell Precision* are trademarks of Dell Inc.; *Intel* and *Xeon* are registered trademarks of Intel Corporation; *Bluetooth* is a registered trademark owned by Bluetooth SIG, Inc. and is used by Dell under license; *Blu-ray Disc* is a trademark of the Blu-ray Disc Association; *Microsoft*, *Windows*, *Windows Server*, *MS-DOS*, *Aero*, *Windows Vista*, and the *Windows Vista* start button are either trademarks or registered trademarks of Microsoft Corporation in the United States and/or other countries.

Other trademarks and trade names may be used in this document to refer to either the entities claiming the marks and names or their products. Dell Inc. disclaims any proprietary interest in trademarks and trade names other than its own.

Model DCTA

September 2009 Rev. A01

About Memory

Dell Precision™ T5500 Service Manual

- [Memory Modules](#)
- [Supported Memory Configurations](#)
- [Memory Subsystem](#)
- [Memory Slots](#)
- [Memory Population Rules](#)

WARNING: Before working inside your computer, read the safety information that shipped with your computer. For additional safety best practices information, see the Regulatory Compliance Homepage at www.dell.com/regulatory_compliance.

Your computer uses 1066 MHz and 1333MHz DDR3 unbuffered or registered ECC SDRAM memory. DDR3 SDRAM, or double-data-rate three synchronous dynamic random access memory, is a random access memory technology. It is a part of the SDRAM family of technologies, which is one of many DRAM (dynamic random access memory) implementations, and is an evolutionary improvement over its predecessor, DDR2 SDRAM.

The primary benefit of DDR3 SDRAM is its ability to run its I/O bus at four times the speed of the memory cells it contains, thus enabling faster bus speeds and higher peak throughputs than earlier technologies. This is achieved at the cost of higher latency. Also, the DDR3 standard allows for chip capacities of 512 megabit to 8 gigabit, effectively enabling memory modules of maximum 16 gigabyte in size.

DDR3 memory comes with a promise of a power consumption reduction of 30% compared to current commercial DDR2 modules due to DDR3's 1.5 V supply voltage. This supply voltage works well with the 90 nm fabrication technology used for most DDR3 chips. Some manufacturers further propose to use "dual-gate" transistors to reduce leakage of current.

The main benefit of DDR3 comes from the higher bandwidth made possible by DDR3's 8 bit deep prefetch buffer, whereas DDR2's is 4 bits, and DDR's is 2 bits deep.

Memory Modules

Standard name	Memory clock	Cycle time	I/O Bus clock	Data transfers per second	Module name	Peak transfer rate
DDR3-1066	133 MHz	7.5 ns	533 MHz	1066 Million	PC3-8500	8533 MB/s
DDR3-1333	166 MHz	6 ns	667 MHz	1333 Million	PC3-10600	10667 MB/s

Supported Memory Configurations

Single Processor Memory Configurations							
Size (GB)	DIMM Ranks	DIMM1	DIMM2	DIMM3	DIMM4	DIMM5	DIMM6
3	SR	1 GB	1 GB	1 GB			
4	SR	1 GB	1 GB	1 GB	1 GB		
4	MR	2 GB	1 GB	1 GB			
8	MR	2 GB	2 GB	2 GB	1 GB	1 GB	
12	SR	2 GB	2 GB	2 GB	2 GB	2 GB	2 GB
12	DR	4 GB	4 GB	4 GB			
24	DR	4 GB	4 GB	4 GB	4 GB	4 GB	4 GB
24	DR	8 GB	8 GB	8 GB			
32	MR	8 GB	8 GB	4 GB	4 GB	4 GB	4 GB
48	DR	8 GB	8 GB	8 GB	8 GB	8 GB	8 GB

Dual CPU Memory Configurations										
Size (GB)	DIMM Ranks	MB DIMM1	MB DIMM2	MB DIMM3	MB DIMM4	MB DIMM5	MB DIMM6	Riser DIMM1	Riser DIMM2	Riser DIMM3
3	SR	1 GB	1 GB					1 GB		
4	SR	1 GB	1 GB					1 GB	1 GB	
6	SR	1 GB	1 GB	1 GB				1 GB	1 GB	1 GB
8	MR	2 GB	1 GB	1 GB				2 GB	1 GB	1 GB
12	SR	2 GB	2 GB	2 GB				2 GB	2 GB	2 GB
24	DR	4 GB	4 GB	4 GB				4 GB	4 GB	4 GB
24	MR	2 GB	2 GB	2 GB	2 GB	2 GB	2 GB	4 GB	4 GB	4 GB
48	DR	8 GB	8 GB	8 GB				8 GB	8 GB	8 GB
48	MR	4 GB	4 GB	4 GB	4 GB	4 GB	4 GB	8 GB	8 GB	8 GB
64	MR	8 GB	8 GB	8 GB	8 GB	4 GB	4 GB	8 GB	8 GB	8 GB

72	DR	8 GB	8 GB	8 GB	8 GB	8 GB	8 GB	8 GB	8 GB	8 GB
----	----	------	------	------	------	------	------	------	------	------

NOTE: If more than one Quad rank DIMM is installed within a channel (DIMM1 & DIMM4, DIMM2 & DIMM5, DIMM3 & DIMM6) then the maximum DDR3 speed is reduced to 800 MHz. Spreading Quad Rank memory modules across multiple channels is recommended.

NOTE: DDR3 DIMMs have 240 pins, the same number as DDR2, and are the same size, but are electrically incompatible and have a different key notch location.

Memory Subsystem

The memory subsystem consists of three DDR3 memory channels attached to each processor. All single-processor configurations have six DIMM slots (two per channel) attached to the primary processor located on the system board. Dual-processor configurations require an optional riser card that contains the secondary processor and the DIMMs associated with the secondary processor. There are six DIMM slots on the riser, for a total of twelve DIMMs in the system.

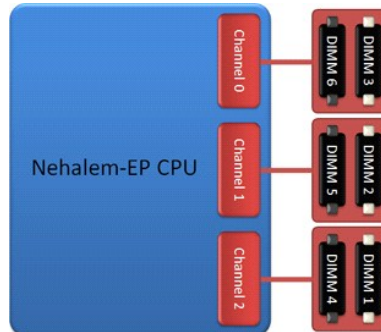

DIMM slot configuration for a single processor or a second processor on the riser.

Memory Slots

There are six memory slots on the system board. The slots are numbered DIMM1 through DIMM6. DIMM1 is furthest from the processor.



In addition, the dual-processor riser features three additional memory slots. The slots are numbered DIMM1 through DIMM3. DIMM1 is furthest from the processor.

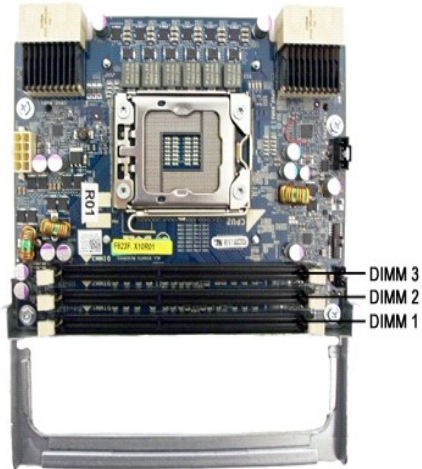

Memory Population Rules

Your computer requires DIMMs within a channel to be populated starting with the DIMMs farthest from the processor first. This means the DIMM slots 1, 2 and 3 must be populated before DIMM slots 4, 5 and 6. In addition, when populating a Quad-rank DIMM with a Single- or Dual-rank DIMM in the same channel, the Quad-rank DIMM must be populated farthest from the CPU.

To maximize available memory bandwidth, DIMMs within a configuration should generally be spread across as many channels as possible before populating multiple DIMMs per channel. The population guidelines below help to achieve this.

Single CPU configurations (6 DIMM slots on MB)

- 1 If configuration contains DIMMs of all the same size, populate in the following order: DIMM1, DIMM2, DIMM3, DIMM4, DIMM5, DIMM6
- 1 If configuration contains DIMMs of mixed sizes, populate the larger DIMMs first. For example, for a 4GB configuration consisting of one 2GB DIMM and two 1GB DIMMs, the population would be DIMM1=2GB, DIMM2=1GB, DIMM3=1GB, DIMM4=empty, DIMM5=empty, DIMM6=empty.

Dual CPU configurations (6 DIMM slots on MB plus 3 DIMM slots on Riser)

- 1 If configuration contains DIMMs of all the same size, populate in the following order: MB_DIMM1, Riser_DIMM1, MB_DIMM2, Riser_DIMM2, MB_DIMM3, Riser_DIMM3, MB_DIMM4, MB_DIMM5, MB_DIMM6.
- 1 If configuration contains DIMMs of mixed sizes, populate the larger DIMMs in the Riser.

NOTE: If any DIMMs are >30mm tall (possibly early 16GB DIMMs), they must be installed on the system board only.

About Your System Board

Dell Precision™ T5500 Service Manual

- [System Board Schematic](#)
- [Clearing Forgotten Passwords](#)
- [Clearing CMOS Settings](#)

System Board Schematic

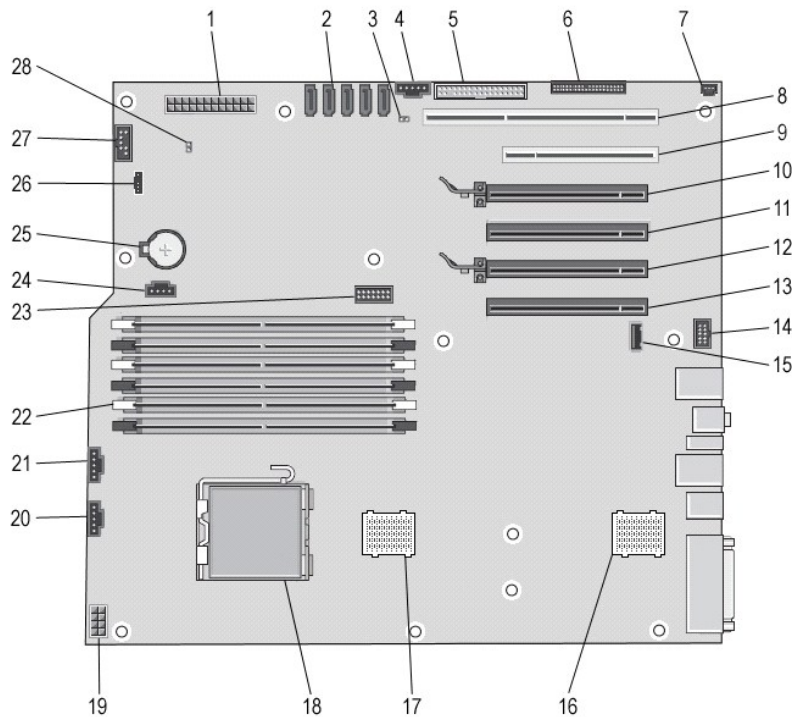

1	Main Power Connector (POWER1)	15	Type A USB Port (INT_USB2)
2	SATA Connectors (SATA0-4)	16	CPU Riser 2 (CPU2_RSR2)
3	Password Jumper (PSWD)	17	CPU Riser 1 (CPU_RSR1)
4	Hard Drive Fan Connector (FAN_HDD)	18	>Primary Processor Connector (CPU1)
5	Floppy Drive (DSKT)	19	Power Connector (POWER_CPU1)
6	Front Panel Connector (FRONTPANEL)	20	Front Fan Connector (FAN_FRONT)
7	Chassis Intrusion Header (INTRUDER)	21	Card Cage Fan (FAN_CCAG)
8	PCI-X Card Slot (SLOT6)	22	Memory Module Connectors (DIMM1-6)
9	PCI Card Slot (SLOT5)	23	Optional Serial/PS2 Connector (SERIAL2)
10	PCI Express 2.0 x16 Card Slot (SLOT4)	24	Auxiliary Hard-drive LED Connector (AUX_LED)
11	PCI Express 2.0 x16 Card Slot, wired as x8 (SLOT3)	25	Battery Socket (BATTERY)
12	PCI Express 2.0 x16 Card Slot (SLOT2)	26	Internal Speaker Connector (INT_SPKR)
13	PCI Express 2.0 x16 Card Slot, wired as x8 (SLOT1)	27	Flexbay USB (INT_USB)
14	Front Panel Audio Connector (FP_AUDIO)	28	RTC Reset Jumper (RTCST)

WARNING: Before working inside your computer, read the safety information that shipped with your computer. For additional safety best practices information, see the Regulatory Compliance Homepage at www.dell.com/regulatory_compliance.

Clearing Forgotten Passwords

1. Remove the computer cover.
2. Locate the 4-pin password connector (PSWD) on the system board.
3. Remove the 2-pin jumper plug from pins 3 and 4 and set the jumper plug aside.
4. Replace the computer cover.
5. Connect your keyboard and mouse, then connect your computer and monitor to electrical outlets and turn them on.
6. After the operating system loads, turn the computer off.

Ensure that the computer is off and not in a power management mode. If you cannot shut down the computer using the operating system, press and hold the power button for 4 seconds.

 **NOTE:** Ensure that the computer is off and not in a power management mode. If you cannot shut down the computer using the operating system, press and hold the power button for 6 seconds.

7. Disconnect the keyboard and mouse, then disconnect the computer and monitor from their electrical outlets.
8. Press the power button on the computer to ground the system board.
9. Remove the computer cover.
10. Replace the 2-pin jumper plug onto pins 3 and 4 of the password connector (RTCRST_PSWD) on the system board.

 **NOTE:** The password jumper plug must be reinstalled on the password jumper pins in order to enable the password feature.

11. Connect your computer and devices to electrical outlets, and then turn them on.

 **NOTE:** In System Setup, both system and administrator password options appear as Not Set. The password feature is enabled, but a password is not assigned.

Clearing CMOS Settings

 **WARNING:** Before working inside your computer, read the safety information that shipped with your computer. For additional safety best practices information, see the Regulatory Compliance Homepage at www.dell.com/regulatory_compliance.

 **NOTE:** The computer must be disconnected from the electrical outlet to clear the CMOS setting.

1. Remove the computer cover.
2. Locate the 4-pin password connector (PSWD) on the system board.
3. Remove the 2-pin jumper plug from pins 3 and 4.
4. Locate the 4-pin CMOS jumper (RTCRST) on the system board.
5. Move the 2-pin jumper plug from the password jumper to pins 1 and 2 of the CMOS jumper.
6. Plug in AC power to the system and wait ten seconds for the CMOS to clear.
7. Move the 2-pin jumper plug back to pins 3 and 4 of the password jumper.
8. Replace the computer cover.
9. Connect your computer and devices to electrical outlets, and turn them on.

 **NOTE:** You can use the RTCRST jumper procedure above to attempt recovery from a No POST, No Video situation.

System Setup

Dell Precision™ T5500 Service Manual

- [POST Keystrokes](#)
- [Boot Menu](#)
- [Entering System Setup](#)
- [System Setup Navigation Keystrokes](#)

POST Keystrokes

Your computer has several keystroke options available during the POST process at the Dell™ Logo screen.

Keystroke	Function	Description
< F2>	Enter System Setup	Use System Setup to make changes to the user-definable settings.
< F12> or <Ctrl><Alt><F8>	Enter Boot Menu	One-time boot and diagnostics utility menu
< F3>	Network Boot	Bypass the BIOS boot sequence and boot directly to the network

Boot Menu



As with previous Dell Precision™ workstation platforms, your computer includes a one-time boot menu. This feature offers a quick and convenient method with which to bypass the System Setup-defined boot device order and boot directly to a specific device (e.g., floppy, CD-ROM, or hard drive).

The boot menu enhancements introduced on previous platforms are as follows:

- 1 **Easier access**—Although the <Ctrl><Alt><F8> keystroke still exists and can be used to call up the menu, you can also simply press <F12> during system boot to access the menu.
- 1 **Diagnostics options**—The boot menu includes two diagnostic options, IDE Drive Diagnostics (90/90 Hard Drive Diagnostics) and Boot to the Utility Partition.

Entering System Setup

Press <F2> to enter System Setup and change the user-definable settings. If you have trouble entering System Setup using this key, press <F2> when the keyboard lights first flash.

Follow the on-screen instructions to view and/or change any settings. On each screen, the system setup options are listed at the left. To the right of each option is the setting or value for that option. You can change settings that appear as white type on the screen. Options or values that you cannot change (because they are determined by your Tablet-PC) appear less bright.

The upper-right corner of the screen displays help information for the currently highlighted option. The lower-right corner displays information about the computer. System setup key functions are listed across the bottom of the screen.

The system setup screens display the current setup information and settings for your computer, such as:

- 1 System configuration
- 1 Boot order
- 1 Boot (start-up) configuration
- 1 Basic device configuration settings
- 1 System security and hard drive password settings

System Setup Navigation Keystrokes

Use the following keystrokes to navigate the BIOS screens.

Navigation Keystrokes	
Action	Keystroke
Expand and collapse field	<Enter>, left- and right-arrow keys, or +/-
Expand or collapse all fields	< >

Exit BIOS	<Esc>—Remain in Setup, Save/Exit, Discard/Exit
Change a setting	Left- and right-arrow keys
Select field to change	<Enter>
Cancel a modification	<Esc>
Reset defaults	<Alt><F> or Load Defaults menu option

 **NOTE:** Depending on your computer and any installed devices, the items listed in this section may or may not appear.

Diagnostics

Dell Precision™ T5500 Service Manual

- [Dell Diagnostics](#)
 - [Power Button Light Codes](#)
 - [Diagnostic Light Codes](#)
 - [Pre-POST Diagnostic Light Patterns](#)
 - [POST Diagnostic Light Patterns](#)
 - [Beep Codes](#)
-

Dell Diagnostics

When to Use the Dell Diagnostics

It is recommended that you print these procedures before you begin.

 **NOTE:** The Dell Diagnostics software works only on Dell computers.

 **NOTE:** The *Drivers and Utilities* disc is optional and may not ship with your computer.

Enter system setup (see [Entering System Setup](#)), review your computer's configuration information, and ensure that the device you want to test displays in System Setup and is active.

Start the Dell Diagnostics from either your hard drive or from the *Drivers and Utilities* disc.

Starting the Dell Diagnostics From Your Hard Drive

1. Turn on (or restart) your computer.
2. When the DELL logo appears, press <F12> immediately.

 **NOTE:** If you see a message stating that no diagnostics utility partition has been found, run the Dell Diagnostics from your *Drivers and Utilities* disc.

If you wait too long and the operating system logo appears, continue to wait until you see the Microsoft® Windows® desktop. Then shut down your computer (see [Turning Off Your Computer](#)), and try again.

3. When the boot device list appears, highlight **Boot to Utility Partition** and press <Enter>.
4. When the Dell Diagnostics **Main Menu** appears, select the test that you want to run.

Starting the Dell Diagnostics From the Drivers and Utilities Disc

1. Insert the *Drivers and Utilities* disc.
2. Shut down and restart the computer.

When the DELL logo appears, press <F12> immediately.

If you wait too long and the Windows logo appears, continue to wait until you see the Windows desktop. Then shut down your computer and try again.

 **NOTE:** The next steps change the boot sequence for one time only. On the next startup, the computer boots according to the devices specified in the system setup program.

3. When the boot device list appears, highlight **Onboard or USB CD-ROM Drive** and press <Enter>.
4. Select the **Boot from CD-ROM** option from the menu that appears and press <Enter>.
5. Type 1 to start the menu and press <Enter> to proceed.
6. Select **Run the 32 Bit Dell Diagnostics** from the numbered list. If multiple versions are listed, select the version appropriate for your computer.
7. When the Dell Diagnostics **Main Menu** appears, select the test you want to run.

Dell Diagnostics Main Menu

1. After the Dell Diagnostics loads and the **Main Menu** screen appears, click the button for the option you want.

Option	Function
Express Test	Performs a quick test of devices. This test typically takes 10 to 20 minutes and requires no interaction on your part. Run Express Test first to increase the possibility of tracing the problem quickly.
Extended Test	Performs a thorough check of devices. This test typically takes 1 hour or more and requires you to answer questions periodically.
Custom Test	Tests a specific device. You can customize the tests you want to run.
Symptom Tree	Lists the most common symptoms encountered and allows you to select a test based on the symptom of the problem you are having.





- If a problem is encountered during a test, a message appears with an error code and a description of the problem. Write down the error code and problem description and follow the instructions on the screen.
- If you run a test from the **Custom Test** or **Symptom Tree** option, click the applicable tab described in the following table for more information.

Tab	Function
Results	Displays the results of the test and any error conditions encountered.
Errors	Displays error conditions encountered, error codes, and the problem description.
Help	Describes the test and may indicate requirements for running the test.
Configuration	Displays your hardware configuration for the selected device. The Dell Diagnostics obtains configuration information for all devices from system setup, memory, and various internal tests, and it displays the information in the device list in the left pane of the screen. The device list may not display the names of all the components installed on your computer or all devices attached to your computer.
Parameters	Allows you to customize the test by changing the test settings.

- When the tests are completed, if you are running the Dell Diagnostics from the *Drivers and Utilities* disc, remove the disc.
- Close the test screen to return to the **Main Menu** screen. To exit the Dell Diagnostics and restart the computer, close the **Main Menu** screen.

Power Button Light Codes

The diagnostic lights give much more information about the system state, but legacy power light states are also supported in your computer. The power light states are shown in following table.

Power Light State	Description
Off 	Power is off, light is blank.
Blinking Amber 	Initial state of light at power up. Indicates system has power, but the POWER_GOOD signal is not yet active. If the Hard Drive light is off , it is probable that the power supply needs to be replaced. If the Hard Drive light is on , it is probable that an onboard regulator or VRM has failed. Look at the diagnostic lights for further information.
Solid Amber 	Second state of the light at power up. Indicates the POWER_GOOD signal is active and it is probable that the power supply is fine. Look at the diagnostic lights for further information.
Blinking Green 	System is in a low power state, either S1 or S3. Look at the diagnostic lights to determine which state the system is in.
Solid Green 	System is in S0 state, the normal power state of a functioning machine. The BIOS will turn the light to this state to indicate it has started fetching opcodes.









Diagnostic Light Codes



Four (4) single color lights are incorporated on the front control panel to serve as a diagnostic aid for troubleshooting systems exhibiting No Post/No Video symptoms. The lights do NOT report runtime errors.

Each light has two possible states of OFF or ON. The most significant bit is labeled with the number 1, and the other three are labeled 2, 3, and 4, as you go down or across the LED stack. The normal operating condition after POST is for all four lights to be ON and then turn off as the BIOS hands over control to the operating system.

Pre-POST Diagnostic Light Patterns







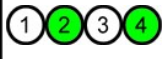

State	Light Pattern (1 2 3 4)	Light Description	Power Light	State Assignment	State Description
Pb0a		1- Off 2- Off 3- Off 4- Off		System Unplugged	System is not plugged into AC, PSU is not plugged into system board, or control panel not connected to system board.
Pb0b		1- Off 2- Off 3- Off 4- Off		ACPI S0: Normal Operation	System is on with no failures detected. This is actually a BIOS controlled state and is also S0e.
Pb0c		1- Off 2- Off 3- Off 4- Off		ACPI S1	Windows Standby State.
Pb1		1- Off 2- Off 3- Off 4- Off		ACPI S4 or S5	Hibernate or Soft off. System plugged in, but either turned off or in Windows Hibernation State.

Pb2		1- Off 2- Off 3- Solid 4- Off	-	Reserved	Reserved
Pb3		1- Off 2- Off 3- Solid 4- Solid		ACPI S3	Suspend to RAM Windows Standby State.
Pb4		1- Off 2- Green 3- Off 4- Off	-	Reserved	Reserved
Pb5		1- Off 2- Green 3- Off 4- Green	-	Reserved	Reserved
Pb6		1- Off 2- Green 3- Green 4- Off	-	Reserved	Reserved
Pb7		1- Off 2- Blink 3- Blink 4- Blink		ACPI S0, hand off to BIOS control	System on. BIOS not execution. This is the transition state to POST states.
Pb8		1- Green 2- Off 3- Off 4- Off	-	Reserved	Reserved
Pb9		1- Blink 2- Off 3- Off 4- Blink		Non-System board Regulator Failure	A power failure has been detected on a plug-in component such as VRM, Video Riser, or Memory Riser.
Pb10		1- Blink 2- Off 3- Blink 4- Off		PSU Failure	PSU may be bad or PSU cable may be crimped creating a short on a main power rail. (PS_ON asserted, PS_PWRGOOD not asserted)
Pb11		1- Blink 2- Off 3- Blink 4- Blink		PSU Cable Failure	All PSU cables may not be properly connected to system board. (PS_ON asserted, missing a main power rail)
Pb12		1- Blink 2- Blink 3- Off 4- Off		System board Regulator Failure	A power failure has been detected in one of the onboard system board regulators. This could be caused by a failed system board component or by a plug-in device creating a short on a regulated power rail. (PS_ON asserted, PS_PWRGOOD asserted, SYS_PWRGOOD de-asserted)
Pb13		1- Blink 2- Blink 3- Off 4- Blink		Mismatch	Hardware detected a population incompatibility with a critical system component such as CPU, VRM, PSU, or MEMORY RISER.
Pb14		1- Green 2- Green 3- Green 4- Off	-	Reserved	Reserved
Pb15		1- Green 2- Green 3- Green 4- Green	-	Reserved	Reserved

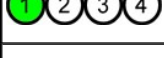
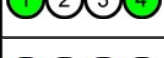
POST Diagnostic Light Patterns

All POST codes except S0 are accompanied by a Solid Green Power light state. If the power light is not green, see [Pre-POST Diagnostic Light Patterns](#).

State	Light Pattern (1 2 3 4)	Light Description	State Name	State Assignment	State Description
S0a		1- Off 2- Off 3- Off 4- Off	OFF	OFF	Power light Off. No power is supplied to the system.
S0e		1- Off 2- Off 3- Off 4- Off	ON	Normal Operation, ACPI S0	Power light Solid Green. System has successfully booted and is operating normally.
S1		1- Off 2- Off 3- Off 4- Solid	RCM	System is in Recovery Mode	BIOS checksum failure was detected and the system is now in recovery mode.
S2		1- Off 2- Off 3- Solid 4- Off	CPU	CPU	CPU configuration activity is in progress or a CPU failure was detected.
S3		1- Off 2- Off 3- Solid 4- Solid	MEM	Memory	Memory subsystem configuration activity is in progress. Appropriate memory modules were detected but a memory failure has occurred.
S4		1- Off 2- Solid 3- Off 4- Off	PCI	PCI device	PCI device configuration activity is in progress or PCI device failure was detected.

S5		1- Off 2- Solid 3- Off 4- Solid	VID	Video Card	Video subsystem configuration activity in progress or video subsystem failure.
S6		1- Off 2- Solid 3- Solid 4- Off	STO	Storage	Storage device configuration in progress or storage subsystem failure.
S7		1- Off 2- Solid 3- Solid 4- Solid	USB	USB	USB subsystem configuration activity in progress or USB subsystem failure.
S8		1- Solid 2- Off 3- Off 4- Off	MEM	Memory	Memory subsystem configuration activity is in progress. No memory modules were detected.
S9		1- Solid 2- Off 3- Off 4- Solid	MBF	System board	Fatal system board failure detected.
S10		1- Solid 2- Off 3- Solid 4- Off	MEM	Memory	Memory subsystem configuration activity is in progress. Memory modules have been detected but appear to be incompatible or in an invalid configuration.
S11		1- Solid 2- Off 3- Solid 4- Solid	PRV	Other pre-video activity	Indicates routine system activity preceding video initialization.
S12		1- Solid 2- Solid 3- Off 4- Off	CFG	Resource configuration	System resource configuration in progress.
S13		1- Solid 2- Solid 3- Off 4- Solid		Reserved	Reserved for future use. This pattern is being considered to indicate the Visual Off state on the Dimension systems.
S14		1- Solid 2- Solid 3- Solid 4- Off	POV	Other post-video activity	Indicates routine system activity subsequent to video initialization.
S15		1- Solid 2- Solid 3- Solid 4- Solid	STD	Boot hand off	Indicates End of POST process. Lights are normally in this state briefly as POST completes. Once the hand-off to the OS is done, the lights turn off and transition to S0e state.

Beep Codes

When errors occur during a boot routine that cannot be reported on the monitor, the computer may emit a beep code that identifies the problem. The beep code is a pattern of sounds: for example, one beep followed by a second beep, then followed by a burst of three beeps (code 1-1-3) means that the computer was unable to read the data in nonvolatile random-access memory (NVRAM). If the system loses power and beeps constantly when you turn it back on, the BIOS is probably corrupted.

System Beep Codes			
Beep Code	Description	Beep Code	Description
1-1-2	CPU register test in progress	2-4-3	1st 64 K RAM chip or data line failure - bit E
1-1-3	CMOS read/write test in progress or failure	2-4-4	1st 64 K RAM chip or data line failure - bit F
1-1-4	BIOS ROM checksum in progress or failure	3-1-1	Slave DMA register test in progress or failure
1-2-1	Timer Test in progress or failure	3-1-2	Master DMA register test in progress or failure
1-2-2	DMA initialization in progress or failure	3-1-3	Master IMR test in progress or failure
1-2-3	DMA page register read/write test in progress or failure	3-1-4	Slave IMR test in progress or failure
1-3-1	RAM refresh verification in progress or failure	3-2-2	Interrupt vector loading in progress
1-3-2	1st 64 K RAM test in progress or failure	3-2-4	Keyboard controller test in progress or failure
1-3-3	1st 64 K RAM chip or data line failure (multi bit)	3-3-1	CMOS power fail and checksum test in progress
1-3-4	1st 64 K RAM odd/even logic failure	3-3-2	CMOS Config info validation in progress
1-4-1	1st 64 K RAM address line failure	3-3-3	RTC/Keyboard controller not found
1-4-2	1st 64 K RAM parity test in progress or failure	3-3-4	Screen memory test in progress or failure
1-4-3	Fail-safe timer test in progress	3-4-1	Screen initialization test in progress or failure
1-4-4	Software NMI port test in progress	3-4-2	Screen retrace tests test in progress or failure
2-1-1	1st 64 K RAM chip or data line failure - bit 0	3-4-3	Search for video ROM in progress
2-1-2	1st 64 K RAM chip or data line failure - bit 1	4-2-1	Timer tick interrupt test in progress or failure
2-1-3	1st 64 K RAM chip or data line failure - bit 2	4-2-2	Shutdown test in progress or failure
2-1-4	1st 64 K RAM chip or data line failure - bit 3	4-2-3	Gate A20 failure

2-2-1	1st 64 K RAM chip or data line failure - bit 4	4-2-4	Unexpected interrupt in Protected Mode
2-2-2	1st 64 K RAM chip or data line failure - bit 5	4-3-1	RAM test in progress or failure above address 0FFFFh
2-2-3	1st 64 K RAM chip or data line failure - bit 6	4-3-2	No memory in Bank 0
2-2-4	1st 64 K RAM chip or data line failure - bit 7	4-3-3	Interval Timer Channel 2 test in progress or failure
2-3-1	1st 64 K RAM chip or data line failure - bit 8	4-3-4	Time-Of-Day Clock test in progress or failure
2-3-2	1st 64 K RAM chip or data line failure - bit 9	4-4-1	Super I/O chip failure
2-3-3	1st 64 K RAM chip or data line failure - bit A	4-4-4	Cache test failure
2-3-4	1st 64 K RAM chip or data line failure - bit B		
2-4-1	1st 64 K RAM chip or data line failure - bit C		
2-4-2	1st 64 K RAM chip or data line failure - bit D		

Adding and Replacing Parts



Dell Precision™ T5500 Service Manual

- [Cover](#)
 - [Battery](#)
 - [Drives Bezel](#)
 - [Hard Drive Tray](#)
 - [Front Fan Assembly](#)
 - [Memory Card Reader](#)
 - [Memory](#)
 - [Dual Processor Riser \(Optional\)](#)
 - [System Board](#)
 - [I/O Data Cable](#)
 - [Chassis Intrusion Switch](#)
 - [Front Bezel](#)
 - [Hard Drive](#)
 - [Floppy Drive](#)
 - [Optical Drive](#)
 - [Expansion Cards](#)
 - [Heat Sink and Processor](#)
 - [Power Supply](#)
-

Specifications

Dell Precision™ T5500/T5500n Service Manual

- [Processors](#)
- [System Information](#)
- [Memory](#)
- [Video](#)
- [Audio](#)
- [Expansion Bus](#)
- [Drives](#)
- [Connectors](#)
- [Controls and Lights](#)
- [Power](#)
- [Physical](#)
- [Environmental](#)

 **NOTE:** Offerings may vary by region. For more information regarding the configuration of your Tablet-PC, click **Start**  (or **Start** in Windows XP)  **Help and Support**, and then select the option to view information about your Tablet-PC.

Processor	
Processor types	Dual-Core Intel® Xeon® Processor 5500 series Quad-Core Intel® Xeon® Processor 5500 series

System Information	
System chipset	Intel 5500/5520
Data bus width	64 bits

Memory	
Memory module connectors	Six Nine with optional riser
Memory module capacities	1 GB, 2 GB, 4 GB, or 8 GB
Memory type	DDR3 1066 MHz SDRAM DDR3 1333 MHz SDRAM (DDR3 800 MHz capable)
Minimum memory	1 GB
Maximum memory	48 GB 72 GB with optional riser

Video	
Video type:	
Discrete	PCI Express 2.0 x16 (two slots) NOTE: Support for two full height, full length graphics cards using the PCIe x16 graphics card slot.

Audio	
Audio type	ADI1984A integrated audio

Expansion Bus	
Bus type	PCI Express 2.0 PCI 2.3 PCI-X 2.0A SATA 1.0 and 2.0 eSATA 2.0 USB 2.0
Bus speed	133 MB/s (PCI) x1-slot bidirectional speed - 500 MB/s (PCI Express) x16-slot bidirectional speed - 8 GB/s (PCI Express) 1.5 Gbps and 3.0 Gbps (SATA) 480-Mbps high speed, 12-Mbps full speed, 1.2-Mbps low speed (USB)
Two PCI Express 2.0 x16 slots (video)	
Connector pins	164 pins
Connector data width (maximum)	16 PCI Express lanes (each direction)
Two PCI Express 2.0 x8 slots (physical x16 connector)	
Connector pins	164 pins
Connector data width (maximum)	8 PCI Express lanes (each direction)
One PCI slot	
Connector pins	120 pins
Connector data width (maximum)	32 bits
One PCI-X slot	
Connector pins	188 pins
Connector data width (maximum)	64 bits

Drives	
Externally accessible	One 3.5-inch drive bay (FlexBay) Two 5.25-inch drive bays
Internally accessible	Two 3.5-inch SATA drive bays
Available devices	Up to two of the following 5.25-inch devices: SATA DVD-ROM/CD-RW Combo, DVD +/- RW Blu-ray™ drive, HD/DVD Combo Blu-ray drive One 3.5-inch USB media card reader internal 1.44 MB 3.5 inch drive external USB 3.5 inch drive internal USB Flash Reader Up to four 3.5 inch SATA or SAS hard drives (hard drives may be placed in 5.25 inch bays with an optional adapter)

Connectors	
External connectors:	
Video	(Depending on video card) DVI connector Display port
Network adapter	RJ-45 connector
USB	USB 2.0 compliant Two internal connectors Two in front Six at the back
Audio	Stereo support integrated (5.1 channel support) NOTE: 5.1 channel support comes from an add-in card only.
Serial	One 9-pin connector; 16550C-compatible
PS/2	Two 6-pin mini-DIN connectors
System board connectors:	
Serial ATA	Five 7-pin SATA connectors
Internal USB device	One 10-pin connector that can support two USB ports
Fans:	
Front fan	One 7-pin connector
Card cage fan	One 7-pin connector
HDD fan	One 5-pin connector
PCI	One 120-pin connector
PCI-X	One 188-pin connector
PCI Express x8	Two 164-pin connectors (physical x16 connector)
PCI Express x16	Two 164-pin connectors
Front panel control (USB included)	One 10-pin connector
Front panel audio HDA header	One 10-pin connector
Processor	One connector Second connector on optional riser
Memory	Six 240-pin connectors Three 240-pin connectors on optional riser
Power 12 V	One 4-pin connector Second 4-pin connector on optional riser
Power	One 24-pin connector

Controls and Lights	
Front of the computer	
Power button	Push button
Power light	Amber light Solid amber indicates a problem with an installed device; blinking amber indicates an internal power problem Green light Blinking green in sleep state; solid green for power-on state
Drive activity light	Green light A blinking green light indicates the computer is reading data from or writing data to the SATA hard drive or CD/DVD
Link integrity light	Green light Solid green indicates a connection to an active network Off (no light) System is not connected to a network
Back of the computer	
Link integrity light (on integrated network adapter)	Green A good connection at 10Mbps exists between the network and the computer Orange A good connection at 100Mbps exists between the network and the computer Yellow A good connection at 1000Mbps exists between the network and the computer Off The computer is not detecting a physical connection to the network

Network activity light (on integrated network adapter)	Yellow blinking light
--	-----------------------

Power	
DC power supply:	
Wattage	875 W
Voltage	100 240 VAC, 50 60 Hz, 12.0 A
Coin-cell battery	3V CR2032 lithium coin cell

Physical	
Height	44.80 cm (17.60 inches)
Width	17.25 cm (6.80 inches)
Depth	46.83 cm (18.40 inches)
Weight	17.20 kg (38 lbs)

Environmental	
Temperature range:	
Operating	10° to 35°C (50° to 95°F)
Storage	-40° to 65°C (-40° to 149°F)
Relative humidity (maximum):	20% to 80% (noncondensing)
Maximum vibration:	
Operating	5 to 350 Hz at 0.0002 G ² /Hz
Storage	5 to 500 Hz at 0.001 to 0.01 G ² /Hz
Maximum shock:	
Operating	40 G +/- 5% with pulse duration of 2 msec +/- 10% (equivalent to 51 cm/sec [20 in/sec])
Storage	105 G +/- 5% with pulse duration of 2 msec +/- 10% (equivalent to 127 cm/sec [50 in/sec])
Altitude (maximum):	
Operating	-15.2 to 3048 m (-50 to 10,000 ft)
Storage	-15.2 to 10,668 m (-50 to 35,000 ft)
Airborne contaminant level	G2 or lower as defined by ISA-S71.04-1985

Battery

Dell Precision™ T5500 Service Manual

⚠ WARNING: Before working inside your computer, read the safety information that shipped with your computer. For additional safety best practices information, see the Regulatory Compliance Homepage at www.dell.com/regulatory_compliance.

Removing the Battery



1. Follow the procedures in [Before Working Inside Your Computer](#).
2. Remove the computer [cover](#).



4. Use a small screw driver or a scribe to press down the coin-cell release tab.



5. Remove the coin-cell from the computer.



Cover

Dell Precision™ T5500 Service Manual

⚠ WARNING: Before working inside your computer, read the safety information that shipped with your computer. For additional safety best practices information, see the Regulatory Compliance Homepage at www.dell.com/regulatory_compliance.

Removing the Cover

1. Follow the procedures in [Before Working Inside Your Computer](#).

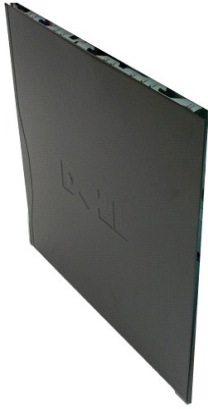

2. Slide the cover release latch toward the back of the computer.



3. Draw the cover away from the computer.



4. Remove the cover from the computer.



Hard-drive Bezel

Dell Precision™ T5500 Service Manual

⚠ WARNING: Before working inside your computer, read the safety information that shipped with your computer. For additional safety best practices information, see the Regulatory Compliance Homepage at www.dell.com/regulatory_compliance.

Removing the Hard-drive Bezel



1. Follow the procedures in [Before Working Inside Your Computer](#).
2. Remove the computer [cover](#).



3. Press and hold the sliding-plate lever toward the base of the computer to release the drives bezel.

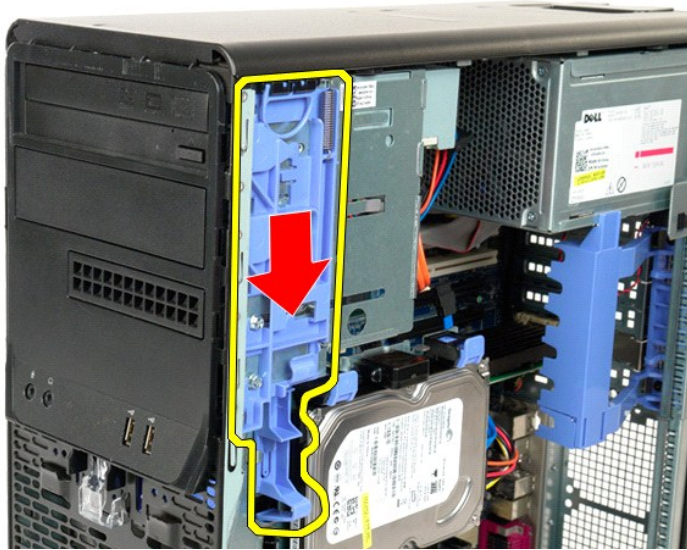

4. Remove the hard drive bezel.





Front Bezel

Dell Precision™ T5500 Service Manual

⚠ WARNING: Before working inside your computer, read the safety information that shipped with your computer. For additional safety best practices information, see the Regulatory Compliance Homepage at www.dell.com/regulatory_compliance.

Removing the Front Bezel



1. Follow the procedures in [Before Working Inside Your Computer](#).
2. Remove the computer [cover](#).



3. Pull up on the front bezel release tab.

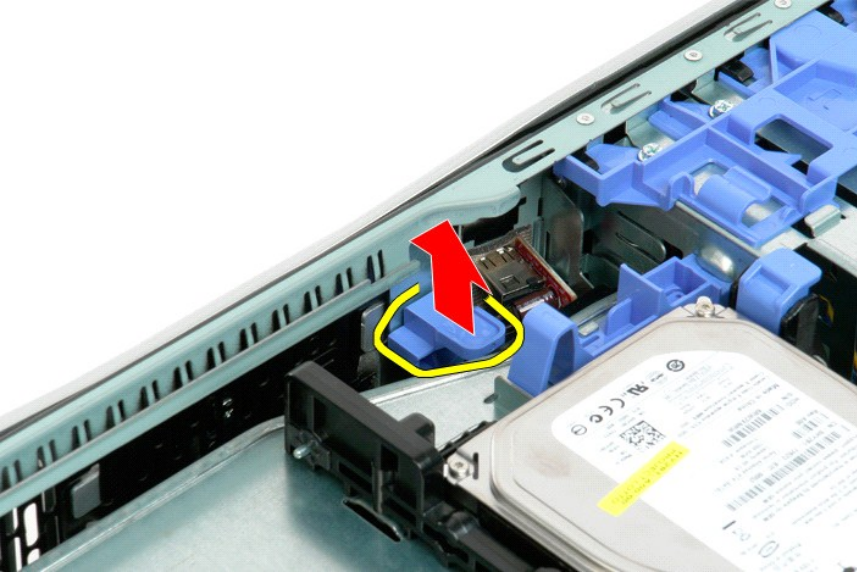

4. Slide the front bezel toward the top of the computer.

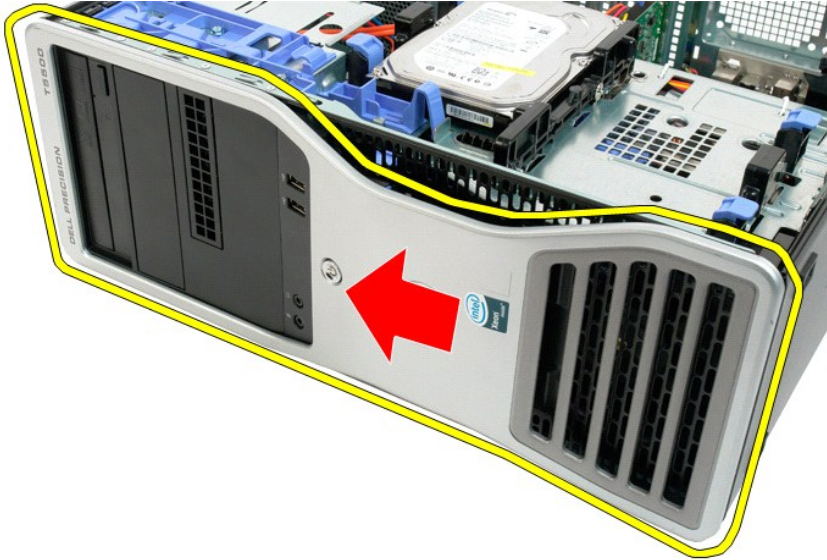

5. Remove the front bezel from the computer.



Front Fan Assembly

Dell Precision™ T5500 Service Manual

⚠ WARNING: Before working inside your computer, read the safety information that shipped with your computer. For additional safety best practices information, see the Regulatory Compliance Homepage at www.dell.com/regulatory_compliance.

Removing the Front Fan Assembly



1. Follow the procedures in [Before Working Inside Your Computer](#).
2. Remove the [computer cover](#).
3. Open the [hard drive tray](#).
4. Remove the [memory shroud](#).



5. Disconnect the two fan cables from the system board.



6. Remove the screw that secures the front fan assembly.



7. Remove the fan assembly from the computer

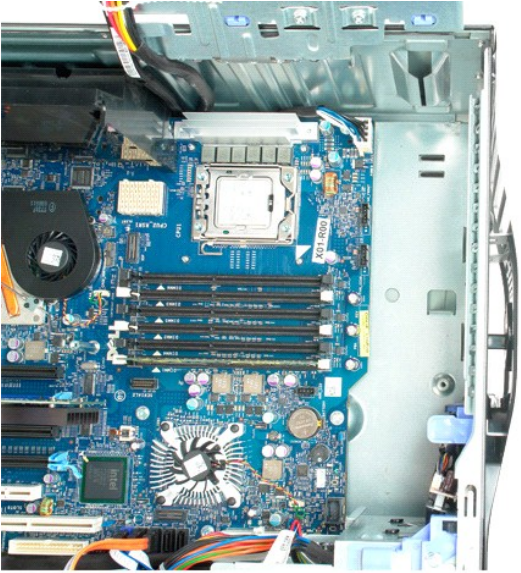
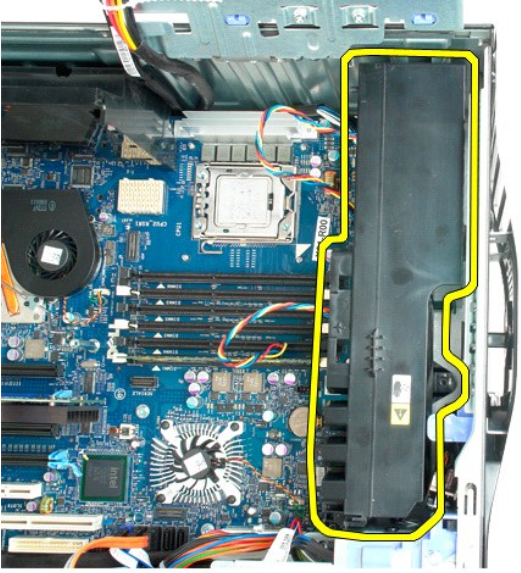

Floppy Drive

Dell Precision™ T5500 Service Manual

 **WARNING:** Before working inside your computer, read the safety information that shipped with your computer. For additional safety best practices information, see the Regulatory Compliance Homepage at www.dell.com/regulatory_compliance.

Removing the Floppy Drive

1. Follow the procedures in [Before Working Inside Your Computer](#).
2. Remove the [computer cover](#).
3. Remove the [front bezel](#).
4. Remove the [drives bezel](#).
5. Disconnect the power and data cables from the back of the floppy drive.
6. Push the sliding plate lever down to release the floppy drive.
7. Remove the floppy drive from the computer.

Replacing the Floppy Drive

1. Follow the procedures in [Before Working Inside Your Computer](#).
2. Remove the [computer cover](#).
3. Remove the [front bezel](#).
4. Remove the [drives bezel](#).
5. Connect the power and data cables to the back of the floppy drive.
6. Push the sliding plate lever down.
7. Place the floppy drive in the computer.

Hard Drives

Dell Precision™ T5500 Service Manual

⚠ WARNING: Before working inside your computer, read the safety information that shipped with your computer. For additional safety best practices information, see the Regulatory Compliance Homepage at www.dell.com/regulatory_compliance.

Removing the Hard Drives



1. Follow the procedures in [Before Working Inside Your Computer](#).
2. Remove the [computer cover](#).



3. Disconnect the power cable from the first hard drive.



4. Disconnect the power cable from the first hard drive.

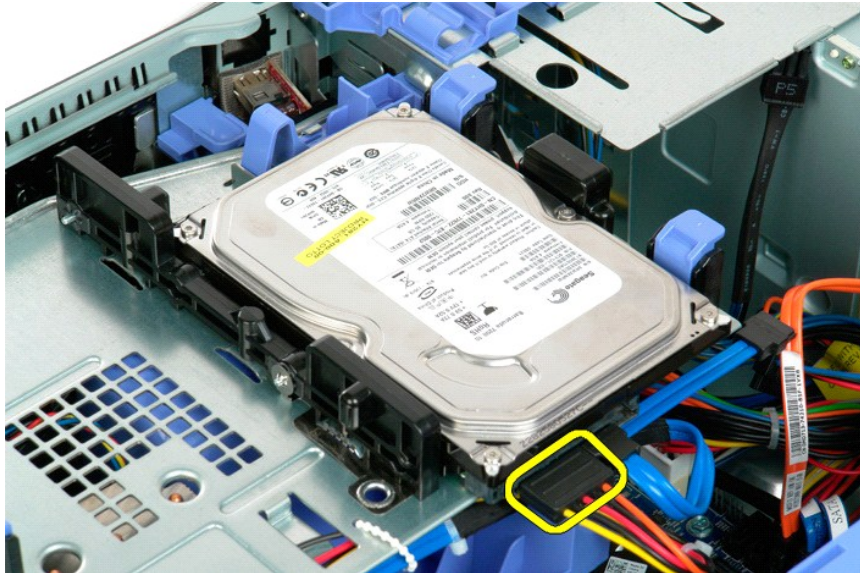

5. Disconnect the data cable from the first hard drive.



6. Lift the two blue hard drive release tabs.

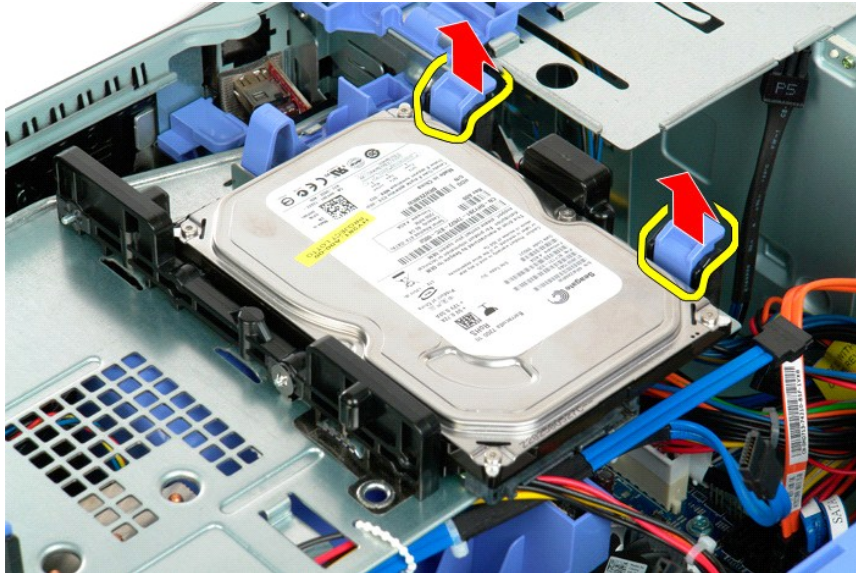

7. Remove the first hard drive assembly from the computer. Repeat these steps for any other installed hard drives.

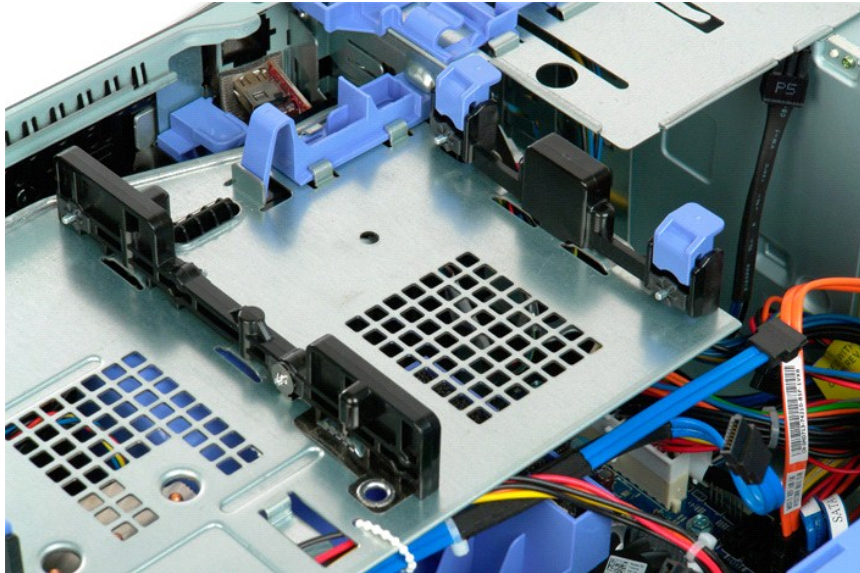
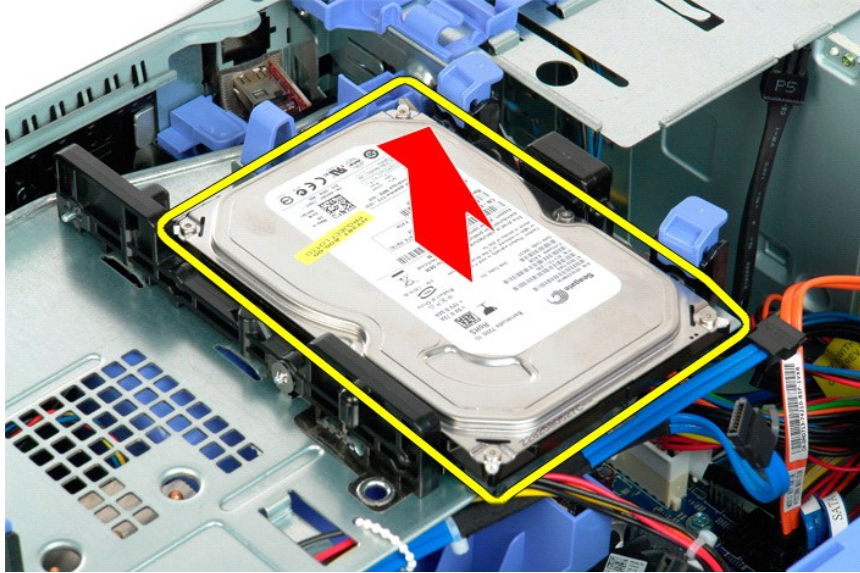

Hard Drive Tray

Dell Precision™ T5500 Service Manual

⚠ WARNING: Before working inside your computer, read the safety information that shipped with your computer. For additional safety best practices information, see the Regulatory Compliance Homepage at www.dell.com/regulatory_compliance.

Lifting the Hard Drive Tray



1. Follow the procedures in [Before Working Inside Your Computer](#).
2. Remove the [computer cover](#).



3. Press the hard drive release lever toward the bottom of the computer.

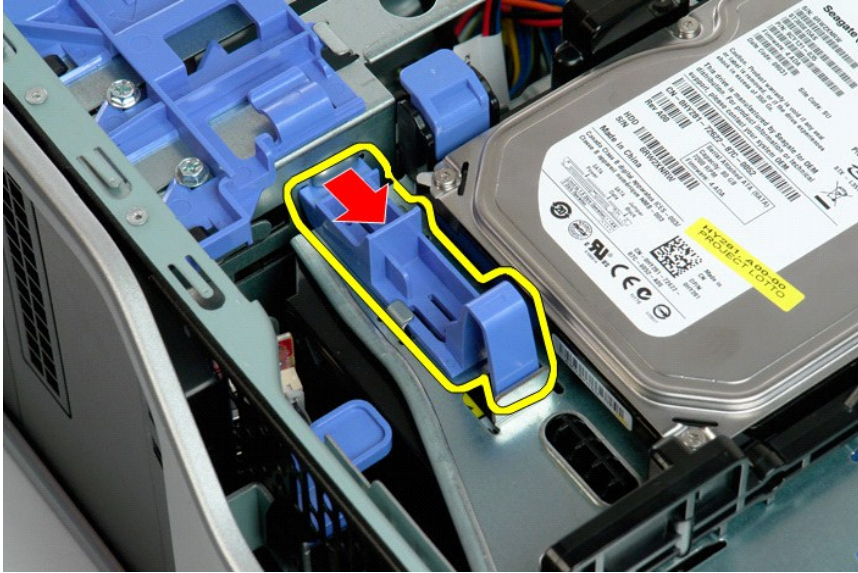

4. Lift and rotate the hard drive tray toward the bottom of the computer.





Chassis Intrusion Switch

Dell Precision™ T5500 Service Manual

⚠ WARNING: Before working inside your computer, read the safety information that shipped with your computer. For additional safety best practices information, see the Regulatory Compliance Homepage at www.dell.com/regulatory_compliance.

Removing the Chassis Intrusion Switch

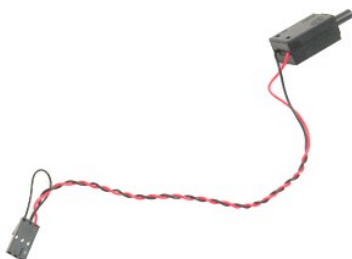

1. Follow the procedures in [Before Working Inside Your Computer](#).
2. Remove the [computer cover](#).



3. Lift up the expansion card retention arm.

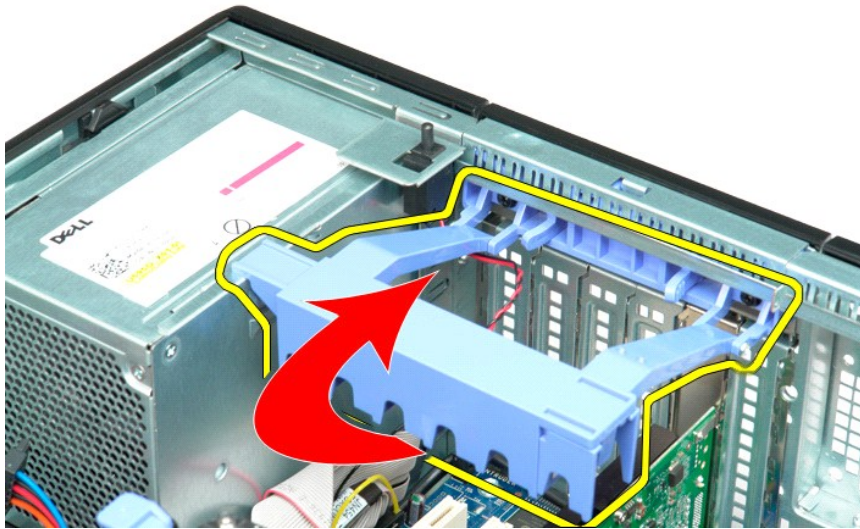

4. Disconnect the intrusion switch cable from the system board.

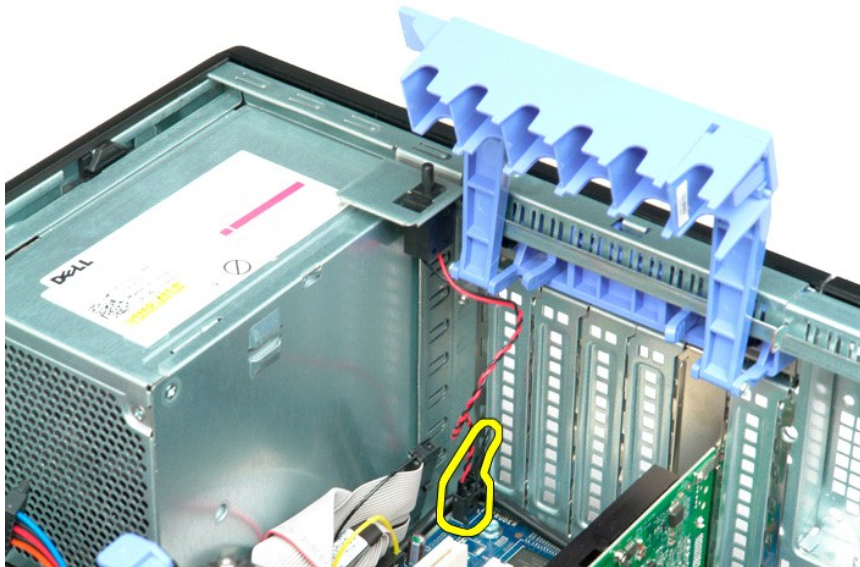

5. Slide the intrusion switch toward the center of the computer.

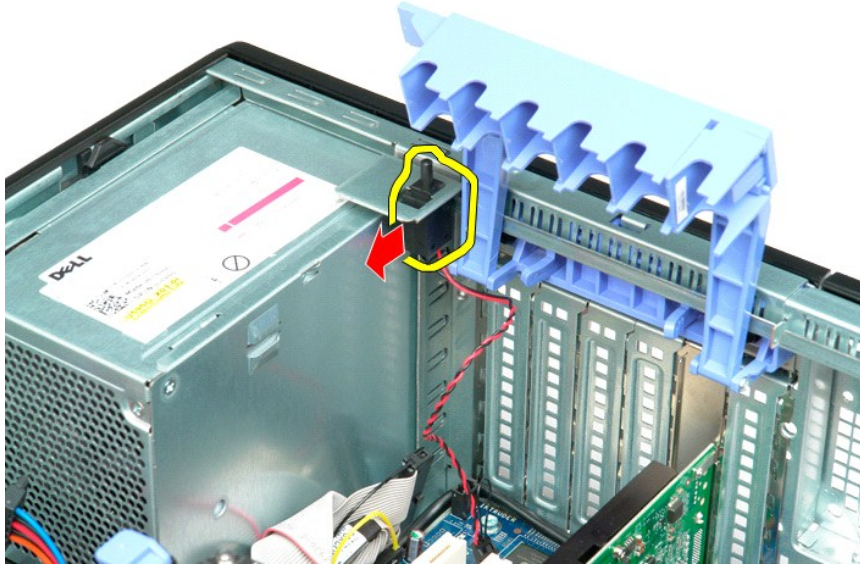

6. Remove the intrusion switch from the computer.

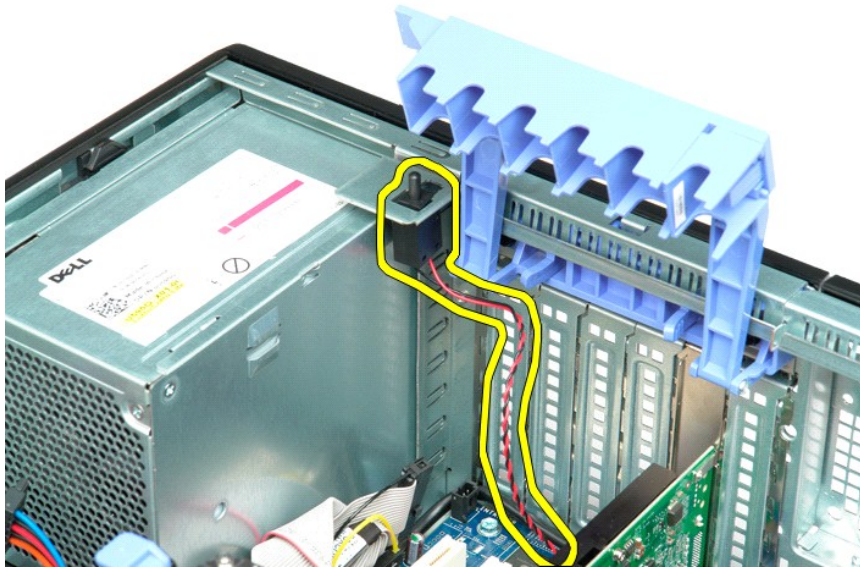

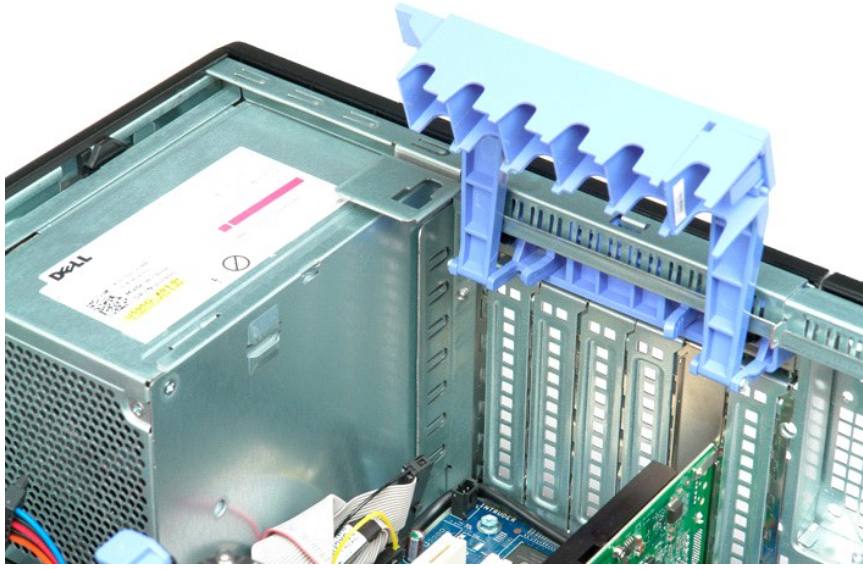

I/O Data Cable

Dell Precision™ T5500 Service Manual

 **WARNING:** Before working inside your computer, read the safety information that shipped with your computer. For additional safety best practices information, see the Regulatory Compliance Homepage at www.dell.com/regulatory_compliance.

Removing the I/O Data Cable

1. Follow the procedures in [Before Working Inside Your Computer](#).
2. Remove the [computer cover](#).
3. Raise the [hard drive tray](#).
4. Remove the [memory module shroud](#).
5. Remove the [front fan assembly](#).
6. Disconnect the I/O data cable from the I/O panel.

Replacing the I/O Data Cable

1. Follow the procedures in [Before Working Inside Your Computer](#).
2. Remove the [computer cover](#).
3. Raise the [hard drive tray](#).
4. Remove the [memory module shroud](#).
5. Remove the [front fan assembly](#).
6. Connect the I/O data cable to the I/O panel.

Memory and Memory Shroud

Dell Precision™ T5500 Service Manual

⚠ WARNING: Before working inside your computer, read the safety information that shipped with your computer. For additional safety best practices information, see the Regulatory Compliance Homepage at www.dell.com/regulatory_compliance.

Your computer features an optional dual-processor riser to accommodate dual processor and expanded memory options (see [Dual Processor Riser \(Optional\)](#)). Memory modules are removed from and installed into slots both on the system board or on the optional dual-processor riser identically, although only the slots located on the system board are illustrated below.

Removing the Memory Shroud and Memory Modules

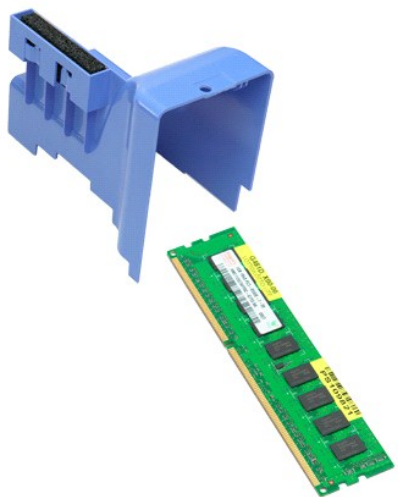

1. Follow the procedures in [Before Working Inside Your Computer](#).
2. Remove the [computer cover](#).
3. Lift the [hard drive tray](#).



4. Lift the memory shroud straight up and remove the memory shroud from the computer.

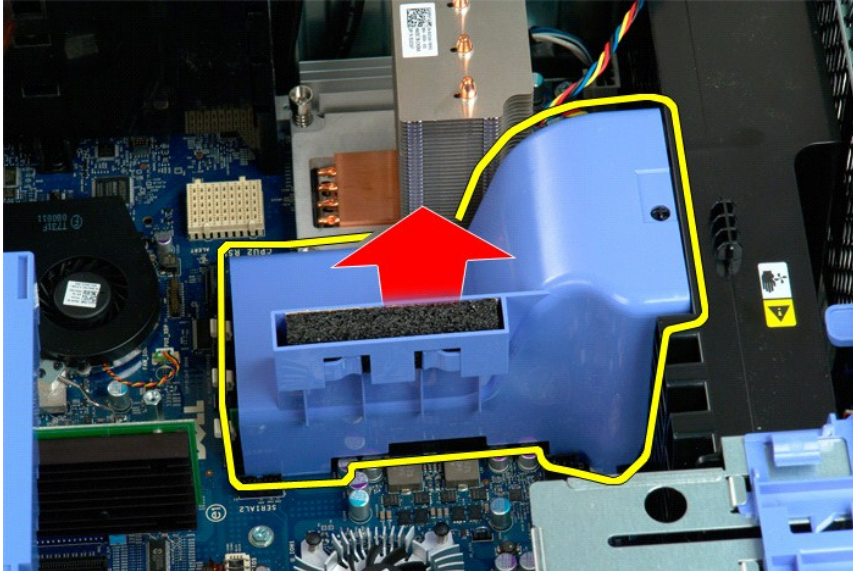

5. Using your thumbs, gently push down on the memory module retention clips to release the module from the connector on the system board.

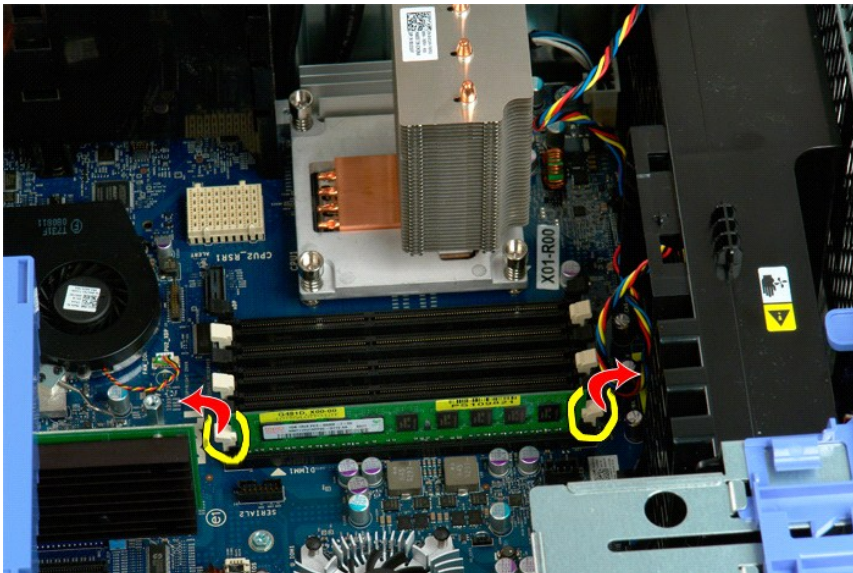

6. Lift the first memory module straight up and out of the computer, and repeat for any remaining memory modules.

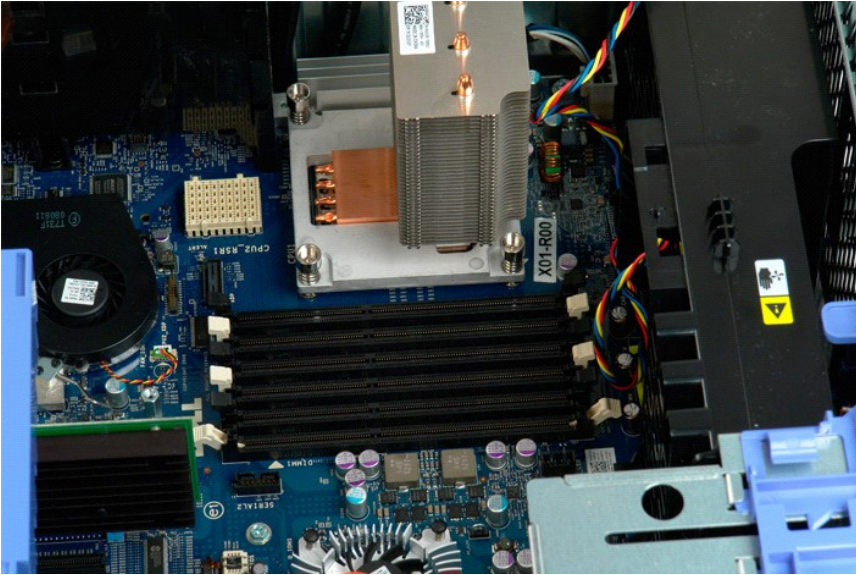
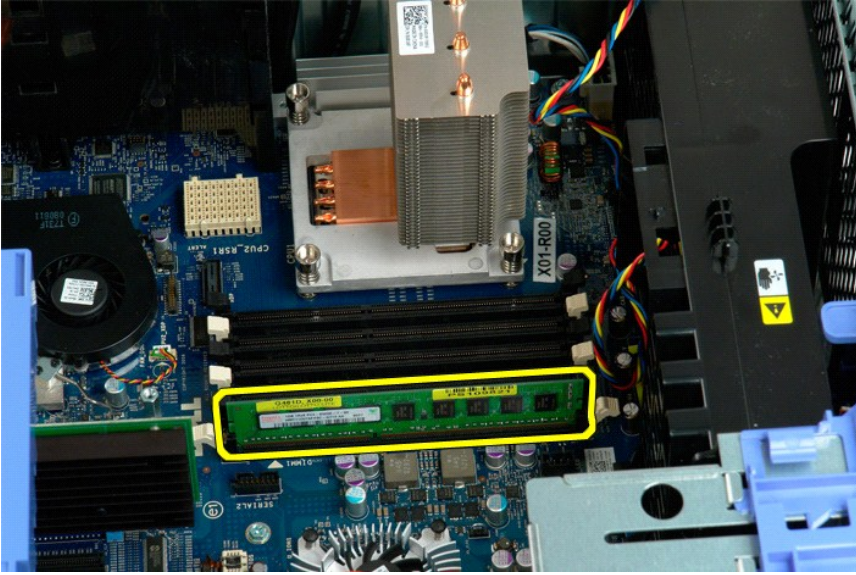

Memory Card Reader

Dell Precision™ T5500 Service Manual

 **WARNING:** Before working inside your computer, read the safety information that shipped with your computer. For additional safety best practices information, see the Regulatory Compliance Homepage at www.dell.com/regulatory_compliance.

Removing the Memory Card Reader

1. Follow the procedures in [Before Working Inside Your Computer](#).
2. Remove the [computer cover](#).
3. Remove the [front bezel](#).
4. Remove the [drives bezel](#).
5. Disconnect the power and data cables from the back of the memory card reader.
6. Push the sliding plate lever down to release the memory card reader.
7. Remove the memory card reader from the computer.

Replacing the Memory Card Reader

1. Follow the procedures in [Before Working Inside Your Computer](#).
2. Remove the [computer cover](#).
3. Remove the [front bezel](#).
4. Remove the [drives bezel](#).
5. Connect the power and data cables to the back of the memory card reader.
6. Push the sliding plate lever down.
7. Place the memory card reader in the computer.

Optical Drive

Dell Precision™ T5500 Service Manual

WARNING: Before working inside your computer, read the safety information that shipped with your computer. For additional safety best practices information, see the Regulatory Compliance Homepage at www.dell.com/regulatory_compliance.

Removing the Optical Drive



1. Follow the procedures in [Before Working Inside Your Computer](#).
2. Remove the [computer cover](#).



3. Disconnect the power cable from the back of the optical drive.



4. Disconnect the data cable from the back of the optical drive.

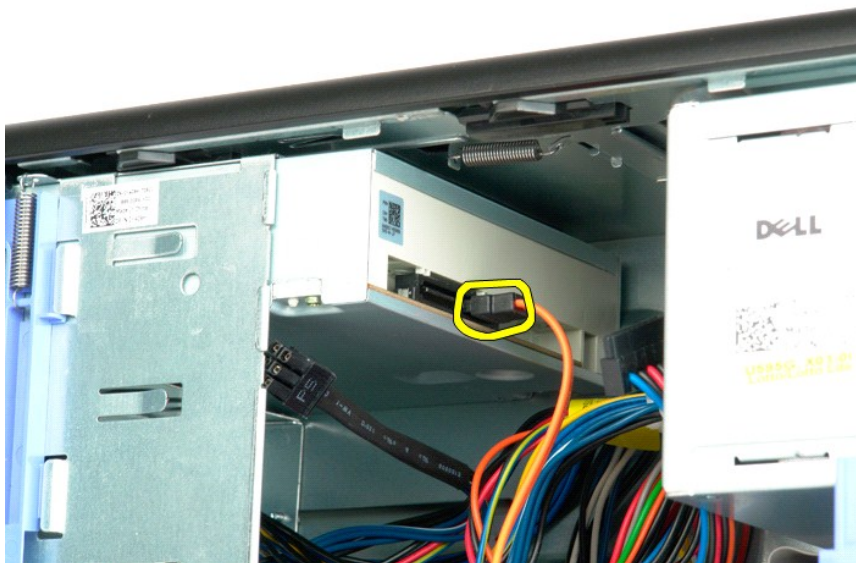

5. Press down on the sliding-plate lever and hold.

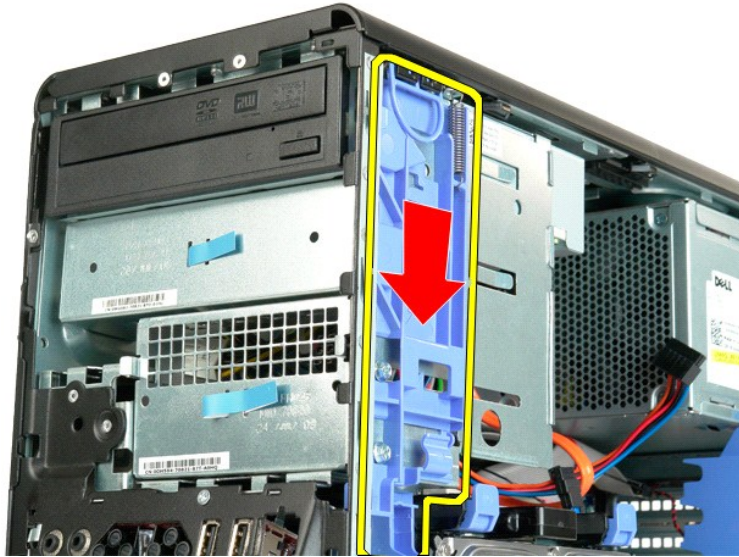

6. Slide the optical drive out of the front of the chassis, and remove from the computer.

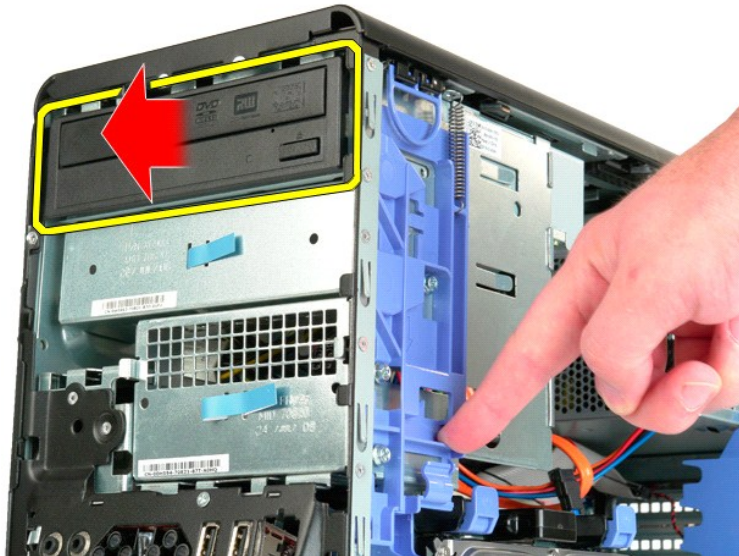

5.



Heat Sink and Processor

Dell Precision™ T5500 Service Manual

⚠ WARNING: Before working inside your computer, read the safety information that shipped with your computer. For additional safety best practices information, see the Regulatory Compliance Homepage at www.dell.com/regulatory_compliance.

Removing the Heat Sink and Processor

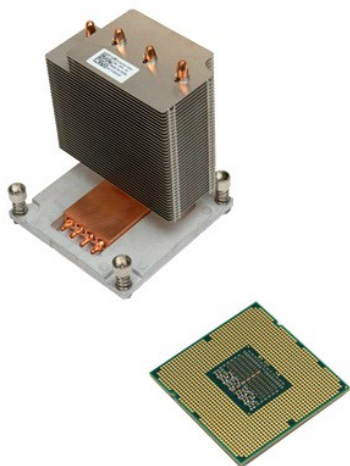

1. Follow the procedures in [Before Working Inside Your Computer](#).
2. Remove the computer [cover](#).
3. Open the [hard drive tray](#).



4. Loosen the four captive screws on the heat sink.

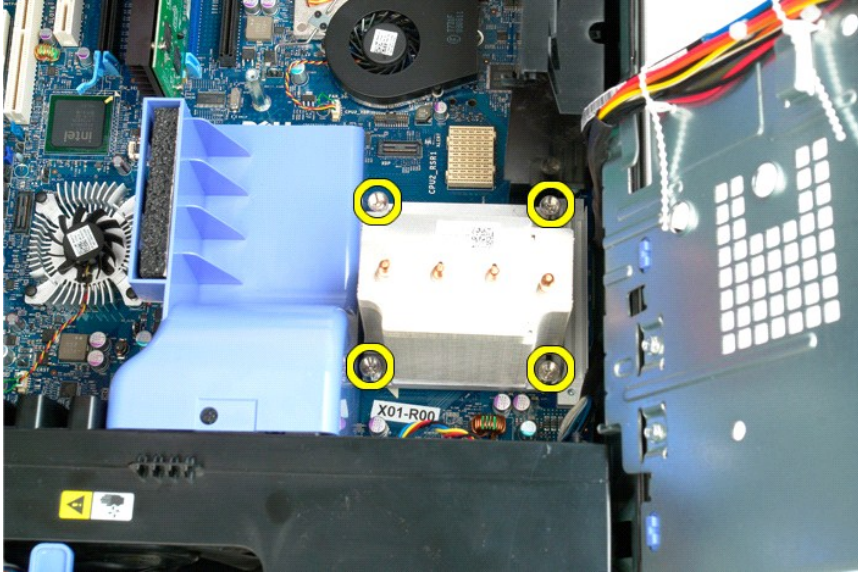

5. Lift the heat sink straight up and remove the heat sink from the computer.

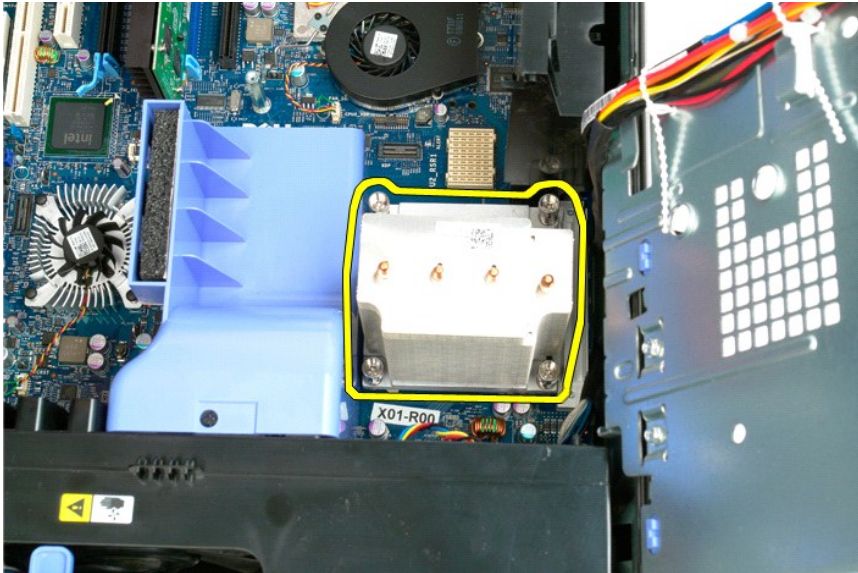

6. Press down and out on the processor release lever to release the processor.

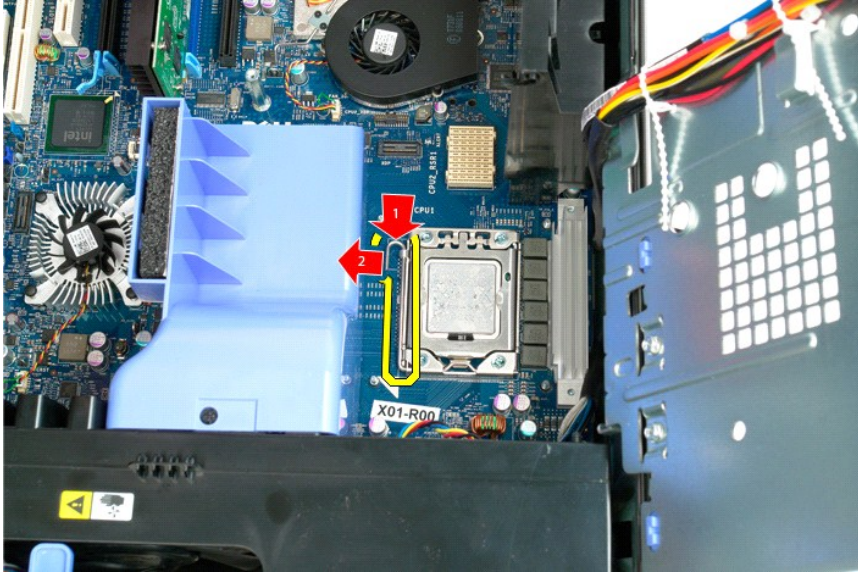

7. Lift the processor cover.

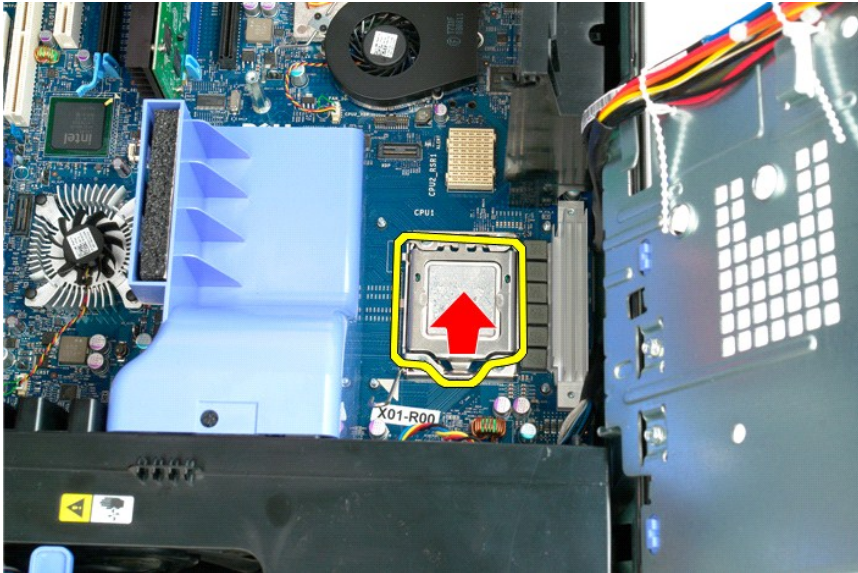

8. Lift the processor straight up and remove it from the computer.

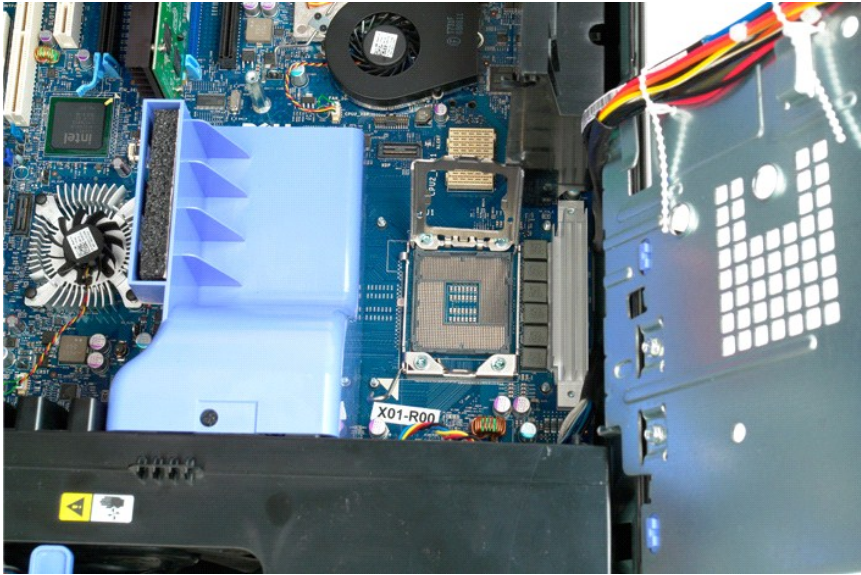
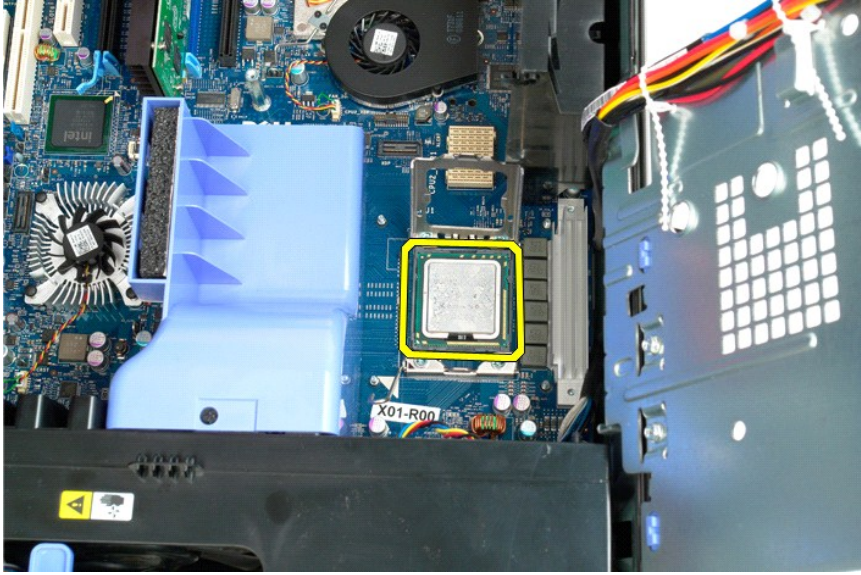

Dual Processor Riser (Optional)

Dell Precision™ T5500 Service Manual

⚠ WARNING: Before working inside your computer, read the safety information that shipped with your computer. For additional safety best practices information, see the Regulatory Compliance Homepage at www.dell.com/regulatory_compliance.

Removing the Optional Dual Processor Riser



1. Follow the procedures in [Before Working Inside Your Computer](#).
2. Remove the [computer cover](#).



3. Pull down on the dual processor riser release lever.

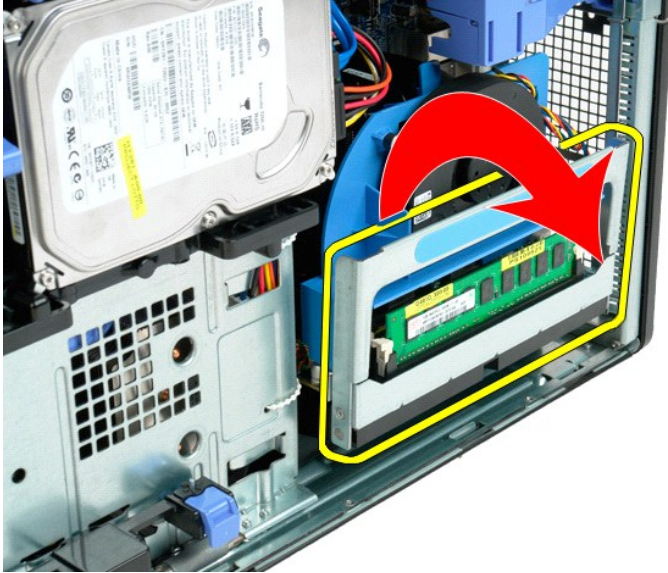

4. Carefully slide the dual processor riser halfway out.

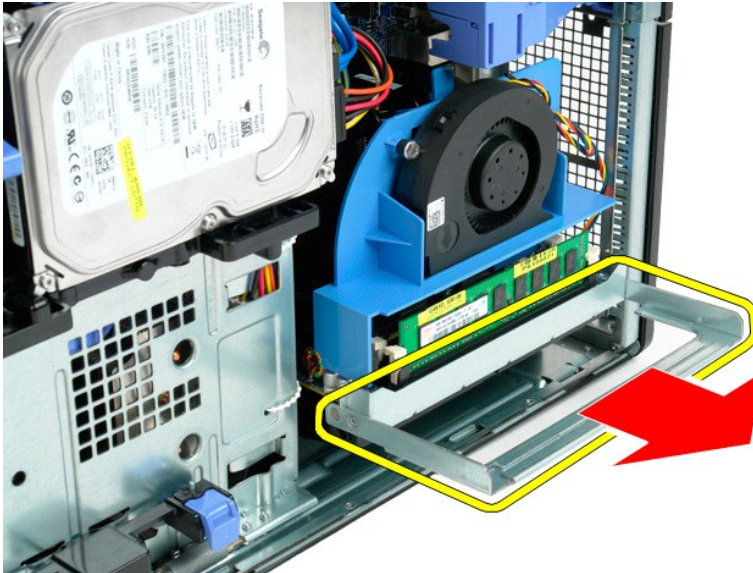

5. Disconnect the power cable from the dual processor board.



6. Remove the dual processor riser completely from the computer.

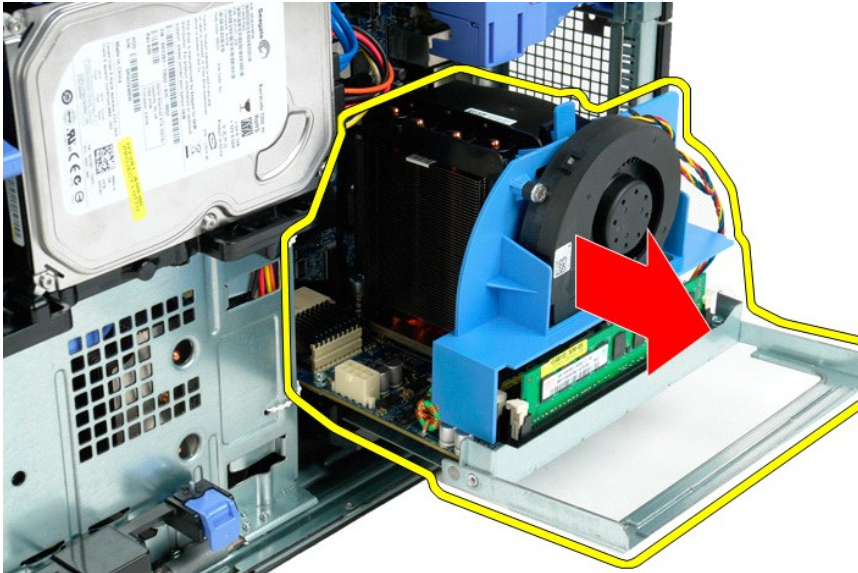

7. Disconnect the dual processor fan cable from the dual processor board.

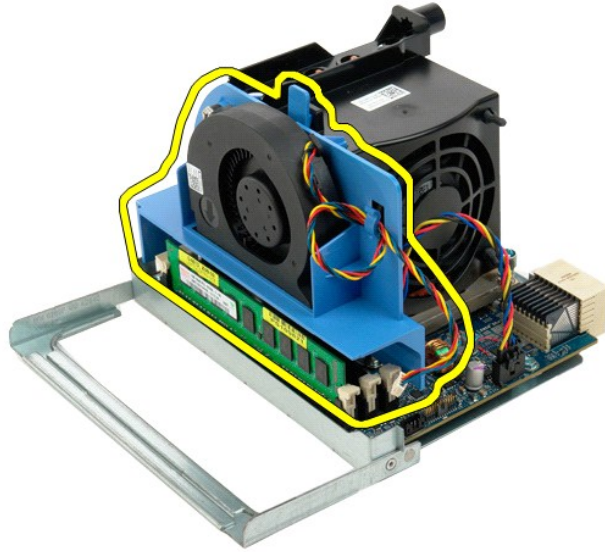

8. While pressing on the blue release tab, remove the dual processor fan assembly from the dual processor assembly.

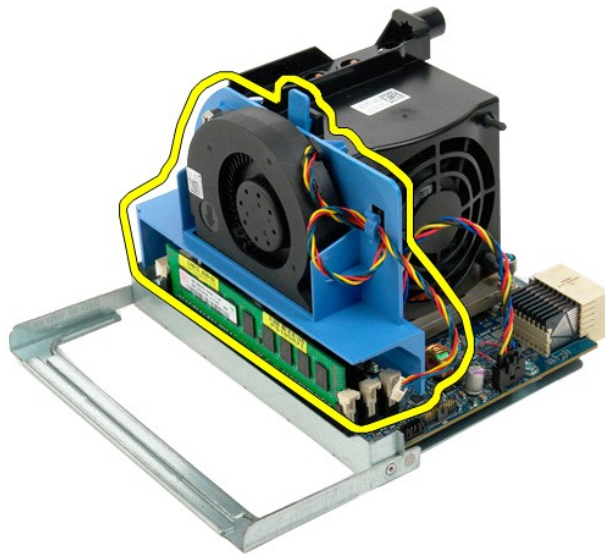

9. Gently press down on the memory module release tabs to release the first dual processor memory module from the connector.

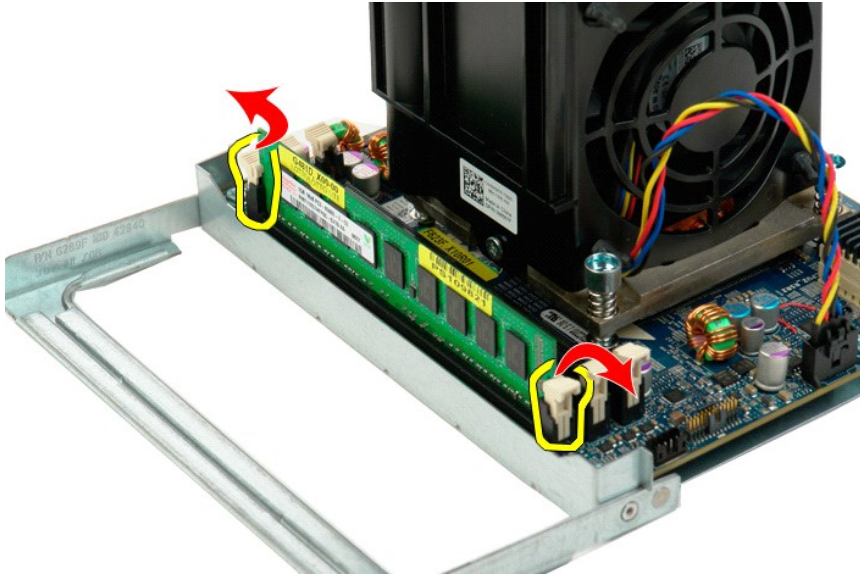

10. Remove the first memory module from the dual processor board, and repeat with any remaining memory modules.

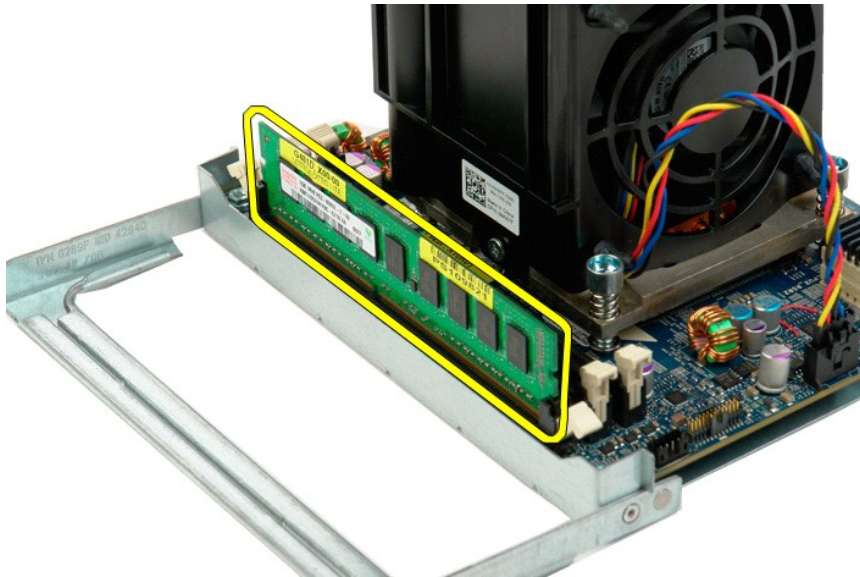

11. Disconnect the dual processor heat sink fan cable from the dual processor board.

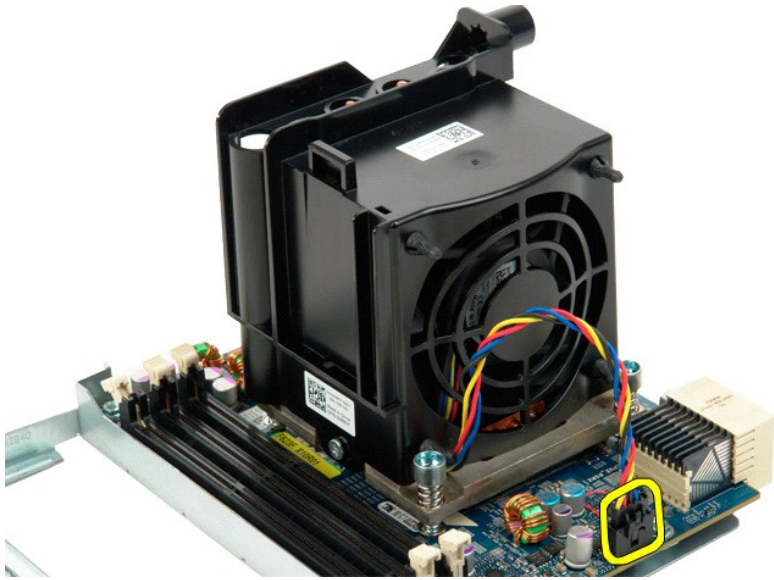

12. Loosen the four captive screws on the dual processor heat sink/fan assembly.

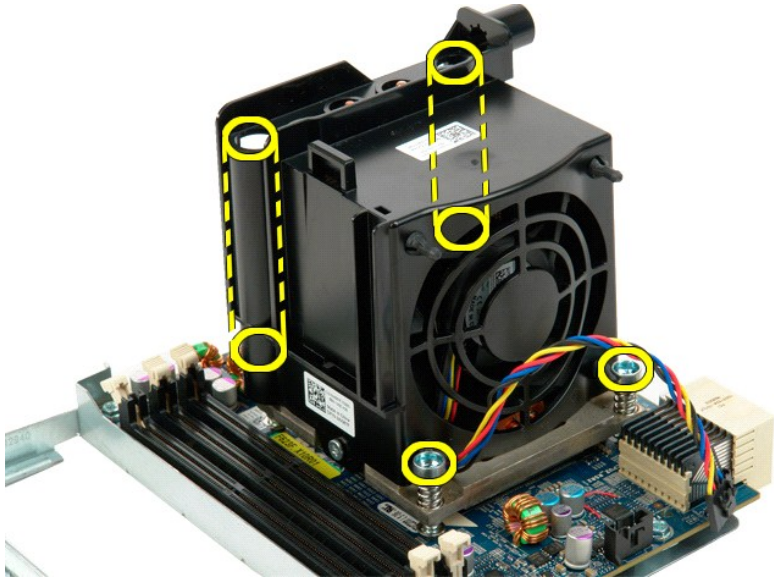

13. Remove the dual processor heat sink fan assembly from the dual processor riser board.



14. Release the dual processor cover by pressing down and out on the release arm.

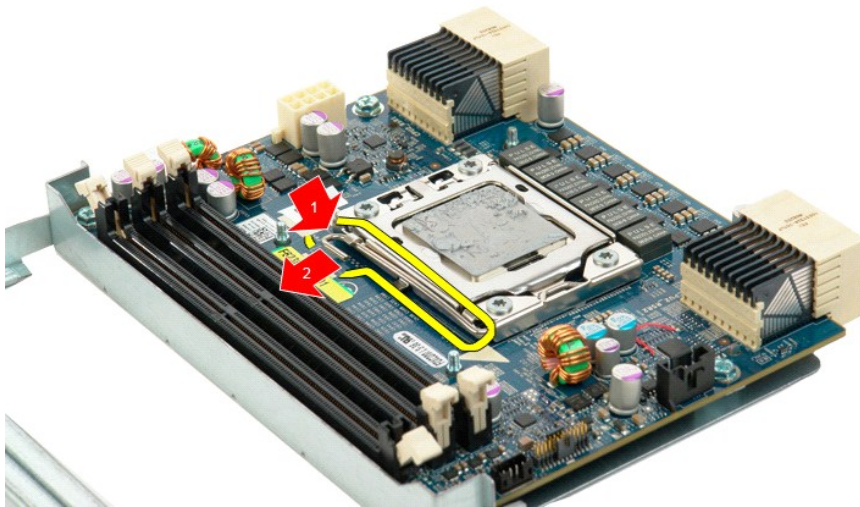

15. Open the dual processor cover.

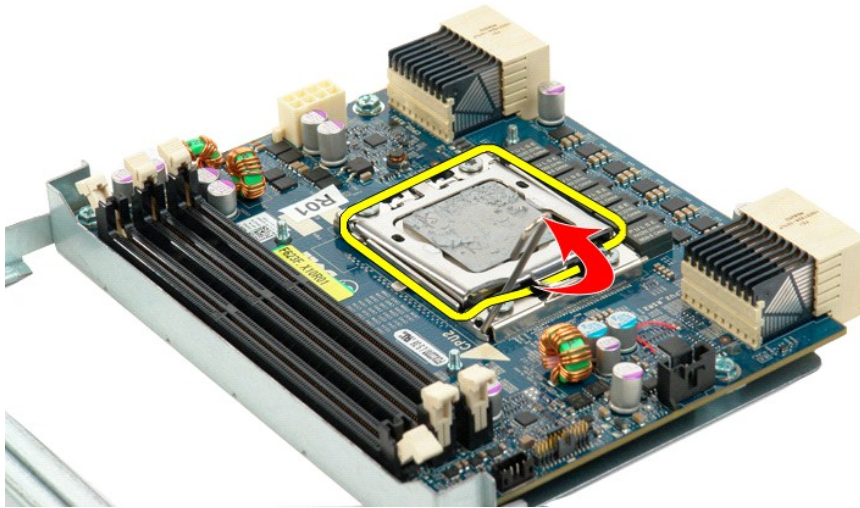

16. Remove the dual processor from the dual processor board.

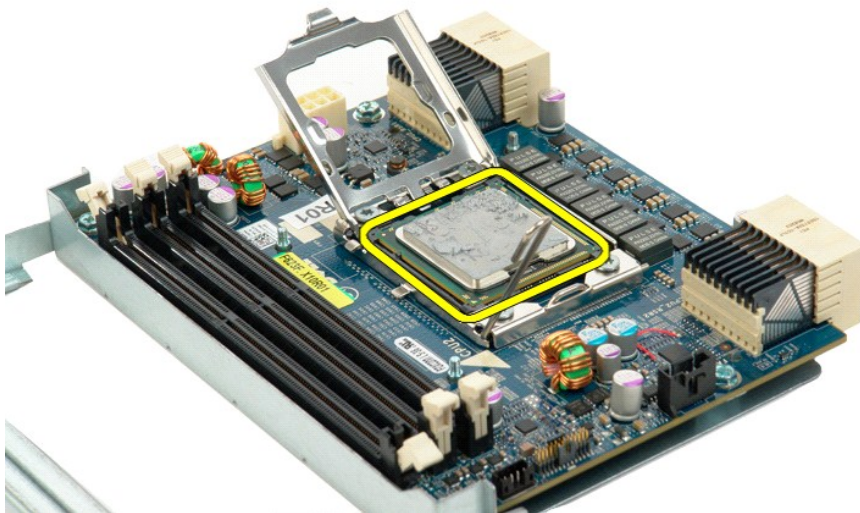



Power Supply

Dell Precision™ T5500 Service Manual

⚠ WARNING: Before working inside your computer, read the safety information that shipped with your computer. For additional safety best practices information, see the Regulatory Compliance Homepage at www.dell.com/regulatory_compliance.

Removing the Power Supply



1. Follow the procedures in [Before Working Inside Your Computer](#).
2. Remove the [computer cover](#).



3. Remove the four screws securing the power supply on the outside of the computer.



4. Rotate the expansion card retention arm toward the outside of the computer.



5. Disconnect the power supply cable from the power supply.

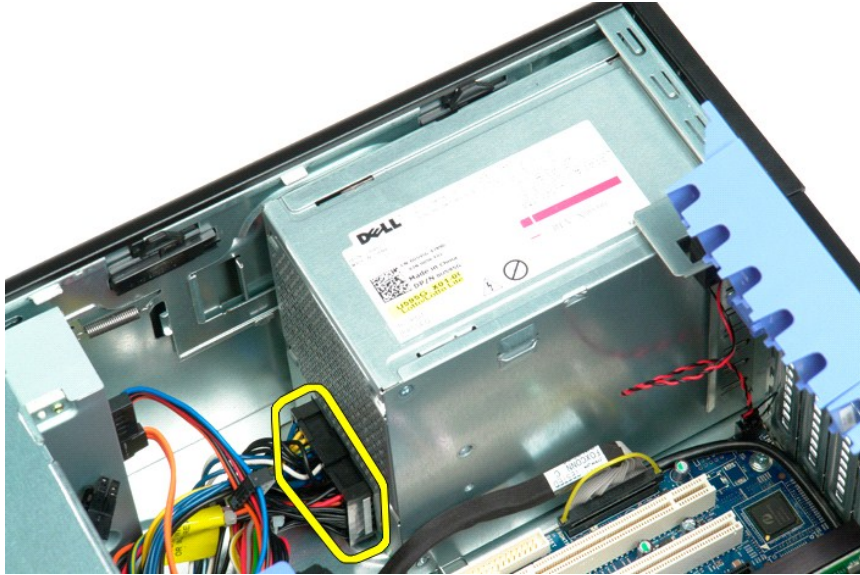

6. Push down and hold the power supply release clip (1), then slide the power supply toward the center of the computer (2).

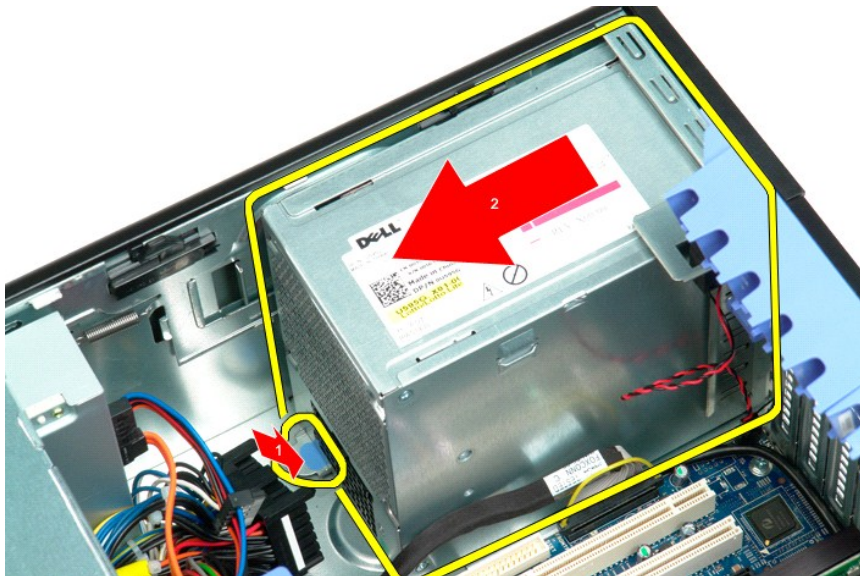

7. Remove the power supply from the system at an angle.

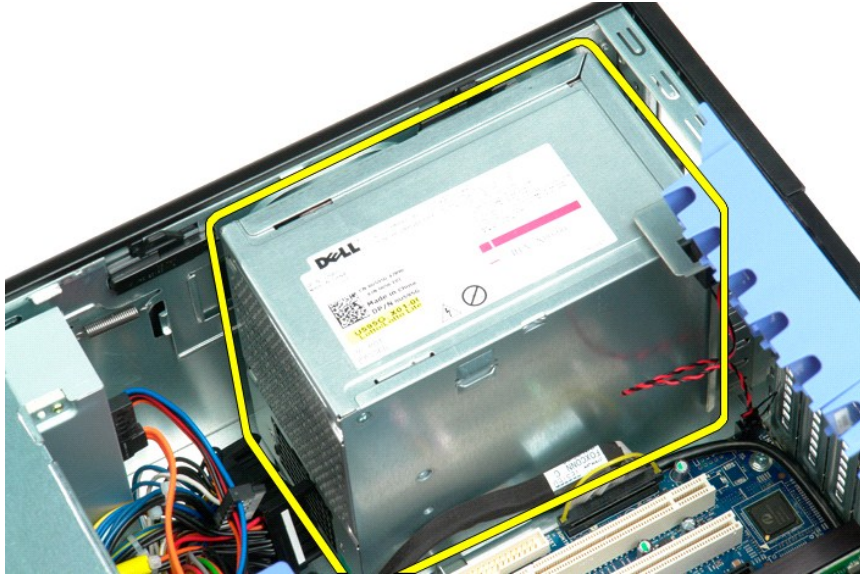

System Board

Dell Precision™ T5500 Service Manual

⚠ WARNING: Before working inside your computer, read the safety information that shipped with your computer. For additional safety best practices information, see the Regulatory Compliance Homepage at www.dell.com/regulatory_compliance.

Removing the System Board



1. Follow the procedures in [Before Working Inside Your Computer](#).
2. Remove the [computer cover](#).
3. Lift the [hard drive tray](#).
4. Remove the [memory shroud](#).
5. Remove the [front fan assembly](#).
6. Remove any [expansion or video cards](#) and raise the [expansion card retention arm](#).
7. Remove the [heat sink and processor](#).



8. Remove any [memory modules](#).
9. Disconnect the front panel audio cable from the system board.

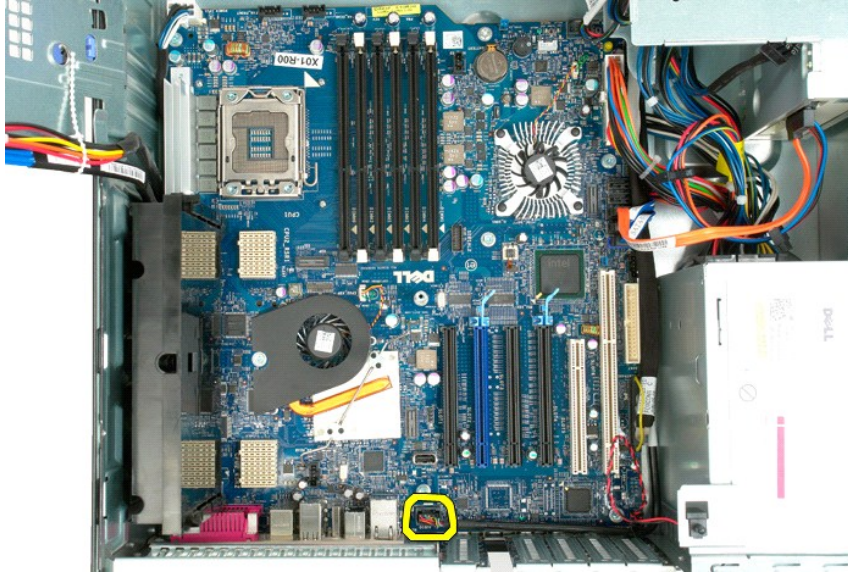

10. Disconnect the intrusion switch cable from the system board.

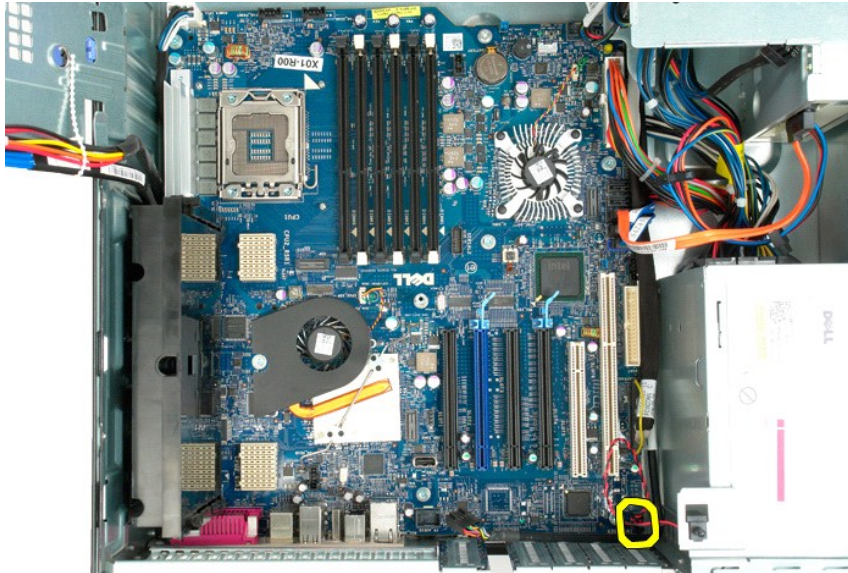

11. Disconnect the I/O data cable from the system board.

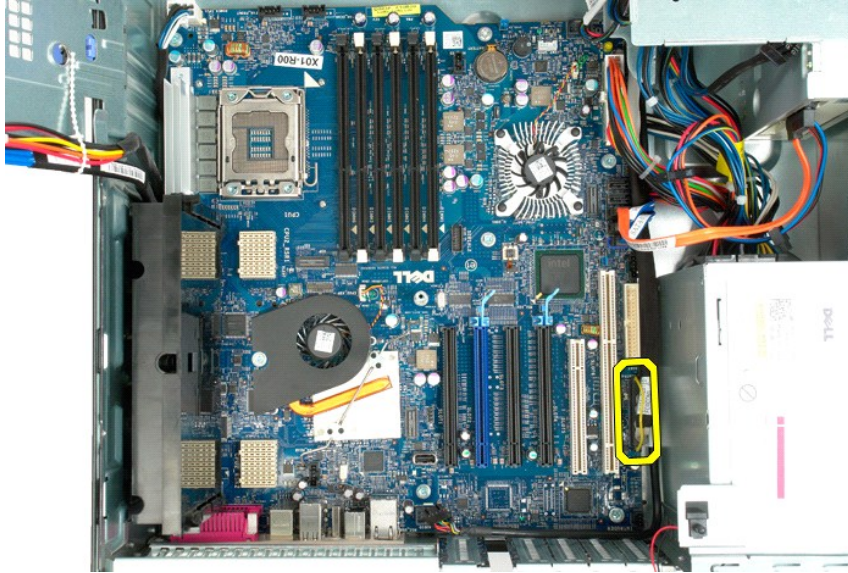

12. Disconnect the hard drive and optical drive data cables from the system board.

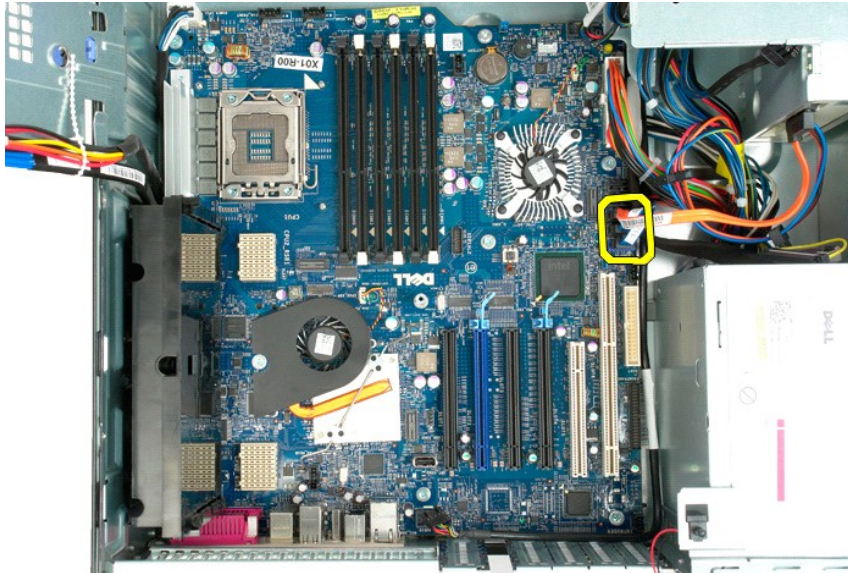

13. Disconnect the power supply cable from the system board.



14. Disconnect the power supply data cable from the system board.



15. Remove the three screws that secure the dual processor riser to the system board.

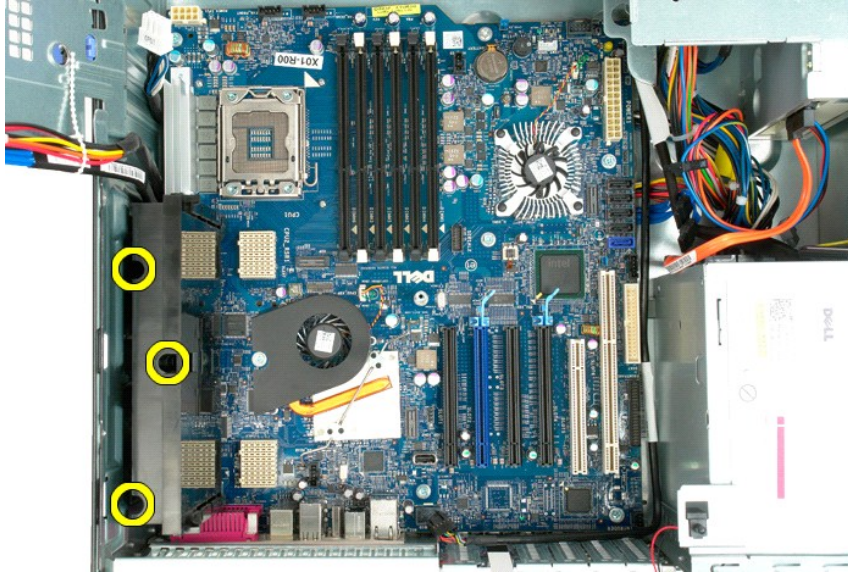

16. Remove the dual processor riser.

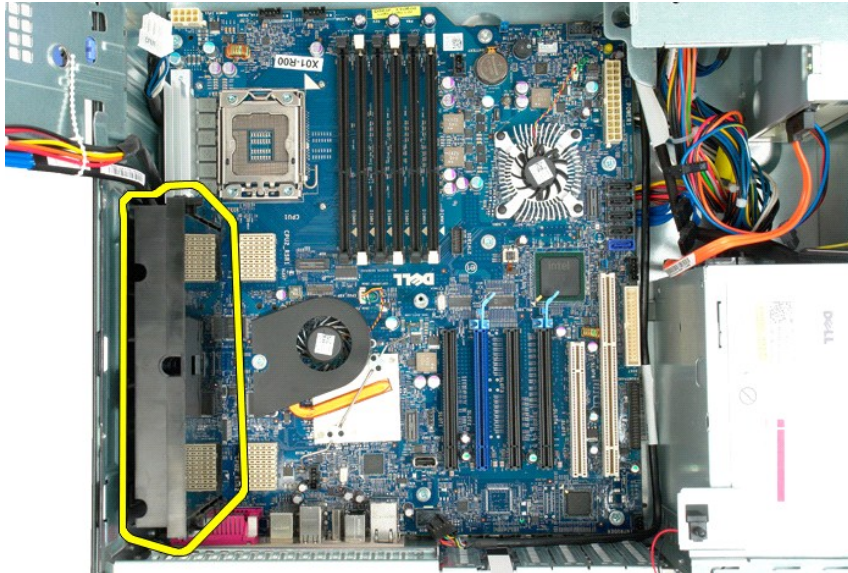

17. Remove the eight screws that secure the system board to the computer chassis.

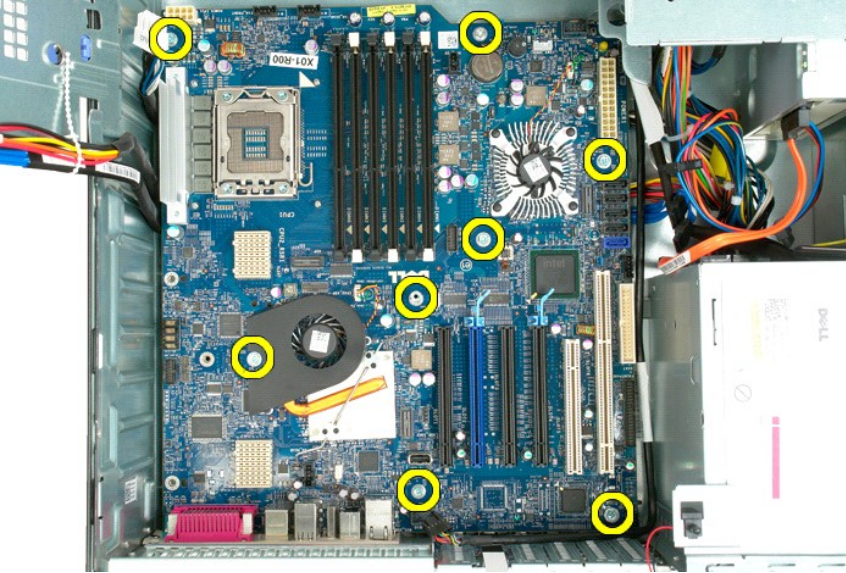

18. Disconnect the optical drive data cable.

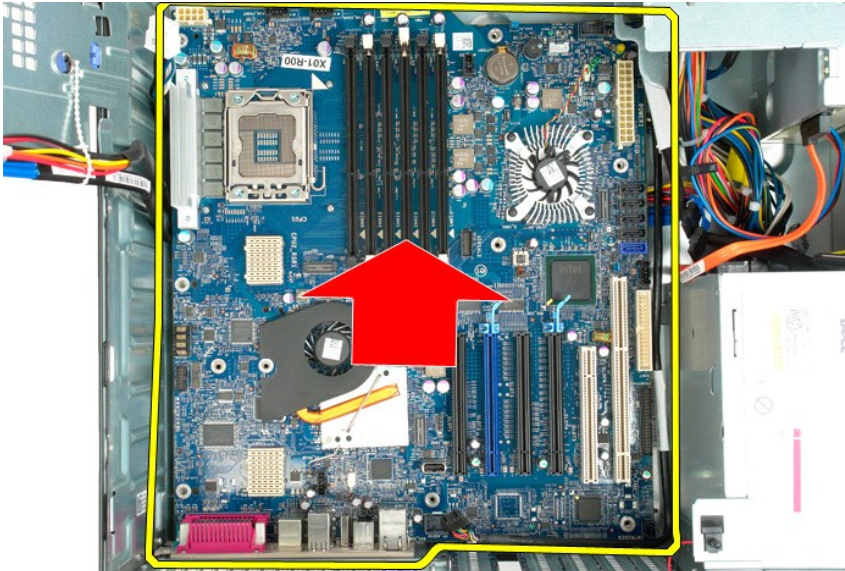

19. Remove the system board.

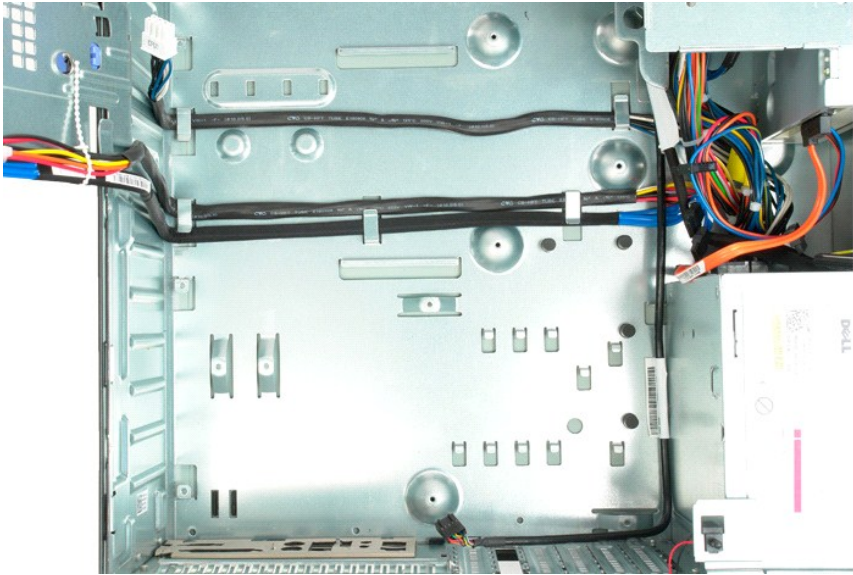
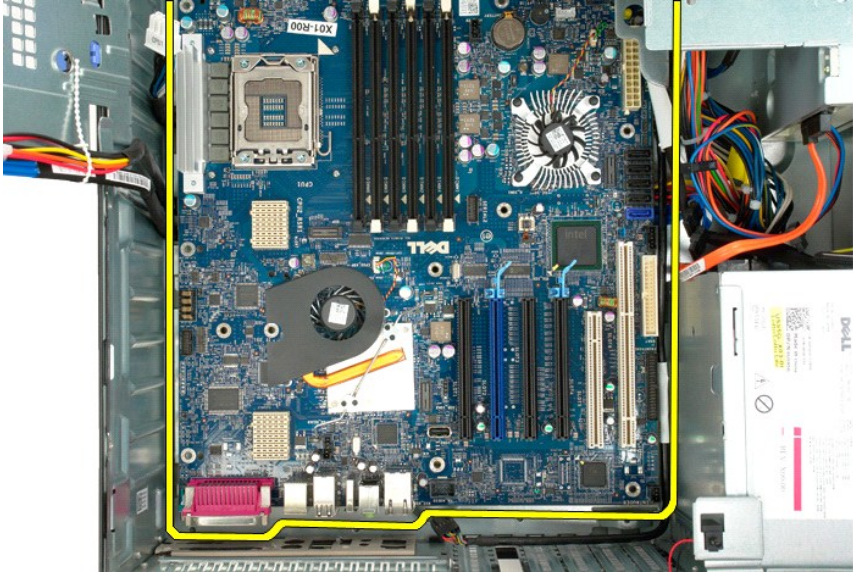

Expansion Cards

Dell Precision™ T5500 Service Manual

WARNING: Before working inside your computer, read the safety information that shipped with your computer. For additional safety best practices information, see the Regulatory Compliance Homepage at www.dell.com/regulatory_compliance.

Removing an Expansion Card



1. Follow the procedures in [Before Working Inside Your Computer](#).
2. Remove the [computer cover](#).



3. Squeeze the release tabs, then lift the expansion card retention arm away from the computer.

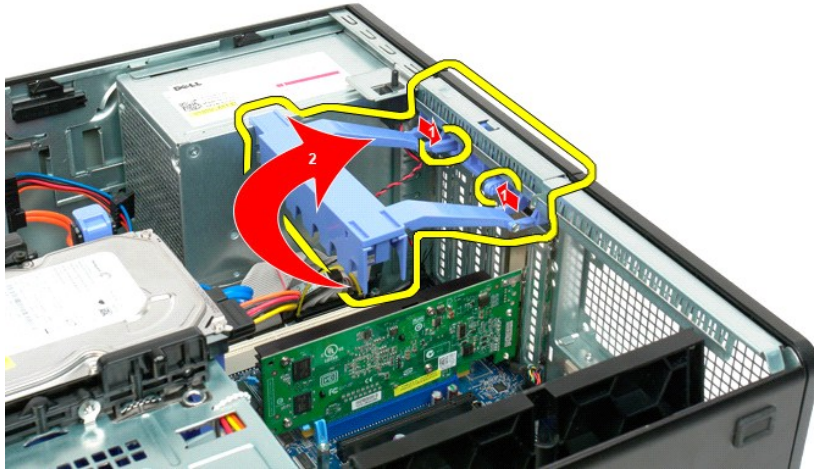

4. Pull back the expansion card retention clip.

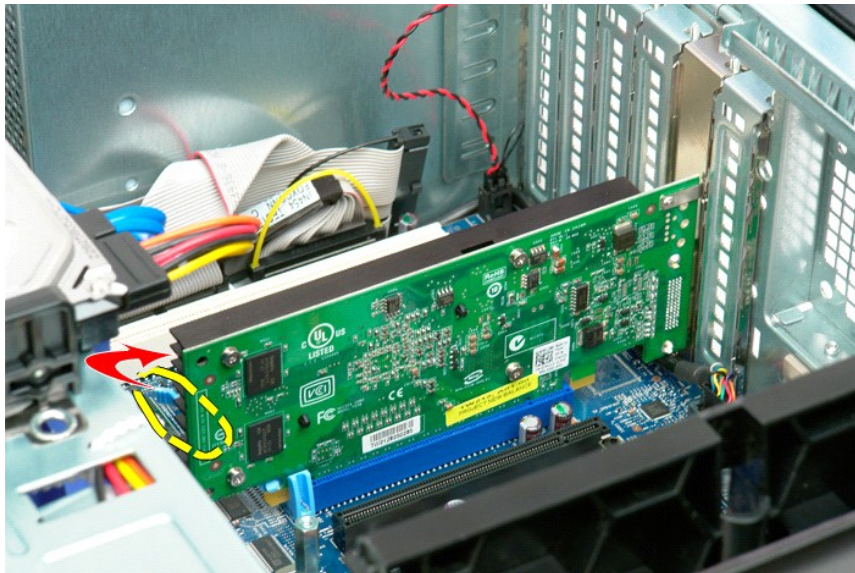

4. Remove the expansion card from the computer.

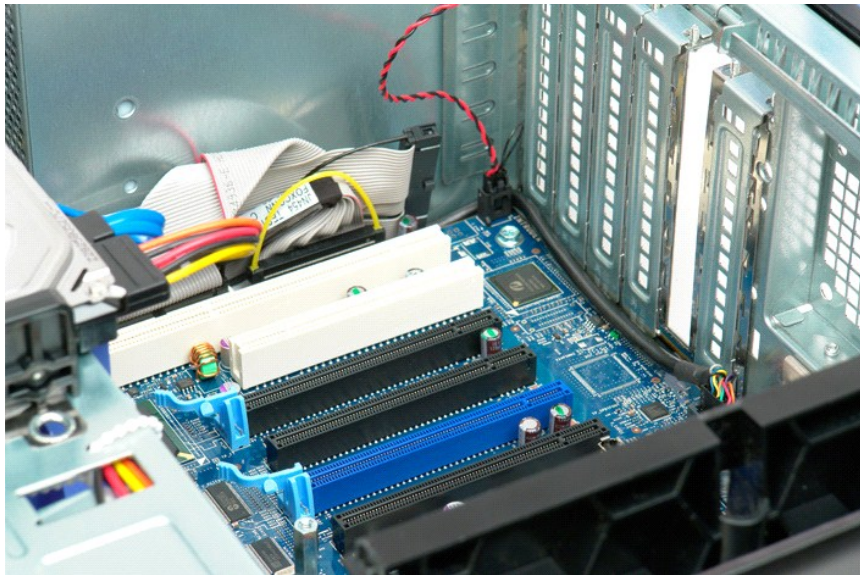
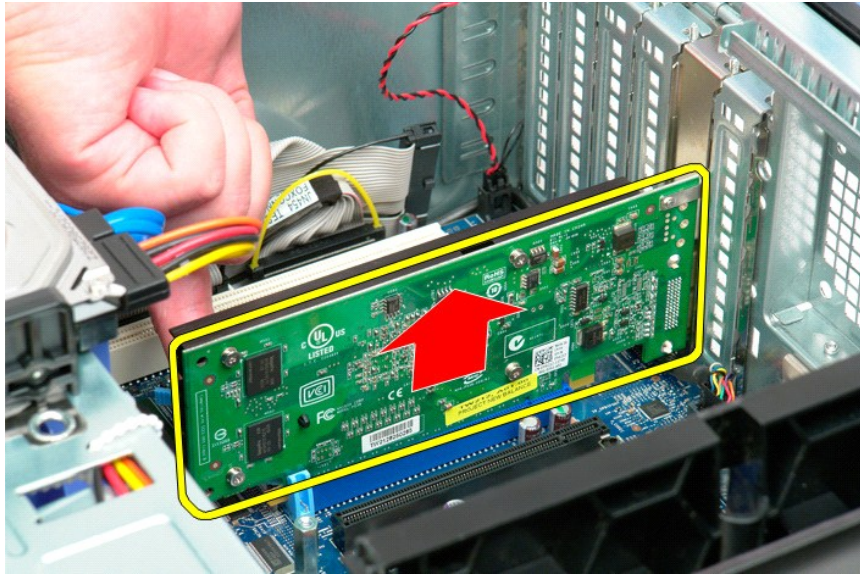

Working on Your Computer

Dell Precision™ T5500 Service Manual

- [Before Working Inside Your Computer](#)
- [Recommended Tools](#)
- [Turning Off Your Computer](#)
- [After Working Inside Your Computer](#)

Before Working Inside Your Computer

Use the following safety guidelines to help protect your computer from potential damage and to help to ensure your personal safety. Unless otherwise noted, each procedure included in this document assumes that the following conditions exist:

- 1 You have performed the steps in [Working on Your Computer](#).
- 1 You have read the safety information that shipped with your computer.
- 1 A component can be replaced or—if purchased separately—installed by performing the removal procedure in reverse order.

WARNING: Before working inside your computer, read the safety information that shipped with your computer. For additional safety best practices information, see the Regulatory Compliance Homepage at www.dell.com/regulatory_compliance.

CAUTION: Only a certified service technician should perform repairs on your computer. Damage due to servicing that is not authorized by Dell is not covered by your warranty.

CAUTION: To avoid electrostatic discharge, ground yourself by using a wrist grounding strap or by periodically touching an unpainted metal surface, such as a connector on the back of the computer.

CAUTION: Handle components and cards with care. Do not touch the components or contacts on a card. Hold a card by its edges or by its metal mounting bracket. Hold a component such as a processor by its edges, not by its pins.

CAUTION: When you disconnect a cable, pull on its connector or on its pull-tab, not on the cable itself. Some cables have connectors with locking tabs; if you are disconnecting this type of cable, press in on the locking tabs before you disconnect the cable. As you pull connectors apart, keep them evenly aligned to avoid bending any connector pins. Also, before you connect a cable, ensure that both connectors are correctly oriented and aligned.

NOTE: The color of your computer and certain components may appear differently than shown in this document.

To avoid damaging your computer, perform the following steps before you begin working inside the computer.

1. Ensure that your work surface is flat and clean to prevent the computer cover from being scratched.
2. Turn off your computer (see [Turning Off Your Computer](#)).

CAUTION: To disconnect a network cable, first unplug the cable from your computer and then unplug the cable from the network device.

3. Disconnect all network cables from the computer.
5. Disconnect your computer and all attached devices from their electrical outlets.
6. Press and hold the power button while the system is unplugged to ground the system board.
7. Remove the computer cover (see [Removing and Replacing the Computer Cover](#)).

CAUTION: Before touching anything inside your computer, ground yourself by touching an unpainted metal surface, such as the metal at the back of the computer. While you work, periodically touch an unpainted metal surface to dissipate static electricity, which could harm internal components.

Recommended Tools

The procedures in this document may require the following tools:

- 1 Small flat-blade screwdriver
- 1 Phillips screwdriver
- 1 Small plastic scribe
- 1 Flash BIOS update program CD (see the Dell Support website at support.dell.com)

Turning Off Your Computer

CAUTION: To avoid losing data, save and close all open files and exit all open programs before you turn off your computer.

1. Shut down the operating system:

In Windows Vista:

Click **Start** , then click the arrow in the lower-right corner of the **Start** menu as shown below, and then click **Shut Down**.



In Windows XP:

Click **Start** → **Turn Off Computer** → **Turn Off**.

The computer turns off after the operating system shutdown process is complete.

2. Ensure that the computer and all attached devices are turned off. If your computer and attached devices did not automatically turn off when you shut down your operating system, press and hold the power button for about 6 seconds to turn them off.
-

After Working Inside Your Computer

After you complete any replacement procedure, ensure you connect any external devices, cards, and cables before turning on your computer.

1. Replace the computer cover (see [Removing and Replacing the Cover](#)).
2. Connect any telephone or network cables to your computer.

 **CAUTION:** To connect a network cable, first plug the cable into the network device and then plug it into the computer.

3. Connect your computer and all attached devices to their electrical outlets.
4. Turn on your computer.
5. Verify that the computer works correctly by running the Dell Diagnostics. See [Dell Diagnostics](#).

Free Manuals Download Website

<http://myh66.com>

<http://usermanuals.us>

<http://www.somanuals.com>

<http://www.4manuals.cc>

<http://www.manual-lib.com>

<http://www.404manual.com>

<http://www.luxmanual.com>

<http://aubethermostatmanual.com>

Golf course search by state

<http://golfingnear.com>

Email search by domain

<http://emailbydomain.com>

Auto manuals search

<http://auto.somanuals.com>

TV manuals search

<http://tv.somanuals.com>