

# Dell PowerEdge R430 Owner's Manual

Regulatory Model: E28S Series  
Regulatory Type: E28S001



# Notes, cautions, and warnings

 **NOTE:** A NOTE indicates important information that helps you make better use of your computer.

 **CAUTION:** A CAUTION indicates either potential damage to hardware or loss of data and tells you how to avoid the problem.

 **WARNING:** A WARNING indicates a potential for property damage, personal injury, or death.

© 2016 Dell Inc. All rights reserved. This product is protected by U.S. and international copyright and intellectual property laws. Dell and the Dell logo are trademarks of Dell Inc. in the United States and/or other jurisdictions. All other marks and names mentioned herein may be trademarks of their respective companies.

2015 - 12

Rev. A01

# Contents

|  |           |
|--|-----------|
| <b>1 About your system.....</b>                            | <b>8</b>  |
| Front-panel features and indicators.....                   | 8         |
| LCD panel features.....                                    | 14        |
| Home screen.....   | 15        |
| Setup menu.....  | 15        |
| View menu.....   | 15        |
| Diagnostic indicators.....                                 | 16        |
| Hot swappable hard drive indicator codes.....              | 17        |
| Back-panel features and indicators.....                    | 18        |
| NIC indicator codes.....                                   | 20        |
| Indicator codes for redundant power supply unit.....       | 20        |
| Non-redundant power supply unit indicator codes.....       | 22        |
| Documentation matrix.....                                  | 23        |
| Quick Resource Locator (QRL).....                          | 23        |
| <b>2 Performing initial system configuration .....</b>     | <b>25</b> |
| Setting up your system.....                                | 25        |
| Setting up and configuring the iDRAC IP address .....      | 25        |
| Logging in to iDRAC.....                                   | 25        |
| Installing the operating system.....                       | 26        |
| Managing your system remotely.....                         | 26        |
| Downloading and installing drivers and firmware.....       | 26        |
| <b>3 Pre-operating system management applications.....</b> | <b>28</b> |
| Navigation keys.....                                       | 28        |
| About system setup.....                                    | 29        |
| Entering System Setup.....                                 | 29        |
| System Setup Main Menu.....                                | 29        |
| System BIOS screen details.....                            | 29        |
| System Information screen details.....                     | 30        |
| Memory Settings screen.....                                | 31        |
| Processor Settings screen.....                             | 31        |
| SATA Settings screen details.....                          | 33        |
| Boot Settings screen details.....                          | 36        |
| Network Settings screen details.....                       | 37        |
| Integrated Devices screen details.....                     | 37        |
| Serial Communication screen details.....                   | 39        |
| System Profile Settings screen details.....                | 39        |

|  |    |
|--|----|
| System Security Settings details.....                              | 41 |
| Miscellaneous Settings screen details.....                         | 42 |
| About Boot Manager.....  | 43 |
| Entering Boot Manager .....  | 43 |
| Boot Manager main menu.....  | 43 |
| About Dell Lifecycle Controller.....                               | 44 |
| Changing the boot order.....                                       | 44 |
| Choosing the system boot mode.....                                 | 44 |
| Assigning a system and setup password.....                         | 45 |
| Using your system password to secure your system.....              | 45 |
| Deleting or changing an existing system and/or setup password..... | 46 |
| Operating with a setup password enabled.....                       | 46 |
| Embedded system management.....                                    | 47 |
| iDRAC Settings utility.....  | 47 |
| Entering the iDRAC Settings utility.....                           | 47 |
| Changing the Thermal Settings.....                                 | 47 |

#### **4 Installing and removing system components.....49**

|  |    |
|--|----|
| Safety instructions.....                           | 49 |
| Before working inside your system.....             | 49 |
| After working inside your system.....              | 50 |
| Recommended tools.....                             | 50 |
| Front bezel (optional).....                        | 50 |
| Installing the optional front bezel.....           | 50 |
| Removing the front bezel.....                      | 51 |
| Removing and installing the system cover.....      | 51 |
| Removing the system cover.....                     | 52 |
| Installing the system cover.....                   | 53 |
| Inside the system.....                             | 53 |
| Cooling shroud.....                                | 55 |
| Removing the cooling shroud.....                   | 56 |
| Installing the cooling shroud.....                 | 57 |
| System memory.....                                 | 57 |
| General memory module installation guidelines..... | 59 |
| Mode-specific guidelines.....                      | 59 |
| Sample memory configurations.....                  | 60 |
| Removing memory module.....                        | 62 |
| Installing memory modules.....                     | 63 |
| Hard drives.....                                   | 65 |
| Removing a 2.5 inch hard-drive blank.....          | 65 |
| Installing a 2.5 inch hard-drive blank.....        | 66 |
| Removing a 3.5 inch hard-drive blank.....          | 67 |

|  |    |
|--|----|
| Installing a 3.5 inch hard-drive blank.....                              | 68 |
| Removing a cabled hard drive.....  | 68 |
| Installing a cabled hard drive.....                                      | 69 |
| Removing a hot-swap hard drive.....                                      | 70 |
| Installing a hot-swap hard drive.....                                    | 71 |
| Installing a 2.5 inch hard drive into a 3.5 inch hard-drive adapter..... | 72 |
| Removing a 2.5 inch hard drive from a 3.5 inch hard-drive adapter.....   | 73 |
| Installing a hard-drive adapter into a hard-drive carrier.....           | 73 |
| Removing a hard-drive adapter from a hard-drive carrier.....             | 74 |
| Removing a hard drive from a hard-drive carrier.....                     | 74 |
| Installing a hard drive into a hard-drive carrier.....                   | 75 |
| Optical drive (optional).....  | 75 |
| Removing an ultra slim optical drive.....                                | 75 |
| Installing an ultra slim optical drive.....                              | 76 |
| Removing the standard optical drive.....                                 | 77 |
| Installing the standard optical drive.....                               | 78 |
| Cooling fans.....  | 79 |
| Removing a cooling fan.....  | 79 |
| Installing a cooling fan.....  | 80 |
| Internal USB memory key (optional).....                                  | 81 |
| Replacing the internal USB key.....                                      | 81 |
| Expansion cards and expansion-card risers (optional).....                | 82 |
| Expansion card installation guidelines.....                              | 82 |
| Removing the expansion-card riser.....                                   | 84 |
| Installing the expansion-card riser.....                                 | 85 |
| Removing an expansion card.....  | 85 |
| Installing an expansion card.....  | 86 |
| iDRAC ports card (optional).....   | 87 |
| Removing the iDRAC port card.....  | 87 |
| Installing the iDRAC port card.....                                      | 89 |
| SD vFlash media card.....  | 89 |
| Replacing an SD vFlash media card.....                                   | 89 |
| Internal dual SD module (optional).....                                  | 90 |
| Removing an internal SD card.....  | 90 |
| Installing an internal SD card.....                                      | 91 |
| Removing the optional internal dual SD module.....                       | 91 |
| Installing the optional internal dual SD module.....                     | 93 |
| Integrated storage controller card.....                                  | 93 |
| Removing the integrated storage controller card.....                     | 93 |
| Installing the integrated storage controller card.....                   | 95 |
| Heat sinks and processors.....   | 95 |
| Removing the heat sink.....  | 96 |

|  |     |
|--|-----|
| Removing a processor.....                    | 96  |
| Installing a processor.....                  | 99  |
| Installing the heat sink.....                | 102 |
| Power supplies.....                          | 103 |
| Hot spare feature.....                       | 104 |
| Removing a redundant power supply.....       | 104 |
| Installing a redundant power supply.....     | 105 |
| Removing a non-redundant power supply.....   | 106 |
| Installing a non-redundant power supply..... | 107 |
| Removing the power supply unit blank.....    | 108 |
| Installing the power supply unit blank.....  | 108 |
| System battery.....                          | 108 |
| Replacing the system battery.....            | 108 |
| Hard-drive backplane.....                    | 110 |
| Removing the hard-drive backplane.....       | 110 |
| Installing the hard-drive backplane.....     | 117 |
| Control-panel assembly.....                  | 117 |
| Removing the control panel.....              | 117 |
| Installing the control panel.....            | 120 |
| Removing the control-panel module.....       | 121 |
| Installing the control-panel module.....     | 124 |
| Power interposer board.....                  | 125 |
| Removing the power interposer board.....     | 125 |
| Installing the power interposer board.....   | 126 |
| System board.....                            | 127 |
| Removing the system board.....               | 127 |
| Installing the system board.....             | 129 |
| Trusted Platform Module.....                 | 131 |
| Installing the Trusted Platform Module ..... | 131 |
| Re-enabling the TPM for BitLocker users..... | 132 |
| Re-enabling the TPM for TXT users.....       | 132 |

## **5 Troubleshooting your system..... 133**

|   |     |
|---|-----|
| Safety first—for you and your system.....   | 133 |
| Troubleshooting system startup failure..... | 133 |
| Troubleshooting external connections.....   | 133 |
| Troubleshooting the video subsystem.....    | 133 |
| Troubleshooting a USB device.....           | 133 |
| Troubleshooting a serial I/O device.....    | 134 |
| Troubleshooting a NIC.....                  | 134 |
| Troubleshooting a wet system.....           | 135 |
| Troubleshooting a damaged system.....       | 136 |

|   |            |
|---|------------|
| Troubleshooting the system battery.....   | 136        |
| Troubleshooting power supply units.....   | 137        |
| Power source problems.....  | 137        |
| Power supply unit problems.....   | 137        |
| Troubleshooting cooling problems.....   | 138        |
| Troubleshooting cooling fans.....   | 138        |
| Troubleshooting system memory.....  | 139        |
| Troubleshooting an internal USB key.....  | 140        |
| Troubleshooting an SD card.....   | 140        |
| Troubleshooting an optical drive.....   | 141        |
| Troubleshooting a tape backup unit.....   | 142        |
| Troubleshooting a hard drive.....   | 142        |
| Troubleshooting a storage controller.....                                       | 143        |
| Troubleshooting expansion cards.....  | 144        |
| Troubleshooting processors.....   | 144        |
| System messages.....  | 145        |
| Warning messages.....   | 145        |
| Diagnostic messages.....  | 145        |
| Alert messages.....   | 145        |
| <b>6 Using system diagnostics.....</b>  | <b>146</b> |
| Dell Embedded System Diagnostics.....   | 146        |
| When to use the Embedded System Diagnostics.....                                | 146        |
| Running the Embedded System Diagnostics from Boot Manager.....                  | 146        |
| Running the Embedded System Diagnostics from the Dell Lifecycle Controller..... | 146        |
| System diagnostic controls.....   | 147        |
| <b>7 Jumpers and connectors.....</b>  | <b>148</b> |
| System board jumper settings.....   | 148        |
| System board connectors.....  | 149        |
| Disabling a forgotten password.....   | 151        |
| <b>8 Technical specifications.....</b>  | <b>152</b> |
| <b>9 Getting help.....</b>  | <b>158</b> |
| Contacting Dell.....  | 158        |
| Locating your system Service Tag.....   | 158        |
| Documentation feedback.....   | 158        |
| Quick Resource Locator (QRL).....   | 158        |

## About your system

The Dell PowerEdge R430 is a rack server that supports up to two processors based on the Intel Xeon EP E5-2600 v3 family, up to 12 DIMMs, and up to ten hard drives or SSDs.

The R430 systems are available in the following configurations:

**Table 1. System configurations**

| System                   | Configuration   |
|--------------------------|---|
| Four hard-drive systems  | Up to four 3.5-inch, cabled hard drives with non-redundant or redundant Power Supply Unit (PSU)<br>Up to four 3.5-inch, hot-swappable hard drives with non-redundant or redundant PSU |
| Eight hard-drive systems | Up to eight 2.5-inch, hot-swappable hard drives or SSDs with redundant PSU  |
| Ten hard-drive systems   | Up to ten 2.5-inch, hot-swappable hard drives or SSDs with redundant PSU  |

## Front-panel features and indicators

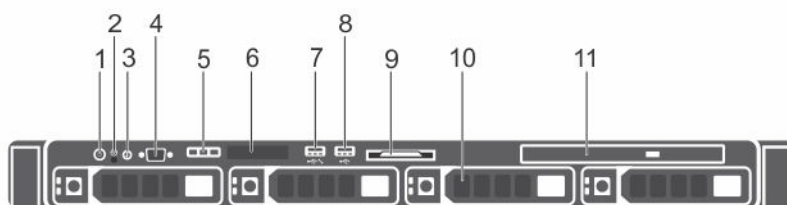







**Figure 1. Front-panel features and indicators—four 3.5 inch hot-swappable hard-drive chassis**

**Table 2. Front-panel features and indicators—four 3.5 inch hot-swappable hard-drive chassis**

| Item | Indicator, Button, or Connector  | Icon  | Description   |
|------|----------------------------------|---|---|
| 1    | Power-on indicator, power button |  | The power-on indicator lights when the system power is on. The power button controls the power supply output to the system. |



| Item | Indicator, Button, or Connector                | Icon  | Description   |
|------|--|---|---|
|      |  |   |  <b>NOTE:</b> On ACPI-compliant operating systems, turning off the system using the power button causes the system to perform a graceful shutdown before power to the system is turned off.  |
| 2    | NMI button                                     |    | <p>Used to troubleshoot software and device driver errors when running certain operating systems. This button can be pressed using the end of a paper clip.</p> <p>Use this button only if directed to do so by qualified support personnel or by the operating system's documentation.</p>   |
| 3    | System identification button                   |    | <p>The identification buttons on the front and back panels can be used to locate a particular system within a rack. When one of these buttons is pressed, the LCD panel on the front and the system status indicator on the back flashes until one of the buttons is pressed again.</p> <p>Press to toggle the system ID on and off.</p> <p>If the system stops responding during POST, press and hold the system ID button for more than five seconds to enter BIOS progress mode.</p> <p>To reset iDRAC (if not disabled in F2 iDRAC setup) press and hold the button for more than 15 seconds.</p> |
| 4    | Video connector                                |  | Allows you to connect a display to the system.  |
| 5    | LCD menu buttons                               |   | Allow you to navigate the control panel LCD menu.   |
| 6    | LCD panel                                      |   | <p>Displays system ID, status information, and system error messages. See <a href="#">LCD panel features</a>.</p> <p> <b>NOTE:</b> LCD panel is not available in a cabled hard-drive chassis.</p>  |
| 7    | USB management port/<br>iDRAC managed USB port |  | <p>The USB management port can function as a regular USB port or provide access to the iDRAC features. For more information, see the <i>Integrated Dell Remote Access Controller User's Guide</i> at <a href="http://Dell.com/idracmanuals">Dell.com/idracmanuals</a>.</p>  |
| 8    | USB connector                                  |  | Allows you to connect USB devices to the system. The port is USB 2.0-compliant.   |

| Item | Indicator, Button, or Connector | Icon | Description  |
|------|---------------------------------|------|--|
| 9    | Information tag                 |      | A slide-out label panel which contains system information such as Service Tag, NIC, MAC address, and so on for your reference. |
| 10   | Hard drives                     |      | Up to four 3.5 inch hot-swappable hard drives or SSDs.   |
| 11   | Optical drive (optional)        |      | One optional slim SATA DVD-ROM drive or DVD +/-RW drive.   |

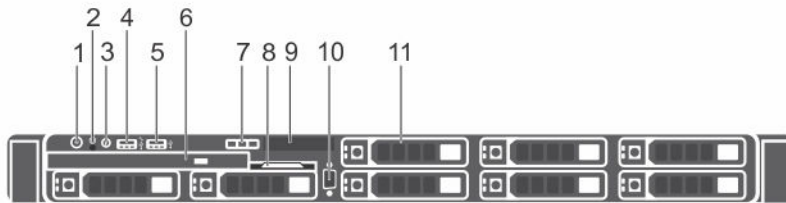





Figure 2. Front-panel features and indicators—eight 2.5 inch hot-swappable hard-drives or SSDs chassis

Table 3. Front-panel features and indicators—eight 2.5 inch hot-swappable hard-drives or SSDs

| Item | Indicator, Button, or Connector  | Icon | Description  |
|------|----------------------------------|------|--|
| 1    | Power-on indicator, power button |      | <p>The power-on indicator lights when the system power is on. The power button controls the power supply output to the system.</p> <p><b>NOTE:</b> On ACPI-compliant operating systems, turning off the system using the power button causes the system to perform a graceful shutdown before power to the system is turned off.</p> |
| 2    | NMI button                       |      | <p>Used to troubleshoot software and device driver errors when running certain operating systems. This button can be pressed using the end of a paper clip.</p> <p>Use this button only if directed to do so by qualified support personnel or by the operating system's documentation.</p>  |
| 3    | System identification button     |      | <p>The identification buttons on the front and back panels can be used to locate a particular system within a rack. When one of these buttons is pressed, the LCD panel on the front and the system status indicator on the back flashes until one of the buttons is pressed again.</p>  |

| Item | Indicator, Button, or Connector               | Icon  | Description  |
|------|---|---|--|
|      |   |   | Press to toggle the system ID on and off.<br><br>If the system stops responding during POST, press and hold the system ID button for more than five seconds to enter BIOS progress mode.<br><br>To reset iDRAC (if not disabled in F2 iDRAC setup) press and hold the button for more than 15 seconds. |
| 4    | USB management port or iDRAC managed USB port |    | The USB management port can function as a regular USB port or provide access to the iDRAC features. For more information, see the <i>Integrated Dell Remote Access Controller User's Guide</i> at <a href="http://Dell.com/idracmanuals">Dell.com/idracmanuals</a> .                                   |
| 5    | USB connector                                 |    | Allows you to connect USB devices to the system. The port is USB 2.0-compliant.  |
| 6    | Optical drive (optional)                      |   | One optional slim SATA DVD-ROM drive or DVD +/-RW drive.   |
| 7    | LCD menu buttons                              |   | Allow you to navigate the control panel LCD menu.  |
| 8    | Information tag                               |   | A slide-out label panel which contains system information such as Service Tag, NIC, MAC address, and so on for your reference.   |
| 9    | LCD panel                                     |   | Displays system ID, status information, and system error messages. See <a href="#">LCD panel features</a> .  |
| 10   | Video connector                               |  | Allows you to connect a VGA display to the system.   |
| 11   | Hard drives                                   |   | Up to eight 2.5-inch hot-swappable hard drives or SSDs.  |

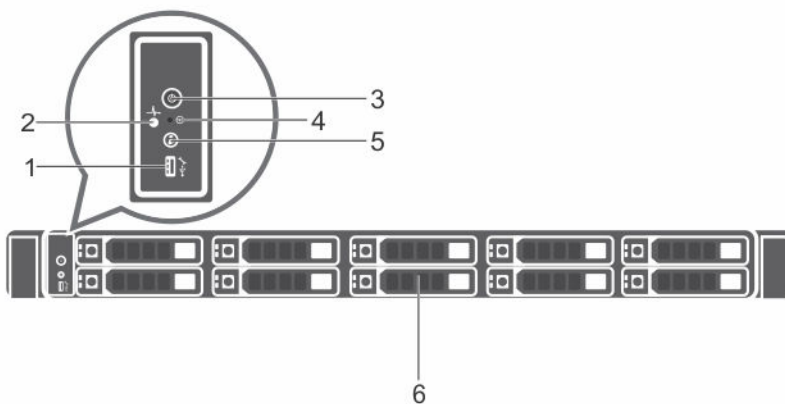







Figure 3. Front-panel features and indicators—ten 2.5-inch hot-swappable hard-drives or SSDs chassis

**Table 4. Front-panel features and indicators—ten 2.5-inch hot-swappable hard-drives or SSDs**

| Item | Indicator, Button, or Connector                   | Icon  | Description  |
|------|---|---|--|
| 1    | USB management port/<br>iDRAC managed USB<br>port |    | The USB management port can function as a regular USB port or provide access to the iDRAC features. For more information, see the <i>Integrated Dell Remote Access Controller User's Guide</i> at <a href="http://Dell.com/idracmanuals">Dell.com/idracmanuals</a> .   |
| 2    | Diagnostic indicator                              |   | The diagnostic indicator lights up to display error status. For more information, see <a href="#">Diagnostic indicators</a> .  |
| 3    | Power-on indicator,<br>power button               |    | The power-on indicator lights when the system power is on. The power button controls the power supply output to the system.<br><br> <b>NOTE:</b> On ACPI-compliant operating systems, turning off the system using the power button causes the system to perform a graceful shutdown before power to the system is turned off.  |
| 4    | NMI button  |    | Used to troubleshoot software and device driver errors when running certain operating systems. This button can be pressed using the end of a paper clip.<br><br>Use this button only if directed to do so by qualified support personnel or by the operating system's documentation.   |
| 5    | System identification<br>button                   |  | The identification buttons on the front and back panels can be used to locate a particular system within a rack. When one of these buttons is pressed, the LCD panel on the front and the system status indicator on the back flashes until one of the buttons is pressed again.<br>Press to toggle the system ID on and off.<br><br>If the system stops responding during POST, press and hold the system ID button for more than five seconds to enter BIOS progress mode.<br><br>To reset iDRAC (if not disabled in F2 iDRAC setup) press and hold the button for more than 15 seconds. |
| 6    | Hard drives                                       |   | Up to ten 2.5 inch hot-swappable hard drives/<br>SSDs.   |

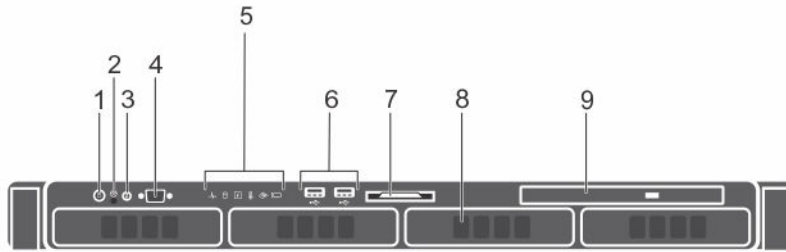



Figure 4. Front-panel features and indicators—four 3.5 inch cabled hard-drive chassis

Table 5. Front panel features and indicators of four 3.5-inch cabled hard-drive

| Item | Indicator, Button, or Connector  | Icon | Description  |
|------|----------------------------------|------|--|
| 1    | Power-on indicator, power button |      | <p>The power-on indicator lights when the system power is on. The power button controls the power supply output to the system.</p> <p> <b>NOTE:</b> On ACPI-compliant operating systems, turning off the system using the power button causes the system to perform a graceful shutdown before power to the system is turned off.</p>  |
| 2    | NMI button                       |      | <p>Used to troubleshoot software and device driver errors when running certain operating systems. This button can be pressed using the end of a paper clip.</p> <p>Use this button only if directed to do so by qualified support personnel or by the operating system's documentation.</p>  |
| 3    | System identification button     |      | <p>The identification buttons on the front and back panels can be used to locate a particular system within a rack. When one of these buttons is pressed, the system status indicator on the back flashes until one of the buttons is pressed again. Press to toggle the system ID on and off. If the system stops responding during POST, press and hold the system ID button for more than five seconds to enter BIOS progress mode.</p> <p>To reset the iDRAC (if not disabled in F2 iDRAC setup) press and hold the button for more than 15 seconds.</p> |
| 4    | Video connector                  |      | Allows you to connect a display to the system.   |

| Item | Indicator, Button, or Connector | Icon  | Description  |
|------|---------------------------------|---|--|
| 5    | Diagnostic indicators           |   | The diagnostic indicator lights up to display error status. For more information, see <a href="#">Diagnostic indicators</a> .  |
| 6    | USB connectors (2)              |  | Allow you to connect USB devices to the system. The ports are USB 2.0-compliant.   |
| 7    | Information tag                 |   | A slide-out label panel which contains system information such as Service Tag, NIC, MAC address, and so on for your reference. |
| 8    | Hard drives                     |   | Up to four 3.5 inch cabled hard drives.  |
| 9    | Optical drive (optional)        |   | One optional slim SATA DVD-ROM drive or DVD +/-RW drive.   |

## LCD panel features

The system's LCD panel provides system information and status and error messages to indicate if the system is operating correctly or if the system needs attention. For more information on error messages, see the *Dell Event and Error Messages Reference Guide* at [Dell.com/openmanagemanuals](http://Dell.com/openmanagemanuals) >**OpenManage software**.

- The LCD backlight lights blue during normal operating conditions.
- When the system needs attention, the LCD lights amber, and displays an error code followed by descriptive text.
  -  **NOTE:** If the system is connected to a power source and an error is detected, the LCD lights amber regardless of whether the system is turned on or off.
- The LCD backlight turns OFF when the system is in standby mode and can be turned on by pressing either the Select, Left, or Right button on the LCD panel.
- The LCD backlight remains OFF if LCD messaging is turned off through the iDRAC utility, the LCD panel, or other tools.

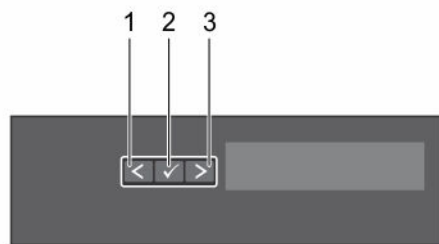

Figure 5. LCD panel features

Table 6. LCD panel features



| Item | Button | Description                                      |
|------|--------|--|
| 1    | Left   | Moves the cursor back in one-step increments.    |
| 2    | Select | Selects the menu item highlighted by the cursor. |

| Item | Button | Description  |
|------|--------|--|
| 3    | Right  | Moves the cursor forward in one-step increments.<br>During message scrolling: <ul style="list-style-type: none"> <li>• Press once to increase scrolling speed</li> <li>• Press again to stop</li> <li>• Press again to return to the default scrolling speed</li> <li>• Press again to repeat the cycle</li> </ul> |

## Home screen

The Home screen displays user-configurable information about the system. This screen is displayed during normal system operation when there are no status messages or errors. When the system is in standby mode, the LCD backlight turns off after five minutes of inactivity if there are no error messages. Press one of the three navigation buttons (Select, Left, or Right) to view the Home screen.

To navigate to the **Home** screen from another menu, complete the following steps:

1. Press and hold the up arrow  until the **Home** icon  is displayed.
2. Select the **Home** icon.
3. From the **Home** screen, press the **Select** button to enter the main menu.

## Setup menu

 **NOTE:** When you select an option in the Setup menu, you must confirm the option before proceeding to the next action.

| Option    | Description  |
|-----------|--|
| iDRAC     | Select <b>DHCP</b> or <b>Static IP</b> to configure the network mode. If <b>Static IP</b> is selected, the available fields are <b>IP</b> , <b>Subnet (Sub)</b> , and <b>Gateway (Gtw)</b> . Select <b>Setup DNS</b> to enable DNS and to view domain addresses. Two separate DNS entries are available.   |
| Set error | Select <b>SEL</b> to view LCD error messages in a format that matches the IPMI description in the SEL. This is useful when trying to match an LCD message with an SEL entry.<br><br>Select <b>Simple</b> to view LCD error messages in a simplified user-friendly description. For more information about error messages, see the Dell Event and Error Messages Reference Guide at <a href="http://Dell.com/openmanagemanuals">Dell.com/openmanagemanuals</a> > <b>OpenManage software</b> . |
| Set home  | Select the default information to be displayed on the <b>Home</b> screen. See <a href="#">View menu</a> for the options and option items that can be set as the default on the <b>Home</b> screen.   |

## View menu

 **NOTE:** When you select an option in the View menu, you must confirm the option before proceeding to the next action.

| Option      | Description  |
|-------------|--|
| iDRAC IP    | Displays the <b>IPv4</b> or <b>IPv6</b> addresses for iDRAC8. Addresses include <b>DNS (Primary and Secondary)</b> , <b>Gateway, IP</b> , and <b>Subnet</b> (IPv6 does not have Subnet). |
| MAC         | Displays the MAC addresses for <b>iDRAC</b> , <b>iSCSI</b> , or <b>Network</b> devices.  |
| Name        | Displays the name of the <b>Host</b> , <b>Model</b> , or <b>User String</b> for the system.  |
| Number      | Displays the <b>Asset tag</b> or the <b>Service tag</b> for the system.  |
| Power       | Displays the power output of the system in BTU/hr or Watts. The display format can be configured in the <b>Set home</b> submenu of the <b>Setup</b> menu.                                |
| Temperature | Displays the temperature of the system in Celsius or Fahrenheit. The display format can be configured in the <b>Set home</b> submenu of the <b>Setup</b> menu.                           |



## Diagnostic indicators

The diagnostic indicators on the system front panel display error status during system startup.



 **NOTE:** The diagnostic indicators are not present if the system is equipped with an LCD display.

 **NOTE:** No diagnostic indicators are lit when the system is turned off. To start the system, plug it into a working power source and press the power button.

**Table 7. Diagnostic indicators**

| Icon  | Description          | Condition  | Corrective action  |
|---|----------------------|--|--|
|  | Health indicator     | If the system is turned on and in good health, the indicator turns solid blue.<br><br>The indicator flashes amber if the system is turned on or in standby, and if any error exists (for example, a failed fan or hard drive). | None required.<br><br>Check the System Event Log or system messages for the specific issue. For more information about error messages, see the <i>Dell Event and Error Messages Reference Guide</i> at <a href="http://Dell.com/openmanagemanuals">Dell.com/openmanagemanuals</a> > <b>OpenManage software</b> .<br><br>Invalid memory configurations can cause the system to halt at startup without any video output. See <a href="#">Getting help</a> . |
|  | Hard drive indicator | The indicator flashes amber if there is a hard drive error.  | Check the System Event Log to determine the hard drive that has an error. Run the appropriate Online Diagnostics test. Restart the system and run embedded diagnostics (ePSA). If the hard drives are configured in a RAID array, restart the system and enter the host adapter configuration utility program.   |
|  | Electrical indicator | The indicator flashes amber if the system experiences an electrical error (for example,  | Check the System Event Log or system messages for the specific issue. If it is due to a problem with the PSU, check the LED  |



| Icon  | Description           | Condition   | Corrective action   |
|---|-----------------------|---|---|
|   |                       | voltage out of range, or a failed power supply unit (PSU) or voltage regulator).  | on the PSU. Reseat the PSU. If the problem persists, see <a href="#">Getting help</a> .   |
|  | Temperature indicator | The indicator flashes amber if the system experiences a thermal error (for example, a temperature out of range or fan failure). | <p>Ensure that none of the following conditions exist:</p> <ul style="list-style-type: none"> <li>• A cooling fan has been removed or has failed.</li> <li>• System cover, cooling shroud, EMI filler panel, memory module blank, or back filler bracket is removed.</li> <li>• Ambient temperature is too high.</li> <li>• External airflow is obstructed.</li> </ul> <p>See <a href="#">Getting help</a>.</p> |
|  | Memory indicator      | The indicator flashes amber if a memory error occurs.   | Check the system event log or system messages for the location of the failed memory. Reseat the memory module. If the problem persists, see <a href="#">Getting help</a> .  |
|  | PCIe indicator        | The indicator flashes amber if a PCIe card experiences an error.  | Restart the system. Update any required drivers for the PCIe card. Reinstall the card. If the problem persists, see <a href="#">Getting help</a> .  |

## Hot swappable hard drive indicator codes

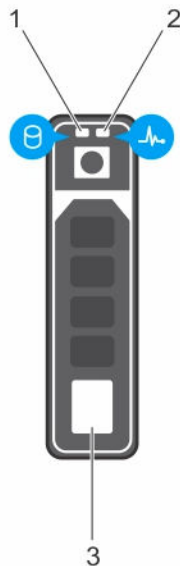

**Figure 6. Hot swappable hard drive indicators**

1. hard drive activity indicator
2. hard drive status indicator
3. hard drive

**NOTE:** If the hard drive is in Advanced Host Controller Interface (AHCI) mode, the status indicator (on the right side) does not function and remains OFF.

**Table 8. Hot swappable hard drive indicators**



| Drive-status indicator pattern (RAID only)                                  | Condition  |
|---|--|
| Flashes green two times per second  | Identifying drive or preparing for removal.  |
| OFF   | Drive ready for insertion or removal.  |
|   | <b>NOTE:</b> The drive status indicator remains OFF until all hard drives are initialized after the system is turned on. Drives are not ready for insertion or removal during this time. |
| Flashes green, amber, and turns off   | Predicted drive failure  |
| Flashes amber four times per second   | Drive failed   |
| Flashes green slowly  | Drive rebuilding   |
| Turns green   | Drive online   |
| Flashes green three seconds, amber three seconds, and turns off six seconds | Rebuild stopped  |

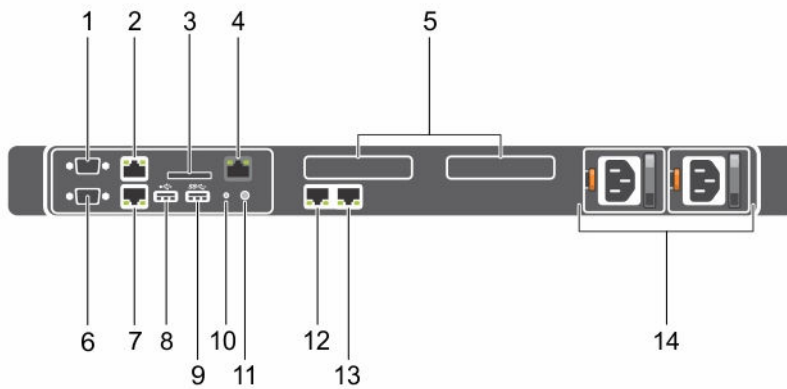





## Back-panel features and indicators



**Figure 7. Back-panel features and indicators**

**Table 9. Back-panel features and indicators**

| Item | Indicator, Button, or Connector | Icon  | Description  |
|------|---------------------------------|---|--|
| 1    | Serial connector                |  | Allows you to connect a serial device to the system. |
| 2    | Ethernet connector 1            |  | Integrated 10/100/1000 Mbps NIC connector.           |

| Item | Indicator, Button, or Connector   | Icon  | Description   |
|------|-----------------------------------|---|---|
| 3    | vFlash card slot (optional)       |   | Allows you to connect the vFlash card.  |
| 4    | iDRAC port (optional)             |   | Dedicated management port on the iDRAC ports card.  |
| 5    | PCIe expansion card slots (2)     |   | Allows you to connect a PCI Express expansion card.   |
| 6    | Video connector                   |    | Allows you to connect a VGA display to the system.  |
| 7    | Ethernet connector 2              |    | Integrated 10/100/1000 Mbps NIC connector.  |
| 8    | USB connector                     |    | Allow you to connect USB devices to the system. The port is USB 2.0-compliant.  |
| 9    | USB connector                     |    | Allow you to connect USB devices to the system. The port is USB 3.0-compliant.  |
| 10   | System identification button      |    | <p>The identification buttons on the front and back panels can be used to locate a particular system within a rack. When one of these buttons is pressed, the system status indicator on the back flashes until one of the buttons is pressed again.</p> <p>Press to toggle the system ID on and off. If the system stops responding during POST, press and hold the system ID button for more than five seconds to enter BIOS progress mode.</p> <p>To reset the iDRAC (if not disabled in F2 iDRAC setup) press and hold the button for more than 15 seconds.</p> |
| 11   | System identification connector   |   | Connects the optional system status indicator assembly through the optional cable management arm.   |
| 12   | Ethernet connector 3              |  | 10/100/1000 Mbps NIC connector.   |
| 13   | Ethernet connector 4              |   |   |
| 14   | Power supply unit (PSU1 and PSU2) |   | <p><b>Redundant power supply</b> Up to two 550 W redundant AC power supplies.</p> <p><b>Non-redundant power supply</b> One 450 W non-redundant AC power supply.</p> <p> <b>NOTE:</b> Non-redundant power supply is supported in systems with cabled hard drives and the systems with x4 backplane.</p>   |

| Item | Indicator, Button, or Connector | Icon | Description |
|------|---------------------------------|------|-------------|
|------|---------------------------------|------|-------------|

 **NOTE:** For non-redundant power supply units, there is only one power supply socket.

## NIC indicator codes

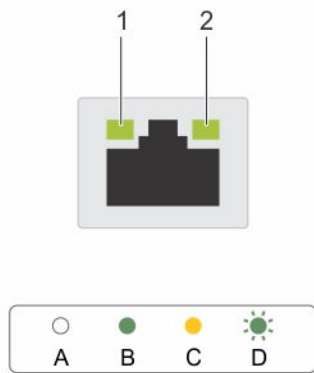

**Figure 8. NIC indicators**

1. link indicator
2. activity indicator

**Table 10. NIC indicators**

| Convention | Indicator pattern                    | Description  |
|------------|--------------------------------------|--|
| A          | Link and activity indicators are OFF | The NIC is not connected to the network.                                     |
| B          | Link indicator is green              | The NIC is connected to a valid network at its maximum port speed (1 Gbps).  |
| C          | Link indicator is yellow             | The NIC is connected to a valid network at less than its maximum port speed. |
| D          | Activity indicator is flashing green | Network data is being sent or received.                                      |

## Indicator codes for redundant power supply unit

Each AC power supply unit (PSU) has an illuminated translucent handle that indicates whether power is present or whether a power fault has occurred.



**Figure 9. AC PSU status indicator**

1. AC PSU status indicator or handle

**Table 11. Redundant AC PSU status indicator**

| Convention | Power Indicator Pattern      | Condition   |
|------------|------------------------------|---|
| A          | Green                        | A valid power source is connected to the PSU and the PSU is operational.  |
| B          | Flashing green               | When the PSU firmware is being updated, the PSU handle flashes green.<br><br><b>⚠ CAUTION: Do not disconnect the power cord or unplug the PSU when updating firmware. If firmware update is interrupted, the PSUs will not function. You must roll back the PSU firmware by using Dell Lifecycle Controller. For more information, see Dell Lifecycle Controller User's Guide at <a href="http://Dell.com/idracmanuals">Dell.com/idracmanuals</a>.</b>  |
| C          | Flashing green and turns off | When hot-adding a PSU, the PSU handle flashes green five times at 4 Hz rate and turns off. This indicates that there is a PSU mismatch with respect to efficiency, feature set, health status, and supported voltage. Ensure that both the PSUs are the same.<br><br><b>📝 NOTE: For AC PSUs, use only PSUs with the Extended Power Performance (EPP) label on the back. Mixing PSUs from previous generations of Dell PowerEdge servers can result in a PSU mismatch condition or failure to turn on.</b> |
| D          | Flashing amber               | Indicates a problem in the PSU.   |

| Convention | Power Indicator Pattern | Condition  |
|------------|-------------------------|--|
|            |                         | <p>△ CAUTION: When correcting a PSU mismatch, replace only the PSU with the flashing indicator. Swapping the other PSU to make a matched pair can result in an error condition and unexpected system shutdown. To change from a High Output configuration to a Low Output configuration or vice versa, you must turn off the system.</p> <p>△ CAUTION: AC PSUs support both 220 V and 110 V input voltages with the exception of Titanium PSUs, which support only 220 V. When two identical PSUs receive different input voltages, they can output different wattages, and trigger a mismatch.</p> <p>△ CAUTION: If two PSUs are used, they must be of the same type and have the same maximum output power.</p> <p>△ CAUTION: Combining AC and DC PSUs is not supported and triggers a mismatch.</p> |
| E          | Not lit                 | Power is not connected.  |

## Non-redundant power supply unit indicator codes

Press the self-diagnostic button to perform a quick health check on the non-redundant power supply unit (PSU) of the system.

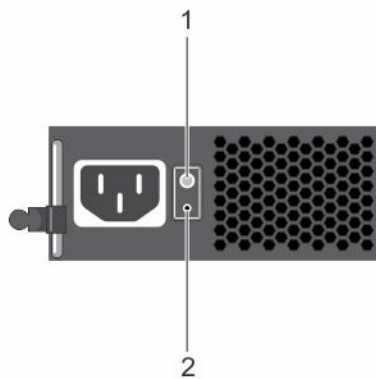

Figure 10. Non-redundant AC PSU status indicator and self-diagnostic button

1. self-diagnostic button
2. AC power supply unit status indicator

Table 12. Non-redundant AC PSU status indicator

| Power Indicator Pattern | Condition  |
|-------------------------|--|
| Not lit                 | Power is not connected or PSU is faulty.                                 |
| Green                   | A valid power source is connected to the PSU and the PSU is operational. |

## Documentation matrix

The documentation matrix provides information on documents that you can refer to for setting up and managing your system.

**Table 13. Documentation matrix**

| To...   | See the...   |
|---|--|
| Install your system into a rack   | Rack documentation included with your rack solution  |
| Set up your system and know the system technical specifications   | <i>Getting Started With Your System</i> that shipped with your system or see <b>Dell.com/poweredgemanuals</b>                      |
| Install the operating system  | Operating system documentation at <b>Dell.com/operatingsystemmanuals</b>   |
| Get an overview of the Dell Systems Management offerings  | <i>Dell OpenManage Systems Management Overview Guide</i> at <b>Dell.com/openmanagemanuals &gt; OpenManage software</b>             |
| Configure and log in to iDRAC, set up managed and management system, know the iDRAC features, and troubleshoot by using iDRAC | <i>Integrated Dell Remote Access Controller User's Guide</i> at <b>Dell.com/idracmanuals</b>                                       |
| Know about the RACADM subcommands and supported RACADM interfaces   | <i>RACADM Command Line Reference Guide</i> for iDRAC at <b>Dell.com/idracmanuals</b>   |
| Launch, enable, and disable Dell Lifecycle Controller, know the features, use and troubleshoot Dell Lifecycle Controller      | <i>Dell Lifecycle Controller User's Guide</i> at <b>Dell.com/idracmanuals</b>  |
| Use Dell Lifecycle Controller Remote Services   | <i>Dell Lifecycle Controller Remote Services Quick Start Guide</i> at <b>Dell.com/idracmanuals</b>                                 |
| Set up, use, and troubleshoot OpenManage Server Administrator   | <i>Dell OpenManage Server Administrator User's Guide</i> at <b>Dell.com/openmanagemanuals &gt; OpenManage Server Administrator</b> |
| Install, use, and troubleshoot OpenManage Essentials  | <i>Dell OpenManage Essentials User's Guide</i> at <b>Dell.com/openmanagemanuals &gt; OpenManage Essentials</b>                     |
| Know the features of the storage controller cards, deploy the cards, and manage the storage subsystem                         | Storage controller documentation at <b>Dell.com/storagecontrollermanuals</b>   |
| Check the event and error messages generated by the system firmware and agents that monitor system components                 | <i>Dell Event and Error Messages Reference Guide</i> at <b>Dell.com/openmanagemanuals &gt; OpenManage software</b>                 |

## Quick Resource Locator (QRL)

Use the Quick Resource Locator (QRL) to get immediate access to system information and how-to videos. This can be done by visiting **dell.com/QRL** or by using your smartphone or tablet and a model

specific Quick Resource (QR) code located on your Dell PowerEdge system. To try out the QR code, scan the following image.



**Figure 11. Quick Resource Locator**



# Performing initial system configuration

After you receive your PowerEdge system, you must set up your system, install the operating system if it is not pre-installed, and set up and configure the system iDRAC IP address.

## Setting up your system

1. Unpack the server.
2. Install the server into the rack. For more information on installing the server into the rack, see your system *Rack Installation Placemat* at [dell.com/poweredgemanuals](http://dell.com/poweredgemanuals).
3. Connect the peripherals to the system.
4. Connect the system to its electrical outlet.
5. Turn the system on by pressing the power button or using iDRAC.
6. Turn on the attached peripherals.

## Setting up and configuring the iDRAC IP address

You can set up the Integrated Dell Remote Access Controller (iDRAC) IP address by using one of the following interfaces:

- iDRAC Settings utility
- Lifecycle Controller
- Dell OpenManage Deployment Toolkit
- Server LCD panel

You can configure iDRAC IP address by using the following interfaces:

- iDRAC Web interface. For more information, see the *Integrated Dell Remote Access Controller User's Guide*.
- Remote Access Controller Admin (RACADM). For more information, see the *RACADM Command Line Interface Reference Guide* and the *Integrated Dell Remote Access Controller User's Guide*.
- Remote Services that includes Web Services Management (WS-Man). For more information, see the *Lifecycle Controller Remote Services Quick Start Guide*.

For more information on setting up and configuring iDRAC, see the *Integrated Dell Remote Access Controller User's Guide* at [dell.com/esmmanuals](http://dell.com/esmmanuals).

## Logging in to iDRAC

You can log in to iDRAC as an iDRAC local user, a Microsoft Active Directory user, or a Lightweight Directory Access Protocol (LDAP) user. You can also log in by using Single Sign-On or a Smart Card. The

default user name is **root** and password is **calvin**. For more information on logging in to iDRAC and iDRAC licenses, see the Integrated Dell Remote Access Controller User's Guide at [dell.com/esmmanuals](http://dell.com/esmmanuals).

You can also access iDRAC using RACADM. For more information, see the RACADM Command Line Interface Reference Guide and the Integrated Dell Remote Access Controller User's Guide available at [dell.com/esmmanuals](http://dell.com/esmmanuals).

## Installing the operating system

If the server is shipped without an operating system, install the supported operating system on the server by using one of the following methods:

- Dell Systems Management Tools and Documentation media. See the operating system documentation at [dell.com/operatingsystemmanuals](http://dell.com/operatingsystemmanuals).
- Dell Lifecycle Controller. See the Lifecycle Controller documentation at [dell.com/esmmanuals](http://dell.com/esmmanuals).
- Dell OpenManage Deployment Toolkit. See the OpenManage documentation at [dell.com/openmanagemanuals](http://dell.com/openmanagemanuals).

For information on the list of operating systems supported on your system, see the operating systems support matrix at [dell.com/ossupport](http://dell.com/ossupport).

## Managing your system remotely

To perform out-of-band systems management using iDRAC, you must configure iDRAC for remote accessibility, set up the management station and managed system, and configure the supported Web browsers. For more information, see the Integrated Dell Remote Access Controller User's Guide at [dell.com/esmmanuals](http://dell.com/esmmanuals).

You can also remotely monitor and manage the server by using the Dell OpenManage Server Administrator (OMSA) software and OpenManage Essentials (OME) systems management console. For more information, see [dell.com/openmanagemanuals](http://dell.com/openmanagemanuals).

## Downloading and installing drivers and firmware

It is recommended that you download and install the latest BIOS, drivers, and systems management firmware on your system.

### Prerequisites

Ensure that you clear the web browser cache.

### Steps

1. Go to [dell.com/support/drivers](http://dell.com/support/drivers).
2. In the **Product Selection** section, enter the Service Tag of your system in the **Service Tag or Express Service Code** field.

 **NOTE:** If you do not have the Service Tag, select **Automatically detect my Service Tag for me** to allow the system to automatically detect your Service Tag, or select **Choose from a list of all Dell products** to select your product from the **Product Selection** page.

3. Click **Get drivers and downloads**.

The drivers that are applicable to your selection are displayed.

4. Download the drivers you require to a diskette drive, USB drive, CD, or DVD.

# Pre-operating system management applications

The pre-operating system management applications for your PowerEdge system help you manage different settings and features of your system without booting to the operating system.

Your PowerEdge system has the following pre-operating system management applications:

- System Setup
- Boot Manager
- Dell Lifecycle Controller

## Navigation keys

The navigation keys can help you quickly access the pre-operating system management applications.

| Key        | Description  |
|------------|--|
| F2         | Enables you to enter <b>System Setup</b> .   |
| F10        | Enables you to enter system services and starts <b>Lifecycle Controller</b> .  |
| F11        | Enables you to enter <b>Boot Manager</b> .   |
| F12        | Enables you to enter <b>PXE Boot</b> .   |
| Page Up    | Enables you to move to the previous screen.  |
| Page Down  | Enables you to move to the next screen.  |
| Up arrow   | Enables you to move to the previous field.   |
| Down arrow | Enables you to move to the next field.   |
| Enter      | Enables you to type a value in the selected field (if applicable).   |
| Spacebar   | Enables you to expand or collapse a drop-down list, if applicable.   |
| Tab        | Enables you to move to the next menu item.   |
|            |  <b>NOTE:</b> This feature is applicable only for the standard graphic browser.   |
| Esc        | Enables you to move to the previous page until you view the main screen. Pressing Esc in the main screen exits <b>System BIOS, iDRAC Settings, Device Settings, or Service Tag Settings</b> , and proceeds with system boot. |
| F1         | Displays the system setup help.  |

## About system setup

By using the **System Setup** screen, you can configure the BIOS settings, iDRAC settings, and device settings of your system.

 **NOTE:** Help text for the selected field is displayed in the graphical browser by default. To view the help text in the text browser, press F1.

You can access system setup in two ways:

- Standard graphical browser—The browser is enabled by default.
- Text Browser—The browser is enabled by using Console Redirection.

### Entering System Setup

1. Turn on, or restart your system.
2. Press F2 immediately after you see the following message:  
F2 = System Setup

If your operating system begins to load before you press F2, wait for the system to finish booting, and then restart your system and try again.

### System Setup Main Menu

The **System Setup Main Menu** screen details are explained as follows:

| Option                 | Description  |
|------------------------|--|
| <b>System BIOS</b>     | Enables you to configure BIOS settings.  |
| <b>iDRAC Settings</b>  | Enables you to configure iDRAC settings.<br>The iDRAC settings utility is an interface to set up and configure the iDRAC parameters by using UEFI. You can enable or disable various iDRAC parameters by using the iDRAC settings utility. For more information about this utility, see <i>Integrated Dell Remote Access Controller User's Guide</i> at <a href="http://Dell.com/idracmanuals">Dell.com/idracmanuals</a> . |
| <b>Device Settings</b> | Enables you to configure device settings.  |

### System BIOS screen details

You can use the **System BIOS** screen to edit specific functions such as boot order, system password, setup password, set the RAID mode, and enable or disable USB ports.

To view the **System BIOS** screen, click **System Setup Main Menu** → **System BIOS**.

The **System BIOS** screen details are explained as follows:

| Option                    | Description   |
|---------------------------|---|
| <b>System Information</b> | Displays information about the system such as the system model name, BIOS version, and Service Tag. |
| <b>Memory Settings</b>    | Displays information and options related to the installed memory.                                   |

| Option                         | Description   |
|--------------------------------|---|
| <b>Processor Settings</b>      | Displays information and options related to the processor such as speed, cache size.  |
| <b>SATA Settings</b>           | Displays options to enable or disable the integrated SATA controller and ports.   |
| <b>Boot Settings</b>           | Displays options to specify the boot mode (BIOS or UEFI). Enables you to modify UEFI and BIOS boot settings.  |
| <b>Network Settings</b>        | Displays options to change the network settings.  |
| <b>Integrated Devices</b>      | Displays options to manage integrated device controllers and ports and specify related features and options.  |
| <b>Serial Communication</b>    | Displays options to manage the serial ports and specify related features and options.   |
| <b>System Profile Settings</b> | Displays options to change the processor power management settings, memory frequency, and so on.  |
| <b>System Security</b>         | Displays options to configure the system security settings, such as system password, setup password, Trusted Platform Module (TPM) security. It also manages the power and NMI buttons on the system. |
| <b>Miscellaneous Settings</b>  | Displays options to change the system date, time, and so on.  |

## System Information screen details

You can use the **System Information** screen to view system properties such as Service Tag, system model name, and the BIOS version.

To view the **System Information** screen, click **System Setup Main Menu** → **System BIOS** → **System Information**.

The **System Information** screen details are explained as follows:

| Option   | Description   |
|--|---|
| <b>System Model Name</b>                       | Displays the system model name.   |
| <b>System BIOS Version</b>                     | Displays the BIOS version installed on the system.  |
| <b>System Management Engine Version</b>        | Displays the current version of the Management Engine firmware.                               |
| <b>System Service Tag</b>                      | Displays the system Service Tag.  |
| <b>System Manufacturer</b>                     | Displays the name of the system manufacturer.   |
| <b>System Manufacturer Contact Information</b> | Displays the contact information of the system manufacturer.                                  |
| <b>System CPLD Version</b>                     | Displays the current version of the system complex programmable logic device (CPLD) firmware. |

| Option                         | Description  |
|--------------------------------|--|
| <b>UEFI Compliance Version</b> | Displays the UEFI compliance level of the system firmware. |

## Memory Settings screen

You can use the **Memory Settings** screen to view all the memory settings as well as enable or disable specific memory functions such as system memory testing and node interleaving. To view the **Memory Setting** screen, click **System Setup Main Menu** → **System BIOS** → **Memory Settings**.

| Option                       | Description   |
|------------------------------|---|
| <b>System Memory Size</b>    | Displays the amount of memory installed in the system.  |
| <b>System Memory Type</b>    | Displays the type of memory installed in the system.  |
| <b>System Memory Speed</b>   | Displays the system memory speed.   |
| <b>System Memory Voltage</b> | Displays the system memory voltage.   |
| <b>Video Memory</b>          | Displays the amount of video memory utilized.   |
| <b>System Memory Testing</b> | Specifies whether system memory tests are run during system boot. Options are <b>Enabled</b> and <b>Disabled</b> . By default, the <b>System Memory Testing</b> option is set to <b>Disabled</b> .  |
| <b>Memory Operating Mode</b> | Specifies the memory operating mode. The options available are <b>Optimizer Mode</b> , <b>Advanced ECC Mode</b> , <b>Mirror Mode</b> , <b>Spare Mode</b> , and <b>Spare with Advanced ECC Mode</b> . By default, the <b>Memory Operating Mode</b> option is set to <b>Optimizer Mode</b> .<br><br> <b>NOTE:</b> The <b>Memory Operating Mode</b> can have different defaults and available options based on the memory configuration of your system. |
| <b>Node Interleaving</b>     | Specifies if Non-Uniform Memory architecture (NUMA) is supported. If this field is <b>Enabled</b> , memory interleaving is supported if a symmetric memory configuration is installed. If <b>Disabled</b> , the system supports NUMA (asymmetric) memory configurations. By default, <b>Node Interleaving</b> option is set to <b>Disabled</b> .  |
| <b>Snoop Mode</b>            | Specifies the Snoop Mode options. Snoop Mode options available are <b>Home Snoop</b> , <b>Early Snoop</b> , and <b>Cluster on Die</b> . By default, the Snoop Mode option is set to <b>Early Snoop</b> . The field is only available when Node Interleaving is <b>Disabled</b> .  |



## Processor Settings screen

You can use the **Processor Settings** screen to view the processor settings and perform specific functions such as enabling virtualization technology, hardware prefetcher, and logical processor idling. To view the **Processor Settings** screen, click **System Setup Main Menu** → **System BIOS** → **Processor Settings**.

| Option                   | Description   |
|--------------------------|---|
| <b>Logical Processor</b> | Enables or disables the logical processors and displays the number of logical processors. If the <b>Logical Processor</b> option is set to <b>Enabled</b> , the BIOS displays all the logical processors. If this option is set to <b>Disabled</b> , the BIOS displays only one |

| Option   | Description  |
|--|--|
|  | logical processor per core. By default, the <b>Logical Processor</b> option is set to <b>Enabled</b> .   |
| <b>Alternate RTID (Requestor Transaction ID) Setting</b> | Enables you to allocate more RTIDs to the remote socket, thereby increasing cache performance between the sockets or easing work in normal mode for NUMA. By default, the <b>Alternate RTID (Requestor Transaction ID) Setting</b> is set to <b>Disabled</b> .                             |
| <b>Virtualization Technology</b>                         | Enables or disables the additional hardware capabilities provided for virtualization. By default, the <b>Virtualization Technology</b> option is set to <b>Enabled</b> .   |
| <b>Address Translation Service (ATS)</b>                 | Defines the Address Translation Cache (ATC) for devices to cache the DMA transactions. This field provides an interface to a chipset's Address Translation and Protection Table to translate DMA addresses to host addresses. By default, the option is set to <b>Enabled</b> .            |
| <b>Adjacent Cache Line Prefetch</b>                      | Optimizes the system for applications that require high utilization of sequential memory access. By default, the <b>Adjacent Cache Line Prefetch</b> option is set to <b>Enabled</b> . You can disable this option for applications that require high utilization of random memory access. |
| <b>Hardware Prefetcher</b>                               | Enables or disables the hardware prefetcher. By default, the <b>Hardware Prefetcher</b> option is set to <b>Enabled</b> .  |
| <b>DCU Streamer Prefetcher</b>                           | Allows you to enable or disable the Data Cache Unit (DCU) streamer prefetcher. By default, the <b>DCU Streamer Prefetcher</b> option is set to <b>Enabled</b> .  |
| <b>DCU IP Prefetcher</b>                                 | Enables or disables the Data Cache Unit (DCU) IP prefetcher. By default, the <b>DCU IP Prefetcher</b> option is set to <b>Enabled</b> .  |
| <b>Execute Disable</b>                                   | Enables or disables the execute disable memory protection technology. By default, the <b>Execute Disable</b> option is set to <b>Enabled</b> .   |
| <b>Logical Processor Idling</b>                          | Enables or disables the operating system capability to put logical processors in the idling state in order to reduce power consumption. By default, the option is set to <b>Disabled</b> .   |
| <b>Configurable TDP</b>                                  | Allows reconfiguration of Thermal Design Power (TDP) to lower levels. TDP refers to the maximum amount of power the cooling system is required to dissipate.   |
| <b>X2Apic Mode</b>                                       | Enables or disables the X2Apic mode.   |
| <b>Number of Cores per Processor</b>                     | Controls the number of enabled cores in each processor. By default, the <b>Number of Cores per Processor</b> option is set to <b>All</b> .   |
| <b>Hardware Prefetcher</b>                               | Enables or disables the hardware prefetcher. By default, the <b>Hardware Prefetcher</b> option is set to <b>Enabled</b> .  |
| <b>DCU Streamer Prefetcher</b>                           | Allows you to enable or disable the Data Cache Unit (DCU) streamer prefetcher. By default, the <b>DCU Streamer Prefetcher</b> option is set to <b>Enabled</b> .  |
| <b>DCU IP Prefetcher</b>                                 | Enables or disables the Data Cache Unit (DCU) IP prefetcher. By default, the <b>DCU IP Prefetcher</b> option is set to <b>Enabled</b> .  |
| <b>Execute Disable</b>                                   | Enables or disables the execute disable memory protection technology. By default, the <b>Execute Disable</b> option is set to <b>Enabled</b> .   |



| Option                               | Description   |
|--------------------------------------|---|
| <b>Logical Processor Idling</b>      | Enables or disables the operating system capability to put logical processors in the idling state in order to reduce power consumption. By default, the option is set to <b>Disabled</b> .  |
| <b>Configurable TDP</b>              | Allows reconfiguration of Thermal Design Power (TDP) to lower levels. TDP refers to the maximum amount of power the cooling system is required to dissipate.  |
| <b>X2Apic Mode</b>                   | Enables or disables the X2Apic mode.  |
| <b>Number of Cores per Processor</b> | Controls the number of enabled cores in each processor. By default, the <b>Number of Cores per Processor</b> option is set to <b>All</b> .  |
| <b>Processor 64-bit Support</b>      | Specifies if the processor(s) support 64-bit extensions.  |
| <b>Processor Core Speed</b>          | Displays the maximum core frequency of the processor.   |
| <b>Processor Bus Speed</b>           | Displays the bus speed of the processor.<br> <b>NOTE:</b> The processor bus speed option displays only when both processors are installed.   |
| <b>Processor 1</b>                   |  <b>NOTE:</b> Depending on the number of installed CPUs, there may be up to two processor listings. The following settings are displayed for each processor installed in the system. |
| <b>Family-Model-Stepping</b>         | Displays the family, model and stepping of the processor as defined by Intel.   |
| <b>Brand</b>                         | Displays the brand name reported by the processor.  |
| <b>Level 2 Cache</b>                 | Displays the total L2 cache.  |
| <b>Level 3 Cache</b>                 | Displays the total L3 cache.  |
| <b>Number of Cores</b>               | Displays the number of cores per processor.   |

## SATA Settings screen details

You can use the **SATA Settings** screen to view the SATA settings of SATA devices and enable RAID on your system.

To view the **SATA Settings** screen, click **System Setup Main Menu** → **System BIOS** → **SATA Settings**.

The **SATA Settings** screen details are explained as follows:

| Option                      | Description   |
|-----------------------------|---|
| <b>Embedded SATA</b>        | Enables the embedded SATA option to be set to <b>Off</b> , <b>ATAAHCI</b> , or <b>RAID</b> modes. This option is set to <b>AHCI</b> by default. |
| <b>Security Freeze Lock</b> | Sends Security Freeze Lock command to the Embedded SATA drives during POST. This option is applicable only for ATA and AHCI modes.              |
| <b>Write Cache</b>          | Enables or disables the command for Embedded SATA drives during POST.   |

## Option

## Description

### Port A

Sets the drive type of the selected device. For **Embedded SATA settings** in **ATA** mode, set this field to **Auto** to enable BIOS support. Set it to **OFF** to turn off BIOS support.

For **AHCI** or **RAID** mode, BIOS support is always enabled.

### Option

### Description

#### Model

Displays the drive model of the selected device.

#### Drive Type

Displays the type of drive attached to the SATA port.

#### Capacity

Displays the total capacity of the hard drive. This field is undefined for removable media devices such as optical drives.

### Port B

Sets the drive type of the selected device. For **Embedded SATA settings** in **ATA** mode, set this field to **Auto** to enable BIOS support. Set it to **OFF** to turn off BIOS support.

For **AHCI** or **RAID** mode, BIOS support is always enabled.

### Option

### Description

#### Model

Displays the drive model of the selected device.

#### Drive Type

Displays the type of drive attached to the SATA port.

#### Capacity

Displays the total capacity of the hard drive. This field is undefined for removable media devices such as optical drives.

### Port C

Sets the drive type of the selected device. For **Embedded SATA settings** in **ATA** mode, set this field to **Auto** to enable BIOS support. Set it to **OFF** to turn off BIOS support.

For **AHCI** or **RAID** mode, BIOS support is always enabled.

### Option

### Description

#### Model

Displays the drive model of the selected device.

#### Drive Type

Displays the type of drive attached to the SATA port.

#### Capacity

Displays the total capacity of the hard drive. This field is undefined for removable media devices such as optical drives.

### Port D

Sets the drive type of the selected device. For **Embedded SATA settings** in **ATA** mode, set this field to **Auto** to enable BIOS support. Set it to **OFF** to turn off BIOS support.

For **AHCI** or **RAID** mode, BIOS support is always enabled.

### Option

### Description

#### Model

Displays the drive model of the selected device.

#### Drive Type

Displays the type of drive attached to the SATA port.

|                   |   |               |                    |                 |  |                   |   |                 |  |
|-------------------|---|---------------|--------------------|-----------------|--|-------------------|---|-----------------|--|
| <b>Option</b>     | <b>Description</b>  |               |                    |                 |  |                   |   |                 |  |
|                   | <table border="0"> <tr> <td style="vertical-align: top;"><b>Option</b></td> <td style="vertical-align: top;"><b>Description</b></td> </tr> <tr> <td style="vertical-align: top;"><b>Capacity</b></td> <td style="vertical-align: top;">Displays the total capacity of the hard drive. This field is undefined for removable media devices such as optical drives.</td> </tr> </table>   | <b>Option</b> | <b>Description</b> | <b>Capacity</b> | Displays the total capacity of the hard drive. This field is undefined for removable media devices such as optical drives. |                   |   |                 |  |
| <b>Option</b>     | <b>Description</b>  |               |                    |                 |  |                   |   |                 |  |
| <b>Capacity</b>   | Displays the total capacity of the hard drive. This field is undefined for removable media devices such as optical drives.  |               |                    |                 |  |                   |   |                 |  |
| <b>Port E</b>     | <p>Sets the drive type of the selected device. For <b>Embedded SATA settings</b> in <b>ATA</b> mode, set this field to <b>Auto</b> to enable BIOS support. Set it to <b>OFF</b> to turn off BIOS support.</p> <p>For <b>AHCI</b> or <b>RAID</b> mode, BIOS support is always enabled.</p> <table border="0"> <tr> <td style="vertical-align: top;"><b>Option</b></td> <td style="vertical-align: top;"><b>Description</b></td> </tr> <tr> <td style="vertical-align: top;"><b>Model</b></td> <td style="vertical-align: top;">Displays the drive model of the selected device.</td> </tr> <tr> <td style="vertical-align: top;"><b>Drive Type</b></td> <td style="vertical-align: top;">Displays the type of drive attached to the SATA port.</td> </tr> <tr> <td style="vertical-align: top;"><b>Capacity</b></td> <td style="vertical-align: top;">Displays the total capacity of the hard drive. This field is undefined for removable media devices such as optical drives.</td> </tr> </table> | <b>Option</b> | <b>Description</b> | <b>Model</b>    | Displays the drive model of the selected device.   | <b>Drive Type</b> | Displays the type of drive attached to the SATA port. | <b>Capacity</b> | Displays the total capacity of the hard drive. This field is undefined for removable media devices such as optical drives. |
| <b>Option</b>     | <b>Description</b>  |               |                    |                 |  |                   |   |                 |  |
| <b>Model</b>      | Displays the drive model of the selected device.  |               |                    |                 |  |                   |   |                 |  |
| <b>Drive Type</b> | Displays the type of drive attached to the SATA port.   |               |                    |                 |  |                   |   |                 |  |
| <b>Capacity</b>   | Displays the total capacity of the hard drive. This field is undefined for removable media devices such as optical drives.  |               |                    |                 |  |                   |   |                 |  |
| <b>Port F</b>     | <p>Sets the drive type of the selected device. For <b>Embedded SATA settings</b> in <b>ATA</b> mode, set this field to <b>Auto</b> to enable BIOS support. Set it to <b>OFF</b> to turn off BIOS support.</p> <p>For <b>AHCI</b> or <b>RAID</b> mode, BIOS support is always enabled.</p> <table border="0"> <tr> <td style="vertical-align: top;"><b>Option</b></td> <td style="vertical-align: top;"><b>Description</b></td> </tr> <tr> <td style="vertical-align: top;"><b>Model</b></td> <td style="vertical-align: top;">Displays the drive model of the selected device.</td> </tr> <tr> <td style="vertical-align: top;"><b>Drive Type</b></td> <td style="vertical-align: top;">Displays the type of drive attached to the SATA port.</td> </tr> <tr> <td style="vertical-align: top;"><b>Capacity</b></td> <td style="vertical-align: top;">Displays the total capacity of the hard drive. This field is undefined for removable media devices such as optical drives.</td> </tr> </table> | <b>Option</b> | <b>Description</b> | <b>Model</b>    | Displays the drive model of the selected device.   | <b>Drive Type</b> | Displays the type of drive attached to the SATA port. | <b>Capacity</b> | Displays the total capacity of the hard drive. This field is undefined for removable media devices such as optical drives. |
| <b>Option</b>     | <b>Description</b>  |               |                    |                 |  |                   |   |                 |  |
| <b>Model</b>      | Displays the drive model of the selected device.  |               |                    |                 |  |                   |   |                 |  |
| <b>Drive Type</b> | Displays the type of drive attached to the SATA port.   |               |                    |                 |  |                   |   |                 |  |
| <b>Capacity</b>   | Displays the total capacity of the hard drive. This field is undefined for removable media devices such as optical drives.  |               |                    |                 |  |                   |   |                 |  |
| <b>Port G</b>     | <p>Sets the drive type of the selected device. For <b>Embedded SATA settings</b> in <b>ATA</b> mode, set this field to <b>Auto</b> to enable BIOS support. Set it to <b>OFF</b> to turn off BIOS support.</p> <p>For <b>AHCI</b> or <b>RAID</b> mode, BIOS support is always enabled.</p> <table border="0"> <tr> <td style="vertical-align: top;"><b>Option</b></td> <td style="vertical-align: top;"><b>Description</b></td> </tr> <tr> <td style="vertical-align: top;"><b>Model</b></td> <td style="vertical-align: top;">Displays the drive model of the selected device.</td> </tr> <tr> <td style="vertical-align: top;"><b>Drive Type</b></td> <td style="vertical-align: top;">Displays the type of drive attached to the SATA port.</td> </tr> <tr> <td style="vertical-align: top;"><b>Capacity</b></td> <td style="vertical-align: top;">Displays the total capacity of the hard drive. This field is undefined for removable media devices such as optical drives.</td> </tr> </table> | <b>Option</b> | <b>Description</b> | <b>Model</b>    | Displays the drive model of the selected device.   | <b>Drive Type</b> | Displays the type of drive attached to the SATA port. | <b>Capacity</b> | Displays the total capacity of the hard drive. This field is undefined for removable media devices such as optical drives. |
| <b>Option</b>     | <b>Description</b>  |               |                    |                 |  |                   |   |                 |  |
| <b>Model</b>      | Displays the drive model of the selected device.  |               |                    |                 |  |                   |   |                 |  |
| <b>Drive Type</b> | Displays the type of drive attached to the SATA port.   |               |                    |                 |  |                   |   |                 |  |
| <b>Capacity</b>   | Displays the total capacity of the hard drive. This field is undefined for removable media devices such as optical drives.  |               |                    |                 |  |                   |   |                 |  |
| <b>Port H</b>     | <p>Sets the drive type of the selected device. For <b>Embedded SATA settings</b> in <b>ATA</b> mode, set this field to <b>Auto</b> to enable BIOS support. Set it to <b>OFF</b> to turn off BIOS support.</p>   |               |                    |                 |  |                   |   |                 |  |

|                   |  |               |                    |              |  |                   |   |                 |  |
|-------------------|--|---------------|--------------------|--------------|--|-------------------|---|-----------------|--|
| <b>Option</b>     | <p><b>Description</b></p> <p>For <b>AHCI</b> or <b>RAID</b> mode, BIOS support is always enabled.</p> <table border="0"> <tr> <td style="vertical-align: top;"><b>Option</b></td> <td><b>Description</b></td> </tr> <tr> <td><b>Model</b></td> <td>Displays the drive model of the selected device.</td> </tr> <tr> <td><b>Drive Type</b></td> <td>Displays the type of drive attached to the SATA port.</td> </tr> <tr> <td><b>Capacity</b></td> <td>Displays the total capacity of the hard drive. This field is undefined for removable media devices such as optical drives.</td> </tr> </table>   | <b>Option</b> | <b>Description</b> | <b>Model</b> | Displays the drive model of the selected device. | <b>Drive Type</b> | Displays the type of drive attached to the SATA port. | <b>Capacity</b> | Displays the total capacity of the hard drive. This field is undefined for removable media devices such as optical drives. |
| <b>Option</b>     | <b>Description</b>   |               |                    |              |  |                   |   |                 |  |
| <b>Model</b>      | Displays the drive model of the selected device.   |               |                    |              |  |                   |   |                 |  |
| <b>Drive Type</b> | Displays the type of drive attached to the SATA port.  |               |                    |              |  |                   |   |                 |  |
| <b>Capacity</b>   | Displays the total capacity of the hard drive. This field is undefined for removable media devices such as optical drives.   |               |                    |              |  |                   |   |                 |  |
| <b>Port I</b>     | <p>Sets the drive type of the selected device. For <b>Embedded SATA settings</b> in <b>ATA</b> mode, set this field to <b>Auto</b> to enable BIOS support. Set it to <b>OFF</b> to turn off BIOS support.</p> <p>For <b>AHCI</b> or <b>RAID</b> mode, BIOS support is always enabled.</p> <table border="0"> <tr> <td style="vertical-align: top;"><b>Option</b></td> <td><b>Description</b></td> </tr> <tr> <td><b>Model</b></td> <td>Displays the drive model of the selected device.</td> </tr> <tr> <td><b>Drive Type</b></td> <td>Displays the type of drive attached to the SATA port.</td> </tr> <tr> <td><b>Capacity</b></td> <td>Displays the total capacity of the hard drive. This field is undefined for removable media devices such as optical drives.</td> </tr> </table> | <b>Option</b> | <b>Description</b> | <b>Model</b> | Displays the drive model of the selected device. | <b>Drive Type</b> | Displays the type of drive attached to the SATA port. | <b>Capacity</b> | Displays the total capacity of the hard drive. This field is undefined for removable media devices such as optical drives. |
| <b>Option</b>     | <b>Description</b>   |               |                    |              |  |                   |   |                 |  |
| <b>Model</b>      | Displays the drive model of the selected device.   |               |                    |              |  |                   |   |                 |  |
| <b>Drive Type</b> | Displays the type of drive attached to the SATA port.  |               |                    |              |  |                   |   |                 |  |
| <b>Capacity</b>   | Displays the total capacity of the hard drive. This field is undefined for removable media devices such as optical drives.   |               |                    |              |  |                   |   |                 |  |
| <b>Port J</b>     | <p>Sets the drive type of the selected device. For <b>Embedded SATA settings</b> in <b>ATA</b> mode, set this field to <b>Auto</b> to enable BIOS support. Set it to <b>OFF</b> to turn off BIOS support.</p> <p>For <b>AHCI</b> or <b>RAID</b> mode, BIOS support is always enabled.</p> <table border="0"> <tr> <td style="vertical-align: top;"><b>Option</b></td> <td><b>Description</b></td> </tr> <tr> <td><b>Model</b></td> <td>Displays the drive model of the selected device.</td> </tr> <tr> <td><b>Drive Type</b></td> <td>Displays the type of drive attached to the SATA port.</td> </tr> <tr> <td><b>Capacity</b></td> <td>Displays the total capacity of the hard drive. This field is undefined for removable media devices such as optical drives.</td> </tr> </table> | <b>Option</b> | <b>Description</b> | <b>Model</b> | Displays the drive model of the selected device. | <b>Drive Type</b> | Displays the type of drive attached to the SATA port. | <b>Capacity</b> | Displays the total capacity of the hard drive. This field is undefined for removable media devices such as optical drives. |
| <b>Option</b>     | <b>Description</b>   |               |                    |              |  |                   |   |                 |  |
| <b>Model</b>      | Displays the drive model of the selected device.   |               |                    |              |  |                   |   |                 |  |
| <b>Drive Type</b> | Displays the type of drive attached to the SATA port.  |               |                    |              |  |                   |   |                 |  |
| <b>Capacity</b>   | Displays the total capacity of the hard drive. This field is undefined for removable media devices such as optical drives.   |               |                    |              |  |                   |   |                 |  |

## Boot Settings screen details

You can use the **Boot Settings** screen to set the boot mode to either **BIOS** or **UEFI**. It also enables you to specify the boot order.

To view the **Boot Settings** screen, click **System Setup Main Menu** → **System BIOS** → **Boot Settings**.

The **Boot Settings** screen details are explained as follows:

|                  |   |
|------------------|---|
| <b>Option</b>    | <b>Description</b>  |
| <b>Boot Mode</b> | Enables you to set the boot mode of the system. Setting this field to <b>UEFI</b> disables the <b>BIOS Boot Settings</b> menu. Setting this field to <b>BIOS</b> disables the <b>UEFI Boot Settings</b> menu. |

| Option                      | Description  |
|-----------------------------|--|
|                             |  <b>CAUTION: Switching the boot mode may prevent the system from booting if the operating system is not installed in the same boot mode.</b><br>If the operating system supports UEFI, you can set this option to <b>UEFI</b> . Setting this field to <b>BIOS</b> allows compatibility with non-UEFI operating systems. This option is set to <b>BIOS</b> by default.   |
| <b>Boot Sequence Retry</b>  | Enables or disables the Boot Sequence Retry feature. If this field is enabled and the system fails to boot, the system reattempts the boot sequence after 30 seconds. This option is set to <b>Enabled</b> by default.   |
| <b>Hard-Disk Failover</b>   | Specifies the hard drive that is booted in the event of a hard drive failure. The devices are selected in the <b>Hard-Disk Drive Sequence</b> on the <b>Boot Option Setting</b> menu. When this option is set to <b>Disabled</b> , only the first hard drive in the list is attempted to boot. When this option is set to <b>Enabled</b> , all hard drives are attempted to boot in the order selected in the <b>Hard-Disk Drive Sequence</b> . This option is not enabled for UEFI Boot Mode. |
| <b>Boot Option Settings</b> | Configures the boot sequence and the boot devices.   |

## Network Settings screen details

You can use the **Network Settings** screen to modify PXE device settings. The network settings option is available only in the UEFI boot mode. BIOS does not control network settings in the BIOS boot mode. For BIOS boot mode, the option ROM of the network controllers handles the network settings. To view the **Network Settings** screen, click **System Setup Main Menu** → **System BIOS** → **Network Settings**.

The **Network Settings** screen details are explained as follows:

| Option                                    | Description   |
|---|---|
| <b>PXE Device n (n = 1 to 4)</b>          | Enables or disables the device. When enabled, a UEFI boot option is created for the device. |
| <b>PXE Device n Settings (n = 1 to 4)</b> | Enables you to control the configuration of the PXE device.                                 |



## Integrated Devices screen details

You can use the **Integrated Devices** screen to view and configure the settings of all integrated devices including the video controller, integrated RAID controller, and the USB ports.

To view the **Integrated Devices** screen, click **System Setup Main Menu** → **System BIOS** → **Integrated Devices**.

The **Integrated Devices** screen details are explained as follows:





| Option                           | Description   |
|----------------------------------|---|
| <b>USB 3.0 Setting</b>           | Enables or disables the USB 3.0 support. Enable this option only if your operating system supports USB 3.0. If you disable this option, devices operate at USB 2.0 speed. USB 3.0 is disabled by default. |
| <b>User Accessible USB Ports</b> | Enables or disables the USB ports. Selecting <b>Only Back Ports On</b> disables the front USB ports, selecting <b>All Ports Off</b> disables all USB ports. The USB keyboard and                          |

| Option  | Description  |
|---|--|
|   | <p>mouse operates during boot process in certain operating systems. After the boot process is complete, the USB keyboard and mouse do not work if the ports are disabled.</p>  |
|   | <p> <b>NOTE:</b> Selecting <b>Only Back Ports On</b> and <b>All Ports Off</b> disables the USB management port and also restricts access to iDRAC features.</p>   |
| <b>Internal USB Port</b>                          | Enables or disables the internal USB port. This option is set to <b>Enabled</b> by default.  |
| <b>Integrated RAID Controller</b>                 | Enables or disables the integrated RAID controller. This option is set to <b>Enabled</b> by default.   |
| <b>Integrated Network Card 1</b>                  | Enables or disables the integrated network card.   |
| <b>Embedded NIC1 and NIC2</b>                     | <p> <b>NOTE:</b> The Embedded NIC1 and NIC2 options are only available on systems that do not have <b>Integrated Network Card 1</b>.</p>  |
|   | <p>Enables or disables the Embedded NIC1 and NIC2 options. If set to <b>Disabled</b>, the NIC may still be available for shared network access by the embedded management controller. The embedded NIC1 and NIC2 options are only available on systems that do not have Network Daughter Cards (NDCs). This option is mutually exclusive with the Integrated Network Card 1 option. Configure this function by using the NIC management utilities of the system.</p> |
| <b>I/OAT DMA Engine</b>                           | Enables or disables the I/OAT option. Enable only if the hardware and software support the feature.  |
| <b>Embedded Video Controller</b>                  | Allows you to enable or disable the <b>Embedded Video Controller</b> option. This option is set to <b>Enabled</b> by default.  |
| <b>Current State of Embedded Video Controller</b> | Displays the current state of the embedded video controller. The <b>Current State of Embedded Video Controller</b> option is a read-only field. If the <b>Embedded Video Controller</b> is the only display capability in the system (that is, no add-in graphics card is installed), then the <b>Embedded Video Controller</b> is automatically used as the primary display even if the <b>Embedded Video Controller</b> setting is set to <b>Disabled</b> .        |
| <b>SR-IOV Global Enable</b>                       | Enables or disables the BIOS configuration of Single Root I/O Virtualization (SR-IOV) devices. This option is set to <b>Disabled</b> by default.   |
| <b>OS Watchdog Timer</b>                          | If your system stops responding, this watchdog timer aids in the recovery of your operating system. When this option is set to <b>Enabled</b> , the operating system initializes the timer. When this option is set to <b>Disabled</b> (the default), the timer does not have any effect on the system.  |
| <b>Memory Mapped I/O above 4 GB</b>               | Enables or disables the support for PCIe devices that require large amounts of memory. This option is set to <b>Enabled</b> by default.  |
| <b>Slot Disablement</b>                           | Enables or disables the available PCIe slots on your system. The slot disablement feature controls the configuration of PCIe cards installed in the specified slot. Slot disablement must be used only when the installed peripheral card prevents booting into the operating system or causes delays in system startup. If the slot is disabled, both the Option ROM and UEFI drivers are disabled.   |

## Serial Communication screen details

You can use the **Serial Communication** screen to view the properties of the serial communication port. To view the **Serial Communication** screen, click **System Setup Main Menu** → **System BIOS** → **Serial Communication**.

The **Serial Communication** screen details are explained as follows:



| Option                           | Description   |
|----------------------------------|---|
| <b>Serial Communication</b>      | Selects serial communication devices (Serial Device 1 and Serial Device 2) in BIOS. BIOS console redirection can also be enabled and the port address can be specified. This option is set to <b>Auto</b> by default.   |
| <b>Serial Port Address</b>       | Enables you to set the port address for serial devices. This option is set to <b>Serial Device 1=COM2, Serial Device 2=COM1</b> by default.<br> <b>NOTE:</b> You can use only Serial Device 2 for the Serial Over LAN (SOL) feature. To use console redirection by SOL, configure the same port address for console redirection and the serial device.<br> <b>NOTE:</b> Every time the system boots, the BIOS syncs the serial MUX setting saved in iDRAC. The serial MUX setting can independently be changed in iDRAC. Loading the BIOS default settings from within the BIOS setup utility may not always revert the serial MUX setting to the default setting of Serial Device 1. |
| <b>External Serial Connector</b> | Enables you to associate the External Serial Connector to Serial Device 1, Serial Device 2, or the Remote Access Device by using this field.<br> <b>NOTE:</b> Only Serial Device 2 can be used for Serial Over LAN (SOL). To use console redirection by SOL, configure the same port address for console redirection and the serial device.<br> <b>NOTE:</b> Every time the system boots, the BIOS syncs the serial MUX setting saved in iDRAC. The serial MUX setting can independently be changed in iDRAC. Loading the BIOS default settings from within the BIOS setup utility may not always revert this setting to the default setting of Serial Device 1.                  |
| <b>Failsafe Baud Rate</b>        | Displays the failsafe baud rate for console redirection. The BIOS attempts to determine the baud rate automatically. This failsafe baud rate is used only if the attempt fails, and the value must not be changed. This option is set to 115200 by default.   |
| <b>Remote Terminal Type</b>      | Sets the remote console terminal type. This option is set to VT 100/VT 220 by default.  |
| <b>Redirection After Boot</b>    | Enables or disables the BIOS console redirection when the operating system is loaded. This option is set to <b>Enabled</b> by default.  |

## System Profile Settings screen details



You can use the **System Profile Settings** screen to enable specific system performance settings such as power management.

To view the **System Profile Settings** screen, click **System Setup Main Menu** → **System BIOS** → **System Profile Settings**.

The **System Profile Settings** screen details are explained as follows:



| Option   | Description  |
|--|--|
| <b>System Profile</b>                                      | <p>Sets the system profile. If you set the <b>System Profile</b> option to a mode other than <b>Custom</b>, the BIOS automatically sets the rest of the options. You can only change the rest of the options if the mode is set to <b>Custom</b>. This option is set to <b>Performance Per Watt Optimized (DAPC)</b> by default. DAPC is Dell Active Power Controller.</p> <p> <b>NOTE:</b> All the parameters on the system profile setting screen available only when the <b>System Profile</b> option is set to <b>Custom</b>.</p> |
| <b>CPU Power Management</b>                                | Sets the CPU power management. This option is set to <b>System DBPM (DAPC)</b> by default. DBPM is Demand-Based Power Management.  |
| <b>Memory Frequency</b>                                    | Sets the speed of the system memory. You can select <b>Maximum Performance</b> , <b>Maximum Reliability</b> , or a specific speed.   |
| <b>Turbo Boost</b>   | Enables or disables the processor to operate in turbo boost mode. This option is set to <b>Enabled</b> by default.   |
| <b>Energy Efficient Turbo</b>                              | <p>Enables or disables the <b>Energy Efficient Turbo</b>.</p> <p>Energy Efficient Turbo (EET) is a mode of operation where a processor's core frequency is adjusted within the turbo range based on workload.</p>  |
| <b>C1E</b>   | Enables or disables the processor to switch to a minimum performance state when it is idle. This option is set to <b>Enabled</b> by default.   |
| <b>C States</b>  | Enables or disables the processor to operate in all available power states. This option is set to <b>Enabled</b> by default.   |
| <b>Collaborative CPU Performance Control</b>               | Enables or disables the CPU power management. When set to <b>Enabled</b> , the CPU power management is controlled by the OS DBPM and the System DBPM (DAPC). This option is set to <b>Disabled</b> by default.   |
| <b>Memory Patrol Scrub</b>                                 | Sets the memory patrol scrub frequency. This option is set to <b>Standard</b> by default.  |
| <b>Memory Refresh Rate</b>                                 | Sets the memory refresh rate to either 1x or 2x. This option is set to <b>1x</b> by default.   |
| <b>Uncore Frequency</b>                                    | <p>Enables you to select the <b>Processor Uncore Frequency</b>.</p> <p>Dynamic mode enables the processor to optimize power resources across the cores and uncore during runtime. The optimization of the uncore frequency to either save power or optimize performance is influenced by the setting of the <b>Energy Efficiency Policy</b>.</p>   |
| <b>Energy Efficient Policy</b>                             | <p>Enables you to select the <b>Energy Efficient Policy</b>.</p> <p>The CPU uses the setting to manipulate the internal behavior of the processor and determines whether to target higher performance or better power savings.</p>   |
| <b>Number of Turbo Boost Enabled Cores for Processor 1</b> | <p> <b>NOTE:</b> If there are two processors installed in the system, you see an entry for <b>Number of Turbo Boost Enabled Cores for Processor 2</b>.</p> <p>Controls the number of turbo boost enabled cores for processor 1. The maximum number of cores is enabled by default.</p>  |



| Option               | Description   |
|----------------------|---|
| <b>Monitor/Mwait</b> | <p>Enables the Monitor/Mwait instructions in the processor. This option is set to <b>Enabled</b> for all system profiles, except <b>Custom</b> by default.</p> <p> <b>NOTE:</b> This option can be disabled only if the <b>C States</b> option in the <b>Custom</b> mode is set to <b>disabled</b>.</p> <p> <b>NOTE:</b> When <b>C States</b> is set to <b>Enabled</b> in the <b>Custom</b> mode, changing the Monitor/Mwait setting does not impact the system power or performance.</p> |

## System Security Settings details

The **System Security Settings** screen details are explained as follows:

| Option                         | Description  |
|--------------------------------|--|
| <b>Intel AES-NI</b>            | Improves the speed of applications by performing encryption and decryption by using the Advanced Encryption Standard Instruction Set (AES-NI) and is set to <b>Enabled</b> by default.   |
| <b>System Password</b>         | Sets the system password. This option is set to <b>Enabled</b> by default and is read-only if the password jumper is not installed in the system.  |
| <b>Setup Password</b>          | Sets the setup password. This option is read-only if the password jumper is not installed in the system.   |
| <b>Password Status</b>         | Locks the system password. This option is set to <b>Unlocked</b> by default.   |
| <b>TPM Security</b>            | <p> <b>NOTE:</b> The TPM menu is available only when the TPM module is installed.</p> <p>Enables you to control the reporting mode of the TPM. The <b>TPM Security</b> option is set to <b>Off</b> by default. You can only modify the TPM Status, TPM Activation, and Intel TXT fields if the <b>TPM Status</b> field is set to either <b>On with Pre-boot Measurements</b> or <b>On without Pre-boot Measurements</b>.</p> |
| <b>TPM Information</b>         | Changes the operational state of the TPM. This option is set to <b>No Change</b> by default.   |
| <b>TPM Status</b>              | Displays the TPM status.   |
| <b>TPM Command</b>             | <p> <b>CAUTION:</b> Clearing the TPM results in the loss of all keys in the TPM. The loss of TPM keys may affect booting to the operating system.</p> <p>Clears all the contents of the TPM. The <b>TPM Clear</b> option is set to <b>No</b> by default.</p>  |
| <b>Intel TXT</b>               | Enables or disables the Intel Trusted Execution Technology (TXT) option. To enable the <b>Intel TXT</b> option, virtualization technology and TPM Security must be enabled with Pre-boot measurements. This option is set to <b>Off</b> by default.  |
| <b>Power Button</b>            | Enables or disables the power button on the front of the system. This option is set to <b>Enabled</b> by default.  |
| <b>NMI Button</b>              | Enables or disables the NMI button on the front of the system. This option is set to <b>Disabled</b> by default.   |
| <b>AC Power Recovery</b>       | Sets how the system behaves after AC power is restored to the system. This option is set to <b>Last</b> by default.  |
| <b>AC Power Recovery Delay</b> | Sets the time delay for system power up after AC power is restored to the system. This option is set to <b>Immediate</b> by default.   |

| Option                                  | Description   |
|---|---|
| <b>User Defined Delay (60s to 240s)</b> | Sets the <b>User Defined Delay</b> option when the <b>User Defined</b> option for <b>AC Power Recovery Delay</b> is selected.   |
| <b>UEFI Variable Access</b>             | Provides varying degrees of securing UEFI variables. When set to <b>Standard</b> (the default), UEFI variables are accessible in the operating system per the UEFI specification. When set to <b>Controlled</b> , selected UEFI variables are protected in the environment and new UEFI boot entries are forced to be at the end of the current boot order. |
| <b>Secure Boot</b>                      | Enables Secure Boot, where the BIOS authenticates each pre-boot image by using the certificates in the Secure Boot Policy. Secure Boot is disabled by default.  |
| <b>Secure Boot Policy</b>               | When Secure Boot policy is set to <b>Standard</b> , the BIOS uses the system manufacturer's key and certificates to authenticate pre-boot images. When Secure Boot policy is set to <b>Custom</b> , the BIOS uses the user-defined key and certificates. Secure Boot policy is set to <b>Standard</b> by default.   |
| <b>Secure Boot Policy Summary</b>       | Displays the list of certificates and hashes that secure boot uses to authenticate images.  |

### Secure Boot Custom Policy Settings screen

Secure Boot Custom Policy Settings is displayed only when **Secure Boot Policy** is set to **Custom**. In the **System Setup Main Menu**, click **System BIOS** → **System Security** → **Secure Boot Custom Policy Settings**. The **Secure Boot Custom Policy Settings** screen details are explained as follows:

| Menu Item                            | Description   |
|--------------------------------------|---|
| <b>Platform Key</b>                  | Imports, exports, deletes, or restores the platform key (PK).                                     |
| <b>Key Exchange Key Database</b>     | Enables you to import, export, delete, or restore entries in the Key Exchange Key (KEK) Database. |
| <b>Authorized Signature Database</b> | Imports, exports, deletes, or restores entries in the Authorized Signature Database (db).         |
| <b>Forbidden Signature Database</b>  | Imports, exports, deletes, or restores entries in the Forbidden Signature Database (dbx).         |



### Miscellaneous Settings screen details

You can use the **Miscellaneous Settings** screen to perform specific functions such as updating the asset tag and changing the system date and time.

To view the **Miscellaneous Settings** screen, click **System Setup Main Menu** → **System BIOS** → **Miscellaneous Settings**.

The **Miscellaneous Settings** screen details are explained as follows:

| Option             | Description   |
|--------------------|---|
| <b>System Time</b> | Enables you to set the time on the system.  |
| <b>System Date</b> | Enables you to set the date on the system.  |
| <b>Asset Tag</b>   | Displays the asset tag and enables you to modify it for security and tracking purposes. |

| Option                              | Description  |
|-------------------------------------|--|
| <b>Keyboard NumLock</b>             | <p>Enables you to set whether the system boots with the NumLock enabled or disabled. This option is set to <b>On</b> by default.</p> <p> <b>NOTE:</b> This option does not apply to 84-key keyboards.</p>   |
| <b>F1/F2 Prompt on Error</b>        | <p>Enables or disables the F1/F2 prompt on error. This option is set to <b>Enabled</b> by default. The F1/F2 prompt also includes keyboard errors.</p>   |
| <b>Load Legacy Video Option ROM</b> | <p>Enables you to determine whether the system BIOS loads the legacy video (INT 10H) option ROM from the video controller. Selecting <b>Enabled</b> in the operating system does not support UEFI video output standards. This field is available only for UEFI boot mode. You cannot set the option to <b>Enabled</b> if <b>UEFI Secure Boot</b> mode is enabled.</p>   |
| <b>In-System Characterization</b>   | <p>This option enables or disables <b>In-System Characterization</b>. By default, <b>In-System Characterization</b> is set to <b>Disabled</b>. The two other options are <b>Enabled</b> and <b>Enabled - No Reboot</b>.</p> <p> <b>NOTE:</b> The default setting for <b>In-System Characterization</b> is subject to change in future BIOS releases.</p> <p>When enabled, In-System Characterization (ISC) executes during POST upon detecting relevant change(s) in system configuration to optimize system power and performance. ISC takes about 20 seconds to execute, and system reset is required for ISC results to be applied. The <b>Enabled - No Reboot</b> option executes ISC and continues without applying ISC results until the next time system reset occurs. The <b>Enabled</b> option executes ISC and forces an immediate system reset so that ISC results can be applied. It takes the system longer to be ready due to the forced system reset. When disabled, ISC does not execute.</p> |

## About Boot Manager

**Boot Manager** enables you to add, delete, and arrange boot options. You can also access System Setup and boot options without restarting the system.

### Entering Boot Manager

The **Boot Manager** screen allows you to select boot options and diagnostic utilities.

1. Turn on or restart your system.
2. Press <F11> when you see the message <F11> = Boot Manager.  
If your operating system begins to load before you press <F11>, allow the system to finish booting, and then restart your system and try again.

### Boot Manager main menu

| Menu item                   | Description   |
|-----------------------------|---|
| <b>Continue Normal Boot</b> | The system attempts to boot to devices starting with the first item in the boot order. If the boot attempt fails, the system continues with the next item in the boot order until the boot is successful or no more boot options are found. |

| Menu item                          | Description   |
|------------------------------------|---|
| <b>One Shot Boot Menu</b>          | Takes you to the boot menu, where you can select a one time boot device to boot from. |
| <b>Launch System Setup</b>         | Enables you to access System Setup.   |
| <b>Launch Lifecycle Controller</b> | Exits the Boot Manager and invokes the Dell Lifecycle Controller program.             |
| <b>System Utilities</b>            | Launches System Utilities menu such as System Diagnostics and UEFI shell.             |

## About Dell Lifecycle Controller

Dell Lifecycle Controller allows you to perform useful tasks such as configuring BIOS and hardware settings, deploying an operating system, updating drivers, changing RAID settings, and saving hardware profiles. For more information about Dell Lifecycle Controller, see the documentation at [dell.com/esmmanuals](http://dell.com/esmmanuals).

## Changing the boot order

You may have to change the boot order if you want to boot from a USB key or an optical drive. The instructions given below may vary if you have selected **BIOS** for **Boot Mode**.

1. In the **System Setup Main Menu**, click **System BIOS** → **Boot Settings**.
2. Click **Boot Option Settings** → **Boot Sequence**.
3. Use the arrow keys to select a boot device, and use the <+> and <-> keys to move the device down or up in the order.
4. Click **Exit**, click **Yes** to save the settings on exit.

## Choosing the system boot mode

System Setup enables you to specify the boot mode for installing your operating system:

- BIOS boot mode (the default) is the standard BIOS-level boot interface.
- UEFI boot mode is an enhanced 64-bit boot interface based on Unified Extensible Firmware Interface (UEFI) specifications that overlays the system BIOS.

To choose the system **Boot Mode**:

1. In **System Setup** click **Boot Settings** and select **Boot Mode**.
2. Select the **Boot Mode** you want the system to boot into.

 **NOTE:** After the system boots in the specified boot mode, proceed to install your operating system from that mode.

 **CAUTION:** Trying to boot the operating system from the other boot mode will cause the system to halt at startup.

 **NOTE:** Operating systems must be UEFI-compatible to be installed from the UEFI boot mode. DOS and 32-bit operating systems do not support UEFI and can only be installed from the BIOS boot mode.

 **NOTE:** For the latest information on supported operating systems, go to [dell.com/ossupport](https://dell.com/ossupport).

## Assigning a system and setup password

### Prerequisites

You can assign a new **System Password** and **Setup Password** or change an existing **System Password** and **Setup Password** only when the password jumper setting is **enabled** and **Password Status** is **Unlocked**.

If the password jumper setting is disabled, the existing **System Password** and **Setup Password** are deleted and you need not provide the system password to boot the system.

 **NOTE:** The password jumper enables or disables the System Password and Setup Password features. For more information about the password jumper settings, see [System board jumper settings](#).

### Steps

1. To enter System Setup, press <F2> immediately after a power-on or reboot.
2. From the **System Setup Main Menu**, select **System BIOS** and press <Enter>. The **System BIOS** screen is displayed.
3. On the **System BIOS** screen, select **System Security** and press <Enter>. The **System Security** screen is displayed.
4. On the **System Security** screen, verify that **Password Status** is **Unlocked**.
5. Select **System Password**, enter your system password, and press <Enter> or <Tab>. Use the following guidelines to assign the system password:
  - A password can have up to 32 characters.
  - The password can contain the numbers 0 through 9.
  - Only the following special characters are allowed: space, ("), (+), (.), (-), (.), (/), (:), (D), (\), (I), (').

A message prompts you to re-enter the system password.

6. Re-enter the system password, and click **OK**.
7. Select **Setup Password**, enter your setup password and press <Enter> or <Tab>. A message prompts you to re-enter the setup password.
8. Re-enter the setup password, and click **OK**.
9. Press <Esc> to return to the System BIOS screen. Press <Esc> again. A message prompts you to save the changes.

 **NOTE:** Password protection does not take effect until the system reboots.

## Using your system password to secure your system

### Prerequisites

 **NOTE:** If you have assigned a setup password, the system accepts your setup password as an alternate system password.

### Steps

1. Turn on or reboot your system.
2. Type your password and press <Enter>.

### Next steps

When **Password Status** is **Locked**, type the password and press <Enter> when prompted at reboot.

If an incorrect system password is entered, the system displays a message and prompts you to re-enter your password. You have three attempts to enter the correct password. After the third unsuccessful attempt, the system displays an error message that the system has halted and must be powered down.

Even after you shut down and restart the system, the error message is displayed until the correct password is entered.

 **NOTE:** You can use the **Password Status** option in conjunction with the **System Password** and **Setup Password** options to protect your system from unauthorized changes.

## Deleting or changing an existing system and/or setup password

### Prerequisites

Ensure that the Password jumper is set to enabled and the **Password Status** is set to **Unlocked** before attempting to delete or change the existing System and/or Setup password. You cannot delete or change an existing System or Setup password if the **Password Status** is **Locked**.

### Steps

1. To enter System Setup, press <F2> immediately after a power-on or restart.
2. In the **System Setup Main Menu**, select **System BIOS** and press <Enter>. The **System BIOS** screen is displayed.
3. In the **System BIOS Screen**, select **System Security** and press <Enter>. The **System Security** screen is displayed.
4. In the **System Security** screen, verify that **Password Status** is set to **Unlocked**.
5. Select **System Password**, alter or delete the existing system password and press <Enter> or <Tab>.
6. Select **Setup Password**, alter or delete the existing setup password and press <Enter> or <Tab>.

 **NOTE:** If you change the System and/or Setup password, a message prompts you to re-enter the new password. If you delete the System and/or Setup password, a message prompts you to confirm the deletion.

7. Press <Esc> to return to the System BIOS screen. Press <Esc> again, and a message prompts you to save the changes.

## Operating with a setup password enabled

If **Setup Password** is **Enabled**, enter the correct setup password before modifying most of the System Setup options.

If you do not enter the correct password in three attempts, the system displays the message

```
Invalid Password! Number of unsuccessful password attempts: <x> System Halted!  
Must power down.
```

Even after you shut down and restart the system, the error message is displayed until the correct password is entered. The following options are exceptions:

- If **System Password** is not **Enabled** and is not locked through the **Password Status** option, you can assign a system password.
- You cannot disable or change an existing system password.

 **NOTE:** You can use the Password Status option in conjunction with the **Setup Password** option to protect the system password from unauthorized changes.

## Embedded system management

The Dell Lifecycle Controller provides advanced embedded systems management throughout the server's lifecycle. The Lifecycle Controller can be started during the boot sequence and can function independently of the operating system.

 **NOTE:** Certain platform configurations may not support the full set of features provided by the Lifecycle Controller.

For more information about setting up the Lifecycle Controller, configuring hardware and firmware, and deploying the operating system, see the Lifecycle Controller documentation at [dell.com/support/home](http://dell.com/support/home).

## iDRAC Settings utility

The iDRAC Settings utility is an interface to set up and configure the iDRAC parameters using UEFI. You can enable or disable various iDRAC parameters using the iDRAC Settings Utility.

 **NOTE:** Accessing some of the features on the iDRAC Settings utility requires the iDRAC Enterprise License upgrade.

For more information on using iDRAC, see the iDRAC User's Guide at [dell.com/esmmanuals](http://dell.com/esmmanuals).

### Entering the iDRAC Settings utility

1. Turn on or restart the managed system.
2. Press <F2> during Power-on Self-test (POST).
3. In the System Setup Main Menu page, click **iDRAC Settings**.  
The iDRAC Settings screen is displayed.

### Changing the Thermal Settings

The iDRAC Settings utility enables you to select and customize the thermal control settings for your system.

1. Enter the iDRAC Settings utility.
2. Under **iDRAC Settings** → **Thermal** → **User Option**, select between the following options:
  - Default
  - Maximum Exhaust Temperature
  - Fan Speed Offset







 **NOTE:** When the **User Option** is set to the default **Auto** setting, the user option cannot be modified.

3. Set the **Maximum Air Exhaust Temperature** or the **Fan Speed Offset** fields.
4. Click **Back** → **Finish** → **Yes**.



# Installing and removing system components

## Safety instructions

-  **WARNING:** Whenever you need to lift the system, get others to assist you. To avoid injury, do not attempt to lift the system by yourself.
-  **WARNING:** Opening or removing the system cover while the system is powered on may expose you to a risk of electric shock.
-  **CAUTION:** Do not operate the system without the cover for a duration exceeding five minutes.
-  **CAUTION:** Many repairs may only be done by a certified service technician. You should only perform troubleshooting and simple repairs as authorized in your product documentation, or as directed by the online or telephone service and support team. Damage due to servicing that is not authorized by Dell is not covered by your warranty. Read and follow the safety instructions that came with the product.
-  **NOTE:** It is recommended that you always use a static mat and static strap while working on components inside the system.
-  **NOTE:** To ensure proper operation and cooling, all bays in the system must be populated at all times with either a module or with a blank.

## Before working inside your system

1. Ensure that you follow the [Safety instructions](#).
2. Turn off the system, including any attached peripherals.
3. Disconnect the system from the electrical outlet and disconnect the peripherals.
4. If applicable, remove the system from the rack. For more information, see the *Rack Installation* placemat at [Dell.com/poweredgemanuals](https://Dell.com/poweredgemanuals).
5. If installed, remove the front bezel.
6. Remove the system cover.

### Related Links

- [Removing the front bezel](#)
- [Removing the system cover](#)

## After working inside your system

1. Install the system cover.
2. If applicable, install the front bezel.
3. Reconnect the system to its electrical outlet.
4. Turn the system on, including any attached peripherals.

### Related Links

[Installing the optional front bezel](#)

[Installing the system cover](#)

## Recommended tools

You may need the following items to perform the procedures in this section:

- Key to the system keylock
- #1 and #2 Phillips screwdriver
- Wrist grounding strap connected to ground

## Front bezel (optional)

### Installing the optional front bezel

1. Locate and remove the bezel key.  
 **NOTE:** The bezel key is attached to the back of the bezel.
2. Hook the right end of the bezel onto the chassis.
3. Fit the free end of the bezel onto the system.
4. Lock the bezel.

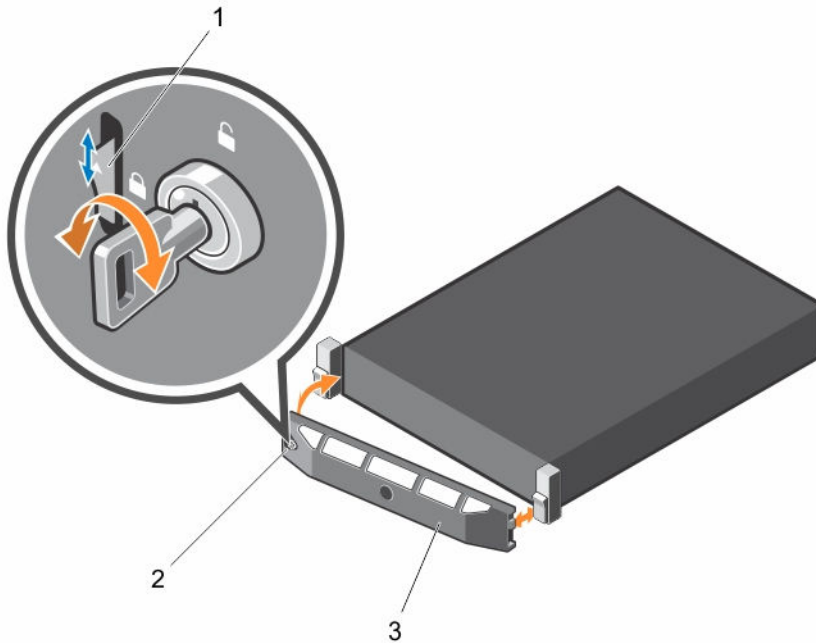

Figure 12. Removing and installing the optional front bezel

- |                  |            |
|------------------|------------|
| 1. release latch | 2. keylock |
| 3. front bezel   |            |

## Removing the front bezel

1. Unlock the keylock at the left end of the bezel.
2. Lift the release latch next to the keylock.
3. Rotate the left end of the bezel away from the front panel.
4. Unhook the right end of the bezel and pull the bezel away from the system.

## Removing and installing the system cover

**⚠ WARNING:** Whenever you need to lift the system, get others to assist you. To avoid injury, do not attempt to lift the system by yourself.

**⚠ WARNING:** Installing or removing the system cover when the system is on may expose you to a risk of electric shock.

**⚠ CAUTION:** Many repairs may only be done by a certified service technician. You should only perform troubleshooting and simple repairs as authorized in your product documentation, or as directed by the online or telephone service and support team. Damage due to servicing that is not authorized by Dell is not covered by your warranty. Read and follow the safety instructions that came with the product.

**⚠ CAUTION:** Do not operate the system without the cover for a duration exceeding five minutes.

## Removing the system cover

### Prerequisites

1. Ensure that you follow the [Safety instructions](#).
2. Turn off the system, including any attached peripherals.
3. Disconnect the system from the electrical outlet and peripherals.
4. If installed, remove the front bezel.

### Steps

1. Turn the latch release lock to the unlock position.
2. Lift the latch and rotate the latch toward the back of the system.  
The system cover slides back, disengaging the tabs on the system cover from the slots on the chassis.
3. Hold the cover on both sides, and lift the cover away from the system.

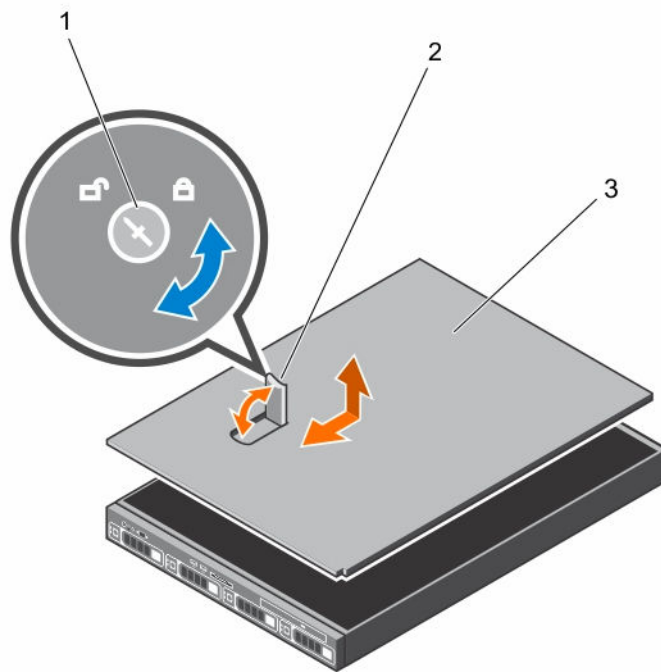

**Figure 13. Removing and installing the system cover**

1. latch release lock
2. latch
3. system cover

### Next steps

Install the system cover.

### Related Links

[Removing the front bezel](#)

## Installing the system cover

### Prerequisites

Ensure that you read the [Safety instructions](#).

### Steps

1. Align the slots of the system cover with the tabs on the chassis.
2. Press the cover release latch, and push the cover toward the front of the chassis until the latch locks into place.
3. Turn the cover latch release lock clockwise to the locked position.

### Next steps

1. Install the bezel (optional).
2. Follow the procedure listed in [After working inside your system](#).

### Related Links

[Installing the optional front bezel](#)

## Inside the system

 **CAUTION:** Many repairs may only be done by a certified service technician. You should only perform troubleshooting and simple repairs as authorized in your product documentation, or as directed by the online or telephone service and support team. Damage due to servicing that is not authorized by Dell is not covered by your warranty. Read and follow the safety instructions that came with the product.

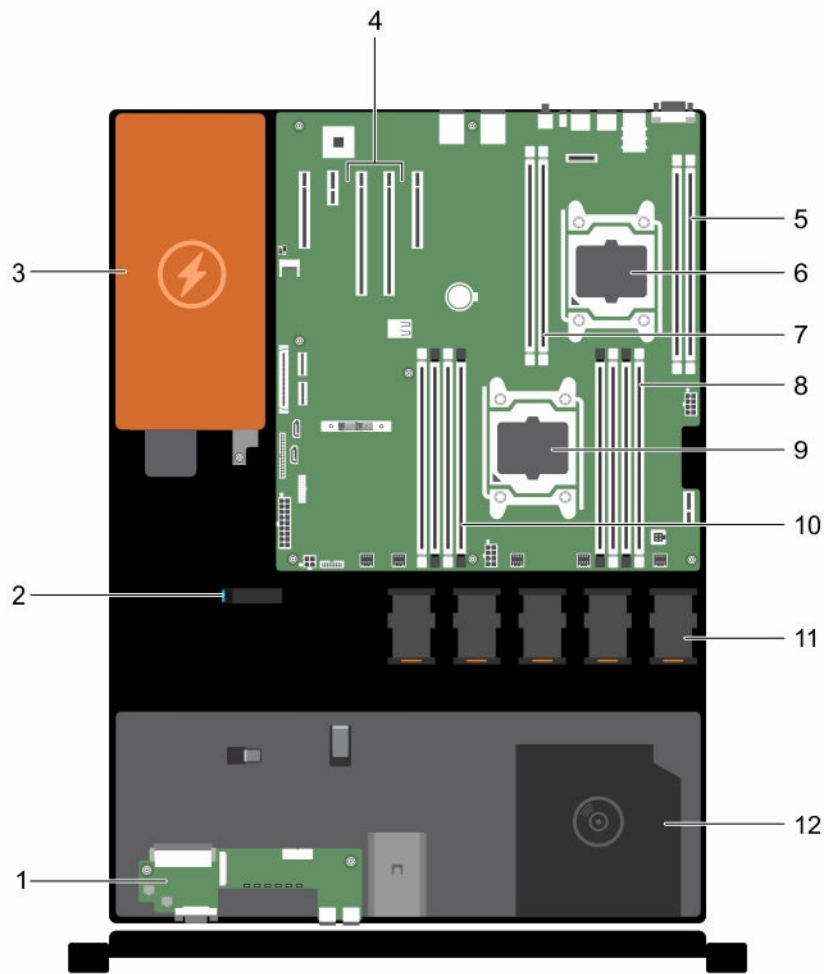

**Figure 14. Inside the system—with a non-redundant power supply**

- |     |                               |     |                                       |
|-----|-------------------------------|-----|---------------------------------------|
| 1.  | control panel                 | 2.  | cable routing latch                   |
| 3.  | power supply unit             | 4.  | expansion-card riser connector (2)    |
| 5.  | memory-module socket (B3, B4) | 6.  | processor 2                           |
| 7.  | memory-module socket (B1, B2) | 8.  | memory-module socket (A1, A5, A2, A6) |
| 9.  | processor 1                   | 10. | memory-module socket (A3, A7, A4, A8) |
| 11. | cooling fan (5)               | 12. | optical drive (optional)              |

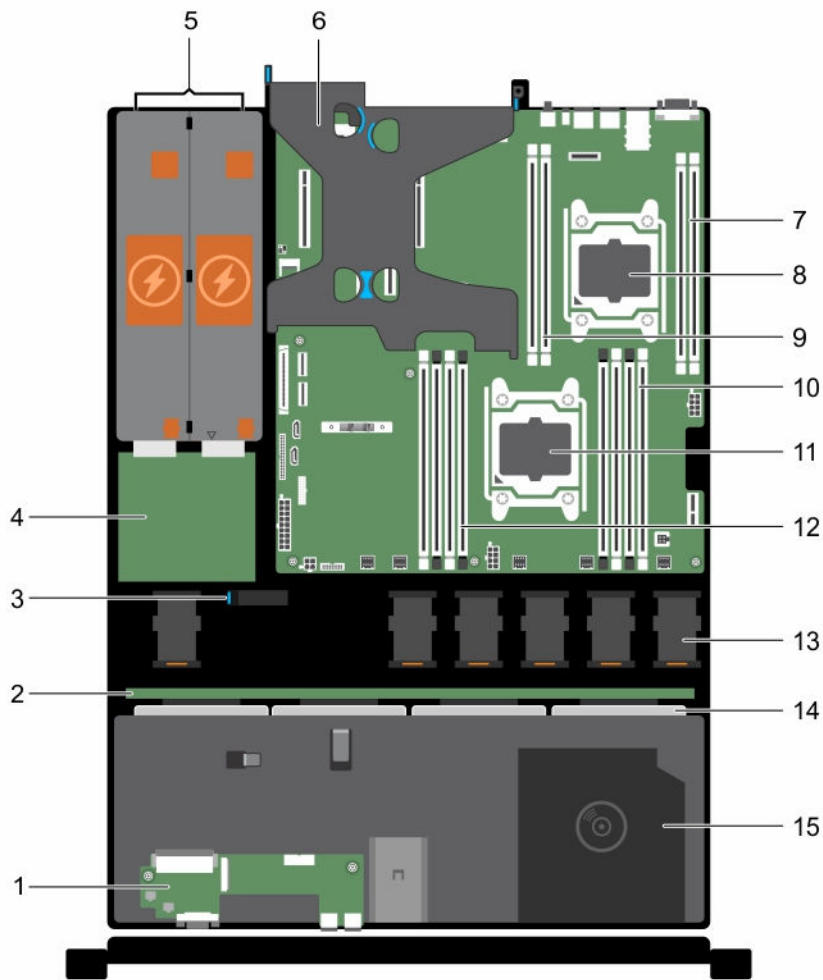

**Figure 15. Inside the System—with redundant power supplies**

- |                                  |   |
|----------------------------------|---|
| 1. control panel                 | 2. hard drive/SSD backplane               |
| 3. cable routing latch           | 4. power interposer board                 |
| 5. power supply units (2)        | 6. PCIe expansion card riser (optional)   |
| 7. memory-module socket (B3, B4) | 8. processor 2                            |
| 9. memory-module socket (B1, B2) | 10. memory-module socket (A1, A5, A2, A6) |
| 11. processor 1                  | 12. memory-module socket (A3, A7, A4, A8) |
| 13. cooling fan (6)              | 14. hard drives/SSDs                      |
| 15. optical drive                |   |

## Cooling shroud

## Removing the cooling shroud

### Prerequisites

**CAUTION:** Many repairs may only be done by a certified service technician. You should only perform troubleshooting and simple repairs as authorized in your product documentation, or as directed by the online or telephone service and support team. Damage due to servicing that is not authorized by Dell is not covered by your warranty. Read and follow the safety instructions that came with the product.

1. Ensure that you read the [Safety instructions](#).
2. Follow the procedure listed in [Before working inside your system](#).

**CAUTION:** Never operate your system with the cooling shroud removed. The system may get overheated quickly, resulting in shutdown of the system and loss of data.

### Steps

Hold the touch points and lift the shroud away from the system.

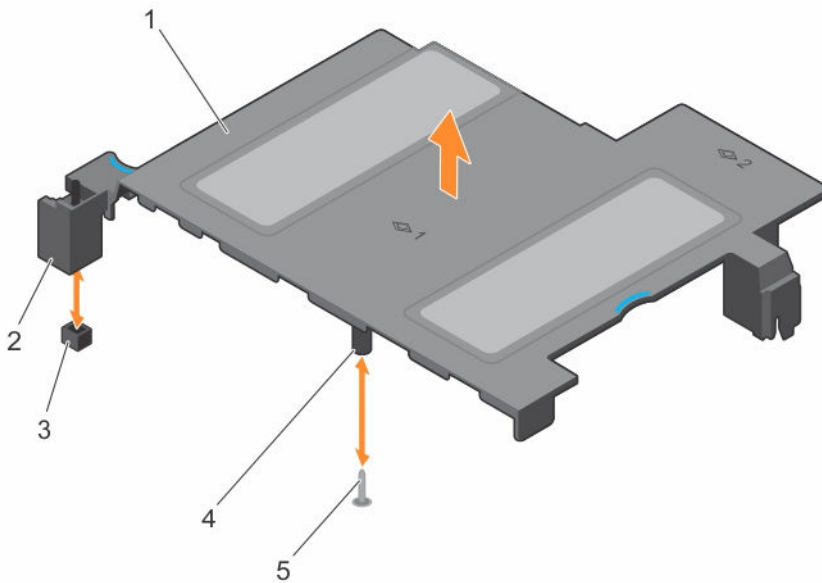

**Figure 16. Removing and installing the cooling shroud**

- |   |                                      |
|---|--------------------------------------|
| 1. cooling shroud                                 | 2. intrusion switch                  |
| 3. intrusion switch connector on the system board | 4. guide on the cooling shroud board |
| 5. guide pin                                      |                                      |

### Related Links

- [Removing the front bezel](#)
- [Removing the system cover](#)
- [Installing the system cover](#)
- [Installing the optional front bezel](#)



## Installing the cooling shroud

### Prerequisites

 **CAUTION:** Many repairs may only be done by a certified service technician. You should only perform troubleshooting and simple repairs as authorized in your product documentation, or as directed by the online or telephone service and support team. Damage due to servicing that is not authorized by Dell is not covered by your warranty. Read and follow the safety instructions that came with the product.

1. Ensure that you read the [Safety instructions](#).
2. Follow the procedure listed in [Before working inside your system](#).

### Steps

1. Align the following:
  - a. guide on the cooling shroud with the guide pin on the system board.
  - b. intrusion switch with the intrusion switch connector on the system board.
2. Lower the cooling shroud into the chassis until it is firmly seated.

When firmly seated, the memory socket numbers marked on the cooling shroud align with the respective memory sockets.

### Next steps

Follow the procedure listed in [After working inside your system](#).

### Related Links

- [Removing the front bezel](#)
- [Installing the optional front bezel](#)

## System memory

Your system supports DDR4 registered DIMMs (RDIMMs).

 **NOTE:** MT/s indicates DIMM speed in MegaTransfers per second.

Memory bus operating frequency can be 2133 MT/s, 1866 MT/s, 1600 MT/s, or 1333 MT/s depending on the following factors:

- System profile selected (for example, Performance Optimized, Custom, or Dense Configuration Optimized)
- Maximum supported DIMM frequency of the processors

The system contains 12 memory sockets split into four sets — two sets of 4 sockets and two sets of 2 sockets each. Each 4-socket set is organized into two channels and each 2-socket set is organized into one channel. In each channel of the 4-socket set, the release levers of the first socket are marked white and the second socket black. In the 2-socket set, each release lever is marked white.

 **NOTE:** DIMMs in sockets A1 to A8 are assigned to processor 1 and DIMMs in sockets B1 to B4 are assigned to processor 2.

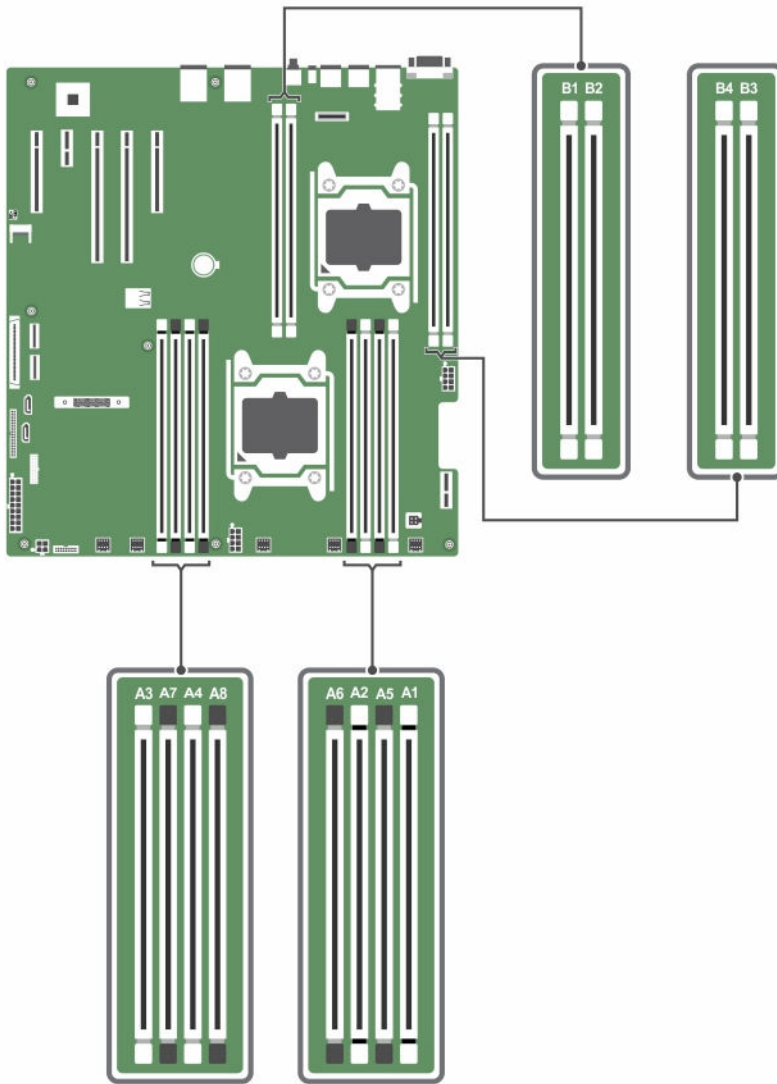

**Figure 17. System memory board**

Memory channels are organized as follows:

- Processor 1**
  - channel 0: memory sockets A1 and A5
  - channel 1: memory sockets A2 and A6
  - channel 2: memory sockets A3 and A7
  - channel 3: memory sockets A4 and A8
- Processor 2**
  - channel 0: memory sockets B1
  - channel 1: memory sockets B2
  - channel 2: memory sockets B3

channel 3: memory sockets B4

The following table shows the memory populations and operating frequencies for the supported configurations.

**Table 14. Supported configurations**

| DIMM Type    | DIMMs Populated/<br>Channel | Operating Frequency (in<br>MT/s) | Maximum DIMM Rank/Channel |
|--------------|-----------------------------|----------------------------------|---------------------------|
| <b>1.2 V</b> |                             |                                  |                           |
| RDIMM        | 1                           | 2133, 1866, 1600, 1333           | Dual rank or single rank  |
|              | 2                           | 2133, 1866, 1600, 1333           | Dual rank or single rank  |

## General memory module installation guidelines

Your system supports Flexible Memory Configuration, enabling the system to be configured and run in any valid chipset architectural configuration. The following are the recommended guidelines for installing memory modules:

- x4 and x8 DRAM based DIMMs can be mixed. For more information, see [Mode-specific guidelines](#).
- Up to two dual- or single-rank RDIMMs can be populated per channel.
- Populate DIMM sockets only if a processor is installed. For single-processor systems, sockets A1 to A8 are available. For dual-processor systems, sockets A1 to A8 and sockets B1 to B4 are available.
- Populate all sockets with white release levers first, and then all the sockets with black release levers.
- When mixing memory modules with different capacities, populate the sockets with memory modules with highest capacity first. For example, if you want to mix 4 GB and 8 GB DIMMs, populate 8 GB DIMMs in the sockets with white release levers and 4 GB DIMMs in the sockets with black release levers.
- In a dual-processor configuration, the memory configuration for each processor should be identical through the first eight slots. For example, if you populate socket A1 for processor 1, then populate socket B1 for processor 2, and so on.
- Memory modules of different capacities can be mixed provided other memory population rules are followed (for example, 4 GB and 8 GB memory modules can be mixed).
- Mixing of more than two DIMM capacities in a system is not supported.
- Populate two DIMMs per processor (one DIMM per channel) at a time to maximize performance.

## Mode-specific guidelines

Four memory channels are allocated to each processor. The allowable configurations depend on the memory mode selected.

 **NOTE:** You can mix x4 and x8 DRAM based DIMMs to support RAS features. However, all guidelines for specific RAS features must be followed. x4 DRAM based DIMMs retain Single Device Data Correction (SDDC) in memory optimized (independent channel) mode. x8 DRAM based DIMMs require Advanced ECC mode to gain SDDC.

The following sections provide additional slot population guidelines for each mode:

## Advanced ECC (lockstep)

Advanced ECC mode extends SDDC from x4 DRAM based DIMMs to both x4 and x8 DRAMs. This protects against single DRAM chip failures during normal operation.

Memory installation guidelines:

- Memory modules must be identical in size, speed, and technology.
- DIMMs installed in memory sockets with white release levers must be identical and similar rule applies for sockets with black release levers. This ensures that identical DIMMs are installed in matched pairs - for example, A1 with A2, A3 with A4, A5 with A6, and so on.

 **NOTE:** Advanced ECC with Mirroring is not supported.

## Memory optimized (independent channel) mode

This mode supports SDDC only for memory modules that use x4 device width, and the mode does not impose any specific slot population requirements.

## Memory sparing

 **NOTE:** To use memory sparing, this feature must be enabled in the System Setup.

In this mode, one rank per channel is reserved as a spare. If persistent correctable errors are detected on a rank, the data from this rank is copied to the spare rank and the failed rank is disabled.

With memory sparing enabled, the system memory available to the operating system is reduced by one rank per channel. For example, in a dual-processor configuration with sixteen 4 GB dual-rank DIMMs, the available system memory is:  $3/4$  (ranks/channel)  $\times$  16 (DIMMs)  $\times$  4 GB = 48 GB, and not 16 (DIMMs)  $\times$  4 GB = 64 GB.

 **NOTE:** Memory sparing does not offer protection against a multi-bit uncorrectable error.

 **NOTE:** Both Advanced ECC/Lockstep and Optimizer modes support Memory Sparing.

## Sample memory configurations

The following tables show sample memory configurations for one and two processor configurations that follow the appropriate memory guidelines.

 **NOTE:** 1R and 2R in the following tables indicate single- and dual-rank DIMMs respectively.

**Table 15. Memory configurations—single processor**

| System Capacity (in GB) | DIMM Size (in GB) | Number of DIMMs | DIMM Rank, Organization, and Frequency  | DIMM Slot Population |
|-------------------------|-------------------|-----------------|---|----------------------|
| 4                       | 4                 | 1               | 1R, x8, 2133 MT/s,<br>1R, x8, 1866 MT/s | A1                   |
| 8                       | 4                 | 2               | 1R, x8, 2133 MT/s,<br>1R, x8, 1866 MT/s | A1, A2               |

| System Capacity (in GB) | DIMM Size (in GB) | Number of DIMMs | DIMM Rank, Organization, and Frequency | DIMM Slot Population           |
|-------------------------|-------------------|-----------------|--|--------------------------------|
| 16                      | 4                 | 4               | 1R, x8, 2133 MT/s,                     | A1, A2, A3, A4                 |
|                         |                   |                 | 1R, x8, 1866 MT/s                      |                                |
|                         | 8                 | 2               | 2R, x8, 2133 MT/s,                     | A1, A2                         |
|                         |                   |                 | 2R, x8, 1866 MT/s                      |                                |
| 24                      | 4                 | 6               | 1R, x8, 2133 MT/s,                     | A1, A2, A3, A4, A5, A6         |
|                         |                   |                 | 1R, x8, 1866 MT/s                      |                                |
| 48                      | 8                 | 6               | 2R, x8, 2133 MT/s,                     | A1, A2, A3, A4, A5, A6         |
|                         |                   |                 | 2R, x8, 1866 MT/s                      |                                |
| 96                      | 16                | 6               | 2R, x4, 2133 MT/s,                     | A1, A2, A3, A4, A5, A6         |
|                         |                   |                 | 2R, x4, 1866 MT/s                      |                                |
| 128                     | 16                | 8               | 2R, x4, 2133 MT/s,                     | A1, A2, A3, A4, A5, A6, A7, A8 |
|                         |                   |                 | 2R, x4, 1866 MT/s,                     |                                |
| 192                     | 32                | 6               | RDIMM, 2R, x4, 2133 MT/s               | A1, A2, A3, A4, A5, A6         |
|                         |                   |                 | RDIMM, 2R, x4, 1866 MT/s               |                                |

**Table 16. Memory configurations—two processors**

| System Capacity (in GB) | DIMM Size (in GB) | Number of DIMMs | DIMM Rank, Organization, and Frequency | DIMM Slot Population                           |
|-------------------------|-------------------|-----------------|--|--|
| 16                      | 4                 | 4               | 1R, x8, 2133 MT/s,                     | A1, A2, B1, B2                                 |
|                         |                   |                 | 1R, x8, 1866 MT/s                      |  |
| 32                      | 4                 | 8               | 1R, x8, 2133 MT/s,                     | A1, A2, A3, A4, B1, B2, B3, B4                 |
|                         |                   |                 | 1R, x8, 1866 MT/s                      |  |
| 64                      | 8                 | 8               | 2R, x8, 2133 MT/s,                     | A1, A2, A3, A4, B1, B2, B3, B4                 |
|                         |                   |                 | 2R, x8, 1866 MT/s                      |  |
| 96                      | 8                 | 12              | 2R, x8, 2133 MT/s,                     | A1, A2, A3, A4, A5, A6, A7, A8, B1, B2, B3, B4 |
|                         |                   |                 | 2R, x8, 1866 MT/s                      |  |
| 128                     | 16                | 8               | 2R, x4, 2133 MT/s,                     | A1, A2, A3, A4, B1, B2, B3, B4                 |

| System Capacity (in GB) | DIMM Size (in GB) | Number of DIMMs | DIMM Rank, Organization, and Frequency   | DIMM Slot Population  |
|-------------------------|-------------------|-----------------|--|---|
|                         |                   |                 | 2R, x4, 1866 MT/s  |   |
| 160                     | 16 and 8          | 12              | 2R, x4, 2133 MT/s,<br>2R, x8, 2133 MT/s,<br>2R, x4, 1866 MT/s<br>2R, x8, 1866 MT/s | A1, A2, A3, A4, A5, A6,A7,A8, B1, B2, B3, B4<br> <b>NOTE:</b> 16 GB DIMMs must be installed in slots numbered A1, A2, A3, A4, B1, B2, B3, and B4 and 8 GB DIMMs must be installed in slots A5, A6, A7, and A8. |
| 192                     | 16                | 12              | 2R, x4, 2133 MT/s,<br>2R, x4, 1866 MT/s  | A1, A2, A3, A4, A5, A6,A7,A8, B1, B2, B3, B4  |
| 384                     | 32                | 12              | RDIMM, 2R, x4, 2133 MT/s<br>RDIMM, 2R, x4, 1866 MT/s                               | A1, A2, A3, A4, A5, A6,A7,A8, B1, B2, B3, B4  |

## Removing memory module

### Prerequisites

 **CAUTION:** Many repairs may only be done by a certified service technician. You should only perform troubleshooting and simple repairs as authorized in your product documentation, or as directed by the online or telephone service and support team. Damage due to servicing that is not authorized by Dell is not covered by your warranty. Read and follow the safety instructions that came with the product.

1. Ensure that you read the [Safety instructions](#).
2. Follow the procedure listed in [Before working inside your system](#).
3. Remove the cooling shroud.

 **WARNING:** The memory modules are hot to the touch for some time after the system has been powered down. Allow time for the memory modules to cool before handling them. Handle the memory modules by the card edges and avoid touching the components or metallic contacts on the memory module.

 **CAUTION:** To ensure proper system cooling, memory-module blanks must be installed in any memory socket that is not occupied. Remove memory-module blanks only if you intend to install memory modules in those sockets.

### Steps

1. Locate the appropriate memory module socket.

 **CAUTION:** Handle each memory module only by the card edges, making sure not to touch the middle of the memory module or metallic contacts.

2. To release the memory module from the socket, simultaneously press the ejectors on both ends of the memory-module socket.

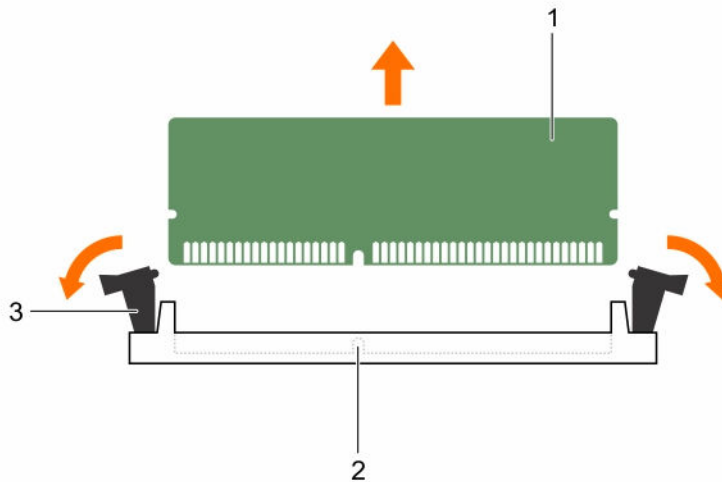

**Figure 18. Removing memory module**

- |                              |                         |
|------------------------------|-------------------------|
| 1. memory-module             | 2. memory-module socket |
| 3. memory module ejector (2) |                         |

#### Related Links

[Removing the cooling shroud](#)

## Installing memory modules

#### Prerequisites

**CAUTION:** Many repairs may only be done by a certified service technician. You should only perform troubleshooting and simple repairs as authorized in your product documentation, or as directed by the online or telephone service and support team. Damage due to servicing that is not authorized by Dell is not covered by your warranty. Read and follow the safety instructions that came with the product.

1. Ensure that you read the [Safety instructions](#).
2. Follow the procedure listed in [Before working inside your system](#).
3. Remove the cooling shroud.

**WARNING:** The memory modules are hot to the touch for some time after the system has been powered down. Allow time for the memory modules to cool before handling them. Handle the memory modules by the card edges and avoid touching the components or metallic contacts on the memory module.

#### Steps

1. Locate the appropriate memory-module socket.

**CAUTION:** Handle each memory module only by the card edges, making sure not to touch the middle of the memory module or metallic contacts.

2. If a memory module or a memory-module blank is installed in the socket, remove it.

 **NOTE:** Retain the removed memory-module blank(s) for future use.

 **CAUTION:** To prevent damage to the memory module or the memory-module socket during installation, do not bend or flex the memory module; insert both ends of the memory module simultaneously.

3. Align the edge connector of the memory module with the alignment key of the memory module socket, and insert the memory module in the socket.

 **NOTE:** The memory-module socket has an alignment key that allows you to install the memory module in the socket in only one orientation.

 **CAUTION:** Do not apply pressure at the center of the memory module; apply pressure at both ends of the memory module evenly.

4. Press the memory module with your thumbs until the socket levers firmly click into place.

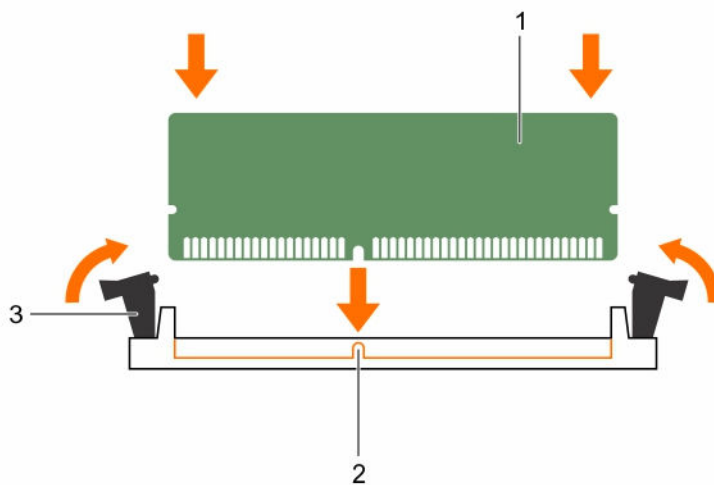

**Figure 19. Installing the memory module**

- |                                     |                  |
|-------------------------------------|------------------|
| 1. memory module                    | 2. alignment key |
| 3. memory-module socket ejector (2) |                  |

When the memory module is properly seated in the socket, the levers on the memory module socket align with the levers on the other sockets that have memory modules installed.

5. Repeat steps 3 and 4 of this procedure to install the remaining memory modules.

#### Next steps

1. Install the cooling shroud.
2. Follow the procedure listed in [After working inside your system](#).
3. Press <F2> to enter System Setup, and check the **System Memory** setting. The **System Memory** value should reflect the newly installed memory.
4. If the value is incorrect, one or more of the memory modules may not be installed properly. Repeat step 3 and step 4 of this procedure, checking to ensure that the memory modules are firmly seated in their sockets.



5. Run the system memory test in the system diagnostics.

#### Related Links

- [Removing the cooling shroud](#)
- [Installing the cooling shroud](#)

## Hard drives

Depending on the configuration, your system supports one of the following:

- |                                 |   |
|---------------------------------|---|
| <b>Four hard-drive systems</b>  | Up to four 3.5-inch cabled hard drives, or<br><br>Up to four 3.5-inch hot-swappable SAS HDD, SATA HDD, or SATA SSD or<br>Up to four 2.5-inch hot-swappable SAS HDD, SATA HDD, or SATA SSD |
| <b>Eight hard-drive systems</b> | Up to eight 2.5-inch hot-swappable SAS HDD, SATA HDD, or SATA SSD   |
| <b>Ten hard-drive systems</b>   | Up to ten 2.5-inch hot-swappable SATA HDD or SATA SSD   |

 **NOTE:** SSD/SAS/SATA hard drives cannot be mixed in a system.

The hot-swappable hard drives connect to the system board through the hard-drive backplane. Hot-swappable hard drives are supplied in hot-swappable hard-drive carriers that fit in the hard-drive slots.

 **CAUTION:** Before attempting to remove or install a hot-swappable hard drive while the system is running, see the documentation for the storage controller card to ensure that the host adapter is configured correctly to support hot-swap hard drive removal and insertion.

 **CAUTION:** Do not turn off or reboot your system while the hard drive is being formatted. Doing so can cause a hard drive failure.

 **NOTE:** Use only hard drives that have been tested and approved for use with the hard-drive backplane.

When you format a hard drive, allow enough time for the formatting to be completed. Be aware that high-capacity hard drives can take a number of hours to format.

## Removing a 2.5 inch hard-drive blank

#### Prerequisites

 **CAUTION:** Many repairs may only be done by a certified service technician. You should only perform troubleshooting and simple repairs as authorized in your product documentation, or as directed by the online or telephone service and support team. Damage due to servicing that is not authorized by Dell is not covered by your warranty. Read and follow the safety instructions that came with the product.

 **CAUTION:** To maintain proper system cooling, all empty hard-drive slots must have hard-drive blanks installed.

1. Ensure that you read the [Safety instructions](#).
2. If installed, remove the bezel.

## Steps

Press the release button and slide the hard-drive blank out of the hard-drive slot.

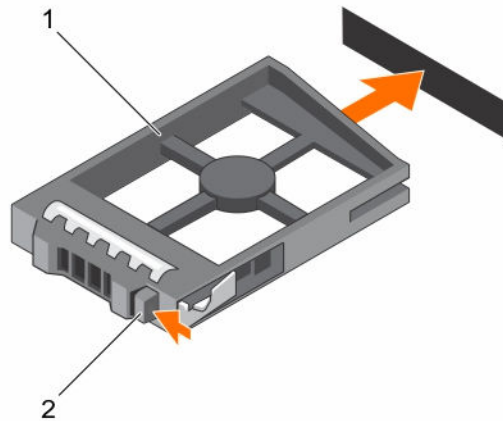

**Figure 20. Removing and installing a 2.5 inch hard-drive blank**

1. hard-drive blank
2. release button

## Related Links

[Removing the front bezel](#)

[Installing the optional front bezel](#)

## Installing a 2.5 inch hard-drive blank

### Prerequisites



**CAUTION:** Many repairs may only be done by a certified service technician. You should only perform troubleshooting and simple repairs as authorized in your product documentation, or as directed by the online or telephone service and support team. Damage due to servicing that is not authorized by Dell is not covered by your warranty. Read and follow the safety instructions that came with the product.

1. Ensure that you read the [Safety instructions](#).
2. If installed, remove the front bezel.

## Steps

Insert the hard-drive blank into the hard-drive slot until the release button clicks into place.

## Next steps

If applicable, install the front bezel.

## Related Links

[Removing the front bezel](#)

[Installing the optional front bezel](#)

## Removing a 3.5 inch hard-drive blank

### Prerequisites

⚠ **CAUTION:** Many repairs may only be done by a certified service technician. You should only perform troubleshooting and simple repairs as authorized in your product documentation, or as directed by the online or telephone service and support team. Damage due to servicing that is not authorized by Dell is not covered by your warranty. Read and follow the safety instructions that came with the product.

⚠ **CAUTION:** To maintain proper system cooling, all empty hard-drive slots must have drive blanks installed.

1. Ensure that you read the [Safety instructions](#).
2. If installed, remove the front bezel.

### Steps

Press the release button and slide the blank out of the hard-drive slot.

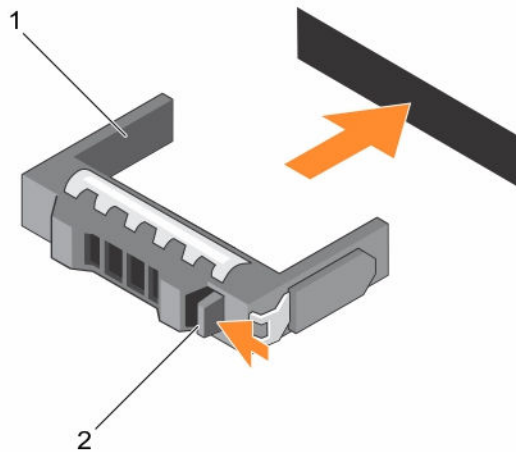

Figure 21. Removing and installing a 3.5 inch hard-drive blank

1. hard-drive blank
2. release button

### Next steps

If applicable, install the front bezel.

### Related Links

[Removing the front bezel](#)

[Installing the optional front bezel](#)

## Installing a 3.5 inch hard-drive blank

### Prerequisites

 **CAUTION:** Many repairs may only be done by a certified service technician. You should only perform troubleshooting and simple repairs as authorized in your product documentation, or as directed by the online or telephone service and support team. Damage due to servicing that is not authorized by Dell is not covered by your warranty. Read and follow the safety instructions that came with the product.

1. Ensure that you read the [Safety instructions](#).
2. If installed, remove the front bezel.

### Steps

Insert the hard-drive blank into the hard-drive slot until the release button clicks into place.

### Next steps

If applicable, install the front bezel.

### Related Links

[Removing the front bezel](#)

[Installing the optional front bezel](#)

## Removing a cabled hard drive

### Prerequisites

 **CAUTION:** Many repairs may only be done by a certified service technician. You should only perform troubleshooting and simple repairs as authorized in your product documentation, or as directed by the online or telephone service and support team. Damage due to servicing that is not authorized by Dell is not covered by your warranty. Read and follow the safety instructions that came with the product.

1. Ensure that you read the [Safety instructions](#).
2. Follow the procedure listed in [Before working inside your system](#).

### Steps

1. Disconnect the data/power cable from the hard drive.
2. Press the release tab on the hard-drive carrier and slide the hard drive out of the hard-drive bay.

 **CAUTION:** To maintain proper system cooling, all empty hard-drive slots must have hard-drive blanks installed.

3. Insert a hard-drive blank in the empty hard-drive slot.

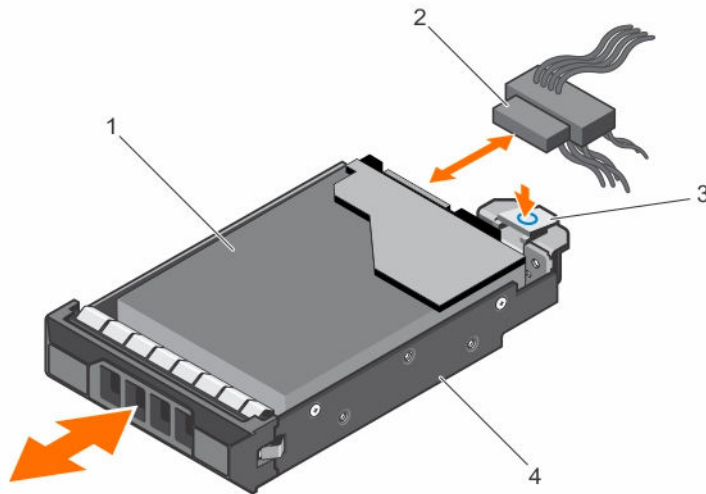

**Figure 22. Removing and installing a cabled hard drive**

- |                |                       |
|----------------|-----------------------|
| 1. hard drive  | 2. power/data cable   |
| 3. release tab | 4. hard-drive carrier |

## Installing a cabled hard drive

### Prerequisites

**⚠ CAUTION:** Many repairs may only be done by a certified service technician. You should only perform troubleshooting and simple repairs as authorized in your product documentation, or as directed by the online or telephone service and support team. Damage due to servicing that is not authorized by Dell is not covered by your warranty. Read and follow the safety instructions that came with the product.

Ensure that you read the [Safety instructions](#).

### Steps

1. Press the release tab on the hard-drive carrier and slide the carrier out of the system.
2. Install the hard drive into the hard-drive carrier.
3. Insert the hard-drive carrier into the hard-drive slot till it clicks into place.
4. Connect the power/data cable to the hard drive.
  - If connecting to the integrated SATA controller (SATA hard drives only), connect the SATA data cable to the SATA\_A-D connector on the system board.
  - If connecting to a SAS RAID controller card (SAS or SATA hard drives), connect the data cable to the connector on the card.

### Next steps

1. Follow the procedure listed in [After working inside your system](#).
2. Reconnect the system to its electrical outlet and turn the system on, including any attached peripherals.

3. Enter the System Setup and ensure that the hard drive's controller is enabled.
4. Exit the System Setup program and reboot the system.
5. Install any software required for the hard drive operation as described in the documentation for the hard drive.

## Removing a hot-swap hard drive

### Prerequisites

 **CAUTION: Many repairs may only be done by a certified service technician. You should only perform troubleshooting and simple repairs as authorized in your product documentation, or as directed by the online or telephone service and support team. Damage due to servicing that is not authorized by Dell is not covered by your warranty. Read and follow the safety instructions that came with the product.**

1. Ensure that you read the [Safety instructions](#).
2. If installed, remove the front bezel.
3. Using the management software, prepare the hard drive for removal. For more information, see the documentation for the storage controller.

If the hard drive is online, the green activity/fault indicator flashes as the drive is turned off. You can remove the hard-drive when the hard-drive indicators turn off.

 **CAUTION: To prevent data loss, ensure that your operating system supports hot-swap drive installation. See the documentation supplied with your operating system.**

### Steps

1. Press the release button to open the hard-drive carrier release handle.
2. Slide the hard-drive carrier out of the hard-drive slot.

 **CAUTION: To maintain proper system cooling, all empty hard-drive slots must have hard-drive blanks installed.**

3. If you are not replacing the hard drive immediately, insert a hard-drive blank in the empty hard-drive slot.

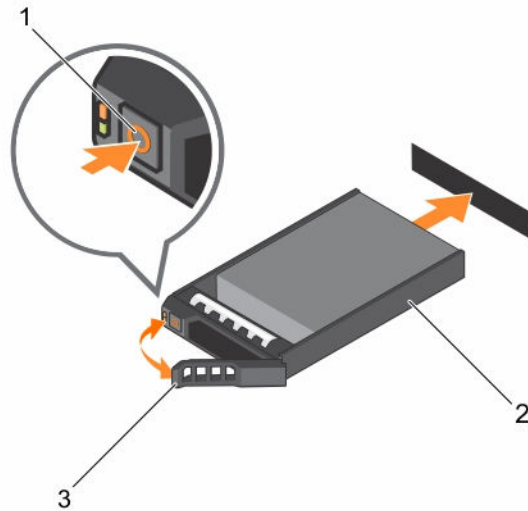

**Figure 23. Removing and installing a hot-swap hard drive**

1. release button
2. hard-drive carrier
3. hard-drive carrier handle

#### Next steps

If removed, install the front bezel.

## Installing a hot-swap hard drive

#### Prerequisites

- △ **CAUTION:** Many repairs may only be done by a certified service technician. You should only perform troubleshooting and simple repairs as authorized in your product documentation, or as directed by the online or telephone service and support team. Damage due to servicing that is not authorized by Dell is not covered by your warranty. Read and follow the safety instructions that came with the product.
- △ **CAUTION:** Use only hard drives that have been tested and approved for use with the hard-drive backplane.
- △ **CAUTION:** Combining SAS and SATA hard drives in the same RAID volume is not supported.
- △ **CAUTION:** When installing a hard drive, ensure that the adjacent drives are fully installed. Inserting a hard-drive carrier and attempting to lock its handle next to a partially installed carrier can damage the partially installed carrier's shield spring and make it unusable.
- △ **CAUTION:** To prevent data loss, ensure that your operating system supports hot-swap drive installation. See the documentation supplied with your operating system.
- △ **CAUTION:** When a replacement hot-swappable hard drive is installed and the system is powered on, the hard drive automatically begins to rebuild. Make absolutely sure that the replacement hard drive is blank or contains data that you wish to have over-written. Any data on the replacement hard drive is immediately lost after the hard drive is installed.

### Steps

1. If a hard-drive blank is installed in the hard-drive slot, remove it.
2. Install a hard drive in the hard-drive carrier.
3. Press the release button on the front of the hard-drive carrier and open the hard-drive carrier handle.
4. Insert the hard-drive carrier into the hard-drive slot until the carrier comes in contact with the backplane.
5. Close the hard-drive carrier handle to lock the hard drive in place.

### Next steps

If applicable, install the front bezel.

## Installing a 2.5 inch hard drive into a 3.5 inch hard-drive adapter

### Prerequisites

**⚠ CAUTION:** Many repairs may only be done by a certified service technician. You should only perform troubleshooting and simple repairs as authorized in your product documentation, or as directed by the online or telephone service and support team. Damage due to servicing that is not authorized by Dell is not covered by your warranty. Read and follow the safety instructions that came with the product.

1. Keep the #2 Phillips screwdriver ready.
2. Ensure that you read the [Safety instructions](#).

### Steps

1. Align the screw holes on the 2.5 inch hard drive with the screw holes on the 3.5 inch hard-drive adapter.
2. Install the screws to secure the hard drive to the hard-drive adapter.

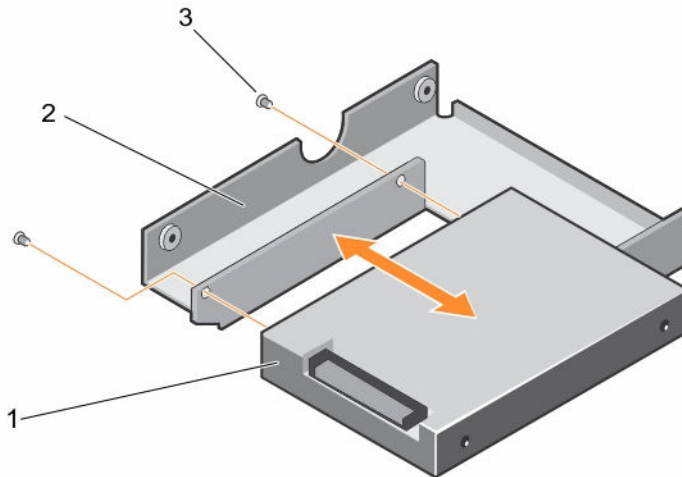

**Figure 24. Removing and Installing a 2.5 inch hard drive into a 3.5 inch hard-drive adapter**

1. 2.5 inch hard drive
2. 3.5 inch hard-drive adapter
3. screw (2)



## Removing a 2.5 inch hard drive from a 3.5 inch hard-drive adapter

### Prerequisites

 **CAUTION:** Many repairs may only be done by a certified service technician. You should only perform troubleshooting and simple repairs as authorized in your product documentation, or as directed by the online or telephone service and support team. Damage due to servicing that is not authorized by Dell is not covered by your warranty. Read and follow the safety instructions that came with the product.

1. Ensure that you read the [Safety instructions](#).
2. Keep the #2 Phillips screwdriver ready.

 **NOTE:** A 2.5 inch hard drive is installed in a 3.5 inch hard-drive adapter, which is then installed in the 3.5 inch hard-drive carrier.

### Steps

1. Remove the screws from the side of the 3.5 inch hard-drive adapter.
2. Remove the hard drive from the hard-drive adapter.

## Installing a hard-drive adapter into a hard-drive carrier

### Prerequisites

 **CAUTION:** Many repairs may only be done by a certified service technician. You should only perform troubleshooting and simple repairs as authorized in your product documentation, or as directed by the online or telephone service and support team. Damage due to servicing that is not authorized by Dell is not covered by your warranty. Read and follow the safety instructions that came with the product.

1. Ensure that you read the [Safety instructions](#).
2. Keep the #2 Phillips screwdriver ready.

### Steps

1. Insert the hard-drive adapter into the hard-drive carrier with the connector end of the hard drive toward the back of the hard-drive carrier.
2. Align the screw holes on the hard drive with the holes on the hard-drive carrier.
3. Install the screws to secure the hard drive to the hard-drive carrier.

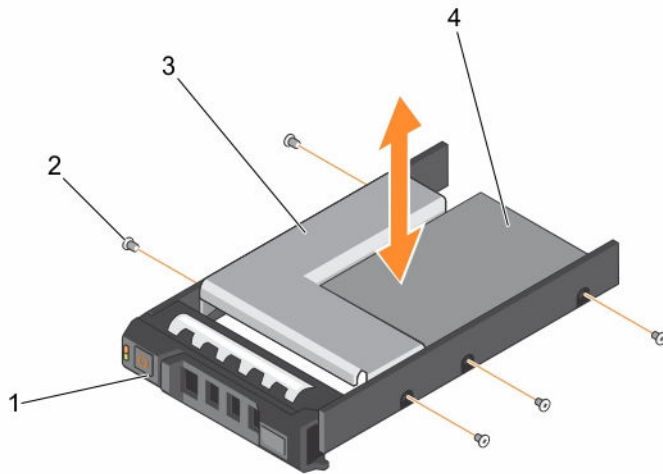

**Figure 25. Removing and installing a hard-drive adapter into a 3.5 inch hard-drive carrier**

- |                                |                        |
|--------------------------------|------------------------|
| 1. 3.5 inch hard-drive carrier | 2. screw (5)           |
| 3. hard-drive adapter          | 4. 2.5 inch hard drive |

## Removing a hard-drive adapter from a hard-drive carrier

### Prerequisites

1. Ensure that you read the [Safety instructions](#).
2. Keep the #2 Phillips screwdriver ready.

### Steps

1. Remove the screws from the slide rails on the hard-drive carrier.
2. Lift the hard-drive adapter out of the hard-drive carrier.

## Removing a hard drive from a hard-drive carrier

### Prerequisites

1. Keep the #2 Phillips screwdriver ready.
2. Remove the hard-drive carrier from the system.

### Steps

1. Remove the screws from the slide rails on the hard-drive carrier.
2. Lift the hard drive out of the hard-drive carrier.

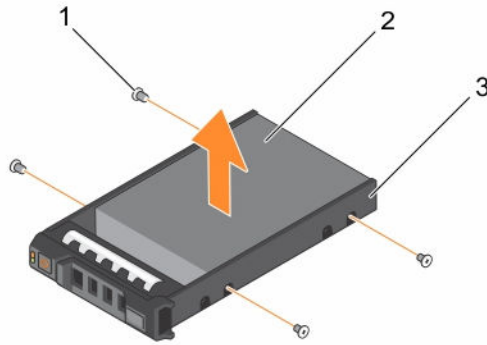

**Figure 26. Removing and installing a hard drive into a hard-drive carrier**

1. screw (4)
2. hard drive
3. hard-drive carrier

## Installing a hard drive into a hard-drive carrier

### Prerequisites

**△ CAUTION:** Many repairs may only be done by a certified service technician. You should only perform troubleshooting and simple repairs as authorized in your product documentation, or as directed by the online or telephone service and support team. Damage due to servicing that is not authorized by Dell is not covered by your warranty. Read and follow the safety instructions that came with the product.

Keep the #1 Phillips screwdriver handy.

### Steps

1. Insert the hard drive into the hard-drive carrier with the connector end of the hard drive toward the back.
2. Align the screw holes on the hard drive with the set of screw holes on the hard-drive carrier. When aligned correctly, the back of the hard drive is flush with the back of the hard-drive carrier.
3. Attach the screws to secure the hard drive to the hard-drive carrier.

## Optical drive (optional)

### Removing an ultra slim optical drive

#### Prerequisites

**△ CAUTION:** Many repairs may only be done by a certified service technician. You should only perform troubleshooting and simple repairs as authorized in your product documentation, or as directed by the online or telephone service and support team. Damage due to servicing that is not authorized by Dell is not covered by your warranty. Read and follow the safety instructions that came with the product.

1. Ensure that you read the [Safety instructions](#).
2. Follow the procedure listed in [Before working inside your system](#).

### Steps

1. Disconnect the power/data cable from the back of the optical drive.  
Observe the routing of the power and data cable inside the chassis as you remove them from the system board and the drive. You must route these cables properly when you replace them to prevent them from being pinched or crimped.
2. To release the optical drive, press and push the release tab toward the front of the system.
3. Slide the optical drive out of the system until it is free of the optical-drive slot.
4. If you are not adding a new optical drive, install the optical-drive blank.

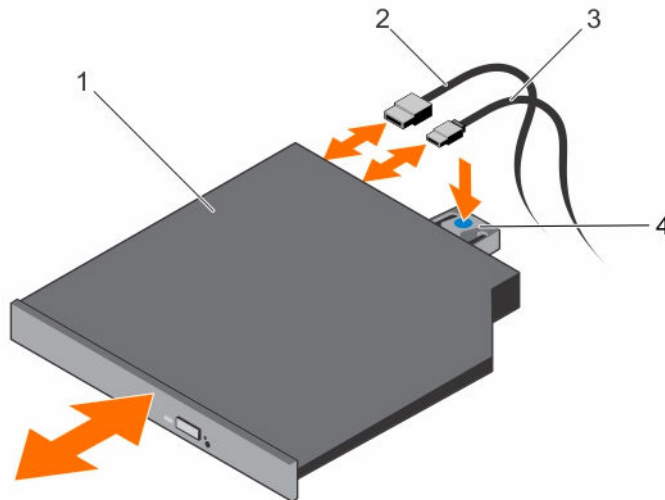

Figure 27. Removing and installing an ultra slim optical drive

- |                  |                |
|------------------|----------------|
| 1. optical drive | 2. data cable  |
| 3. power cable   | 4. release tab |

### Next steps

Follow the procedure listed in [After working inside your system](#).

## Installing an ultra slim optical drive

### Prerequisites

**CAUTION:** Many repairs may only be done by a certified service technician. You should only perform troubleshooting and simple repairs as authorized in your product documentation, or as directed by the online or telephone service and support team. Damage due to servicing that is not authorized by Dell is not covered by your warranty. Read and follow the safety instructions that came with the product.

1. Ensure that you read the [Safety instructions](#).
2. Follow the procedure listed in [Before working inside your system](#).

### Steps

1. To remove the optical drive blank, press the blue release tab at the back of the blank and push the blank out of the system.
2. Align the optical drive with the optical drive slot on the front of chassis.
3. Slide the optical drive into the slot until the latch snaps into place.
4. Connect the power/data cable to the back of the drive.
5. Route the power/data cable underneath the cable routing latch of the system.
6. Connect the power/data cable to the connectors on the system board.

### Next steps

1. Follow the procedure listed in [After working inside your system](#).

## Removing the standard optical drive

### Prerequisites



**CAUTION:** Many repairs may only be done by a certified service technician. You should only perform troubleshooting and simple repairs as authorized in your product documentation, or as directed by the online or telephone service and support team. Damage due to servicing that is not authorized by Dell is not covered by your warranty. Read and follow the safety instructions that came with the product.

1. Ensure that you read the [Safety instructions](#).
2. Follow the procedure listed in [Before working inside your system](#).

### Steps

1. Disconnect the power/data cable from the back of the optical drive.  
Observe the routing of the power and data cable inside the chassis as you remove them from the system board and the drive. You must route these cables properly when you replace them to prevent them from being pinched or crimped.
2. Pull the release latch and disengage the optical drive from the notches on the metal standoffs.
3. Lift the optical drive out of the system.
4. If you are not adding a new optical drive, install the optical-drive blank.

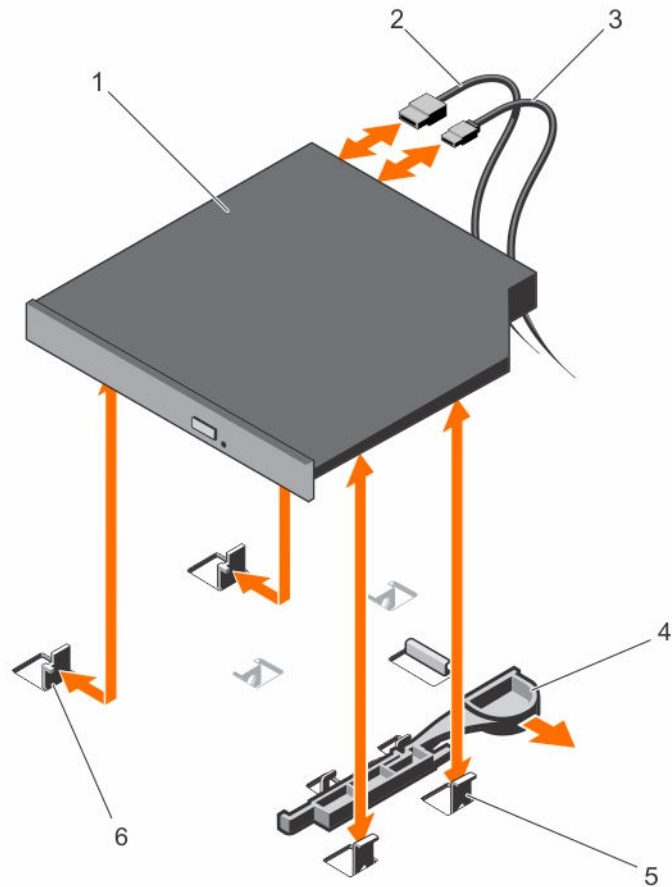

**Figure 28. Removing and installing the standard optical drive**

- |                       |                                    |
|-----------------------|------------------------------------|
| 1. optical drive      | 2. data cable                      |
| 3. power cable        | 4. release latch                   |
| 5. metal standoff (4) | 6. notch on the metal standoff (2) |

#### Next steps

Follow the procedure listed in [After working inside your system](#).

## Installing the standard optical drive

#### Prerequisites

**⚠ CAUTION:** Many repairs may only be done by a certified service technician. You should only perform troubleshooting and simple repairs as authorized in your product documentation, or as directed by the online or telephone service and support team. Damage due to servicing that is not authorized by Dell is not covered by your warranty. Read and follow the safety instructions that came with the product.

1. Ensure that you read the [Safety instructions](#).
2. Follow the procedure listed in [Before working inside your system](#).

### Steps

1. Align the two notches on the metal standoffs with the slots on the side of the optical drive.
2. Slide the optical drive into the notches until it is seated firmly and the release latch snaps into place.
3. Connect the power cable.
4. Connect the data cable to the back of the drive and to the SATA connector on the system board.

 **NOTE:** Route and secure the cables using the cable routing latch on the system chassis to prevent them from being pinched or crimped.

### Next steps

Follow the procedure listed in [After working inside your system](#).

## Cooling fans

Your system supports:

- Up to five cooling fans in a non-redundant power supply configuration.
- Up to six cooling fans in a redundant power supply configuration.

 **NOTE:** Fan 1 must be installed in a redundant power supply configuration.

 **NOTE:** Hot-swap removal or installation of the fans is not supported.

 **NOTE:** Each fan is listed in the system's management software, referenced by the respective fan number. If there is a problem with a particular fan, you can easily identify and replace the proper fan by noting the fan numbers on the cooling fan assembly.

## Removing a cooling fan

### Prerequisites

 **CAUTION:** Many repairs may only be done by a certified service technician. You should only perform troubleshooting and simple repairs as authorized in your product documentation, or as directed by the online or telephone service and support team. Damage due to servicing that is not authorized by Dell is not covered by your warranty. Read and follow the safety instructions that came with the product.

 **NOTE:** The procedure for removing each fan is identical.

1. Ensure that you read the [Safety instructions](#).
2. Follow the procedure listed in [Before working inside your system](#).
3. If installed, remove the cooling shroud.

### Steps

1. Disconnect the fan's power cable from the power cable connector on the system board or power interposer board as applicable.
2. Lift the fan out of the cooling-fan bracket.

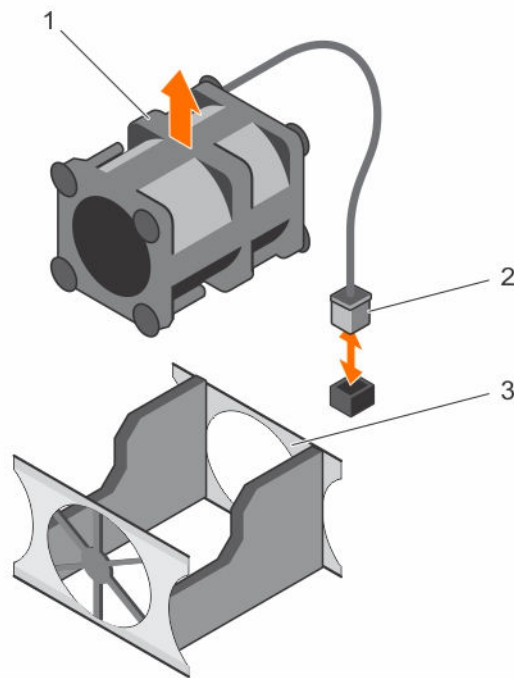

**Figure 29. Removing and installing a cooling fan**

1. cooling fan
2. power cable connector
3. cooling-fan bracket

#### Related Links

[Removing the cooling shroud](#)

## Installing a cooling fan

#### Prerequisites

**⚠ CAUTION:** Many repairs may only be done by a certified service technician. You should only perform troubleshooting and simple repairs as authorized in your product documentation, or as directed by the online or telephone service and support team. Damage due to servicing that is not authorized by Dell is not covered by your warranty. Read and follow the safety instructions that came with the product.

1. Ensure that you read the [Safety instructions](#).
2. Remove the cooling shroud.

#### Steps

1. Facing the front of the system, lower the fan into the cooling-fan bracket.  
**📌 NOTE:** When aligned correctly, the fan cable is on the left of the fan.
2. Connect the fan's power cable to the power cable connector on the system board as applicable.
3. Install the cooling shroud.



### Next steps

Follow the procedure listed in [After working inside your system](#).

### Related Links

[Removing the cooling shroud](#)

[Installing the cooling shroud](#)

## Internal USB memory key (optional)

The USB memory key installed inside your system can be used as a boot device, security key, or mass storage device.

To boot from the USB memory key, configure the USB memory key with a boot image and then specify the USB memory key in the boot sequence in the System Setup.

 **NOTE:** The internal USB connector is located on the system board.

### Related Links

[System board connectors](#)

## Replacing the internal USB key

### Prerequisites

 **CAUTION:** Many repairs may only be done by a certified service technician. You should only perform troubleshooting and simple repairs as authorized in your product documentation, or as directed by the online or telephone service and support team. Damage due to servicing that is not authorized by Dell is not covered by your warranty. Read and follow the safety instructions that came with the product.

1. Ensure that you read the [Safety instructions](#).
2. Follow the procedure listed in [Before working inside your system](#)

### Steps

1. Locate the USB connector/USB key on the system board.  
To locate the USB connector, see [System board connectors](#).
2. If installed, remove the USB key.
3. Insert the USB key into the USB connector.

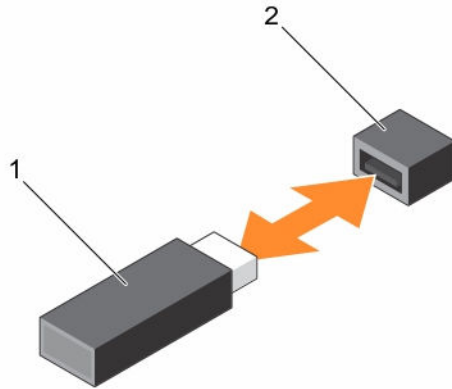

**Figure 30. Replacing the internal USB key**

1. USB memory key
2. USB memory key connector

#### Next steps

1. Follow the procedure listed in [After working inside your system](#).
2. While booting, press <F2> to enter the **System Setup** and verify that the USB key is detected by the system.

## Expansion cards and expansion-card risers (optional)

**NOTE:** A missing or an unsupported expansion-card riser logs an SEL event. It does not prevent your system from powering on and no BIOS POST message or F1/F2 pause is displayed.

### Expansion card installation guidelines

Your system supports Generation 1, Generation 2, and Generation 3 cards. The following table provides riser configurations for R430 systems:

**Table 17. Expansion card slots available on the expansion-card riser**

| Expansion-card riser | PCIe slot on the expansion-card riser | Processor connection | Height      | Length      | Link width | Slot width |
|----------------------|---------------------------------------|----------------------|-------------|-------------|------------|------------|
| PCIe_G3_X16          | 1                                     | Processor 1          | Half Height | Half Length | x16        | x16        |
|                      | 2                                     | Processor 1          | Half Height | Half Length | x16        | x16        |
| PCIe_G3_X8           | 1                                     | Processor 1          | Full Height | Half Length | x8         | x16        |

| Expansion-card riser | PCIe slot on the expansion-card riser | Processor connection | Height      | Length      | Link width | Slot width |
|----------------------|---------------------------------------|----------------------|-------------|-------------|------------|------------|
|                      | 2                                     | Processor 1          | Half Height | Half Height | x8         | x16        |

 **NOTE:** The PCIE\_G3\_X8 and PCIE\_G3\_X16 are the two different types of risers supported on R430 systems. You can install an expansion card on the system board only using expansion-card riser.

 **NOTE:** The expansion cards are not hot-swappable.

The following table provides a guide for installing expansion cards to ensure proper cooling and mechanical fit. The expansion cards with the highest priority must be installed first using the slot priority indicated. All other expansion cards must be installed in card priority and slot priority order.

**Table 18. Expansion card installation order (LP+LP configuration)**

| Card priority | Card type                              | Slot priority   | Maximum allowed |
|---------------|--|-----------------|-----------------|
| 1             | RAID Integrated Storage                | Integrated Slot | 1               |
|               | RAID External Storage                  | 2, 1            | 1               |
| 2             | Infiniband single Port/Dual (Mellanox) | 2, 1            | 2               |
| 3             | 40 Gb NICs                             | 2, 1            | 2               |
| 4             | 10 Gb NICs                             | 2, 1            | 2               |
| 5             | FC8 HBA                                | 2, 1            | 2               |
| 6             | 1 Gb NICs                              | 2, 1            | 2               |
| 7             | 12 GB SAS HBA                          | 2, 1            | 2               |
|               | HBA330                                 | Integrated Slot | 1               |

**Table 19. Expansion card installation order (FH+LP configuration)**

| Card priority | Card type                                   | Slot priority   | Maximum allowed |
|---------------|---|-----------------|-----------------|
| 1             | RAID Integrated Storage                     | Integrated Slot | 1               |
|               | RAID External Storage Low Profile           | 2               | 1               |
|               | RAID External Storage Full Height           | 1               | 1               |
| 2             | Infiniband Single Port/Dual Port (Mellanox) | 2               | 1               |
| 3             | 40 Gb NICs (Low profile)                    | 2               | 1               |
|               | 40 Gb NICs (Full height)                    | 1               | 1               |
| 4             | 10 Gb NICs (Low profile)                    | 2               | 1               |
|               | 10 Gb NICs (Full height)                    | 1               | 1               |
| 5             | FC8 HBA (Low profile)                       | 2               | 1               |

| Card priority | Card type                   | Slot priority   | Maximum allowed |
|---------------|-----------------------------|-----------------|-----------------|
|               | FC8 HBA (Full height)       | 1               | 1               |
| 6             | 1 Gb NICs (Low profile)     | 2               | 1               |
|               | 1 Gb NICs (Full height)     | 1               | 1               |
| 7             | 12 GB-SAS-HBA (Low profile) | 2               | 1               |
|               | 12 GB-SAS-HBA (Full height) | 1               | 1               |
| 8             | Non-RAID HBA330             | Integrated Slot | 1               |

## Removing the expansion-card riser

### Prerequisites

**CAUTION:** Many repairs may only be done by a certified service technician. You should only perform troubleshooting and simple repairs as authorized in your product documentation, or as directed by the online or telephone service and support team. Damage due to servicing that is not authorized by Dell is not covered by your warranty. Read and follow the safety instructions that came with the product.

1. Ensure that you read the [Safety instructions](#).
2. Follow the procedure listed in [Before working inside your system](#).

### Steps

Holding the touch points, lift the expansion-card riser from the riser connector on the system board.

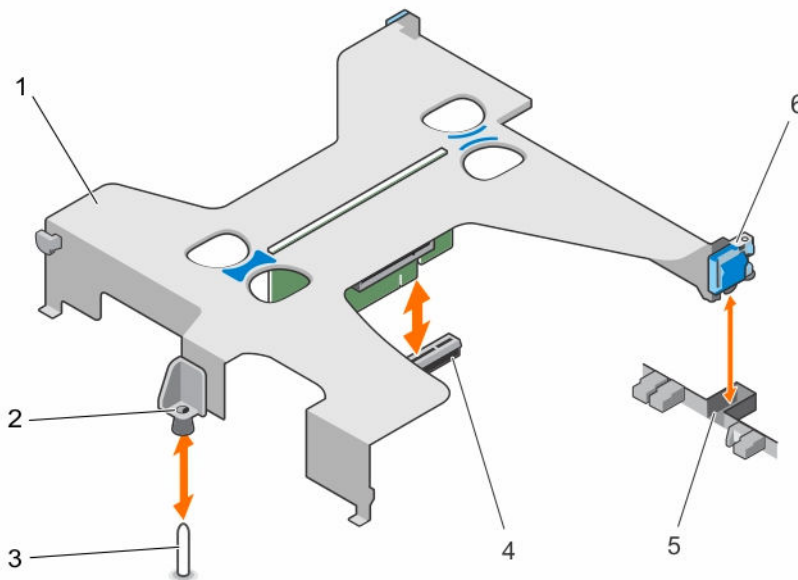

**Figure 31. Removing and installing the expansion-card riser**

- |                                  |  |
|----------------------------------|--|
| 1. expansion-card riser          | 2. guide on the expansion-card riser             |
| 3. guide pin on the system board | 4. expansion-riser connector on the system board |

5. slot on the chassis

6. expansion-card latch

### Next steps

1. Install the expansion card, if applicable.
2. Install the expansion-card riser.
3. Follow the procedure listed in [After working inside your system](#).

### Related Links

[Removing an expansion card](#)

[Installing an expansion card](#)

[Installing the expansion-card riser](#)

## Installing the expansion-card riser

### Prerequisites

 **CAUTION:** Many repairs may only be done by a certified service technician. You should only perform troubleshooting and simple repairs as authorized in your product documentation, or as directed by the online or telephone service and support team. Damage due to servicing that is not authorized by Dell is not covered by your warranty. Read and follow the safety instructions that came with the product.

Ensure that you read the [Safety instructions](#).

### Steps

1. If applicable, reinstall the expansion card into the expansion-card riser.
2. Align the following:
  - a. guide on the expansion-card riser with the guide pin on the system board.
  - b. expansion-card riser latch with the slot on the chassis.
3. Lower the expansion-card riser until the expansion-card riser is fully seated in the connector.

### Next steps

Follow the procedure listed in [After working inside your system](#).

### Related Links

[Removing an expansion card](#)

[Installing an expansion card](#)

## Removing an expansion card

### Prerequisites

 **CAUTION:** Many repairs may only be done by a certified service technician. You should only perform troubleshooting and simple repairs as authorized in your product documentation, or as directed by the online or telephone service and support team. Damage due to servicing that is not authorized by Dell is not covered by your warranty. Read and follow the safety instructions that came with the product.

1. Ensure that you read the [Safety instructions](#).
2. Follow the procedure listed in [Before working inside your system](#).

## Steps

1. Disconnect any cables connected to the expansion card or expansion-card riser.
2. If installed, remove the expansion-card riser.
3. Hold the expansion card by its edges and remove it from the expansion-card connector on the riser.
4. If you are removing the card permanently, install a metal filler bracket over the empty expansion slot and close the expansion-card latch.

 **NOTE:** You must install a filler bracket over an empty expansion slot to maintain Federal Communications Commission (FCC) certification of the system. The brackets also keep dust and dirt out of the system and aid in proper cooling and airflow inside the system.

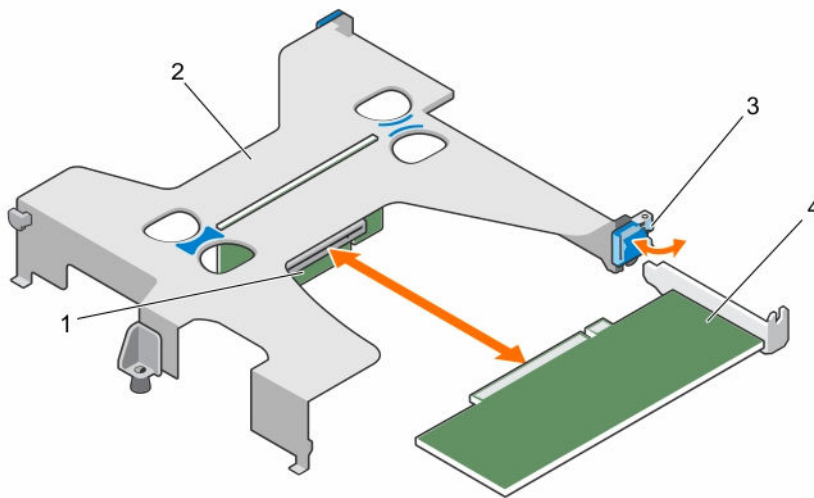

**Figure 32. Removing and installing the expansion card from expansion-card riser**

- |  |                         |
|--|-------------------------|
| 1. expansion-card connector on the riser | 2. expansion-card riser |
| 3. expansion-card latch                  | 4. expansion card       |

## Next steps

Follow the procedure listed in [After working inside your system.](#)

## Related Links

[Removing the expansion-card riser](#)

[Installing the expansion-card riser](#)

## Installing an expansion card

### Prerequisites

 **CAUTION:** Many repairs may only be done by a certified service technician. You should only perform troubleshooting and simple repairs as authorized in your product documentation, or as directed by the online or telephone service and support team. Damage due to servicing that is not authorized by Dell is not covered by your warranty. Read and follow the safety instructions that came with the product.

1. Ensure that you read the [Safety instructions](#).
2. Follow the procedure listed in [Before working inside your system](#).

### Steps

1. Locate the expansion-card connector on the riser.
2. Holding the card by its edges, position the card so that the card-edge connector aligns with the expansion-card connector.
3. Align the expansion-card bracket with the hooks on the chassis.
4. Insert the card-edge connector into the expansion-card connector until the card is fully seated.



**NOTE:** Ensure that the expansion card is properly seated along the chassis, so that expansion-card latch can be closed.

5. If applicable, connect cables to the expansion card.
6. Install the expansion card-riser on the system board.

### Next steps

Follow the procedure listed in [After working inside your system](#).

### Related Links

[Removing the expansion-card riser](#)

[Installing the expansion-card riser](#)

## iDRAC ports card (optional)

The iDRAC ports card consists of the SD vFlash card slot and an iDRAC port. The iDRAC ports card is used for advanced management of the system.

An SD vFlash card is a Secure Digital (SD) card that plugs into the SD vFlash card slot in the system. It provides persistent on-demand local storage and a custom deployment environment that allows automation of server configuration, scripts, and imaging. It emulates USB device(s). For more information, see the Integrated Dell Remote Access Controller User's Guide at [dell.com/esmmanuals](http://dell.com/esmmanuals).

## Removing the iDRAC port card

### Prerequisites



**CAUTION:** Many repairs may only be done by a certified service technician. You should only perform troubleshooting and simple repairs as authorized in your product documentation, or as directed by the online or telephone service and support team. Damage due to servicing that is not authorized by Dell is not covered by your warranty. Read and follow the safety instructions that came with the product.

1. Ensure that you read the [Safety instructions](#).
2. Follow the procedure listed in [Before working inside your system](#).
3. Disconnect any cables connected to the iDRAC port card.
4. If installed, remove the expansion-card riser.

### Steps

1. Loosen the two screws securing the iDRAC port card holder to the system board.
2. Pull the iDRAC port card to disengage it from the connector and remove the card from the chassis.

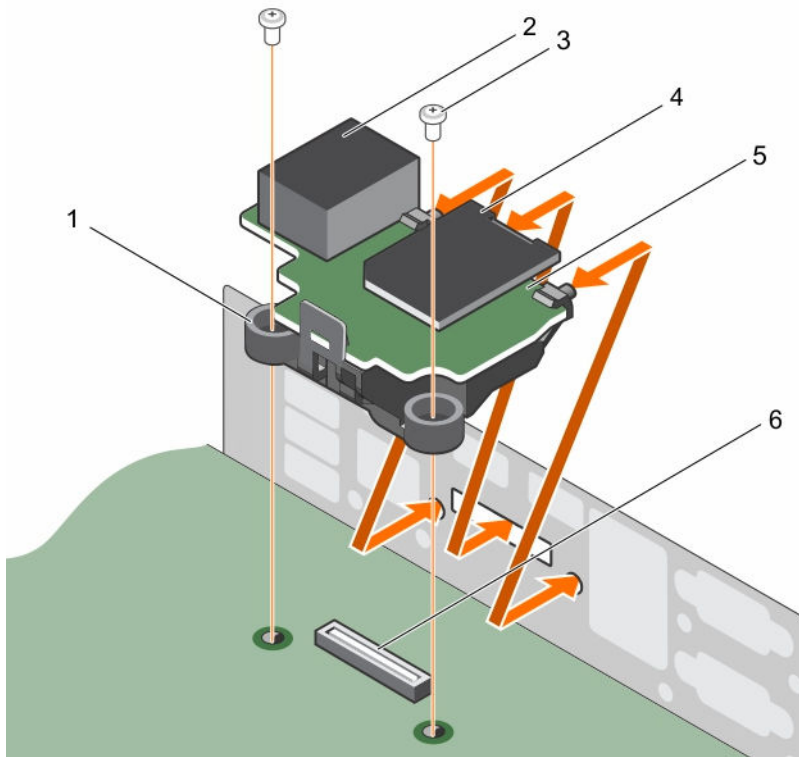

**Figure 33. Removing and Installing the iDRAC port card**

- |                           |                              |
|---------------------------|------------------------------|
| 1. iDRAC port card holder | 2. iDRAC port                |
| 3. screw (2)              | 4. SD vFlash media card      |
| 5. iDRAC port card        | 6. iDRAC port card connector |

#### **Next steps**

1. Install the expansion card, if applicable.
2. Install the expansion-card riser.
3. Follow the procedure listed in [After working inside your system](#).

#### **Related Links**

- [Removing the expansion-card riser](#)
- [Removing an expansion card](#)
- [Installing an expansion card](#)
- [Installing the expansion-card riser](#)



## Installing the iDRAC port card

### Prerequisites

 **CAUTION:** Many repairs may only be done by a certified service technician. You should only perform troubleshooting and simple repairs as authorized in your product documentation, or as directed by the online or telephone service and support team. Damage due to servicing that is not authorized by Dell is not covered by your warranty. Read and follow the safety instructions that came with the product.

1. Ensure that you read the [Safety instructions](#).
2. Follow the procedure listed in [Before working inside your system](#).
3. If installed, remove the expansion card and the expansion card riser.

### Steps

1. Align and insert the tabs on the iDRAC port card on the slots on the chassis wall.
2. Insert the iDRAC port card into the connector on the system board.
3. Tighten the two screws that secure the iDRAC port card holder to the system board.
4. Reconnect the cable to the iDRAC port card.

### Next steps

1. Install the expansion card, if applicable.
2. Install the expansion-card riser.
3. Follow the procedure listed in [After working inside your system](#).

### Related Links

[Removing the expansion-card riser](#)

[Removing an expansion card](#)

[Installing an expansion card](#)

[Installing the expansion-card riser](#)

## SD vFlash media card

A vFlash SD card is a Secure Digital (SD) card that plugs into the vFlash SD card slot in the system. It provides persistent on-demand local storage and a custom deployment environment that allows automation of server configuration, scripts, and imaging. It emulates USB device(s). For more information, see the Integrated Dell Remote Access Controller User's Guide at [dell.com/esmmanuals](http://dell.com/esmmanuals).

### Replacing an SD vFlash media card

1. Locate the SD vFlash media slot at the back of the chassis.
2. To remove the SD vFlash media card, push the card inward to release it, and pull the card from the card slot.

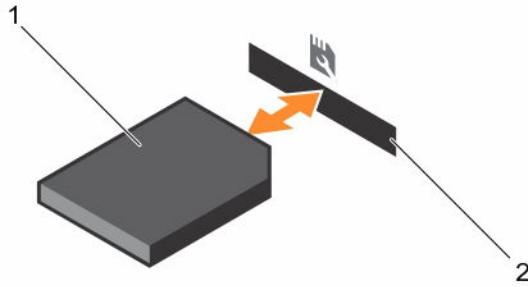

**Figure 34. Removing and installing the SD vFlash media card**

1. SD vFlash media card
2. SD vFlash media-card slot
3. To install an SD vFlash media card, insert the contact-pin end of the SD vFlash media card into the card slot on the module.  
**NOTE:** The slot is keyed to ensure correct insertion of the card.
4. Press the card inward to lock it into the slot.

## Internal dual SD module (optional)

The Internal Dual SD Module (IDSDM) card provides two SD card slots. This card offers the following features:

- Dual card operation — maintains a mirrored configuration by using SD cards in both the slots and provides redundancy.  
**NOTE:** When the **Redundancy** option is set to **Mirror Mode** in the **Integrated Devices** screen of System Setup, the information is replicated from one SD card to another.
- Single card operation — single card operation is supported, but without redundancy.

## Removing an internal SD card

### Prerequisites

1. Ensure that you read the [Safety instructions](#).
2. Follow the procedure listed in [Before working inside your system](#).

**CAUTION:** Many repairs may only be done by a certified service technician. You should only perform troubleshooting and simple repairs as authorized in your product documentation, or as directed by the online or telephone service and support team. Damage due to servicing that is not authorized by Dell is not covered by your warranty. Read and follow the safety instructions that came with the product.

## Steps

Locate the SD card slot on the internal dual SD module and press the card to release it from the slot.

## Next steps

Follow the procedure listed in [After working inside your system](#).

## Installing an internal SD card

### Prerequisites

1. Ensure that you read the [Safety instructions](#).
2. Follow the procedure listed in [Before working inside your system](#).

 **CAUTION:** Many repairs may only be done by a certified service technician. You should only perform troubleshooting and simple repairs as authorized in your product documentation, or as directed by the online or telephone service and support team. Damage due to servicing that is not authorized by Dell is not covered by your warranty. Read and follow the safety instructions that came with the product.

 **NOTE:** To use an SD card with your system, ensure that the **Internal SD Card Port** is enabled in the System Setup.

### Steps

1. Locate the SD card connector on the internal dual SD module. Orient the SD card appropriately and insert the contact-pin end of the card into the slot.

 **NOTE:** The slot is keyed to ensure correct insertion of the card.

2. Press the card into the card slot to lock it into place.

### Next steps

Follow the procedure listed in [After working inside your system](#).

## Removing the optional internal dual SD module

### Prerequisites

 **CAUTION:** Many repairs may only be done by a certified service technician. You should only perform troubleshooting and simple repairs as authorized in your product documentation, or as directed by the online or telephone service and support team. Damage due to servicing that is not authorized by Dell is not covered by your warranty. Read and follow the safety instructions that came with the product.

1. Ensure that you follow the [Safety instructions](#).
2. Follow the procedure listed in [Before working inside your system](#).
3. Locate the Internal Dual SD Module (IDSDM) on the system board.
4. If installed, remove the SD card(s).

### Steps

Hold the pull tab and pull the IDSDM out of the chassis.

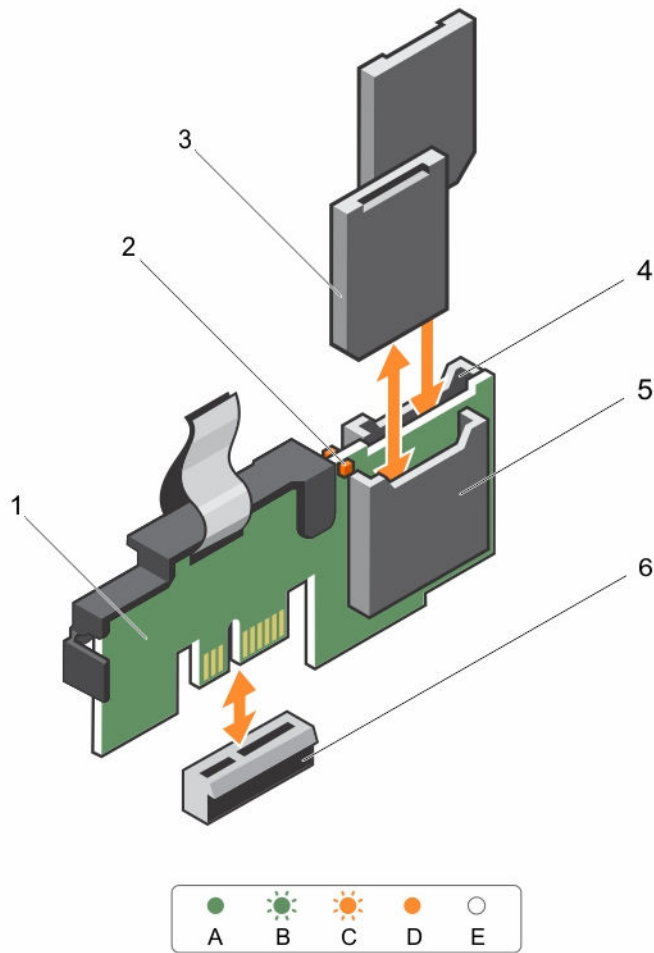

**Figure 35. Removing and installing the Internal Dual SD Module (IDSDM)**

- |                            |                             |
|----------------------------|-----------------------------|
| 1. Internal Dual SD module | 2. LED status indicator (2) |
| 3. SD card (2)             | 4. SD card slot 2           |
| 5. SD card slot 1          | 6. IDSDM connector          |

The following table describes the IDSDM indicator codes:

**Table 20. IDSDM indicator codes**

| Convention | IDSDM indicator code | Description  |
|------------|----------------------|--|
| A          | Green                | Indicates that the card is online.                   |
| B          | Flashing green       | Indicates rebuild or activity.                       |
| C          | Flashing amber       | Indicates card mismatch or that the card has failed. |

| Convention | IDSDM indicator code | Description  |
|------------|----------------------|--|
| D          | Amber                | Indicates that the card is offline, has failed, or is write protected. |
| E          | Not lit              | Indicates that the card is missing or is booting.                      |

#### Next steps

1. Installing the dual SD module.
2. Follow the procedure listed in [After working inside your system](#).

## Installing the optional internal dual SD module

#### Prerequisites



**CAUTION:** Many repairs may only be done by a certified service technician. You should only perform troubleshooting and simple repairs as authorized in your product documentation, or as directed by the online or telephone service and support team. Damage due to servicing that is not authorized by Dell is not covered by your warranty. Read and follow the safety instructions that came with the product.

1. Ensure that you follow the [Safety instructions](#).
2. Follow the procedure listed in [Before working inside your system](#).

#### Steps

1. Locate the Internal Dual SD Module (IDSDM) connector on the system board. To locate the internal dual SD module connector, see .
2. Align the IDSDM with the connector on the system board.
3. Push the IDSDM until it is firmly seated on the system board.

#### Next steps

1. Install the SD card(s).
  -  **NOTE:** Temporarily label each SD card with its corresponding slot before removal. Replace the SD card(s) into the same slots.
2. Follow the procedure listed in [After working inside your system](#).

## Integrated storage controller card

Your system includes a dedicated expansion-card slot on the system board for an integrated controller card. The integrated storage controller card provides the integrated storage subsystem for your system's internal hard drives. The controller supports SAS and SATA hard drives and also enables you to set up the hard drives in RAID configurations as supported by the version of the storage controller included with your system.

## Removing the integrated storage controller card

#### Prerequisites

1. Ensure that you read the [Safety instructions](#).
2. Follow the procedure listed in [Before working inside your system](#).
3. Remove the cooling shroud.

4. Keep the #2 Phillips screwdriver handy.

**⚠ CAUTION:** Many repairs may only be done by a certified service technician. You should only perform troubleshooting and simple repairs as authorized in your product documentation, or as directed by the online or telephone service and support team. Damage due to servicing that is not authorized by Dell is not covered by your warranty. Read and follow the safety instructions that came with the product.

#### Steps

1. Loosen the screws that secure the integrated storage controller cable to the integrated storage-controller card connector on the system board.
2. Lift the integrated storage controller cable out.
3. Lift one end of the card and angle it to disengage the card from the integrated storage-controller card holder on system board.
4. Lift the card out of the chassis.

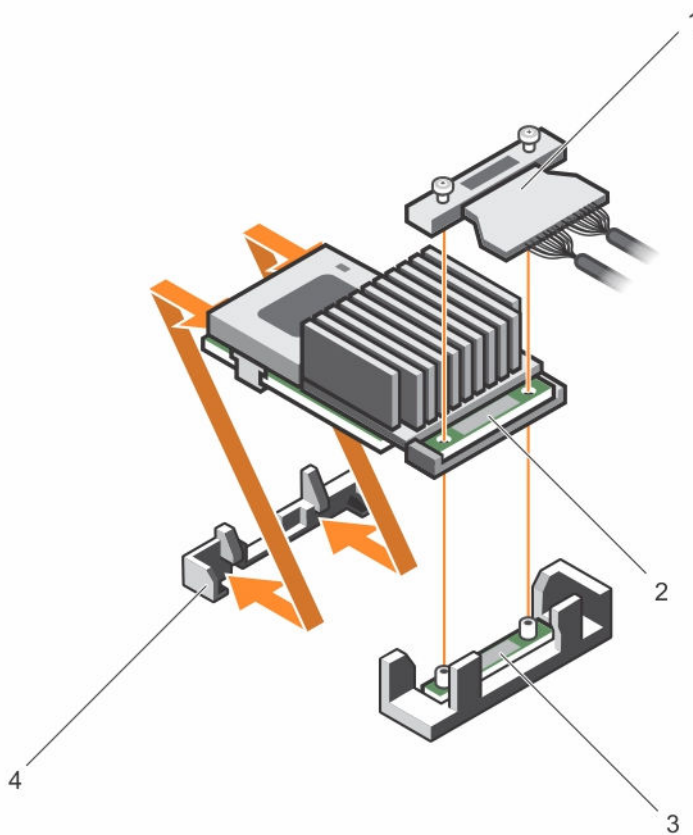

**Figure 36. Removing and installing the integrated storage controller card**

- |   |  |
|---|--|
| 1. integrated storage controller cable                              | 2. integrated storage controller card        |
| 3. integrated storage-controller card connector on the system board | 4. integrated storage controller card holder |

### Next steps

1. Replace the cooling shroud.
2. Follow the procedure listed in [After working inside your system](#).

### Related Links

- [Removing the cooling shroud](#)
- [Installing the cooling shroud](#)

## Installing the integrated storage controller card

### Prerequisites

 **CAUTION:** Many repairs may only be done by a certified service technician. You should only perform troubleshooting and simple repairs as authorized in your product documentation, or as directed by the online or telephone service and support team. Damage due to servicing that is not authorized by Dell is not covered by your warranty. Read and follow the safety instructions that came with the product.

1. Ensure that you read the [Safety instructions](#).
2. Follow the procedure listed in [Before working inside your system](#).
3. Remove the cooling shroud.
4. Keep the #2 Phillips screwdriver ready.

### Steps

1. Align the end of the integrated storage-controller card with the integrated storage-controller card holder.
2. Lower the connector side of the integrated storage-controller card into the integrated storage-controller card connector on the system board.  
Ensure that the tabs on the system board align with the screw holes on the integrated storage-controller card.
3. Align the screws on the integrated storage-controller card cable with the screw holes on the connector.
4. Tighten the screws to secure the integrated storage-controller card cable with the integrated storage-controller card connector on the system board.

### Next steps

1. Replace the cooling shroud.
2. Follow the procedure listed in [After working inside your system](#).

### Related Links

- [Removing the cooling shroud](#)
- [Installing the cooling shroud](#)

## Heat sinks and processors

Use the following procedure when:

- Installing an additional processor
- Replacing a processor



**NOTE:** To ensure proper system cooling, you must install a processor blank in any empty processor socket.

## Removing the heat sink

### Prerequisites

 **CAUTION:** Many repairs may only be done by a certified service technician. You should only perform troubleshooting and simple repairs as authorized in your product documentation, or as directed by the online or telephone service and support team. Damage due to servicing that is not authorized by Dell is not covered by your warranty. Read and follow the safety instructions that came with the product.

 **CAUTION:** Never remove the heat sink from a processor unless you intend to remove the processor. The heat sink is necessary to maintain proper thermal conditions.

1. Ensure that you follow the [Safety instructions](#).
2. Keep the Phillips #2 screwdriver ready.
3. Follow the procedure listed in [Before working inside your system](#).
4. Remove the cooling shroud.

 **WARNING:** The heat sink and processor are hot to the touch for some time after the system has been powered down. Allow the heat sink and processor to cool before handling them.

### Steps

1. Loosen one of the screws that secure the heat sink to the system board.  
Allow some time (around 30 seconds) for the heat sink to loosen from the processor.
2. Loosen the screw that is diagonally opposite the screw you first removed.
3. Repeat the procedure for the remaining two screws.
4. Lift the heat sink away from the system.

### Next steps

1. If you are removing only a faulty heat sink, install the replacement heat sink, if not, remove the processor.
2. Follow the procedure listed in [After working inside your system](#).

## Removing a processor

### Prerequisites

 **WARNING:** The heat sink and processor are hot to the touch for some time after the system has been powered down. Allow the heat sink and processor to cool before handling them.

 **CAUTION:** Many repairs may only be done by a certified service technician. You should only perform troubleshooting and simple repairs as authorized in your product documentation, or as directed by the online or telephone service and support team. Damage due to servicing that is not authorized by Dell is not covered by your warranty. Read and follow the safety instructions that came with the product.

 **CAUTION:** Never remove the heat sink from a processor unless you intend to remove the processor. The heat sink is necessary to maintain proper thermal conditions.

1. Ensure that you read the [Safety instructions](#).
2. Keep the #2 Phillips screwdriver handy.



3. Before upgrading your system, download the latest system BIOS version from [dell.com/support](https://www.dell.com/support) and follow the instructions included in the compressed download file to install the update on your system.

 **NOTE:** You can update the system BIOS using the Lifecycle Controller. For more information about Dell Lifecycle controller, see [dell.com/esmmanuals](https://www.dell.com/esmmanuals).

4. Follow the procedure listed in [Before working inside your system](#).
5. Remove the cooling shroud.

### Steps

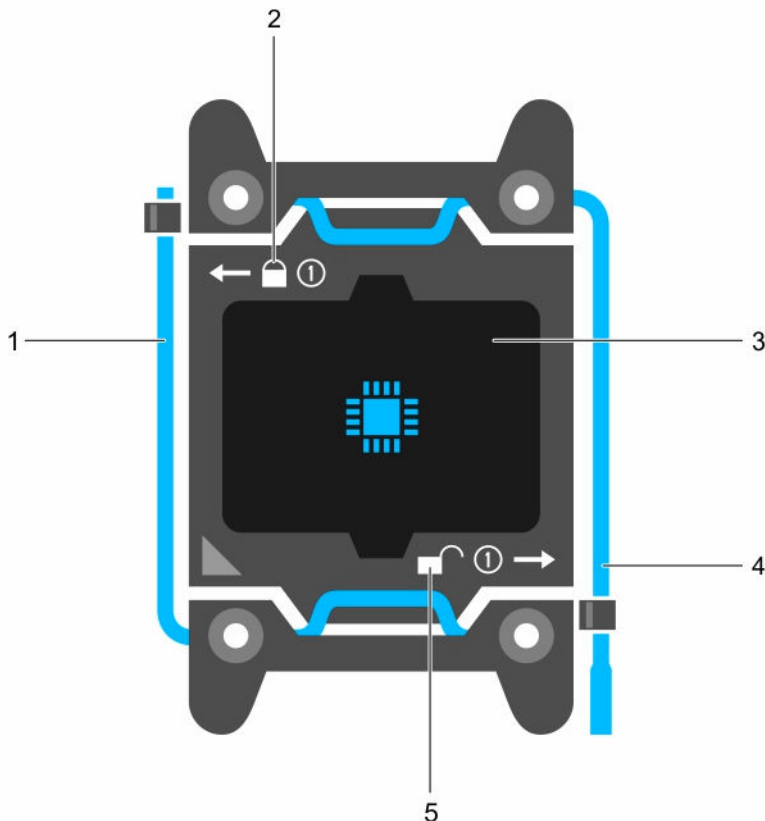

1. Loosen one of the screws that secures the heat sink to the system board.  
Wait 30 seconds for the heat sink to loosen from the processor.
2. Remove the screw diagonally opposite the screw you first removed.
3. Repeat the procedure for the remaining two screws.
4. Remove the heat sink.

 **CAUTION:** The processor is held in its socket under strong pressure. Be aware that the release lever can spring up suddenly if not firmly grasped.



**Figure 37. Processor shield opening and closing lever sequence**

1. *close first socket release lever*
2. *lock icon*

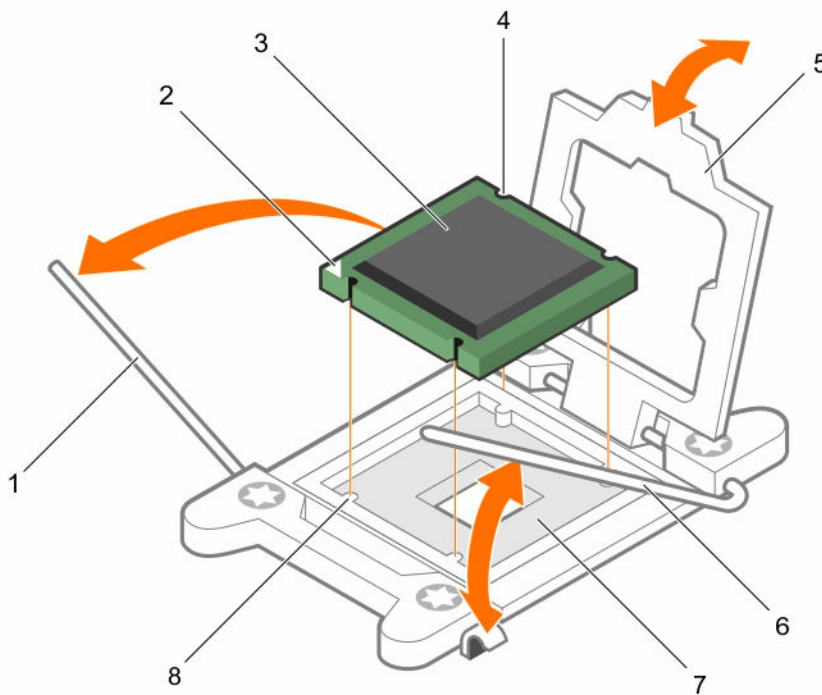

3. processor
4. *open first* socket release lever
5. unlock icon
5. Position your thumb firmly over the processor *open first* socket-release lever near the unlock icon  and release the lever from the locked position by pushing down and out from under the tab.
6. Similarly, position your thumb firmly over the processor *close first* socket-release lever near the lock icon  and release the lever from the locked position by pushing down and out from under the tab. Rotate the lever 90 degrees upward.
7. Lower the *open first* socket-release lever to lift the processor shield.



**Figure 38. Removing and installing a processor**

1. *close first* socket-release lever
2. pin-1 indicator of processor
3. processor
4. slot (4)
5. processor shield
6. *open first* socket-release lever
7. socket
8. socket keys (4)
8. Hold the tab on the processor shield and rotate the processor shield upward until the *open first* socket-release lever lifts up.
9. Lift the processor out of the socket and leave the *open first* socket-release lever up so that the socket is ready for the new processor.

 **CAUTION: The socket pins are fragile and can be permanently damaged. Be careful not to bend the pins in the socket when removing the processor out of the socket.**

-  **NOTE:** If you are permanently removing the processor, you must install a socket protective cap in the vacant socket to protect the socket pins and keep the socket free of dust.
-  **NOTE:** After removing the processor, place it in an antistatic container for reuse, return, or temporary storage. Do not touch the bottom of the processor. Touch only the side edges of the processor.

#### Related Links

[Removing the cooling shroud](#)

[Installing the cooling shroud](#)

## Installing a processor

### Prerequisites

1. Ensure that you read the [Safety instructions](#).
2. Keep the #2 Phillips screwdriver handy.
3. Before upgrading your system, download the latest system BIOS version from [dell.com/support](http://dell.com/support) and follow the instructions included in the compressed download file to install the update on your system.

 **NOTE:** You can update the system BIOS using the Lifecycle Controller.

4. Follow the procedure listed in [Before working inside your system](#).
5. Remove the cooling shroud.



 **WARNING:** The heat sink and processor are hot to the touch for some time after the system has been powered down. Allow the heat sink and processor to cool before handling them.

 **CAUTION:** Never remove the heat sink from a processor unless you intend to remove the processor. The heat sink is necessary to maintain proper thermal conditions.

 **CAUTION:** Many repairs may only be done by a certified service technician. You should only perform troubleshooting and simple repairs as authorized in your product documentation, or as directed by the online or telephone service and support team. Damage due to servicing that is not authorized by Dell is not covered by your warranty. Read and follow the safety instructions that came with the product.

 **NOTE:** If you are installing a single processor, it must be installed in socket CPU1.

### Steps

1. Remove the heat sink.
2. Unpack the new processor  
If the processor has previously been used in a system, remove any remaining thermal grease from the processor using a lint-free cloth.
3. Locate the processor socket.
4. If applicable, remove the socket protective cap.
5. Position your thumb firmly over the *open first* socket-release lever near the unlock icon  and release the lever from the locked position by pushing down and in from under the tab.
6. Similarly, release the *close first* socket-release lever near the lock icon  from the locked position. Rotate the lever 90 degrees upward.
7. Hold the tab near the lock symbol on the processor shield and rotate it upward and out of the way.
8. To install the processor in the socket:

 **CAUTION: Positioning the processor incorrectly can permanently damage the system board or the processor. Be careful not to bend the pins in the socket.**

 **CAUTION: While removing or reinstalling the processor, wipe your hands of any contaminants. Contaminants on the processor pins such as thermal grease or oil can damage the processor.**

a. Align the processor with the socket keys on the socket.

 **CAUTION: Do not use force to seat the processor. When the processor is positioned correctly, it engages easily into the socket.**

b. Align the pin-1 indicator of the processor with the triangle on the socket.

c. Place the processor on the socket such that the slots on the processor aligns with the socket keys on the socket.

 **CAUTION: Do not use force to seat the processor. When the processor is positioned correctly, it engages easily into the socket.**

d. Close the processor shield.

e. Rotate the *close first* socket-release lever near the lock icon  until it is locked in position.

f. Similarly, rotate the *open first* socket-release lever near the unlock icon  to the unlocked position.

9. To install the heat sink:

a. If applicable, remove the existing thermal grease from the heat sink using a clean lint-free cloth.

b. Apply thermal grease on the top of the processor. Use the thermal-grease syringe included with your processor kit to apply the grease in a thin spiral on the top of the processor as shown in the figure.

 **CAUTION: Applying too much thermal grease can result in excess grease coming in contact with and contaminating the processor socket.**

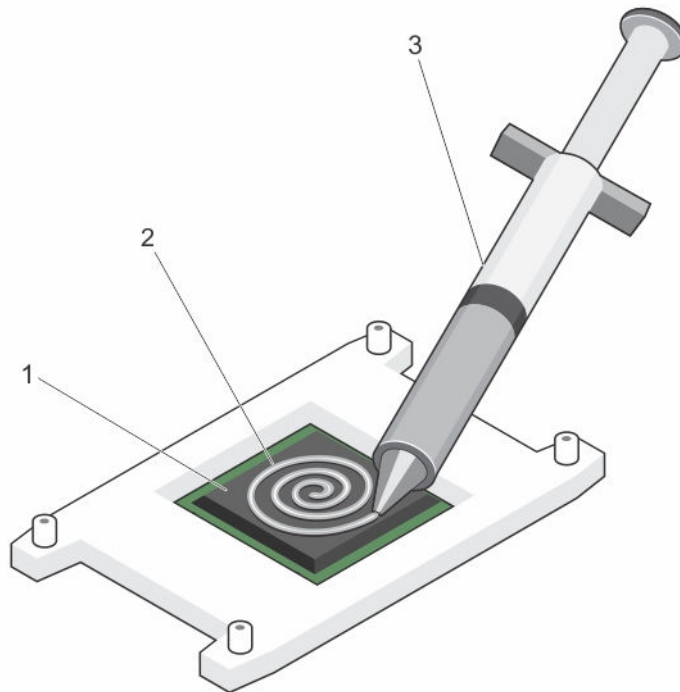

**Figure 39. Applying thermal grease on the top of the processor**

1. processor
2. thermal grease
3. thermal-grease syringe

**NOTE:** The thermal-grease is intended for one-time use only. Dispose of the syringe after you use it.

- c. Place the heat sink onto the processor.
- d. Tighten the four screws to secure the heat sink to the system board.

**NOTE:** Tighten the screws diagonally opposite to each other. Do not over-tighten the heat sink retention screws when installing the heat sink. To prevent over-tightening, tighten the retention screw until resistance is felt, and stop once the screw is seated. The screw tension should be no more than 6 in-lb (6.9 kg-cm).

#### Next steps

1. Install the cooling shroud.
2. Follow the procedure listed in [After working inside your system](#).
3. While booting, press <F2> to enter the System Setup and check that the processor information matches the new system configuration.
4. Run the system diagnostics to verify that the new processor operates correctly.

#### Related Links

- [Removing the cooling shroud](#)
- [Installing the cooling shroud](#)

## Installing the heat sink

### Prerequisites

 **CAUTION:** Many repairs may only be done by a certified service technician. You should only perform troubleshooting and simple repairs as authorized in your product documentation, or as directed by the online or telephone service and support team. Damage due to servicing that is not authorized by Dell is not covered by your warranty. Read and follow the safety instructions that came with the product.

1. Ensure that you follow the [Safety instructions](#).
2. Keep the Phillips #2 screwdriver ready.
3. Follow the procedure listed in [Before working inside your system](#).
4. Remove the cooling shroud.
5. Install the processor.

### Steps

1. If you are using an existing heat sink, remove the thermal grease from the heat sink by using a clean lint free cloth.
2. Use the thermal grease syringe included with your processor kit to apply the grease in a thin spiral on the top of the processor as shown in the following figure.

 **CAUTION:** Applying too much thermal grease can result in excess grease coming in contact with and contaminating the processor socket.

 **NOTE:** The thermal grease syringe is intended for one-time use only. Dispose of the syringe after you use it.

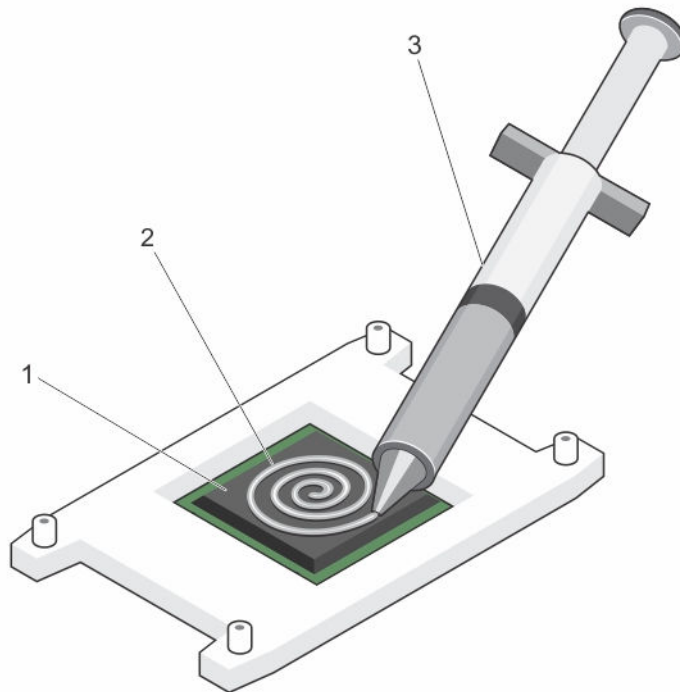

**Figure 40. Applying thermal grease on the top of the processor**

1. processor
  2. thermal grease
  3. thermal grease syringe
3. Place the heat sink onto the processor.
  4. Tighten one of the four screws to secure the heat sink to the system board.
  5. Tighten the screw diagonally opposite to the first screw you tightened.  
**NOTE:** Do not overtighten the heat sink retention screws when installing the heat sink. To prevent overtightening, tighten the retention screw until resistance is felt. The screw tension must not be more than 6 in-lb (6.9 kg-cm).
  6. Repeat the procedure for the remaining two screws.

#### Next steps

1. Install the cooling shroud.
2. Follow the procedure listed in [After working inside your system](#).
3. While booting, press F2 to enter System Setup and check that the processor information matches the new system configuration.
4. Run the system diagnostics to verify that the new processor operates correctly.

## Power supplies

Your system supports the following power supplies:

- 450 W AC (non-redundant)

- 550 W AC (redundant)

When two identical power supplies are installed, the power supply configuration is redundant (1 + 1). In redundant mode, power is supplied to the system equally from both power supplies to maximize efficiency.

When only one power supply is installed, the power supply configuration is non-redundant (1 + 0). Power is supplied to the system only by the single power supply.

 **NOTE:** If two power supplies are used, they must be of the same type and have the same maximum output power.

 **NOTE:** For AC power supplies, use only PSUs with the Extended Power Performance (EPP) label on the back. Mixing PSUs from previous generations of Dell PowerEdge servers can result in a PSU mismatch condition or failure to power on.

## Hot spare feature

Your system supports the hot spare feature that significantly reduces the power overhead associated with power supply redundancy.

When the hot spare feature is enabled, one of the redundant PSUs is switched to the sleep state. The active PSU supports 100 percent of the load, thus operating at higher efficiency. The PSU in the sleep state monitors output voltage of the active PSU. If the output voltage of the active PSU drops, the PSU in the sleep state returns to an active output state.

If having both PSUs active is more efficient than having one PSU in the sleep state, the active PSU can also activate the sleeping PSU.

The default PSU settings are as follows:

- If the load on the active PSU is more than 50 percent, then the redundant PSU is switched to the active state.
- If the load on the active PSU falls below 20 percent, then the redundant PSU is switched to the sleep state.

You can configure the hot spare feature by using the iDRAC settings. For more information about iDRAC settings, see the *Integrated Dell Remote Access Controller User's Guide* available at [Dell.com/idracmanuals](http://Dell.com/idracmanuals).

## Removing a redundant power supply

### Prerequisites

 **CAUTION:** Many repairs may only be done by a certified service technician. You should only perform troubleshooting and simple repairs as authorized in your product documentation, or as directed by the online or telephone service and support team. Damage due to servicing that is not authorized by Dell is not covered by your warranty. Read and follow the safety instructions that came with the product.

 **CAUTION:** The system requires one power supply for normal operation. On power-redundant systems, remove and replace only one power supply at a time in a system that is powered on.

1. Ensure that you read the [Safety instructions](#).
2. Disconnect the power cable from the power source.



3. Disconnect the power cable from the power supply and remove the straps that bundle and secure the system cables.

 **NOTE:** You may have to unlatch and lift the optional cable management arm if it interferes with power-supply removal. For information about the cable management arm, see the system's rack documentation.

### Steps

Press the release latch and pull the power supply straight out to release it from the power interposer board and clear the chassis.

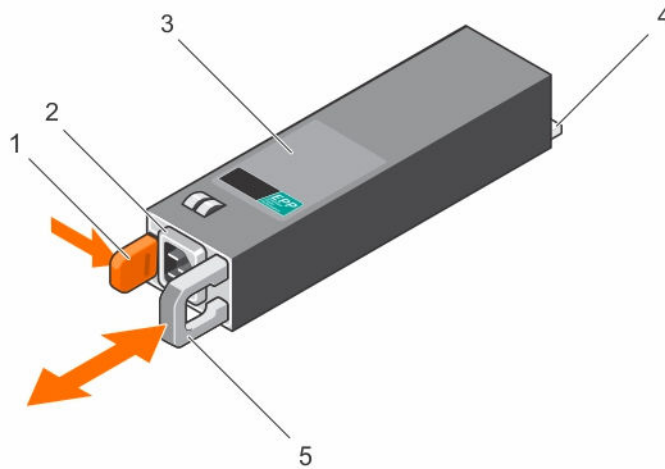

**Figure 41. Removing and installing a redundant power supply**

- |                                |                           |
|--------------------------------|---------------------------|
| 1. release latch               | 2. power supply connector |
| 3. redundant power supply unit | 4. connector              |
| 5. power supply handle         |                           |

## Installing a redundant power supply

### Prerequisites

 **CAUTION:** Many repairs may only be done by a certified service technician. You should only perform troubleshooting and simple repairs as authorized in your product documentation, or as directed by the online or telephone service and support team. Damage due to servicing that is not authorized by Dell is not covered by your warranty. Read and follow the safety instructions that came with the product.



Ensure that you read the [Safety instructions](#).

### Steps

1. Verify that both power supplies are the same type and have the same maximum output power.

 **NOTE:** The maximum output power (shown in Watts) is listed on the power supply label.

2. If applicable, remove the power supply blank.

3. Slide the new power supply into the chassis until the power supply is fully seated and the release latch snaps into place.
  -  **NOTE:** If you unlatched the cable management arm in step 3 of the previous procedure, relatch it. For information about the cable management arm, see the system's rack documentation.
4. Connect the power cable to the power supply and plug the cable into a power outlet.
  -  **CAUTION: When connecting the power cable, secure the cable with the strap.**
  -  **NOTE:** When installing, hot-swapping, or hot-adding a new power supply in a system with two power supplies, allow several seconds for the system to recognize the power supply and determine its status. The power-supply status indicator turns green to signify that the power supply is functioning properly.

## Removing a non-redundant power supply

### Prerequisites

 **CAUTION: Many repairs may only be done by a certified service technician. You should only perform troubleshooting and simple repairs as authorized in your product documentation, or as directed by the online or telephone service and support team. Damage due to servicing that is not authorized by Dell is not covered by your warranty. Read and follow the safety instructions that came with the product.**

1. Ensure that you read the [Safety instructions](#).
2. Disconnect the power cable from the power source.
3. Disconnect the power cable from the power supply and remove the straps that bundle and secure the system cables.
4. Follow the procedure listed in [Before working inside your system](#).

 **NOTE:** You may have to unlatch and lift the optional cable management arm if it interferes with the power-supply removal. For information about the cable management arm, see the system's rack documentation.

### Steps

1. Disconnect all the power cables from the power supply to the system board, hard drives, and optical drive.
2. Remove the screw securing the power supply to the chassis, slide and lift the power supply out of the chassis.

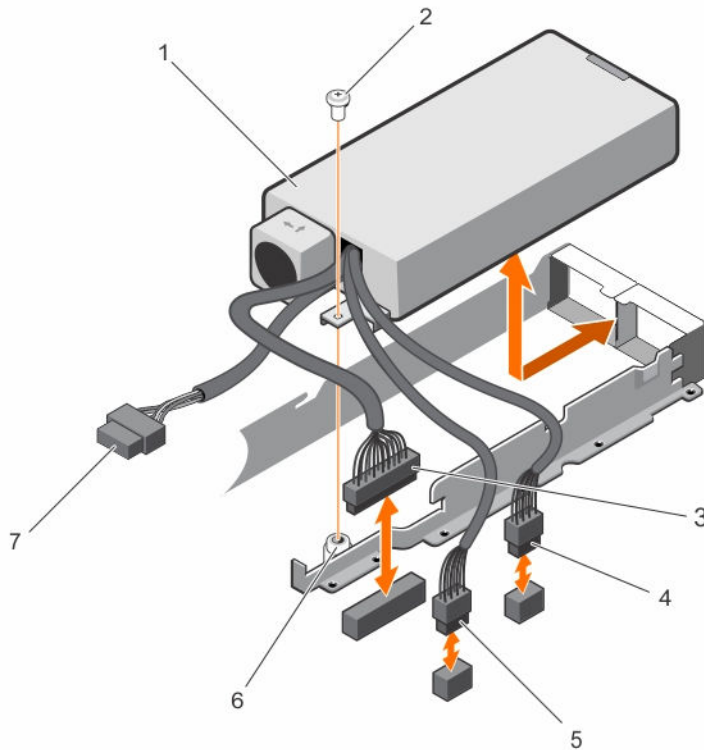

**Figure 42. Removing and installing a non-redundant power supply**

- |                        |                       |
|------------------------|-----------------------|
| 1. power supply        | 2. screw              |
| 3. P1 cable connector  | 4. P2 cable connector |
| 5. P3 cable connector  | 6. standoff           |
| 7. Backplane connector |                       |

## Installing a non-redundant power supply

### Prerequisites

**CAUTION:** Many repairs may only be done by a certified service technician. You should only perform troubleshooting and simple repairs as authorized in your product documentation, or as directed by the online or telephone service and support team. Damage due to servicing that is not authorized by Dell is not covered by your warranty. Read and follow the safety instructions that came with the product.

1. Ensure that you read the [Safety instructions](#).
2. Follow the procedure listed in [Before working inside your system](#).

**NOTE:** A hot-swappable non-redundant power supply must be installed in Slot 1 of the power supply bay.

### Steps

1. Align the screw hole on the power supply with the standoff on the chassis.
2. Tighten the screw to secure the power supply to the chassis.
3. Connect all the power cables to the system board, hard drives, and optical drive.

### Next steps

1. Follow the procedure listed in [After working inside your system](#).
2. Connect the power cable to the power supply and plug the cable into a power outlet.

## Removing the power supply unit blank

If you are installing a second power supply unit, remove the power supply unit blank in the bay by pulling the blank outward.

**⚠ CAUTION:** To ensure proper system cooling, the power supply blank must be installed in the second power supply bay in a non-redundant configuration. Remove the power supply blank only if you are installing a second power supply.

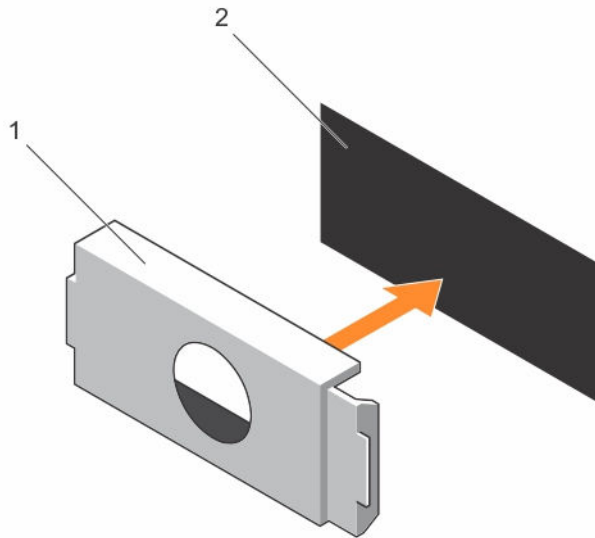

Figure 43. Removing and installing the power supply blank

1. power supply blank
2. power supply bay

## Installing the power supply unit blank

Install the power supply unit blank only in the second power supply unit bay.

To install the power supply unit blank, align the blank with the power supply unit bay and push it into the chassis until it clicks into place.

## System battery

### Replacing the system battery

#### Prerequisites

**⚠ WARNING:** There is a danger of a new battery exploding if it is incorrectly installed. Replace the battery only with the same or equivalent type recommended by the manufacturer. See your safety information for additional information.

**△ CAUTION:** Many repairs may only be done by a certified service technician. You should only perform troubleshooting and simple repairs as authorized in your product documentation, or as directed by the online or telephone service and support team. Damage due to servicing that is not authorized by Dell is not covered by your warranty. Read and follow the safety instructions that came with the product.

1. Ensure that you read the [Safety instructions](#).
2. Follow the procedure listed in [Before working inside your system](#).
3. Remove the expansion-card riser.

#### Steps

1. Locate the battery socket, see [System board connectors](#).

**△ CAUTION:** To avoid damage to the battery connector, you must firmly support the connector while installing or removing a battery.

2. To eject the battery, press firmly on the edge of the positive side of the battery in the direction of the arrow as shown in the illustration below.

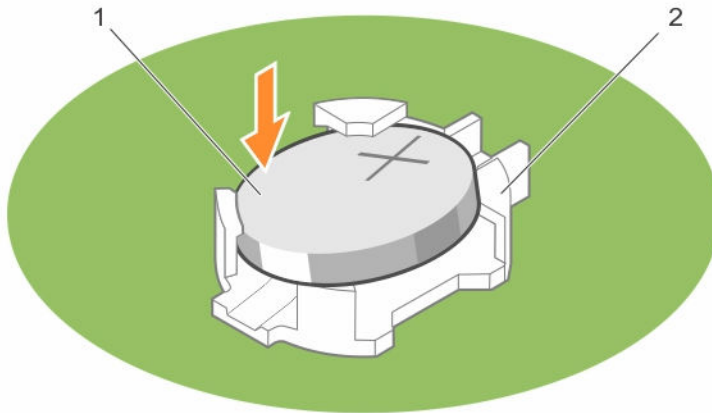

**Figure 44. System battery**

- |                             |           |
|-----------------------------|-----------|
| 1. positive side of battery | 2. socket |
|-----------------------------|-----------|

3. To install a new system battery, hold the battery with the positive facing up and slide it under the securing tabs.
4. Press the battery into the connector until it snaps into place.

#### Next steps

1. Install the expansion-card riser.
2. Follow the procedure listed in [After working inside your system](#).
3. While booting, press F2 to enter the System Setup and ensure the battery is operating properly.
4. Enter the correct time and date in the System Setup **Time** and **Date** fields.
5. Exit the System Setup.

#### Related Links

[Removing the expansion-card riser](#)

- [Removing an expansion card](#)
- [Installing an expansion card](#)
- [Installing the expansion-card riser](#)

## Hard-drive backplane

Depending on your system configuration:

**PowerEdge R430** Four 3.5 inch or 2.5 inch SAS/SATA backplane or supports

Eight 2.5 inch SAS/SATA backplane or

Ten 2.5 inch SAS/SATA backplane

## Removing the hard-drive backplane

### Prerequisites

 **CAUTION:** Many repairs may only be done by a certified service technician. You should only perform troubleshooting and simple repairs as authorized in your product documentation, or as directed by the online or telephone service and support team. Damage due to servicing that is not authorized by Dell is not covered by your warranty. Read and follow the safety instructions that came with the product.

 **CAUTION:** To prevent damage to the drives and backplane, you must remove the hard drives from the system before removing the backplane.

 **CAUTION:** You must note the number of each hard drive and temporarily label them before removal so that you can replace them in the same locations.

1. Ensure that you read the [Safety instructions](#).
2. Follow the procedure listed in [Before working inside your system](#).
3. Remove all hard drives.

### Steps

1. Disconnect the SAS/SATA data, signal, and power cable(s) from the backplane.
2. Press the release tabs and lift the backplane upward and slide it toward the back of the chassis.

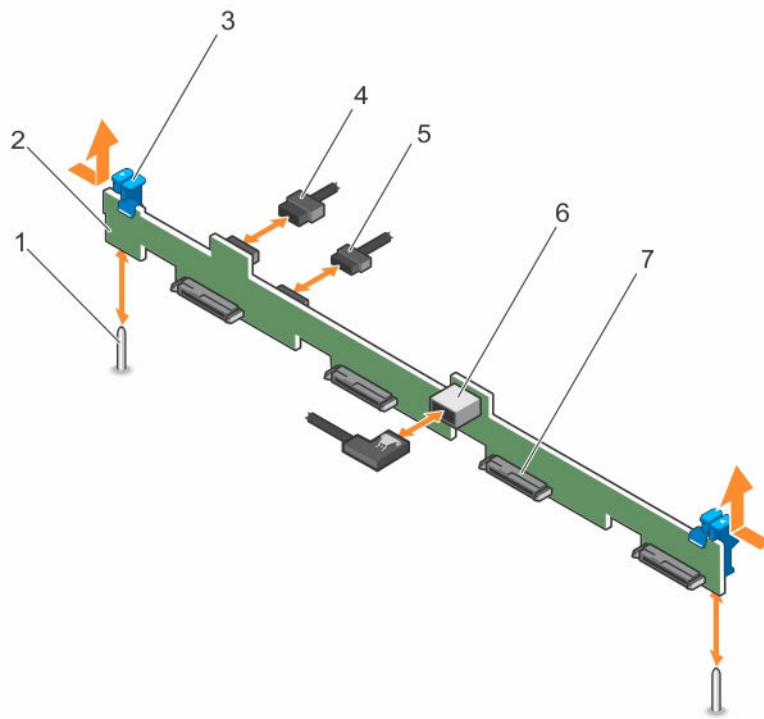

**Figure 45. Removing and Installing the 3.5 inch or 2.5 inch (x4) SAS/SATA backplane**

- |                                 |                                     |
|---------------------------------|-------------------------------------|
| 1. guide (2)                    | 2. hard-drive/SSD backplane         |
| 3. release tab (2)              | 4. backplane power cable            |
| 5. backplane signal cable       | 6. SAS_A connector on the backplane |
| 7. hard-drive/SSD connector (4) |                                     |

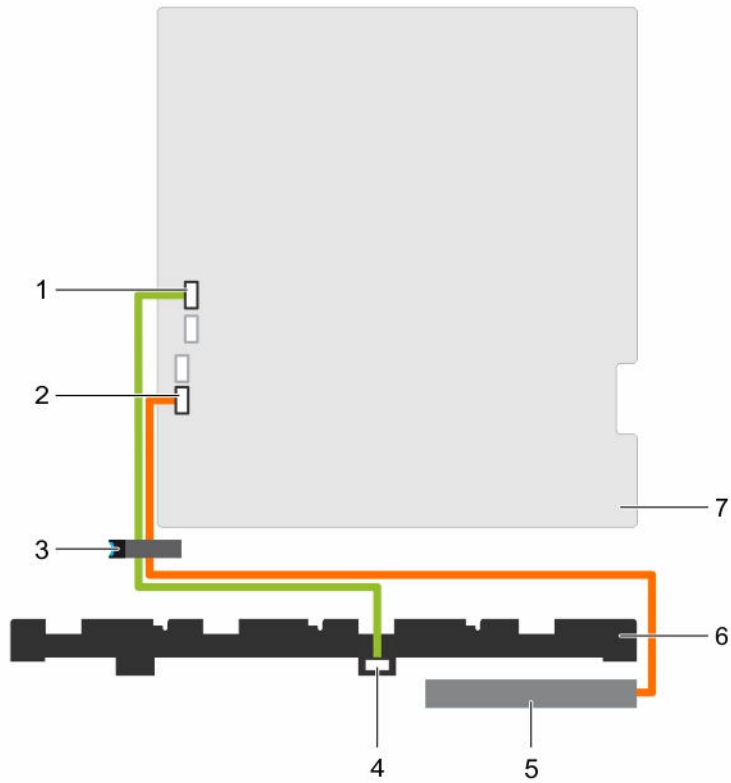

**Figure 46. Cabling diagram—3.5 inch or 2.5 inch (x4) SAS/SATA backplane**

- |  |   |
|--|---|
| 1. SW_RAID_A connector on the system board | 2. SATA_CDROM connector on the system board |
| 3. cable routing latch                     | 4. SAS_A connector on the backplane         |
| 5. Optical Disk Drive (ODD)                | 6. hard-drive backplane                     |
| 7. system board                            |   |



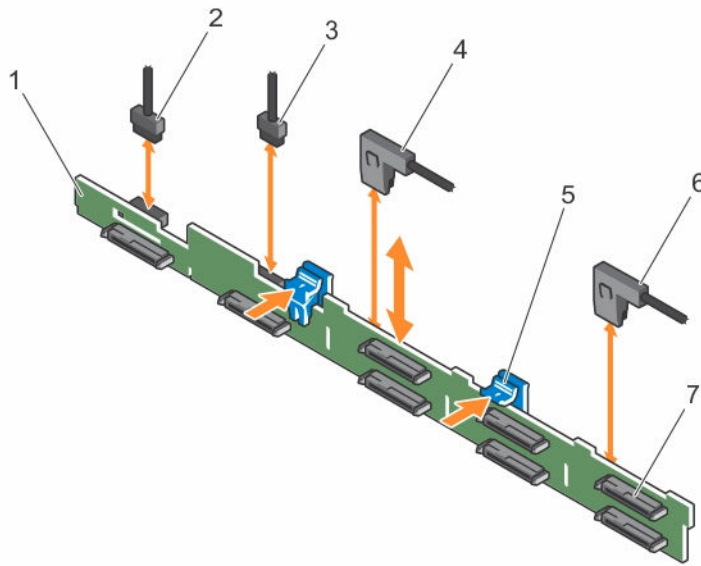

**Figure 47. Removing and installing the 2.5 inch (x8) SAS/SATA backplane**

- |                                 |                          |
|---------------------------------|--------------------------|
| 1. hard-drive/SSD backplane     | 2. backplane power cable |
| 3. backplane signal cable       | 4. SAS_A cable connector |
| 5. release tab (2)              | 6. SAS_B cable connector |
| 7. hard-drive/SSD connector (8) |                          |

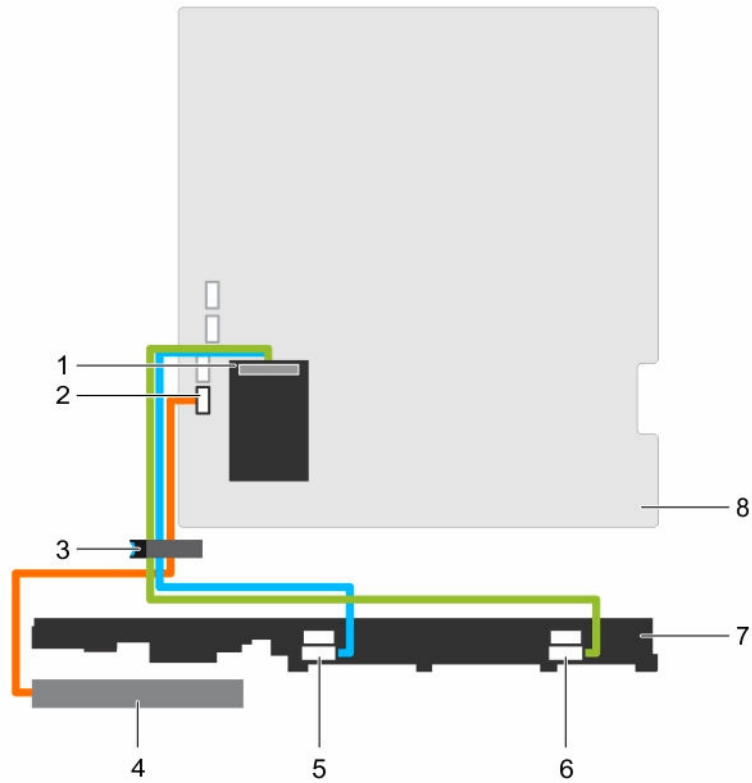

**Figure 48. Cabling diagram—2.5 inch (x8) SAS/SATA backplane**

- |                                       |   |
|---------------------------------------|---|
| 1. integrated storage controller card | 2. SATA_CDROM connector on the system board |
| 3. cable routing latch                | 4. Optical Disk Drive (ODD)                 |
| 5. SAS_A connector on the backplane   | 6. SAS_B connector on the backplane         |
| 7. hard-drive/SSD backplane           | 8. system board                             |

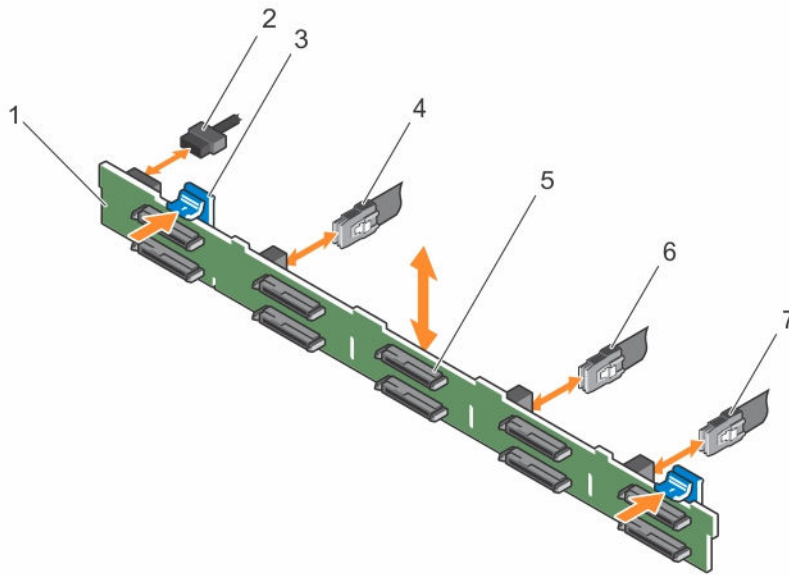

**Figure 49. Removing and installing the 2.5 inch (x10) SAS/SATA backplane**

1. hard drive/SSD backplane
2. backplane power cable
3. release tab (2)
4. SAS\_A connector on the backplane
5. hard drive/SSD connector (10)
6. SAS\_B connector on the backplane
7. SAS\_C connector on the backplane

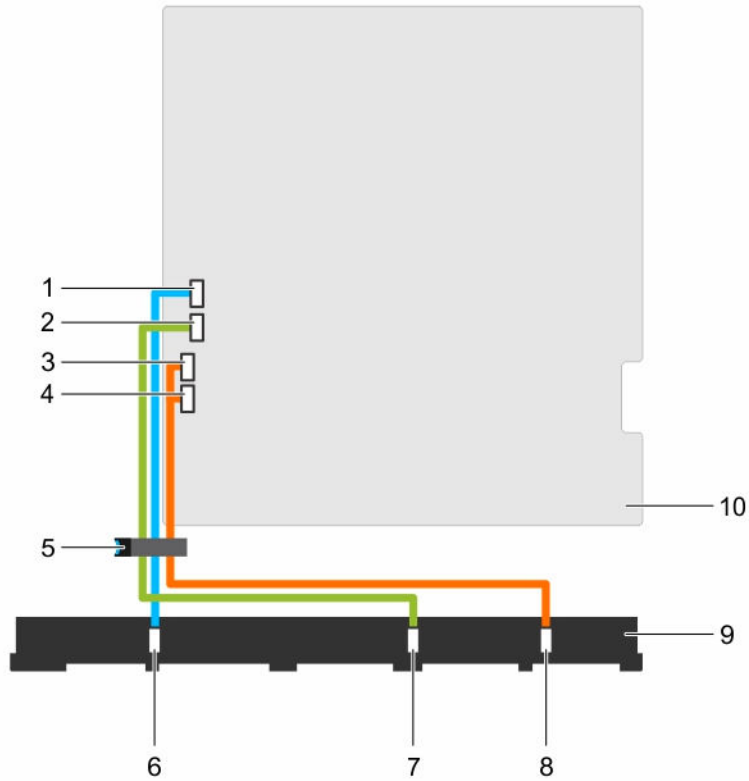

**Figure 50. Cabling diagram—2.5 inch (x10) SAS/SATA backplane**

- |  |  |
|--|--|
| 1. SW_RAID_A connector on the system board | 2. SW_RAID_B connector on the system board |
| 3. SATA_HDD8 connector on the system board | 4. SATA_HDD9 connector on the system board |
| 5. cable routing latch                     | 6. SAS_A connector on the backplane        |
| 7. SAS_B connector on the backplane        | 8. SAS_C connector on the backplane        |
| 9. hard drive/SSD backplane                | 10. system board                           |

**Related Links**

[Removing a hot-swap hard drive](#)

## Installing the hard-drive backplane

### Prerequisites

 **CAUTION:** Many repairs may only be done by a certified service technician. You should only perform troubleshooting and simple repairs as authorized in your product documentation, or as directed by the online or telephone service and support team. Damage due to servicing that is not authorized by Dell is not covered by your warranty. Read and follow the safety instructions that came with the product.

 **CAUTION:** To prevent damage to the control panel flex cable, do not to bend the control panel flex cable after it is inserted into the connector.

1. Ensure that you read the [Safety instructions](#).
2. Follow the procedure listed in [Before working inside your system](#).

### Steps

1. Use the hooks on the chassis as guides to align the hard-drive backplane.
2. Slide down the hard-drive backplane until the release tabs snap into place.
3. Connect the SAS/SATA/SSD data, signal, and power cable(s) to the backplane.

### Next steps

1. Install the hard drives in their original locations.
2. Follow the procedure listed in [After working inside your system](#).

### Related Links

[Installing a hot-swap hard drive](#)

## Control-panel assembly

### Removing the control panel

#### Prerequisites

 **CAUTION:** Many repairs may only be done by a certified service technician. You should only perform troubleshooting and simple repairs as authorized in your product documentation, or as directed by the online or telephone service and support team. Damage due to servicing that is not authorized by Dell is not covered by your warranty. Read and follow the safety instructions that came with the product.

1. Ensure that you read the [Safety instructions](#).
2. Follow the procedure listed in [Before working inside your system](#).
3. Keep the #2 Phillips screwdriver handy.

#### Steps

1. Using a #2 Phillips screwdriver, remove the screw(s) securing the control panel to the chassis.

 **CAUTION:** Do not use excessive force when removing the control panel as it can damage the connectors.

2. Release the locking tabs of the control panel by angling the control panel up and away from the system.

For an eight 2.5 inch hot-swappable hard-drive chassis, remove the screw (located at the bottom of the chassis) that secures the control panel to the chassis.

For a ten 2.5 inch hot-swappable hard-drive chassis, Press the control panel latch and slide the control panel out of the chassis.

3. Remove all the cables connecting the control panel to the chassis.

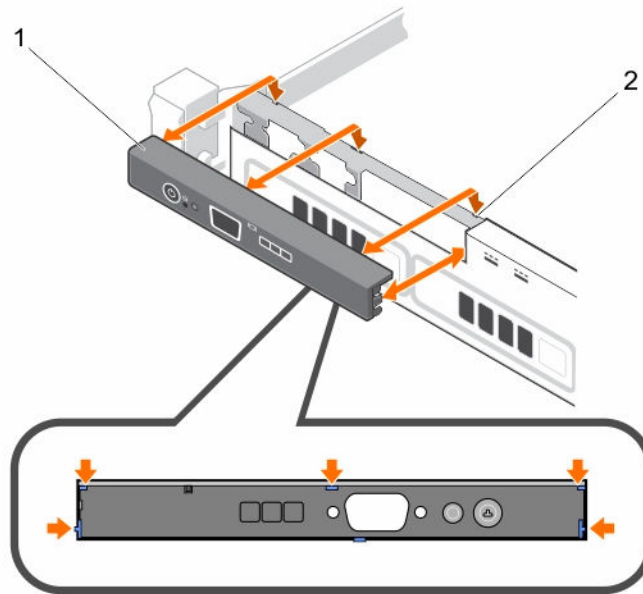

**Figure 51. Removing and installing the control panel—four 3.5 inch hard-drives chassis**

1. control panel
2. notches (6)

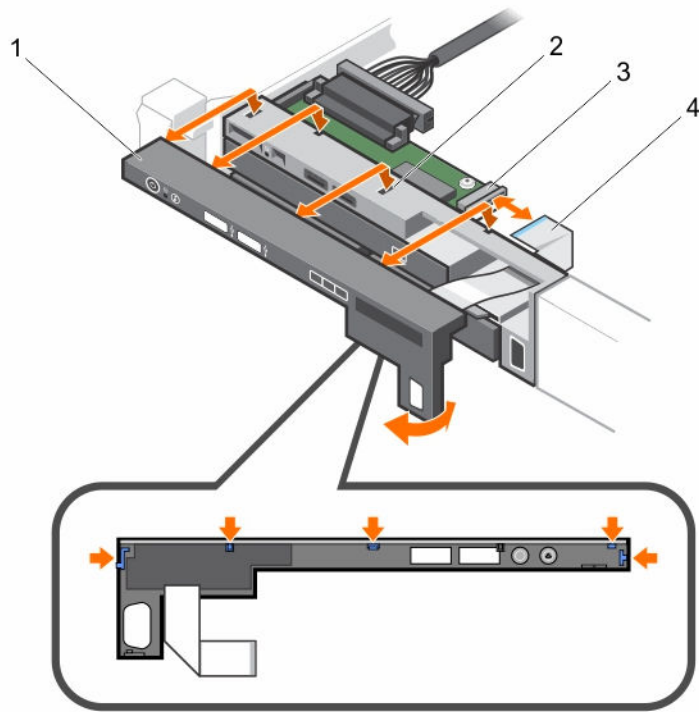

**Figure 52. Removing and installing the control panel—eight 2.5 inch hard-drives/SSDs chassis**

- |                         |                        |
|-------------------------|------------------------|
| 1. control panel        | 2. notches (4)         |
| 3. control panel module | 4. LCD connector cable |

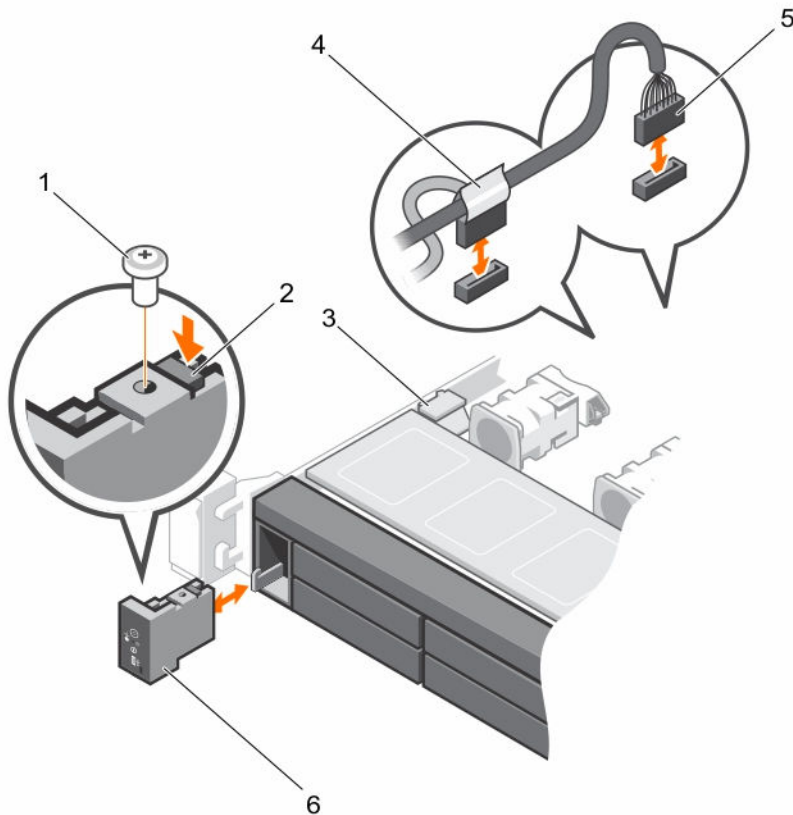

**Figure 53. Removing and installing the control panel—ten 2.5 inch hard-drives/SSDs chassis**

- |                             |   |
|-----------------------------|---|
| 1. screw                    | 2. control panel release latch                        |
| 3. cable securing clip      | 4. control panel cable connecting to the system board |
| 5. J_FP_USB connector cable | 6. control panel                                      |

#### Next steps

1. Replace the control panel.
2. Follow the procedure listed in [After working inside your system](#).

#### Related Links

[Installing the control panel](#)

## Installing the control panel

#### Prerequisites

**⚠ CAUTION:** Many repairs may only be done by a certified service technician. You should only perform troubleshooting and simple repairs as authorized in your product documentation, or as directed by the online or telephone service and support team. Damage due to servicing that is not authorized by Dell is not covered by your warranty. Read and follow the safety instructions that came with the product.





1. Ensure that you read the [Safety instructions](#).
2. Keep the #2 Phillips screwdriver handy.

### Steps

Align the locking tabs on the control panel with the notches on the chassis and angle the control panel until it snaps into place.

When properly seated, the control panel will be flush with the front panel.

 **NOTE:** For an eight 2.5 inch hard drive chassis, tighten the screw to secure the control panel to the bottom of the chassis.

 **NOTE:** For a ten 2.5 inch hard-drive chassis, slide the control panel into the chassis and secure the module with the screw.

### Next steps

Follow the procedure listed in [After working inside your system](#).

## Removing the control-panel module

### Prerequisites

 **CAUTION:** Many repairs may only be done by a certified service technician. You should only perform troubleshooting and simple repairs as authorized in your product documentation, or as directed by the online or telephone service and support team. Damage due to servicing that is not authorized by Dell is not covered by your warranty. Read and follow the safety instructions that came with the product.

1. Ensure that you read the [Safety instructions](#).
2. Follow the procedure listed in [Before working inside your system](#).

 **CAUTION:** Do not use excessive force when removing the control panel as it can damage the connectors.

### Steps

1. Remove the screw(s) securing the control-panel module to the chassis.
2. For a 3.5 inch cabled hard-drive chassis:
  - a. Remove the screw(s) securing the LED panel to the chassis.
  - b. Remove the LED panel.
3. Remove all the cables connecting the control-panel module to the chassis.

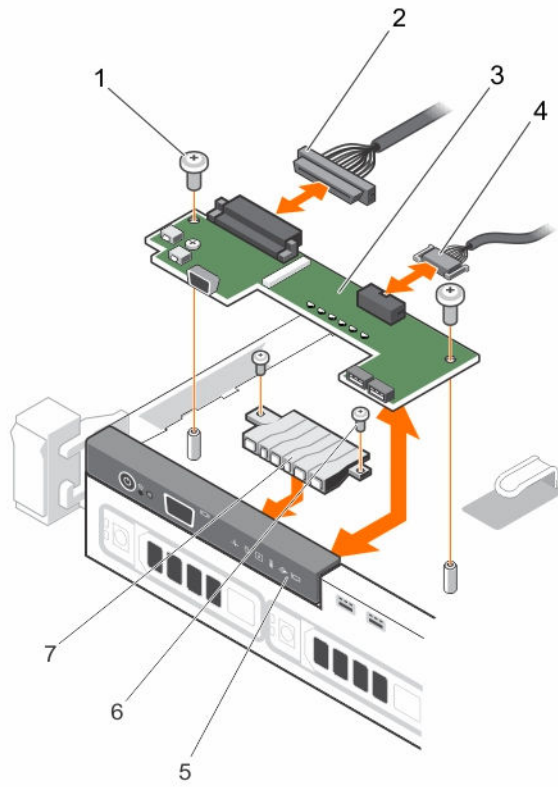

**Figure 54. Removing and installing the control-panel module—four cabled hard-drive chassis**

- |                         |   |
|-------------------------|---|
| 1. screw (2)            | 2. control-panel module connector cable |
| 3. control panel module | 4. USB connector cable                  |
| 5. control panel        | 6. LED-panel screw (2)                  |
| 7. LED panel            |   |

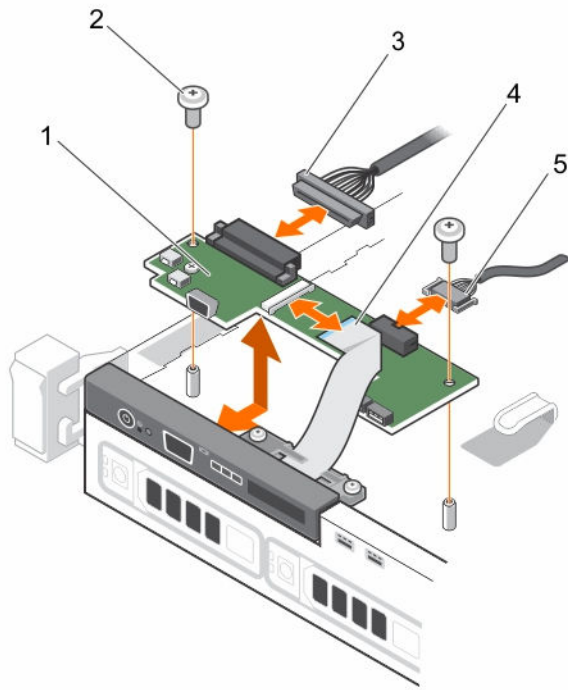

**Figure 55. Removing and installing the control panel module—four hard-drive chassis**

- |   |                                    |
|---|------------------------------------|
| 1. control-panel module                 | 2. control-panel module screws (2) |
| 3. control-panel module connector cable | 4. display module cable            |
| 5. USB connector cable                  |                                    |

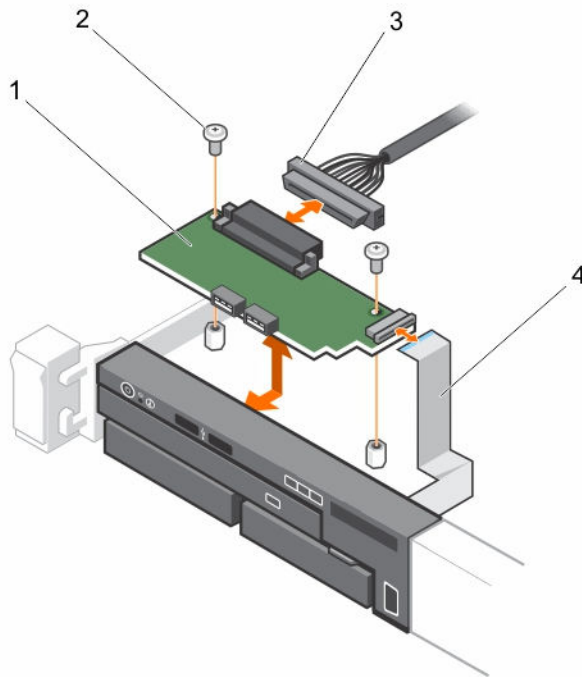

**Figure 56. Removing and Installing the control panel module—eight hard-drive chassis**

- |   |                         |
|---|-------------------------|
| 1. control panel module                 | 2. screw (2)            |
| 3. control-panel module connector cable | 4. display module cable |

## Installing the control-panel module

### Prerequisites

**⚠ CAUTION:** Many repairs may only be done by a certified service technician. You should only perform troubleshooting and simple repairs as authorized in your product documentation, or as directed by the online or telephone service and support team. Damage due to servicing that is not authorized by Dell is not covered by your warranty. Read and follow the safety instructions that came with the product.

1. Ensure that you read the [Safety instructions](#).
2. Follow the procedure listed in [Before working inside your system](#).

### Steps

1. For a 3.5 inch cabled hard drive system:
  - a. Insert the LED panel into the slot in the chassis.
  - b. Secure the LED panel with the screws.
2. Insert the control-panel module into the slot in the chassis and align the two screw holes on the control-panel module with the corresponding holes on the chassis.
3. Secure the control-panel module with the screws.

4. Connect all the applicable cables to the control-panel module.

#### Next steps

Follow the procedure listed in [After working inside your system](#).

## Power interposer board

### Removing the power interposer board

#### Prerequisites



**CAUTION:** Many repairs may only be done by a certified service technician. You should only perform troubleshooting and simple repairs as authorized in your product documentation, or as directed by the online or telephone service and support team. Damage due to servicing that is not authorized by Dell is not covered by your warranty. Read and follow the safety instructions that came with the product.



**NOTE:** The power interposer board is present only in systems that support redundant power supplies.

1. Ensure that you read the [Safety instructions](#).
2. Follow the procedure listed in [Before working inside your system](#).
3. Remove the power supplies from the system.

#### Steps

1. Disconnect the power distribution cables from the system board.
2. Disconnect the fan cable.
3. Remove the two screws securing the power interposer board to the chassis and lift the board out of the chassis.

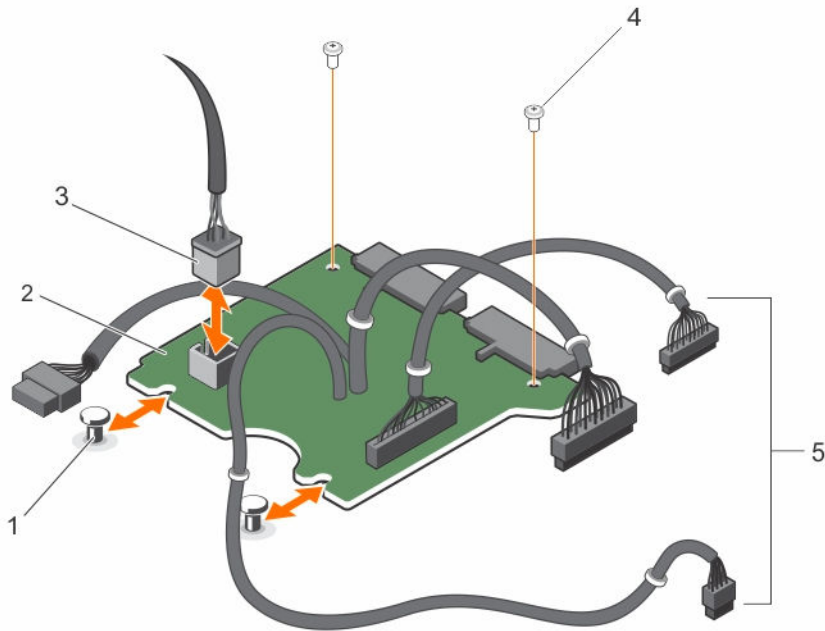

**Figure 57. Removing and installing the power interposer board**

- |   |                           |
|---|---------------------------|
| 1. standoffs (2)                                  | 2. power interposer board |
| 3. fan cable connector                            | 4. screw (2)              |
| 5. power supply cables to the system board<br>(3) |                           |

## Installing the power interposer board

### Prerequisites

**⚠ CAUTION:** Many repairs may only be done by a certified service technician. You should only perform troubleshooting and simple repairs as authorized in your product documentation, or as directed by the online or telephone service and support team. Damage due to servicing that is not authorized by Dell is not covered by your warranty. Read and follow the safety instructions that came with the product.

Ensure that you read the [Safety instructions](#).

### Steps

1. Align the power interposer board with the standoffs on the chassis.
2. Install the two screws that secure the power interposer board to the chassis.
3. Connect the power distribution cables to the system board and fan cable connector to the power interposer board.



## Next steps

Follow the procedure listed in [After working inside your system](#).



# System board

## Removing the system board

### Prerequisites

-  **CAUTION:** Many repairs may only be done by a certified service technician. You should only perform troubleshooting and simple repairs as authorized in your product documentation, or as directed by the online or telephone service and support team. Damage due to servicing that is not authorized by Dell is not covered by your warranty. Read and follow the safety instructions that came with the product.
  -  **CAUTION:** If you are using the Trusted Program Module (TPM) with an encryption key, you may be prompted to create a recovery key during program or System Setup. Be sure to create and safely store this recovery key. If you replace this system board, you must supply the recovery key when you restart your system or program before you can access the encrypted data on your hard drives.
  -  **CAUTION:** Do not attempt to remove the TPM plug-in module from the system board. Once the TPM plug-in module is installed, it is cryptographically bound to that specific system board. Any attempt to remove an installed TPM plug-in module breaks the cryptographic binding, and it cannot be re-installed or installed on another system board.
1. Ensure that you read the [Safety instructions](#).
  2. Follow the procedure listed in [Before working inside your system](#).
  3. Remove the following:
    - a. cooling shroud
    - b. memory modules
    - c. cooling fan cables
    - d. expansion cards
    - e. expansion-card riser
    - f. integrated storage controller card
    - g. heat sink and processor
    - h. internal dual SD module

### Steps

1. Disconnect all other cables from the system board.
  -  **CAUTION:** Take care not to damage the system identification button while removing the system board from the chassis.
2. Remove the nine screws on the system board and slide the system board toward the front of the system.
3. Hold the system board t-handle and lift the system board out of the chassis.
  -  **NOTE:** To prevent damage to the system board, ensure that you hold the system board by its edges only.
  -  **CAUTION:** Do not lift the system board assembly by holding a memory module, processor, or other components.

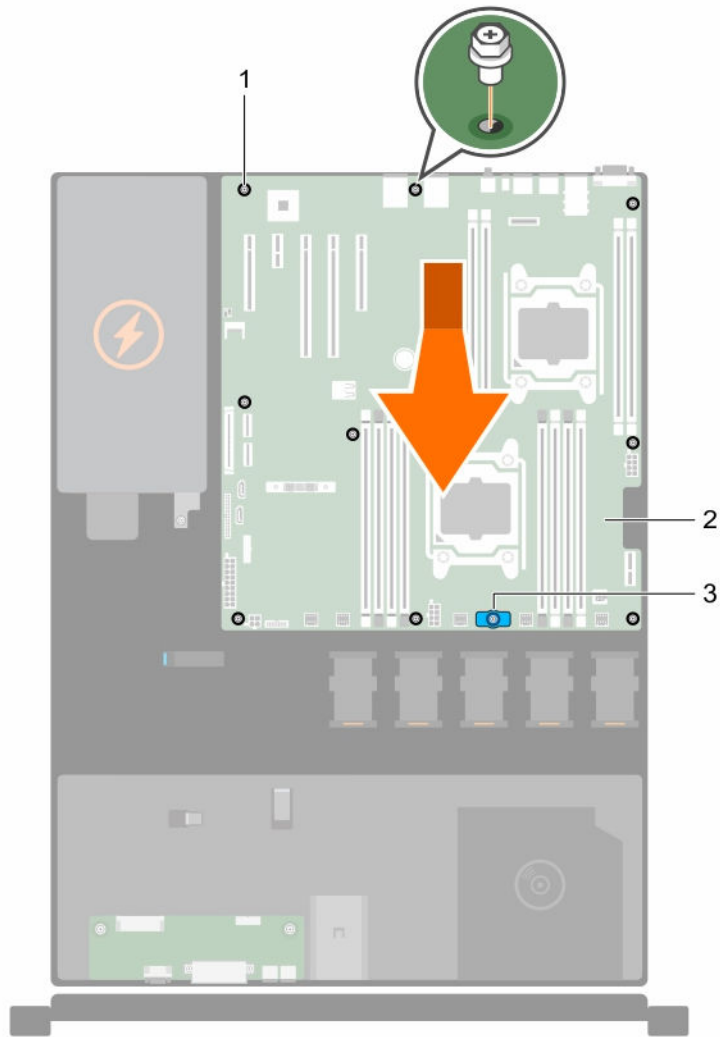

**Figure 58. Removing and installing the system board**

1. screw (9)
2. system board
3. system board t-handle

**Related Links**

- [Removing the cooling shroud](#)
- [Removing memory module](#)
- [Removing a cooling fan](#)
- [Removing an expansion card](#)
- [Removing the expansion-card riser](#)
- [Removing the integrated storage controller card](#)
- [Removing a processor](#)
- [Removing an internal SD card](#)



## Installing the system board

### Prerequisites

 **CAUTION:** Many repairs may only be done by a certified service technician. You should only perform troubleshooting and simple repairs as authorized in your product documentation, or as directed by the online or telephone service and support team. Damage due to servicing that is not authorized by Dell is not covered by your warranty. Read and follow the safety instructions that came with the product.

 **CAUTION:** Do not lift the system board assembly by holding a memory module, processor, or other components.

 **CAUTION:** Take care not to damage the system identification button while placing the system board into the chassis.

1. Ensure that you read the [Safety instructions](#).
2. Unpack the new system board assembly.

### Steps

1. Hold the system board by its edges and the system board t-handle, and angle it toward the back of the chassis.
2. Lower the system board into the chassis till the connectors at the back of the system board align with the slots on the rear wall of the chassis, and the screw holes on the system board align with the standoffs on the chassis.
3. Tighten the nine screws that secure the system board to the chassis.

### Next steps

1. Install the Trusted Platform Module (TPM). See, [Installing the Trusted Platform Module](#).
2. Replace the following:
  - a. internal dual SD module
  - b. heat sink/heat sink blank and processor/processor blank
  - c. expansion card riser
  - d. expansion cards
  - e. integrated storage controller card
  - f. memory modules
  - g. cooling shroud
3. Reconnect all cables to the system board.

 **NOTE:** Ensure that the cables inside the system are routed through the cable routing latch.
4. Follow the procedure listed in [After working inside your system](#).
5. Import your new or existing iDRAC Enterprise license. For more information, see the *Integrated Dell Remote Access Controller User's Guide* at [Dell.com/support/home](https://Dell.com/support/home).
6. Ensure that you:
  - a. Use the Easy Restore feature to restore the service tag. See [Restoring the Service Tag using Easy Restore](#).

- b. If the Service Tag is not backed up in the backup flash device, enter the system service tag manually. See [Entering the system Service Tag using System Setup](#).
- c. Update the BIOS and iDRAC versions.
- d. Re-enable the Trusted Platform Module (TPM). See [Re-enabling the TPM for BitLocker users](#) or [Re-enabling the TPM for TXT users](#).

#### Related Links

- [Installing the cooling shroud](#)
- [Installing memory modules](#)
- [Installing a cooling fan](#)
- [Installing an expansion card](#)
- [Installing the expansion-card riser](#)
- [Installing the integrated storage controller card](#)
- [Installing a processor](#)
- [Removing an internal SD card](#)

### Restoring the Service Tag using Easy Restore

Use the Easy Restore feature if you do not know the Service Tag of your system. The Easy Restore feature allows you to restore your system's Service Tag, license, UEFI configuration, and the system configuration data after replacing the system board. All data is backed up in a backup flash device automatically. If BIOS detects a new system board and the Service Tag in the backup flash device, BIOS prompts the user to restore the backup information.

1. Turn on the system.  
If BIOS detects a new system board, and if the Service Tag is present in the backup flash device, BIOS displays the Service Tag, the status of the license, and the **UEFI Diagnostics** version.
2. Do one of the following:
  - Press **Y** to restore the Service Tag, license, and diagnostics information.
  - Press **N** to navigate to the Lifecycle Controller based restore options.
  - Press <F10> to restore data from a previously created **Hardware Server Profile**.

After the restore process is complete, BIOS prompts to restore the system configuration data.

3. Do one of the following:
  - Press **Y** to restore the system configuration data.
  - Press **N** to use the default configuration settings.

After the restore process is complete, the system restarts.

### Entering the system Service Tag using System Setup

If you know the system Service Tag, use the System Setup menu to enter the Service Tag.

1. Turn on the system.
2. Press <F2> to enter the System Setup.
3. Click **Service Tag Settings**.
4. Enter the Service Tag.



**NOTE:** You can enter the only when the **Service Tag** field is empty. Ensure that you enter the correct Service Tag. Once the Service Tag is entered, it cannot be updated or changed.

5. Click **Ok**.

6. Import your new or existing iDRAC Enterprise license.

For more information, see Integrated Dell Remote Access Controller User's Guide, at [dell.com/esmmanuals](http://dell.com/esmmanuals).

## Trusted Platform Module

The Trusted Platform Module (TPM) is used to generate/store keys, protect/authenticate passwords, and create/store digital certificates. TPM can also be used to enable the BitLocker hard drive encryption feature in Windows Server.

-  **CAUTION: Do not attempt to remove the Trusted Platform Module (TPM) from the system board. Once the TPM is installed, it is cryptographically bound to that specific system board. Any attempt to remove an installed TPM breaks the cryptographic binding, and it cannot be re-installed or installed on another system board.**

## Installing the Trusted Platform Module

### Prerequisites

1. Ensure that you read the [Safety instructions](#).
2. Follow the procedure listed in [Before working inside your system](#).

-  **CAUTION: Do not remove an installed Trusted Platform Module (TPM). Any attempt to remove an installed TPM from the system board may damage the TPM.**

### Steps

1. Align the edge connectors on the TPM with the slot on the TPM connector.
2. Insert the TPM into the TPM connector such that the plastic bolt aligns with the slot on the system board.
3. Press the plastic bolt until the bolt snaps into place.

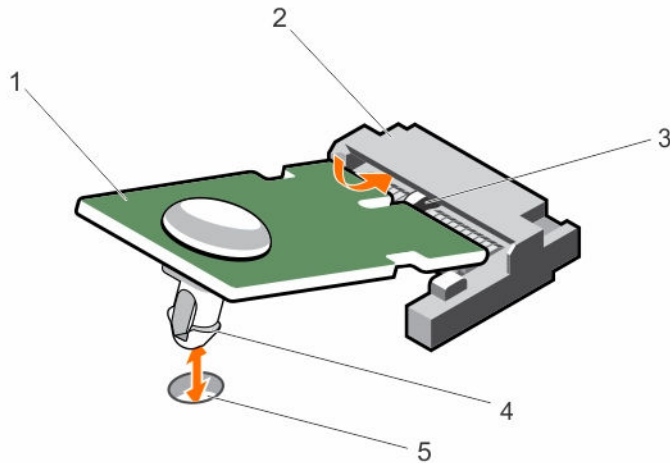

**Figure 59. Installing the TPM**

- |                              |                  |
|------------------------------|------------------|
| 1. TPM                       | 2. TPM connector |
| 3. slot on the TPM connector | 4. plastic bolt  |
| 5. slot on the system board  |                  |

#### **Next steps**

Follow the procedure listed in [After working inside your system](#).

### **Re-enabling the TPM for BitLocker users**

Initialize the TPM.

For more information on initializing the TPM, see <http://technet.microsoft.com/en-us/library/cc753140.aspx>.

The **TPM Status** changes to **Enabled, Activated**.

### **Re-enabling the TPM for TXT users**

1. While booting your system, press <F2> to enter System Setup.
2. In the **System Setup Main Menu**, click **System BIOS** → **System Security Settings**.
3. In the **TPM Security** option, select **On with Pre-boot Measurements**.
4. In the **TPM Command** option, select **Activate**.
5. Save the settings.
6. Restart your system.
7. Enter System Setup again.
8. In the **System Setup Main Menu**, click **System BIOS** → **System Security Settings**.
9. In the **Intel TXT** option, select **On**.

# Troubleshooting your system

## Safety first—for you and your system

 **CAUTION:** Many repairs may only be done by a certified service technician. You should only perform troubleshooting and simple repairs as authorized in your product documentation, or as directed by the online or telephone service and support team. Damage due to servicing that is not authorized by Dell is not covered by your warranty. Read and follow the safety instructions that came with the product.

## Troubleshooting system startup failure

If you boot the system to the BIOS boot mode after installing an operating system from the UEFI Boot Manager, the system hangs. The reverse is also true. You must boot to the same boot mode in which you installed the operating system.

For all other startup issues, note the system messages that appear on the screen.

## Troubleshooting external connections

Ensure that all external cables are securely attached to the external connectors on your system before troubleshooting any external devices.

## Troubleshooting the video subsystem

1. Check the system and power connections to the monitor.
2. Check the video interface cabling from the system to the monitor.
3. Run the appropriate diagnostic test.

If the tests run successfully, the problem is not related to video hardware.

If the tests fail, see [Getting Help](#).

## Troubleshooting a USB device

### About this task

Use the following steps to troubleshoot a USB keyboard/mouse. For other USB devices, go to step 7.

### Steps

1. Disconnect the keyboard and mouse cables from the system and reconnect them.
2. If the problem persists, connect the keyboard/mouse to the USB port(s) on the opposite side of the system.

3. If the problem is resolved, restart the system, enter the System Setup, and check if the non-functioning USB ports are enabled.  
Check if USB 3.0 is enabled in System Setup. If enabled, disable it and see if the issue is resolved (older operating systems may not support USB 3.0).
4. In the **IDRAC Settings Utility**, ensure the **USB Management Port Mode** is configured as **Automatic or Standard OS Use**.
5. Replace the keyboard/mouse with a working keyboard/mouse.  
If the problem is not resolved, proceed to the next step to begin troubleshooting other USB devices attached to the system.
6. Power down all attached USB devices and disconnect them from the system.
7. Restart the system and, if your keyboard is functioning, enter the System Setup.
8. Verify that all USB ports are enabled on the **Integrated Devices** screen, in the System Setup options.
9. Check if USB 3.0 is enabled in System Setup. If it is enabled, disable it and restart your system.  
If your keyboard is not functioning, you can also use remote access.
10. If the system is not accessible, reset the NVRAM\_CLR jumper inside your system and restore the BIOS to the default settings.
11. In the **IDRAC Settings Utility**, ensure the **USB Management Port Mode** is configured as **Automatic or Standard OS Use**.
12. Reconnect and power on each USB device one at a time.
13. If a USB device causes the same problem, power down the device, replace the USB cable with a known good cable, and power up the device.

#### Next steps

If all troubleshooting fails, see [Getting Help](#).

## Troubleshooting a serial I/O device

#### Steps

1. Turn off the system and any peripheral devices connected to the serial port.
2. Swap the serial interface cable with a working cable, and turn on the system and the serial device.  
If the problem is resolved, replace the interface cable with a known good cable.
3. Turn off the system and the serial device, and swap the device with a comparable device.
4. Turn on the system and the serial device.

#### Next steps

If the problem persists, see [Getting Help](#).

## Troubleshooting a NIC

#### Steps

1. Run the appropriate diagnostic test. See [Using System Diagnostics](#) for available diagnostic tests.
2. Reboot the system and check for any system messages pertaining to the NIC controller.
3. Check the appropriate indicator on the NIC connector:
  - If the link indicator does not glow, check all cable connections.
  - If the activity indicator does not glow, the network driver files might be damaged or missing.

Remove and reinstall the drivers if applicable. See the NIC's documentation.

- If applicable, change the autonegotiation setting.
  - Use another connector on the switch or hub.
4. Ensure that the appropriate drivers are installed and the protocols are bound. See the NIC's documentation.
  5. Enter the System Setup and confirm that the NIC ports are enabled on the **Integrated Devices** screen.
  6. Ensure that the NICs, hubs, and switches on the network are all set to the same data transmission speed and duplex. See the documentation for each network device.
  7. Ensure that all network cables are of the proper type and do not exceed the maximum length.

#### Next steps

If all troubleshooting fails, see [Getting Help](#).

## Troubleshooting a wet system

#### Prerequisites

 **CAUTION: Many repairs may only be done by a certified service technician. You should only perform troubleshooting and simple repairs as authorized in your product documentation, or as directed by the online or telephone service and support team. Damage due to servicing that is not authorized by Dell is not covered by your warranty. Read and follow the safety instructions that came with the product.**

#### Steps

1. Turn off the system and attached peripherals, and disconnect the system from the electrical outlet.
2. Remove the system cover.
3. Remove the following components from the system:
  - hard drives
  - hard-drive backplane
  - USB memory key
  - hard-drive tray
  - cooling shroud
  - expansion-card risers (if present)
  - expansion cards
  - power supply unit(s)
  - cooling-fan assembly (if present)
  - cooling fans
  - processor(s) and heat sink(s)
  - memory modules
4. Let the system dry thoroughly for at least 24 hours.
5. Reinstall the components you removed in step 3.
6. Install the system cover.
7. Turn on the system and attached peripherals.

If the system does not start properly, see [Getting Help](#).
8. If the system starts properly, shut down the system, and reinstall all the expansion cards that you removed.

9. Run the appropriate diagnostic test. For more information, see [Using System Diagnostics](#).

#### Next steps

If the tests fail, see [Getting Help](#).

## Troubleshooting a damaged system

#### Prerequisites

 **CAUTION:** Many repairs may only be done by a certified service technician. You should only perform troubleshooting and simple repairs as authorized in your product documentation, or as directed by the online or telephone service and support team. Damage due to servicing that is not authorized by Dell is not covered by your warranty. Read and follow the safety instructions that came with the product.

#### Steps

1. Turn off the system and attached peripherals, and disconnect the system from the electrical outlet.
2. Remove the system cover.
3. Ensure that the following components are properly installed:
  - Cooling shroud
  - Expansion-card risers (if present)
  - Expansion cards
  - Power supply(s)
  - Cooling-fan assembly (if present)
  - Cooling fans
  - Processor(s) and heat sink(s)
  - Memory modules
  - Hard-drive carriers
  - Hard-drive backplane
4. Ensure that all cables are properly connected.
5. Install the system cover.
6. Run the appropriate diagnostic test. For more information, see [Using System Diagnostics](#).

#### Next steps

If the tests fail, see [Getting Help](#).

## Troubleshooting the system battery

#### Prerequisites

 **CAUTION:** Many repairs may only be done by a certified service technician. You should only perform troubleshooting and simple repairs as authorized in your product documentation, or as directed by the online or telephone service and support team. Damage due to servicing that is not authorized by Dell is not covered by your warranty. Read and follow the safety instructions that came with the product.

 **NOTE:** If the system is turned off for long periods of time (for weeks or months), the NVRAM may lose its system configuration information. This situation is caused by a defective battery.



### Steps

1. Re-enter the time and date in the System Setup.
2. Turn off the system and disconnect it from the electrical outlet for at least one hour.
3. Reconnect the system to the electrical outlet and turn on the system.
4. Enter the System Setup.  
If the date and time are not correct in the System Setup, check the SEL for system battery messages.

### Next steps

If the problem persists, see [Getting Help](#).

 **NOTE:** Some software may cause the system time to speed up or slow down. If the system seems to operate normally except for the time kept in the System Setup, the problem may be caused by software rather than by a defective battery.

## Troubleshooting power supply units

 **CAUTION:** Many repairs may only be done by a certified service technician. You should only perform troubleshooting and simple repairs as authorized in your product documentation, or as directed by the online or telephone service and support team. Damage due to servicing that is not authorized by Dell is not covered by your warranty. Read and follow the safety instructions that came with the product.

### Power source problems

1. Press the power button to ensure that your system is turned on. If the power indicator does not light up when the power button is pressed, press the power-on button firmly.
2. Plug in another working device to ensure that the system board is not faulty.
3. Ensure that no loose connections exist.  
For example, loose power cables.
4. Ensure that the power source meets applicable standards.
5. Ensure that there are no short circuits.
6. Have a qualified electrician check the line voltage to ensure that it meets the required specifications.

### Power supply unit problems

1. Ensure that no loose connections exist.  
For example, loose power cables.
2. Ensure that the power supply handle/LED indicates that the power supply is working properly.
3. If you have recently upgraded your system, ensure that the power supply unit has enough power to support the new system.
4. If you have a redundant power supply configuration, ensure that both the power supply units are of the same type and wattage.  
If the LED You may have to upgrade to a higher wattage power supply unit.
5. Ensure that you use only power supply units with the Extended Power Performance (EPP) label on the back.
6. Reseat the power supply unit.

 **NOTE:** After installing a power supply unit, allow several seconds for the system to recognize the power supply unit and determine if it is working properly.

If the problem persists, see [Getting Help](#).

## Troubleshooting cooling problems

 **CAUTION:** Many repairs may only be done by a certified service technician. You should only perform troubleshooting and simple repairs as authorized in your product documentation, or as directed by the online or telephone service and support team. Damage due to servicing that is not authorized by Dell is not covered by your warranty. Read and follow the safety instructions that came with the product.

Ensure that the following conditions exist:

- System cover, cooling shroud, EMI filler panel, memory-module blank, or back-filler bracket is not removed.
- Ambient temperature is not too high.
- External airflow is not obstructed.
- A cooling fan is not removed or has not failed.
- The expansion card installation guidelines have been followed.

Additional cooling can be added by one of the following methods:

From the iDRAC Web GUI

1. Click **Hardware** → **Fans** → **Setup**.
2. From the **Fan Speed Offset** drop-down list, select the cooling level needed or set the minimum fan speed to a custom value.

From F2 System Setup

1. Select **iDRAC Settings** → **Thermal**, and set a higher fan speed from the fan speed offset or minimum fan speed.

From RACADM commands

1. Run the command `racadm help system.thermalsettings`

For more information, see the Integrated Dell Remote Access User's Guide at [dell.com/esmmanuals](http://dell.com/esmmanuals).

## Troubleshooting cooling fans

### Prerequisites

 **CAUTION:** Many repairs may only be done by a certified service technician. You should only perform troubleshooting and simple repairs as authorized in your product documentation, or as directed by the online or telephone service and support team. Damage due to servicing that is not authorized by Dell is not covered by your warranty. Read and follow the safety instructions that came with the product.

 **NOTE:** In the event of a problem with a particular fan, the fan number is referenced by the system's management software, allowing you to easily identify and replace the proper fan by noting the fan numbers on the cooling fan assembly.

### Steps

1. Remove the system cover.
2. Reseat the fan or the fan's power cable.
3. Install the system cover.
4. Restart your system.,

### Next steps

If the problem persists, see [Getting Help](#).

## Troubleshooting system memory

### Prerequisites



**CAUTION:** Many repairs may only be done by a certified service technician. You should only perform troubleshooting and simple repairs as authorized in your product documentation, or as directed by the online or telephone service and support team. Damage due to servicing that is not authorized by Dell is not covered by your warranty. Read and follow the safety instructions that came with the product.

### Steps

1. If the system is operational, run the appropriate diagnostic test. See [Using system diagnostics](#) for available diagnostic tests.  
If diagnostics indicate a fault, follow the corrective actions provided by the diagnostic program.
2. If the system is not operational, turn off the system and attached peripherals, and unplug the system from the power source. Wait at least 10 seconds and then reconnect the system to the power source.
3. Turn on the system and attached peripherals and note the messages on the screen.  
If an error message is displayed indicating a fault with a specific memory module, go to step 12.
4. Enter the System Setup and check the system memory setting. Make any changes to the memory settings, if needed.  
If the memory settings match the installed memory but the problem still persists, go to step 12.
5. Turn off the system and attached peripherals, and disconnect the system from the electrical outlet.
6. Remove the system cover.
7. Check the memory channels and ensure that they are populated correctly.  
 **NOTE:** See the system event log or system messages for the location of the failed memory module. Reinstall the memory device.
8. Reseat the memory modules in their sockets.
9. Install the system.
10. Enter the System Setup and check the system memory setting.  
If the problem is not resolved, proceed with the next step.
11. Remove the system cover.
12. If a diagnostic test or error message indicates a specific memory module as faulty, swap or replace the module with a known good memory module.
13. To troubleshoot an unspecified faulty memory module, replace the memory module in the first DIMM socket with a module of the same type and capacity.  
If an error message is displayed on the screen, this may indicate a problem with the installed DIMM type(s), incorrect DIMM installation, or defective DIMM(s). Follow the on-screen instructions to resolve the problem.

14. Install the system cover.
15. As the system boots, observe any error message that is displayed and the diagnostic indicators on the front of the system.
16. If the memory problem persists, repeat step 12 through step 15 for each memory module installed.

#### Next steps

If the problem persists after all memory modules have been checked, see [Getting Help](#).

## Troubleshooting an internal USB key

### Prerequisites

 **CAUTION:** Many repairs may only be done by a certified service technician. You should only perform troubleshooting and simple repairs as authorized in your product documentation, or as directed by the online or telephone service and support team. Damage due to servicing that is not authorized by Dell is not covered by your warranty. Read and follow the safety instructions that came with the product.

### Steps

1. Enter the System Setup and ensure that the **USB key port** is enabled on the **Integrated Devices** screen.
2. Turn off the system and attached peripherals, and disconnect the system from the electrical outlet.
3. Remove the system cover.
4. Locate the USB key and reseat it.
5. Install the system cover.
6. Turn on the system and attached peripherals and check if the USB key is functioning.
7. If the problem is not resolved, repeat step 2 and step 3.
8. Insert a different USB key that you know works properly.
9. Install the system cover.

#### Next steps

If the problem is not resolved, see [Getting Help](#).

## Troubleshooting an SD card

### Prerequisites

 **CAUTION:** Many repairs may only be done by a certified service technician. You should only perform troubleshooting and simple repairs as authorized in your product documentation, or as directed by the online or telephone service and support team. Damage due to servicing that is not authorized by Dell is not covered by your warranty. Read and follow the safety instructions that came with the product.

 **NOTE:** Certain SD cards have a physical write-protect switch on the card. If the write-protect switch is turned on, the SD card is not writeable.

### Steps

1. Enter the System Setup and ensure that the **Internal SD Card Port** is enabled.
2. Turn off the system, including any attached peripherals, and disconnect the system from the electrical outlet.
3. Remove the system cover.

 **NOTE:** When an SD card failure occurs, the internal dual SD module controller notifies the system. On the next restart, the system displays a message indicating the failure. If redundancy is enabled at the time of SD card failure, a critical alert will be logged and chassis health will degrade.

4. Replace the failed SD card with a new SD card.
5. Install the system cover.
6. Reconnect the system to its electrical outlet and turn the system on, including any attached peripherals.
7. Enter the System Setup and ensure that the **Internal SD Card Port** and **Internal SD Card Redundancy** mode is set to the required mode.  
Verify that correct SD slot is set as **Primary SD Card**.
8. Check if the SD card is functioning properly.
9. If the **Internal SD Card Redundancy** option is set to **Enabled** at the time of the SD card failure, the system will prompt you to perform a rebuild.

 **NOTE:** The rebuild will always be sourced from the primary SD card to the secondary SD card. Perform the rebuild of the SD card as necessary.

## Troubleshooting an optical drive

### Prerequisites

 **CAUTION:** Many repairs may only be done by a certified service technician. You should only perform troubleshooting and simple repairs as authorized in your product documentation, or as directed by the online or telephone service and support team. Damage due to servicing that is not authorized by Dell is not covered by your warranty. Read and follow the safety instructions that came with the product.

### Steps

1. Try using a different CD or DVD.
2. Enter the System Setup and ensure that the integrated SATA controller and the drive's SATA port are enabled.
3. Run the appropriate diagnostic test.
4. Turn off the system and attached peripherals, and disconnect the system from the electrical outlet.
5. If installed, remove the front bezel.
6. Remove the system cover.
7. Ensure that the interface cable is securely connected to the optical drive and to the controller.
8. Ensure that a power cable is properly connected to the drive.
9. Install the system cover.

### Next steps

If the problem is not resolved, see [Getting Help](#).

# Troubleshooting a tape backup unit

## Prerequisites

 **CAUTION:** Many repairs may only be done by a certified service technician. You should only perform troubleshooting and simple repairs as authorized in your product documentation, or as directed by the online or telephone service and support team. Damage due to servicing that is not authorized by Dell is not covered by your warranty. Read and follow the safety instructions that came with the product.

## Steps

1. Use a different tape cartridge.
2. Ensure that the device drivers for the tape backup unit are installed and are configured correctly. See your tape drive documentation for more information about device drivers.
3. Reinstall the tape-backup software as instructed in the tape-backup software documentation.
4. Ensure that the interface cable of the tape drive is connected to the external port on the controller card.
5. Perform the following steps to ensure that the controller card is properly installed:
  - a. Turn off the system and attached peripherals, and disconnect the system from the electrical outlet.
  - b. Remove the system cover.
  - c. Reseat the controller card in the expansion card slot.
  - d. Install the system cover.
  - e. Turn on the system and attached peripherals.
6. Run the appropriate diagnostic test. For more information, see [Using System Diagnostics](#).

## Next steps

If you cannot resolve the problem, see [Getting Help](#).

# Troubleshooting a hard drive

## Prerequisites

 **CAUTION:** Many repairs may only be done by a certified service technician. You should only perform troubleshooting and simple repairs as authorized in your product documentation, or as directed by the online or telephone service and support team. Damage due to servicing that is not authorized by Dell is not covered by your warranty. Read and follow the safety instructions that came with the product.

 **CAUTION:** This troubleshooting procedure can erase data stored on the hard drive. Before you proceed, back up all files on the hard drive.

## Steps

1. Run the appropriate diagnostic test. For more information, see [Using System Diagnostics](#). Depending on the results of the diagnostics test, proceed as needed through the following steps.
2. If your system has a RAID controller and your hard drives are configured in a RAID array, perform the following steps:
  - a. Reboot the system and press <F10> during system startup to run the Lifecycle Controller, and then run the Hardware Configuration wizard to check the RAID configuration. See the Lifecycle Controller documentation or online help for information on RAID configuration.
  - b. Ensure that the hard drive(s) are configured correctly for the RAID array.

- c. Take the hard drive offline and reseat the drive.
- d. Exit the configuration utility and allow the system to boot to the operating system.
3. Ensure that the required device drivers for your controller card are installed and are configured correctly. See the operating system documentation for more information.
4. Reboot the system and enter the System Setup.
5. Verify that the controller is enabled and the drives are displayed in the System Setup.

#### Next steps

If the problem persists, try troubleshooting the expansion cards or see [Getting Help](#).

## Troubleshooting a storage controller

 **CAUTION:** Many repairs may only be done by a certified service technician. You should only perform troubleshooting and simple repairs as authorized in your product documentation, or as directed by the online or telephone service and support team. Damage due to servicing that is not authorized by Dell is not covered by your warranty. Read and follow the safety instructions that came with the product.

 **NOTE:** When troubleshooting a SAS or PERC controller, see the documentation for your operating system and the controller.

1. Run the appropriate diagnostic test. For more information, see [Using System Diagnostics](#).
2. Turn off the system and attached peripherals, and disconnect the system from the electrical outlet.
3. Remove the system cover.
4. Verify that the installed expansion cards are compliant with the expansion card installation guidelines.
5. Ensure that each expansion card is firmly seated in its connector.
6. Install the system cover.
7. Reconnect the system to the electrical outlet, and turn on the system and attached peripherals.
8. If the problem is not resolved, turn off the system and attached peripherals, and disconnect the system from the electrical outlet.
9. Remove the system cover.
10. Remove all expansion cards installed in the system.
11. Install the system cover.
12. Reconnect the system to the electrical outlet, and turn on the system and attached peripherals.
13. Run the appropriate diagnostic test. For more information, see [Using System Diagnostics](#). If the tests fail, see [Getting Help](#).
14. For each expansion card you removed in step 10, perform the following steps:
  - a. Turn off the system and attached peripherals, and disconnect the system from the electrical outlet.
  - b. Remove the system cover.
  - c. Reinstall one of the expansion cards.
  - d. Install the system cover.
  - e. Run the appropriate diagnostic test. For more information, see [Using System Diagnostics](#).

If the tests fail, see [Getting Help](#).

# Troubleshooting expansion cards

## Prerequisites

 **CAUTION:** Many repairs may only be done by a certified service technician. You should only perform troubleshooting and simple repairs as authorized in your product documentation, or as directed by the online or telephone service and support team. Damage due to servicing that is not authorized by Dell is not covered by your warranty. Read and follow the safety instructions that came with the product.

 **NOTE:** When troubleshooting an expansion card, see the documentation for your operating system and the expansion card.

## Steps

1. Run the appropriate diagnostic test. For more information, see [Using System Diagnostics](#) .
2. Turn off the system and attached peripherals, and disconnect the system from the electrical outlet.
3. Open the system.
4. Ensure that each expansion card is firmly seated in its connector.
5. Close the system.
6. If the problem is not resolved, turn off the system and attached peripherals, and disconnect the system from the electrical outlet.
7. Open the system.
8. Remove all expansion cards installed in the system.
9. Close the system.
10. Run the appropriate diagnostic test. For more information, see [Using System Diagnostics](#) .  
If the tests fail, see [Getting Help](#).
11. For each expansion card you removed in step 8, perform the following steps:
  - a. Turn off the system and attached peripherals, and disconnect the system from the electrical outlet.
  - b. Open the system.
  - c. Reinstall one of the expansion cards.
  - d. Close the system.
  - e. Run the appropriate diagnostic test. For more information, see [Using System Diagnostics](#) .

## Next steps

If the problem persists, see [Getting Help](#).

# Troubleshooting processors

## Prerequisites

 **CAUTION:** Many repairs may only be done by a certified service technician. You should only perform troubleshooting and simple repairs as authorized in your product documentation, or as directed by the online or telephone service and support team. Damage due to servicing that is not authorized by Dell is not covered by your warranty. Read and follow the safety instructions that came with the product.

## Steps

1. Run the appropriate diagnostics test. See [Using System Diagnostics](#) for available diagnostic tests.
2. Turn off the system and attached peripherals, and disconnect the system from the electrical outlet.



3. Open the system.
4. Ensure that the processor and heat sink are properly installed.
5. Close the system.
6. Run the appropriate diagnostic test. For more information, see [Using System Diagnostics](#).

#### Next steps

If the problem persists, see [Getting Help](#).

## System messages

For a list of event and error messages generated by the system firmware and agents that monitor system components, see the Dell Event and Error Messages Reference Guide at [dell.com/esmmanuals](http://dell.com/esmmanuals).

### Warning messages

A warning message alerts you to a possible problem and prompts you to respond before the system continues a task. For example, before you format a hard drive, a message warns you that you may lose all data on the hard drive. Warning messages usually interrupt the task and require you to respond by typing y (yes) or n (no).

 **NOTE:** Warning messages are generated by either the application or the operating system. For more information, see the documentation that accompanied the operating system or application.

### Diagnostic messages

The system diagnostic utilities may issue messages if you run diagnostic tests on your system. See [Using system diagnostics](#) for more information about system diagnostics.

### Alert messages

The systems management software generates alert messages for your system. Alert messages include information, status, warning, and failure messages for drive, temperature, fan, and power conditions. For more information, see the systems management software documentation.

## Using system diagnostics

If you experience a problem with your system, run the system diagnostics before contacting Dell for technical assistance. The purpose of running system diagnostics is to test your system hardware without requiring additional equipment or risking data loss. If you are unable to fix the problem yourself, service and support personnel can use the diagnostics results to help you solve the problem.

### Dell Embedded System Diagnostics

 **NOTE:** The Dell Embedded System Diagnostics is also known as Enhanced Pre-boot System Assessment (ePSA) diagnostics.

The embedded system diagnostics provides a set of options for particular device groups or devices allowing you to:

- Run tests automatically or in an interactive mode
- Repeat tests
- Display or save test results
- Run thorough tests to introduce additional test options to provide extra information about the failed device(s)
- View status messages that inform you if tests are completed successfully
- View error messages that inform you of problems encountered during testing

### When to use the Embedded System Diagnostics

If a major component or device in the system does not operate properly, running the embedded system diagnostics may indicate component failure.

### Running the Embedded System Diagnostics from Boot Manager

1. As the system boots, press <F11>.
2. Use the up and down arrow keys to select **System Utilities** → **Launch Diagnostics**.  
The **ePSA Pre-boot System Assessment** window is displayed, listing all devices detected in the system. The diagnostics starts executing the tests on all the detected devices.

### Running the Embedded System Diagnostics from the Dell Lifecycle Controller

1. As the system boots, press <F11>.
2. Select **Hardware Diagnostics** → **Run Hardware Diagnostics**.  
The **ePSA Pre-boot System Assessment** window is displayed, listing all devices detected in the system. The diagnostics starts executing the tests on all the detected devices.

## System diagnostic controls

| Menu          | Description   |
|---------------|---|
| Configuration | Displays the configuration and status information of all detected devices.  |
| Results       | Displays the results of all tests that are executed.  |
| System health | Provides the current overview of the system performance.  |
| Event log     | Displays a time-stamped log of the results of all tests run on the system. This is displayed if at least one event description is recorded. |





For information about embedded system diagnostics, see the *ePSA Diagnostics Guide (Notebooks, Desktops and Servers)* at [dell.com/support/home](http://dell.com/support/home).

# Jumpers and connectors

## System board jumper settings

For information about resetting the password jumper to disable a password, see [Disabling a Forgotten Password](#).

**Table 21. System board jumper settings**

| Jumper    | Setting  | Description  |
|-----------|--|--|
| PWRD_EN   | <br>2 4 6 (default) | The password reset feature is enabled (pins 2–4).  |
|           | <br>2 4 6           | The password reset feature is disabled (pins 4–6).<br>The iDRAC local access is unlocked at the next AC power cycle. |
| NVRAM_CLR | <br>1 3 5 (default) | The configuration settings are retained at the next system boot (pins 3–5).  |
|           | <br>1 3 5         | The configuration settings are cleared at system boot (pins 1–3).  |

## System board connectors

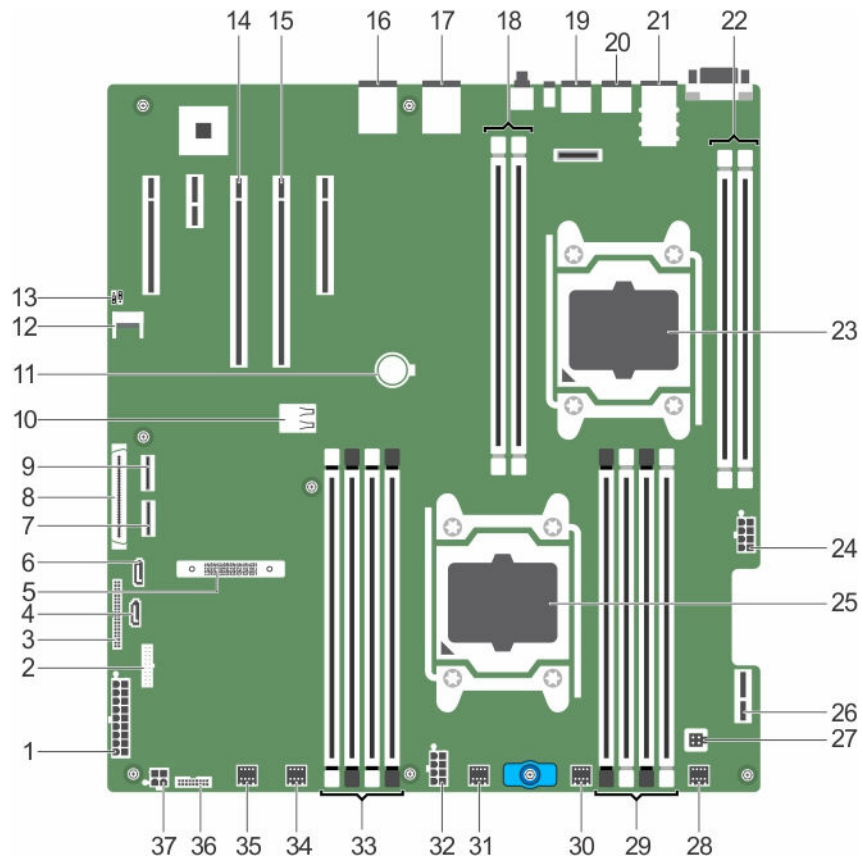



Figure 60. System board jumpers and connectors

Table 22. System board jumpers and connectors

| Item | Connector                  | Description                       |
|------|----------------------------|-----------------------------------|
| 1    | SYS_PWR_CONN (P1)          | 24-pin power connector            |
| 2    | FB_USB                     | Front-panel USB connector         |
| 3    | PIB_CONN                   | Power interposer board connector  |
| 4    | SATA_CDRUM                 | SATA connector CDRUM              |
| 5    | MiniPERC PCIE_G3_X8 (CPU1) | Mini PERC card connector          |
| 6    | SATA_TBU                   | SATA connector tape backup unit   |
| 7    | SW_RAID_B                  | Software RAID connector B         |
| 8    | CTRL_PNL                   | Control panel interface connector |
| 9    | SW_RAID_A                  | Software RAID connector A         |
| 10   | INT_USB_3.0                | Internal USB connector            |

| Item | Connector               | Description   |
|------|-------------------------|---|
| 11   | BATTERY                 | Battery connector   |
| 12   | TPM_MODULE              | Trusted platform module connector   |
| 13   | J_PSWD_NVRAM            | For more information, see <a href="#">System board jumper settings</a>  |
| 14   | SLOT3 PCIE_G3_X16(CPU1) | PCIe card connector 3   |
| 15   | SLOT2 PCIE_G3_X16(CPU1) | PCIe card connector 2   |
|      |                         |  <b>NOTE:</b> The PCIE_G3_X8 and PCIE_G3_X16 are the two different types of risers supported on R430 systems. You can install an expansion card on the system board only using expansion-card riser. Form more information about the installation guidelines, see <a href="#">Expansion card installation guidelines</a> . |
| 16   | NIC4                    | Network connector   |
| 17   | NIC3                    | Network connector   |
| 18   | B1, B2                  | Memory module socket  |
| 19   | USB2_3.0                | USB connector   |
| 20   | USB1                    | USB connector   |
| 21   | NIC1 and NIC2           | Network connector   |
| 22   | B3, B4                  | Memory module socket  |
| 23   | CPU2                    | Processor socket 2  |
| 24   | PWR_CONN_C(P3)          | 8-pin power connector   |
| 25   | CPU1                    | Processor socket 1  |
| 26   | IDSMD                   | Internal Dual SD Module connector   |
| 27   | INTRUSION               | Intrusion switch connector  |
| 28   | FAN6                    | Cooling fan connector   |
| 29   | A1, A5, A2, A6          | Memory module socket  |
| 30   | FAN5                    | Cooling fan connector   |
| 31   | FAN4                    | Cooling fan connector   |
| 32   | PWR_CONN_B(P2)          | 8-pin power connector   |
| 33   | A3, A7, A4, A8          | Memory module socket  |
| 34   | FAN3                    | Cooling fan connector   |
| 35   | FAN2                    | Cooling fan connector   |

| Item | Connector | Description                  |
|------|-----------|------------------------------|
| 36   | BP_SIG    | Backplane signal connector   |
| 37   | ODD_PWR   | Optical disk drive connector |

## Disabling a forgotten password

The system's software security features include a system password and a setup password. The password jumper enables these password features or disables them and clears any password(s) currently in use.

### Prerequisites

 **CAUTION:** Many repairs may only be done by a certified service technician. You should only perform troubleshooting and simple repairs as authorized in your product documentation, or as directed by the online or telephone service and support team. Damage due to servicing that is not authorized by Dell is not covered by your warranty. Read and follow the safety instructions that came with the product.

### Steps

1. Turn off the system, including any attached peripherals, and disconnect the system from the electrical outlet.
2. Open the system.
3. Move the jumper on the system-board jumper from pins 4 and 6 to pins 2 and 4.
4. Close the system.

The existing passwords are not disabled (erased) until the system boots with the jumper on pins 2 and 4. However, before you assign a new system and/or setup password, you must move the jumper back to pins 4 and 6.

 **NOTE:** If you assign a new system and/or setup password with the jumper on pins 2 and 4, the system disables the new password(s) the next time it boots.

5. Reconnect the system to its electrical outlet and turn the system on, including any attached peripherals.
6. Turn off the system, including any attached peripherals, and disconnect the system from the electrical outlet.
7. Open the system.
8. Move the jumper on the system-board jumper from pins 2 and 4 to pins 4 and 6.
9. Close the system.
10. Reconnect the system to its electrical outlet and turn the system on, including any attached peripherals.
11. Assign a new system and/or setup password.

# Technical specifications

**Table 23. Physical specifications**

| <b>Physical</b>        |                       |
|------------------------|-----------------------|
| Height                 | 42.8 mm (1.68 inch)   |
| Width                  |                       |
| With rack latches      | 482.4 mm (18.99 inch) |
| Without rack latches   | 434.0 mm (17.08 inch) |
| Depth (excludes bezel) | 607.0 mm (23.9 inch)  |
| Weight (maximum)       | 19.9 kg (43.87 lb)    |
| Weight (empty)         | 16.73 kg (36.88 lb)   |

**Table 24. Processor specification**

| <b>Processor</b> |   |
|------------------|---|
| Processor type   | Intel Xeon EP E5-2600 v3 product family |

**Table 25. Expansion Bus specifications**

| <b>Expansion Bus</b>                                  |  |
|---|--|
| Bus type  | PCI Express Generation 2 and 3   |
| <b>Expansion slots using the expansion-card riser</b> |  |
| PCIE_G3_X16   | (Slot 1) one half-height, half-length x16 link for processor 1<br><br>(Slot 2) one half-height, half-length x16 link for processor 1 |
| PCIE_G3_X8  | (Slot 1) one Full-height, half-length x8 link for processor 1<br><br>(Slot 2) one half-height, half-length x8 link for processor 1   |



**Table 26. Memory specifications**

| <b>Memory</b> |  |
|---------------|--|
| Architecture  | 1333 MT/s, 1600 MT/s, 1866 MT/s, or 2133 MT/s<br>DDR4 Registered DIMMs |



| <b>Memory</b>                     |  |
|-----------------------------------|--|
|                                   | Support for advanced ECC or memory optimized operation   |
| Memory module sockets             | Twelve 288-pin   |
| Memory module capacities (RDIMMs) | 4 GB (single-rank), 8 GB (single- and dual-rank), 16 GB (single- and dual-rank), and 32 GB (single- and dual-rank) |
| Minimum RAM                       | 4 GB with single processor<br>8 GB with dual processor   |
| Maximum RAM                       | Up to 192 GB with single processor<br>Up to 384 GB with dual processor   |

**Table 27. Power specifications**

| <b>Power</b>   |  |
|--|--|
| AC power supply (per power supply)   |  |
| Wattage  | 450 W or 550 W   |
| Power rating per power supply unit   | 550 W (Platinum) AC (100–240 V, 50/60 Hz, 7.4 A-3.7 A)<br>450 W (Bronze) AC (100–240 V, 50/60 Hz, 6.5 A-3.5 A) |
| Heat Dissipation   | 2107 BTU/hr (550W power supply)<br>1871 BTU/hr (450W power supply)   |
|  <b>NOTE:</b> Heat dissipation is calculated using the power supply wattage rating.   |  |
| Voltage  | 100-240 V AC, autoranging, 50/60 Hz  |
|  <b>NOTE:</b> This system is also designed to be connected to IT power systems with a phase to phase voltage not exceeding 230 V. |  |

**Table 28. RAID controller specification**

| <b>RAID Controller</b> |        |
|------------------------|--------|
| Controller type        | PERC 9 |



**Table 29. Driver specifications**

| <b>Drives</b>           |  |
|-------------------------|--|
| Hard drives             |  |
| Four hard-drive systems | Up to four 3.5-inch cabled hard drives, or |

---

**Drives**

---

|                          |  |
|--------------------------|--|
|                          | Up to four 3.5-inch hot-swappable SAS, SATA, or Nearline SAS hard drives, or   |
|                          | Up to four 2.5-inch hot-swappable SAS, SATA, SATA SSD, or Nearline SAS hard drives.  |
|                          |  <b>NOTE:</b> Four hard-drive systems support software RAID. For more information on software RAID, see the Dell PowerEdge RAID Controller (PERC) documentation at <a href="http://dell.com/support/home">dell.com/support/home</a> . |
| Eight hard-drive systems | Up to eight 2.5-inch, hot-swappable SAS, SATA, SATA SSD, or Nearline SAS hard drives   |
| Ten hard-drive systems   | Up to ten 2.5-inch, hot-swappable SATA HDD or SATA SSD   |
| Optical drive            |  |
| Four hard-drive systems  | One optional slim SATA DV-DROM or DVD+/-RW drive   |
|                          |  <b>NOTE:</b> DVD devices are data only.  |
| Eight hard-drive systems | One optional ultra slim SATA DV-DROM or DVD +/-RW drive  |
|                          |  <b>NOTE:</b> DVD devices are data only.  |

**Table 30. Connectors specifications**

---

**Connectors**

---

**Back**

|                      |  |
|----------------------|--|
| NIC                  | Four 10/100/1000 Mbps  |
| Serial               | 9-pin, DTE, 16550-compatible   |
| USB                  | One 9-pin, USB 3.0-compliant   |
|                      | One 4-pin, USB 2.0-compliant   |
| Video                | 15-pin VGA   |
| iDRAC8               | One optional 1 GbE Ethernet  |
| External vFlash card | One optional vFlash memory card  |
|                      |  <b>NOTE:</b> The card slot is available for use only if the iDRAC8 Enterprise license is installed on your system. |

**Front**

|     |                              |
|-----|------------------------------|
| USB | Two 4-pin, USB 2.0-compliant |
|-----|------------------------------|

| <b>Connectors</b>               |   |
|---------------------------------|---|
| Video                           | 15-pin VGA  |
| <b>Internal</b>                 |   |
| USB                             | One 9-pin, USB 3.0-compliant  |
| Internal Dual SD Module (IDSDM) | Two optional flash memory card slots with the internal SD module  |
|                                 |  <b>NOTE:</b> One card slot is dedicated for redundancy. |

**Table 31. Video specifications**

| <b>Video</b> |                        |
|--------------|------------------------|
| Video type   | Integrated Matrox G200 |
| Video memory | 16 MB shared           |

**Table 32. Environmental specifications**

| <b>Environmental specifications</b>                            |   |
|--|---|
|  |  <b>NOTE:</b> For additional information about environmental measurements for specific system configurations, see <a href="http://dell.com/environmental_datasheets">dell.com/environmental_datasheets</a> . |
| <b>Temperature</b>   |   |
| Storage  | -40°C to 65°C (-40°F to 149°F)  |
| Continuous operation (for altitude less than 950 m or 3117 ft) | 10°C to 35°C (50°F to 95°F) with no direct sunlight on the equipment.   |
| Fresh air  | For information on fresh air, see Expanded Operating Temperature section.   |
| Maximum temperature gradient (operating and storage)           | 20°C/h (36°F/h)   |
| <b>Relative humidity</b>                                       |   |
| Storage  | 5% to 95% RH with 33°C (91°F) maximum dew point. Atmosphere must be non-condensing at all times.  |
| Operating  | 10% to 80% Relative Humidity with 29°C (84.2°F) maximum dew point.  |
| <b>Maximum vibration</b>                                       |   |
| Operating  | 0.26 G <sub>rms</sub> at 5 Hz to 350 Hz (all operation orientations).   |
| Storage  | 1.88 G <sub>rms</sub> at 10 Hz to 500 Hz for 15 min (all six sides tested).   |
| <b>Maximum shock</b>   |   |

---

**Environmental specifications**

---

|           |  |
|-----------|--|
| Operating | Six consecutively executed shock pulses in the positive and negative x, y, and z axes of 40 G for up to 2.3 ms.                                      |
| Storage   | Six consecutively executed shock pulses in the positive and negative x, y, and z axes (one pulse on each side of the system) of 71 G for up to 2 ms. |

**Maximum altitude**

|           |                       |
|-----------|-----------------------|
| Operating | 3048 m (10,000 ft).   |
| Storage   | 12,000 m (39,370 ft). |

**Operating temperature de-rating**

|                               |  |
|-------------------------------|--|
| Up to 35°C (95°F)             | Maximum temperature is reduced by 1°C/300 m (1°F/547 ft) above 950 m (3,117 ft). |
| 35°C to 40°C (95°F to 104°F)  | Maximum temperature is reduced by 1°C/175 m (1°F/319 ft) above 950 m (3,117 ft). |
| 40°C to 45°C (104°F to 113°F) | Maximum temperature is reduced by 1°C/125 m (1°F/228 ft) above 950 m (3,117 ft). |

**Particulate contamination**

 **NOTE:** This section defines the limits to help avoid IT equipment damage and/or failure from particulates and gaseous contamination. If it is determined that levels of particulates or gaseous pollution are beyond the limits specified below and are the reason for the damage and/or failures to your equipment, it may be necessary for you to re-mediate the environmental conditions that are causing the damage and/or failures. Re-mediation of environmental conditions will be the responsibility of the customer.

Air filtration Data center air filtration as defined by ISO Class 8 per ISO 14644-1 with a 95% upper confidence limit.

 **NOTE:** Applies to data center environments only. Air filtration requirements do not apply to IT equipment designed to be used outside a data center, in environments such as an office or factory floor.

 **NOTE:** Air entering the data center must have MERV11 or MERV13 filtration.

Conductive dust Air must be free of conductive dust, zinc whiskers, or other conductive particles.

 **NOTE:** Applies to data center and non-data center environments.

Corrosive dust

 **NOTE:** Applies to data center and non-data center environments.

- Air must be free of corrosive dust.
- Residual dust present in the air must have a deliquescent point less than 60% relative humidity.

**Gaseous contamination**

---

**Environmental specifications**

---

 **NOTE:** Maximum corrosive contaminant levels measured at  $\leq 50\%$  relative humidity.

Copper coupon corrosion rate <math><300 \text{ \AA}/\text{month}</math> per Class G1 as defined by ANSI/ISA71.04-1985.

Silver coupon corrosion rate <math><200 \text{ \AA}/\text{month}</math> as defined by AHSRAE TC9.9.

**Table 33. Expanded operating temperature specifications**

---

**Expanded operating temperature**

---

 **NOTE:** When operating in the expanded temperature range, system performance may be impacted.

 **NOTE:** When operating in the expanded temperature range, ambient temperature warnings may be reported on the LCD and in the System Event Log.

Continuous operation 5°C to 40°C at 5% to 85% RH with 29°C dew point.

 **NOTE:** Outside the standard operating temperature (10°C to 35°C), the system can operate down to 5°C or up to 40°C for a maximum of 10% of its annual operating hours.

For temperatures between 35°C and 40°C, de-rate maximum allowable dry bulb temperature by 1°C per 175 m above 950 m (1°F per 319 ft).

$\leq 1\%$  of annual operating hours -5°C to 45°C at 5% to 90% RH with 29°C dew point.

 **NOTE:** Outside the standard operating temperature (10°C to 35°C), the system can operate down to -5°C or up to 45°C for a maximum of 1% of its annual operating hours.

For temperatures between 40°C and 45°C, de-rate maximum allowable dry bulb temperature by 1°C per 125 m above 950 m (1°F per 228 ft).

Expanded Operating Temperature Restrictions

- Processors of 55 W and 65 W are not supported.
- Do not perform a cold startup below 5°C.
- Allow processor performance degrade.
- Non-redundant power supplies are not supported.
- Non Dell qualified peripheral cards and/or peripheral cards are not supported.
- Maximum altitude for the operating temperature must be 3050 m (10,000 ft).

# Getting help

## Contacting Dell

Dell provides several online and telephone-based support and service options. If you do not have an active Internet connection, you can find contact information on your purchase invoice, packing slip, bill, or Dell product catalog. Availability varies by country and product, and some services may not be available in your area. To contact Dell for sales, technical support, or customer-service issues:

1. Go to **dell.com/support**.
2. Select your country from the drop-down menu on the bottom right corner of the page.
3. For customized support:
  - a. Enter your system Service Tag in the **Enter your Service Tag** field.
  - b. Click **Submit**.The support page that lists the various support categories is displayed.
4. For general support:
  - a. Select your product category.
  - b. Select your product segment.
  - c. Select your product.The support page that lists the various support categories is displayed.

## Locating your system Service Tag

Your system is identified by a unique Express Service Code and Service Tag number. The Express Service Code and Service Tag are found on the front of the system by pulling out the information tag. Alternatively, the information may be on a sticker on the chassis of the system. This information is used by Dell to route support calls to the appropriate personnel.

## Documentation feedback

If you have feedback for this document, write to **documentation\_feedback@dell.com**. Alternatively, you can click on the **Feedback** link in any of the Dell documentation pages, fill out the form, and click **Submit** to send your feedback.

## Quick Resource Locator (QRL)

Use the Quick Resource Locator (QRL) to get immediate access to system information and how-to videos. This can be done by visiting **dell.com/QRL** or by using your smartphone or tablet and a model specific Quick Resource (QR) code located on your Dell PowerEdge system. To try out the QR code, scan the following image.



Figure 61. Quick Resource Locator

## Free Manuals Download Website

<http://myh66.com>

<http://usermanuals.us>

<http://www.somanuals.com>

<http://www.4manuals.cc>

<http://www.manual-lib.com>

<http://www.404manual.com>

<http://www.luxmanual.com>

<http://aubethermostatmanual.com>

Golf course search by state

<http://golfingnear.com>

Email search by domain

<http://emailbydomain.com>

Auto manuals search

<http://auto.somanuals.com>

TV manuals search

<http://tv.somanuals.com>