



Dell™ 3100MP Projector User's Guide

The information below is provided by the supplier of the referenced device without independent verification by Dell and is subject to the [restrictions and disclaimers](#).

[Safety Instructions](#)
[About Your Projector](#)
[Installation](#)
[Using Your Projector](#)
[Troubleshooting](#)
[Specifications](#)
[Regulatory Notices](#)
[Contacting Dell](#)

Notes, Notices, and Cautions

-  NOTE: A NOTE indicates important information that helps you make better use of your computer.
 -  NOTICE: A NOTICE indicates either potential damage to hardware or loss of data and tells you how to avoid the problem.
 -  CAUTION: A CAUTION indicates a potential for property damage, personal injury, or death.
-

Information in this document is subject to change without notice.

© 2001 Coretronic Corporation.

© 2002 Dell Computer Corporation. All rights reserved.

Reproduction in any manner whatsoever without the written permission of Dell Computer Corporation is strictly forbidden.

Trademarks used in this text: *Dell* and the *DELL* logo are trademarks of Dell Computer Corporation; *DLP* and *Texas Instruments* are trademarks of Texas Instruments Corporation; *Microsoft* and *Windows* are registered trademarks of Microsoft Corporation; *Macintosh* is a registered trademark of Apple Computer, Inc.

Other trademarks and trade names may be used in this document to refer to either the entities claiming the marks and names or their products. Dell Computer Corporation disclaims any proprietary interest in trademarks and trade names other than its own.

Restrictions and Disclaimers

The information contained in this document, including all instructions, cautions, and regulatory approvals and certifications, is based upon statements provided to Dell by the manufacturer and has not been independently verified or tested by Dell. Dell disclaims all liability in connection with any deficiencies in such information.

All statements or claims regarding the properties, capabilities, speeds, or qualifications of the part referenced in this document are made by the manufacturer and not by Dell. Dell specifically disclaims any knowledge of the accuracy, completeness, or substantiation for any such statements.

March 2002 Rev. A00

Safety Instructions: Dell™ 3100MP Projector



CAUTION

Use the following safety guidelines to help protect your projector from potential damage and to ensure your own personal safety:

- The lamp becomes very hot with use. Do not attempt to replace the lamp after use until the projector has been allowed to cool down for at least 30 minutes, and follow all instructions in "[Changing the Lamp](#)."
- Do not touch the bulb or the lamp glass at any time. The bulb may explode due to improper handling, including the touching of the bulb or the lamp glass.
- To avoid damaging the projector, allow the cooling fan to run for 3 minutes before turning off the projector.
- The remote control is equipped with a Class II laser that emits laser radiation. To reduce the risk of injury, do not look directly into the laser light, and do not point the laser light into anyone's eyes.
- Do not block the ventilation slots and openings on the projector.
- Disconnect the power cord from the electrical outlet if the projector is not used for a long period of time.
- Do not use the projector in an extremely hot, cold, or humid environment.
- Do not use the projector in areas susceptible to excessive dust and dirt.
- Do not use the projector near any appliance that generates a strong magnetic field.
- Do not place the projector in direct sunlight.
- Do not look into the lens while the projector is on; the bright light may hurt your eyes.
- To reduce the risk of fire or electric shock, do not expose the projector to rain or moisture.
- To prevent electric shock, do not open or disassemble the projector further than what is needed for lamp replacement.
- To avoid damaging the projector, ensure that the zoom lens is fully retracted before moving the projector or placing the projector in its carrying case.
- Turn off the projector and disconnect it from the electrical outlet before cleaning it. Use a soft cloth moistened with mild detergent to clean the display housing. Do not use abrasive cleaners, waxes, or solvents.

[Back to Contents Page](#)

About Your Projector: Dell™ 3100MP Projector

- [Features](#)
- [Equipment](#)
- [Panel Control](#)
- [Main Unit](#)
- [Connection Ports](#)
- [Remote Control With Mouse Function and Laser Pointer](#)

Features

- ❑ Single chip 0.7" Texas Instruments DLP™ technology
- ❑ True XGA, 1024 x 768 addressable pixels
- ❑ 3.5 lb (1.6 kg) lightweight compact design
- ❑ 1000 ANSI lumens brightness
- ❑ Auto image re-sizing to 1024 x 768 full screen with scaling compression compatibility for UXGA, SXGA+, XGA, SVGA, VGA, MAC, and SXGA
- ❑ 130-watt, user-replaceable P-VIP lamp
- ❑ Compatibility with Macintosh® computers
- ❑ Compatibility with NTSC, NTSC4.43, PAL, PAL-M, PAL-N, SECAM, and HDTV (1080i, 720P, 576P, 480i/P)
- ❑ Remote control with mouse function and laser pointer
- ❑ DVI-I connection for digital and analog video connectivity
- ❑ High-definition TV compatibility
- ❑ User-friendly, multilanguage on-screen display (OSD)
- ❑ Advanced electronic keystone correction
- ❑ User-friendly control panel with backlight
- ❑ Carrying case included

Equipment

Your projector comes with all the items shown below. Ensure that you have all the items, and [contact Dell](#) if anything is missing.

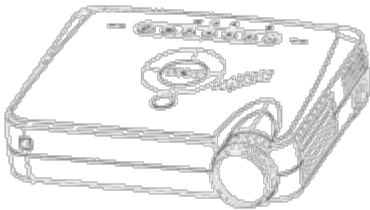

main unit

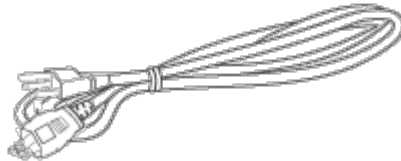

power cord

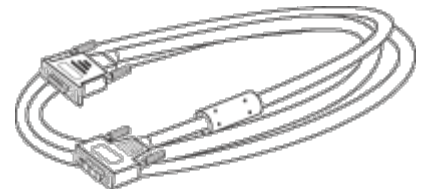

D-sub to DVI-I signal cable



S-video cable

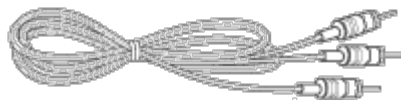

RCA audio cable



composite video cable

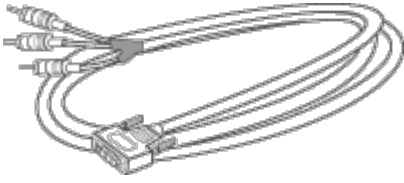

DVI-I signal cable for HDTV/component

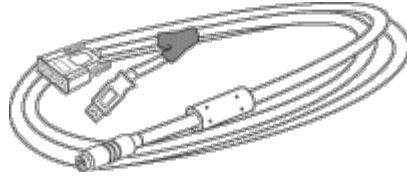

remote mouse Y-cable



remote control with mouse function and laser pointer

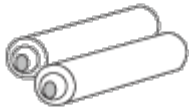

batteries (2)



Dell 3100MP Projector User's Guide

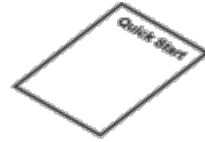

Dell 3100MP Projector Quick Start Card

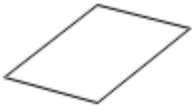

Dell 3100MP Projector Safety and Warranty Guide



carrying case

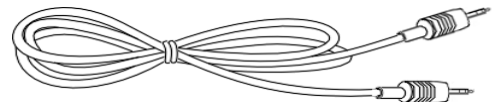

mini pin to mini pin cable

Panel Control

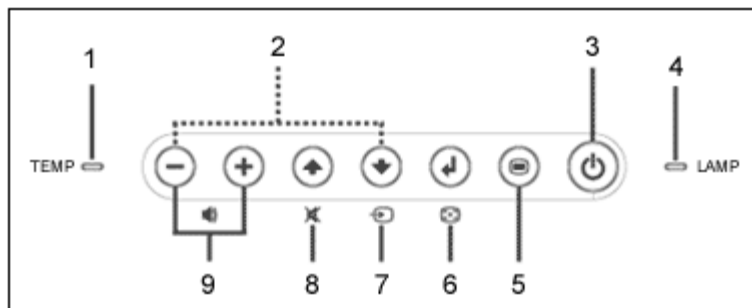

1	temperature warning light
2	four directional keys
3	power button
4	lamp warning light
5	Menu

6	Enter
7	Source
8	Mute
9	Volume

Main Unit

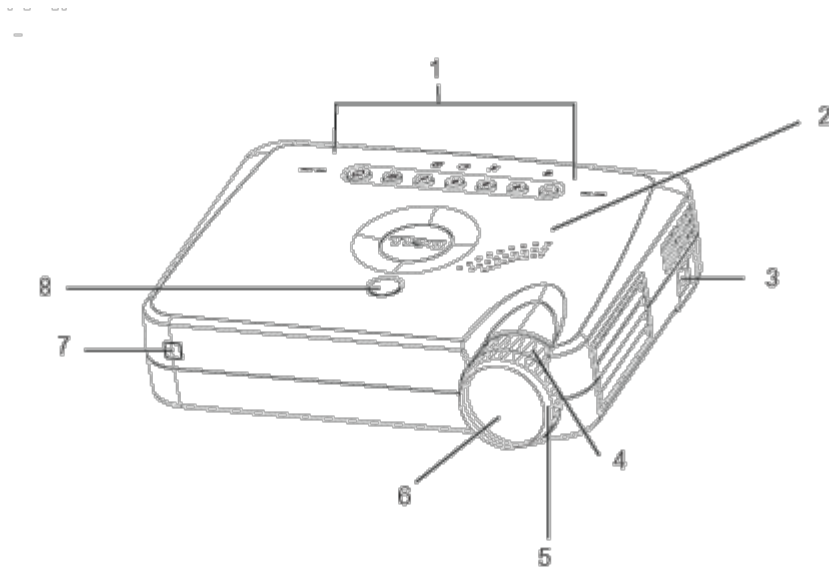

1	panel control
2	speaker
3	power connector
4	zoom ring
5	focus ring
6	zoom lens
7	remote control receiver
8	elevator button

Connection Ports

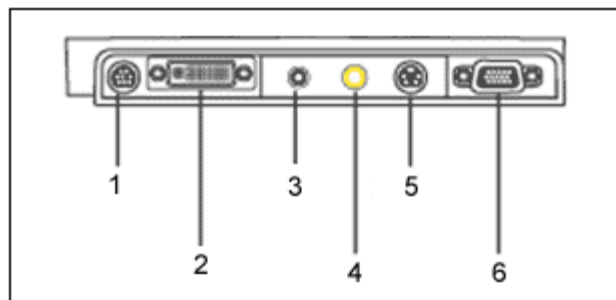

1	remote-mouse input connector
---	------------------------------

2	HDTV/component video and computer input connector
3	audio input connector
4	composite video connector
5	S-video connector
6	monitor loop-through connector

Remote Control With Mouse Function and Laser Pointer

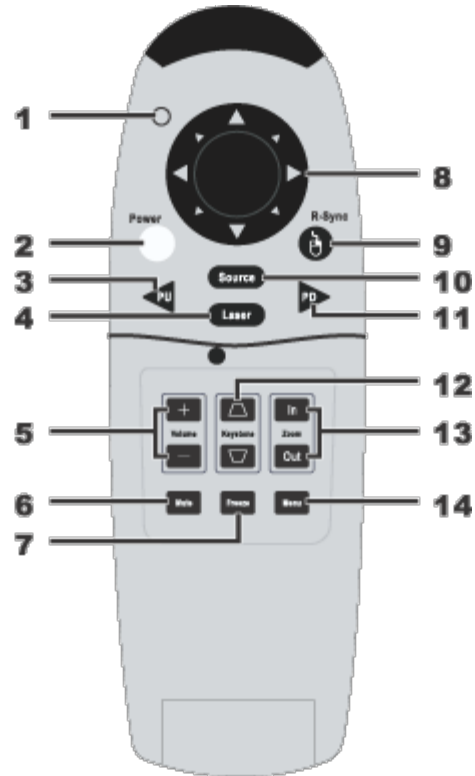

1	light
2	Power button
3	PU button (page up)
4	laser pointer
5	volume controls
6	Mute button
7	Freeze button
8	directional pad
9	R-Sync button
10	Source button
11	PD button (page down)
12	keystone correction
13	zoom in/zoom out
14	Menu button



CAUTION: The remote control has a Class II laser that emits radiation. To reduce the risk of injury to the eyes, do not look directly into the laser light on the remote control and do not point the laser light into anyone's eyes.



Battery Disposal: Your projector remote control uses zinc-manganese batteries. If you need to replace the batteries, see your *Dell 3100MP Projector Quick Start Card*.

Do not dispose of used batteries along with household waste. Contact your local waste disposal agency for the address of the nearest battery deposit site.

[Back to Contents Page](#)

Installation: Dell™ 3100MP Projector

- [Connecting the Projector](#)
- [Powering On/Off the Projector](#)
- [Adjusting the Projected Image](#)
- [Changing the Lamp](#)

Connecting the Projector

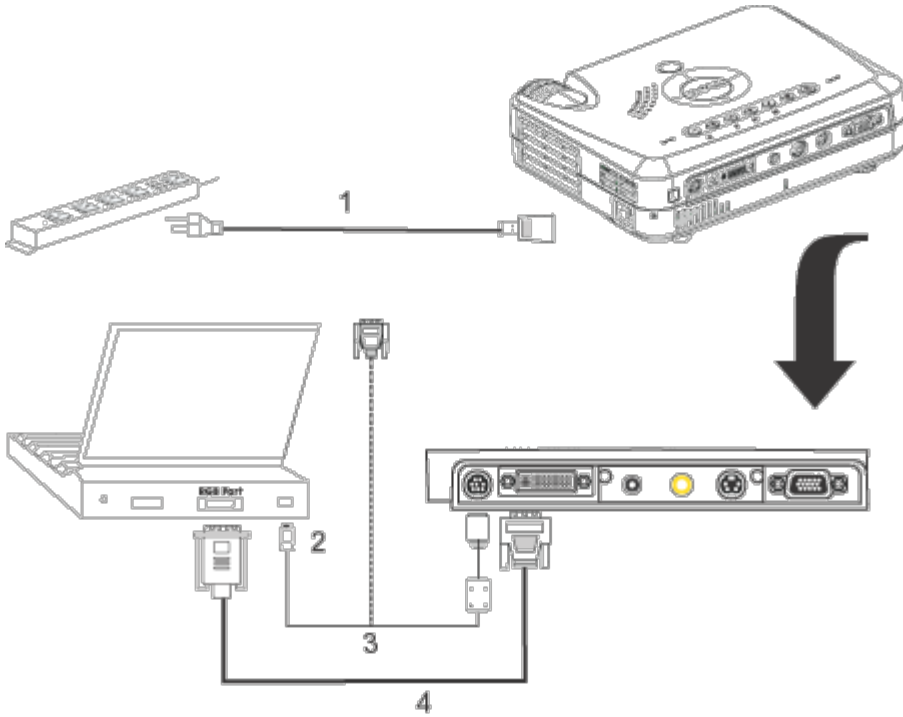

1	power cord
2	USB
3	remote mouse Y-cable
4	D-sub to DVI-I cable

Powering On/Off the Projector

Powering On the Projector

 NOTE: Turn on the projector before you turn on the source.

1. Remove the lens cap.
 2. Ensure that the power cord and D-sub to DVI-I cable are securely connected. The power button light blinks green.
 3. Press the power button to turn on the projector. After approximately 5 seconds, the startup screen appears, and the LAMP light blinks orange. After 20 seconds, the LAMP light stops blinking orange.
 4. Turn on your source (computer, notebook, VCR, and so on). The projector automatically detects your source.
- If the No Signal - check video cable message appears on the screen, ensure that the D-sub to DVI-I cable is securely connected.
 - If you are connecting multiple sources to the projector simultaneously, press the Source button on the [remote control](#) or [panel control](#) to select the desired source.

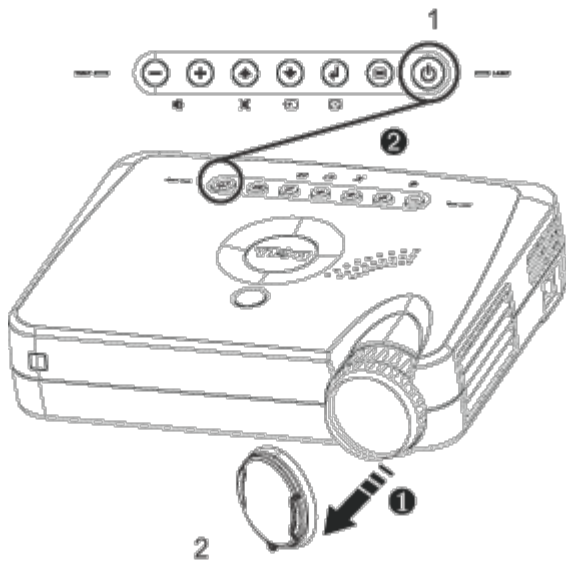

1	power button
2	lens cap

Powering Off the Projector

1. Press the power button to turn off the projector. The `Power off the lamp?` message appears on the OSD.
2. Press the power button again. The cooling fans continue to operate for about 30 seconds.
3. Disconnect the power cord from the electrical outlet and the projector.
4. If the LAMP light is solid orange, replace the lamp.
5. If the TEMP light is solid orange, the projector has overheated. The display automatically shuts down. Try turning the display on again after the projector cools down. If the problem persists, [contact Dell](#).
6. If you press the power button while the projector is running, the `Power off the lamp?` message appears on the screen. To clear the message, press any button on the panel control or ignore the message; the message disappears after 5 seconds.

Adjusting the Projected Image

Adjusting the Projector Height

To raise the projector:

1. Press the elevator button.
2. Raise the projector to the desired display angle, and then release the button to lock the elevator foot into position.
3. Use the tilt adjustment wheel to fine-tune the display angle.

To lower the projector:

1. Press the elevator button.
2. Lower the projector, and then release the button to lock the elevator foot into position.

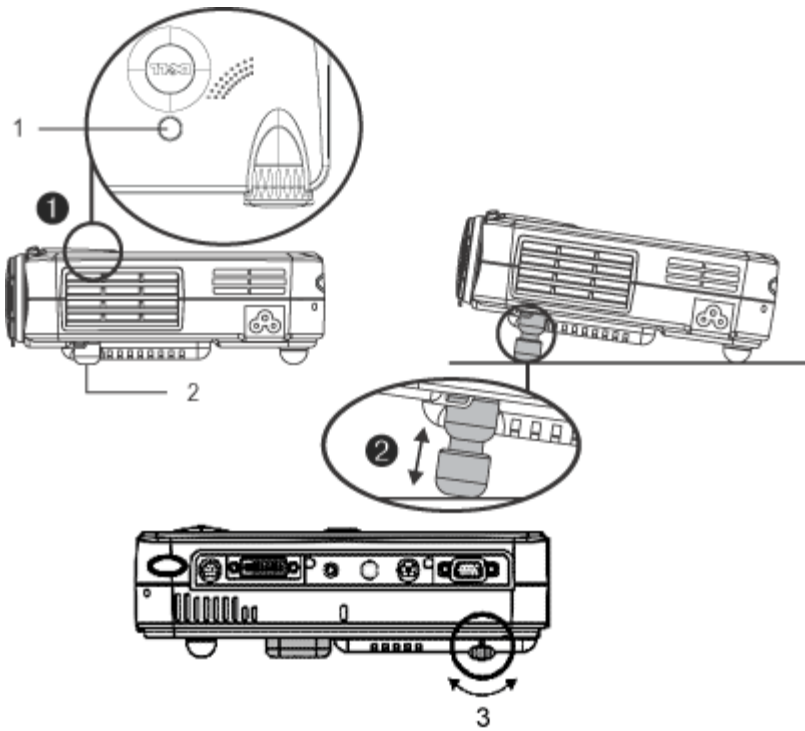

1	elevator button
2	elevator foot
3	tilt adjustment wheel

Adjusting the Projector Zoom and Focus

! CAUTION: To avoid damaging the projector, ensure that the zoom lens is fully retracted before moving the projector or placing the projector in its carrying case.

1. Rotate the zoom ring to zoom in and out.
2. Rotate the focus ring until the image is clear. The projector focuses at distances from 3.3 ft to 39.4 ft (1 m to 12 m).

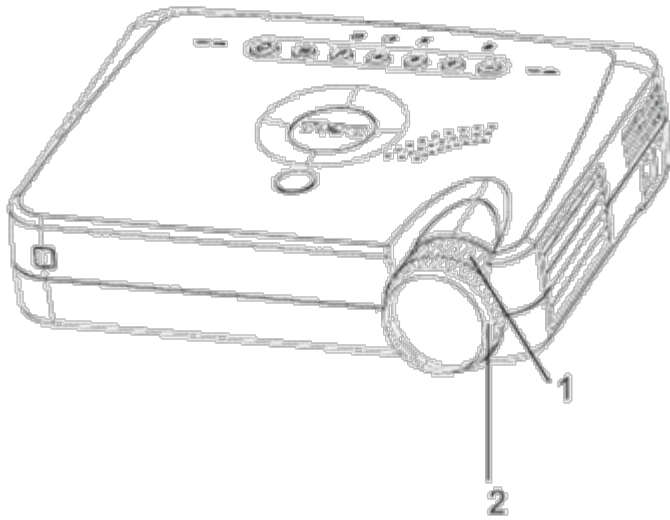

1	zoom ring
2	focus ring

Adjusting Projection Image Size

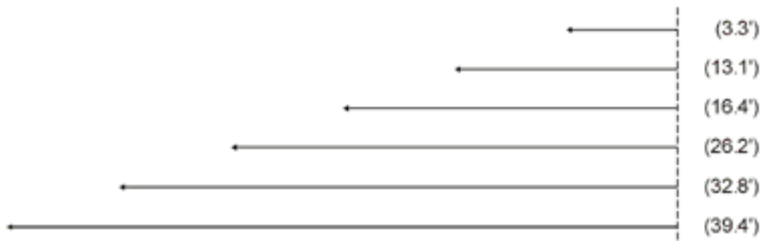
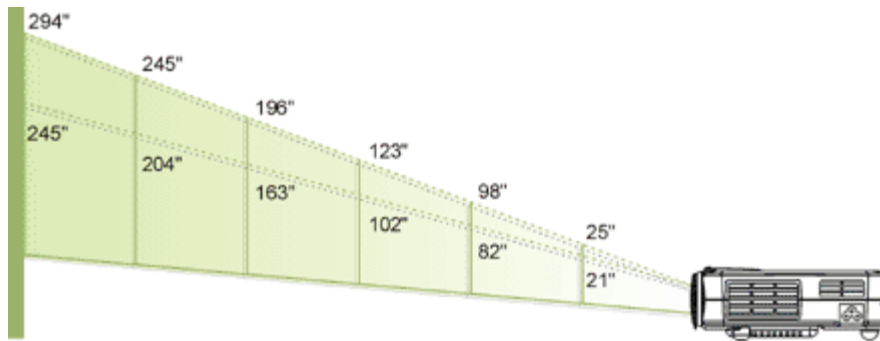

Screen (Diagonal)	Max.	25"	98"	123"	196"	245"	294"
	Min.	21"	82"	102"	163"	204"	245"
Screen Size	Max. (WXH)	20.0"X15.0"	78.4"X58.8"	98.4"X73.8"	156.8"X117.6"	196"X147"	235.2"X176.4"
	Min. (WXH)	16.8"X12.6"	65.6"X49.2"	81.6"X61.2"	130.4"X97.8"	163.2"X122.4"	196.0"X147.0"
Distance		3.3'	13.1'	16.4'	26.2'	32.8'	39.4'

* This graph is for user reference only.

Changing the Lamp

Replace the lamp when you see the `Lamp may fail soon! Replacement suggested!` message on the screen by carefully following these instructions.

 **CAUTION:** The lamp becomes very hot with use. Do not attempt to replace the lamp after use until the projector has been allowed to cool down for at least 30 minutes.

Lamp Changing Procedure:

1. Turn off the projector and disconnect the power cord.
2. Let the projector cool for at least 30 minutes.
3. Remove the two screws that secure the lamp cover, and remove the cover.
4. Remove the three screws that secure the lamp.
5. Pull up the lamp by its metal handle.
6. Reverse steps 1 through 5 to install the new lamp.
7. Reset the lamp by selecting the left Lamp Reset icon in the OSD [Management](#) tab.
8. Dell may require that lamps replaced under warranty are returned to Dell. Otherwise, contact your local waste disposal agency for the address of the nearest deposit site

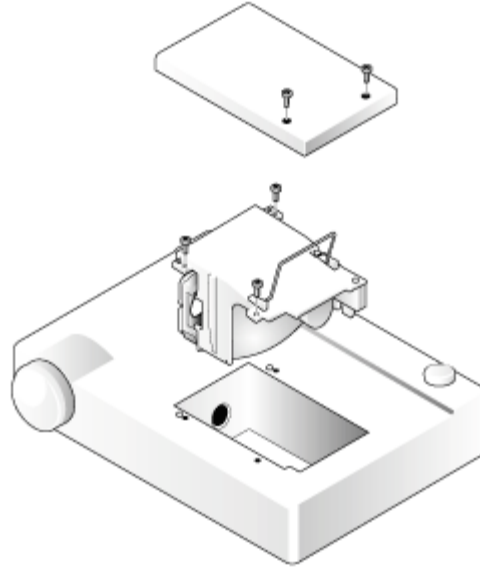

 **CAUTION:** Do not touch the bulb or the lamp glass at any time. The bulb may explode due to improper handling, including the touching of the bulb or the lamp glass.

[Back to Contents Page](#)

Using Your Projector: Dell™ 3100MP Projector

- [Panel Control](#)
 - [Remote Control](#)
 - [On-Screen Display](#)
-

Panel Control



Power

See "[Powering On/Off the Projector.](#)"

Source

Press  to choose RGB, Digital RGB, S-video, and composite sources.

R-Sync (Resync)





Press  to synchronize the projector to the input source.

R-Sync will not operate if the [OSD](#) is displayed.

Menu

Press  to activate the [OSD](#). Press  and  to navigate through the menu tabs.

Four Directional Keys

The four directional keys     can be used to toggle through the tabs in the [OSD](#).

Mute

Press  to mute and unmute the projector speaker.

Volume + / -

Increases/decreases projector speaker volume.

Keystone

Adjusts image distortion caused by tilting the projector. (± 16 degrees)

Enter

To confirm your selection, press  while the [OSD](#) is on the screen.

Remote Control

- If the remote control cover is closed:
The R-Sync button functions as the right mouse button.

The Enter button functions as the left mouse button.

- If the remote control cover is open, use the directional pad to navigate through the [OSD](#) tabs.

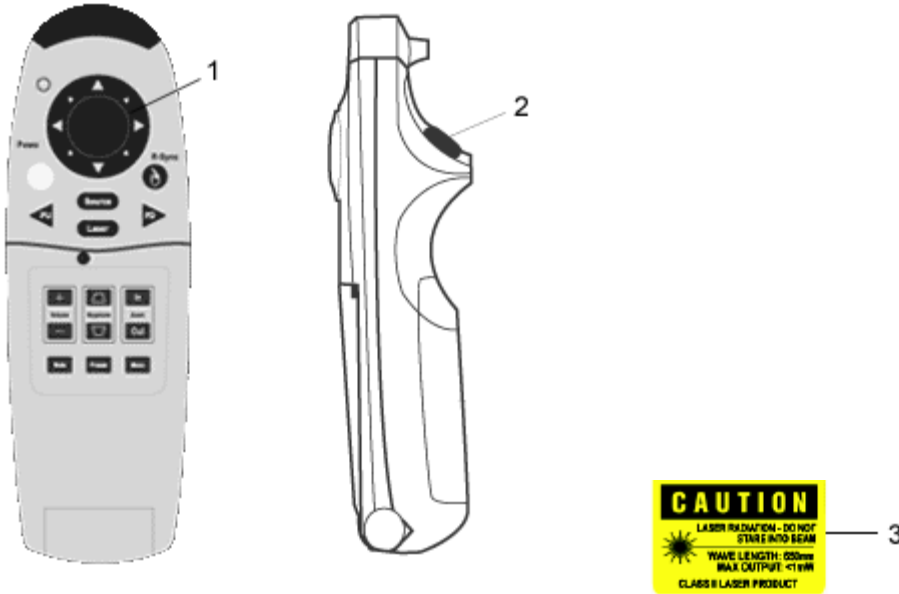

1	directional pad
2	Enter button
3	laser radiation caution

Power

See "[Power On/Off the Projector.](#)"

Source

Press the Source button to choose RGB, Digital RGB, S-video, and composite sources.

R-Sync

If the remote control cover is open, the R-Sync button synchronizes the projector to the input source.
If the remote control cover is closed, the R-Sync button functions as the right mouse button.

Directional Pad

The directional pad can be used to control mouse movement when the remote control cover is closed. The mouse function is enabled using the remote mouse Y-cable connection between your computer and the projector.

Laser

Aim the remote control at the screen, and press and hold the Laser button to activate the laser light.

Page Up

Press the PU button to page up.

Page Down

Press the PD button to page down.

Menu

Press the Menu button to activate the OSD. Use the directional pad and Enter button to navigate through the [OSD](#).

Zoom In/Out (Computer Mode Only)

Press the In button to digitally magnify an image up to 32 times on the screen. Press the Out button to reduce the zoomed image.

This function cannot be used with SXGA+ and UXGA.

Freeze

Press the Freeze button to temporarily stop video motion. Press the button again to resume video motion.

Mute

Press the Mute button to mute or unmute the projector speaker.

Volume

Increases/decrease the speaker volume.







Keystone

Adjusts image distortion caused by tilting the projector. (± 16 degrees)

Enter

Activates the left mouse button when the remote control cover is closed.

On-Screen Display

- The projector has a multilanguage OSD that can only be displayed when the projector is accepting an input source.
- The OSD allows you to make image adjustments and change a variety of settings. If the source is a computer, the OSD shows the computer OSD. When using a video source, the OSD shows the video OSD. The projector automatically detects the source.
- When the OSD is on the screen, press  or  to navigate through the OSD tabs.
Example: Image-I--> Image-II--> Audio--> Language--> Management--> Image-I. To make a selection in a tab, press .
- Press  or  to make a selection and adjust the settings by pressing  or . When an item is selected, the color of the item changes from yellowish brown to blue.

Example: Brightness--> Color Temp.--> Zoom--> Contrast--> Keystone--> Brightness
- To exit the OSD, press .

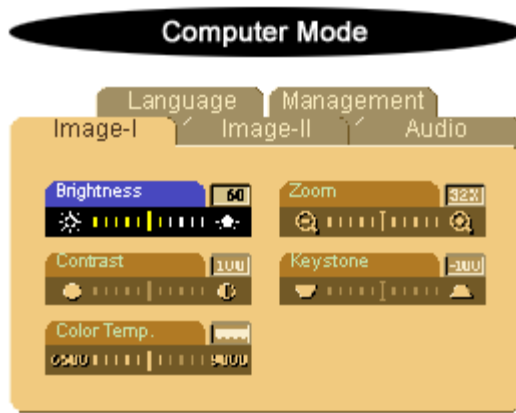

Image-I (Computer Mode)

Brightness

Adjusts the brightness of the image.

- Press **-** to darken the image.
- Press **+** to lighten the image.

Contrast

Controls the degree of difference between the lightest and darkest parts of the picture. Adjusting the contrast changes the amount of black and white in the image.

- Press **-** to decrease the contrast.
- Press **+** to increase the contrast.

Color Temp.

Adjusts the color temperature. The range is from 6500K to 9000K, and the default is 7050K. With the higher temperature, the screen looks colder; with the lower temperature, the screen looks warmer.

Zoom

- Press **+** to digitally magnify an image up to 32 times on the projection screen.
- Press **-** to reduce the zoomed image.

Keystone (Keystone Correction)

Adjusts image distortion caused by tilting the projector. (± 16 degrees)

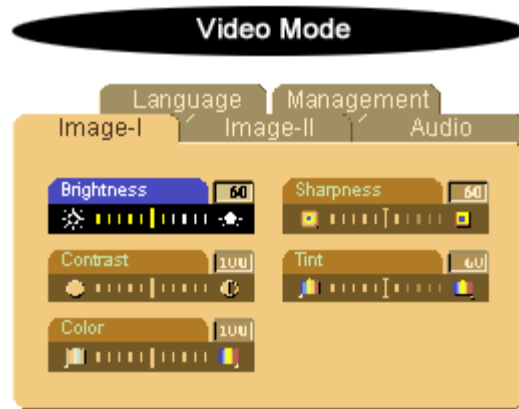

Image-I (Video Mode)

Brightness

Adjusts the brightness of the image.

- Press **(-)** to darken the image.
- Press **(+)** to lighten the image.

Contrast

Controls the degree of difference between the lightest and darkest parts of the picture. Adjusting the contrast changes the amount of black and white in the image.

- Press **(-)** to decrease the contrast.
- Press **(+)** to increase the contrast.

Color

Adjusts a video image from black and white to fully saturated color.

- Press **(-)** to decrease the amount of color in the image.
- Press **(+)** to increase the amount of color in the image.

Sharpness

Adjusts the sharpness of the image.

- Press **(-)** to decrease the sharpness.
- Press **(+)** to increase the sharpness.

Tint

Adjusts the color balance of red and green.

- Press **(-)** to increase the amount of green in the image.
- Press **(+)** to increase the amount of red in the image.

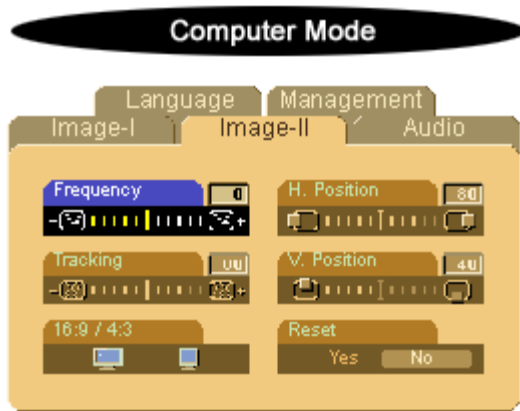

Image-II (Computer Mode)

Frequency

Changes the display data frequency to match the frequency of your computer graphic card. If you experience a vertical flickering bar, use the frequency function to make an adjustment.



Tracking

Synchronizes the signal timing of the display with that of the graphic card. If you experience an unstable or flickering image, use the tracking function to correct it.



16 : 9 / 4 : 3

Select this function to fit your desired aspect ratio type.

Horizontal Position

- Press  to move the image left.
- Press  to move the image right.

Vertical Position

- Press  to move the image down.
- Press  to move the image up.

Reset

Select Yes to reset the display to its factory default settings. Reset items include both Image-I and Image-II settings.

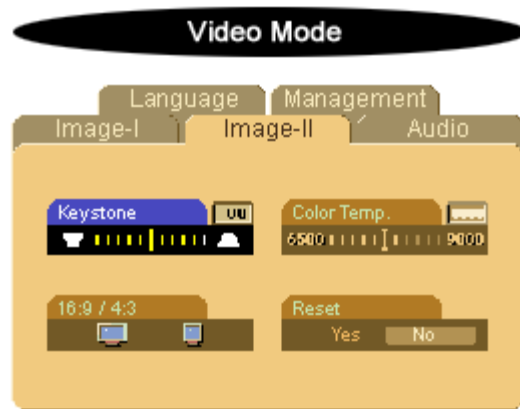

Image-II (Video Mode)

Keystone Correction

Adjusts image distortion caused by tilting the projector. (± 16 degrees)

16 : 9 / 4 : 3

Select this function to fit your desired aspect ratio type.

Color Temp.

Adjusts the color temperature setting. The range is from 6500K to 9000K, and the default is 7050K. With the higher temperature settings, the screen looks colder; with the lower temperature, the screen looks warmer.

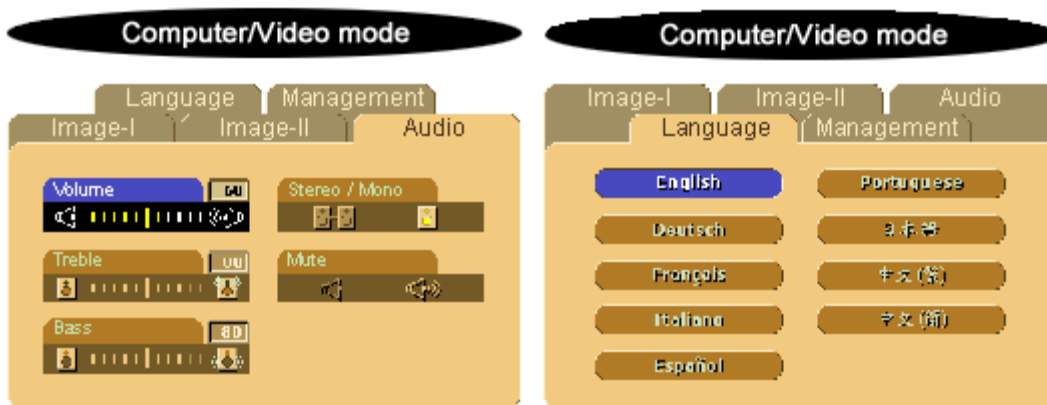

Reset

Select Yes to reset the display to its factory default settings. Reset items include both Image-I and Image-II settings.





Audio

Volume

- Press  to decrease the volume.
- Press  to increase the volume.



Treble

Controls the higher frequencies of your audio source.



- Press  to decrease the treble.
- Press  to increase the treble.

Bass

Controls the lower frequencies of your audio source.

- Press  to decrease the bass.
- Press  to increase the bass.

Stereo / Mono



- Mono : Mono sound effect.
- Stereo : Stereo sound effect.

Mute

- Select the left icon to mute the volume.
- Select the right icon to unmute the volume.

Language

Language

Press  or  to select the language you prefer.

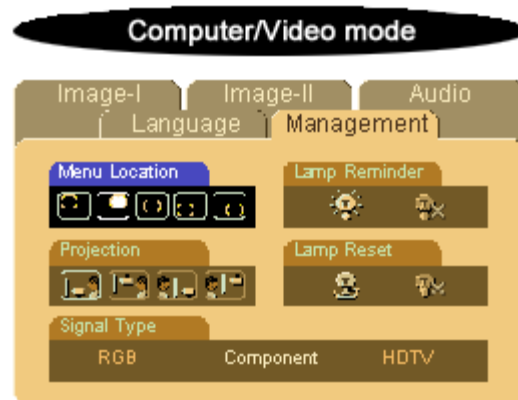



Management

Menu Location

Selects the location of the OSD on the screen.

Projection

-  Front-Desktop
The default setting.
-  Rear-Desktop
The projector reverses the image so you can project from behind a translucent screen.
- Front-Ceiling



The projector turns the image upside down for ceiling-mounted projection.

-  Rear-Ceiling

The projector simultaneously reverses and turns the image upside down. You can project from behind a translucent screen with a ceiling-mounted projection.

Signal Type

Select signal type from RGB, HDTV, and component video sources.

Lamp Reminder

The `Lamp may fail soon! Replacement suggested!` message appears on the screen 30 hours before the end of lamp life. Use this function to show or hide the message.

Lamp Reset

Use this function only after a new lamp is installed in the projector. Select the left Lamp Reset icon (light bulb and arrow under the icon), and press the Enter button to accept the new lamp.



[Back to Contents Page](#)

Troubleshooting: Dell™ 3100MP Projector

- [No image appears on the screen](#)
- [Partial, scrolling, or incorrectly displayed image](#)
- [The screen does not display your presentation](#)
- [Image is unstable or flickering](#)
- [Image has vertical flickering bar](#)
- [Image is out of focus](#)
- [The screen is outstretched when displaying 16:9 DVD](#)
- [Image is reversed](#)
- [Lamp burns out or makes a popping sound](#)

If you experience problems with your projector, see the following troubleshooting tips. If the problem persists, [contact Dell](#).



No image appears on the screen

- If you are using a portable computer, press  .
- Ensure that all the cables are correctly and securely connected as described in "[Connecting the Projector](#)."
- Ensure that the pins of the connectors are not bent or broken.
- Ensure that the lamp is securely installed (see "[Changing the Lamp](#)").
- Ensure that the lens cap is removed and the projector is turned on.

Partial, scrolling, or incorrectly displayed image

- Press the R-Sync button on the [remote control](#) or the [panel control](#).
- If you are using a desktop computer and the resolution of your computer is set higher than 1024 x 768, follow the steps below to reset the resolution.
- For Microsoft® Windows® 95, Windows 98, Windows 2000, and Windows XP:
 1. Open the Control Panel, and then double click Display.
 2. Click the Settings tab.
 3. Verify that the resolution setting in Desktop Area is less than or equal to 1024 x 768 resolution.

If the projector still does not display the image correctly, change the monitor display:
Follow steps 1 and 2. Click Advanced Properties.

4. Click the Change button in the Monitor tab.
 5. Click Show all devices. Then click Standard monitor types in the Manufacturer box; click to select the resolution mode you need in the Models box.
 6. Verify that the resolution setting of the monitor display is less than or equal to 1024 x 768.
- If you are using a portable computer:
 1. Set the resolution of the computer.
 2. Press  .
 - If you experience difficulty in changing resolutions or your monitor freezes, restart all the equipment and the projector.

The screen does not display your presentation



- If you are using a portable computer, press  .

Image is unstable or flickering

- Adjust the tracking in the OSD Image-II tab.
- Change the monitor color setting on your computer.

Image has vertical flickering bar

- Adjust the frequency in the OSD Image-II tab.
- Check and reconfigure the display mode of your graphic card to make it compatible with the projector.

Image is out of focus

- Adjust the focus ring on the projector lens.
- Ensure that the projection screen is within the required distance from the projector (3.3ft [1m] to 39.4ft [12m]).

The screen is outstretched when displaying 16:9 DVD

The projector automatically detects 16:9 DVD and adjusts the aspect ratio by digitization to full screen with a 4:3 default setting.

If the projector is still outstretched, adjust the aspect ratio as follows:

- If you are playing a 16:9 DVD, select 4:3 aspect ratio type on your DVD player.
- If you cannot select 4:3 aspect ratio type on your DVD player, select 4:3 OSD function.

Image is reversed

- Select [Management](#) from the OSD.

Lamp burns out or makes a popping sound

- When the lamp reaches its end of life, it will burn out and may make a loud popping sound. If this occurs, the projector will not turn back on until the lamp is replaced. To replace the lamp, see "[Changing the Lamp](#)".

[Back to Contents Page](#)

Specifications: Dell™ 3100MP Projector

Light Valve	single-chip DLP™ technology
Contrast Ratio	280:1 (Full On/Full Off)
Lamp	130-watt, user-replaceable P-VIP lamp
Number of Pixels	1024 x 768
Displayable Color	16.7M colors
Projection Lens	F/2.21–2.47, f=28.55–34.28 mm with 1.2x manual zoom lens
Projection Screen Size	21–294 inches (diagonal)
Projection Distance	3.3–39.4 ft (1m–12m)
Video Compatibility	NTSC, NTSC 4.43, PAL, PAL-M, PAL-N, SECAM, and HDTV (1080i, 720P, 576P, 480i/P)-compatibility
H. Frequency	15kHz–100kHz horizontal scan
V. Frequency	43Hz–120Hz vertical refresh
Multimedia Audio	one internal speaker with 2-watt output
Power Supply	universal 100–240V AC 50–60 Hz
Power Consumption	180 watts at normal operation
I/O Connectors	power: AC power input socket
	computer input: one 30-pin DVI-I for analog/digital/component and HDTV signal
	computer output: one 15-pin D-sub
	video input: one composite video RCA and one S-Video
	audio input: one phone jack
	mouse input: one 8-pin connector for remote mouse (USB and RS232)
Weight	3.5 lb (1.6 kg)
Dimensions (W x H x D)	2.0 x 6.9 x 8.9 inches (52 x 176 x 225 mm)
Environmental	operating temperature: 10°C–40°C (50°F–104°F) humidity: 80% maximum
	storage temperature: –20°C to 60°C (–4°F to 140°F) humidity: 80% maximum
Safety Regulation	FCC, CE, VCCI, UL, cUL, TUV GS, ICES-003, MIC, BSMI, C-Tick, NEMKO, GOST, PCBC, CCIB, PSB, EK, EZU, IRAM, NOM

Compatibility Modes

Mode	Resolution	(ANALOG)		(DIGITAL)	
		V. Frequency (Hz)	H. Frequency (KHz)	V. Frequency (Hz)	H. Frequency (KHz)
VGA	640X350	70	31.5	70	31.5
VGA	640X350	85	37.9	85	37.9

VGA	640X400	85	37.9	85	37.9
VGA	640X480	60	31.5	60	31.5
VGA	640X480	72	37.9	72	37.9
VGA	640X480	75	37.5	75	37.5
VGA	640X480	85	43.3	85	43.3
VGA	720X400	70	31.5	70	31.5
VGA	720X400	85	37.9	85	37.9
SVGA	800X600	56	35.2	56	35.2
SVGA	800X600	60	37.9	60	37.9
SVGA	800X600	72	48.1	72	48.1
SVGA	800X600	75	46.9	75	46.9
SVGA	800X600	85	53.7	85	53.7
XGA	1024X768	43.4	35.5		
XGA	1024X768	60	48.4	60	48.4
XGA	1024X768	70	56.5	70	56.5
XGA	1024X768	75	60.0	75	60.0
XGA	1024X768	85	68.7	-	-
*SXGA	1280X1024	60	63.98	-	-
*SXGA	1280X1024	75	79.98	-	-
*SXGA	1280X1024	85	91.1	-	-
*SXGA+	1400X1050	60	63.98	-	-
*UXGA	1600X1200	60	75.0	-	-
MAC LC13*	640X480	66.66	34.98	-	-
MAC II 13*	640X480	66.68	35	-	-
MAC 16*	832X624	74.55	49.725	-	-
MAC 19*	1024X768	75	60.24	-	-
*MAC	1152X870	75.06	68.68	-	-
MAC G4	640X480	60	31.35	-	-
MAC G4	640X480	120	68.03	-	-
MAC G4	1024X768	120	97.09	-	-
IMAC DV	640X480	117	60	-	-
IMAC DV	800X600	95	60	-	-
IMAC DV	1024X768	75	60	-	-
IMAC DV	1152X870	75	68.49	-	-
IMAC DV	1280X960	75	75	-	-
IMAC DV	1280X1024	85	91.1	-	-

* Compression computer image.

Regulatory Notices: Dell™ 3100MP Projector

- [Federal Communications Commission \(FCC\) Notice \(U.S. Only\)](#)
 - [FCC Declaration of Conformity](#)
 - [CE Declaration of Conformity for a Class B Digital Device](#)
 - [Canadian Regulatory Information \(Canada Only\)](#)
 - [EN 55022 Compliance \(Czech Republic Only\)](#)
 - [VCCI Class 2 Notice \(Japan Only\)](#)
 - [MIC Notice \(South Korea Only\)](#)
 - [Polish Center for Testing and Certification Notice](#)
 - [NOM Information \(Mexico Only\)](#)
 - [BSMI Notice \(Taiwan Only\)](#)
 - [Regulatory Listing](#)
-

Federal Communications Commission (FCC) Notice (U.S. Only)

 NOTICE: This equipment has been tested and found to comply with the limits for a Class B digital device, pursuant to Part 15 of the FCC Rules. These limits are designed to provide reasonable protection against harmful interference in a residential installation. This equipment generates, uses, and can radiate radio frequency energy and, if not installed and used in accordance with the instructions, may cause harmful interference to radio communications. However, there is no guarantee that interference will not occur in a particular installation. If this equipment does cause harmful interference to radio or television reception, which can be determined by turning the equipment off and on, the user is encouraged to try to correct the interference by one or more of the following measures:

- Reorient or relocate receiving antenna.
- Increase the separation between the equipment and receiver.
- Connect the equipment into an outlet on a circuit different from that to which the receiver is connected.
- Consult the dealer or an experienced radio/TV technician for help.

This device complies with Part 15 of the FCC rules. Operation is subject to the following two conditions:

- This device may not cause harmful interference.
- This device must accept any interference received including interference that may cause undesired operation.

Instructions to Users: This equipment complies with the requirements of FCC (Federal Communication Commission) equipment provided that following conditions are met.

1. Power cable: Shielded power cable must be used.
2. Video inputs: The input signal amplitude must not exceed the specified level.

 NOTICE: Changes or modifications not expressly approved by the party responsible for compliance could void the user's authority to operate the equipment.

FCC Declaration of Conformity

According to 47 CFR, Part 15 of the FCC Rules

* For the following named product:

DLP Projector
3100MP/DELL CHC7229

* Manufactured at:

Coretronic Corporation

We hereby declare that this device complies with Part 15 of the FCC Rules.
Operation is subject to the following two conditions:

1. This device may not cause harmful interference, and
2. This device must accept any interference received,
including interference that may cause undesired operation.

* FCC Rules:

Tested to comply with FCC part 15, class B

* Test site at:

Advance Data Technology Corporation
No.81-1, Lu Liao Keng, 9 Ling, Wu Lung Tsung, Chiung Lin Hsiang, Hsin Chu
Hsien, Taiwan

Coretronic Corporation

* Responsible Party for
Product Compliance:

No 11, Li Hsing Rd, Scienced-Based Industrial Park, Hsinchu, Taiwan
Tel: 886-3-5772000 Fax: 886-3-5790066

* Manufacturer Information:

Coretronic Corporation
No 11, Li Hsing Rd, Scienced
based Industrial Park, Hsinchu,
300, Taiwan

RD Center
Technology Engineering
Associate Vice President

March 29, 2002

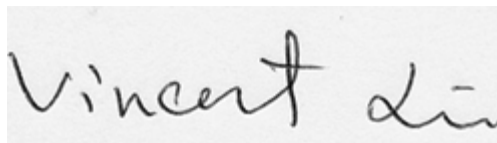

Hsinchu, March 29, 2002

Mr. Vincent Lin

CE Declaration of Conformity for a Class B Digital Device

Directives to which conformity is declared:

EMC Directives 89/336/EEC and Amending Directive 92/31/EEC

And

Low Voltage Directive 73/23/EEC

Standards to which conformity is declared

EN55022: 1998; EN55024: 1998; EN60950 +A1+A2+A3+A4: 1992;

EN61000-3-2: 1995; EN61000-3-3: 1995

Manufacturer's Name: Coretronic Corporation

Manufacturer's Address: No 11, Li Hsing Rd, Scienced-Based Industrial Park, Hsinchu, Taiwan

Importer's Address:

Dell Computer de Mexico,
Paseo de la Reforma 2620, 11th Floor
Col. Lomas Altas Dell Product
Mexico DF
CP 11950

Type of Equipment: DLP Projector

Model Number(s): 3100MP

Reference Report Number:

Previously Declared Models:

I, the undersigned, hereby declare that the equipment specified above conforms to the above Directive(s) and standards.

Hsinchu, Taiwan

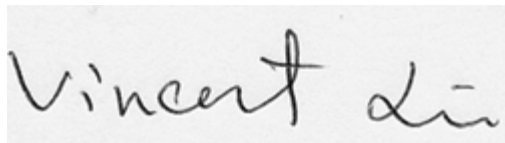

March 29, 2002

Mr. Vincent Lin

Head of RD Center

Canadian Regulatory Information (Canada Only)

This digital apparatus does not exceed the Class B limits for radio noise emissions from digital apparatus set out in the Radio Interference Regulations of the Canadian Department of Communications.

Note that Canadian Department of Communications (DOC) regulations provide, that changes or modifications not expressly approved by Dell Computer Corporation could void your authority to operate this equipment.

This Class B digital apparatus meets all requirements of the Canadian Interference-Causing Equipment Regulations.

Cet appareil numerique de la classe B respecte toutes les exigences du Reglement sur le materiel brouilleur du Canada.

EN 55022 Compliance (Czech Republic Only)

This device belongs to Class B devices as described in EN 55022, unless it is specifically stated that it is a Class A device on the specification label. The following applies to devices in Class A of EN 55022 (radius of protection up to 30 meters). The user of the device is obliged to take all steps necessary to remove sources of interference to telecommunication or other devices.

Pokud není na typovém štítku počítače uvedeno, že spadá do třídy A podle EN 55022, spadá automaticky do třídy B podle EN 55022. Pro zařízení zařazená do třídy A (ochranné pásmo 30m) podle EN 55022 platí následující. Dojde-li k rušení telekomunikačních nebo jiných zařízení, je uživatel povinen provést taková opatření, aby rušení odstranil.

VCCI Class 2 Notice (Japan Only)

This equipment complies with the limits for a Class 2 digital device (devices used in or adjacent to a residential environment) and conforms to the standards for information technology equipment that are set by the Voluntary Control Council for Interference for preventing radio frequency interference in residential areas.



Class B ITE

この装置は、情報処理装置等電波障害自主規制協議会 (VCCI) の基準に基づくクラス B 情報技術装置です。この装置は家庭環境で使用することを目的としていますが、ラジオやテレビジョン受信機に近接して使用されると、受信障害を引き起こすことがあります。取扱説明書に従って正しい取り扱いをしてください。

MIC Notice (South Korea Only)

B Class Device



1. 기기의 명칭(모델명) :
2. 인증번호 :
3. 인증받은 자의 상호 : (B)
4. 제조년월일:
5. 제조자/제조국가 :

기종별	사용자 안내문
B급 기기 (가정용 정보통신기기)	이 기기는 가정용으로 전자파적합등록을 한 기기로서 주거지역에서는 물론 모든 지역에서 사용할 수 있습니다.

Please note that this device has been approved for nonbusiness purposes and may be used in any environment, including residential areas.

Polish Center for Testing and Certification Notice

The equipment should draw power from a socket with an attached protection circuit (a three-prong socket). All equipment that works together (computer, monitor, printer, and so on) should have the same power supply source.

The phasing conductor of the room's electrical installation should have a reserve short-circuit protection device in the form of a fuse with a nominal value no larger than 16 amperes (A).

To completely switch off the equipment, the power supply cable must be removed from the power supply socket, which should be located near the equipment and easily accessible.

A protection mark "B" confirms that the equipment is in compliance with the protection usage requirements of standards PN-93/T-42107 and PN-89/E-06251.

Wymagania Polskiego Centrum Badań i Certyfikacji

Urządzenie powinno być zasilane z gniazda z przyłączonym obwodem ochronnym (gniazdo z kołkiem). Współpracujące ze sobą urządzenia (komputer, monitor, drukarka) powinny być zasilane z tego samego źródła.

Instalacja elektryczna pomieszczenia powinna zawierać w przewodzie fazowym rezerwową ochronę przed zwarciami, w postaci bezpiecznika o wartości znamionowej nie większej niż 16A (amperów).

W celu całkowitego wyłączenia urządzenia z sieci zasilania, należy wyjąć wtyczkę kabla zasilającego z gniazdka, które powinno znajdować się w pobliżu urządzenia i być łatwo dostępne.

Znak bezpieczeństwa "B" potwierdza zgodność urządzenia z wymaganiami bezpieczeństwa użytkowania zawartymi w PN-93/T-42107 i PN-EN 55022:1996.

Jeżeli na tabliczce znamionowej umieszczono informację, że urządzenie jest klasy A, to oznacza to, że urządzenie w środowisku mieszkalnym może powodować zakłócenia radioelektryczne. W takich przypadkach można żądać od jego użytkownika zastosowania odpowiednich środków zaradczych.

Pozostałe instrukcje bezpieczeństwa

- Nie należy używać wtyczek adapterowych lub usuwać kołka obwodu ochronnego z wtyczki. Jeżeli konieczne jest użycie przedłużacza to należy użyć przedłużacza 3-żyłowego z prawidłowo połączonym przewodem ochronnym.
- System komputerowy należy zabezpieczyć przed nagłymi, chwilowymi wzrostami lub spadkami napięcia, używając eliminatora przepięć, urządzenia dopasowującego lub bezzakłóceniowego źródła zasilania.
- Należy upewnić się, aby nic nie leżało na kablach systemu komputerowego, oraz aby kable nie były umieszczone w miejscu, gdzie można byłoby na nie nadeptywać lub potykać się o nie.
- Nie należy rozlewać napojów ani innych płynów na system komputerowy.
- Nie należy wpychać żadnych przedmiotów do otworów systemu komputerowego, gdyż może to spowodować pożar lub porażenie prądem, poprzez zwarcie elementów wewnętrznych.
- System komputerowy powinien znajdować się z dala od grzejników i źródeł ciepła. Ponadto, nie należy blokować otworów wentylacyjnych. Należy unikać kładzenia luźnych papierów pod komputer oraz umieszczania komputera w ciasnym miejscu bez możliwości cyrkulacji powietrza wokół niego.

NOM Information (Mexico Only)

The following information is provided on the device(s) described in this document in compliance with the requirements of the official Mexican standards (NOM)

Exporter: Dell Computer Corporation
One Dell Way
Round Rock, TX 78682

Importer: Dell Computer de México,
Paseo de la Reforma 2620, 11th Floor
Col. Lomas Altas
México DF
CP 11950

Ship to: Dell Computer de Mexico,
S.A. de C.V. al Cuidado de Kuehne & Nagel
de México S. de R.I., Avenida Soles No. 55
Col. Peñon de los Baños, 15520 Mexico, D.F.

Supply voltage: > 100–240 VAC
Frequency: 50–60 Hz
Current consumption: 1.2 A

BSMI Notice (Taiwan Only)

警告使用者：

這是甲類的資訊產品，在居住的環境中使用時，可能會造成射頻干擾，在這種情況下，使用者會被要求採取某些適當的對策。

Regulatory Listing

Safety Certifications:

- UL 1950
- cUL
- NOM
- CE Mark--EN60950: 1992 + A1 + A2 + A3
- NEMKO
- SEMKO
- DEMKO
- FIMKO
- EZU
- IEC 950
- TUV GS
- PCBC
- GOST
- CCIB
- EK
- PSB
- IRAM

EMC Certifications:

- FCC Part 15 Class B
 - CE Mark--EN55022:1998 Class B, EN61003-3:1995, EN55024:1998
 - ICES-003
 - EZU
 - NEMKO
 - SEMKO
 - DEMKO
 - FIMKO
 - PCBC
 - C-Tick
 - VCCI Class B ITE
 - MIC
 - BSMI
-

[Back to Contents Page](#)

Contacting Dell: Dell™ 3100MP Projector

- [Overview](#)
 - [International Dialing Codes](#)
 - [Americas Contact Numbers](#)
 - [Europe Contact Numbers](#)
 - [Asia and Other Regions Contact Numbers](#)
-

Overview

When you need to contact Dell, use the telephone numbers, codes, and electronic addresses provided in the following sections. "[International Dialing Codes](#)" provides the various codes required to make long-distance and international calls. "[Americas Contact Numbers](#)," "[Europe Contact Numbers](#)," and "[Asia and Other Regions Contact Numbers](#)" provide local telephone numbers, area codes, toll-free numbers, and e-mail addresses, if applicable, for each department or service available in various countries around the world.

If you are making a direct-dialed call to a location outside of your local telephone service area, determine which codes to use (if any) in "[International Dialing Codes](#)," in addition to the local numbers provided in the other sections.

For example, to place an international call from Paris, France, to Bracknell, England, dial the international access code for France followed by the country code for the U.K., the city code for Bracknell, and then the local number as shown in the following illustration:



To place a long-distance call within your own country, use area codes instead of international access codes, country codes, and city codes. For example, to call Paris, France, from Montpellier, France, dial the area code plus the local number as shown in the following illustration:



The codes required depend on where you are calling from as well as the destination of your call; in addition, each country has a different dialing protocol. If you need assistance in determining which codes to use, contact a local or an international operator.

-  **NOTES:** *Toll-free numbers are for use only within the country for which they are listed. Area codes are most often used to call long distance within your own country (not internationally)—in other words, when your call originates in the same country you are calling.*

Have your Express Service Code ready when you call. The code helps Dell's automated-support telephone system direct your call more efficiently.

International Dialing Codes

Click a listed country to obtain the appropriate contact numbers.

Country (City)	International Access Code	Country Code	City Code
Argentina (Buenos Aires)	00	54	11
Australia (Sydney)	0011	61	2
Austria (Vienna)	900	43	1
Belgium (Brussels)	00	32	2
Brazil	0021	55	51
Brunei	—	673	—
Canada (North York, Ontario)	011	—	Not required
Chile (Santiago)	—	56	2
China (Xiamen)	—	86	592
Czech Republic (Prague)	00	420	2
Denmark (Horsholm)	00	45	Not required
Finland (Helsinki)	990	358	9
France (Paris) (Montpellier)	00	33	(1) (4)
Germany (Langen)	00	49	6103
Hong Kong	001	852	Not required
Ireland (Cherrywood)	16	353	1
Italy (Milan)	00	39	02
Japan (Kawasaki)	001	81	44
Korea (Seoul)	001	82	2
Luxembourg	00	352	—
Macau	—	853	Not required
Malaysia (Penang)	00	60	4
Mexico (Colonia Granada)	00	52	Not required
Netherlands (Amsterdam)	00	31	20
New Zealand	00	64	—
Norway (Lysaker)	00	47	Not required
Poland (Warsaw)	011	48	22

Portugal	00	35	—
Singapore (Singapore)	005	65	Not required
South Africa (Johannesburg)	09/091	27	11
Spain (Madrid)	00	34	91
Sweden (Upplands Vasby)	00	46	8
Switzerland (Geneva)	00	41	22
Taiwan	002	886	—
Thailand	001	66	—
U.K. (Bracknell)	010	44	1344
U.S.A. (Austin, Texas)	011	1	Not required

Americas Contact Numbers

Country (City)	Department Name or Service	Area Code	Local Number or Toll-Free Number
Antigua and Barbuda	General Support		1-800-805-5924
Argentina (Buenos Aires)	Technical Support, Customer Care		toll free: 0800 444 0733
	Sales		toll free: 0810 444 3355
	Tech Support Fax	11	4515-7139
	Customer Care Fax	11	4515-7139
	Website: www.dell.com.ar		
Barbados	General Support		1-800-534-3066
Bermuda	General Support		1-800-342-0671
Brazil	Customer Support, Technical Support		toll free: 0800 90 3355
	Technical Support Fax	51	481-5470
	Customer Care Fax	51	481-5480

	Sales		toll free: 0800 90 3390
	Website: www.dell.com/br		
Canada (North York, Ontario)	Automated Order-Status System		toll free: 1-800-433-9014
	AutoTech (Automated technical support)		toll free: 1-800-247-9362
	Customer Care (From outside Toronto)		toll free: 1-800-387-5759
	Customer Care (From within Toronto)	416	758-2400
	Customer Technical Support		toll free: 1-800-847-4096
	Sales (Direct sales—from outside Toronto)		toll free: 1-800-387-5752
	Sales (Direct sales—from within Toronto)	416	758-2200
	Sales (Federal government, education, and medical)		toll free: 1-800-567-7542
	Sales (Major accounts)		toll free: 1-800-387-5755
	TechFax		toll free: 1-800-950-1329
Cayman Islands	General Support		1-800-805-7541
Chile (Santiago) <i>NOTE: Customers in Chile call the U.S.A. for sales, customer, and technical assistance</i>	Sales, Customer Support, and Technical Support		toll free: 1230-020-4823
Colombia	General Support		980-9-15-3978
Costa Rica	General Support		800-012-0435
Dominican Republic	General Support		1-800-148-0530

El Salvador	General Support		01-889-753-0777
Guatemala	General Support		1-800-999-0136
Jamaica	General Support		1-800-682-3639
Latin America <i>NOTE: Customers in Latin America call the U.S.A. for sales, customer, and technical assistance.</i>	Customer Technical Support (Austin, Texas, U.S.A.)	512	728-4093
	Customer Service (Austin, Texas, U.S.A.)	512	728-3619
	Fax (Technical Support and Customer Service) (Austin, Texas, U.S.A.)	512	728-3883
	Sales (Austin, Texas, U.S.A.)	512	728-4397
	SalesFax (Austin, Texas, U.S.A.)	512	728-4600 728-3772
Mexico	Customer Technical Support		001-877-384-8979 or 001-877-269-3383
	Sales		50-81-8800 or 01-800-888-3355
	Customer Service		001-877-384-8979 or 001-877-269-3383
	Main		50-81-8800 or 01-800-888-3355
Netherlands Antilles	General Support		001-800-882-15194
Nicaragua	General Support		001-800-220-1006

Panama	General Support		001-800-507-0962
Peru	General Support		0800-50-669
Puerto Rico	General Support		800-805-7545
St. Lucia	General Support		1-800-882-1521
Trinidad and Tobago	General Support		1-800-805-8035
U.S.A. (Austin, Texas)	Automated Order-Status System		toll free: 1-800-433-9014
	AutoTech (For portable and desktop computers)		toll free: 1-800-247-9362
	Dell Home and Small Business Group (For portable and desktop computers):		
	Customer Technical Support (Return Material Authorization Numbers)		toll free: 1-800-624-9896
	Customer Technical Support (Home sales purchased via www.dell.com)		toll free: 1-877-576-3355
	Customer Service (Credit Return Authorization Numbers)		toll free: 1-800-624-9897
	National Accounts (Systems purchased by established Dell national accounts [have your account number handy] or value-added resellers [VARs]):		
	Customer Service and Technical Support (Return Material Authorization Numbers)		toll free: 1-800-822-8965
	Public Americas (Systems purchased by governmental agencies [local, state, or federal], medical institutions, or educational institutions):		
	Customer Service and Technical Support		toll free: 1-800-234-1490

	(Return Material Authorization Numbers)		
	Dell Sales		toll free: 1-800-289-3355 toll free: 1-800-879-3355
	Spare Parts Sales		toll free: 1-800-357-3355
	Desktop and Portable Fee-Based Technical Support		toll free: 1-800-433-9005
	Sales (Catalogs)		toll free: 1-800-426-5150
	Fax		toll free: 1-800-727-8320
	TechFax		toll free: 1-800-950-1329
	Dell Services for the Deaf, Hard-of-Hearing, or Speech-Impaired		toll free: 1-877-DELLTTY (1-877-335-5889)
	Switchboard	512	338-4400
U.S. Virgin Islands	General Support		1-877-673-3355
Venezuela	General Support		8001-3605

Europe Contact Numbers

Country (City)	Department Name or Service	Area Code	Local Number or Toll-Free Number
Austria (Vienna) <i>NOTE: Customers in Austria call Langen, Germany for Technical Support and Customer Care.</i>	Switchboard	01	491 040
	Home/Small Business Sales	01	795676-02
	Home/Small Business Sales Fax	01	795676-05
	Home/Small Business Customer Care	01	795676-03
	Preferred Accounts/Corporate Customer		0660-8056

	Care		
	Home/Small Business Technical Support	01	795676-04
	Preferred Accounts/Corporate Technical Support		0660-8779
	Website: support.euro.dell.com		
	E-mail: tech_support_central_europe@dell.com		
Belgium (Brussels)	Technical Support	02	481 92 88
	Customer Care	02	481 91 19
	Home/Small Business Sales		toll free: 0800 16884
	Corporate Sales	02	481 91 00
	Fax	02	481 92 99
	Switchboard	02	481 91 00
	Website: support.euro.dell.com		
	E-mail: tech_be@dell.com		
	E-mail for French Speaking Customers: support.euro.dell.com/be/fr/emaildell/		
Czech Republic (Prague)	Technical Support	02	22 83 27 27
	Customer Care	02	22 83 27 11
	Fax	02	22 83 27 14
	TechFax	02	22 83 27 28
	Switchboard	02	22 83 27 11
	Website: support.euro.dell.com		
	E-mail: czech_dell@dell.com		
Denmark (Horsholm)	Technical Support		45170182
	Relational Customer Care		45170184
	Home/Small Business Customer Care		32875505
	Switchboard		45170100
	Fax Technical Support (Upplands Vasby, Sweden)	46	859005594
	Fax Switchboard		45170117
	Website: support.euro.dell.com		
<i>NOTE: Customers in Denmark call Sweden for fax technical support.</i>			

	E-mail: den_support@dell.com		
	E-mail Support for Servers: Nordic_server_support@dell.com		
Finland (Helsinki)	Technical Support	09	253 313 60
	Technical Support Fax	09	253 313 81
	Relational Customer Care	09	253 313 38
	Home/Small Business Customer Care	09	693 791 94
	Fax	09	253 313 99
	Switchboard	09	253 313 00
	Website: support.euro.dell.com		
	E-mail: fin_support@dell.com		
France (Paris) (Montpellier)	Home and Small Business		
	Technical Support	0825	387 270
	Customer Care	0825	823 833
	Fax	0825	004 701
	Fax (Alternative)	04	99 75 40 01
	Switchboard	0825	004 700
	Switchboard (Alternative)	04	99 75 40 00
	Sales	0825	004 700
	Website: support.euro.dell.com		
	E-mail: support.euro.dell.com/fr/fr/emaildell/		
	Corporate		
	Technical Support	0825	004 719
	Customer Care	0825	338 339
	Fax	01	55 94 71 01
	Switchboard	01	55 94 71 00
	Sales	01	55 94 71 00
	Website: support.euro.dell.com		
E-mail: support.euro.dell.com/fr/fr/emaildell/			
Germany (Langen)	Technical Support	06103	766-7200

	Home/Small Business Customer Care		0180-5-224400
	Global Segment Customer Care	06103	766-9570
	Preferred Accounts Customer Care	06103	766-9420
	Large Accounts Customer Care	06103	766-9560
	Public Accounts Customer Care	06103	766-9555
	Switchboard	06103	766-7000
	Website: support.euro.dell.com		
	E-mail: tech_support_central_europe@dell.com		
Ireland (Cherrywood)	Ireland Technical Support	1850	543 543
	UK Technical Support (dial number within UK only)	0870	908 0800
	Ireland Home User Customer Care	01	204 4095
	Ireland Small Business Customer Care	01	204 4444
	Ireland Corporate Customer Care	01	204 4003
	UK Customer Care (dial number within UK only)	0870	906 0010
	Ireland Sales	01	204 4444
	UK Sales (dial number within UK only)	0870	907 4000
	SalesFax	01	204 0144
	Ireland Fax	01	204 5960
	Switchboard	01	204 4444
	Website: support.euro.dell.com		
	E-mail: dell_direct_support@dell.com		
Italy (Milan)	Home and Small Business		
	Technical Support	02	577 826 90
	Customer Care	02	696 821 14
	Fax	02	696 821 13
	Switchboard	02	696 821 11
	Website: support.euro.dell.com		
	E-mail:		

	support.euro.dell.com/it/it/emaildell/		
	Corporate		
	Technical Support	02	577 826 90
	Customer Care	02	577 825 55
	Fax	02	035 30
	Switchboard	02	577 821
	Website: support.euro.dell.com		
	E-mail: support.euro.dell.com/it/it/emaildell/		
Luxembourg	Technical Support (Brussels, Belgium)	02	481 92 88
<i>NOTE: Customers in Luxembourg call Belgium for sales, customer, and technical assistance.</i>	Home/Small Business Sales (Brussels, Belgium)		toll free: 080016884
	Corporate Sales (Brussels, Belgium)	02	481 91 00
	Customer Care (Brussels, Belgium)	02	481 91 19
	Switchboard (Brussels, Belgium)	02	481 91 00
	Fax (Brussels, Belgium)	02	481 92 99
	Website: support.euro.dell.com		
	E-mail: tech_be@dell.com		
Netherlands (Amsterdam)	Technical Support	020	581 8838
	Customer Care	020	581 8740
	Home/Small Business Sales		toll free: 0800-0663
	Home/Small Business Sales Fax	020	682 7171
	Corporate Sales	020	581 8818
	Corporate Sales Fax	020	686 8003
	Fax	020	686 8003
	Switchboard	020	581 8818
	Website: support.euro.dell.com		
	E-mail: tech_nl@dell.com		
Norway (Lysaker)	Technical Support		671 16882
	Relational Customer Care		671 17514
<i>NOTE: Customers in Norway call Sweden for fax technical</i>	Home/Small Business Customer Care		231 62298

support.	Switchboard		671 16800
	Fax Technical Support (Upplands Vasby, Sweden)	00	46 08 590 05 594
	Fax Switchboard		671 16865
	Website: support.euro.dell.com		
	E-mail: nor_support@dell.com		
	E-mail Support for Servers: Nordic_server_support@dell.com		
Poland (Warsaw)	Customer Service Phone	22	57 95 700
	Customer Care	22	57 95 999
	Sales	22	57 95 999
	Switchboard	22	57 95 999
	Customer Service Fax	22	57 95 806
	Fax	22	57 95 998
	Website: support.euro.dell.com		
	E-mail: pl_support@dell.com		
Portugal	Technical Support	35	800 834 077
	Customer Care		800 300 415 or 800 834 075
	Sales		800 300 410 or 800 300 411 or 800 300 412 or 351 214 220 710
	Switchboard	34	917 229 200
	Fax	35	121 424 01 12
	E-mail: support.euro.dell.com/es/es/emaildell/		
Spain (Madrid)	Home and Small Business		
	Technical Support		902 100 130
	Customer Care		902 118 540
	Sales		902 118 541
	Fax		902 118 539
	Website: support.euro.dell.com		

	E-mail: support.euro.dell.com/es/es/emaildell/		
	Corporate		
	Technical Support		902 100 130
	Customer Care		902 118 546
	Switchboard	91	722 92 00
	Fax	91	722 95 83
	Website: support.euro.dell.com		
	E-mail: support.euro.dell.com/es/es/emaildell/		
Sweden (Upplands Vasby)	Technical Support	08	590 05 199
	Relational Customer Care	08	590 05 642
	Home/Small Business Customer Care	08	587 70 527
	Fax Technical Support	08	590 05 594
	Sales	08	590 05 185
	Website: support.euro.dell.com		
	E-mail: swe_support@dell.com		
Switzerland (Geneva)	Technical Support (Home and Small Business)		0844 811 411
	Technical Support (Corporate)		0844 822 844
	Customer Care (Home and Small Business)		0848 802 202
	Customer Service (Corporate)		0848 821 721
	Switchboard	022	799 01 01
	Fax	022	799 01 90
	Website: support.euro.dell.com		
	E-mail for French Speaking HSB and Corporate Customers: support.euro.dell.com/ch/fr/emaildell/		

U.K. (Bracknell)	Technical Support (Corporate/Preferred Accounts/PAD [1000+ employees])	0870	908 0500
	Technical Support (Direct/PAD and general)	0870	908 0800
	Global Accounts Customer Care	01344	373 186
	Corporate Customer Care	0870	908 0500
	Preferred Accounts (500–5000 employees) Customer Care	01344	373 196
	Central Government Customer Care	01344	373 193
	Local Government Customer Care	01344	373 199
	Home/Small Business Sales	0870	907 4000
	Home/Small Business Customer Care	0870	906 0010
	Corporate/Public Sector Sales	01344	860 456
	Website: support.euro.dell.com		
	E-mail: dell_direct_support@dell.com		

Asia and Other Regions Contact Numbers

Country (City)	Department Name or Service	Area Code	Local Number or Toll-Free Number
Australia (Sydney)	Home and Small Business		1-300-65-55-33
	Government and Business		toll free: 1-800-633-559
	Preferred Accounts Division (PAD)		toll free: 1-800-060-889
	Customer Care		toll free: 1-800-819-339
	Corporate Sales		toll free: 1-800-808-385
	Transaction Sales		toll free: 1-800-808-312
	Fax		toll free: 1-800-818-341
Brunei <i>NOTE: Customers in Brunei call Malaysia for customer assistance.</i>	Customer Technical Support (Penang, Malaysia)		633 4966
	Customer Service (Penang, Malaysia)		633 4949
	Transaction Sales (Penang, Malaysia)		633 4955
China (Xiamen)	Home and Small Business Technical Support		toll free: 800 858 2437

	Corporate Accounts Technical Support		toll free: 800 858 2333
	Customer Experience		toll free: 800 858 2060
	Home and Small Business		toll free: 800 858 2222
	Preferred Accounts Division		toll free: 800 858 2062
	Large Corporate Accounts North		toll free: 800 858 2999
	Large Corporate Accounts East		toll free: 800 858 2020
	Large Corporate Accounts South		toll free: 800 858 2355
	Large Corporate Accounts GCP		toll free: 800 858 2055
	Large Corporate Accounts HK		toll free: 800 964108
	Large Corporate Accounts GCP HK		toll free: 800 907308
Hong Kong	Technical Support		toll free: 800 96 4107
<i>NOTE: Customers in Hong Kong call Malaysia for customer assistance.</i>	Customer Service (Penang, Malaysia)		633 4949
	Transaction Sales		toll free: 800 96 4109
	Corporate Sales		toll free: 800 96 4108
India	Technical Support		1600-33-8045
	Sales		1600-33-8044
Japan (Kawasaki)	Technical Support	044	toll free: 0120-1982-26 or toll free: 0120-1984-33
	Technical Support Outside of Japan	044	520-1435 or 556-3894
	Customer Care	044	556-4240
	24-Hour Automated Order Status Service	044	556-3801
	Individual User	044	556-1657
	Business Sales Division (Up to 400 employees)	044	556-3494
	Public Sales (Government agencies, education institutions, and medical institutions)	044	556-3440
	Preferred Accounts Division Sales (Over 400 employees)	044	556-3433

	Global Segment Japan	044	556-3469
	Large Corporate Accounts Sales (Over 3500 employees)	044	556-3440
	Faxbox Service	044	556-3490
	Switchboard	044	556-4300
	Web site: support.jp.dell.com		
Korea (Seoul)	Technical Support		toll free: 080-200-3800
	Sales		toll free: 080-200-3600
	Customer Service (Penang, Malaysia)		toll free: 604-633-4949
	Customer Service (Seoul, Korea)		080-200-3800
	Fax		2194-6202
	Switchboard		2194-6000
Macau <i>NOTE: Customers in Macau call Malaysia for customer assistance.</i>	Technical Support		toll free: 0800 582
	Customer Service (Penang, Malaysia)		633 4949
	Transaction Sales		toll free: 0800 581
Malaysia (Penang)	Technical Support		toll free: 1 800 888 298
	Customer Service	04	633 4949
	Transaction Sales		toll free: 1 800 888 202
	Corporate Sales		toll free: 1 800 888 213
New Zealand	Home and Small Business		0800 446 255
	Government and Business		0800 444 617
	Sales		0800 441 567
	Fax		0800 441 566
Singapore (Singapore) <i>NOTE: Customers in Singapore call Malaysia for customer assistance.</i>	Technical Support		toll free: 800 6011 051
	Customer Service (Penang, Malaysia)	04	633 4949
	Transaction Sales		toll free: 800 6011 054
	Corporate Sales		toll free: 800 6011 053
South Africa (Johannesburg)	Technical Support	011	709 7710
	Customer Care	011	709 7707

	Sales	011	709 7700
	Fax	011	706 0495
	Switchboard	011	709 7700
	Website: support.euro.dell.com		
	E-mail: dell_za_support@dell.com		
Southeast Asian/Pacific Countries (excluding Australia, Brunei, China, Hong Kong, Japan, Korea, Macau, Malaysia, New Zealand, Singapore, Taiwan, and Thailand—refer to individual listings for these countries)	Customer Technical Support, Customer Service, and Sales (Penang, Malaysia)		60 4 633-4810
Taiwan	Technical Support		toll free: 0080 60 1225
	Technical Support (Servers)		toll free: 0080 60 1256
	Customer Service (Penang, Malaysia)		633 4949
	Transaction Sales		toll free: 0080 651 228/0800 33 556
	Corporate Sales		toll free: 0080 651 227/0800 33 555
Thailand <i>NOTE: Customers in Thailand call Malaysia for customer assistance.</i>	Technical Support		toll free: 088 006 007
	Customer Service (Penang, Malaysia)		633 4949
	Sales		toll free: 088 006 009

[Back to Contents Page](#)

Free Manuals Download Website

<http://myh66.com>

<http://usermanuals.us>

<http://www.somanuals.com>

<http://www.4manuals.cc>

<http://www.manual-lib.com>

<http://www.404manual.com>

<http://www.luxmanual.com>

<http://aubethermostatmanual.com>

Golf course search by state

<http://golfingnear.com>

Email search by domain

<http://emailbydomain.com>

Auto manuals search

<http://auto.somanuals.com>

TV manuals search

<http://tv.somanuals.com>