

Dell Projector 1220/1450

User's Guide



Notes, Cautions, and Warnings



NOTE: A NOTE indicates important information that helps you make better use of your projector



CAUTION: A CAUTION indicates potential damage to hardware or loss of data if instructions are not followed.



WARNING: A WARNING indicates a potential for property damage, personal injury, or death.

**Information in this document is subject to change without notice.
© 2015 Dell Inc. All rights reserved.**

Reproduction of these materials in any manner whatsoever without the written permission of Dell Inc. is strictly forbidden.

Trademarks used in this text: Dell and the DELL logo are trademarks of Dell Inc.; DLP and DLP logo are trademarks of TEXAS INSTRUMENTS INCORPORATED; Microsoft and Windows are either trademarks or registered trademarks of Microsoft Corporation in the United States and/or other countries.

Other trademarks and trade names may be used in this document to refer to either the entities claiming the marks and names or their products. Dell Inc. disclaims any proprietary interest in trademarks and trade names other than its own.

Model: Dell Projector 1220/1450

June 2015 Rev. A02

Contents

1	About Your Dell Projector	4
	Projector Box Contents	4
	Projector Top and Bottom View	5
	Projector Connections	6
2	Setting Up Your Projector	8
	Adjusting Projected Image	8
	Using Remote Control	13
	Connecting Projector	18
3	Using Your Projector	23
	Turning Projector On	23
	Turning Projector Off	23
	Menu Settings	24
4	Troubleshooting Your Projector	39
	Guiding Signals	43
	Changing the Lamp	44
5	Specifications	46
	Compatibility Modes (Analog/Digital)	49
6	Contacting Dell	51
7	Appendix: Glossary	52

1

About Your Dell Projector

Your projector comes with all the items shown below. Ensure that you have all the items, and contact Dell if anything is missing.

Projector Box Contents

1220/1450 Package Contents

Power cable

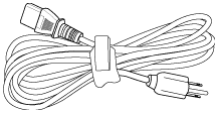

VGA cable (VGA to VGA)

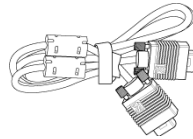

Remote control



AAA Batteries (2)



CD User's Guide and Documentation

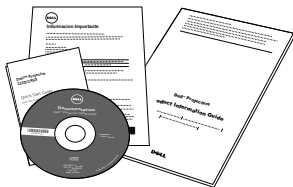

Projector Top and Bottom View

Top View

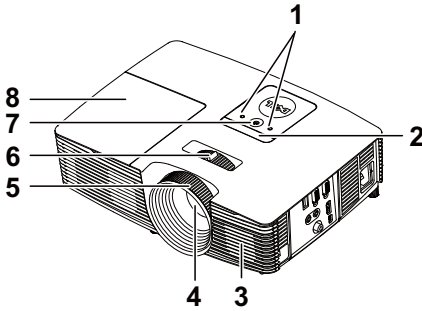

Bottom View

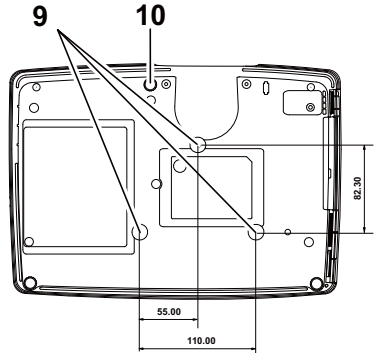

- | | |
|----|----------------------------------|
| 1 | Status indicators |
| 2 | IR receivers |
| 3 | 2W Speaker |
| 4 | Lens |
| 5 | Focus ring |
| 6 | Zoom tab |
| 7 | Power button |
| 8 | Lamp cover |
| 9 | Mounting holes for ceiling mount |
| 10 | Tilt adjustment wheel |



NOTE: Ceiling mount screw hole M3 x 6.5mm depth.
Recommended torque <15 kgf-cm.

Projector Connections

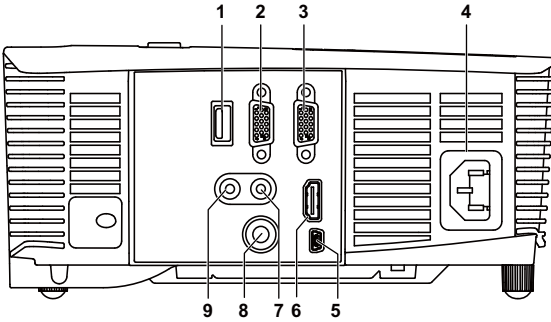

1 +5 V DC out connector	6 HDMI connector
2 VGA output (monitor loop through) connector	7 Audio input connector
3 VGA input (D-sub) connector	8 Composite Video connector
4 Power cord connector	9 Audio output connector
5 Mini USB (mini type B) connector for remote mouse and firmware upgrade	

CAUTION: Before you begin any of the procedures in this section, follow the Safety Instructions as described on page 7.

NOTE: 5 V DC out connector ONLY available in 1450 projector.

CAUTION: Safety Instructions

- 1 Do not use the projector near appliances that generate a lot of heat.
- 2 Do not use the projector in areas where there is an excessive amount of dust. The dust may cause the system to fail and the projector will automatically shutdown.
- 3 Ensure that the projector is mounted in a well-ventilated area.
- 4 Do not block the ventilation slots and openings on the projector.
- 5 Ensure the projector operates between ambient temperatures (5 °C to 40 °C).
- 6 Do not try to touch the ventilation outlet as it can become very hot after the projector has been turned on or immediately after it is turned off.
- 7 Do not look into the lens while the projector is on as it may cause injury to your eyes.
- 8 Do not place any objects near or in front of the projector or cover its lens while the projector is on as the heat may cause the object to melt or burn.
- 9 Do not use alcohol to wipe the lens.



NOTE:

- Do not attempt to ceiling mount the projector by yourself. It should be installed by a qualified technician.
- Recommended Projector Ceiling Mount Kit (P/N: C3505). For more information, see the Dell Support website at [dell.com/support](https://www.dell.com/support).
- For more information, see the Safety Information that shipped with your projector.
- The 1220/1450 projector can only be used indoors.

2

Setting Up Your Projector

Adjusting Projected Image

Raising the Projector Height

- 1 Raise the projector to the desired display angle, and use the front tilt adjustment wheel to fine-tune the display angle.
- 2 Use the tilt adjustment wheels to fine-tune the display angle.

Lowering the Projector Height

- 1 Lower the projector, and use the front tilt adjustment wheel to fine-tune the display angle.

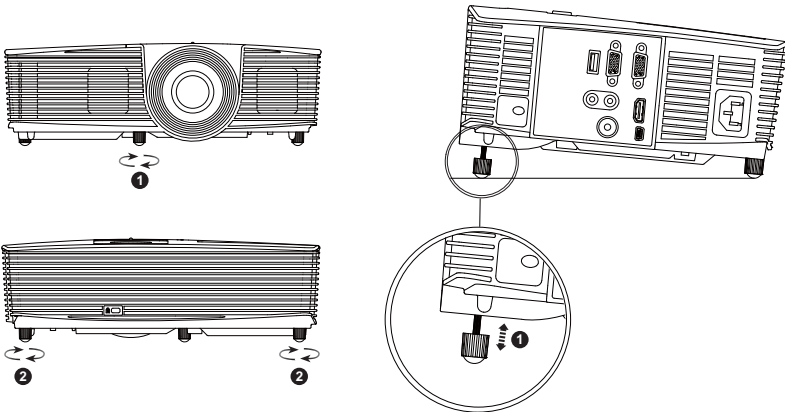

-
- 1 Front tilt adjustment wheel
(Angle of tilt: -5 to 5 degrees)
 - 2 Tilt adjustment wheel
-

Adjusting Projector Focus

1 Rotate the focus ring until the image is clear. The projector focuses at distances ranging between 3.94 ft to 32.81 ft (1.2 m to 10 m).

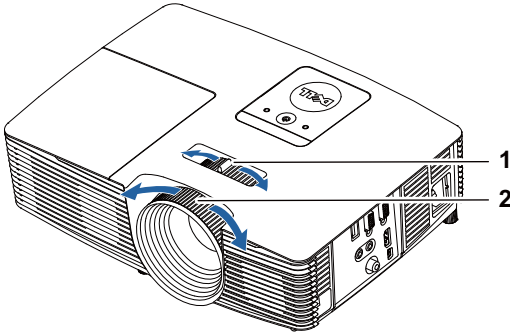

1 Zoom tab

2 Focus ring

Adjusting Image Size

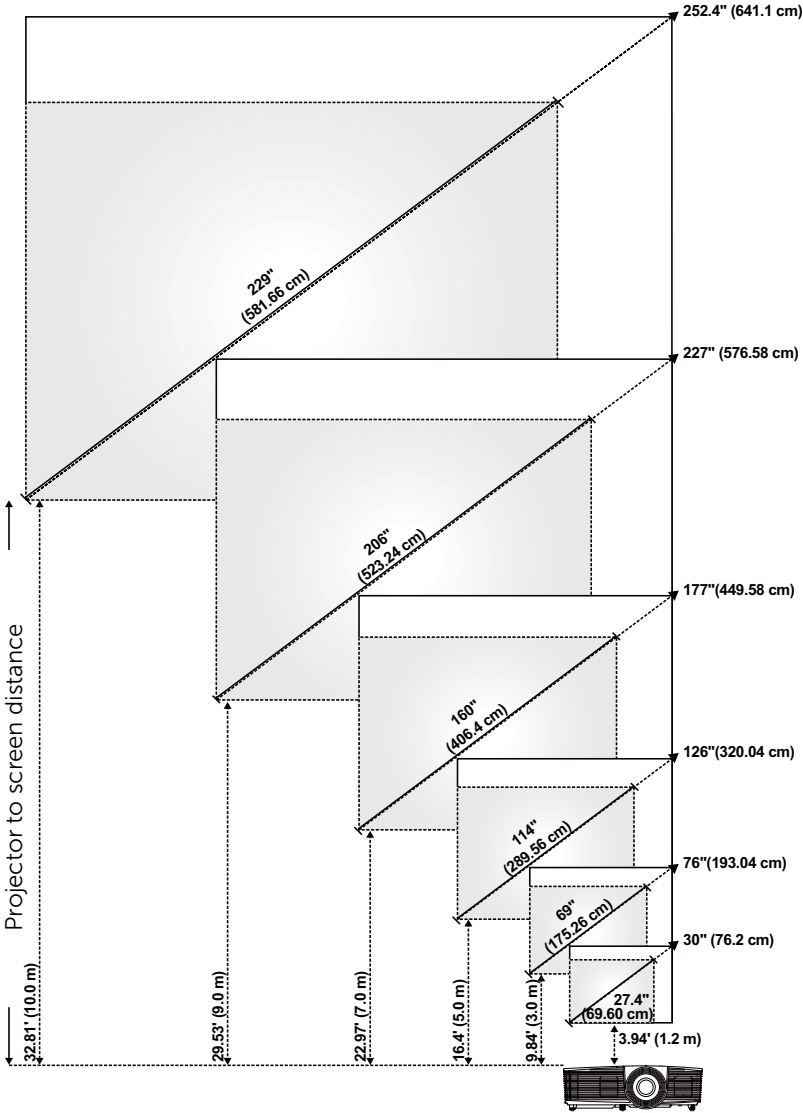

Adjusting Image Shape

Projection Distance (m) [A]	Min Zoom				
	Image size			Projector base to top of image (cm) [C]	Projector base to bottom of image (cm) [D]
	Diagonal (inch/cm) [B]	Width (cm) [W]	Height (cm) [H]		
1.2	27.4"/69.6 cm	56	42	48	6
3	69"/175.26 cm	140	105	120	15
5	114"/289.56 cm	233	174	201	27
7	160"/406.4 cm	326	244	281	37
9	206"/523.24 cm	419	314	361	47
10	229"/581.66 cm	465	349	401	52

Projection Distance (m) [A]	Max Zoom				
	Image size			Projector base to top of image (cm) [C]	Projector base to bottom of image (cm) [D]
	Diagonal (inch/cm) [B]	Width (cm) [W]	Height (cm) [H]		
1.2	30"/76.2 cm	62	46	53	7
3	76"/193.04 cm	154	115	133	18
5	126"/320.04 cm	256	192	221	29
7	177"/449.58 cm	359	269	310	41
9	227"/576.58 cm	462	346	398	52
10	252.4"/641.1 cm	513	385	442	57



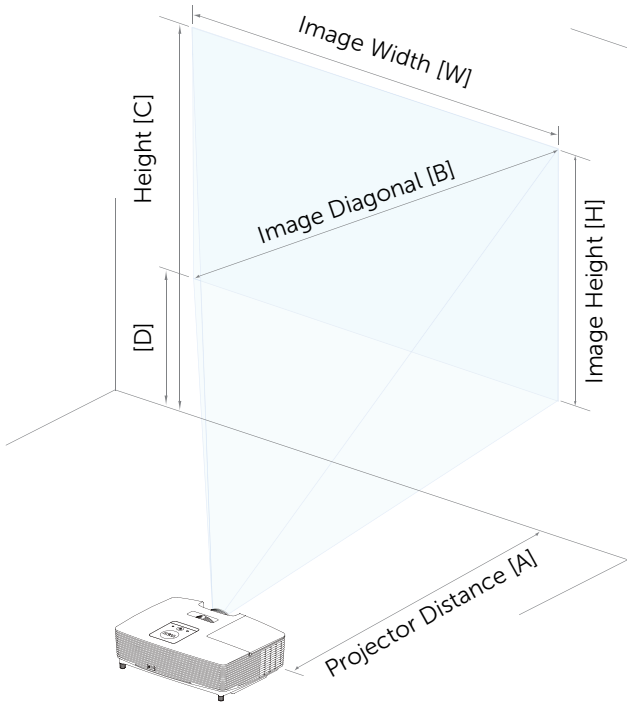

* This graph is for user reference only.



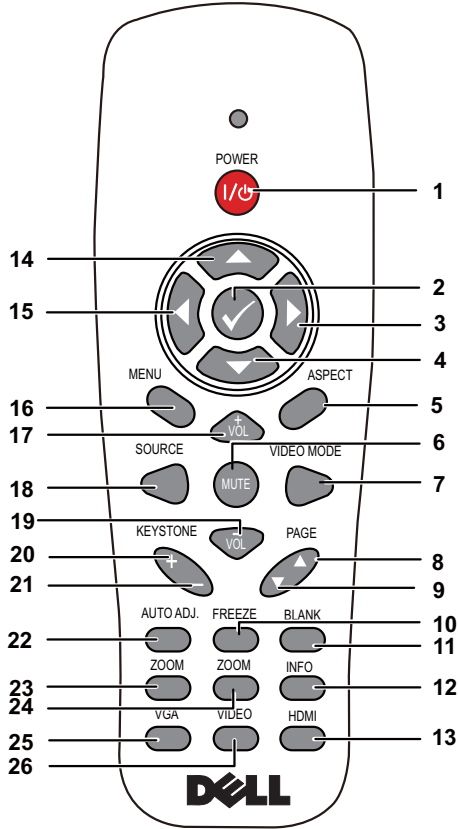





* Offset Ratio: 115±5%



Using Remote Control



1	Power 	Turns the projector on or off. For more information, see "Turning Projector On" on page 23 and "Turning Projector Off" on page 23.
2	Enter 	Press to confirm the selection.
3	Right 	Press to navigate through the On-Screen Display (OSD) Menu items.
4	Down 	Press to navigate through the On-Screen Display (OSD) Menu items.

5	Aspect Ratio	Press to change the aspect ratio of a displayed image.
6	Mute 	Press to mute or un-mute the projector speaker.
7	Video mode	<p>The projector has preset configurations that are optimized for displaying data (presentation slides) or video (movies, games, etc.).</p> <p>Press the Video Mode button to toggle between Presentation mode, Bright mode, Movie mode, sRGB, or Custom mode.</p> <p>Pressing the Video Mode button once will show the current display mode. Pressing the Video Mode button again will switch between modes.</p>
8	Page up 	<p>Press to move to the previous page.</p> <p> NOTE: The Mini USB cable must be connected if you want to use the Page Up feature.</p>
9	Page down 	<p>Press to move to the next page.</p> <p> NOTE: The Mini USB cable must be connected if you want to use the Page Down feature.</p>
10	Freeze	Press to pause the screen image, then press "Freeze" again to unfreeze the image.
11	Blank screen	Press to hide/unhide the image.
12	Information	Press to provide projector native resolution information.
13	HDMI	Press to choose HDMI source.
14	Up 	Press to navigate through the On-Screen Display (OSD) Menu items.
15	Left 	Press to navigate through the On-Screen Display (OSD) Menu items.
16	Menu	Press to activate the OSD.
17	Volume up 	Press to increase the volume.

18	Source	Press to switch between Analog RGB, Composite, Component (YPbPr, via VGA), and HDMI source.
19	Volume down 	Press to decrease the volume.
20	Keystoneadjustment +	Press to adjust image distortion caused by tilting the projector (+/-40 degrees).
21	Keystoneadjustment -	Press to adjust image distortion caused by tilting the projector (+/-40 degrees).
22	Auto Adjust	Press to synchronize the projector with the input source. Auto adjust does not operate if the OSD is displayed.
23	Zoom +	Press to increase the image.
24	Zoom -	Press to decrease the image.
25	VGA	Press to choose VGA source.
26	Video	Press to choose Composite Video source.

Installing Remote Control Batteries



NOTE: Remove the batteries from the remote control when not in use.

1 Press the tab to lift the battery compartment cover.

1

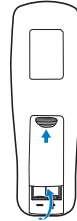

2 Check the polarity (+/-) marking on the batteries.

2

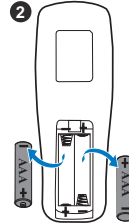

3 Insert the batteries and align their polarity correctly according to the marking in the battery compartment.

3

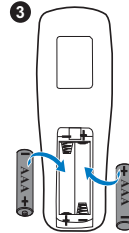

4 Slip the battery cover back.

4

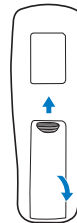

NOTE: Avoid mixing different types of batteries or using new and old batteries together.

Remote Control Operating Range

Operating range	
Angle	$\pm 30^\circ$
Distance	7 m/22.97 feet

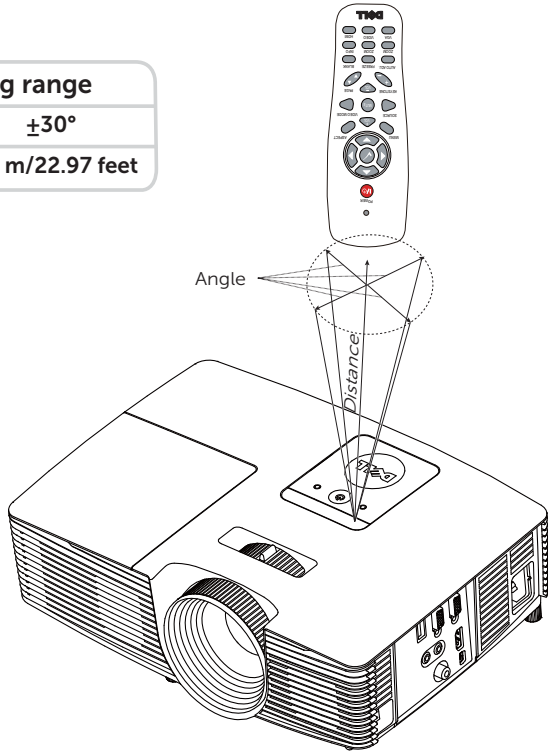

NOTE: Actual operating range may slightly differ from the diagram. Weak batteries will also prevent the remote control from properly operating the projector.

Connecting Projector

Connecting with VGA and External Speakers

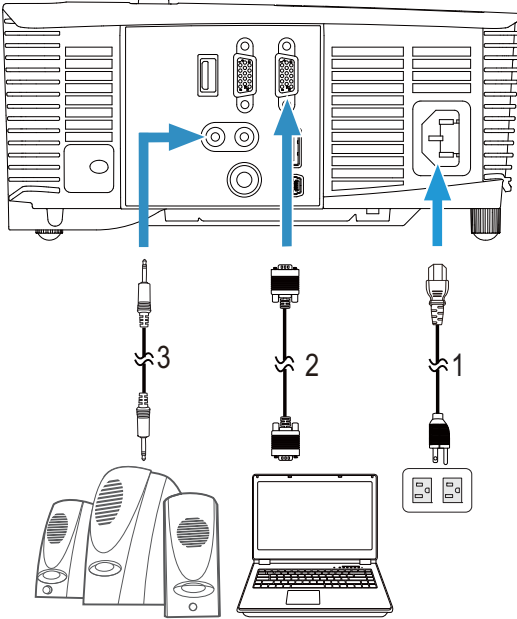

- 1 Power cord
- 2 VGA to VGA cable
- 3 Audio cable

Connecting with HDMI

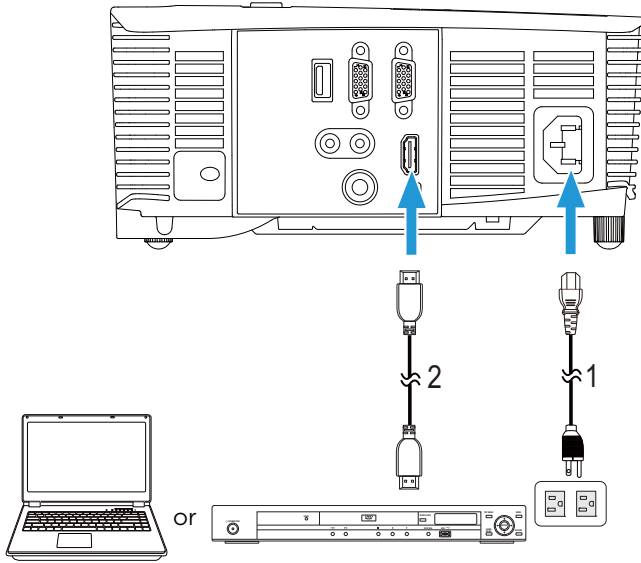

1 Power cord

2 HDMI cable

 **NOTE:** The HDMI cable is not shipped with your projector. You can purchase the HDMI cable on the Dell website at www.dell.com.

Connecting with Composite AV

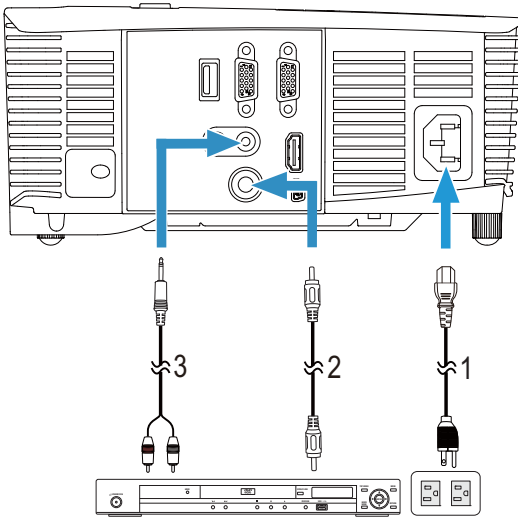

- 1 Power cord
- 2 Composite Video cable
- 3 Composite Audio cable



NOTE: The Composite Video cable and Composite Audio cable are not shipped with your projector.

Connecting to External Monitor via VGA Loop-Through

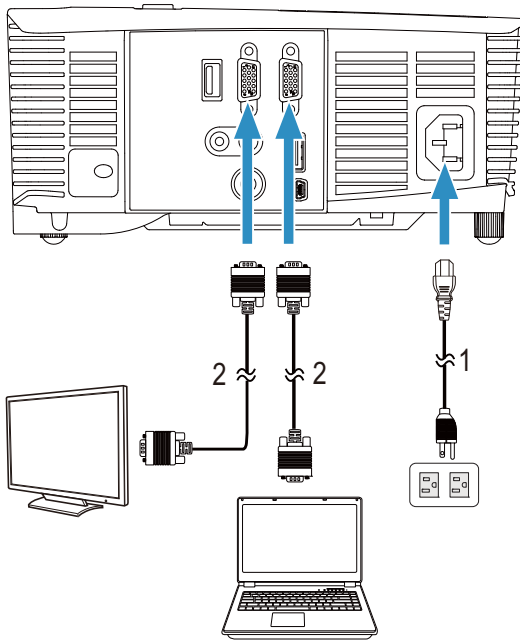

1 Power cord

2 VGA to VGA cable



NOTE: Only one VGA cable is shipped with your projector. An additional VGA cable can be purchased on the Dell website at www.dell.com.

Connecting with Wireless Display Adapter via HDMI (1450 Only)

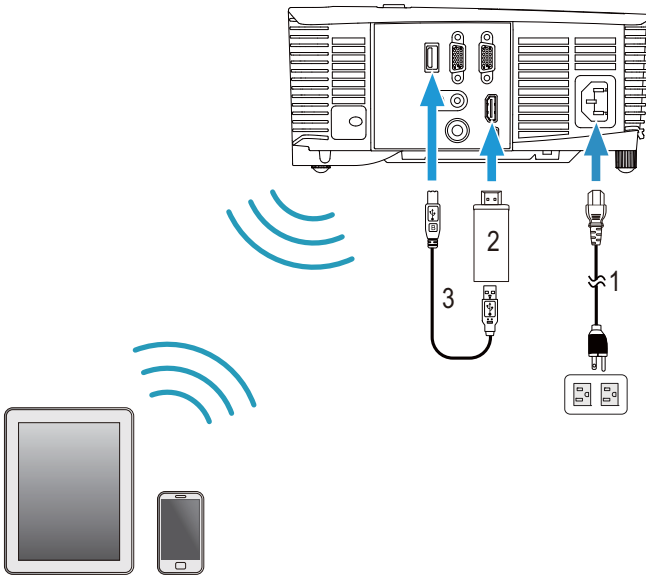

- | | |
|---|---------------------------|
| 1 | Power cord |
| 2 | Wireless Display Adapter |
| 3 | USB-A to Mini USB-B cable |

- 1 Connect receiver to HDMI port and its USB power cable to the powered USB port.
- 2 Switch to HDMI source mode.
- 3 Complete setup following receiver's setup instructions.



NOTE: The Wireless Display Adapter is not shipped with your projector. You can purchase Wireless Display Adapter on the Dell website at www.dell.com.

3

Using Your Projector

Turning Projector On



NOTE: Turn on the projector before you turn on the source (computer, DVD player, etc.). The **Power** button light blinks white until pressed.

- 1 Connect the power cord and appropriate signal cables to the projector. For information about connecting the projector, see "Setting Up Your Projector" on page 8.
- 2 Press the **Power** button (see "Using Remote Control" on page 13 to locate the **Power** button).
- 3 Turn on your source (computer, DVD player, etc.)
- 4 Connect your source to the projector using the appropriate cable. See "Setting Up Your Projector" on page 8 for instructions to connect your source to the projector.
- 5 By default, the input source of the projector is set to VGA-In. Change the input source of the projector if necessary.
- 6 If you have multiple sources connected to the projector, press the **Source** button on the remote control to select the desired source. See "Using Remote Control" on page 13 to locate the **Source** button.

Turning Projector Off



CAUTION: Unplug the projector after properly shutting down as explained in the following procedure.

- 1 Press the **Power** button. Follow the instruction displayed on screen to properly turn off the projector.
-  **NOTE:** The "**Press Power Button to Turn off Projector**" message will appear on the screen. The message disappears after 5 seconds or you can press the **Menu** button to clear it.
- 2 Press the **Power** button again. The cooling fans continue to operate for 120 seconds.
 - 3 To power off the projector quickly, press the Power button and hold for 1 second while the projector's cooling fans are still running.



NOTE: Before you turn on the projector again, wait for 60 seconds to allow the internal temperature to stabilize.

4 Disconnect the power cord from the electrical outlet and the projector.

Menu Settings

- The projector has a multi-language On-Screen Display (OSD) Menu that can be displayed with or without an input source.
- Press the Menu button on the remote control to enter the Main Menu.
- To navigate through the tabs in the Main Menu, press the or buttons on the remote control.
- To select a submenu, press the or button on the remote control.
- To select an option, press the or buttons on the remote control. When an item is selected, the color changes to dark blue.
- Use the or buttons on the remote control to adjust the settings.
- To go back to the Main Menu, press the button on the remote control.
- To exit the OSD, press the Menu button directly on the remote control.

INPUT SOURCE

The Input Source menu allows you to select your projector's input source.

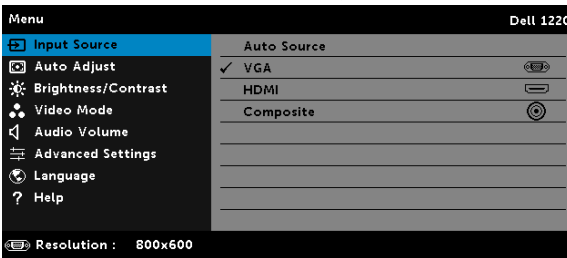

AUTO SOURCE—If you press to activate, the Auto Source option will automatically find the next available input source.

VGA—Press to detect a VGA signal.

HDMI—Press to detect a HDMI signal.

COMPOSITE—Press to detect a Composite Video signal.

AUTO ADJUST

Auto Adjust automatically adjusts the projector's **Horizontal**, **Vertical**, **Frequency**, and **Tracking** in PC mode.



BRIGHTNESS/CONTRAST

The Brightness/Contrast menu allows you adjust the brightness/contrast settings of your projector.

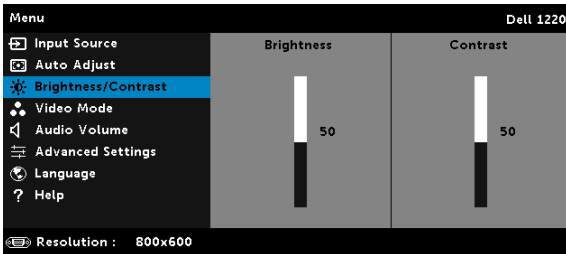

BRIGHTNESS—Use and to adjust the brightness of the image.

CONTRAST—Use and to adjust the display contrast.



NOTE: If you adjust the settings for **Brightness** and **Contrast** the projector automatically switches to Custom mode.

VIDEO MODE

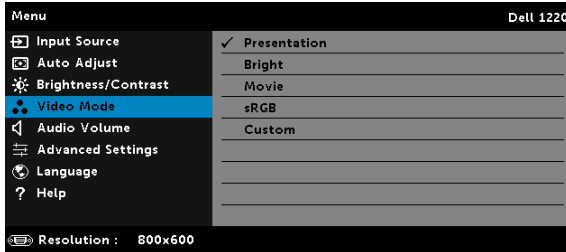

The Video Mode menu allows you to optimize the display image: **Presentation**, **Bright**, **Movie**, **sRGB** (provides more accurate color representation), and **Custom** (set your preferred settings).

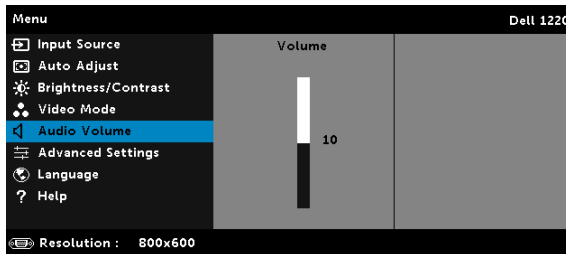

AUDIO VOLUME

The Audio Volume menu allows you to adjust the audio volume settings of your projector.



AUDIO VOLUME—Press  to increase the audio volume and  to decrease the audio volume.

ADVANCED SETTINGS

The Advanced Settings menu allows you to change the settings for **Image**, **Display**, **Projector**, **Menu**, **Power**, and **Information**.

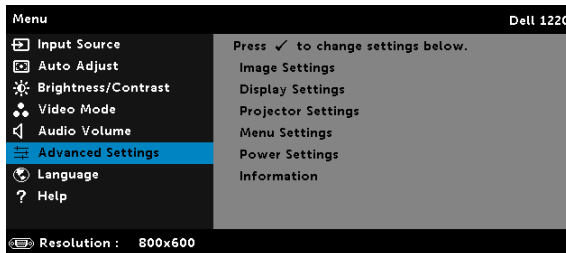





IMAGE SETTINGS (IN PC MODE)—Select and press  to activate image settings. The image settings menu provides the following options:



COLOR TEMPERATURE—Allows you to adjust the color temperature. The screen appears cooler at higher color temperatures and warmer at lower color temperatures. When you adjust the values in the **Color Adjust** menu, the Custom mode is activated. The values are saved in the Custom mode.

RGB COLOR ADJUST—Allows you to manually adjust the colors red, green, and blue.

WHITE INTENSITY—Press  and use  and  to display white intensity.

COLOR SPACE—Allows you to select the color space. The options are: RGB, YCbCr, and YPbPr.



NOTE: If you adjust the settings for **Color Temperature**, **RGB Color Adjust**, and **White Intensity** the projector automatically switches to **Custom mode**.

IMAGE SETTINGS (IN VIDEO MODE)—Select and press  to activate image settings. The image settings menu provides the following options:



COLOR TEMPERATURE—Allows you to adjust the color temperature. The screen appears cooler at higher color temperatures and warmer at lower color temperatures. When you adjust the values in the **Color Adjust** menu, the Custom mode is activated. The values are saved in the Custom mode.

RGB COLOR ADJUST—Allows you to manually adjust the colors red, green, and blue.

SATURATION—Allows you to adjust the video source from black and white to fully saturated color. Press to increase the amount of color in the image and to decrease the amount of color in the image.

SHARPNESS—Press to increase the sharpness and to decrease the sharpness.

TINT—Press to increase the amount of green in the image and to decrease the amount of green in the image.

WHITE INTENSITY—Press and use and to display white intensity.

COLOR SPACE—Allows you to select the color space. The options are: RGB, YCbCr, and YPbPr.



NOTE:

- 1 If you adjust the settings for **Color Temperature**, **RGB Color Adjust**, **Saturation**, **Sharpness**, **Tint**, and **White Intensity** the projector automatically switches to Custom mode.
- 2 **Saturation**, **Sharpness**, and **Tint** only available when the input source is from Composite or S-Video.

DISPLAY SETTINGS (IN PC MODE)—Select and press to activate display settings. The display settings menu provides the following options:

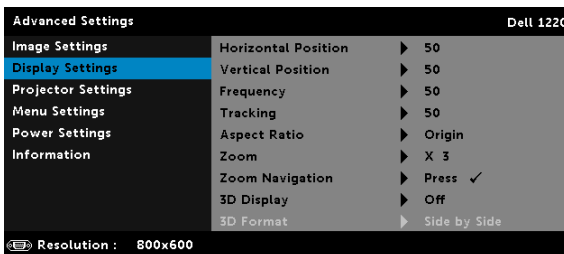

HORIZONTAL POSITION—Press to move the image right and to move the image left.

VERTICAL POSITION—Press to move the image up and to move the image down.

FREQUENCY—Allows you to change the display data clock frequency to match the frequency of your computer's graphics card. If you see a vertical flickering wave, use the Frequency control to minimize the bars. This is a coarse adjustment.

TRACKING—Synchronize the phase of the display signal with the graphic card. If you experience an unstable or flickering image, use Tracking to correct it. This is a fine adjustment.

ASPECT RATIO—Allows you to select the aspect ratio to adjust how the image appears. Options are: Origin, 16:10, 16:9, and 4:3.

- Origin — Select Origin to maintain the aspect ratio of the image projector according to the input source.
- 16:10 — The input source scales to fit the width of the screen to project a 16:10 screen image.
- 16:9 — The input source scales to fit the width of the screen to project a 16:9 screen image.
- 4:3 — The input source scales to fit the screen and projects a 4:3 image.

ZOOM—Press and to zoom and view the image.

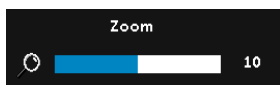

Adjust the image scale by pressing or and press to view on your remote control only.



ZOOM NAVIGATION—Press to activate the **Zoom Navigation** menu.

Use to navigate the projection screen.

3D DISPLAY—Select On to activate the 3D display function (default is Off).



NOTE:

- 1 When you want to create a 3D experience, you will need a few other components including:
 - a Computer/Laptop with a 120 Hz signal output quad-buffered graphics card.

- b "Active" 3D glasses with DLP Link™.
 - c 3D content.
 - d 3D Player.
- 2 Enable the 3D function when it satisfies any of the below-mentioned conditions:
 - a Computer/Laptop with graphics card, capable of outputting at 120 Hz signal via VGA cable.
 - b Input a suite of 3D content via Video.
 - 3 "3D Display" selection will only be enabled in the "Display Settings of the Advanced Settings" menu when the projector detects either of the inputs mentioned above.
 - 4 3D support and refresh rate are as below:
 - a VGA/HDMI 1280x720, 1024x768, and 800x600 at 120 Hz
 - b Composite at 60 Hz
 - 5 The recommended VGA signal for laptop is Single-mode output (Dual mode is not recommended).
 - 6 HDMI 1.4a 3D support rates:
 - a 1280x720p@50 Hz Frame Packing
 - b 1280x720p@59.94/60 Hz Frame Packing
 - c 1920x1080p@23.98/24 Hz Frame Packing
 - d 1920x1080i@50 Hz Side by Side Half
 - e 1920x1080i@59.94/60 Hz Side by Side Half
 - f 1280x720p@50 Hz Top and Bottom
 - g 1280x720p@59.94/60 Hz Top and Bottom
 - h 1920x1080p@23.98/24 Hz Top and Bottom

3D FORMAT—Allows you to select the 3D format when the 3D display function is activated. Options are: Side By Side, Side By Side Full, Frame Sequential, Field Sequential, Top/Bottom, and Frame Packing.

3D SYNC INVERT—If you see a discrete or overlapping image while wearing DLP 3D goggles, you may need to execute 'Invert' to get best match of left/right image sequence to get the correct image. (For DLP 3D goggles)

DISPLAY SETTINGS (IN VIDEO MODE)—Select and press  to activate

display settings. The display settings menu provides the following options:

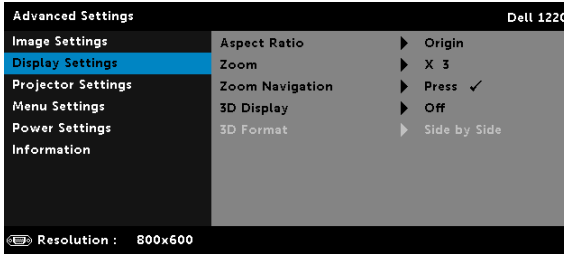



ASPECT RATIO—Allows you to select the aspect ratio to adjust how the image appears.

- Origin — Select Origin to maintain the aspect ratio of image projector according to the input source.
- 16:9 — The input source scales to fit the width of the screen to project a 16:9 screen image.
- 16:10 — The input source scales to fit the width of the screen to project a 16:10 screen image.
- 4:3 — The input source scales to fit the screen and projects a 4:3 image.

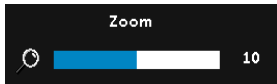



Zoom—Press  and  to zoom and view the image.



Adjust the image scale by pressing  or  and press  to view on your remote control only.



ZOOM NAVIGATION—Press  to activate the Zoom Navigation menu.

Use , , , and  to navigate the projection screen.

3D DISPLAY—Select On to activate the 3D display function (default is Off).



NOTE:

- 1 When you want to create a 3D experience, you will need a few other components including:
 - a Computer/Laptop with a 120 Hz signal output quad-buffered graphics card.
 - b "Active" 3D glasses with DLP Link™.

- c 3D content.
- d 3D Player.
- 2 Enable the 3D function when it satisfies any of the below mentioned conditions:
 - a Computer/Laptop with graphics card, capable of outputting at 120 Hz signal via VGA cable.
 - b Input a suite of 3D content via Video.
- 3 "3D Display" selection will only be enabled in the "Display Settings of the Advanced Settings" menu when the projector detects either of the inputs mentioned above.
- 4 3D support and refresh rate are as below:
 - a VGA/HDMI 1280x720, 1024x768, and 800x600 at 120 Hz
 - b Composite at 60 Hz
- 5 The recommended VGA signal for laptop is Single-mode output (Dual mode is not recommended).
- 6 HDMI 1.4a 3D support rates:
 - a 1280x720p@50 Hz Frame Packing
 - b 1280x720p@59.94/60 Hz Frame Packing
 - c 1920x1080p@23.98/24 Hz Frame Packing
 - d 1920x1080i@50 Hz Side by Side Half
 - e 1920x1080i@59.94/60 Hz Side by Side Half
 - f 1280x720p@50 Hz Top and Bottom
 - g 1280x720p@59.94/60 Hz Top and Bottom
 - h 1920x1080p@23.98/24 Hz Top and Bottom

3D FORMAT—Allows you to select the 3D format when the 3D display function is activated. Options are: Side By Side, Side By Side Full, Frame Sequential, Field Sequential, Top/Bottom, and Frame Packing.

3D SYNC INVERT—If you see a discrete or overlapping image while wearing DLP 3D goggles, you may need to execute 'Invert' to get best match of left/right image sequence to get the correct image. (For DLP 3D goggles)

PROJECTOR SETTINGS—Select and press  to activate projector settings.

The projector settings menu provides the following options:

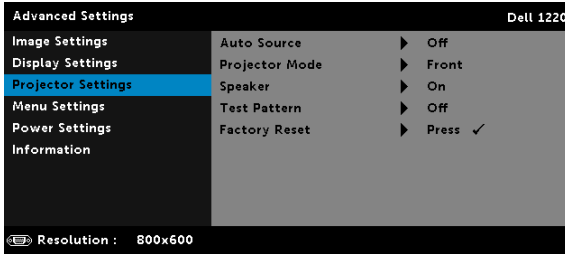

AUTO SOURCE—Select **Off** (the default) to lock the current input signal. If you press the **Source** button when the **Auto Source** mode is set to **Off**, you can manually select the input signal. Select **On** to auto detect the available input signals. If you press the **Source** button when the projector is on, it automatically finds the next available input signal.

PROJECTOR MODE—Allows you to select the projector mode, depending upon how the projector is mounted.

- **Rear Projection-Desktop** — The projector reverses the image so that you can project from behind a translucent screen.
- **Rear Projection-Ceiling Mount** — The projector reverses and turns the image upside down. You can project from behind a translucent screen with a ceiling-mounted projection.
- **Front Projection-Desktop** — This is the default option.
- **Front Projection-Ceiling Mount** — The projector turns the image upside down for ceiling-mounted projection.

SPEAKER—Select **On** to enable the speaker. Select **Off** to disable the speaker.

TEST PATTERN—Test Pattern is used to test focus and resolution.

You can enable or disable the **Test Pattern** by selecting **Off**, **Test**

Pattern 1, or Test Pattern 2.

Test Pattern 1:

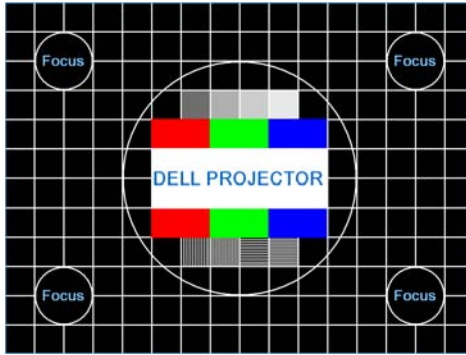

Test Pattern 2:

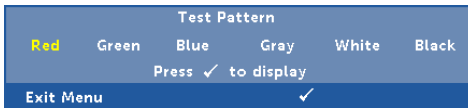

FACTORY RESET—Select Confirm and press to reset all settings to its factory default. The below warning message appears:



Reset items include both computer sources and Video source settings.

MENU SETTINGS—Select and press to activate menu settings. The menu settings consist of the following options:

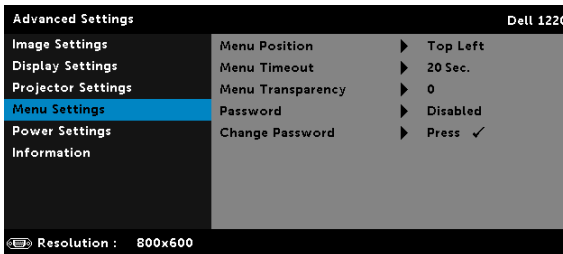

MENU POSITION—Allows you to change the position of the OSD menu on the screen.

MENU TIMEOUT—Allows you to adjust the time for an OSD timeout. By default, the OSD disappears after 20 seconds of non-activity.

MENU TRANSPARENCY—Select to change the transparency level of the OSD background.

PASSWORD—When Password Protect is enabled, a Password Protect screen requesting you to enter a password will be displayed when the power plug is inserted into the electrical output and the power for the projector is first turned on. By default, this function is disabled. You can enable this feature by selecting **Enabled**. If the password has been set before, key in the password first and select the function. This password security feature will be activated the next time you turn on the projector. If you enable this feature, you will be asked to enter the projector's password after you turn on the projector:

1 First time password input request:

- a** Go to **Menu Settings**, press and then select **Password** to enable the password settings.

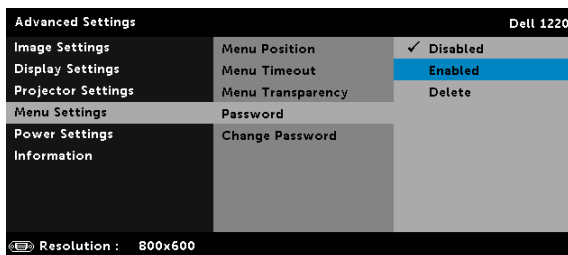

- b** Enabling the Password function will pop up a change screen. Key in a 4-digit number from the screen and press .

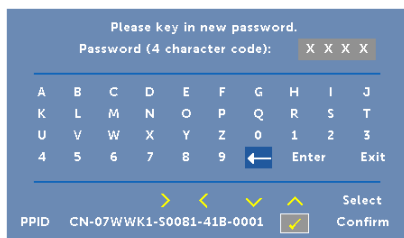

- c** To confirm, enter the password again.
- d** If the password verification is successful, you may resume with accessing the projector's functions and its utilities.

- 2 If you have entered an incorrect password, you will be given two more chances. After three invalid attempts, the projector will automatically turn off.

 **NOTE:** If you forget your password, contact DELL or a qualified service person.

- 3 To disable the password function, select the **Disabled** option to close the function.
- 4 To delete the password, select the **Delete** option.

CHANGE PASSWORD—Key in the original password. Then, enter the new password and confirm the new password again.

Please key in the original password.

Password (4 character code): X X X X

A	B	C	D	E	F	G	H	I	J
K	L	M	N	O	P	Q	R	S	T
U	V	W	X	Y	Z	0	1	2	3
4	5	6	7	8	9	←	Enter	Exit	

PPID CN-07WWK1-S00B1-41B-0001

Navigation: > < ✓ ▲ Select Confirm

Please key in new password.

Password (4 character code): X X X X

A	B	C	D	E	F	G	H	I	J
K	L	M	N	O	P	Q	R	S	T
U	V	W	X	Y	Z	0	1	2	3
4	5	6	7	8	9	←	Enter	Exit	

PPID CN-07WWK1-S00B1-41B-0001

Navigation: > < ✓ ▲ Select Confirm

Please key in new password again.

Password (4 character code): X X X X

A	B	C	D	E	F	G	H	I	J
K	L	M	N	O	P	Q	R	S	T
U	V	W	X	Y	Z	0	1	2	3
4	5	6	7	8	9	←	Enter	Exit	

PPID CN-07WWK1-S00B1-41B-0001

Navigation: > < ✓ ▲ Select Confirm

POWER SETTINGS—Select and press  to activate power settings. The power settings menu provides the following options:

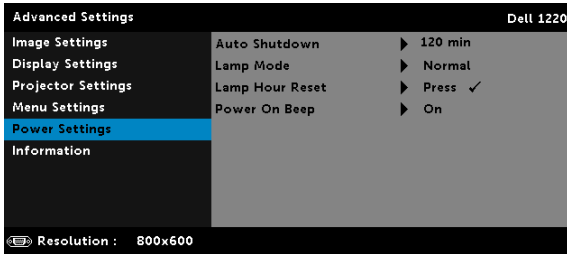

AUTO SHUTDOWN—By default, the projector is set to enter auto shutdown mode after 120 minutes of no activity. A warning message appears on screen showing a 60 seconds countdown before switching to auto shutdown mode. Press any button during the countdown period to stop the auto shutdown mode.

You can also set a different delay period to enter auto shutdown mode. The delay period is the time you want the projector to wait without an input signal.

If an input signal is not detected during the delay period, the projector turns off. To turn on the projector press the Power button.

LAMP MODE—Allows you to select the **Normal** or **ECO** mode.

Normal mode operates at full power level. ECO mode operates at a lower power level which may provide longer lamp life, quieter operation, and dimmer luminance output on the screen.

LAMP HOUR RESET—Press  and select the Confirm option to reset the lamp hour.

POWER ON BEEP—Select **On** to enable the power on beep. Select **Silent** to disable the power on beep.

INFORMATION—The information menu displays the current 1220 or 1450 projector settings.

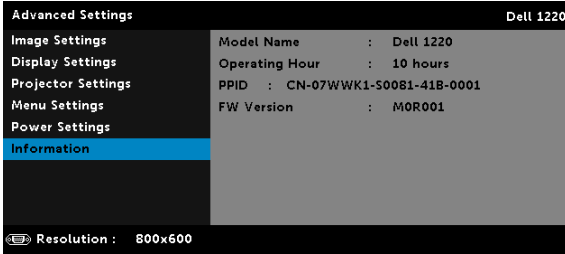

LANGUAGE

Allows you to set the language for the OSD. Press to activate the Language menu.

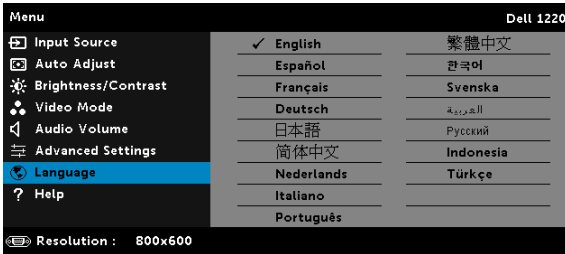

HELP

If you encounter problems with your projector, you can access the help menu for troubleshooting.

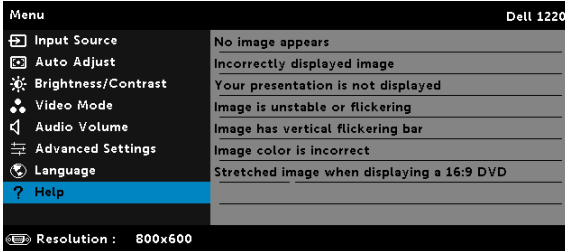

4

Troubleshooting Your Projector



If you experience problems with your projector, see the following troubleshooting tips. If the problem persists, contact Dell (see Contacting Dell on page 51).



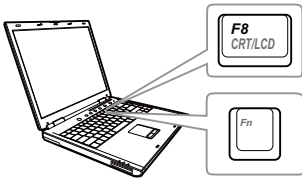

Problem

No image appears on the screen



Possible Solution

- Ensure that you have chosen the correct input source on the INPUT SOURCE menu.
 - Ensure the external graphics port is enabled. If you are using a Dell laptop computer, press   (Fn+F8). For other computers, see your respective documentation. If images are not displayed properly, please upgrade the video driver of your computer. For Dell computers, see support.dell.com.
 - Ensure that all the cables are securely connected. See "Setting Up Your Projector" on page 8.
 - Ensure that the pins of the connectors are not bent or broken.
 - Ensure that the lamp is securely installed (see "Changing the Lamp" on page 44).
 - Use Test Pattern in the Projector Settings of the Advanced Settings menu. Ensure that the colors of the test pattern are correct.
-

Problem (continued)	Possible Solution (continued)
Partial, scrolling, or incorrectly displayed image	<p>1 Press the Auto Adjust button on the remote control.</p> <p>2 If you are using a Dell laptop computer, set the resolution of the computer to SVGA (800 x 600) or XGA (1024 x 768):</p> <ul style="list-style-type: none"> a Right-click the unused portion of your Microsoft® Windows® desktop, click Properties, and then select Settings tab. b Verify that the setting is 800 x 600 or 1024 x 768 pixels for the external monitor port. c Press   (Fn+F8).
	<p>If you experience difficulty in changing resolutions, or if your monitor freezes, restart all the equipment and the projector.</p>
	<p>If you are not using a Dell laptop computer, see your documentation. If images are not displayed properly, please upgrade the video driver of your computer. For a Dell computer, see support.dell.com.</p>
The screen does not display your presentation	<p>If you are using a portable computer, press   (Fn+F8).</p>
Image is unstable or flickering	<p>Adjust the tracking in the OSD Display Settings of the Advanced Settings menu (in PC Mode only).</p>
Image has vertical flickering bar	<p>Adjust the frequency in the OSD Display Settings of the Advanced Settings menu (in PC Mode only).</p>

Problem (continued)	Possible Solution (continued)
Image color is incorrect	<ul style="list-style-type: none"> • If the display receives the wrong signal output from the graphics card, please set the signal type to RGB in the OSD Image Settings of the Advanced Settings tab. • Use Test Pattern in the Projector Settings of the Advanced Settings menu. Ensure that the colors of the test pattern are correct.
Image is out of focus	<ol style="list-style-type: none"> 1 Adjust the focus ring on the projector lens. 2 Ensure that the projection screen is within the required distance from the projector (3.94 ft [1.2 m] ~ 32.81 ft [10 m]).
The image is stretched when displaying a 16:9 DVD	<p>The projector automatically detects the input signal format. It will maintain the aspect ratio of the projected image according to input signal format with an Original setting.</p> <p>If the image is still stretched, adjust the aspect ratio in the Display Settings of the Advanced Settings menu in the OSD.</p>
Image is reversed	<p>Select Projector Settings of the Advanced Settings from the OSD and adjust the projector mode.</p>
Lamp is burned out or makes a popping sound	<p>When the lamp reaches its end of life, it may burn out and may make a loud popping sound. If this occurs, the projector does not turn back on. To replace the lamp, see "Changing the Lamp" on page 44.</p>
LAMP light is solid amber	<p>If the LAMP light is solid amber, replace the lamp.</p>

Problem (continued)	Possible Solution (continued)
LAMP light is blinking amber	<p>If the LAMP light is blinking amber, the lamp module connection may be disrupted. Please check the lamp module and ensure that it is properly installed.</p> <p>If the LAMP lights and the Power light are blinking amber, the lamp driver has failed and the projector will automatically shut down.</p> <p>If the LAMP and TEMP lights are blinking amber and the Power light is solid blue, the color wheel has failed and the projector will automatically shut down.</p> <p>To clear the protection mode, press and hold the POWER button for 10 seconds.</p>
TEMP light is solid amber	<p>The projector has overheated. The display automatically shuts down. Turn the display on again after the projector cools down. If the problem persists, contact Dell.</p>
TEMP light is blinking amber	<p>If the projector fan fails, the projector will automatically shut down. Try to clear the projector mode by pressing and holding the Power button for 10 seconds. Please wait for about 5 minutes and try to power up again. If the problem persists, contact Dell.</p>
The remote control is not operating smoothly or works only within a limited range	<p>The battery may be low. If so, replace with two new AAA batteries.</p>

Guiding Signals

Projector Status	Description	Control Buttons		Indicator	
		Power	TEMP (Amber)	LAMP (Amber)	
Standby mode	Projector in Standby mode. Ready to power on.	White Flashing	OFF	OFF	OFF
Warming up mode	Projector takes some time to warm up and power on.	White	OFF	OFF	OFF
Lamp on	Projector in Normal mode, ready to display an image.  Note: The OSD menu is not accessed.	White	OFF	OFF	OFF
Cooling mode	Projector is cooling to shutdown.	White	OFF	OFF	OFF
Projector overheated	Air vents might be blocked or ambient temperature may be above 35 °C. The projector automatically shuts down. Ensure that the air vents are not blocked and that the ambient temperature is within operational range. If the problem persists, contact Dell.	OFF	AMBER	OFF	OFF
Lamp driver overheated	The lamp driver is overheated. The air vents may be blocked. The projector automatically shuts down. Turn the display on again after the projector cools down. If the problem persists, contact Dell.	AMBER	AMBER	OFF	OFF
Fan breakdown	One of the fans has failed. The projector automatically shuts down. If the problem persists, contact Dell.	OFF	AMBER Flashing	OFF	OFF
Lamp driver breakdown	The lamp driver has failed. The projector automatically shuts down. Unplug the power cord after three minutes and then turn the display on again. If this problem persists, contact Dell.	AMBER Flashing	OFF	AMBER Flashing	AMBER Flashing
Color Wheel breakdown	Color wheel cannot start. The projector has failed and the projector automatically shuts down. Unplug the power cord after three minutes and then turn on the projector. If this problem persists, contact Dell.	White	AMBER Flashing	AMBER Flashing	AMBER Flashing
Lamp failure	Lamp is defective. Replace the lamp.	OFF	OFF	AMBER	AMBER
Fault - DC supply (+12V)	Power supply has been interrupted. The projector automatically shuts down. Unplug the power cord after three minutes and then turn on the projector. If this problem persists, contact Dell.	AMBER Flashing	AMBER	AMBER	AMBER
Lamp module connection failed	Lamp module connection may be disrupted. Check the lamp module and ensure that it is properly installed. If the problem persists, contact Dell.	OFF	OFF	AMBER Flashing	AMBER Flashing

Changing the Lamp

CAUTION: Before you begin any of the procedures in this section, follow the Safety Instructions as described on page 7.

Replace the lamp when the message "**Lamp is approaching the end of its useful life in the operation. Replacement suggested!**" www.dell.com/lamps" appears on the screen. If this problem persists after replacing the lamp, contact Dell. For more information, see "Contacting Dell" on page 51.

CAUTION: Use an original lamp to ensure safe and optimal working condition of your projector.

CAUTION: The lamp becomes very hot when in use. Do not attempt to replace the lamp until the projector has been allowed to cool down for at least 30 minutes.

CAUTION: Do not touch the bulb or the lamp glass at any time. Projector lamps are very fragile and may shatter if touched. The shattered glass pieces are sharp and can cause injury.

CAUTION: If the lamp shatters, remove all broken pieces from the projector and dispose or recycle according to state, local, or federal law. For more information see www.dell.com/hg.

- 1 Turn off the projector and disconnect the power cord.
- 2 Let the projector cool for at least 30 minutes.
- 3 Loosen the one screw that secures the lamp cover, and remove the cover.
- 4 Loosen the two screws that secure the lamp.
- 5 Pull the lamp up by its metal handle.

NOTE: Dell may require lamps replaced under warranty to be returned to Dell. Otherwise, contact your local waste disposal agency for the address of the nearest deposit site.

- 6 Replace with the new lamp.
- 7 Tighten the two screws that secure the lamp.

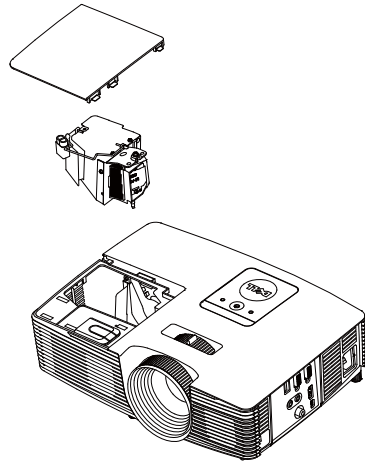

- 8 Replace the lamp cover and tighten the one screw.
- 9 Reset the lamp usage time by selecting "Yes" for **Lamp Reset** in the OSD **Power Settings** of the **Advanced Settings** menu (see Power Settings of the Advanced Settings menu on page 37). When a new lamp module has been changed, the projector will automatically detect and reset the lamp hours.



CAUTION: Lamp Disposal (for the US only)

 **LAMP(S) INSIDE THIS PRODUCT CONTAIN MERCURY AND MUST BE RECYCLED OR DISPOSED OF ACCORDING TO LOCAL, STATE, OR FEDERAL LAWS. FOR MORE INFORMATION, GO TO WWW.DELL.COM/HG OR CONTACT THE ELECTRONIC INDUSTRIES ALLIANCE AT WWW.EIAE.ORG. FOR LAMP-SPECIFIC DISPOSAL INFORMATION, CHECK WWW.LAMPRECYCLE.ORG.**

5

Specifications

Light Valve	1220: 0.55" SVGA S450 DMD, DarkChip3™ 1450: 0.55" XGA S450 DMD, DarkChip3™
Brightness	1220: 2700 ANSI Lumens (Max.) 1450: 3000 ANSI Lumens (Max.)
Contrast Ratio	2200:1 Typical (Full On/Full Off)
Uniformity	85% Typical (Japan Standard - JBMA)
Number of Pixels	1220: 800 x 600 (SVGA) 1450: 1024 x 768 (XGA)
Aspect Ratio	4:3
Displayable Color	1.07 billion colors
Color Wheel Speed	2 X 1 X for 3D Display
Projection Lens	F-Stop: F/2.41~2.55 Focal length, f=21.8~24 mm 1.1X manual Zoom Lens Throw ratio =1.95~2.15 wide and tele Offset ratio: 115 ± 5%
Projection Screen Size	27.5 ~ 252.4 inches (diagonal)
Projection Distance	3.94 ~ 32.81 ft (1.2 ~ 10 m)
Video Compatibility	Composite Video: NTSC: M (3.58 MHz), 4.43 MHz PAL: B, D, G, H, I, M, N, 4.43 MHz SECAM: B, D, G, K, K1, L, 4.25/4.4 MHz Component Video input via VGA: 1080i (50/60 Hz), 720p (50/60 Hz), 576i/p, 480i/p HDMI input: 1080p, 720p, 576i/p, 480i/p

Power Supply	Universal AC 100-240 V 50-60 Hz with PFC input
Power Consumption	Normal mode: 230 W \pm 10% @ 110 Vac Eco mode: 195 W \pm 10% @ 110 Vac Standby mode: < 0.5 W
Audio	1 speaker x 2 watt RMS
Noise Level	Normal mode: 34 dB(A) Eco mode: 31 dB(A)
Projector Weight	5.4 lbs (2.4 kg)
Dimensions (W x H x D)	12.38 x 3.45 x 8.8 inches (314.4 x 87.6 x 223.5 mm)

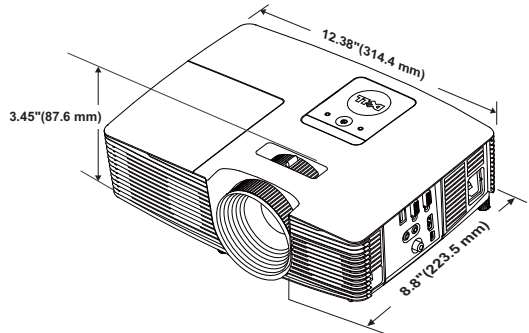

Environmental	Operating temperature: 5 °C - 40 °C (41 °F-104 °F) Humidity: 80% maximum Storage temperature: 0 °C to 60 °C (32 °F to 140 °F) Humidity: 90% maximum Shipping temperature: -20 °C to 60 °C (-4 °F to 140 °F) Humidity: 90% maximum
I/O Connectors	Power: One AC power socket (3-pin - C14 inlet) VGA input: One 15-pin D-sub connector (Blue), VGA In, for analog RGB/Component input signals.

VGA output: One 15-pin D-sub connector (Black) for VGA-A loop through.

Composite Video input: One Yellow RCA jack for CVBS signal.

HDMI input: One HDMI connector for supporting HDMI 1.4a. specification HDCP compliant.

Analog Audio input: One 3.5 mm stereo mini phone jack (Blue).

Variable audio output: One 3.5 mm stereo mini phone jack (Green).

USB (type B) port: One mini USB slave for remote support and firmware upgrade.

5V output: One USB type A 5V DC / 1 A output for support dongle (1450 Only).

Lamp

OSRAM 190 W user-replaceable lamp

Lamp life

Normal mode: Up to 5000 hours

Eco mode: Up to 6000 hours



NOTE: The lamp life rating for any projector is a measure of brightness degradation only, and is not a specification for the time it takes a lamp to fail and cease light output. Lamp life is defined as the time it takes for more than 50 percent of a lamp sample population to have brightness decrease by approximately 50 percent of the rated lumens for the specified lamp. The lamp life rating is not guaranteed in any way. The actual operating life span of a projector lamp will vary according to operating conditions and usage patterns. Usage of a projector in stressful conditions which may include dusty environments, under high temperatures, many hours per day, and abrupt powering-off will most likely result in a lamp's shortened operating life span or possible lamp failure.

Compatibility Modes (Analog/Digital)

Resolution	Refresh Rate (Hz)	Hsync Frequency (KHz)	Pixel Clock (MHz)
640 x 350	70.087	31.469	25.175
640 x 480	59.940	31.469	25.175
640 x 480 p60	59.940	31.469	25.175
720 x 480 p60	59.940	31.469	27.000
720 x 576 p50	50.000	31.250	27.000
720 x 400	70.087	31.469	28.322
640 x 480	75.000	37.500	31.500
848 x 480	60.000	31.020	33.750
640 x 480	85.008	43.269	36.000
800 x 600	60.317	37.879	40.000
800 x 600	75.000	46.875	49.500
800 x 600	85.061	53.674	56.250
1024 x 768	60.004	48.363	65.000
1280 x 720 p50	50.000	37.500	74.250
1280 x 720 p60	60.000	45.000	74.250
1920 x 1080 i50	50.000	28.125	74.250
1920 x 1080 i60	60.000	33.750	74.250
1280 x 720	59.855	44.772	74.500
1024 x 768	75.029	60.023	78.750
1280 x 800	59.810	49.702	83.500
1366 x 768	59.790	47.712	85.500
1360 x 768	60.015	47.712	85.500
1024 x 768	84.997	68.677	94.500
1440 x 900	59.887	55.935	106.500
1152 x 864	75.000	67.500	108.000
1280 x 960	60.000	60.000	108.000
1280 x 1024	60.020	63.981	108.000
1152 x 864	85.000	77.095	119.651
1400 x 1050	59.978	65.317	121.750
1280 x 800	84.880	71.554	122.500
1280 x 1024	75.025	79.976	135.000
1440 x 900	74.984	70.635	136.750
1680 x 1050	59.954	65.290	146.250
1280 x 960	85.002	85.938	148.500
1920 x 1080	60.000	67.500	148.500
1400 x 1050	74.867	82.278	156.000
1280 x 1024	85.024	91.146	157.000
1440 x 900	84.842	80.430	157.000

1600 x 1200	60.000	75.000	162.000
800 x 600	119.972	76.302	73.250
1024 x 768	119.989	97.551	115.500



NOTE: The refresh rate of the timings at 120 Hz (gray area) can supported in 3D mode.

6

Contacting Dell

For customers in the United States, call 800-WWW-DELL (800-999-3355).



NOTE: If you do not have an active Internet connection, you can find contact information on your purchase invoice, packing slip, bill, or Dell product catalog.

Dell provides several online and telephone-based support and service options. Availability varies by country and product, and some services may not be available in your area. To contact Dell for sales, technical support, or customer service issues:

- 1 Visit go to www.dell.com/contactDell.
- 2 Select your region on the interactive map.
- 3 Select a Segment for Contact.
- 4 Select the appropriate service or support link based on your need.

7

Appendix: Glossary

ANSI Lumens — A standard for measuring the brightness. It is calculated by dividing a square meter image into nine equal rectangles, measuring the lux (or brightness) reading at the center of each rectangle, and averaging these nine points.

Aspect Ratio — The most popular aspect ratio is 4:3 (4 by 3). Early television and computer video formats are in a 4:3 aspect ratio, which means that the width of the image is 4/3 times the height.

Brightness — The amount of light emitted from a display or projection display or projection device. The brightness of projector is measured by ANSI lumens.

Color Temperature — The color appearance of white light. Low color temperature implies warmer (more yellow/red) light while high color temperature implies a colder (more blue) light. The standard unit for color temperature is Kelvin (K).

Component Video — A method of delivering quality video in a format that consists of the luminance signal and two separate chrominance signals and are defined as Y'Pb'Pr' for analog component and Y'Cb'Cr' for digital component. Component video is available on DVD players.

Composite Video — A video signal that combines the luma (brightness), chroma (color), burst (color reference), and sync (horizontal and vertical synchronizing signals) into a signal waveform carried on a single wire pair. There are three kinds of formats, namely, NTSC, PAL, and SECAM.

Compressed Resolution — If the input images are of higher resolution than the native resolution of the projector, the resulting image will be scaled to fit the native resolution of the projector. The nature of compression in a digital device means that some image content is lost.

Contrast Ratio — Range of light and dark values in a picture, or the ratio between their maximum and minimum values. There are two methods used by the projection industry to measure the ratio:

- 1 Full On/Off — measures the ratio of the light output of an all white image (full on) and the light output of an all black (full off) image.
- 2 ANSI — measures a pattern of 16 alternating black and white rectangles. The average light output from the white rectangles is divided by the

average light output of the black rectangles to determine the ANSI contrast ratio.

Full On/Off contrast is always a larger number than ANSI contrast for the same projector.

dB — decibel — A unit used to express relative difference in power or intensity, usually between two acoustic or electric signals, equal to ten times the common logarithm of the ratio of the two levels.

Diagonal Screen — A method of measuring the size of a screen or a projected image. It measures from one corner to the opposite corner. A 9 FT high, 12 FT wide, screen has a diagonal of 15 FT. This document assumes that the diagonal dimensions are for the traditional 4:3 ratio of a computer image as per the example above.

DHCP — Dynamic Host Configuration Protocol — A network protocol that enables a server to automatically assign a TCP/IP address to a device.

DLP® — Digital Light Processing™ — Reflective display technology developed by Texas Instruments, using small manipulated mirrors. Light passing through a color filter is sent to the DLP mirrors which arrange the RGB colors into a picture projected onto screen, also known as DMD.

DMD — Digital Micro-Mirror Device — Each DMD consists of thousands of tilting, microscopic aluminum alloy mirrors mounted on a hidden yoke.

Focal Length — The distance from the surface of a lens to its focal point.

Frequency — It is the rate of repetition in cycles per seconds of electrical signals. Measured in Hz (Hertz).

HDCP — High-Bandwidth Digital-Content Protection — A specification developed by Intel™ Corporation to protect digital entertainment across digital interface, such as DVI, HDMI.

HDMI — High-Definition Multimedia Interface — HDMI carries both uncompressed high definition video along with digital audio and device control data in a single connector.

Hz (Hertz) — Unit of frequency.

Keystone Correction — Device that will correct an image of the distortion (usually a wide-top narrow-bottom effect) of a projected image caused by improper projector to screen angle.

Maximum Distance — The distance from a screen the projector can be to cast an image that is usable (bright enough) in a fully darkened room.

Maximum Image Size — The largest image a projector can throw in a darkened room. This is usually limited by focal range of the optics.

Minimum Distance — The closest position that a projector can focus an image onto a screen.

NTSC — National Television Standards Committee. North American standard for video and broadcasting, with a video format of 525 lines at 30 frames per second.

PAL — Phase Alternating Line. A European broadcast standard for video and broadcasting, with a video format of 625 lines at 25 frames per second.

Reverse Image — Feature that allows you to flip the image horizontally. When used in a normal forward projection environment text, graphics, etc. are backwards. Reverse image is used for rear projection.

RGB — Red, Green, Blue — typically used to describe a monitor that requires separate signals for each of the three colors.

SECAM — A French and international broadcast standard for video and broadcasting, closely related to PAL but with a different method of sending color information.

SVGA — Super Video Graphics Array — 800 x 600 pixels count.

SXGA — Super Extended Graphics Array, — 1280 x 1024 pixels count.

UXGA — Ultra Extended Graphics Array — 1600 x 1200 pixels count.

VGA — Video Graphics Array — 640 x 480 pixels count.

WEP — Wired Equivalent Privacy — This is a method for encrypting communication data. The encryption key is created and notified only to the communicating user, so the communication data cannot be decrypted by a third party.

XGA — Extended Video Graphics Array — 1024 x 768 pixels count.

WXGA — Wide Extended Graphics Array — 1280 x 800 pixels count.

Index

A

- Adjusting Projector Focus 9
- Adjusting the Projected Image
 - Adjusting the Projector Height 8
 - lower the projector
 - Front tilt adjustment wheel 8
 - Tilt adjustment wheel 8
- Adjusting the Projector Zoom and Focus
 - Focus ring 9
 - Zoom tab 9

C

- Changing the Lamp 44
- Connecting the Projector
 - Audio cable 18
 - Composite Audio cable 20
 - Composite Video cable 20
 - HDMI cable 19
 - Power cord 18, 19, 20, 21, 22
 - To Computer 18
 - USB-A to Mini USB-B cable 22
 - VGA to VGA cable 18, 21
 - Wireless Display Adapter 22
- Connection Ports
 - +5 V DC out connector 6
 - Audio input connector 6

- Audio output connector 6
- Composite Video connector 6
- HDMI connector 6
- Mini USB (mini type B) connector for remote mouse and firmware upgrade 6
- Power cord connector 6
- VGA input (D-sub) connector 6
- VGA output (monitor loop through) connector 6

Contact Dell 4, 42, 44

D

- Dell
 - contacting 51, 52

M

- Main Unit 5
 - 2W Speaker 5
 - Focus ring 5
 - IR receivers 5
 - Lamp cover 5
 - Lens 5
 - Power button 5
 - Status indicators 5
 - Tilt adjustment wheel 5
 - Zoom tab 5

O

- On-Screen Display
 - ADVANCED SETTINGS 26
 - AUTO ADJUST 25
 - BRIGHTNESS/CONTRAST 25
 - HELP 38
 - INPUT SOURCE 24
 - LANGUAGE 38
 - Main Menu 24
 - VIDEO MODE 26
 - VOLUME 26

P

- phone numbers 51

R

- Remote Control 13

S

- Specifications
 - Aspect Ratio 46
 - Audio 47
 - Brightness 46
 - Color Wheel Speed 46
 - Contrast Ratio 46
 - Dimensions 47
 - Displayable Color 46
 - Environmental 47
 - I/O Connectors 47
 - Light Valve 46
 - Noise Level 47
 - Number of Pixels 46
 - Power Consumption 47

- Power Supply 47
- Projection Distance 46
- Projection Lens 46
- Projection Screen Size 46
- Projector Weight 47
- Uniformity 46
- Video Compatibility 46

support

- contacting Dell 51, 52

T

- telephone numbers 51
- Troubleshooting
 - Contact Dell 39

Free Manuals Download Website

<http://myh66.com>

<http://usermanuals.us>

<http://www.somanuals.com>

<http://www.4manuals.cc>

<http://www.manual-lib.com>

<http://www.404manual.com>

<http://www.luxmanual.com>

<http://aubethermostatmanual.com>

Golf course search by state

<http://golfingnear.com>

Email search by domain

<http://emailbydomain.com>

Auto manuals search

<http://auto.somanuals.com>

TV manuals search

<http://tv.somanuals.com>