

fx-83GT X

fx-85GT X

User's Guide

CASIO Worldwide Education Website

<https://edu.casio.com>

Manuals are available in multi languages at

<https://world.casio.com/manual/calc/>

Be sure to keep all user documentation handy for future reference.

Table of Contents

Before Using the Calculator	4
About this Manual.....	4
Initializing the Calculator.....	4
Precautions.....	4
Safety Precautions.....	4
Handling Precautions.....	5
Getting Started.....	5
Removing the Hard Case.....	5
Turning Power On and Off.....	5
Adjusting Display Contrast.....	6
Key Markings.....	6
Reading the Display.....	8
Using Menus.....	9
Calculation Modes and Calculator Setup	10
Calculation Mode.....	10
Configuring the Calculator Setup.....	11
Items and Available Setting Options.....	11
Initializing the Calculation Mode and Other Settings.....	16
Inputting Expressions and Values	17
Inputting a Calculation Expression Using Values.....	17
Inputting a Calculation Expression Using Standard Format.....	17
Correcting an Expression.....	18
Overwrite Input Mode (LineI/LineO or LineI/DecimalO only).....	19
Inputting an Expression Using Natural Textbook Format (MathI/MathO or MathI/DecimalO Only).....	20
Natural Textbook Format Input Examples.....	21
Undo Operations.....	22
Incorporating a Value into a Function.....	22
Displaying Calculation Results in a Form that Includes $\sqrt{2}$, π , etc. (Irrational Number Form).....	23
Basic Calculations	25
Recurring Decimal Calculations.....	25
Inputting a Recurring Decimal.....	25
Displaying a Calculation Result as a Recurring Decimal Value.....	26
Conditions for Displaying a Calculation Result as a Recurring Decimal.....	28
Recurring Decimal Examples.....	29
Toggling Calculation Results.....	30
Arithmetic Calculations.....	31
Number of Decimal Places and Number of Significant Digits.....	32
Omitting a Final Closed Parenthesis.....	32
Fraction Calculations.....	32

Switching between Improper Fraction and Mixed Fraction Format.....	34
Percent Calculations.....	34
Degree, Minute, Second (Sexagesimal) Calculations.....	36
Inputting Sexagesimal Values.....	36
Sexagesimal Calculations.....	36
Converting Values between Sexagesimal and Decimal.....	37
Multi-Statements.....	37
Using Engineering Notation.....	38
Prime Factorization.....	39
Calculation History and Replay.....	40
Calculation History.....	40
Replay.....	41
Using Memory Functions.....	42
Answer Memory (Ans).....	42
Variables (A, B, C, D, E, F, M, x , y).....	43
Independent Memory (M).....	44
Clearing the Contents of All Memories.....	46
Function Calculations.....	47
Pi (π), Natural Logarithm Base e	47
Pi (π).....	47
Natural Logarithm Base e	47
Trigonometric Functions, Inverse Trigonometric Functions.....	47
Trigonometric Functions.....	47
Inverse Trigonometric Functions.....	47
Hyperbolic Functions, Inverse Hyperbolic Functions.....	48
Hyperbolic Functions.....	48
Inverse Hyperbolic Functions.....	48
Converting an Input Value to the Calculator's Default Angle Unit.....	49
Exponential Functions, Logarithmic Functions.....	50
Exponential Functions.....	50
Logarithmic Functions.....	51
Power Functions and Power Root Functions.....	52
Rectangular-Polar Coordinate Conversion.....	53
Converting to Polar Coordinates (Pol).....	54
Converting to Rectangular Coordinates (Rec).....	54
Rectangular-Polar Coordinate Conversion Examples.....	54
Factorial (!).....	55
Absolute Value Calculation (Abs).....	56
Random Number (Ran#), Random Integer (RanInt#).....	56
Random Number (Ran#).....	56
Random Integer (RanInt#).....	57
Permutation (nPr) and Combination (nCr).....	57
Rounding Function (Rnd).....	58

Using Calculation Modes.....	60
Statistical Calculations.....	60
Inputting Data with Statistics Editor.....	61
Statistical Calculation Screen.....	64
Using the Statistical Menu.....	64
Displaying Statistical Values Based On Input Data.....	67
Displaying Regression Calculation Results Based On Input Data (Paired- Variable Data Only).....	67
Single-variable Statistical Calculation Commands.....	68
Single-variable Statistical Calculation Examples.....	69
Linear Regression Calculation ($y=a+bx$) Commands.....	72
Linear Regression Calculation Examples.....	74
Quadratic Regression Calculation ($y=a+bx+cx^2$) Commands.....	77
Quadratic Regression Calculation Examples.....	78
Logarithmic Regression Calculation ($y=a+b \cdot \ln(x)$) Commands.....	80
Logarithmic Regression Calculation Examples.....	80
e Exponential Regression Calculation ($y=a \cdot e^{(bx)}$) Commands.....	82
e Exponential Regression Calculation Examples.....	82
ab Exponential Regression Calculation ($y=a \cdot b^x$) Commands.....	84
ab Exponential Regression Calculation Examples.....	85
Power Regression Calculation ($y=a \cdot x^b$) Commands.....	87
Power Regression Calculation Examples.....	87
Inverse Regression Calculation ($y=a+b/x$) Commands.....	89
Inverse Regression Calculation Examples.....	90
Creating a Number Table.....	92
Configuring a Number Table Generation Function.....	92
Ratio Calculations.....	94
Changing the Ratio Expression Type.....	95
Ratio Mode Calculation Example.....	95
Technical Information.....	96
Errors.....	96
Displaying the Location of an Error.....	96
Clearing the Error Message.....	96
Error Messages.....	96
Before Assuming Malfunction of the Calculator... ..	98
Replacing the Battery.....	98
Calculation Priority Sequence.....	99
Stack Limitations.....	100
Calculation Ranges, Number of Digits, and Precision.....	100
Calculation Range and Precision.....	101
Function Calculation Input Ranges and Precision.....	101
Specifications.....	103
Frequently Asked Questions.....	105
Frequently Asked Questions.....	105

Before Using the Calculator

About this Manual

- In no event shall CASIO Computer Co., Ltd. be liable to anyone for special, collateral, incidental, or consequential damages in connection with or arising out of the purchase or use of this product and items that come with it.
- Moreover, CASIO Computer Co., Ltd. shall not be liable for any claim of any kind whatsoever by any other party arising out of the use of this product and the items that come with it.
- Unless specifically stated, all sample operations in this manual assume that the calculator is in its initial default setup. Use the procedure under “Initializing the Calculator” to return the calculator to its initial default setup.
- The contents of this manual are subject to change without notice.
- The displays and illustrations (such as key markings) shown in this manual are for illustrative purposes only, and may differ somewhat from the actual items they represent.
- Company and product names used in this manual may be registered trademarks or trademarks of their respective owners.

Initializing the Calculator

Perform the following procedure when you want to initialize the calculator and return the calculation mode and setup (except for the Contrast setting) to their initial default settings. Note that this operation also clears all data currently in calculator memory.

SHIFT **9** (RESET) **3** (Initialize All) **≡** (Yes)

Precautions

Be sure to read the following safety precautions before using the calculator.

Safety Precautions

Battery

- Keep batteries out of the reach of small children.

- Use only the type of battery specified for this calculator in this manual.

Handling Precautions

- fx-83GT X: Even if the calculator is operating normally, replace the battery at least once every two years (R03 (UM-4)).
fx-85GT X: Even if the calculator is operating normally, replace the battery at least once every three years (LR44).
A dead battery can leak, causing damage to and malfunction of the calculator. Never leave a dead battery in the calculator. Do not try using the calculator while the battery is completely dead (fx-85GT X).
- The battery that comes with the calculator discharges slightly during shipment and storage. Because of this, it may require replacement sooner than the normal expected battery life.
- Avoid use and storage of the calculator in areas subjected to temperature extremes, and large amounts of humidity and dust.
- Do not subject the calculator to excessive impact, pressure, or bending.
- Never try to take the calculator apart.
- Use a soft, dry cloth to clean the exterior of the calculator.
- Whenever discarding the calculator or batteries, be sure to do so in accordance with the laws and regulations in your particular area.

Getting Started

Removing the Hard Case

Before using the calculator, slide its hard case downwards to remove it, and then affix the hard case to the back of the calculator as shown in the illustration below.

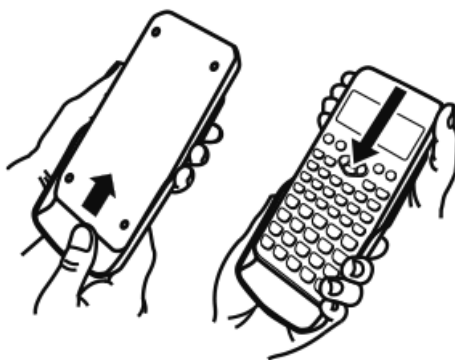

Turning Power On and Off

- Press **ON** to turn on the calculator.
- Press **SHIFT AC** (OFF) to turn off the calculator.

Note

- The calculator also will turn off automatically after approximately 10 minutes of non-use. Press the **ON** key to turn the calculator back on.

Adjusting Display Contrast

1. Press **SHIFT** **MENU** (SETUP).
 - This displays the setup menu.

```
1:Input/Output
2:Angle Unit
3:Number Format
4:Fraction Result
```

2. Press **▲**.

```
1:Digit Separator
2:MultiLine Font
3:Contrast
```

3. Press **3** (Contrast).
 - This displays the contrast adjustment screen.

```
Contrast
Light          Dark
[◀]           [▶]
```

4. Use **◀** and **▶** to adjust display contrast.
5. After the setting is the way you want, press **AC**.

Important!

- If adjusting display contrast does not improve display readability, it probably means that battery power is low. Replace the battery.

Key Markings

Pressing the **SHIFT** or **ALPHA** key followed by a second key performs the alternate function of the second key. The alternate function is indicated by the text printed above the key.

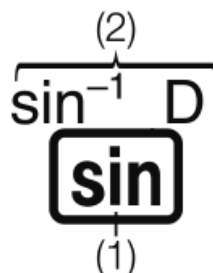

(1) Keycap function (2) Alternate function

- The following shows what the different colors of the alternate function key text mean.

If key marking text is this color:	It means this:
Yellow	Press SHIFT and then the key to access the applicable function.
Red	Press ALPHA and then the key to input the applicable variable, constant, function, or symbol.

- The following shows an example of how an alternate function operation is represented in this manual.





Example: **SHIFT** **sin** (\sin^{-1}) **1** **=**

* Indicates the function that is accessed by the key operation (**SHIFT** **sin**) before it. Note that this is not part of the actual key operation you perform.

- The following shows an example of how a key operation to select an on-screen menu item is represented in this manual.

Example: **1** (Input/Output)

* Indicates the menu item that is selected by the number key operation (**1**) before it. Note that this is not part of the actual key operation you perform.

- The cursor key is marked with four arrows, indicating direction, as shown in the illustration nearby. In this manual, cursor key operation is indicated as , , , and .



- Pressing the **OPTN** displays an options screen. The options screen shows functions that can be used in a calculation. The functions listed on the options screen depend on the calculation mode.

1:Hyperbolic Func
2:Angle Unit

Reading the Display

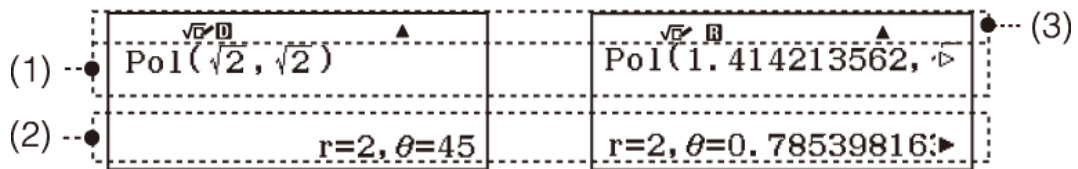



(1) Input expression

(2) Calculation result

(3) Indicators

- If a ► or ▷ indicator appears on the right side of either the input expression line (1) or calculation result line (2), it means the displayed line continues to the right. Use ◀ and ▶ to scroll the line display. Note that if you want to scroll the input expression while both the ► and ▷ indicators are displayed, you will need to press **AC** first and then use ◀ and ▶ to scroll.
- The table below describes some of the typical indicators that appear at the top of the screen (3).

This indicator:	Means this:
S	The keypad has been shifted by pressing the SHIFT key. The keypad will unshift and this indicator will disappear when you press a key.
A	The alpha input mode has been entered by pressing the ALPHA key. The alpha input mode will be exited and this indicator will disappear when you press a key.
D/R/G	Indicates the current setting of Angle Unit (D : Degree, R : Radian, or G : Gradian) on the setup menu.
FIX	A fixed number of decimal places is in effect.
SCI	A fixed number of significant digits is in effect.
M	There is a value stored in independent memory.
→x	The calculator is standing by for input of a variable name to assign a value to the variable. This indicator appears after you press STO .
√□	Indicates that MathI/MathO or MathI/DecimalO is selected for Input/Output on the setup menu.



	The display currently shows an intermediate result of a multi-statement calculation.
	This indicator is displayed while the calculator is being powered directly by its solar cells, either entirely or in some combination with the battery. (fx-85GT X only)

Using Menus

Some of the operations of this calculator are performed using menus. Menus are displayed by pressing **OPTN** or **SHIFT** and then **MENU** (SETUP). General menu operation operations are described below.

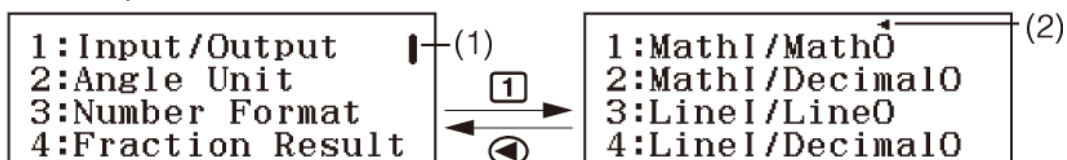
- You can select a menu item by pressing the number key that corresponds to the number to its left on the menu screen.







- A vertical scroll bar (1) indicates that the menu runs off the screen. In this case, you can use  and  to scroll the menu up and down. A left arrow (2) indicates that the currently displayed menu is a sub-menu. To return from a sub-menu to its parent menu, press .
- To close a menu without selecting anything, press **AC**.

Calculation Modes and Calculator Setup

Calculation Mode

The calculation modes of this calculator are described below.

Icon:	Description:
 (Calculate)	General calculations
 (Statistics)	Statistical and regression calculations
 (Table)	Generate a number table based on one or two functions
 (Ratio)	Ratio calculations

Specify the calculation mode that is suitable for the type of calculation you want to perform.

1. Press **MENU** to display the Main Menu.

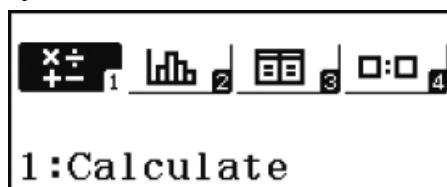

2. Use the cursor keys to move the highlighting to the icon you want.

3. Press **ENTER** to display the initial screen of the mode whose icon you selected.

Note

- You can also enter a mode without highlighting an icon in the Main Menu by inputting the number or letter marked in the lower right corner of the icon.
- The initial default calculation mode is the Calculate Mode.

Configuring the Calculator Setup

Pressing $\boxed{\text{SHIFT}} \boxed{\text{MENU}}$ (SETUP) displays the setup menu, which you can use to control how the calculations are executed and displayed.

To change the calculator setup

1. Press $\boxed{\text{SHIFT}} \boxed{\text{MENU}}$ (SETUP) to display the setup menu.
2. Use \blacktriangledown and \blacktriangle to scroll the setup menu, and then input the number displayed to the left of the item whose setting you want to change.

Items and Available Setting Options

“◆” indicates the initial default setting.

Input/Output

Specifies the format to be used by the calculator for formula input and calculation result output.

To specify this type of input and output:	Perform this key operation:
Input: Natural Textbook Output: Format that includes a fraction ^{*1}	$\boxed{\text{SHIFT}} \boxed{\text{MENU}}$ (SETUP) $\boxed{1}$ (Input/Output) $\boxed{1}$ (MathI/MathO)◆
Input: Natural Textbook Output: Converted to decimal value	$\boxed{\text{SHIFT}} \boxed{\text{MENU}}$ (SETUP) $\boxed{1}$ (Input/Output) $\boxed{2}$ (MathI/DecimalO)
Input: Linear ^{*2} Output: Decimal or fraction	$\boxed{\text{SHIFT}} \boxed{\text{MENU}}$ (SETUP) $\boxed{1}$ (Input/Output) $\boxed{3}$ (LineI/LineO)

Input: Linear*2 Output: Converted to decimal value	SHIFT MENU (SETUP) 1 (Input/Output) 4 (Line/DecimalO)
---	---

*1 Decimal output is applied when this format cannot be output for some reason.

*2 All calculations, including fractions and functions are input in a single line. Same output format as that for models without Natural Textbook Display (S-V.P.A.M. models, etc.)

Input/Output Format Display Examples

MathI/MathO

$$\frac{4}{5} + \frac{2}{3}$$

$$\frac{22}{15}$$

$$\frac{1 + \sqrt{2}}{\sqrt{2}}$$

$$\frac{2 + \sqrt{2}}{2}$$

MathI/DecimalO

$$\frac{4}{5} + \frac{2}{3}$$

$$1.466666667$$

$$\frac{1 + \sqrt{2}}{\sqrt{2}}$$

$$1.707106781$$

LineI/LineO

$$4 \div 5 + 2 \div 3$$

$$22 \div 15$$

$$(1 + \sqrt{2}) \div \sqrt{2}$$

$$1.707106781$$

LineI/DecimalO

$$4 \div 5 + 2 \div 3$$

$$1.466666667$$

$$(1 + \sqrt{2}) \div \sqrt{2}$$

$$1.707106781$$

Angle Unit

Specifies degree, radian or gradian as the angle unit for value input and calculation result display.

To specify this as the default angle unit:	Perform this key operation:
Degrees	SHIFT MENU (SETUP) 2 (Angle Unit) 1 (Degree) ◆
Radians	SHIFT MENU (SETUP) 2 (Angle Unit) 2 (Radian)

Grads	SHIFT MENU (SETUP) 2 (Angle Unit) 3 (Gradian)
-------	--

$90^\circ = \pi/2$ radians = 100 grads

Number Format

Specifies the number of digits for display of a calculation result.

To specify this:	Perform this key operation:
Number of Decimal Places	SHIFT MENU (SETUP) 3 (Number Format) 1 (Fix) 0 – 9
Number of Significant Digits	SHIFT MENU (SETUP) 3 (Number Format) 2 (Sci) 0 – 9
Exponential Display Range	SHIFT MENU (SETUP) 3 (Number Format) 3 (Norm) 1 (Norm 1♦) or 2 (Norm 2)

Calculation Result Display Examples

- Fix: The value you specify (from 0 to 9) controls the number of decimal places for displayed calculation results. Calculation results are rounded off to the specified digit before being displayed.

Example: $100 \div 7$ **SHIFT** **MODE** (\approx)* 14.286 (Fix 3)
14.29 (Fix 2)

- Sci: The value you specify (from 0 to 9) controls the number of significant digits for displayed calculation results. Calculation results are rounded off to the specified digit before being displayed.

Example: $1 \div 7$ **SHIFT** **MODE** (\approx)* 1.4286×10^{-1} (Sci 5)
 1.429×10^{-1} (Sci 4)

- Norm: Selecting one of the two available settings (Norm1, Norm2) determines the range in which results will be displayed in exponential format. Outside the specified range, results are displayed using non-exponential format.

Norm 1: $10^{-2} > |x|$, $|x| \geq 10^{10}$

Norm 2: $10^{-9} > |x|$, $|x| \geq 10^{10}$

Example: $1 \div 200$ **SHIFT** **MODE** (\approx)* 5×10^{-3} (Norm 1)
0.005 (Norm 2)

* Pressing **SHIFT** **MODE** (\approx) instead of **MODE** after inputting a calculation will display the calculation result in decimal form.

Fraction Result

Specifies either mixed fraction or improper fraction for display of fractions in calculation results.

To specify this fraction display format:	Perform this key operation:
Mixed	SHIFT MENU (SETUP) 4 (Fraction Result) 1 (ab/c)
Improper	SHIFT MENU (SETUP) 4 (Fraction Result) 2 (d/c)◆

Statistics

Specifies whether or not to display a Freq (frequency) column in the Statistics Mode Statistics Editor.

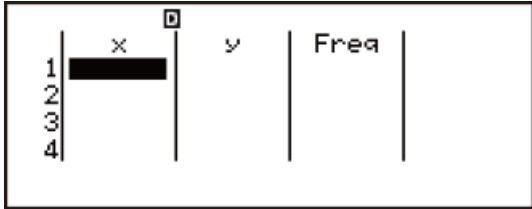
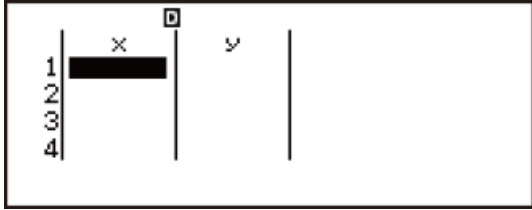
To specify this:	Perform this key operation:
Show frequency Column	SHIFT MENU (SETUP) 1 (Statistics) 1 (On) 
Hide frequency Column	SHIFT MENU (SETUP) 1 (Statistics) 2 (Off)◆ 

Table

Specifies whether to use function $f(x)$ only or the two functions $f(x)$ and $g(x)$ in the Table Mode.

To specify this:	Perform this key operation:
$f(x)$ only	SHIFT MENU (SETUP) 2 (Table) 1 ($f(x)$)
$f(x)$ and $g(x)$	SHIFT MENU (SETUP) 2 (Table) 2 ($f(x),g(x)$)◆

Recurring Dec

Specifies whether or not to use recurring decimal form in calculation results.

To specify this:	Perform this key operation:
Use recurring decimal form	SHIFT MENU (SETUP) ▼ 3 (Recurring Dec) 1 (On)◆
Do not use recurring decimal form	SHIFT MENU (SETUP) ▼ 3 (Recurring Dec) 2 (Off)

Decimal Mark

Specifies whether to display a dot or a comma for the calculation result decimal mark. A dot is always displayed during input.

To specify this decimal point display format:	Perform this key operation:
Dot (.)	SHIFT MENU (SETUP) ▼ 4 (Decimal Mark) 1 (Dot)◆
Comma (,)	SHIFT MENU (SETUP) ▼ 4 (Decimal Mark) 2 (Comma)

Note

- When dot is selected as the decimal mark, the separator for multiple results is a comma (,). When comma is selected, the separator is a semicolon (;).

Digit Separator

Specifies whether or not to use separator symbols in calculation results.

To specify this:	Perform this key operation:
Use three-digit separator character	SHIFT MENU (SETUP) ▼ ▼ 1 (Digit Separator) 1 (On)
Do not use three-digit separator character	SHIFT MENU (SETUP) ▼ ▼ 1 (Digit Separator) 2 (Off)◆

MultiLine Font

Specifies the display font size when LineI/LineO or LineI/DecimalO is selected for Input/Output. Up to four lines can be displayed while Normal Font is selected, and up to six lines can be displayed with Small Font.

To specify this:	Perform this key operation:
Use normal font	SHIFT MENU (SETUP) ▼ ▼ 2 (MultiLine Font) 1 (Normal Font) ◆
Use small font	SHIFT MENU (SETUP) ▼ ▼ 2 (MultiLine Font) 2 (Small Font)

Initializing the Calculation Mode and Other Settings

Performing the following procedure initializes the calculation mode and other setup settings as shown below. (except the Contrast setting)

SHIFT **9** (RESET) **1** (Setup Data) **☰** (Yes)

This setting:	Is initialized to this:
Calculation Mode	Calculate
Input/Output	MathI/MathO
Angle Unit	Degree
Number Format	Norm 1
Fraction Result	d/c
Statistics	Off
Table	$f(x),g(x)$
Recurring Dec	On
Decimal Mark	Dot
Digit Separator	Off
MultiLine Font	Normal Font

- To cancel initialization without doing anything, press **AC** (Cancel) instead of **☰**.

Inputting Expressions and Values

Inputting a Calculation Expression Using Values

Inputting a Calculation Expression Using Standard Format

Your calculator lets you input calculation expressions just as they are written. Then simply press the = key to execute it. The calculator automatically judges the calculation priority sequence for addition, subtraction, multiplication, and division, functions, and parentheses.

Example: $2(5 + 4) - 2 \times (-3) =$

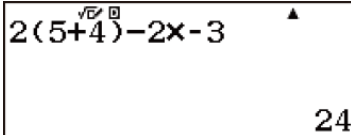
$$2 \text{ (} 5 \text{ + } 4 \text{) } \text{ - } 2 \text{ x } \text{ (-) } 3 \text{ =}$$

24

Note

- If you execute a calculation that includes both division and multiplication operations in which a multiplication sign has been omitted, parentheses will be inserted automatically as shown in the examples below.

- When a multiplication sign is omitted immediately before an open parenthesis or after a closed parenthesis.

Example: $6 \div 2(1 + 2) \rightarrow 6 \div (2(1 + 2))$

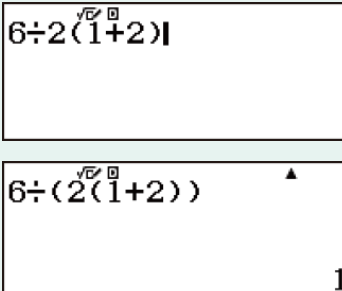

$$6 \text{ } \div \text{ } 2 \text{ (} 1 \text{ + } 2 \text{)}$$

1

- When a multiplication sign is omitted immediately before a variable, a constant, etc.

Example: $4\pi \div 2\pi \rightarrow 4\pi \div (2\pi)$

$$4 \text{ [SHIFT] [x10^-3] } (\pi) \text{ } \div \text{ } 2 \text{ [SHIFT] [x10^-3] } (\pi)$$

- Normally the input cursor appears as a straight vertical (|) or horizontal (—) flashing line on the display screen. When there are 10 or fewer bytes of input remaining in the current expression, the cursor changes shape to  to let you know. If the  cursor appears, terminate the expression at a convenient point and calculate the result.

Correcting an Expression

This section explains how to correct an expression as you are inputting it. The procedure you should use depends on the current Input/Output setting on the setup menu.

Changing the Character or Function You Just Input

Example: To correct the expression 369×13 so it becomes 369×12

Deleting a Character or Function

Example: To correct the expression $369 \times \times 12$ so it becomes 369×12

Correcting a Calculation

Example: To correct $\cos(60)$ so it becomes $\sin(60)$

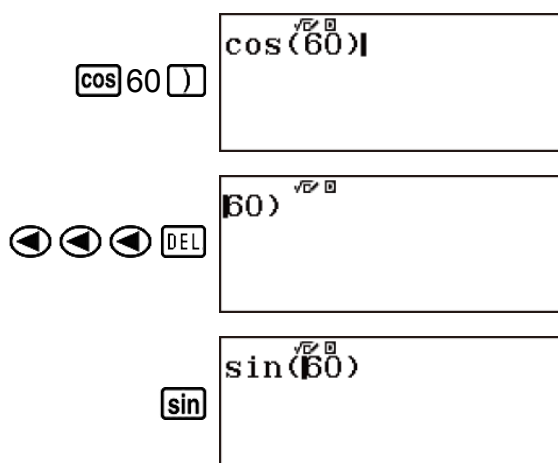

Inserting Input into a Calculation

Use **◀** and **▶** to move the cursor to the location where you want to insert the character or function and then input it. Be sure always to use the insert mode if **LineI/LineO** or **LineI/DecimalO** is selected.

Clearing all of the calculation you are inputting

Press **AC**.

Overwrite Input Mode (LineI/LineO or LineI/DecimalO only)

In the overwrite mode, text you input replaces the text at the current cursor location. You can toggle between the insert and overwrite modes by performing the operations: **SHIFT DEL** (INS). The cursor appears as **|** in the insert mode and as **_** in the overwrite mode.
(LineI/LineO or LineI/DecimalO)

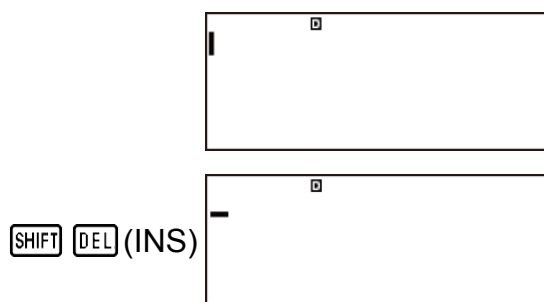

Deleting a Character or Function

Example: To correct the expression $369 \times \times 12$ so it becomes 369×12

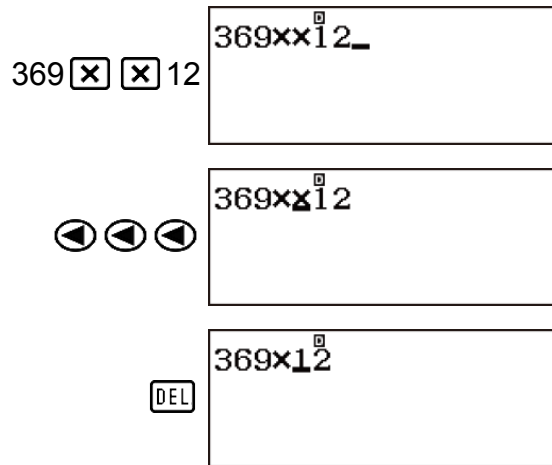

Correcting a Calculation

Example: To correct $\cos(60)$ so it becomes $\sin(60)$

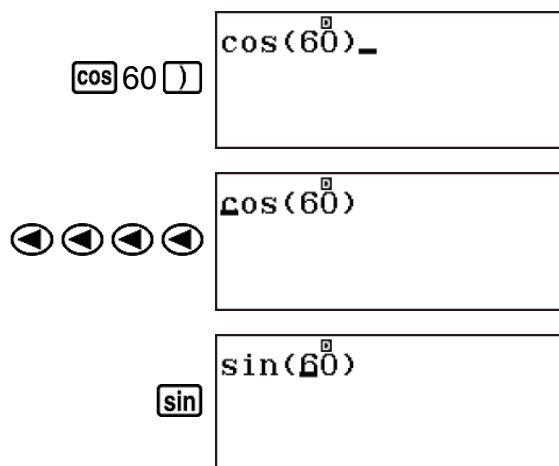

Inputting an Expression Using Natural Textbook Format (MathI/MathO or MathI/DecimalO Only)

Formulas and expressions that include fractions and/or special functions such as $\sqrt{\quad}$ can be input in natural textbook format by using templates that appear when certain keys are pressed.

Note

- When you press = and obtain a calculation result, part of the expression you input may be cut off. If you need to view the entire input expression again, press AC and then use ← and → to scroll the input expression.

Natural Textbook Format Input Examples

- Pay close attention to the location and size of the cursor on the display when you input using natural textbook format.

Example 1: To input $2^3 + 1$

2 $\boxed{x^{\square}}$ 3 2^{\square}

\blacktriangleright $\boxed{+}$ 1 $2^{\square} + 1^{\square}$

Example 2: To input $1 + \sqrt{2} + 3$

1 $\boxed{+}$ $\boxed{\sqrt{\square}}$ 2 $1 + \sqrt{2}^{\square}$

\blacktriangleright $\boxed{+}$ 3 $1 + \sqrt{2} + 3^{\square}$

Example 3: To input $3\frac{1}{2} + 5\frac{3}{2}$

$\boxed{\text{SHIFT}}$ $\boxed{\frac{\square}{\square}}$ ($\frac{\square}{\square}$) $\frac{\square}{\square}^{\square}$

3 \blacktriangleright 1 \blacktriangleright 2 $3\frac{1}{2}^{\square}$

\blacktriangleright $\boxed{+}$ $\boxed{\text{SHIFT}}$ $\boxed{\frac{\square}{\square}}$ ($\frac{\square}{\square}$) 5 \blacktriangleright 3 \blacktriangleright 2 $3\frac{1}{2} + 5\frac{3}{2}^{\square}$

Example 4: To input $(1 + \frac{2}{5})^2 \times 2$

$\boxed{(}$ 1 $\boxed{+}$ $\boxed{\frac{\square}{\square}}$ 2 \blacktriangledown 5 \blacktriangleright $\boxed{)}$ $\boxed{x^2}$ $\boxed{\times}$ 2 $(1 + \frac{2}{5})^2 \times 2^{\square}$

Example 5: To input $\frac{2 + \sqrt{2}}{1 + \sqrt{2}}$

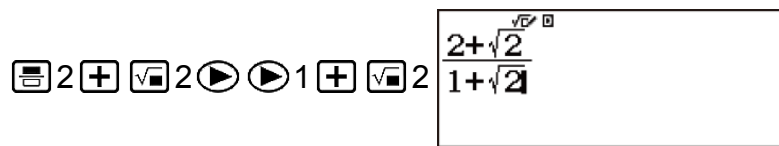

Tip: While the input cursor is located within the input area of a template (mixed fractions), pressing **SHIFT** **▶** jumps to the position immediately following (to the right) of the template, while pressing **SHIFT** **◀** jumps to the position immediate before (to the left of) it.

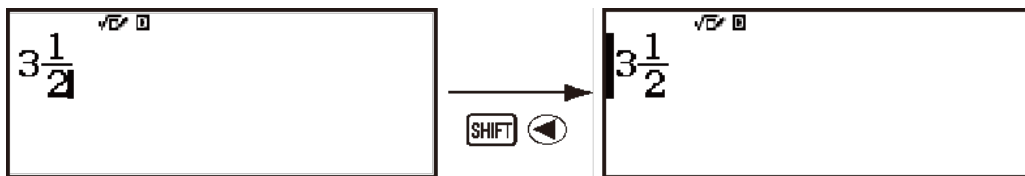

Undo Operations

To undo the last key operation, press **ALPHA** **DEL** (UNDO).

To redo a key operation you have just undone, press **ALPHA** **DEL** (UNDO) again.

Incorporating a Value into a Function

When using natural textbook format, you can incorporate part of an input expression (a value, an expression within parentheses, etc.) into a function.

Example: To incorporate the expression inside of the parentheses of $1 + (2 + 3) + 4$ into the $\sqrt{\quad}$ function

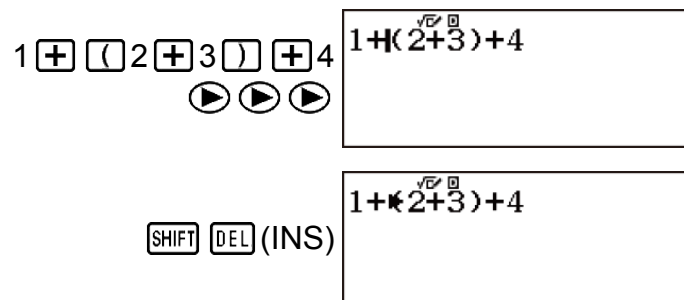

This changes the shape of the cursor as shown here.

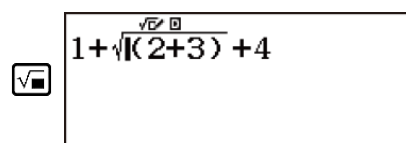

This incorporates the expression in the parentheses into the function $\sqrt{\quad}$.

Displaying Calculation Results in a Form that Includes $\sqrt{2}$, π , etc. (Irrational Number Form)

While MathI/MathO is selected for Input/Output on the setup menu, you can specify whether calculation results should be displayed in a form that includes expressions like $\sqrt{2}$ and π (irrational number form).

- Pressing $\boxed{\equiv}$ after inputting a calculation displays the result using irrational number form.
- Pressing $\boxed{\text{SHIFT}} \boxed{\equiv} (\approx)$ after inputting a calculation displays the result using decimal values.

Note

- When MathI/DecimalO or LineI/DecimalO is selected for Input/Output on the setup menu, calculation results are always displayed using decimal values (no irrational number form) regardless of whether you press $\boxed{\equiv}$ or $\boxed{\text{SHIFT}} \boxed{\equiv} (\approx)$.
- The following are the π forms that are supported.

$n\pi$ (n is an integer.)

$\frac{d}{c}\pi$ or $\frac{b}{c}\pi$ (depending on fraction display format setting)

Example 1: $\sqrt{2} + \sqrt{8} = 3\sqrt{2}$ (MathI/MathO)

$\boxed{\sqrt{\square}} \boxed{2} \boxed{\rightarrow} \boxed{+} \boxed{\sqrt{\square}} \boxed{8} \boxed{\equiv}$

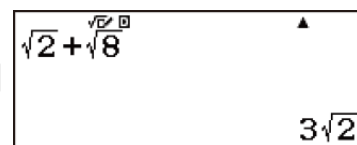

$\sqrt{2} + \sqrt{8}$
 $3\sqrt{2}$

$\boxed{\sqrt{\square}} \boxed{2} \boxed{\rightarrow} \boxed{+} \boxed{\sqrt{\square}} \boxed{8} \boxed{\text{SHIFT}} \boxed{\equiv} (\approx)$

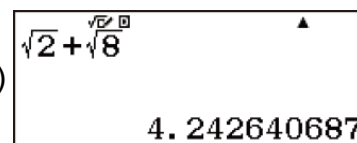

$\sqrt{2} + \sqrt{8}$
4.242640687

Example 2: $\sin(60) = \frac{\sqrt{3}}{2}$ (MathI/MathO) (Angle Unit: Degree)

$\boxed{\sin} \boxed{60} \boxed{)} \boxed{\equiv}$

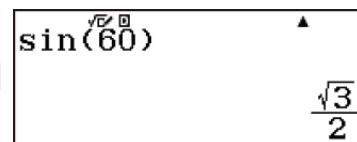

$\sin(60)$
 $\frac{\sqrt{3}}{2}$

Example 3: $\sin^{-1}(0.5) = \frac{1}{6}\pi$ (MathI/MathO) (Angle Unit: Radian)

SHIFT **sin** (sin⁻¹) 0.5 **)** **=**

$\sin^{-1}(0.5)$
$\frac{1}{6}\pi$

Basic Calculations

Recurring Decimal Calculations

Your calculator uses a recurring decimal when you input a value. Calculation results also can be displayed using recurring decimal form whenever applicable.

Inputting a Recurring Decimal

When inputting a recurrent decimal, press SHIFT x^2 (\blacksquare) before inputting its period (repetend) and then input the period up to the ending value. To input the recurring decimal $0.909090\dots$ ($0.\dot{9}0$), perform the following operation: “0 \square SHIFT x^2 (\blacksquare) 90”.

Important!

- If the value starts with an integer part (like: $12.3123123\dots$), do not include the integer part when inputting the period ($12.\dot{3}1\dot{2}$).
- Recurring decimal input is possible only when MathI/MathO or MathI/DecimalO is selected for Input/Output on the setup menu.

Example 1: To input $0.33333\dots$ ($0.\dot{3}$)

0 \square 0.

SHIFT x^2 (\blacksquare) 0.

3 0.3

Example 2: To input $1.428571428571\dots$ ($1.\dot{4}2857\dot{1}$)

1 \square SHIFT x^2 (\blacksquare) 1.

428571

Example 3: To calculate $1.\dot{0}2\dot{1} + 2.\dot{3}1\dot{2}$

1 $\frac{\square}{\square}$ [SHIFT] x^2 ($\dot{\square}$) 021 [▶] [+]
 2 $\frac{\square}{\square}$ [SHIFT] x^2 ($\dot{\square}$) 312 [=]

Calculation result displayed as recurring decimal value:

[S+D]

Displaying a Calculation Result as a Recurring Decimal Value

Calculation results that can be displayed as recurring decimal values will be displayed as such when On is selected for the Recurring Dec setting on the setup menu.

Pressing the [S+D] key will cycle between the available calculation result formats.

Example 1: $\frac{1}{7} = 0.\dot{1}4285\dot{7} = 0.1428571429$ (Number Format: Norm 1)

1 $\frac{\square}{\square}$ 7 [=]

Display as recurring decimal:

[S+D]

Decimal value according to Norm 1 setting:

[S+D]

Return to initial display format (fraction):

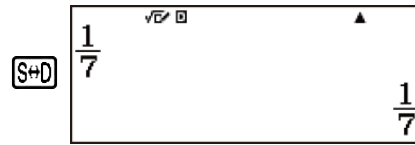

Example 2: $1 \div 7 = \frac{1}{7} = 0.\dot{1}4285\dot{7} = 0.1428571429$ (Number Format: Norm 1)

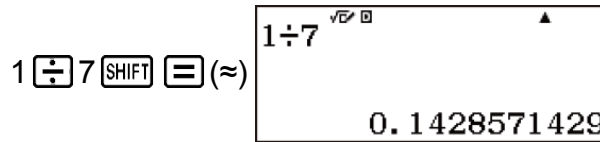

Display as fraction:



Display as recurring decimal:

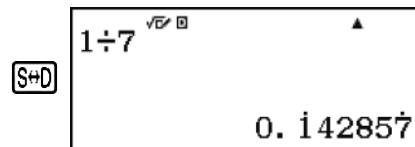

Return to initial display format (Norm 1):

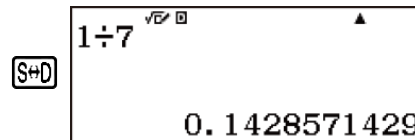

Example 3: $\frac{1}{7} = 0.\dot{1}4285\dot{7} = 0.1428571429$ (Norm 1)
(LineI/LineO)

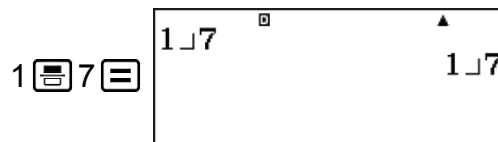

Display as recurring decimal:

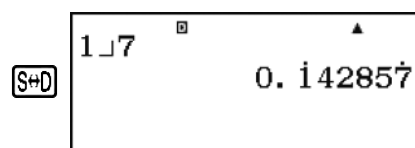

Decimal value according to Norm 1 setting:

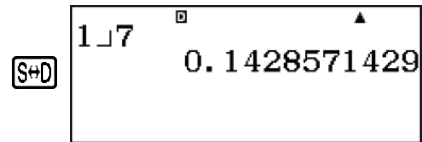

Return to initial display format (fraction):



Example 4: $1 \div 7 = 0.1428571429$ (Norm 1) = $0.\dot{1}4285\dot{7} = \frac{1}{7}$

(LineI/LineO)

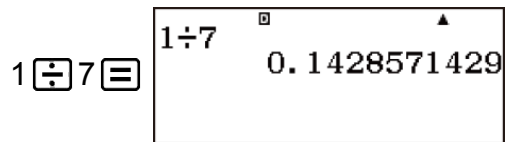

Display as fraction:

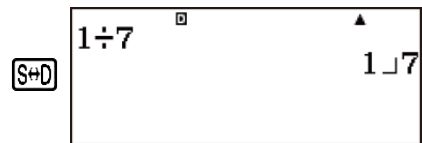

Display as recurring decimal:

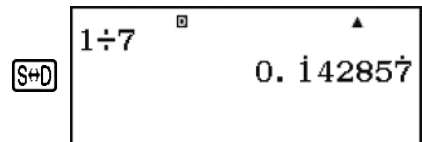

Return to initial display format (Norm 1):

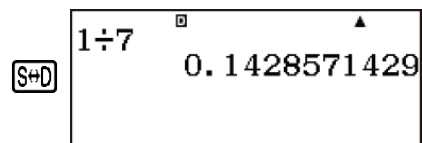

Conditions for Displaying a Calculation Result as a Recurring Decimal

If a calculation result satisfies the following conditions, pressing $\boxed{S \rightarrow D}$ will display it as a recurring decimal value.

- The total number of digits used in the mixed fraction (including integer, numerator, denominator, and separator symbol) must be no more than 10.

Recurring Decimal Examples

Example 1: $0.\dot{3} + 0.\dot{45} = 0.\dot{78}$

0 \cdot SHIFT x^2 $(\dot{})$ 3 ▶ $+$
 0 \cdot SHIFT x^2 $(\dot{})$ 45 $=$ S+D

$0.\dot{3} + 0.\dot{45}$
$0.\dot{78}$

Example 2: $1.\dot{6} + 2.\dot{8} = 4.\dot{5}$

1 \cdot SHIFT x^2 $(\dot{})$ 6 ▶ $+$
 2 \cdot SHIFT x^2 $(\dot{})$ 8 $=$ S+D

$1.\dot{6} + 2.\dot{8}$
$4.\dot{5}$

Example 3: To confirm the following: $0.\dot{123} = \frac{123}{999}$, $0.\dot{1234} = \frac{1234}{9999}$,

$$0.\dot{12345} = \frac{12345}{99999}$$

123 $\text{=} 999$ $=$

$\frac{123}{999}$
$\frac{41}{333}$

S+D

$\frac{123}{999}$
$0.\dot{123}$

1234 $\text{=} 9999$ $=$

$\frac{1234}{9999}$
$\frac{1234}{9999}$

S+D

$\frac{1234}{9999}$
$0.\dot{1234}$

12345 $\text{=} 99999$ $=$

$\frac{12345}{99999}$
$\frac{4115}{33333}$

S+D

$\frac{12345}{99999}$
$0.\dot{12345}$

Toggling Calculation Results

While MathI/MathO or MathI/DecimalO is selected for Input/Output on the setup menu, each press of $\boxed{S+D}$ will toggle the currently displayed calculation result between its fraction form and decimal form, its $\sqrt{\quad}$ form and decimal form, or its π form and decimal form.

Example 1: Fraction \rightarrow Decimal (MathI/MathO) (Recurring Dec: Off)

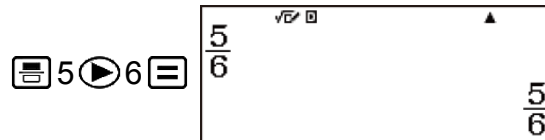

Each press of the $\boxed{S+D}$ key toggles between the two forms.

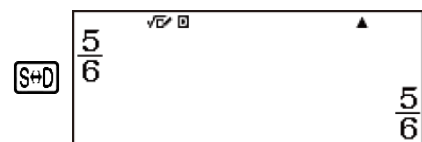
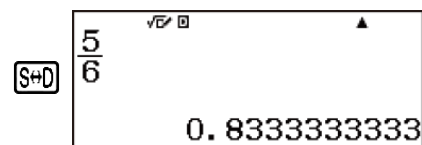

The format of the fraction depends on the currently selected Fraction Result setting (improper fraction or mixed fraction).

Example 2: $\pi \div 6 = \frac{1}{6} \pi = 0.5235987756$ (MathI/MathO)

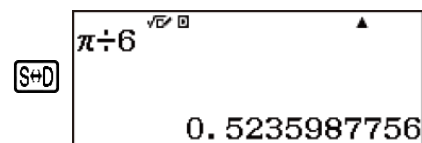
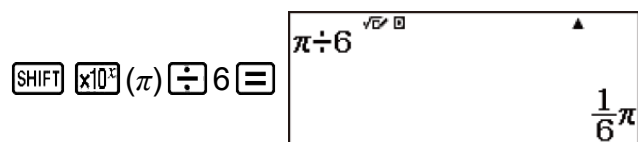

Example 3: $(\sqrt{2} + 2) \times \sqrt{3} = 5.913591358 = \sqrt{6} + 2\sqrt{3}$
(MathI/DecimalO)

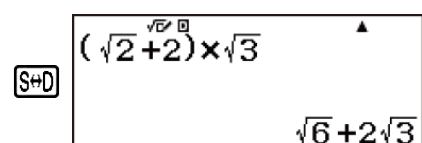
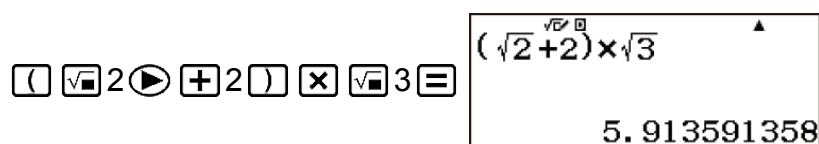

While LineI/LineO or LineI/DecimalO is selected for Input/Output on the setup menu, each press of $\boxed{S+D}$ will toggle the currently displayed calculation result between its decimal form and fraction form.

Example 4: $1 \div 5 = 0.2 = \frac{1}{5}$ (LineI/LineO)

1 $\boxed{\div}$ 5 $\boxed{=}$

1 \div 5	0.2
------------	-----

$\boxed{S+D}$

1 \div 5	$1 \div 5$
------------	------------

Example 5: $1 - \frac{4}{5} = \frac{1}{5} = 0.2$ (LineI/LineO)

1 $\boxed{-}$ 4 $\boxed{\div}$ 5 $\boxed{=}$

1 - 4 \div 5	$1 \div 5$
----------------	------------

$\boxed{S+D}$

1 - 4 \div 5	0.2
----------------	-----

Important!

- With certain calculation results, pressing the $\boxed{S+D}$ key will not convert the displayed value.
- You cannot switch from decimal form to mixed fraction form if the total number of digits used in the mixed fraction (including integer, numerator, denominator, and separator symbol) is greater than 10.

To obtain a decimal value calculation result while MathI/MathO or LineI/LineO is selected

Press $\boxed{SHIFT} \boxed{=}$ (\approx) instead of $\boxed{=}$ after inputting a calculation.

Arithmetic Calculations

Use the $\boxed{+}$, $\boxed{-}$, $\boxed{\times}$, and $\boxed{\div}$ keys to perform arithmetic calculations.

Example: To divide the result of $7 \times 8 - 4 \times 5 = 36$

$$7 \times 8 - 4 \times 5 = 36$$

- The calculator automatically judges the calculation priority sequence.

Number of Decimal Places and Number of Significant Digits

You can specify a fixed number of decimal places and significant digits for the calculation result.

Example: $1 \div 6 =$

Initial default setting (Norm 1)

$$1 \div 6 \approx 0.1666666667$$

3 decimal places (Fix 3)

$$1 \div 6 \approx 0.167$$

3 significant digits (Sci 3)

$$1 \div 6 \approx 1.67 \times 10^{-1}$$

Omitting a Final Closed Parenthesis

Example: $(2 + 3) \times (4 - 1) = 15$

$$(2 + 3) \times (4 - 1) = 15$$

Fraction Calculations

Note that the input method for fractions depends on the current Input/Output setting on the setup menu.

	Improper Fraction	Mixed Fraction
MathI/MathO MathI/DecimalO	$\frac{7}{3}$ ($\frac{7}{3}$ or $\frac{7}{3}$) ($\frac{7}{3}$ or $\frac{7}{3}$)	$2\frac{1}{3}$ ($\frac{2}{3}$) ($\frac{1}{3}$) 2 ($\frac{1}{3}$) 3 or ($\frac{2}{3}$) ($\frac{1}{3}$) 2 ($\frac{1}{3}$) 3)
LineI/LineO LineI/DecimalO	$\begin{array}{c} 7 \quad 3 \\ \diagdown \quad \diagup \\ \text{Numerator Denominator} \\ (7 \quad 3) \end{array}$	$\begin{array}{c} 2 \quad 1 \quad 3 \\ \diagdown \quad \diagup \quad \diagdown \\ \text{Integer Part Numerator Denominator} \\ (2 \quad 1 \quad 3) \end{array}$

Note

- Under initial default settings, fractions are displayed as improper fractions.
- Mixing fractions and decimal values in a calculation while something other than MathI/MathO is selected will cause the result to be displayed as a decimal value.
- Fractions in calculation results are displayed after being reduced to their lowest terms.

Example 1: $\frac{2}{3} + \frac{1}{2} = \frac{7}{6}$

(MathI/MathO)

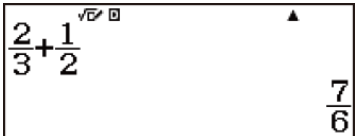
$\frac{2}{3} + \frac{1}{2}$

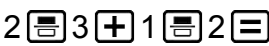
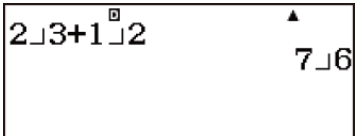

(LineI/LineO)

$2 \frac{1}{3} + 1 \frac{1}{2}$

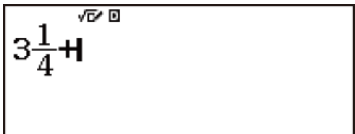

Example 2: $3\frac{1}{4} + 1\frac{2}{3} = 4\frac{11}{12}$ (Fraction Result: ab/c)

(MathI/MathO)

$3\frac{1}{4} + 1\frac{2}{3}$



$\boxed{\text{SHIFT}} \boxed{\frac{\square}{\square}} (\boxed{\frac{\square}{\square}}) 1 \boxed{\rightarrow} 2 \boxed{\downarrow} 3 \boxed{=}$

$$3\frac{1}{4} + 1\frac{2}{3}$$

$$4\frac{11}{12}$$

(LineI/LineO)

$3 \boxed{\frac{\square}{\square}} 1 \boxed{\frac{\square}{\square}} 4 \boxed{+} 1 \boxed{\frac{\square}{\square}} 2 \boxed{\frac{\square}{\square}} 3 \boxed{=}$

$$3\frac{1}{4} + 1\frac{2}{3}$$

$$4\frac{11}{12}$$

Example 3: $4 - 3\frac{1}{2} = \frac{1}{2}$ (Fraction Result: ab/c)

(MathI/MathO)

$4 \boxed{-} \boxed{\text{SHIFT}} \boxed{\frac{\square}{\square}} (\boxed{\frac{\square}{\square}}) 3 \boxed{\rightarrow} 1 \boxed{\downarrow} 2 \boxed{=}$

$$4 - 3\frac{1}{2}$$

$$\frac{1}{2}$$

(LineI/LineO)

$4 \boxed{-} 3 \boxed{\frac{\square}{\square}} 1 \boxed{\frac{\square}{\square}} 2 \boxed{=}$

$$4 - 3\frac{1}{2}$$

$$1\frac{1}{2}$$

Note

- If the total number of digits used for a mixed fraction (including integer, numerator, denominator, and separator symbols) is greater than 10, the value is automatically displayed in decimal format.
- The result of a calculation that involves both fraction and decimal values is displayed in decimal format.

Switching between Improper Fraction and Mixed Fraction Format

Pressing the $\boxed{\text{SHIFT}} \boxed{\text{S}\frac{\square}{\square}} (a\frac{b}{c} + \frac{d}{c})$ key toggles the display fraction between mixed fraction and improper fraction format.

Percent Calculations

Inputting a value and pressing $\boxed{\text{SHIFT}} \boxed{\text{Ans}} (\%)$ causes the input value to become a percent.

Example 1: $2\% = 0.02 (\frac{2}{100})$

2 [SHIFT] [Ans] (%) [SHIFT] [=] (≈)

2%	0.02
----	------

Example 2: $150 \times 20\% = 30$ ($150 \times \frac{20}{100}$)

150 [×] 20 [SHIFT] [Ans] (%) [=]

150×20%	30
---------	----

Example 3: Calculate what percentage of 880 is 660. (75%)

660 [÷] 880 [SHIFT] [Ans] (%) [=]

660÷880%	75
----------	----

Example 4: Increase 2500 by 15%. (2875)

2500 [+] 2500 [×] 15 [SHIFT] [Ans] (%) [=]

2500+2500×15%	2875
---------------	------

Example 5: Discount 3500 by 25%. (2625)

3500 [-] 3500 [×] 25 [SHIFT] [Ans] (%) [=]

3500-3500×25%	2625
---------------	------

Example 6: Discount the sum of 168, 98, and 734 by 20%. (800)

168 [+] 98 [+] 734 [=]

168+98+734	1000
------------	------

[=] [Ans] [×] 20 [SHIFT] [Ans] (%) [=]

Ans-Ans×20%	800
-------------	-----

Example 7: 300 grams are added to a test sample originally weighing 500 grams, producing a final test sample of 800 grams. What percent of 500 grams is 800 grams? (160%)

$$\boxed{(500 + 300) \div 500} \text{SHIFT} \text{Ans} (\%) =$$

$(500+300) \div 500\%$
160

Example 8: What is the percentage change when a value is increased from 40 to 46? How about to 48? (15%, 20%)

$$\boxed{(46 - 40) \div 40} \text{SHIFT} \text{Ans} (\%) =$$

$(46-40) \div 40\%$
15

$$\text{▶▶▶▶} \text{DEL} 8 =$$

$(48-40) \div 40\%$
20

Degree, Minute, Second (Sexagesimal) Calculations

You can perform calculations using sexagesimal values, and convert values between sexagesimal and decimal.

Inputting Sexagesimal Values

The following is the syntax for inputting a sexagesimal value.

{Degrees} $^{\circ}$ {Minutes} $'$ {Seconds} $''$

- Note that you must always input something for the degrees and minutes, even if they are zero.

Example: Input 2°0'30"

$$2^{\circ} 0' 30'' =$$

$2^{\circ} 0' 30''$
2° 0' 30''

Sexagesimal Calculations

Performing the following types of sexagesimal calculations produces a sexagesimal result.

- Addition or subtraction of two sexagesimal values
- Multiplication or division of a sexagesimal value and a decimal value

Example: 2°20'30" + 39'30" = 3°00'00"

$$2 \text{ [DMS]} 20 \text{ [DMS]} 30 \text{ [DMS]} + 0 \text{ [DMS]} 39 \text{ [DMS]} 30 \text{ [DMS]} =$$

$$2^{\circ} 20' 30'' + 0^{\circ} 39' 30'' = 3^{\circ} 0' 0''$$

Converting Values between Sexagesimal and Decimal

Pressing [DMS] while a calculation result is displayed toggles the value between sexagesimal and decimal.

Example: Convert 2.255 to its sexagesimal equivalent.

$$2.255 \text{ [SHIFT]} \text{[DMS]} (\approx)$$

The first screenshot shows the decimal value 2.255. Pressing $\text{[SHIFT]} \text{[DMS]}$ results in the second screenshot, which displays the sexagesimal equivalent $2^{\circ} 15' 18''$. Pressing [DMS] again results in the third screenshot, which displays the decimal value 2.255.

Multi-Statements

You can use the colon character (:) to connect two or more expressions and execute them in sequence from left to right when you press [DMS] .

Example: To create a multi-statement that performs the following two calculations: $3 + 3$ and 3×3 (MathI/MathO)

$$3 \text{ [DMS]} + 3 \text{ [ALPHA]} \text{[x^3]} (:) 3 \text{ [DMS]} \times 3 \text{ [DMS]} =$$

The calculator screen shows the expression $3+3$ followed by a newline operation (indicated by a small square icon) and then 3×3 . The results are 6 and 9.

“ \square ” indicates this is an intermediate result of a multi-statement.

The calculator screen shows the expression 3×3 followed by a newline operation (indicated by a small square icon) and the result 9.

Note

- Inputting a colon (:) while LineI/LineO or LineI/DecimalO is selected for the Input/Output setting on the setup menu causes a newline operation to be performed.

(Line/LineO)

3 $\boxed{+}$ 3 $\boxed{\text{ALPHA}}$ $\boxed{x^3}$ (:) 3 $\boxed{\times}$ 3 $\boxed{=}$



3+3:
3x3
6

“ $\boxed{\text{II}}$ ” indicates this is an intermediate result of a multi-statement.



3+3:
3x3
9

Using Engineering Notation

A simple key operation transforms a displayed value to engineering notation. Engineering notation converts the exponent part of a displayed calculation result value to a power of ten that is a multiple of 3, and displays the result.

Example 1: Transform the value 1234 to engineering notation, shifting the decimal point to the right.

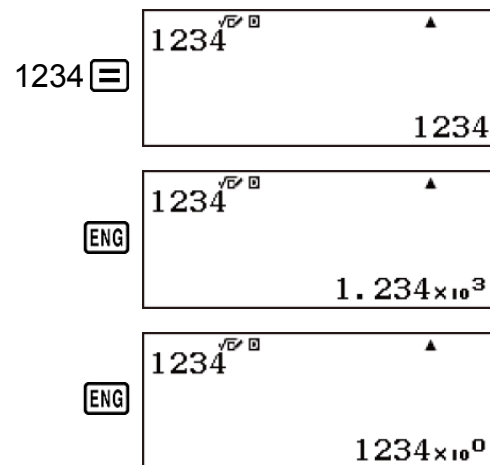

1234 $\boxed{=}$ 1234^{√E} 1234

$\boxed{\text{ENG}}$ 1234^{√E} 1.234 × 10³

$\boxed{\text{ENG}}$ 1234^{√E} 1234 × 10⁰

Example 2: Transform the value 123 to engineering notation, shifting the decimal point to the left.

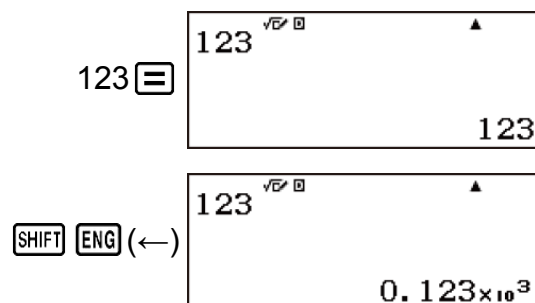

123 $\boxed{=}$ 123^{√E} 123

$\boxed{\text{SHIFT}} \boxed{\text{ENG}} (\leftarrow)$ 123^{√E} 0.123 × 10³

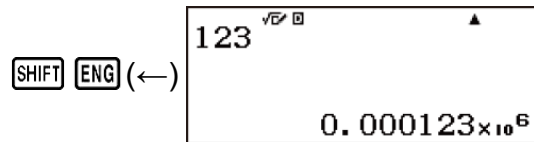

Prime Factorization

In the Calculate Mode, a positive integer no more than 10 digits long can be factored to prime factors.

Example: To perform prime factorization on 1014

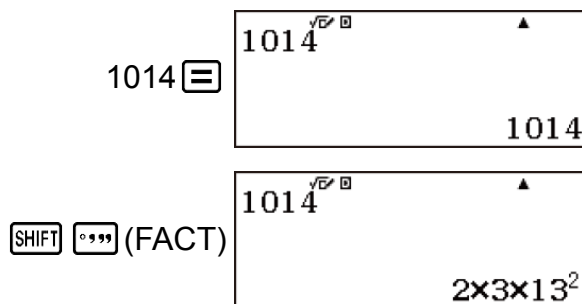

- To re-display the unfactored value, press \square \square (FACT) or \square .

Example: To perform prime factorization on 4104676 (= 2² × 1013²)

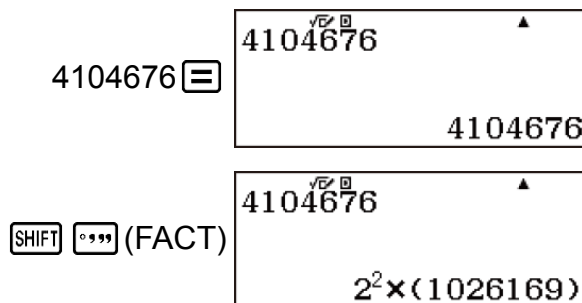

Any one of the following operations will exit prime factorization result display.

- Pressing \square \square (FACT) or \square .
- Pressing any of the following keys: \square or \square .

Note

- The types of values described below cannot be factored, even if they have 10 or fewer digits.
 - One of the prime factors of the value is 1018081 or greater.
 - Two or more of the prime factors of the value have more than three digits.
- The part that cannot be factored will be enclosed in parentheses on the display.

Calculation History and Replay

Calculation History

An ▲ and/or ▼ at the top of the display indicates that there is more calculation history content above and/or below. You can scroll through calculation history contents using ▲ and ▼.

Note that calculation history can be used in the Calculate Mode only.

Example: (MathI/MathO)

(1 + 1 = 2)

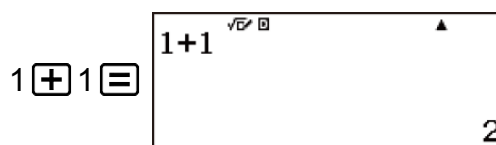

(2 + 2 = 4)

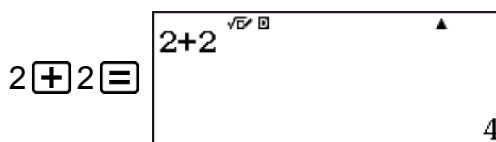

(3 + 3 = 6)

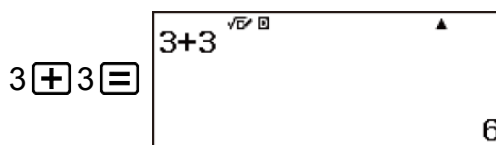

(Scrolls back.) ▲

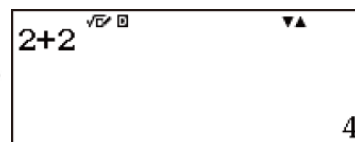

(Scrolls back again.) ▲

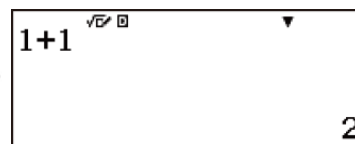

Note

- Calculation history data is all cleared whenever you press [ON], when you change to a different calculation mode, when you change the Input/Output setting, or whenever you perform a RESET operation (“Initialize All” or “Setup Data”).
- Calculation history memory is limited. When the calculation you are performing causes calculation history memory to become full, the oldest calculation is deleted automatically to make room for the new calculation.

Replay

While a calculation result is on the display, you can press ◀ or ▶ to edit the expression you used for the previous calculation.

Example: $4 \times 3 + 2 = 14$
 $4 \times 3 - 7 = 5$

The diagram illustrates the process of editing a calculation on a calculator display. It consists of four sequential display states:

- The first display shows the expression $4 \times 3 + 2$ and the result 14 . To the left of the display, the sequence of button presses is shown as $4 \times 3 + 2 =$.
- The second display shows the expression $4 \times 3 + 2$ with a left arrow (◀) pointing to the right side of the expression. To the left of the display, a left arrow (◀) is shown.
- The third display shows the expression 4×3 with a right arrow (▶) pointing to the right side of the expression. To the left of the display, two DEL buttons are shown.
- The fourth display shows the expression $4 \times 3 - 7$ and the result 5 . To the left of the display, the sequence of button presses is shown as $= 7 =$.

Note

- If you want to edit a calculation when the ▶ indicator is on the right side of a calculation result display, press AC and then use ◀ or ▶ to scroll the calculation.

Example: $\text{Pol}(2, \sqrt{2}) \rightarrow \text{Pol}(2, 2)$
 (MathI/MathO) (Angle Unit: Radian)

The diagram illustrates the process of editing a polar coordinate calculation on a calculator display. It consists of four sequential display states:

- The first display shows the expression $\text{Pol}(2, \sqrt{2})$ and the result $r=2.449489743, \theta=$. To the left of the display, the sequence of button presses is shown as $\text{SHIFT} + (\text{Pol}) 2 \text{SHIFT}) (, \sqrt{\square} 2 \text{SHIFT}) =$.
- The second display shows the expression $\text{Pol}(2, \sqrt{2})$ with a right arrow (▶) pointing to the right side of the expression. To the left of the display, the AC button and a left arrow (◀) are shown.
- The third display shows the expression $\text{Pol}(2, \sqrt{2})$ with a right arrow (▶) pointing to the right side of the expression. To the left of the display, a left arrow (◀), DEL, and DEL buttons are shown.
- The fourth display shows the expression $\text{Pol}(2, 2)$ and the result $r=2.828427125, \theta=$. To the left of the display, the number 2 and the = button are shown.

Using Memory Functions

Answer Memory (Ans)

The last calculation result obtained is stored in Ans (answer) memory.

Note

- Ans Memory contents are updated whenever you execute a calculation using any one of the following keys: $\boxed{=}$, $\boxed{\text{SHIFT}} \boxed{=}$ (\approx), $\boxed{\text{M}+}$, $\boxed{\text{SHIFT}} \boxed{\text{M}+}$ ($\text{M}-$), $\boxed{\text{SHIFT}} \boxed{\text{STO}}$ (RECALL), $\boxed{\text{STO}}$.
- Ans Memory contents are not change if an error occurs during the current calculation.

Using Ans Memory to Perform a Series of Calculations

Example: To divide the result of 3×4 by 30

$$3 \boxed{\times} 4 \boxed{=}$$

The calculator display shows the expression 3×4 and the result 12.

(Continuing) $\boxed{\div} 30 \boxed{=}$

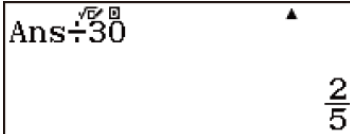

The calculator display shows the expression $\text{Ans} \div 30$ and the result $\frac{2}{5}$.

Pressing $\boxed{\div}$ automatically inputs “Ans” command.

- With the above procedure, you need to perform the second calculation immediately after the first one. If you need to recall Ans Memory contents after pressing $\boxed{\text{AC}}$, press the $\boxed{\text{Ans}}$ key.

Inputting Ans Memory Contents into an Expression

Example: To perform the calculations shown below:

$$123 + 456 = 579 \quad 789 - 579 = 210$$

A diagram shows a line connecting the result 579 of the first calculation to the second calculation, which uses 579 as a constant.

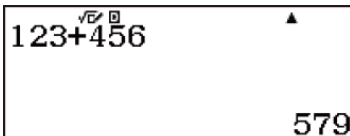
$$123 \boxed{+} 456 \boxed{=}$$

The calculator display shows the expression $123 + 456$ and the result 579.

(Continuing) $789 \boxed{-} \boxed{\text{Ans}} \boxed{=}$

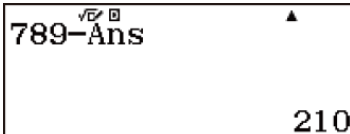

The calculator display shows the expression $789 - \text{Ans}$ and the result 210.

Variables (A, B, C, D, E, F, M, x, y)

Your calculator has nine preset variables named A, B, C, D, E, F, M, x, and y.

You can assign values to variables and use the variables in calculations.

- You can assign a specific value or a calculation result to a variable.

Example: To assign the result of $3 + 5$ to variable A.

3 $\boxed{+}$ 5 $\boxed{\text{STO}}$ $\boxed{\text{A}}$ (A)



The calculator screen displays the expression $3+5 \rightarrow A$ and the result 8.

Example: To assign the result of 4×6 to variable x.

4 $\boxed{\times}$ 6 $\boxed{\text{STO}}$ \boxed{x} (x)

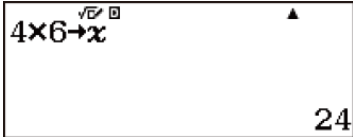

The calculator screen displays the expression $4 \times 6 \rightarrow x$ and the result 24.

- Use the following procedure when you want to check the contents of a variable.

Example: To recall the contents of variable A

(Continuing) $\boxed{\text{SHIFT}}$ $\boxed{\text{STO}}$ (RECALL)*1

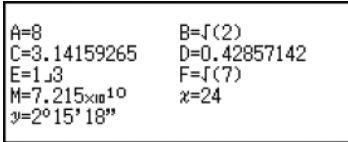

The calculator screen displays the following variable values:

A=8	B=f(2)
C=3.14159265	D=0.42857142
E=1.3	F=f(7)
M=7.215x10 ¹⁰	x=24
y=2 ¹⁵ *18"	

$\boxed{\text{A}}$ $\boxed{\text{A}}$ $\boxed{=}$



The calculator screen displays the value of variable A, which is 8.

- *1 Pressing $\boxed{\text{SHIFT}}$ $\boxed{\text{STO}}$ (RECALL) displays a screen that shows the values currently assigned to variables A, B, C, D, E, F, M, x, and y. On this screen, values are always displayed using the "Norm 1" Number Format. To close the screen without recalling a variable value, press $\boxed{\text{AC}}$.

- The following shows how you can include variables inside of an expression.

Example: To multiply the contents of variable A by the contents of variable B

(Continuing) 1 $\boxed{+}$ 2 $\boxed{\text{STO}}$ $\boxed{\text{B}}$ (B)

$\boxed{\text{ALPHA}}$ $\boxed{\text{A}}$ $\boxed{\times}$ $\boxed{\text{ALPHA}}$ $\boxed{\text{B}}$ $\boxed{=}$ *2





The calculator screen displays the expression $A \times B$ and the result 24.

*2 Input a variable as shown here: press $\boxed{\text{ALPHA}}$ and then press the key that corresponds to the desired variable name. To input x as the variable name, you can press $\boxed{\text{ALPHA}} \boxed{X}$ (x).

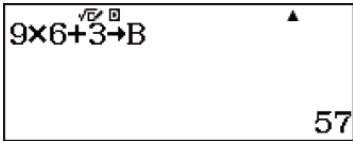
Example: $\frac{9 \times 6 + 3}{5 \times 8} = 1.425$

$9 \boxed{\times} 6 \boxed{+} 3 \boxed{\text{STO}} \boxed{\text{ALPHA}} \boxed{B}$



$5 \boxed{\times} 8 \boxed{\text{STO}} \boxed{\text{ALPHA}} \boxed{X}$ (x)
 

$\boxed{\text{ALPHA}} \boxed{\text{ALPHA}} \boxed{B} \boxed{\div} \boxed{\text{ALPHA}} \boxed{X}$ (x) $\boxed{\text{SHIFT}} \boxed{=}$ (\approx)
 

Clearing the Contents of a Specific Variable

Press $0 \boxed{\text{STO}}$ and then press the key for the name of the variable whose contents you want to clear.

Example: To clear the contents of variable A

$0 \boxed{\text{STO}} \boxed{\text{ALPHA}} \boxed{A}$

Independent Memory (M)

You can add calculation results to or subtract results from independent memory. The “M” appears on the display when independent memory contains a value.

- The following is a summary of the different operations you can perform using independent memory.

To do this:	Perform this key operation:
Add the displayed value or result of the expression to independent memory	$\boxed{\text{M}+}$

Subtract the displayed value or result of the expression from independent memory	SHIFT M+ (M-)
Recall current independent memory contents	SHIFT STO (RECALL) M+ (M) =

- Variable M is used for independent memory.
- You can also insert the M variable into a calculation, which tells the calculator to use the current independent memory contents at that location. The following is the key operation for inserting the M variable.
 ALPHA M+ (M)
- The “M” indicator appears on the display when there is any value other than zero stored in independent memory.

Calculation Examples Using Independent Memory

- If the “M” indicator is on the display, perform the procedure under “Clearing Independent Memory” before performing this example.

Example: $23 + 9 = 32$
 $53 - 6 = 47$
 $45 \times 2 = 90$
 $99 \div 3 = 33$
 (Total) 22

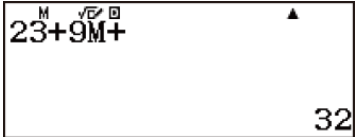
$$23 \text{ + } 9 \text{ M+}$$

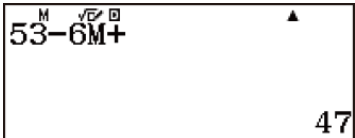
$$53 \text{ - } 6 \text{ M+}$$

$$45 \text{ x } 2 \text{ SHIFT M+ (M-)}$$

$$99 \text{ \div } 3 \text{ M+}$$

SHIFT **STO** (RECALL) **M+** (M) **=**

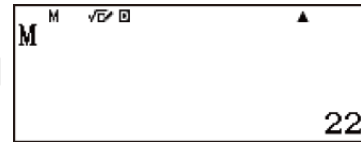

Clearing Independent Memory

Press **0** **STO** **M+** (M). This clears independent memory and causes the “M” indicator to disappear from the display.

0 **STO** **M+** (M)

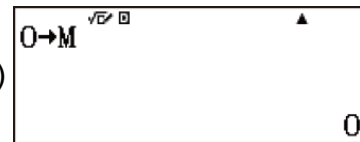

Clearing the Contents of All Memories

Ans memory, independent memory, and variable contents are retained even if you press **AC**, change the calculation mode, or turn off the calculator.

Perform the procedure below when you want to clear the contents of all memories.

SHIFT **9** (RESET) **2** (Memory) **=** (Yes)

- To cancel the clear operation without doing anything, press **AC** (Cancel) instead of **=**.

Function Calculations

Pi (π), Natural Logarithm Base e

Pi (π)

You can input pi (π) into a calculation.

The following shows the required key operations and the values this calculator uses for pi (π).

$$\pi = 3.14159265358980 \text{ (SHIFT) (x10⁻⁹) (\pi)}$$

π is displayed as 3.141592654, but $\pi = 3.14159265358980$ is used for internal calculations.

Natural Logarithm Base e

You can input natural logarithm base e into a calculation.

The following shows the required key operations and the values this calculator uses for e .

$$e = 2.71828182845904 \text{ (SHIFT) (x10⁻⁹) (e)}$$

e is displayed as 2.718281828, but $e = 2.71828182845904$ is used for internal calculations.

Trigonometric Functions, Inverse Trigonometric Functions

Trigonometric Functions

- The angle unit required by trigonometric functions is one specified as the calculator's default angle unit. Before performing a calculation, be sure to specify the default angle unit you want to use.

Example: $\sin 30 = \frac{1}{2}$ (Angle Unit: Degree)

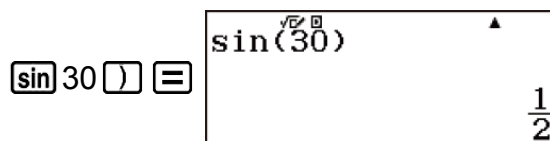

The image shows a calculator keypad with the keys **sin**, **30**, **)**, and **=** highlighted. To the right is a calculator display showing $\sin(30)$ at the top and $\frac{1}{2}$ at the bottom. A small cursor is visible at the end of the display line.

Inverse Trigonometric Functions

- The angle unit required by inverse trigonometric functions is one specified as the calculator's default angle unit. Before performing a calculation, be sure to specify the default angle unit you want to use.

Example: $\sin^{-1} 0.5 = 30$ (Angle Unit: Degree)

SHIFT sin (\sin^{-1}) 0.5 $\text{)} \text{=}$

$\sin^{-1}(0.5)$
30

Hyperbolic Functions, Inverse Hyperbolic Functions

Hyperbolic Functions

- Input a function from the menu that appears when you press OPTN 1 (Hyperbolic Func)*.
- * Depending on the calculation mode, you should press OPTN \blacktriangle 1 .

Example 1: $\sinh 1 = 1.175201194$

OPTN 1 (Hyperbolic Func)

1: sinh	2: cosh
3: tanh	4: sinh ⁻¹
5: cosh ⁻¹	6: tanh ⁻¹

1 (sinh) 1 $\text{)} \text{=}$

$\sinh(1)$
1.175201194

Example 2: $\cosh 0 = 1$

OPTN 1 (Hyperbolic Func)

1: sinh	2: cosh
3: tanh	4: sinh ⁻¹
5: cosh ⁻¹	6: tanh ⁻¹

2 (cosh) 0 $\text{)} \text{=}$

$\cosh(0)$
1

Inverse Hyperbolic Functions

- Input a function from the menu that appears when you press OPTN 1 (Hyperbolic Func)*.
- * Depending on the calculation mode, you should press OPTN \blacktriangle 1 .

Example : $\cosh^{-1} 1 = 0$

OPTN 1 (Hyperbolic Func)

1: sinh	2: cosh
3: tanh	4: sinh ⁻¹
5: cosh ⁻¹	6: tanh ⁻¹

$\boxed{5} (\cosh^{-1}) \boxed{1} \boxed{)} \boxed{=}$



Converting an Input Value to the Calculator's Default Angle Unit

After inputting a value, press $\boxed{\text{OPTN}} \boxed{2}$ (Angle Unit)* to display the angle unit specification menu shown below. Press the number key that corresponds to the angle unit of the input value. The calculator will automatically convert it to the calculator's default angle unit.

* Depending on the calculation mode, you should press $\boxed{\text{OPTN}} \boxed{\blacktriangle} \boxed{2}$.

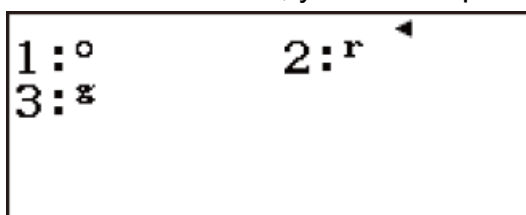

° : Degrees, r : Radians, g : Gradians

Example 1: To convert the following values to degrees: $\frac{\pi}{2}$ radians = 90° ,

50 grads = 45°

The following procedure assumes that the calculator's default angle unit is degrees.

$\boxed{(\pi)} \boxed{\text{SHIFT}} \boxed{\times 10^{-1}} (\pi) \boxed{\div} \boxed{2} \boxed{)} \boxed{=}$

$\boxed{\text{OPTN}} \boxed{2}$ (Angle Unit) $\boxed{2}$ (r) $\boxed{=}$



50 $\boxed{\text{OPTN}} \boxed{2}$ (Angle Unit) $\boxed{3}$ (g) $\boxed{=}$

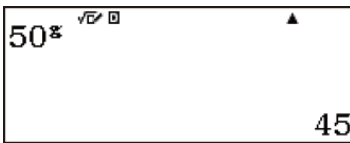

Example 2: $\cos(\pi \text{ radians}) = -1$, $\cos(100 \text{ grads}) = 0$

$\boxed{\cos} \boxed{\text{SHIFT}} \boxed{\times 10^{-1}} (\pi)$

$\boxed{\text{OPTN}} \boxed{2}$ (Angle Unit) $\boxed{2}$ (r) $\boxed{)} \boxed{=}$

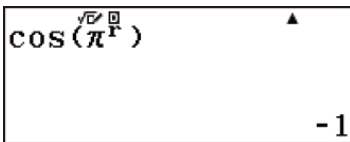

$\boxed{\cos} \boxed{100} \boxed{\text{OPTN}} \boxed{2}$ (Angle Unit) $\boxed{3}$ (g) $\boxed{)} \boxed{=}$

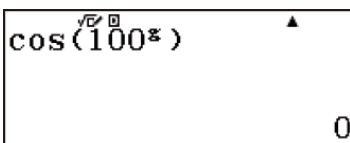

Example 3: $\cos^{-1}(-1) = 180$ (Angle Unit: Degree), $\cos^{-1}(-1) = \pi$ (Angle Unit: Radian)

(Angle Unit: Degree)

$\text{SHIFT} \text{COS} (\text{COS}^{-1}) (-) 1 \text{) } \text{=}$

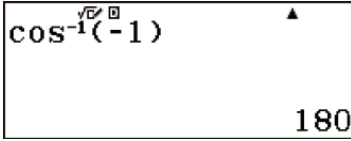

(Angle Unit: Radian)

$\text{SHIFT} \text{COS} (\text{COS}^{-1}) (-) 1 \text{) } \text{=}$

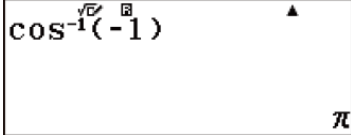

Exponential Functions, Logarithmic Functions

Exponential Functions

Example 1: $e^5 \times 2 = 296.8263182$
(MathI/MathO)

$\text{SHIFT} \text{LN} (e^{\blacksquare}) 5 \text{ > } \text{X} 2 \text{ =}$

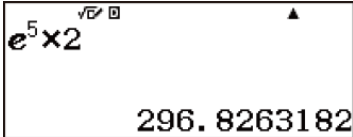

(LineI/LineO)

$\text{SHIFT} \text{LN} (e^{\blacksquare}) 5 \text{) } \text{X} 2 \text{ =}$

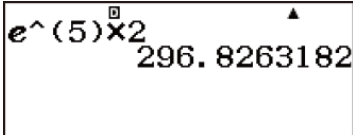

Example 2: $1.2 \times 10^3 = 1200$
(MathI/MathO)

$1.2 \text{ X } \text{SHIFT} \text{LOG} (10^{\blacksquare}) 3 \text{ =}$

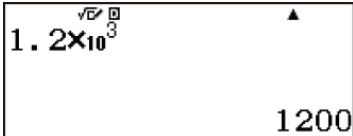

(LineI/LineO)

$1.2 \text{ X } \text{SHIFT} \text{LOG} (10^{\blacksquare}) 3 \text{) } \text{=}$

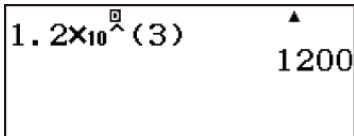

Logarithmic Functions

- For the logarithmic function “log(”, you can specify base m using the syntax “log (m , n)”.
If you input only a single value, a base of 10 is used for the calculation.
- “ln(” is a natural logarithm function with base e .
- You can also use the $\boxed{\log_{\square}}$ key when inputting an expression with the form of “log _{m} n ” while using MathI/MathO or MathI/DecimalO format. For details, see Example 1. Note that you must input the base (base m) when using the $\boxed{\log_{\square}}$ key for input.

Example 1: $\log_2 16 = 4$

(MathI/MathO)

$\boxed{\log_{\square}} 2 \blacktriangleright 16 \boxed{=}$ 

(LineI/LineO)

$\boxed{\log}$ (or $\boxed{\log_{\square}}$) 2 $\boxed{\text{SHIFT}}$ $\boxed{\log}$ (,) 16 $\boxed{)}$ $\boxed{=}$ 

Example 2: $\log 16 = 1.204119983$

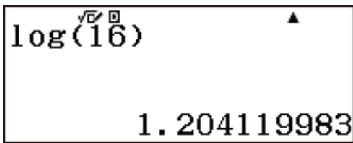
$\boxed{\log}$ 16 $\boxed{)}$ $\boxed{=}$ 

A base of 10 (common logarithm) is used if no base is specified.

Example 3: $\ln 90 (= \log_e 90) = 4.49980967$, $\ln e = 1$

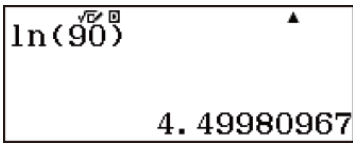
$\boxed{\ln}$ 90 $\boxed{)}$ $\boxed{=}$ 

$\boxed{\ln}$ $\boxed{\text{ALPHA}}$ $\boxed{\times 10^{\square}}$ (e) $\boxed{)}$ $\boxed{=}$ 

Power Functions and Power Root Functions

Example 1: $(1 + 1)^{2+2} = 16$

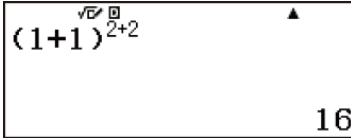
$((1 + 1) x^2 + 2) =$

Example 2: $(5^2)^3 = 15625$

$((5 x^2) x^3) =$

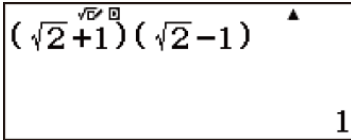

Example 3: $(\sqrt{2} + 1)(\sqrt{2} - 1) = 1$
(MathI/MathO)

$((\sqrt{2} \blacktriangleright + 1) (\sqrt{2} \blacktriangleright - 1)) =$

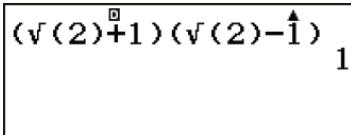
(LineI/LineO)

$((\sqrt{2}) + 1) ((\sqrt{2}) - 1) =$

Example 4: $^5\sqrt{32} = 2$
(MathI/MathO)

$(\text{SHIFT} x^{\square} (\sqrt{\square}) 5 \blacktriangleright 32) =$

(LineI/LineO)

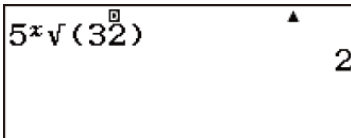
$5 \text{SHIFT} x^{\square} (\sqrt{\square}) 32) =$

Example 5: $(-2)^{\frac{2}{3}} = 1.587401052$
(MathI/MathO)

$$\left(\left((-) 2 \right) x^2 \right)^3 = (-2)^{2 \cdot 3} = 1.587401052$$

(LineI/LineO)

$$\left(\left((-) 2 \right) x^2 \right)^3 = (-2)^{(2 \cdot 3)} = 1.587401052$$

Example 6: $\sqrt[3]{5} + \sqrt[3]{-27} = -1.290024053$

(MathI/MathO)

$$\sqrt[3]{5} + \sqrt[3]{-27} = -1.290024053$$

(LineI/LineO)

$$\sqrt[3]{5} + \sqrt[3]{-27} = -1.290024053$$

Example 7: $\frac{1}{\frac{1}{3} - \frac{1}{4}} = 12$

(MathI/MathO)

$$\left(\frac{1}{\frac{1}{3} - \frac{1}{4}} \right) = 12$$

Rectangular-Polar Coordinate Conversion

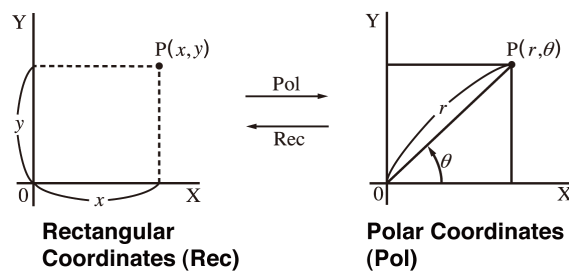

- Coordinate conversion can be performed in the Calculate and Statistics calculation modes.

- Pol converts rectangular coordinates to polar coordinates, while Rec converts polar coordinates to rectangular coordinates.
- Specify the angle unit before performing calculations.

Converting to Polar Coordinates (Pol)

Pol(X, Y) X: Specifies the rectangular coordinate X value

Y: Specifies the rectangular coordinate Y value

- Calculation result θ is displayed in the range of $-180^\circ < \theta < 180^\circ$.
- Calculation result θ is displayed using the calculator's angle unit.
- Calculation result r is assigned to variable X, while θ is assigned to Y.

Converting to Rectangular Coordinates (Rec)

Rec(r, θ) r : Specifies the polar coordinate r value

θ : Specifies the polar coordinate θ value

- Input value θ is treated as an angle value, in accordance with the calculator's angle unit setting.
- Calculation result x is assigned to variable X, while y is assigned to Y.
- If you perform coordinate conversion inside of an expression instead of a stand-alone operation, the calculation is performed using only the first value (either the r -value or the X-value) produced by the conversion.

Example: Pol ($\sqrt{2}, \sqrt{2}$) + 5 = 2 + 5 = 7

Rectangular-Polar Coordinate Conversion Examples

Example 1: $(X, Y) = (\sqrt{2}, \sqrt{2}) \rightarrow (r, \theta)$ (Angle Unit: Degree)

(MathI/MathO)

$\text{[SHIFT] [Pol] [√] 2 [▶] [SHIFT] [)] (,) [√] 2 [▶] [)] [≡]$



Pol($\sqrt{2}, \sqrt{2}$)
r=2, $\theta=45$

(LineI/LineO)

$\text{[SHIFT] [Pol] [√] 2 [)] [SHIFT] [)] (,) [√] 2 [)] [)] [≡]$

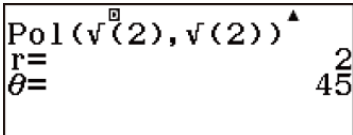

Pol($\sqrt{(2)}, \sqrt{(2)}$)
r=
 $\theta=45$

Example 2: $(X, Y) = (\sqrt{3}, 1) \rightarrow (r, \theta)$ (Angle Unit: Radian)

(MathI/MathO)

$\text{[SHIFT] [Pol] [√] 3 [▶] [SHIFT] [)] (,) 1 [)] [≡]$

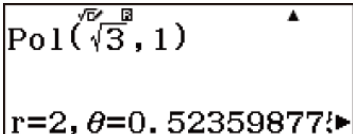

Pol($\sqrt{3}, 1$)
r=2, $\theta=0.52359877!$

(Line/LineO)

$\text{SHIFT} \text{+} (\text{Pol}) \sqrt{\square} 3 \text{)} \text{SHIFT} \text{)} (,) 1 \text{)} \text{=}$

Pol($\sqrt{3}$), 1)		▲
r=		2
θ =	0.5235987756	

Example 3: $(r, \theta) = (\sqrt{2}, 45) \rightarrow (X, Y)$ (Angle Unit: Degree)

(MathI/MathO)

$\text{SHIFT} \text{=} (\text{Rec}) \sqrt{\square} 2 \text{▶} \text{SHIFT} \text{)} (,) 45 \text{)} \text{=}$

Rec($\sqrt{2}$, 45)		▲
x=		
y=		
		x=1, y=1

(Line/LineO)

$\text{SHIFT} \text{=} (\text{Rec}) \sqrt{\square} 2 \text{)} \text{SHIFT} \text{)} (,) 45 \text{)} \text{=}$

Rec($\sqrt{2}$, 45)		▲
x=		1
y=		1

Example 4: $(r, \theta) = (2, \frac{\pi}{6}) \rightarrow (X, Y)$ (Angle Unit: Radian)

(MathI/MathO)

$2 \text{SHIFT} \text{)} (,) \text{SHIFT} \times 10^{\square} (\pi) \text{=} 6 \text{▶} \text{)} \text{=}$

Rec($2, \frac{\pi}{6}$)		▲
x=		
y=		
		x=1.732050808, y=1

(Line/LineO)

$\text{SHIFT} \text{=} (\text{Rec}) 2 \text{SHIFT} \text{)} (,) \text{SHIFT} \times 10^{\square} (\pi) \text{=} 6 \text{)} \text{=}$

Rec($2, \frac{\pi}{6}$)		▲
x=	1.732050808	
y=		1

Factorial (!)

This function obtains the factorials of a value that is zero or a positive integer.

Example: $(5 + 3)! = 40320$

$(5 + 3) \text{SHIFT} \times \text{SHIFT} (x!) \text{=}$

$(5+3)!$		▲
		40320

Absolute Value Calculation (Abs)

When you are performing a real number calculation, this function simply obtains the absolute value.

Example: $\text{Abs}(2 - 7) = |2 - 7| = 5$
(MathI/MathO)

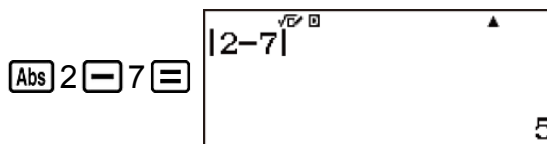

(LineI/LineO)

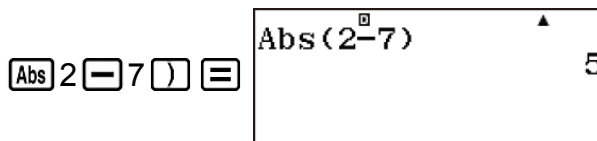

Random Number (Ran#), Random Integer (RanInt#)

Random Number (Ran#)

Function that generates a pseudo random number in the range of 0.000 to 0.999.

The result is displayed as a fraction when MathI/MathO is selected for Input/Output on the setup menu.

Example: Generate three 3-digit random numbers.

The random 3 digit decimal values are converted to 3-digit integer values by multiplying by 1000.

Note that the values shown here are examples only. Values actually generated by your calculator will be different.

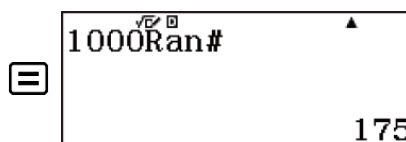
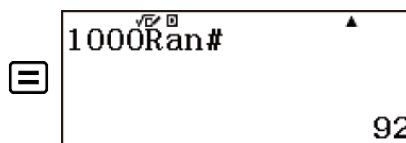
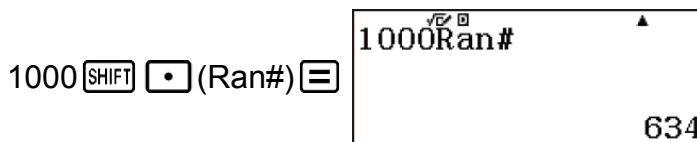

Random Integer (RanInt#)

For input of the function of the form $\text{RanInt}\#(a, b)$, which generates a random integer within the range of a to b .

Example: To generate random integers in the range of 1 to 6.
Note that the values shown here are examples only.
Values actually generated by your calculator will be different.

ALPHA RanInt 1 SHIFT R (,) 6 R =

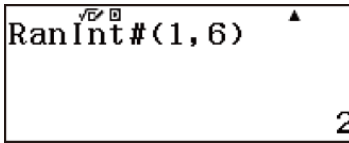

$\text{RanInt}\#(1,6)$
2

$\text{RanInt}\#(1,6)$
6

$\text{RanInt}\#(1,6)$
1

Permutation (nPr) and Combination (nCr)

These functions make it possible to perform permutation and combination calculations.

n and r must be integers in the range of $0 \leq r \leq n < 1 \times 10^{10}$.

Example: To determine the number of permutations and combinations possible when selecting four people from a group of 10.

Permutations:

10 SHIFT P (nPr) 4 =

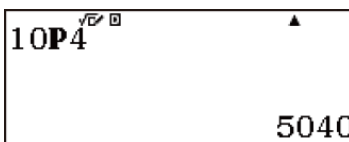

$10P4$
5040

Combinations:

10 SHIFT C (nCr) 4 =



$10C4$
210

Rounding Function (Rnd)

Using the Rnd function causes decimal fraction values of the argument to be rounded in accordance with the current Number Format setting.

Number Format: Norm 1 or Norm 2

The argument is rounded off to 10 digits.

Number Format: Fix or Sci

The argument is rounded off to the specified digit.

When Fix 3 is the Number Format setting, for example, the result of $10 \div 3$ is displayed as 3.333, while the calculator maintains a value of 3.333333333333333 (15 digits) internally for calculation. In the case of $\text{Rnd}(10 \div 3) = 3.333$ (with Fix 3), both the displayed value and the calculator's internal value become 3.333. Because of this a series of calculations will produce different results depending on whether Rnd is used ($\text{Rnd}(10 \div 3) \times 3 = 9.999$) or not used ($10 \div 3 \times 3 = 10.000$).

Example: To perform the following calculation when Fix 3 is selected for the number of display digits: $200 \div 7 \times 14 = 400$ (MathI/DecimalO)

$200 \div 7 \times 14$ 

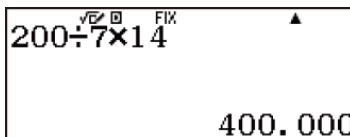

(Calculation is performed internally using 15 digits.)

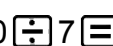
$200 \div 7$ 

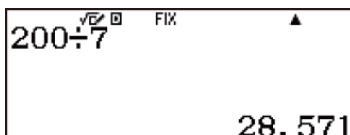

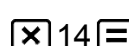
$\times 14$ 

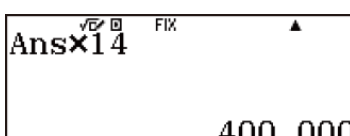

The following performs the same calculation with rounding.

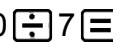
$200 \div 7$ 

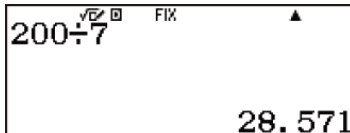

(Round the value to the specified number of digits.)

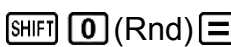

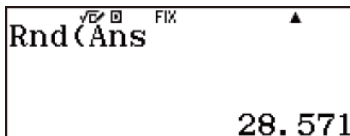

(Check rounded result.)

14

\sqrt{x} \square FIX \blacktriangle
Ans \times 14
399.994

Using Calculation Modes

Statistical Calculations

Perform the steps below to start a statistical calculation.

1. Press **MENU**, select the Statistics Mode icon, and then press **☰**.

1: 1-Variable
2: $y=a+bx$
3: $y=a+bx+cx^2$
4: $y=a+b \cdot \ln(x)$

2. On the Select Type screen that appears, press one of the keys below to select a statistical calculation type.

1 (1-Variable)	Single-variable (x)
2 ($y=a+bx$)	Paired-variable (x, y), linear regression
3 ($y=a+bx+cx^2$)	Paired-variable (x, y), quadratic regression
4 ($y=a+b \cdot \ln(x)$)	Paired-variable (x, y), logarithmic regression
1 ($y=a \cdot e^{(bx)}$)	Paired-variable (x, y), e exponential regression
2 ($y=a \cdot b^x$)	Paired-variable (x, y), ab exponential regression
3 ($y=a \cdot x^b$)	Paired-variable (x, y), power regression
4 ($y=a+b/x$)	Paired-variable (x, y), inverse regression

- Performing any of the above key operations displays the Statistics Editor.

Note

- When you want to change the calculation type after entering the Statistics Mode, perform the key operation **OPTN** **1** (Select Type) to display the calculation type selection screen.

Inputting Data with Statistics Editor

Statistics Editor

There are two Statistics Editor formats, depending on the type of statistical calculation you selected.

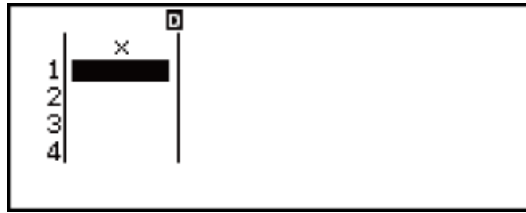

Single-variable

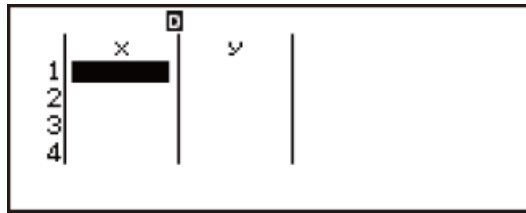

Paired-variable

- The first line of the Statistics Editor shows the value for the first sample or the values for their first pair of samples.

Freq (Frequency) Column

If you turn on the Statistics setting on the setup menu, a column labeled “Freq” will also be included on the Statistics Editor.

You can use the Freq column to specify the frequency (the number of times the same sample appears in the group of data) of each sample value.

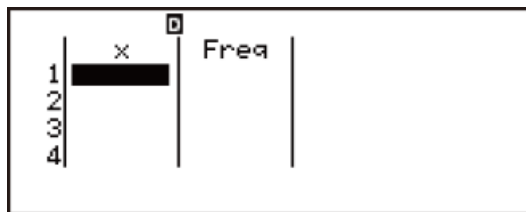

Single-variable

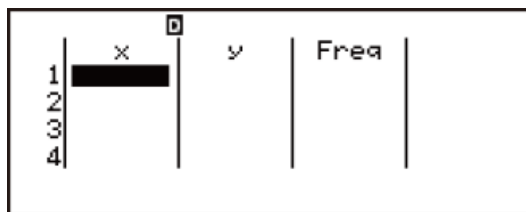

Paired-variable

Rules for Inputting Sample Data on the Statistics Editor

- Data you input is inserted into the cell where the cursor is located. Use the cursor keys to move the cursor between cells.

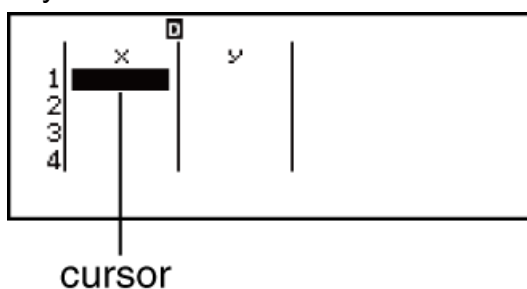

- After inputting a value, press $\boxed{=}$. This registers the value and displays up to six of its digits in the currently selected cell.

Example 1: To input the value 1234 in cell X1
(Move the cursor to cell X1.)



The value you input appears in the formula area.

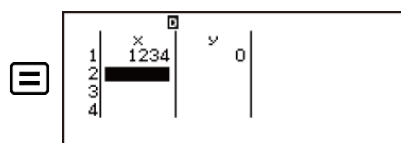

Registering a value causes the cursor to move down one cell.

Example 2: To select logarithmic regression and input the following data: (170, 66), (173, 68), (179, 75)

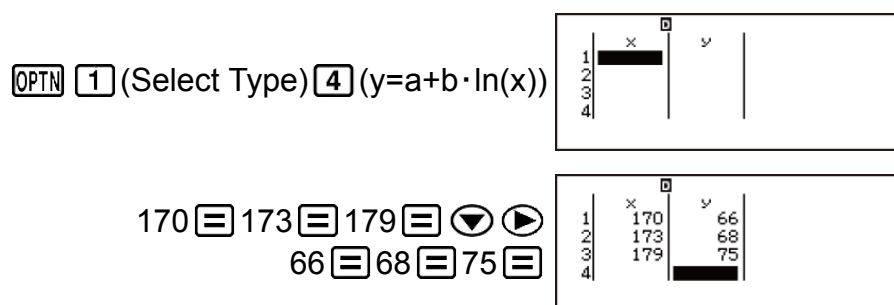

Statistics Editor Input Precautions

- The number of lines in Statistics Editor (the number of sample data values you can input) depends on the type of statistical calculation you selected, and on the Statistics setting on the setup menu.

Statistics setting calculation type	Off (No Freq column)	On (Freq column)
Single-variable	160 lines	80 lines
Paired-variable	80 lines	53 lines

- Pressing the **AC** key while the Statistics Editor is on the screen will display a statistical calculation screen for performing calculations based on the input data. What you need to do to return to the Statistics Editor from the statistical calculation screen depends on the calculation type you selected. Press **OPTN** **3** (Data) if you selected single-variable or **OPTN** **4** (Data) if you selected paired-variable.

Precautions Concerning Sample Data Storage

- All data currently input in the Statistics Editor is deleted whenever you exit the Statistics Mode, switch between the single-variable and a paired-variable statistical calculation type, or change the Statistics setting on the setup menu.

Editing Sample Data

To replacing the data in a cell

1. On the Statistics Editor, move the cursor to the cell you want to edit.
2. Input the new data value or expression, and then press **≡**.

Important!

- Note that you must totally replace the existing data of the cell with new input. You cannot edit parts of the existing data.

To delete a line

1. On the Statistics Editor, move the cursor to the line you want to delete.
2. Press **DEL**.

To insert a line

1. On the Statistics Editor, move the cursor to the line that will be under the line you will insert.
2. Press **OPTN** **2** (Editor).
3. Press **1** (Insert Row).

Important!

- Note that the insert operation will not work if the maximum number of lines allowed for the Statistics Editor are already used.

To delete all Statistics Editor contents

1. On the Statistics Editor, press **OPTN** **2** (Editor).
2. Press **2** (Delete All).

Statistical Calculation Screen

The statistical calculation screen is for performing statistical calculations with the data you input with the Statistics Editor. Pressing the **AC** key while the Statistics Editor is displayed switches to the statistical calculation screen.

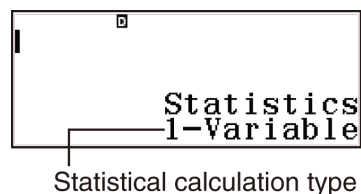

Using the Statistical Menu

While the Statistics Editor or statistical calculation screen is on the display, press **OPTN** to display the statistical menu.

The content to the statistical menu depends on whether the currently selected statistical operation type uses a single variable or paired variables.

Statistics Editor: Single-variable

A screenshot of a calculator screen showing a menu with four options: "1:Select Type", "2:Editor", "3:1-Variable Calc", and "4:Statistics Calc". A vertical cursor is on the right side of the screen.

Select this menu item:	When you want to do this:
1 (Select Type)	Display the statistical calculation type selection screen
2 (Editor)	Display the Editor sub-menu for editing Statistics Editor contents
3 (1-Variable Calc)	Display statistical values based on input data

4 (Statistics Calc)	Display the statistical calculation screen
----------------------------	--

Statistics Editor: Paired-variable

```

1:Select Type
2:Editor
3:2-Variable Calc
4:Regression Calc

```

```

1:Statistics Calc

```

Select this menu item:	When you want to do this:
1 (Select Type)	Display the statistical calculation type selection screen
2 (Editor)	Display the Editor sub-menu for editing Statistics Editor contents
3 (2-Variable Calc)	Display statistical values based on input data
4 (Regression Calc)	Display regression calculation results based on input data
1 (Statistics Calc)	Display the statistical calculation screen

Statistical calculation screen: Single-variable

```

1:Select Type
2:1-Variable Calc
3:Data

```

```

1:Summation
2:Variable
3:Min/Max

```

Select this menu item:	When you want to do this:
<input type="checkbox"/> 1 (Select Type)	Display the statistical calculation type selection screen
<input type="checkbox"/> 2 (1-Variable Calc)	Display statistical values based on input data
<input type="checkbox"/> 3 (Data)	Display the Statistics Editor
<input type="radio"/> 1 (Summation)	Display the Summation sub-menu of commands for calculating sums
<input type="radio"/> 2 (Variable)	Display the Variable sub-menu of commands for calculating the mean, standard deviation, etc.
<input type="radio"/> 3 (Min/Max)	Display the Min/Max sub-menu of commands for obtaining maximum and minimum values

Statistical calculation screen: Paired-variable

```

1:Select Type
2:2-Variable Calc
3:Regression Calc
4:Data

```

```

1:Summation
2:Variable
3:Min/Max
4:Regression

```

Select this menu item:	When you want to do this:
1 (Select Type)	Display the statistical calculation type selection screen
2 (2-Variable Calc)	Display statistical values based on input data
3 (Regression Calc)	Display regression calculation results based on input data
4 (Data)	Display the Statistics Editor
1 (Summation)	Display the Summation sub-menu of commands for calculating sums
2 (Variable)	Display the Variable sub-menu of commands for calculating the mean, standard deviation, etc.
3 (Min/Max)	Display the Min/Max sub-menu of commands for obtaining maximum and minimum values
4 (Regression)	Display the Regression sub-menu of commands for regression calculations

Displaying Statistical Values Based On Input Data

From the Statistics Editor:

OPTN **3** (1-Variable Calc or 2-Variable Calc)

From the statistical calculation screen:

OPTN **2** (1-Variable Calc or 2-Variable Calc)

$\sum x$	=174
$\sum x^2$	=522
$\sum x^2$	=90870
$\sigma^2 x$	=14
σx	=3.741657387
$s^2 x$	=21

Displaying Regression Calculation Results Based On Input Data (Paired-Variable Data Only)

From the Statistics Editor:

OPTN **4** (Regression Calc)

From the statistical calculation screen:

OPTN **3** (Regression Calc)

$y=a+b \cdot \ln(x)$	
a	=-852.1627746
b	=178.6897969
r	=0.9919863213

Single-variable Statistical Calculation Commands

The following are the commands that appear on the sub-menus that appear when you select Summation, Variable, or Min/Max on the statistical menu while a single-variable statistical calculation type is selected.

The following is the calculation formula used for each command.

$$\bar{x} = \frac{\sum x}{n}$$

$$\sigma_x = \sqrt{\frac{\sum (x - \bar{x})^2}{n}}$$

$$s_x = \sqrt{\frac{\sum (x - \bar{x})^2}{n - 1}}$$

Summation Sub-menu (OPTN \blacktriangledown 1 (Summation))

1: $\sum x$	2: $\sum x^2$
-------------	---------------

Select this menu item:	When you want to obtain this:
1 ($\sum x$)	Sum of the sample data
2 ($\sum x^2$)	Sum of squares of the sample data

Variable Sub-menu (OPTN \blacktriangledown 2 (Variable))

1: \bar{x}	2: $\sigma^2 x$
3: σx	4: $s^2 x$
5: $s x$	6: n

Select this menu item:	When you want to obtain this:
1 (\bar{x})	Mean of the sample data
2 (σ^2_x)	Population variance
3 (σ_x)	Population standard deviation
4 (s^2_x)	Sample variance
5 (s_x)	Sample standard deviation

6 (n)	Number of items
------------------	-----------------

Min/Max Sub-menu (**OPTN** **▼** **3** (Min/Max))

```
1:min(x)  2:Q1
3:Med     4:Q3
5:max(x)
```

Select this menu item:	When you want to obtain this:
1 ($\min(x)$)	Minimum value
2 (Q_1)	First quartile
3 (Med)	Median
4 (Q_3)	Third quartile
5 ($\max(x)$)	Maximum value

Single-variable Statistical Calculation Examples

Select single-variable and input the following data: {1, 2, 3, 4, 5, 6, 7, 8, 9, 10} (Statistics: On)

OPTN **1** (Select Type) **1** (1-Variable)

x	Freq
1	
2	
3	
4	

1 **2** **3** **4** **5** **6** **7** **8** **9** **10**

x	Freq
8	1
9	1
10	1
11	

AC

Statistics
1-Variable

Edit the data to the following, using insert and delete: {0, 1, 2, 3, 4, 5, 6, 7, 9, 10}

OPTN **3** (Data)

x	Freq
1	1
2	1
3	1
4	1

1

OPTN 2 (Editor)

1: Insert Row
2: Delete All

1 (Insert Row)

x	Freq
1	1
2	1
3	1
4	1

0

▲ ▲ ▲ ▲

x	Freq
9	1
10	1
11	1
12	1

8

DEL

x	Freq
9	1
10	1
11	
12	

9

AC

Statistics
1-Variable

Edit the Freq data to the following: {1, 2, 1, 2, 2, 2, 3, 4, 2, 1}

OPTN 3 (Data) ▶

x	Freq
1	1
2	1
3	1
4	1

1

▼ 2 = ▼ 2 = 2 = 2 = 3 = 4 = 2 =

x	Freq
7	3
8	4
9	2
10	1

1

AC

Statistics
1-Variable

Display statistical values based on input data.

OPTN 2 (1-Variable Calc)

\bar{x}	=5.1
$\sum x$	=102
$\sum x^2$	=672
$\sigma^2 x$	=7.59
σx	=2.754995463
$s^2 x$	=7.989473684

▼

sx	=2.826565705
n	=20
$\min(x)$	=0
Q_1	=3
Med	=5.5
Q_3	=7

▼

$\max(x)$	=10
-----------	-----

Calculate sum of squares of the sample data and sum of the sample data.

AC OPTN \blacktriangledown 1 (Summation)	1: Σx	2: Σx^2
2 (Σx^2) \equiv	Σx^2	672
OPTN \blacktriangledown 1 (Summation)	Σx^2	672
1 (Σx) \equiv	Σx	102

Calculate number of samples, mean, and population standard deviation.

OPTN \blacktriangledown 2 (Variable)	1: \bar{x}	2: $\sigma^2 x$
	3: σx	4: $s^2 x$
	5: $s x$	6: n
6 (n) \equiv	Σx	102
	n	20
OPTN \blacktriangledown 2 (Variable)	n	20
1 (\bar{x}) \equiv	\bar{x}	5.1
OPTN \blacktriangledown 2 (Variable)	\bar{x}	5.1
3 (σ_x) \equiv	σx	2.754995463

Calculate minimum value and maximum value.

OPTN \blacktriangledown 3 (Min/Max)	1: $\min(x)$	2: Q_1
	3: Med	4: Q_3
	5: $\max(x)$	
1 ($\min(x)$) \equiv	σx	2.754995463
	$\min(x)$	0
OPTN \blacktriangledown 3 (Min/Max)	$\min(x)$	0
5 ($\max(x)$) \equiv	$\max(x)$	10

Linear Regression Calculation ($y=a+bx$) Commands

With linear regression, regression is performed in accordance with the following model equation.

$$y = a + bx$$

The following is the calculation formula used for each command.

$$\bar{x} = \frac{\sum x}{n}$$

$$\sigma_x = \sqrt{\frac{\sum (x - \bar{x})^2}{n}}$$

$$s_x = \sqrt{\frac{\sum (x - \bar{x})^2}{n - 1}}$$

$$\bar{y} = \frac{\sum y}{n}$$

$$\sigma_y = \sqrt{\frac{\sum (y - \bar{y})^2}{n}}$$

$$s_y = \sqrt{\frac{\sum (y - \bar{y})^2}{n - 1}}$$

$$a = \frac{\sum y - b \cdot \sum x}{n}$$

$$b = \frac{n \cdot \sum xy - \sum x \cdot \sum y}{n \cdot \sum x^2 - (\sum x)^2}$$

$$r = \frac{n \cdot \sum xy - \sum x \cdot \sum y}{\sqrt{\{n \cdot \sum x^2 - (\sum x)^2\} \{n \cdot \sum y^2 - (\sum y)^2\}}}$$

$$\hat{x} = \frac{y - a}{b}$$

$$\hat{y} = a + bx$$

Summation Sub-menu (**OPTN** **▼** **1** (Summation))

1: $\sum x$	2: $\sum x^2$
3: $\sum y$	4: $\sum y^2$
5: $\sum xy$	6: $\sum x^3$
7: $\sum x^2 y$	8: $\sum x^4$

Select this menu item:	When you want to obtain this:
1 ($\sum x$)	Sum of the x-data
2 ($\sum x^2$)	Sum of squares of the x-data
3 ($\sum y$)	Sum of the y-data
4 ($\sum y^2$)	Sum of squares of the y-data

5 (Σxy)	Sum of products of the x-data and y-data
6 (Σx^3)	Sum of cubes of the x-data
7 ($\Sigma x^2 y$)	Sum of (x-data squares \times y-data)
8 (Σx^4)	Sum of biquadrate of the x-data

Variable Sub-menu (**OPTN \blacktriangledown **2** (Variable))**

1: \bar{x}	2: $\sigma^2 x$	1: σy	2: $s^2 y$
3: σx	4: $s^2 x$	3: $s y$	
5: $s x$	6: n		
7: \bar{y}	8: $\sigma^2 y$		

Select this menu item:	When you want to obtain this:
1 (\bar{x})	Mean of the x-data
2 (σ^2_x)	Population variance of the x-data
3 (σ_x)	Population standard deviation of the x-data
4 (s^2_x)	Sample variance of the x-data
5 (s_x)	Sample standard deviation of the x-data
6 (n)	Number of items
7 (\bar{y})	Mean of the y-data
8 (σ^2_y)	Population variance of the y-data
\blacktriangledown 1 (σ_y)	Population standard deviation of the y-data
\blacktriangledown 2 (s^2_y)	Sample variance of the y-data
\blacktriangledown 3 (s_y)	Sample standard deviation of the y-data

Min/Max Sub-menu (**OPTN \blacktriangledown **3** (Min/Max))**

1: $\min(x)$	2: $\max(x)$
3: $\min(y)$	4: $\max(y)$

Select this menu item:	When you want to obtain this:
1 (min(x))	Minimum value of the x-data
2 (max(x))	Maximum value of the x-data
3 (min(y))	Minimum value of the y-data
4 (max(y))	Maximum value of the y-data

Regression Sub-menu (**OPTN** \blacktriangledown **4** (Regression))

1 :a	2 :b
3 :r	4 : \hat{x}
5 : \hat{y}	

Select this menu item:	When you want to obtain this:
1 (a)	Regression coefficient constant term a
2 (b)	Regression coefficient b
3 (r)	Correlation coefficient r
4 (\hat{x})	Estimated value of x
5 (\hat{y})	Estimated value of y

Linear Regression Calculation Examples

Select linear regression and input the following data (Statistics: Off)

x	y	x	y
1.0	1.0	2.1	1.5
1.2	1.1	2.4	1.6
1.5	1.2	2.5	1.7
1.6	1.3	2.7	1.8
1.9	1.4	3.0	2.0

OPTN **1** (Select Type) **2** ($y=a+bx$)

1	x	y
2		
3		
4		

1 **⇨** 1.2 **⇨** 1.5 **⇨** 1.6 **⇨** 1.9 **⇨**
 2.1 **⇨** 2.4 **⇨** 2.5 **⇨** 2.7 **⇨** 3 **⇨**

8	x	y
9	2.5	0
10	2.7	0
11	3	0

1 **⇨** 1.1 **⇨** 1.2 **⇨** 1.3 **⇨** 1.4 **⇨**
 1.5 **⇨** 1.6 **⇨** 1.7 **⇨** 1.8 **⇨** 2 **⇨**

8	x	y
9	2.5	1.7
10	2.7	1.8
11	3	2

AC

Statistics
 $y=a+bx$

Display statistical values based on input data.

OPTN **2** (2-Variable Calc)

Σx	=1.99
Σx^2	=19.9
Σxy	=43.57
$\sigma^2 x$	=0.3969
σx	=0.63
$s^2 x$	=0.441

⇩

$s x$	=0.6640783086
n	=10
Σy	=1.46
Σy^2	=14.6
Σy^2	=22.24
$\sigma^2 y$	=0.0924

⇩

σy	=0.3039736831
$s^2 y$	=0.1026666667
$s y$	=0.3204163958
Σxy	=30.96
Σx^3	=102.451
$\Sigma x^2 y$	=71.244

⇩

Σx^4	=253.5541
$\min(x)$	=1
$\max(x)$	=3
$\min(y)$	=1
$\max(y)$	=2

Display regression calculation results based on input data.

AC **OPTN** **3** (Regression Calc)

$y=a+bx$	
a	=0.5043587805
b	=0.4802217183
r	=0.9952624646

Calculate sum of products of the x-data and y-data, Population standard deviation of the x-data, and maximum value of the y-data.

AC **OPTN** **⇩** **1** (Summation)

1: Σx	2: Σx^2
3: Σy	4: Σy^2
5: Σxy	6: Σx^3
7: $\Sigma x^2 y$	8: Σx^4

5 (Σxy) =

Σxy	30.96
-------------	-------

OPTN \blacktriangledown 2 (Variable)

1: \bar{x}	2: $\sigma^2 x$
3: σx	4: $s^2 x$
5: $s x$	6: n
7: \bar{y}	8: $\sigma^2 y$

3 (σ_x) =

Σxy	30.96
σx	0.63

OPTN \blacktriangledown 3 (Min/Max)

1: min(x)	2: max(x)
3: min(y)	4: max(y)

4 (max(y)) =

σx	0.63
max(y)	2

Calculate regression coefficient constant term a, regression coefficient b, and correlation coefficient r.

OPTN \blacktriangledown 4 (Regression)

1: a	2: b
3: r	4: \hat{x}
5: \hat{y}	

1 (a) =

max(y)	2
a	0.5043587805

OPTN \blacktriangledown 4 (Regression)

2 (b) =

a	0.5043587805
b	0.4802217183

OPTN \blacktriangledown 4 (Regression)

3 (r) =

b	0.4802217183
r	0.9952824846

Calculate estimated values.
($y=-3 \rightarrow \hat{x}=?$)

(\leftarrow) 3 OPTN \blacktriangledown 4 (Regression)

1: a	2: b
3: r	4: \hat{x}
5: \hat{y}	

$\boxed{4}$ (\hat{x}) \equiv	r	0.9952824846
	$-3\hat{x}$	-7.297376705

($x=2 \rightarrow \hat{y}=?$)

2 OPTN \blacktriangledown $\boxed{4}$ (Regression)	$-3\hat{x}$	-7.297376705
$\boxed{5}$ (\hat{y}) \equiv	$2\hat{y}$	1.464802217

Quadratic Regression Calculation ($y=a+bx+cx^2$) Commands

With quadratic regression, regression is performed in accordance with the following model equation.

$$y = a + bx + cx^2$$

The following is the calculation formula used for each command.

$$a = \frac{\sum y}{n} - b\left(\frac{\sum x}{n}\right) - c\left(\frac{\sum x^2}{n}\right)$$

$$b = \frac{S_{xy} \cdot S_{x^2x^2} - S_{x^2y} \cdot S_{xx}}{S_{xx} \cdot S_{x^2x^2} - (S_{xx^2})^2}$$

$$c = \frac{S_{x^2y} \cdot S_{xx} - S_{xy} \cdot S_{xx^2}}{S_{xx} \cdot S_{x^2x^2} - (S_{xx^2})^2}$$

$$S_{xx} = \sum x^2 - \frac{(\sum x)^2}{n}$$

$$S_{xy} = \sum xy - \frac{(\sum x \cdot \sum y)}{n}$$

$$S_{xx^2} = \sum x^3 - \frac{(\sum x \cdot \sum x^2)}{n}$$

$$S_{x^2x^2} = \sum x^4 - \frac{(\sum x^2)^2}{n}$$

$$S_{x^2y} = \sum x^2y - \frac{(\sum x^2 \cdot \sum y)}{n}$$

$$\hat{x}_1 = \frac{-b + \sqrt{b^2 - 4c(a - y)}}{2c}$$

$$\hat{x}_2 = \frac{-b - \sqrt{b^2 - 4c(a - y)}}{2c}$$

$$\hat{y} = a + bx + cx^2$$

- Summation Sub-menu, Variable Sub-menu, and Min/Max Sub-menu operations are the same those for linear regression calculations.

Regression Sub-menu (OPTN \blacktriangledown $\boxed{4}$ (Regression))

1:a	2:b
3:c	4: \hat{x}_1
5: \hat{x}_2	6: \hat{y}

Select this menu item:	When you want to obtain this:
1 (a)	Regression coefficient constant term a
2 (b)	Linear coefficient b of the regression coefficients
3 (c)	Quadratic coefficient c of the regression coefficients
4 (\hat{x}_1)	Estimated value of x1
5 (\hat{x}_2)	Estimated value of x2
6 (\hat{y})	Estimated value of y

Quadratic Regression Calculation Examples

Select quadratic regression and input the following data (Statistics: Off)

x	y	x	y
1.0	1.0	2.1	1.5
1.2	1.1	2.4	1.6
1.5	1.2	2.5	1.7
1.6	1.3	2.7	1.8
1.9	1.4	3.0	2.0

OPTN **1** (Select Type) **3** ($y=a+bx+cx^2$)

x	y
1.0	1.0
1.2	1.1
1.5	1.2
1.6	1.3
1.9	1.4

1 **1.2** **1.5** **1.6** **1.9**
 2.1 **2.4** **2.5** **2.7** **3**

x	y
2.1	1.5
2.4	1.6
2.5	1.7
2.7	1.8
3.0	2.0

1.1 **1.2** **1.3** **1.4**
 1.5 **1.6** **1.7** **1.8** **2**

x	y
2.5	1.7
2.7	1.8
3.0	2.0

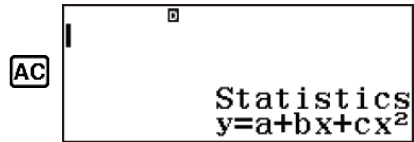

Display statistical values based on input data.

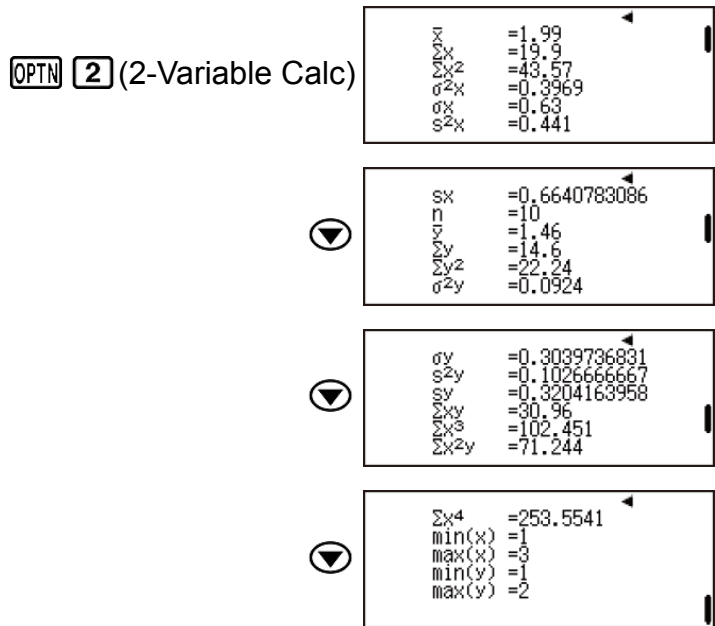

Display regression calculation results based on input data.

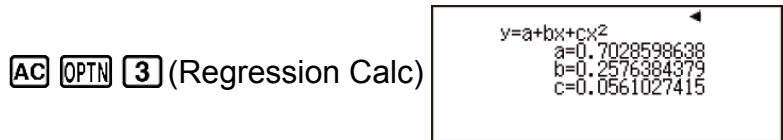

Calculate regression coefficient constant term a, linear coefficient b, and quadratic coefficient c.

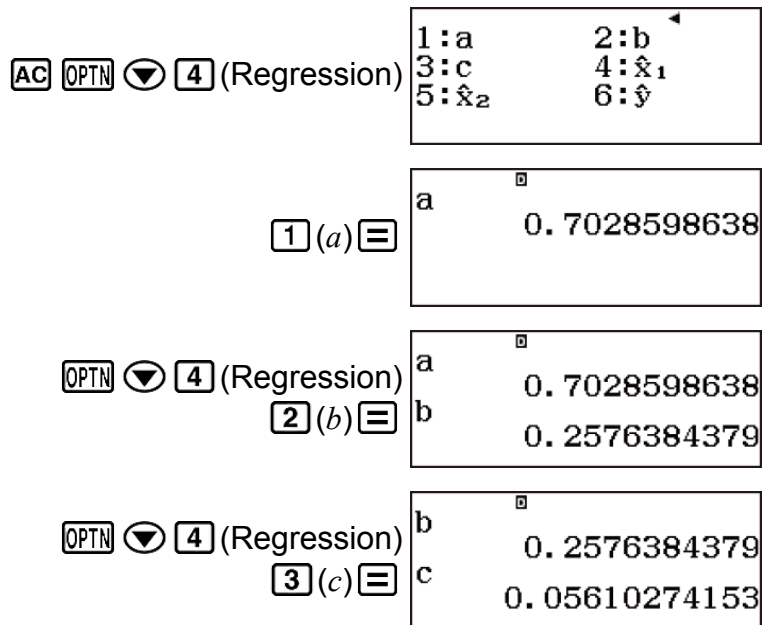

Logarithmic Regression Calculation ($y=a+b \cdot \ln(x)$) Commands

With logarithmic regression, regression is performed in accordance with the following model equation.

$$y = a + b \ln x$$

The following is the calculation formula used for each command.

$$a = \frac{\sum y - b \cdot \sum \ln x}{n}$$

$$b = \frac{n \cdot \sum (\ln x)y - \sum \ln x \cdot \sum y}{n \cdot \sum (\ln x)^2 - (\sum \ln x)^2}$$

$$r = \frac{n \cdot \sum (\ln x)y - \sum \ln x \cdot \sum y}{\sqrt{\{n \cdot \sum (\ln x)^2 - (\sum \ln x)^2\} \{n \cdot \sum y^2 - (\sum y)^2\}}}$$

$$\hat{x} = e^{\frac{y-a}{b}}$$

$$\hat{y} = a + b \ln x$$

- Summation Sub-menu, Variable Sub-menu, Min/Max Sub-menu, and Regression Sub-menu operations are the same those for linear regression calculations.

Logarithmic Regression Calculation Examples

Select logarithmic regression and input the following data (Statistics: Off)

x	y
29	1.6
50	23.5
74	38.0
103	46.4
118	48.9

OPTN **1** (Select Type) **4** ($y=a+b \cdot \ln(x)$)

x	y

29 **⇩** 50 **⇩** 74 **⇩** 103 **⇩** 118 **⇩**

x	y
74	0
103	0
118	0

1.6 $\boxed{=}$ 23.5 $\boxed{=}$ 38 $\boxed{=}$ 46.4 $\boxed{=}$ 48.9 $\boxed{=}$

x	y
74	38
103	46.4
118	48.9

AC

Statistics
 $y=a+b \cdot \ln(x)$

Display statistical values based on input data.

OPTN **2** (2-Variable Calc)

Σx	=74.8
Σx^2	=374
Σx^3	=33350
Σx^4	=1074.96
σx	=32.78658262
s^2x	=1343.7

\blacktriangledown

sx	=96.65651375
n	=5
Σy	=31.68
Σy^2	=158.4
Σy^3	=6542.98
Σy^4	=304.9736

\blacktriangledown

σy	=17.46349335
s^2y	=301.217
σxy	=19.52477913
Σxy	=14582.8
Σx^3	=3290372
Σx^2y	=1441324.8

\blacktriangledown

Σx^4	=943372514
$\min(x)$	=29
$\max(x)$	=118
$\min(y)$	=1.6
$\max(y)$	=48.9

Display regression calculation results based on input data.

AC **OPTN** **3** (Regression Calc)

$y=a+b \cdot \ln(x)$	
a	=-111.1283976
b	=34.0201475
r	=0.9940139466

Calculate regression coefficient constant term a, regression coefficient b, and correlation coefficient r.

AC **OPTN** \blacktriangledown **4** (Regression)

1:a	2:b
3:r	4: \hat{x}
5: \hat{y}	

1 (a) $\boxed{=}$

a	-111.1283976
---	--------------

OPTN \blacktriangledown **4** (Regression)

2 (b) $\boxed{=}$

a	-111.1283976
b	34.0201475

OPTN	▼	4	(Regression)	b	34.0201475
		3	(r)	r	0.9940139466

Calculate estimated values.

($y=73 \rightarrow \hat{x}=?$)

73	OPTN	▼	4	(Regression)	1:a	2:b
					3:r	4: \hat{x}
					5: \hat{y}	

4	(\hat{x})	r	0.9940139466
		73 \hat{x}	224.1541313

($x=80 \rightarrow \hat{y}=?$)

80	OPTN	▼	4	(Regression)	73 \hat{x}	224.1541313
				5(\hat{y})	80 \hat{y}	37.94879482

e Exponential Regression Calculation ($y=a \cdot e^{bx}$) Commands

With *e* exponential regression, regression is performed in accordance with the following model equation.

$$y = ae^{bx}$$

The following is the calculation formula used for each command.

$$a = \exp\left(\frac{\sum \ln y - b \cdot \sum x}{n}\right)$$

$$b = \frac{n \cdot \sum x \ln y - \sum x \cdot \sum \ln y}{n \cdot \sum x^2 - (\sum x)^2}$$

$$r = \frac{n \cdot \sum x \ln y - \sum x \cdot \sum \ln y}{\sqrt{\{n \cdot \sum x^2 - (\sum x)^2\} \{n \cdot \sum (\ln y)^2 - (\sum \ln y)^2\}}}$$

$$\hat{x} = \frac{\ln y - \ln a}{b}$$

$$\hat{y} = a e^{bx}$$

- Summation Sub-menu, Variable Sub-menu, Min/Max Sub-menu, and Regression Sub-menu operations are the same those for linear regression calculations.

e Exponential Regression Calculation Examples

Select *e* exponential regression and input the following data (Statistics: Off)

x	y
6.9	21.4
12.9	15.7
19.8	12.1
26.7	8.5
35.1	5.2

OPTN [1] (Select Type) ▼ [1] ($y = a \cdot e^{(bx)}$)

6.9 [] 12.9 [] 19.8 [] 26.7 [] 35.1 []

21.4 [] 15.7 [] 12.1 [] 8.5 [] 5.2 []

AC

Statistics
 $y = a \cdot e^{(bx)}$

Display statistical values based on input data.

OPTN [2] (2-Variable Calc)

\bar{x} =20.28
 Σx =101.4
 Σx^2 =2550.96
 $\sigma^2 x$ =98.9136
 σx =9.9453166
 $s^2 x$ =123.642

s_x =11.11944243
 n =5
 \bar{y} =12.58
 Σy =62.9
 Σy^2 =950.15
 $\sigma^2 y$ =31.7736

σy =5.636807607
 $s^2 y$ =39.717
 s_y =6.302142493
 Σxy =998.24
 Σx^3 =72515.304
 $\Sigma x^2 y$ =20841.192

Σx^4 =2209715.154
 $\min(x)$ =6.9
 $\max(x)$ =35.1
 $\min(y)$ =5.2
 $\max(y)$ =21.4

Display regression calculation results based on input data.

AC OPTN 3 (Regression Calc)

$y = a \cdot e^{(bx)}$	
a=	30.49758743
b=	-0.049203708
r=	-0.997247352

Calculate regression coefficient constant term a, regression coefficient b, and correlation coefficient r.

AC OPTN 4 (Regression)

1:a	2:b
3:r	4: \hat{x}
5: \hat{y}	

1 (a) =

a	30.49758743
---	-------------

OPTN 4 (Regression)

2 (b) =

a	30.49758743
b	-0.04920370831

OPTN 4 (Regression)

3 (r) =

b	-0.04920370831
r	-0.997247352

Calculate estimated values.

($y=20 \rightarrow \hat{x}=?$)

20 OPTN 4 (Regression)

1:a	2:b
3:r	4: \hat{x}
5: \hat{y}	

4 (\hat{x}) =

r	-0.997247352
20 \hat{x}	8.574868047

($x=16 \rightarrow \hat{y}=?$)

16 OPTN 4 (Regression)

5 (\hat{y}) =

20 \hat{x}	8.574868047
16 \hat{y}	13.87915739

ab Exponential Regression Calculation ($y = a \cdot b^x$) Commands

With *ab* exponential regression, regression is performed in accordance with the following model equation.

$$y = ab^x$$

The following is the calculation formula used for each command.

$$a = \exp\left(\frac{\sum \ln y - \ln b \cdot \sum x}{n}\right)$$

$$b = \exp\left(\frac{n \cdot \sum x \ln y - \sum x \cdot \sum \ln y}{n \cdot \sum x^2 - (\sum x)^2}\right)$$

$$r = \frac{n \cdot \sum x \ln y - \sum x \cdot \sum \ln y}{\sqrt{\{n \cdot \sum x^2 - (\sum x)^2\} \{n \cdot \sum (\ln y)^2 - (\sum \ln y)^2\}}}$$

$$\hat{x} = \frac{\ln y - \ln a}{\ln b}$$

$$\hat{y} = ab^x$$

- Summation Sub-menu, Variable Sub-menu, Min/Max Sub-menu, and Regression Sub-menu operations are the same those for linear regression calculations.

ab Exponential Regression Calculation Examples

Select *ab* exponential regression and input the following data (Statistics: Off)

x	y
-1	0.24
3	4
5	16.2
10	513

OPTN **1** (Select Type) **2** ($y = a \cdot b^x$)

x	y
1	
4	

(←) **1** **3** **5** **10**

x	y
1	0
3	0
5	0
10	0

0.24 **4** **16.2** **513**

x	y
1	0.24
3	4
5	16.2
10	513

AC

Statistics	
$y = a \cdot b^x$	

Display statistical values based on input data.

OPTN **2** (2-Variable Calc)

```

Σx      =4.25
Σx²     =17
Σxy     =135
σ²x     =15.6875
σx      =3.960744879
s²x     =20.91666667
  
```



```

sX      =4.573474245
n       =4
σy      =133.36
Σy²     =533.44
σ²y     =263447.4976
σ²y     =48076.9848
  
```



```

σy      =219.2646456
s²y     =64102.6464
σy      =253.1850043
Σxy     =522.76
Σx³     =1151
Σx²y    =51741.24
  
```



```

Σx⁴     =10707
min(x)  =-1
max(x)  =10
min(y)  =0.24
max(y)  =513
  
```

Display regression calculation results based on input data.

AC **OPTN** **3** (Regression Calc)

```

y=a·b^x
a=0.48886664
b=2.007499344
r=0.9999873552
  
```

Calculate regression coefficient constant term a, regression coefficient b, and correlation coefficient r.

AC **OPTN** ▼ **4** (Regression)

```

1:a      2:b
3:r      4:x̂
5:ŷ
  
```

1 (a) **=**

```

a      0.48886664
  
```

OPTN ▼ **4** (Regression)

2 (b) **=**

```

a      0.48886664
b      2.007499344
  
```

OPTN ▼ **4** (Regression)

3 (r) **=**

```

b      2.007499344
r      0.9999873552
  
```

Calculate estimated values.

($y=1.02 \rightarrow \hat{x}=?$)

1.02 **OPTN** ▼ **4** (Regression)

```

1:a      2:b
3:r      4:x̂
5:ŷ
  
```

$\boxed{4}(\hat{x})\boxed{=}$	r^{\square}	0.9999873552
	$1.02\hat{x}$	1.055357865

($x=15 \rightarrow \hat{y}=?$)

$15\boxed{OPTN}\boxed{\blacktriangledown}\boxed{4}(\text{Regression})$	$1.02\hat{x}^{\square}$	1.055357865
$\boxed{5}(\hat{y})\boxed{=}$	$15\hat{y}$	16944.22002

Power Regression Calculation ($y=a \cdot x^b$) Commands

With power regression, regression is performed in accordance with the following model equation.

$$y = ax^b$$

The following is the calculation formula used for each command.

$$a = \exp\left(\frac{\sum \ln y - b \cdot \sum \ln x}{n}\right)$$

$$b = \frac{n \cdot \sum \ln x \ln y - \sum \ln x \cdot \sum \ln y}{n \cdot \sum (\ln x)^2 - (\sum \ln x)^2}$$

$$r = \frac{n \cdot \sum \ln x \ln y - \sum \ln x \cdot \sum \ln y}{\sqrt{\{n \cdot \sum (\ln x)^2 - (\sum \ln x)^2\} \{n \cdot \sum (\ln y)^2 - (\sum \ln y)^2\}}}$$

$$\hat{x} = e^{\frac{\ln y - \ln a}{b}}$$

$$\hat{y} = ax^b$$

- Summation Sub-menu, Variable Sub-menu, Min/Max Sub-menu, and Regression Sub-menu operations are the same those for linear regression calculations.

Power Regression Calculation Examples

Select power regression and input the following data (Statistics: Off)

x	y
28	2410
30	3033
33	3895
35	4491
38	5717

OPTN **1** (Select Type) **3** ($y=a \cdot x^b$)

	x	y
1		
2		
3		
4		

28 **2nd** 30 **2nd** 33 **2nd** 35 **2nd** 38 **2nd**

	x	y
3	33	0
4	35	0
5	38	0

2410 **2nd** 3033 **2nd** 3895 **2nd** 4491 **2nd** 5717 **2nd**

	x	y
3	33	3895
4	35	4491
5	38	5717

AC

Statistics
 $y=a \cdot x^b$

Display statistical values based on input data.

OPTN **2** (2-Variable Calc)

\bar{x}	=32.8
$\sum x$	=164
$\sum x^2$	=5442
$\sigma^2 x$	=12.56
σx	=3.544009029
$s^2 x$	=15.7

2nd

s_x	=3.962322551
n	=5
\bar{y}	=3909.2
$\sum y$	=19546
$\sum y^2$	=83031384
$\sigma^2 y$	=1324432.16

2nd

σy	=1150.839763
$s^2 y$	=1655540.2
s_y	=1286.677971
$\sum xy$	=661436
$\sum x^3$	=182636
$\sum x^2 y$	=22617618

2nd

$\sum x^4$	=6196338
$\min(x)$	=28
$\max(x)$	=38
$\min(y)$	=2410
$\max(y)$	=5717

Display regression calculation results based on input data.

AC **OPTN** **3** (Regression Calc)

$y=a \cdot x^b$	
a	=0.2388010685
b	=2.771866158
r	=0.9989062551

Calculate regression coefficient constant term a, regression coefficient b, and correlation coefficient r.

AC **OPTN** **4** (Regression)

1:a	2:b
3:r	4: \hat{x}
5: \hat{y}	

1 (a) =	a	0.2388010685
---------	---	--------------

OPTN ▼ 4 (Regression)	a	0.2388010685
2 (b) =	b	2.771866158

OPTN ▼ 4 (Regression)	b	2.771866158
3 (r) =	r	0.9989062551

Calculate estimated values.

($y=1000 \rightarrow \hat{x}=?$)

1000 OPTN ▼ 4 (Regression)	1:a	2:b
	3:r	4: \hat{x}
	5: \hat{y}	

4 (\hat{x}) =	r	0.9989062551
	1000 \hat{x}	20.26225681

($x=40 \rightarrow \hat{y}=?$)

40 OPTN ▼ 4 (Regression)	1000 \hat{x}	20.26225681
5 (\hat{y}) =	40 \hat{y}	6587.674589

Inverse Regression Calculation ($y=a+b/x$) Commands

With inverse regression, regression is performed in accordance with the following model equation.

$$y = a + \frac{b}{x}$$

The following is the calculation formula used for each command.

$$a = \frac{\Sigma y - b \cdot \Sigma x^{-1}}{n}$$

$$b = \frac{S_{xy}}{S_{xx}}$$

$$r = \frac{S_{xy}}{\sqrt{S_{xx} \cdot S_{yy}}}$$

$$S_{xx} = \Sigma (x^{-1})^2 - \frac{(\Sigma x^{-1})^2}{n}$$

$$S_{yy} = \Sigma y^2 - \frac{(\Sigma y)^2}{n}$$

$$S_{xy} = \sum(x^{-1})y - \frac{\sum x^{-1} \cdot \sum y}{n}$$

$$\hat{x} = \frac{b}{y - a}$$

$$\hat{y} = a + \frac{b}{x}$$

- Summation Sub-menu, Variable Sub-menu, Min/Max Sub-menu, and Regression Sub-menu operations are the same those for linear regression calculations.

Inverse Regression Calculation Examples

Select inverse regression and input the following data (Statistics: Off)

x	y
1.1	18.3
2.1	9.7
2.9	6.8
4.0	4.9
4.9	4.1

OPTN **1** (Select Type) **4** (y=a+b/x)

x	y
1.1	18.3
2.1	9.7
2.9	6.8
4.0	4.9
4.9	4.1

1.1 **≡** 2.1 **≡** 2.9 **≡** 4 **≡** 4.9 **≡**

x	y
2.9	6.8
4	4.9
4.9	4.1

18.3 **≡** 9.7 **≡** 6.8 **≡** 4.9 **≡** 4.1 **≡**

x	y
2.9	6.8
4	4.9
4.9	4.1

AC

Statistics
y=a+b/x

Display statistical values based on input data.

OPTN **2** (2-Variable Calc)

$\sum x$	=3
$\sum x^2$	=15
$\sum x^3$	=54.04
$\sigma^2 x$	=1.808
σx	=1.344618905
$s^2 x$	=2.26

▼

Σx	=1.503329638
n	=5
Σy	=8.76
Σxy	=43.8
Σy^2	=516.04
$\sigma^2 y$	=26.4704

▼

σy	=5.144939261
$s^2 y$	=33.088
σxy	=5.752216964
Σxy	=99.91
Σx^3	=216.63
$\Sigma x^2 y$	=298.949

▼

Σx^4	=924.1204
$\min(x)$	=1.1
$\max(x)$	=4.9
$\min(y)$	=4.1
$\max(y)$	=18.3

Display regression calculation results based on input data.

AC **OPTN** **3** (Regression Calc)

$y=a+b/x$	
a	=-0.093440618
b	=20.26709711
r	=0.9998526953

Calculate regression coefficient constant term a , regression coefficient b , and correlation coefficient r .

AC **OPTN** ▼ **4** (Regression)

1: a	2: b
3: r	4: \hat{x}
5: \hat{y}	

1 (a) **=**

a	-0.09344061817
-----	----------------

OPTN ▼ **4** (Regression)

2 (b) **=**

a	-0.09344061817
b	20.26709711

OPTN ▼ **4** (Regression)

3 (r) **=**

b	20.26709711
r	0.9998526953

Calculate estimated values.

($y=15 \rightarrow \hat{x}=?$)

15 **OPTN** ▼ **4** (Regression)

1: a	2: b
3: r	4: \hat{x}
5: \hat{y}	

4 (\hat{x}) **=**

r	0.9998526953
15 \hat{x}	1.342775158

$(x=3.5 \rightarrow \hat{y}=?)$

3.5 **OPTN** **▼** **4** (Regression) **5** (\hat{y}) **≡**

$15\hat{x}$	1.342775158
$3.5\hat{y}$	5.697158557

Creating a Number Table

The Table Mode generates a number table based on one or two functions. You can use the function $f(x)$ or the two functions $f(x)$ and $g(x)$.

Configuring a Number Table Generation Function

Perform the following steps to generate a number table.

1. Press **MENU**, select the Table Mode icon, and then press **≡**.
 - This displays the function input screen.

$f(x) = \sqrt{x}$

2. Use the x variable to input two functions, one in the format $f(x)$ and the other in the format $g(x)$.
 - Be sure to input the x variable (**(ALPHA)** **(X)** (x)) when generating a number table. Any variable other than x is handled as a constant.
 - If you are using a single function, input a function in the format $f(x)$ only.
3. On the Table Range dialog box that appears, input values for Start, End, and Step.

For this:	Input this:
Start	Input the lower limit of x (Default = 1).
End	Input the upper limit of x (Default = 5).

Step	<p>Input the increment step (Default = 1).</p> <p>Note: The Step specifies by how much the Start value should be sequentially incremented as the number table is generated. If you specify Start = 1 and Step = 1, x sequentially will be assigned the values 1, 2, 3, 4, and so on to generate the number table until the End value is reached.</p>
------	--

- Pressing $\boxed{\equiv}$ generates and displays the number table in accordance with the Table Range dialog box.
- Pressing \boxed{AC} while the number table screen is displayed will return to the function input screen in step 2.

Example: To generate a number table for the functions $f(x) = x^2 + \frac{1}{2}$ and $g(x) = x^2 - \frac{1}{2}$ for the range $-1 \leq x \leq 1$, incremented in steps of 0.5

$\boxed{ALPHA} \boxed{)} \boxed{(x)} \boxed{x^2} \boxed{+} \boxed{1} \boxed{\equiv} \boxed{2}$

$f(x) = x^2 + \frac{1}{2}$

$\boxed{\equiv}$

$g(x) =$

$\boxed{ALPHA} \boxed{)} \boxed{(x)} \boxed{x^2} \boxed{-} \boxed{1} \boxed{\equiv} \boxed{2}$

$g(x) = x^2 - \frac{1}{2}$

$\boxed{\equiv}$

Table Range

Start: 1

End : 5

Step : 1

$\boxed{\leftarrow} \boxed{1} \boxed{\equiv} \boxed{1} \boxed{\equiv} \boxed{0.5} \boxed{\equiv}$

Table Range

Start: -1

End : 1

Step : 0.5

$\boxed{\equiv}$

x	$f(x)$	$g(x)$	
1	1.5	0.5	
2	-0.5	0.75	-0.25
3	0	0.5	-0.5
4	0.5	0.75	-0.25

-1

Tip:

- In the number table, you can change the value in the currently highlighted x cell. Changing the x value causes the $f(x)$ and $g(x)$ values in the same line to be updated accordingly.
- If there is value in the x cell above the currently highlighted x cell, pressing $\boxed{+}$ or $\boxed{-}$ automatically inputs into the highlighted cell the value equal to the value of the cell above it plus the step value. So also, pressing $\boxed{-}$ automatically inputs the value equal to the value of the cell above less the step value. The $f(x)$ and $g(x)$ values in the same line are also updated accordingly.

Note

- The maximum number of rows in the generated number table depends on the setup menu table setting. Up to 45 rows are supported for the “ $f(x)$ ” setting, while 30 rows are supported for the “ $f(x),g(x)$ ” setting.
- The number table generation operation causes the contents of variable x to be changed.

Important!

- Functions input in this mode are deleted whenever the Input/Output settings are changed in the Table Mode.

Ratio Calculations

The Ratio Mode lets you determine the value of X in the ratio expression $A : B = X : D$ (or $A : B = C : X$) when the values of A , B , C and D are known. The following shows the general procedure for using Ratio.

1. Press $\boxed{\text{MENU}}$, select the Ratio Mode icon, and then press $\boxed{\text{=}}$.

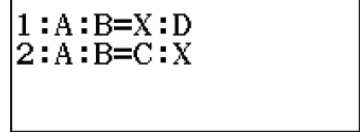

1:A:B=X:D
2:A:B=C:X

2. On the menu that appears, select $\boxed{1}$ ($A:B=X:D$) or $\boxed{2}$ ($A:B=C:X$).
3. On the Coefficient Editor screen that appears, input up to 10 digits for each of the required values (A , B , C , D).
 - To solve $3 : 8 = X : 12$ for X , for example, press $\boxed{1}$ in step 1, and then input the following for the coefficients ($A = 3$, $B = 8$, $D = 12$): $3 \boxed{=}$ $8 \boxed{=}$ $12 \boxed{=}$.

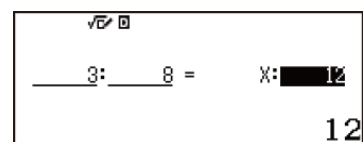

$\sqrt{\square}$ \square
3: 8 = X: \blacksquare
12

- Pressing $\boxed{\text{AC}}$ will reset all of the coefficients to one.
4. After all the values are the way you want, press $\boxed{\text{=}}$.
- This displays the solution (value of X).

A calculator display showing the result of a calculation. The text "X=" is on the left, and the fraction $\frac{9}{2}$ is on the right. Above the fraction is a small icon of a square root symbol.

- Pressing $\boxed{\text{=}}$ again will return to the Coefficient Editor.

Important!

- A Math ERROR will occur if you perform a calculation while 0 is input for a coefficient.

Changing the Ratio Expression Type

Press $\boxed{\text{OPTN}} \boxed{1}$ (Select Type) and then select the ratio expression type you want from the menu that appears. Changing the ratio expression type causes the values of all Coefficient Editor coefficients to change to one.

Ratio Mode Calculation Example

Example 1: To calculate X in the ratio $1 : 2 = X : 10$

$\boxed{\text{OPTN}} \boxed{1}$ (Select Type) $\boxed{1}$ (A:B=X:D)
 $1 \boxed{=} 2 \boxed{=} 10 \boxed{=}$

A calculator display showing the ratio expression $1:2 = X:10$. The numbers 1, 2, and 10 are entered into the respective fields. The variable X is in a shaded field. A small icon of a square root symbol is at the top right.

$\boxed{=}$

A calculator display showing the result $X = 5$. A small icon of a square root symbol is at the top right.

Example 2: To calculate X in the ratio $1 : 2 = 10 : X$

$\boxed{\text{OPTN}} \boxed{1}$ (Select Type) $\boxed{2}$ (A:B=C:X)
 $1 \boxed{=} 2 \boxed{=} 10 \boxed{=}$

A calculator display showing the ratio expression $1:2 = 10:X$. The numbers 1, 2, and 10 are entered into the respective fields. The variable X is in a shaded field. A small icon of a square root symbol is at the top right.

$\boxed{=}$

A calculator display showing the result $X = 20$. A small icon of a square root symbol is at the top right.

Technical Information

Errors

The calculator will display an error message whenever an error occurs for any reason during a calculation.

Displaying the Location of an Error

While an error message is displayed, press \blacktriangleleft or \blacktriangleright return to the calculation screen. The cursor will be positioned at the location where the error occurred, ready for input. Make the necessary corrections to the calculation and execute it again.

Example: When you input $14 \div 0 \times 2 =$ by mistake instead of $14 \div 10 \times 2 =$.

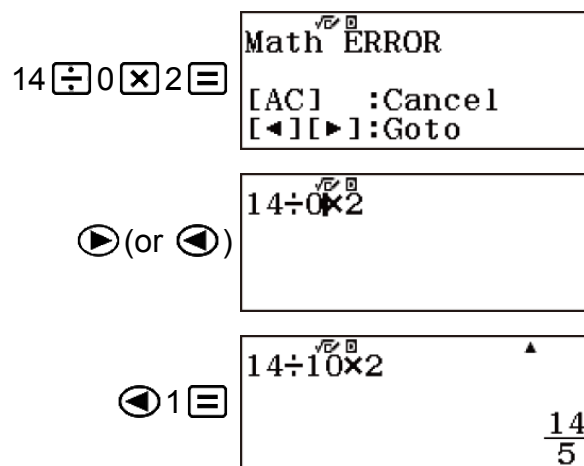

Clearing the Error Message

While an error message is displayed, press **[AC]** to return to the calculation screen. Note that this also clears the calculation that contained the error.

Error Messages

Math ERROR

Cause:

- The intermediate or final result of the calculation you are performing exceeds the allowable calculation range.
- Your input exceeds the allowable input range (particularly when using functions).
- The calculation you are performing contains an illegal mathematical operation (such as division by zero).

Action:

- Check the input values, reduce the number of digits, and try again.
- When using independent memory or a variable as the argument of a function, make sure that the memory or variable value is within the allowable range for the function.

Stack ERROR**Cause:**

- The calculation you are performing has caused the capacity of the numeric stack or the command stack to be exceeded.

Action:

- Simplify the calculation expression so it does not exceed the capacity of the stack.
- Try splitting the calculation into two or more parts.

Syntax ERROR**Cause:**

- There is a problem with the format of the calculation you are performing.

Action:

- Make necessary corrections.

Argument ERROR**Cause:**

- There is a problem with the argument of the calculation you are performing.

Action:

- Make necessary corrections.

Range ERROR**Cause:**

- An attempt to generate a number table in the Table Mode whose conditions cause it to exceed the maximum number of allowable rows. The maximum number of rows is 45 when " $f(x)$ " is selected for the setup menu table setting and 30 when " $f(x),g(x)$ " is selected.

Action:

- Narrow the table calculation range by changing the Start, End, and Step values, and try again.

Before Assuming Malfunction of the Calculator...

Perform the following steps whenever an error occurs during a calculation or when calculation results are not what you expected. If one step does not correct the problem, move on to the next step.

Note that you should make separate copies of important data before performing these steps.

1. Check the calculation expression to make sure that it does not contain any errors.
2. Make sure that you are using the correct mode for the type of calculation you are trying to perform.
3. If the above steps do not correct your problem, press the **ON** key.
 - This will cause the calculator to perform a routine that checks whether calculation functions are operating correctly. If the calculator discovers any abnormality, it automatically initializes the calculation mode and clears memory contents.
4. Return the calculation mode and setup (except for the Contrast setting) to their initial default settings by performing the following operation: **SHIFT** **9** (RESET) **1** (Setup Data) **≡** (Yes).

Replacing the Battery

A low battery is indicated by a dim display, even if contrast is adjusted, or by failure of figures to appear on the display immediately after you turn on the calculator. If this happens, replace the battery with a new one.

Important!

- Removing the battery will cause all of the calculator's memory contents to be deleted.

1. Press **SHIFT** **AC** (OFF) to turn off the calculator.
 - To ensure that you do not accidentally turn on power while replacing the battery, slide the hard case onto the front of the calculator.
2. On the back of the calculator, remove the screws and the cover.

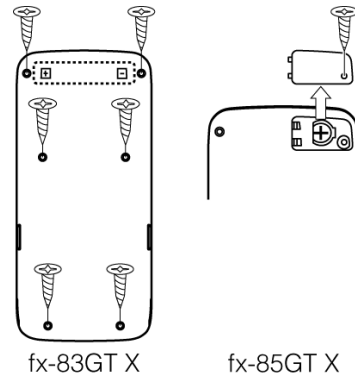

3. Remove the battery, and then load a new battery with its plus (+) and minus (-) ends facing correctly.
4. Replace the cover.
5. Initialize the calculator: **ON** **SHIFT** **9** (RESET) **3** (Initialize All) **≡** (Yes).
 - Do not skip the above step!

Calculation Priority Sequence

The calculator performs calculations according to a calculation priority sequence.

- Basically, calculations are performed from left to right.
- Expressions within parentheses have the highest priority.
- The following shows the priority sequence for each individual command.

1	Parenthetical expressions
2	Functions that have parentheses (sin(, log(, etc., functions that take an argument to the right, functions that require a closing parenthesis after the argument)
3	Functions that come after the input value (x^2 , x^3 , x^{-1} , $x!$, $^{\circ}$, $^{\circ}$, $^{\circ}$, $^{\circ}$, $^{\circ}$), powers (x^{\blacksquare}), roots ($\sqrt{\blacksquare}$)
4	Fractions
5	Negative sign ((-))
6	Statistics Mode estimated values (\hat{x} , \hat{y} , \hat{x}_1 , \hat{x}_2)
7	Multiplication where the multiplication sign is omitted
8	Permutation (nPr), combination (nCr)
9	Multiplication (\times), division (\div)

10	Addition (+), subtraction (-)
----	-------------------------------

If a calculation contains a negative value, you may need to enclose the negative value in parentheses. If you want to square the value -2, for example, you need to input: $(-2)^2$. This is because x^2 is a function preceded by a value (Priority 3, above), whose priority is greater than the negative sign, which is a prefix symbol (Priority 5).

Example:

$\boxed{(-)} \boxed{2} \boxed{x^2} \boxed{=}$	$-2^2 = -4$
$\boxed{(} \boxed{(-)} \boxed{2} \boxed{)} \boxed{x^2} \boxed{=}$	$(-2)^2 = 4$

Stack Limitations

This calculator uses memory areas called *stacks* to temporarily store lower calculation priority sequence values, commands, and functions. The *numeric stack* has 10 levels and the *command stack* has 24 levels, as shown in the illustration below.

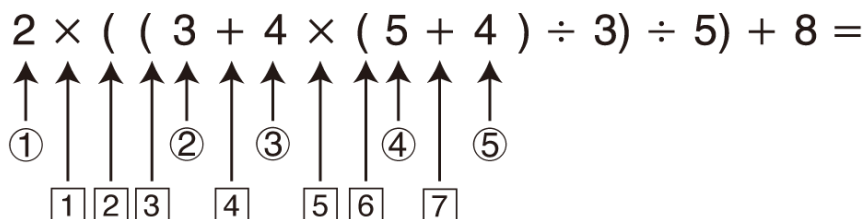

Numeric Stack

①	2	④	5
②	3	⑤	4
③	4	⋮	

Command Stack

1	×	5	×
2	(6	(
3	(7	+
4	+	⋮	

A Stack ERROR occurs when the calculation you are performing causes the capacity of either stack to be exceeded.

Calculation Ranges, Number of Digits, and Precision

The calculation range, number of digits used for internal calculation, and calculation precision depends on the type of calculation you are performing.

Calculation Range and Precision

Calculation Range	$\pm 1 \times 10^{-99}$ to $\pm 9.999999999 \times 10^{99}$ or 0
Number of Digits for Internal Calculation	15 digits
Precision	In general, ± 1 at the 10th digit for a single calculation. Precision for exponential display is ± 1 at the least significant digit. Errors are cumulative in the case of consecutive calculations.

Function Calculation Input Ranges and Precision

Functions	Input Range	
$\sin x$ $\cos x$	Degree	$0 \leq x < 9 \times 10^9$
	Radian	$0 \leq x < 157079632.7$
	Gradian	$0 \leq x < 1 \times 10^{10}$
$\tan x$	Degree	Same as $\sin x$, except when $ x = (2n-1) \times 90$.
	Radian	Same as $\sin x$, except when $ x = (2n-1) \times \pi/2$.
	Gradian	Same as $\sin x$, except when $ x = (2n-1) \times 100$.
$\sin^{-1}x, \cos^{-1}x$	$0 \leq x \leq 1$	
$\tan^{-1}x$	$0 \leq x \leq 9.999999999 \times 10^{99}$	
$\sinh x, \cosh x$	$0 \leq x \leq 230.2585092$	
$\sinh^{-1}x$	$0 \leq x \leq 4.999999999 \times 10^{99}$	
$\cosh^{-1}x$	$1 \leq x \leq 4.999999999 \times 10^{99}$	
$\tanh x$	$0 \leq x \leq 9.999999999 \times 10^{99}$	
$\tanh^{-1}x$	$0 \leq x \leq 9.999999999 \times 10^{-1}$	

$\log x, \ln x$	$0 < x \leq 9.999999999 \times 10^{99}$
10^x	$-9.999999999 \times 10^{99} \leq x \leq 99.99999999$
e^x	$-9.999999999 \times 10^{99} \leq x \leq 230.2585092$
\sqrt{x}	$0 \leq x < 1 \times 10^{100}$
x^2	$ x < 1 \times 10^{50}$
x^{-1}	$ x < 1 \times 10^{100}; x \neq 0$
$\sqrt[3]{x}$	$ x < 1 \times 10^{100}$
$x!$	$0 \leq x \leq 69$ (x is an integer)
${}^n P_r$	$0 \leq n < 1 \times 10^{10}, 0 \leq r \leq n$ (n, r are integers) $1 \leq \{n!/(n-r)!\} < 1 \times 10^{100}$
${}^n C_r$	$0 \leq n < 1 \times 10^{10}, 0 \leq r \leq n$ (n, r are integers) $1 \leq n!/r! < 1 \times 10^{100}$ or $1 \leq n!/(n-r)! < 1 \times 10^{100}$
$\text{Pol}(x, y)$	$ x , y \leq 9.999999999 \times 10^{99}$ $\sqrt{x^2 + y^2} \leq 9.999999999 \times 10^{99}$
$\text{Rec}(r, \theta)$	$0 \leq r \leq 9.999999999 \times 10^{99}$ θ : Same as $\sin x$
$a^\circ b' c''$	$ a , b, c < 1 \times 10^{100}; 0 \leq b, c$ The display seconds value is subject to an error of ± 1 at the second decimal place.
\leftarrow $\circ', ''$	$ x < 1 \times 10^{100}$ Decimal \leftrightarrow Sexagesimal Conversions $0^\circ 0' 0'' \leq x \leq 9999999^\circ 59' 59''$
x^y	$x > 0: -1 \times 10^{100} < y \log x < 100$ $x = 0: y > 0$ $x < 0: y = n, \frac{m}{2n+1}$ (m, n are integers) However: $-1 \times 10^{100} < y \log x < 100$

$\sqrt[x]{y}$	$y > 0: x \neq 0, -1 \times 10^{100} < 1/x \log y < 100$ $y = 0: x > 0$ $y < 0: x = 2n+1, \frac{2n+1}{m} (m \neq 0; m, n \text{ are integers})$ However: $-1 \times 10^{100} < 1/x \log y < 100$
$a^{b/c}$	Total of integer, numerator, and denominator must be 10 digits or less (including separator symbol).
RanInt#(a, b)	$a < b; a , b < 1 \times 10^{10}; b - a < 1 \times 10^{10}$

- Precision is basically the same as that described under “Calculation Range and Precision”, above.
- $x^y, \sqrt[x]{y}, \sqrt[3]{y}, x!, nPr, nCr$ type functions require consecutive internal calculation, which can cause accumulation of errors that occur with each calculation.
- Error is cumulative and tends to be large in the vicinity of a function’s singular point and inflection point.
- The range for calculation results that can be displayed in π form when MathI/MathO is selected for Input/Output on the setup menu is $|x| < 10^6$. Note, however, that internal calculation error can make it impossible to display some calculation results in π form. It also can cause calculation results that should be in decimal form to appear in π form.

Specifications

fx-83GT X

Power Requirements:

AAA-size battery R03 (UM-4) \times 1

Approximate Battery Life:

2 years (based on one hour of operation per day)

Power Consumption:

0.0006 W

Operating Temperature:

0°C to 40°C (32°F to 104°F)

Dimensions:

13.8 (H) × 77 (W) × 165.5 (D) mm

½" (H) × 3" (W) × 6½" (D)

Approximate Weight:

100 g (3.5 oz) including the battery

fx-85GT X**Power Requirements:**

Built-in solar cell; button battery LR44 × 1

Approximate Battery Life:

2 years (based on one hour of operation per day)

Operating Temperature:

0°C to 40°C (32°F to 104°F)

Dimensions:

11.1 (H) × 77 (W) × 165.5 (D) mm

⅜" (H) × 3" (W) × 6½" (D)

Approximate Weight:

90 g (3.2 oz) including the battery

Frequently Asked Questions

Frequently Asked Questions

- **How can I perform input and display results the same way I did on a model that does not have Natural Textbook Format?**

→ Perform the following key operation:

SHIFT **MENU** (SETUP) **1** (Input/Output) **3** (LineI/LineO), or
SHIFT **MENU** (SETUP) **1** (Input/Output) **4** (LineI/DecimalO).

- **How can I change a fraction form result produced by a division operation to decimal form?**

→ While a fraction calculation result is displayed, press **S \leftrightarrow D**. To have calculation results initially appear as decimal values, change the setup menu Input/Output setting to MathI/DecimalO.

- **What is the difference between Ans memory, independent memory, and variable memory?**

→ Each of these types of memory acts like “containers” for temporary storage of a single value.

Ans Memory: Stores the result of the last calculation performed. Use this memory to carry the result of one calculation on to the next.

Independent Memory: Use this memory to totalize the results of multiple calculations.

Variables: This memory is helpful when you need to use the same value multiple times in one or more calculations.

- **What is the key operation to take me from the Statistics Mode or Table Mode to a mode where I can perform arithmetic calculations?**

→ Press **MENU** **1** (Calculate).

- **How can I return the calculator to its initial default settings?**

→ Perform the following operation to initialize calculator settings (except the Contrast setting): **SHIFT** **9** (RESET) **1** (Setup Data) **≡** (Yes).

- **When I execute a function calculation, why do I get a calculation result that is completely different from older CASIO calculator models?**

→ With a Natural Textbook Display model, the argument of a function that uses parentheses must be followed by a closing parenthesis. Failing to press **)** after the argument to close the parentheses may cause unwanted values or expressions to be included as part of the argument.

Example: $(\sin 30) + 15$ (Angle Unit: Degree)

Older (S-V.P.A.M.) Model: $\boxed{\sin} \boxed{30} \boxed{+} \boxed{15} \boxed{=}$ 15.5

Natural Textbook Display Model:

(LineI/LineO) $\boxed{\sin} \boxed{30} \boxed{)} \boxed{+} \boxed{15} \boxed{=}$ 15.5

Failure to press $\boxed{)}$ here as shown below will result in calculation of $\sin 45$.

$\boxed{\sin} \boxed{30} \boxed{+} \boxed{15} \boxed{=}$ 0.7071067812

CASIO®

Free Manuals Download Website

<http://myh66.com>

<http://usermanuals.us>

<http://www.somanuals.com>

<http://www.4manuals.cc>

<http://www.manual-lib.com>

<http://www.404manual.com>

<http://www.luxmanual.com>

<http://aubethermostatmanual.com>

Golf course search by state

<http://golfingnear.com>

Email search by domain

<http://emailbydomain.com>

Auto manuals search

<http://auto.somanuals.com>

TV manuals search

<http://tv.somanuals.com>