



CEILING FAN REMOTE WALL CONTROL

Model 99195

CASABLANCA FAN COMPANY CONTROL LIMITED WARRANTY

This product is warranted to the original purchaser by Casablanca Fan Company against defects in material and workmanship for one (1) year from date of purchase. During the warranty period, we will repair or, at our option, replace a defective product at no charge. For information on how to obtain service, contact Casablanca's Service Department by calling our toll-free number at 1-888-227-2178. Damage to the product caused by mishandling, improper installation or modification is not covered by this warranty. This warranty is given in lieu of all other warranties expressed or implied. Some states do not allow limitations of time on an implied warranty, therefore the above limitations may not apply in every case. This warranty states specific legal rights which may vary from state to state.

READ AND SAVE THESE INSTRUCTIONS

This product conforms to UL Standard 1917.

⚠️ WARNINGS

This device complies with part 15 of the FCC Rules. Operation is subject to the following two conditions: (1) this device may not cause harmful interference, and (2) this device must accept any interference received, including interference that may cause undesired operation.

This device complies with RSS-210 of Industry Canada. Operation is subject to the following two conditions: (1) this device may not cause interference, and (2) this device must accept any interference, including interference that may cause undesired operation of the device.

This equipment has been tested and found to comply with the limits for a Class B digital device, pursuant to Part 15 of the FCC Rules. These limits are designed to provide reasonable protection against harmful interference in a residential installation. This equipment generates, uses and can radiate radio frequency energy and, if not installed and used in accordance with the instructions, may cause harmful interference to radio communications. However there is no guarantee that interference will not occur in a particular installation. If this equipment does cause harmful interference to radio or television reception, which can be determined by turning the equipment off and on, the user is encouraged to try to correct the interference by one or more of the following measures: Reorient or relocate the receiving antenna, increase the separation between the equipment and receiver, connect the equipment into an outlet on a circuit different from that to which the receiver is connected. Consult the dealer or an experienced radio/TV technician for help. Note: Any changes or modifications to the transmitter or receiver not expressly approved by Hunter Fan Company may void one's authority to operate this remote control.

If you are installing multiple remote-controlled fans on the same circuit breaker,

you may need to perform a few extra steps to prevent interference or faulty operation of your remote controls.

Go to www.CasablancaFanCo.com/FAQs and click "How do I properly install multiple remote-controlled fans?" for more information.

INSTALLATION

- 1 Turning off the power**
Before installation, use the pull chains to set the fan speed to HIGH and the light to ON. Ensure the power is OFF at the outlet box and wall switch location before proceeding with installation.

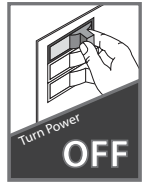

- 2 Installing the battery**
To access the battery compartment, slide the battery door up. Replace the used battery with two AAA batteries when needed.

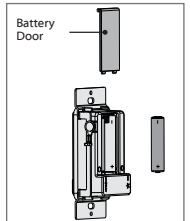

- 3 Installing the Wall Plate Bracket**
Snap the Wall Control into the Wall Plate Bracket. Ensure that the lip on the bracket is facing outward.

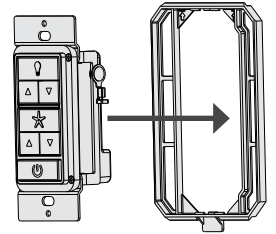

- 4 Wiring the Wall Control**
 1. Connect the grounding wire from the wall control to the ground control from the switch box using the provided wire nuts.
 2. Connect the "LIVE IN" from the switch box to the "-VAC" from the wall control using the provided wire nuts.
 3. Connect the "LIVE OUT" from the switch box to the "FAN" out from the wall control using the provided wire nuts.
 4. Push all wires into the switch box.

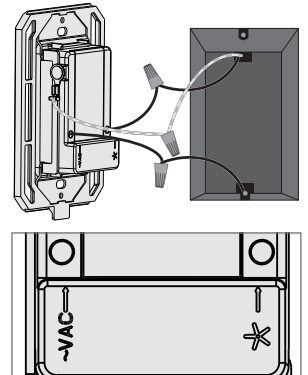

To avoid possible electrical shock, before installing or servicing your fan, disconnect the power by turning off the circuit breakers to the outlet box and associated wall switch location. If you cannot lock the circuit breakers in the off position, securely fasten a prominent warning device, such as a tag, to the service panel.

5

Installing the Wall Control

Install the longer screws through the slots in the wall control into the switch box screw holes.

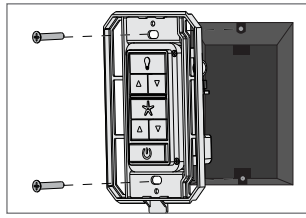

6

Installing the Wall Plate

Push the wall plate onto the Wall Plate Bracket. It should snap into place.

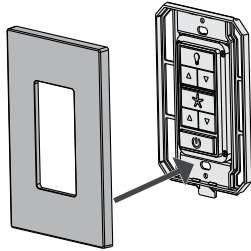

7

Turning on the power

IMPORTANT

Use the pull-chain switch on the fan to set the fan speed to the HIGH position before operation.

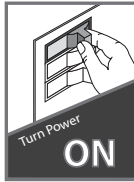

8

To pair the remote to your Casablanca receiver, **LONG PRESS** the Fan and Light buttons together within three minutes of restoring power to the fan.



9

Reference the included remote function card for information on how to use your wall control!

**Key Press
Light Functions**

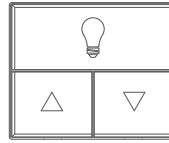

- Long Press
- Long Press
- Long Press +

Function

- Light On/Off
- Light Dimming Control
- Light High
- Light Low
- Dimming Mode On/Off

Fan Functions

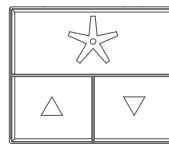

- Long Press
- Long Press

- Fan On/Off
- Fan Speed Control
- Fan High
- Fan Low



Fan Reverse

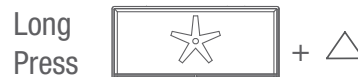

Fan Updraft

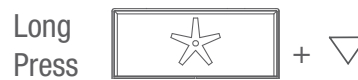

Fan Downdraft



Power On/Off



Pair Function



Reset
(For WiFi enabled fans ONLY)

Free Manuals Download Website

<http://myh66.com>

<http://usermanuals.us>

<http://www.somanuals.com>

<http://www.4manuals.cc>

<http://www.manual-lib.com>

<http://www.404manual.com>

<http://www.luxmanual.com>

<http://aubethermostatmanual.com>

Golf course search by state

<http://golfingnear.com>

Email search by domain

<http://emailbydomain.com>

Auto manuals search

<http://auto.somanuals.com>

TV manuals search

<http://tv.somanuals.com>